

TOSHIBA

Instruction Manual Direct Drinking Water Purifier

Model

TWP-W1743STH(W)



Please read the manual carefully before operating the water purifier.
Retain it for future reference.

DIRECTORY

1.Safety Instructions	1
1-1 Safety Instructions.....	1
1-2 Packing List	5
2. Your Direct Drinking Water Purifier	6
2-1 Part Name of Water Purifier	6
2-2.Model and Major Parameters.....	7
2-3 Product Features.....	7
2-4 Product Functions	8
2-5 Working principle	8
3.Use Guide and Maintenance	9
3-1. Guidance on Unpacking and Installation	9
3-2. Machine installation	11
3-3. The display panel is shown as below	11
3-4. Filter Replacement Cycle	12
3-5. WIFI function connection.....	13
3-6. Maintenance	13
3-7 Troubleshooting	14
Filter Replace Advise Table	16

The packaging material used is recyclable; we recommend that you separate plastic, paper and cardboard and give them to recycling companies. To help preserve the environment, the refrigerant used in this product is R134a (Hydrofluorocarbon -HFC), which does not affect the ozone layer and has little impact on the greenhouse effect. Guidelines, waste from electrical and electronic devices should be collected separately. If you need to dispose of this appliance in the future, do NOT throw it away with the rest of your domestic garbage.





1. Safety Instruction

1-1 Safety Instructions

All instructions described should be carefully read and followed.







- These instructions are precautions to prevent the risks of serious injury or death of the user, and any damages to property.

MARKINGS	
 WARNING	WARNING indicates high possibility of serious injury (*1) or death of the user.
 CAUTION	CAUTION indicates high possibility of injury (*2) or property loss (*3).









(*1) Serious injury – injury which requires hospitalization, lengthy treatment, or blindness, hot and cold skin burn, electric shock, broken bones or poisoning.

















(*2) Injury – injury, skin burn or electric shock which does not require hospitalization or lengthy treatment.

(*3) Property loss – extended loss of houses, furniture, domestic animals or pets.

SYMBOLS	
 PROHIBITED!	 PROHIBITED! Indicates prohibited actions. Detailed instructions would be indicated on the inside of the circle or around the symbol in figures or in writing.
 IMPORTANT	 IMPORTANT Indicates mandatory actions. Detailed instructions would be indicated on the inside of the circle or around the symbol in figures or in writing.
 CAUTION	 CAUTION Recommends to take precautions. Detailed instructions would be indicated on the inside of the triangle or around the symbol in figures or in writing.





* To use

 WARNING	
 Instruction	Prior to use, the water purifier must be properly assembled and installed in accordance with this manual. It may damage to the water purifier and cause danger.
 Away from flammable materials	Do not use the water purifier near a material with high volatility which is easily ignited or exploded. It will cause explosion or fire. 
 Prohibit	Do not use an extension cord with the water purifier. It may cause electric shock or fire due to heat. 
 Electric shock	Do not use damaged power lines, power plug or loose power socket. It may cause electric shock, fault, fire or injuries. 
 Instruction	Place the water purifier on a solid level surface. It may cause the water purifier to fall and tumble down or make noise.

 Prohibit	<p>Do not immerse cord, plug, or any other part of the water purifier in water or other liquids. It may cause electric shock or fire.</p>
 Away from children	<p>Do not purify hot water without proper and direct supervision. Unplug unit to prevent unsupervised use by children. It may cause electrical shock, damage, or malfunction.</p> 
 Away from children	<p>Do not operate the water purifier by weak people (including children) which are reduced physical, sensory, mental capabilities, nor inadequate experience and knowledge, unless sufficient instructions have been given by the person who can guarantee the safe use of the water purifier. It may cause electric shock, damage, or malfunction.</p>
 Away from children	<p>Children should be supervised to ensure that they do not play with the water purifier. It may cause electric shock, damage, or malfunction.</p>
 Away from flammable materials	<p>Do not store explosive substances such as aerosol cans with a flammable propellant in the water purifier and also put anything flammable beside the water purifier. It may cause explosion or fire.</p>
 Correct grounding	<p>The water purifier must be grounded. The current resistance are minimum after grounding, and this can reduce the danger of electric shock when the water purifier has fault. The electric wires of the water purifier have grounding wire and grounding plug. Fault connection of the grounding wire will cause electric shock. When it is difficult to confirm the correctness of grounding, please call for professional electricians or service men for inspection.</p>
	<p>Use outlet with rated voltage AC 220-240V, rated current 10A or more, and don't use multiple outlets. Can cause a fire or an electric shock.</p>
 No dis-assembly and repair without permission	<p>Do not damage power line. Do not damage, cut, process power line or bend, pull, twist or bind power line. Besides, do not yank the power line violently, or put weights on the line or clamp the power line. The power line may be damaged and cause fire or electric shock if the power line is damaged, the damaged line must be replaced by the manufacturer or its service agent or personnel having similar qualification, so as to prevent dangers.</p> 
 Insert plug	<p>Insert the power plug securely to the base and let the cord go downward. If the cord goes upward or if the plug is incompletely inserted, it may cause fire due to electric leakage or heat generation.</p> 
 Wipe off dust	<p>Wipe off dust or dirt accumulated on the plug of power line. The accumulated dust or dirt may cause fire,electric shock, or short circuit.</p>
 No modification	<p>Do not disassemble, remodel, modify and repair the water purifier. This may cause fire, electric shock or fault, and cause injuries. If repair is required, please contact with the vendor of the water purifier.</p>
	<p>Please do not put anything on the water purifier. If something overflow, it may result fire ,electric shock.</p>
 Care for cleaning	<p>To clean the water purifier, use the soft cloth moisten by the neutral detergent diluted with water. Do not use the insecticide, Thinner, Benzene, chlorine or acid lotion. It may cause crack, electric shock, fire, or deleterious gas.</p>





**CAUTION**

	Do not connect to water which is not tap water. This product is the water purifier exclusive for tap water. Otherwise, it may damage health or cause trouble.	
 Prohibit	Do not freeze. It may cause leakage or other malfunctions. Reverse osmosis membrane filters will be damaged below 0°C.	
 Prohibit	Do not use outdoors. Keep the water purifier at dry place and away from direct sunlight. It may cause fire or malfunction. Also the body of the water purifier may change color, deform and breeds moss and fungus.	
 Prohibit	Do not place water purifier into enclosed space or a cabinet. It may damages to the water purifier and cause fire.	
 No pulling by force	When disconnecting the plug from the socket, do not pull the power line by force. Pull out by grasping the power plug. It may cause electric shock or fault and cause injuries.	
 Space between wall	Need to put space between the back of the water purifier and the wall is more than 20 cm. Not only the back space but also both side of the water purifier is more than 20 cm. To allow the airflow. It may damage the water purifier and cause fire.	
 Prohibit	Do not damage the refrigerant circuit of the water purifier. It may damage to the water purifier and cause refrigerant leakage.	
 Application environment	Indoor use only. This appliance is intended to be used in household and similar applications such as staff kitchen areas in shops, offices and other working environments; farm houses and by clients in hotels, motels and other residential type environments; bed and breakfast type environments; catering and similar non-retail applications.	
 Application range	The water purifier's usage temperature range is between 4°C~38°C. Do not use the water purifier out of usage temp range. It may damage to the water purifier and cause fire.	
 Away from fire	Do not place the water purifier close to fire. It may damage to the water purifier and cause fire.	
 Prohibit	Do not put anything on the water purifier, also do not lean, shake and push the water purifier. It may damage to the water purifier and cause injury, leakage, electric shock, fire or others.	
 No water spraying	Do not install the water purifier in where the water jet washer is used. It may cause electric shock or fire due to an insulation deterioration.	
	Do not install water inlet pipe and drain pipe beside gas range and other sources of fire. Stay away from the fire source above 30cm. It will cause fire or machine damage.	
	Do not reseat the filter except to replace expired filters or to stop using them for long periods. It may cause Adhesion of germs or water leakage.	
	Do not connect hot water pipe of water heater to the water inlet. Reverse osmosis membrane filter will be damaged above 38°C.	

	The water once take out should be used as soon as possible. It is easy to breeding miscellaneous bacteria. When stored water for a longtime. Since there no residual chlorine in water , be stored only 2 to 3 days in the refrigerator safely.
	When water leakage close the inlet water valve and unplug the power cord as soon as possible. Leakage can cause other damage. Please contact teh local service center.
	Replace the filter regularly. The filter change lamp will flashing when the filter need to change. Please see page 11 for filter replacement cycle.
	When not using for a long time close the inlet water valve and release the water from the water purifier. It may cause water leakage.





*** To inspection and maintenance**









 **WARNING**

 No dis-assembly and repair without permission	If the supply cord is damaged, it must be replaced by the manufacturer, its service agent or similarly qualified persons in order to avoid a hazard. Can cause fire, electric shock.
 Prohibit	Do not be cleaned by a water jet. Can cause electrical insulation to deteriorate and cause electric shock or fire.
 Disconnect power plug	Make sure the water purifier's power plug is disconnect from the power outlet before clearing or inspect the water purifier. It may cause electric shock.
 Instruction	Disconnect the power plug from power supply immediately and call for service when: - burnt smell from the water purifier - the water from the hot tap is not hot - color of the water has changed - abnormal phenomenon happend It may cause short circuit, fire or electric shock.













 **CAUTION**

 Certified technician	Service should be performed only by a certified technician. It may damage to the purifier and cause electric shock.
 Prohibit	Do not use mechanical devices nor other means to accelerate the defrosting process, other than those recommended by the manufacturer. Can cause fire, electric shock.
 Ice point	When the machine is under the ice point and blocked by ice, the cooling switch must be off for 4 hours before turning it on again to continue its operation. Can cause water leakage.
 Prohibit	Do not close the water purifiers ventilation openings by put into enclosure nor in the built-in structure. The water purifier ventilation openings must be clear from obstruction. It may damage to the purifier and cause fire.

 Indoor	Do not use the water purifier other than indoor. Can cause a fire or malfunction. Also it may cause the water purifiers color change, deformation, breeds moss and contaminated.
 Instruction	WARNING: Do not operate the UV-C emitter when it is removed from the appliance enclosure.
 Instruction	This appliance contains a UV-C emitter.
 Prohibit	Unintended use of the appliance or damage to the housing may result in the escape of dangerous UV-C radiation. UV-C radiation may, even in little doses, cause harm to the eyes and skin.
 Prohibit	Appliances that are obviously damaged must not be operated.
 Instruction	The user is not allowed to replace the UV-C emitter.
 Prohibit	WARNING: Disconnect the appliance from the supply before carrying out maintenance.
 Instruction	The appliance is to be supplied through a residual current device (RCD) having rated residual operating current not exceeding 30 mA.

1-2 Packing List

Packing box	Direct drinking water purifier (1 set)			1/4" PE pipe (3m)		Filter	PP sediment filter-F1(1PC)
	Materials bag	Instruction Manual(1 copy)	Easy to use guide(1 copy)	APP use guide(1 copy)	Expansion rubber plug(1PC)		C1 active carbon filter-F1(1PC)
							RO reverse osmosis filter-F1(1PC)
		Bracket(1PC)	rubber gasket(1PC)	Inlet ball valve(1PC)	Filter flushing tip(1PC)		Long screws (1PC)
							

2. Your Direct Drinking Water Purifier

2-1 Part Name of Water Purifier

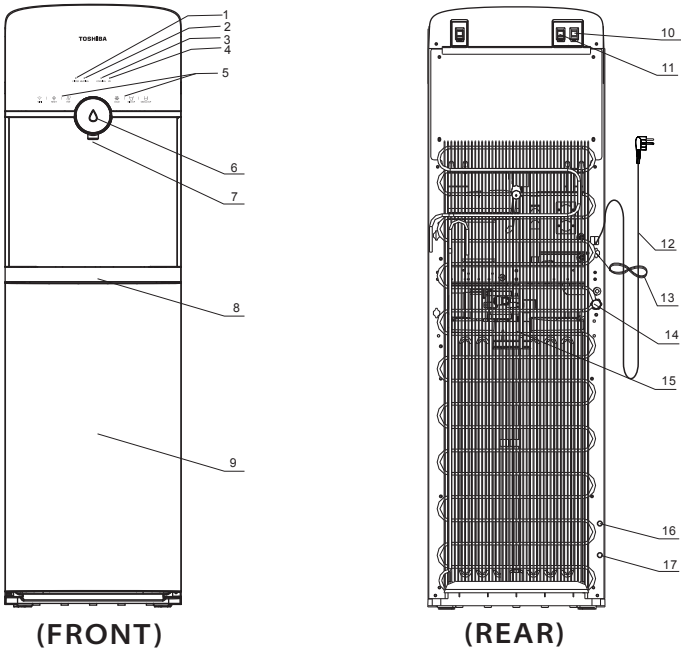

NO.	PART NAME	NO.	PART NAME
1	filter change lamp	10	heating switch
2	heating pilot lamp	11	cooling switch
3	cooling pilot lamp	12	power cord
4	UV pilot lamp	13	ground wire
5	dispenser controls panel	14	outlet of hot water
6	water button	15	condenser
7	spout	16	drain water
8	water collector	17	water inlet
9	door		

NOTE: Please use the product in a place with temperature of 4-38°C and relative humidity less than 90%.

Control panel and Indication

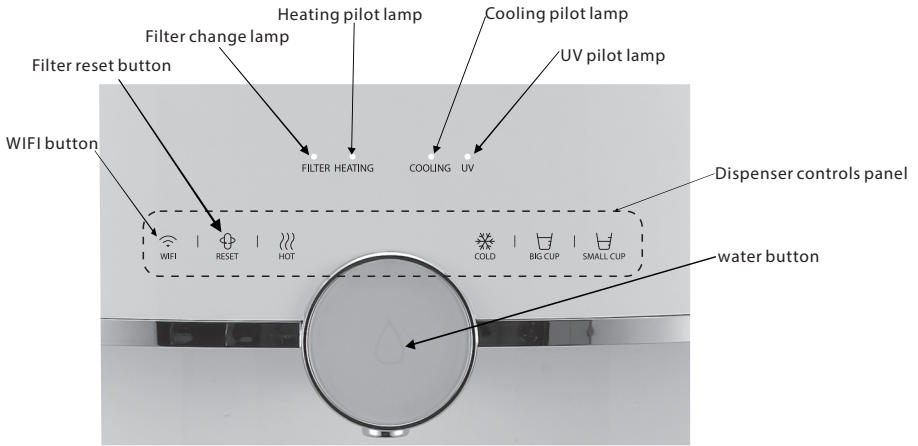

2-2.Model and Major Parameters

Model		TWP-W1743STH(W)	
Rated Voltage	220-240V~	Applicable water pressure	0.1-0.4MPa
Rated Frequency	50/60Hz	Stage 1	PP sediment filter-F1
Rated Power	665W	Stage 2	C1 active carbon filter-F1
Heating Power	550W	Stage 3	RO reverse osmosis filter-F1
Refrigerating Power	100W	Stage 4	C2 active carbon filter-F1
Hot water capacity	4L/h($\geq 85^{\circ}\text{C}$)	Applicable water	Tap water
Cold water capacity	2L/h($\leq 10^{\circ}\text{C}$)	Product size	310x375x1061mm
Refrigerant	R134a/32g	Packing size	378x417x1205mm
Climate class	T	Net weight	18 kg
Applicable environment	4-38 $^{\circ}\text{C}$ humidity $\leq 90\%$	Gross weight	22 kg

2-3 Product Features

1. Fresh pure water: four stage high-precision filtration to ensure effluent water quality.
2. Compressor for cooling: adopt stable, high-efficiency and low noise compressor
3. Quadruple anti-dry burning protection: filtered water was provided to hot tank in priority, water level control system identifies the water level automatically, double protection of thermostat, quadruple anti-dry burning protection system.
4. Quick connect fitting technology: adopt Korean quick connect fitting technology which has outstanding sealing and no water leakage.

2-4 Product Functions

- **High-precision filtration, pure water quality**

Through high-precision four stage filtration system, it filters granules, iron rust, colloids, bacteria, residential chlorine and impurities in water.

- **Satisfy demand of drinking water and kitchen water**

It can make water in 24 hours continuously according to needs. Ample water satisfies demand of drinking water and kitchen water.

- **Keep fresh pure water**

It is connected to tap water directly, can make water continuously and keep dissolved oxygen in water, ensuring fresh pure water for drinking and kitchen use.

- **Humanized safety protection**

A series of humanized designs guarantee safety of water consumption completely, like lighting device, childproof faucet and quadruple anti-dry burning protection.

2-5 Working principle

1.Flowchart of water generation

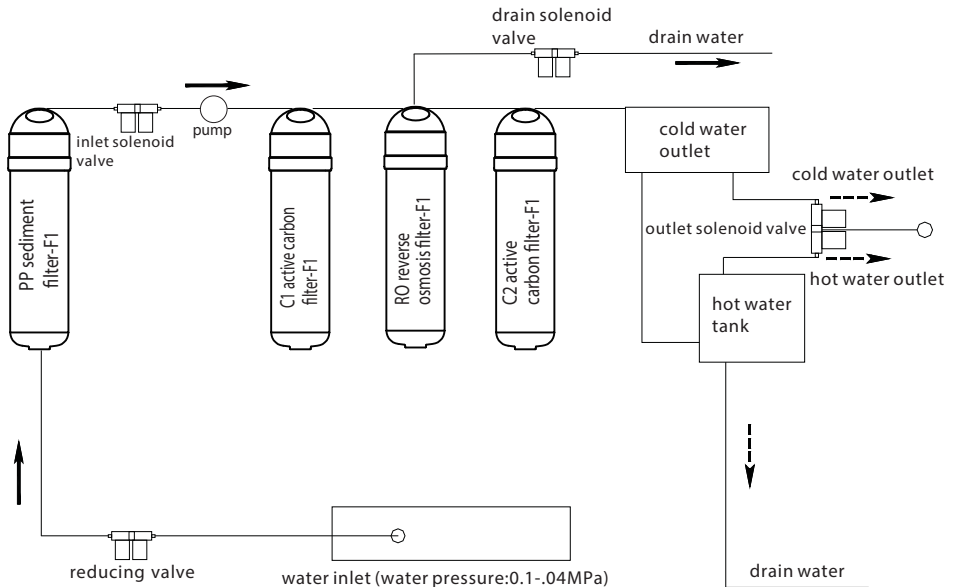

● Filter Function Introduction

Stage	Filter	Function
Stage 1	PP sediment filter-F1	Carry out coarse filtration of original water, and filter out mud, sand, impurity, iron rust and suspension, etc.
Stage 2	C1 active carbon filter-F1	Absorb unusual colors and odors, Remove residual chlorine and organic substances in water.
Stage 3	RO reverse osmosis filter-F1	Nonionic Absorbing: Organics, alcohol, ketone, aldehyde, phenol. Particulate retention: Solid suspended solids, Colloids.
Stage 4	C2 active carbon filter-F1	Further absorb micro-molecules and organic substances in water. Make water taste better.

3. Use Guide and Maintenance



Please cut off water source before replacing filters. Never plug filters in water running state.

3-1. Guidance on Unpacking and Installation

Very Important Issue

We recommend that the main unit installation be requested by a specialist and installed.

Note: For connection to the Tap water pipe, please consult your dealer or Water works store.

1. Open the top of the packing case, take out the top foam and its accessories (include 4 filters and inlet ball valve).
2. Put the accessories aside.
3. Unpack the product.
4. Take out the inlet ball valve.
5. Attach inlet ball valve to tap water pipe.
6. Attach the PE pipe to the inlet ball valve (Insert firmly until it hits).

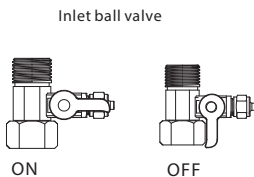

(1)

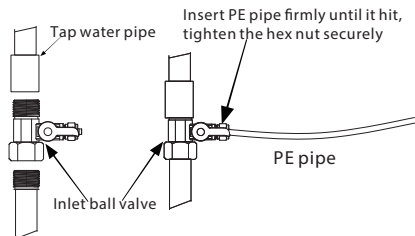

(2)

5. Use the accessory—filter flushing tip, the arrow direction is the water flow direction, insert the PE pipe in the inlet ball valve.

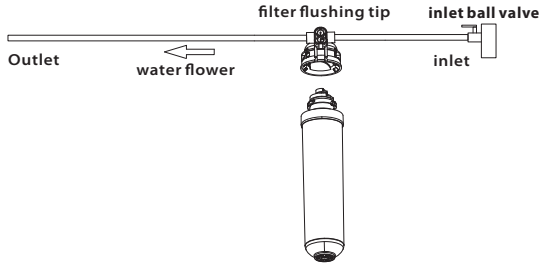

6. Insert the C1 active carbon filter into the filter flushing tip, tighten it by turning clockwise, and open the water tap to flush the filter till it doesn't discharge black water, for about 10min; Take the same step to flush the C2 active carbon filter-F1.

7. Install the clean filter in the product, hold the filter base with the left hand and enclosure of filter with the right hand, and insert it upwards in the filter, tighten it by turning clockwise, the installation order is: PP sediment filter-F1→C1 active carbon filter-F1→RO reverse osmosis filter-F1→C2 active carbon filter-F1

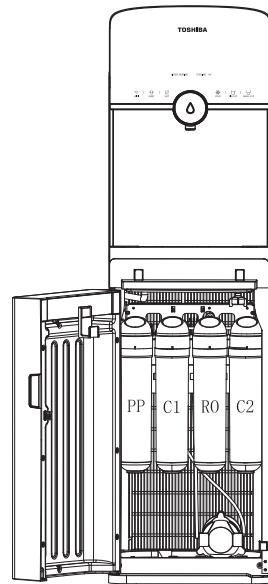
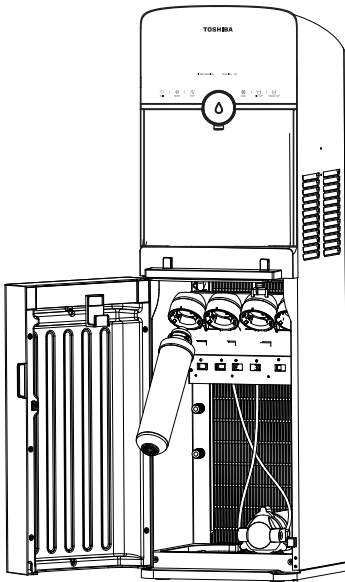

8. For quick connector at back side of WP, Remove the snap ring and press lock ring of quick joint to take out the white plug.

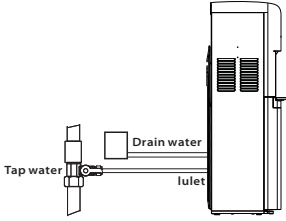
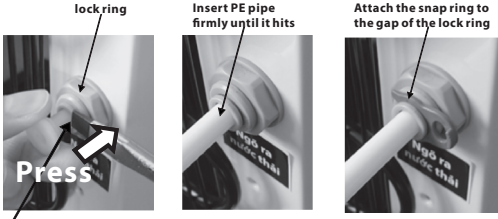

- 9. Insert PE pipe into water inlet valve and Drain water valve, and make sure it insert firmly .
- 10. After installing, supply power, and use it normally.
- 11. The water purifier plug cord into a ground fault interrupter receptacle.
- 12. When installing filter and replace filter please turn off the water and power supply before installation and replacement.

3-2. Machine installation

To prevent the machine from swaying or falling, please install the bracket accordingly.

- 1-2. Loosen screw under the black cushion of the left or right bottom angle just as the picture shown.
- 3. Use the screw removed above to fix the bracket on the left or right bottom angle of the Water Purifier.
- 4. Make a hole on the floor's or the desk's surface where the water dispenser will be installed.
- 5. Fix the bracket on the floor by attached expansion rubber plug and Long screw tightly. The rubber gasket is set between the fixed bracket and the ground (or desk).
- 6. Tighten the attached long screw.

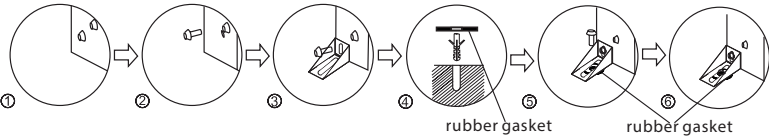
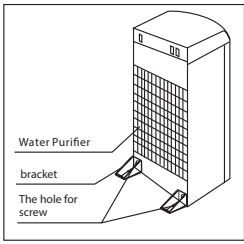

WARNING! To avoid a hazard due to instability of the appliance, it must be fixed in accordance with the instructions.

3-3. The display panel is shown as below

DISPENSING WATER

This unit has been tested and sanitized prior to packing and shipping. During transit dust and odors can accumulate in the tank and lines. It is recommended to turn on the heating and cooling functions after the first tank of water is filled, let it stand for 2 hours, then turn off the heating and cooling functions and disconnect the power plug. Drain the internal water through the hot water outlet, repeat it again, and make water again for the third time before drinking.

Dispensing Cold Water

After setup, it will take up 1 hour to get water to maximum cold temperature. During this time the compressor could run continuously. This is normal.

1. While the “ COOLING ” turns off, Position bottle or cup below spout.
2. Touch the cold water button “ ❄️ ”, then touch the get water button “ ◯ ”, the indicator turns on and the device starts discharging cold water. Touch the get water button “ ◯ ” again, the indicator turns off, the device stops discharging water, finish getting water.
3. Touch the cold water button “ ❄️ ” and “ 🍵 ”, then touch the get water button “ ◯ ”, the indicator turns on and the device starts discharging cold water. The machine will dispensing about 25 seconds.
4. Touch the cold water button “ ❄️ ” and “ 🍵 ”, then touch the get water button “ ◯ ”, the indicator turns on and the device starts discharging cold water. The machine will dispensing about 12 seconds.

Dispensing Hot Water

1. While the “ HEATING ” turns off, Position bottle or cup below spout.
2. Touch the hot water button “ 🔥 ”, then touch the get water button “ ◯ ”, the indicator turns on and the device starts discharging hot water. Touch the get water button “ ◯ ” again, the indicator turns off, the device stops discharging water, finish getting water.
3. Touch the hot water button “ 🔥 ” and “ 🍵 ”, then touch the get water button “ ◯ ”, the indicator turns on and the device starts discharging hot water. The machine will dispensing about 25 seconds.
4. Touch the hot water button “ 🔥 ” and “ 🍵 ”, then touch the get water button “ ◯ ”, the indicator turns on and the device starts discharging hot water. The machine will dispensing about 12 seconds.

3-4. Filter Replacement Cycle

PP sediment filter-F1	C1 active carbon filter-F1	RO reverse osmosis filter-F1	C2 active carbon filter-F1
6 months	6 months	24 months	12 months

Special hints:

1. The data above are for references only. It is based on 10L per daily drinking water. The specific cycle for replacement of filters varies with local water quality and water amount consumed.
2. If use an unofficial filter may cause damage to the water purifier and prevent it from working properly.

Maintenance of Filtration System:

- 1) While the “ FILTER ” is flashing, it indicates the filter should be changed.
- 2) Checking the filter replace advise table at the last of the manual and find out which filter should be replaced.

●Replacement filter

- Be sure to use genuine TOSHIBA replacement filter.
- The replacement filter model number.

Filter name	PP sediment filter-F1	C1 active carbon filter-F1	RO reverse osmosis filter-F1	C2 active carbon filter-F1
Filter model number	F-1643-PP	F-1643-C1	F-1643-RO	F-1643-C2

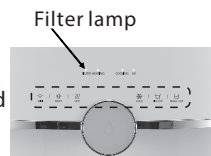

How to get the replacement filter.

Please call up 025117777 for your replacement filter inquiry or visit <https://www.toshiba-lifestyle.com/th>

3) To replace the maturity filter by the new one.

If C1 or C2 is needed to replace, go back page 9 of this manual and use "filter flushing tip" to discharge black water.

4) After replacement, please touch the reset button "  ", until the "FILTER" light stop splashing.

5) After the above 4 steps, you can use the product as usual.

3-5. WIFI function connection

See details: **Application Software Use Guide.**

1. Mobile app store search: TSmartLife, download APP .

2. Long press  for 3 seconds, light flashes, the mobile phone opens the APP to configure the network, and the WIFI indicator is always on after the connection is successful.

3. Brief function description of APP:

- Total water consumption display : You can see the cumulative daily, weekly, monthly and yearly water consumption through the APP.
- Filter replacement reminder: If the life of filters is about to expire, the APP will remind you with Red/Yellow color.

3-6. Maintenance

1. Keep this machine in a dry and cool place and avoid direct sunshine. Rearward of the machine shall be at least 20 cm away from the wall. Never put the machine on paper or foam, which may store water and then cause creepage. Never put anything flammable beside this machine. Do not use the machine outdoors or in a place that can be splashed by water.
2. For the water purifier, the installation and replacement of filters must be carried out by qualified personnel.
3. In case the machine is not in use for not so long time, turn off the heating switch and the refrigerating switch to save power.
4. In case the machine is not needed for a long time, please take off the plug, turn off the copper chrome - plated ball valve and drain off the remaining water through the outlet. For another use, discharge water for 10 min. In the event that the machine is blocked by ice due to the environment below ice point, keep the refrigerating switch closed for 4 hours and then turn it on to continue the operation.
5. In case the water supply is cut off, please close the feed water ball valve and cut off the power, after water re-supply, please open the other faucets to discharge sediment and then turn on the feed water ball valve.
6. The machine must use an earthed three-pin socket. In case the socket don't have grounding plug, the set must be grounded by connecting the grounding wire - on back side of WP, to the ground with instruction from professional person.
7. Never use organic solvents such as gasoline to clean the machine: strictly prohibit washing the machine with water or splashing water to the machine.

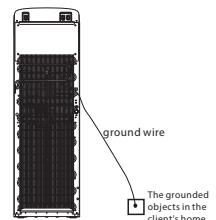

8. Never turn on (off) the machine by inserting the plug into (pulling the plug out from) the socket. Never increase the length of the supply cord to avoid fire.
9. If the supply cord is damaged, it must be replaced by the manufacturer or qualified person so as to avoid a hazard.
10. The water source for the water purifier is civil tap water.
11. Never dismantle spare parts of the machine to avoid water leakage or damage.
12. Never turn the machine upside down or lean it more than 45° when moving it so as to avoid any damage to it or any accident.
13. Limited warranty: electrical components and water system are warranted for 12 months from date of purchasing.

3-7 Troubleshooting

In case of failure, please carry out inspection according to the requirements below. If unresolved, please contact the local service agency.

Failure	Cause	Solution
Small water flow	Low water pressure	Check the water inlet(Fig. 1)
	Filter not replaced in time , beyond the use time	Please contact the local service agency to replace the filter
Unsuitable Water temperature	Over consumption of water in a short time	Just wait a moment, and water is available again
	Power supply not put through	Please switch on power supply
	Corresponding functions not started	Press a corresponding function key to start the function
Water leakage	Pipe not connected properly	Inspect the connector to connect the pipe properly(Fig. 2)
	Water pipe and PE pipe bursting	Replace the water pipe and PE pipe
“  ” light flashing and buzzer alarming	There should be leakage	contact the local service center
Electric leakage	Machine in poor contact with ground	Use a three-pin socket with earth wire, making the machine grounded properly
Noisy operation	Not installed steadily	Place the machine on a steady & solid surface(Fig. 3)
Machine fails to run	Power supply not put through	Switch on power supply
No hot or cold water	The hot tank or the cold tank is not working	Please turn on heating and cooling switches after connecting to the water pipe(Fig. 4)
Water in the drip tray is full	Customer draws water overflow accumulation	Pull out the drip tray forward, pour away the water, install the drip tray back to its original position(Fig. 5)

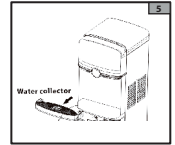
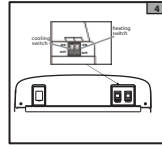
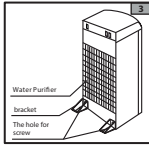
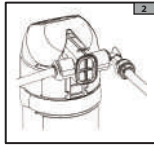
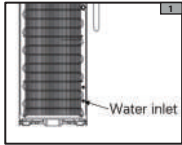

It is a normal state that the following circumstances occur when the water purifier is used.

1. During the heating , the heating tube may generate slight noises. This is a normal state.
2. When the heating tank is being heated without water, the anti dry-burning device will disconnect automatically and can not reset by its own. The reset must be completed by a professional technician. The design is in accordance with the national safety requirements.
3. When an ambient temperature is higher, the cooling capacity may be slower, which is a normal state.

Filter Replace Advise Table

Replacement recommendation	Replacing date	6 months 1st-PP	6 months 2nd-C1	24 months 3rd-RO	12 months 4th-C2
Fill in the first using date on the right	/ /	√	√	√	√
Advise to replace, 6 months later from the last time	/ /	√	√		
Advise to replace, 6 months later from the last time	/ /	√	√		√
Advise to replace, 6 months later from the last time	/ /	√	√		
Advise to replace, 6 months later from the last time	/ /	√	√	√	√
Advise to replace, 6 months later from the last time	/ /	√	√		
Advise to replace, 6 months later from the last time	/ /	√	√		√
Advise to replace, 6 months later from the last time	/ /	√	√		
Advise to replace, 6 months later from the last time	/ /	√	√	√	√
Advise to replace, 6 months later from the last time	/ /	√	√		
Advise to replace, 6 months later from the last time	/ /	√	√		√
Advise to replace, 6 months later from the last time	/ /	√	√	√	√
Advise to replace, 6 months later from the last time	/ /	√	√		
Advise to replace, 6 months later from the last time	/ /	√	√		√
Advise to replace, 6 months later from the last time	/ /	√	√	√	√
Advise to replace, 6 months later from the last time	/ /	√	√		
Advise to replace, 6 months later from the last time	/ /	√	√		√
Advise to replace, 6 months later from the last time	/ /	√	√	√	√
Advise to replace, 6 months later from the last time	/ /	√	√		
Advise to replace, 6 months later from the last time	/ /	√	√		√
Advise to replace, 6 months later from the last time	/ /	√	√	√	√