

# TOSHIBA

Installation Instruction  
**ELECTRIC WATER HEATER**  
For Home Use Only

Model

**DSK45ES5KB**  
**DSK45ES5KW**  
**DSK38ES5KB**  
**DSK38ES5KW**



**Read this manual carefully before installation and use**

After-sales engineers should test the ground resistance for the customers at least once per year to insure the grounding of the water heater is reliable

Sincerely thank you for selecting our electric water heater. Please read this manual carefully before use; correctly grasp the methods for installation and use of this electrical water heater, to make full use of its excellent performances. Please do preserve the instruction manual for future reference.

For any improper installation and incorrect operation of this product, our company will not be liable for any responsibility.

## TABLE OF CONTENTS



TITLE	PAGE
1. Product introduction .....	(5)
2. Unit installation .....	(8)
3. Troubleshooting .....	(11)

**DO CONNECT GROUND WIRE TO THE PRODUCT, otherwise NO FUNCTION**

# SAFETY INSTRUCTIONS

All instructions described should be carefully read and followed.



- These instructions are precautions to prevent the risks of serious injury or death of the user, and any damages to property.

MARKINGS	
 <b>WARNING</b>	WARNING indicates high possibility of serious injury (*1) or death of the user.
 <b>CAUTION</b>	CAUTION indicates high possibility of injury (*2) or property loss (*3).





(\*1) Serious injury – injury which requires hospitalization, lengthy treatment, or blindness, hot and cold skin burn, electric shock, broken bones or poisoning.













(\*2) Injury – injury, skin burn or electric shock which does not require hospitalization or lengthy treatment.

(\*3) Property loss – extended loss of houses, furniture, domestic animals or pets.

SYMBOLS	
 <b>PROHIBITED!</b>	<p>⊘ <b>PROHIBITED! Indicates prohibited actions.</b> Detailed instructions would be indicated on the inside of the circle or around the symbol in figures or in writing.</p>
 <b>IMPORTANT</b>	<p>● <b>IMPORTANT Indicates mandatory actions.</b> Detailed instructions would be indicated on the inside of the circle or around the symbol in figures or in writing.</p>
 <b>CAUTION</b>	<p>△ <b>CAUTION Recommends to take precautions.</b> Detailed instructions would be indicated on the inside of the triangle or around the symbol in figures or in writing.</p>

## \* Precautions for installation

 <b>WARNING</b>	
 Household Use	This electric water heater is for household, and it can be installed wherever place that need hot water. Can not be used for business use.
 Classified Worker	Installation, piping works and wiring works or electrical construction should comply to relevant laws and follow the installation instruction. If fail to comply, leakage or electricity may lead to fire or electric shock.
 Prohibited	Do not install this electric water heater outside, indoor use only. It may result fire or electric shock.
	Plug is not used for this electric water heater; this electric water heater must be connected directly with power switch that comes with leakage-protection. Please distinguish live line (red/brown), neutral line (blue) and earth line (green/yellow) during installation. If using the earth leakage circuit breaker under out of order condition, it may result electric shock.

 220V~	<p>Specification: Only connect to main voltage 220V~.  Do check whether the amperes of the household wiring enough. Directly connect to the AC outlet, and don't use multiple outlets. This may cause fire or electric shock.</p>
 Grounding	<p>Before installing this electric water heater, check and confirm the earth electrode on the socket is reliably earthed, without electricity. If there is no ground electrode or incorrect ground connection, the electric water heater will not work. Do not connect grounding wire to gases or water pipes.  The grounding wire connection should be provided individually.</p>
	<p>The distance between water heater installed and water output should be as nearby as possible to avoid loss of heat.</p>
	<p>The electric water heater may be damaged if the water hardness is too high. To ensure longer product lifespan, please install and put it into use on condition that the local water hardness is less than 450mg/L (CaCO<sub>3</sub>)</p>
 Blow Down	<p>Please blow down the water for about 10 seconds to drain away the impurities in the pipe before connecting the water source to the electric water heater to avoid blockage of water heater .</p>
 Prohibited!	<p>Do not place flammable materials or Gases near to the Electric water heater. It may result fire or explosion.</p>
 Validation	<p>Ensure the function of built-in ELCB (once a month).  If using the ELCB under out of order condition, it may result electric shock.</p>
 Validation	<p>Check the earth connection periodically (1 times a year) by the Electrician. Otherwise you may receive an electric shock. This can lead to a serious injury or death.</p>
 Professional	<p>Do cut-off power supply before any maintenance. Any maintenance or adjustment towards this product by non-professional is highly prohibited.</p>
 Professional	<p>The damaged power cord must be replaced by a good power cord provided by the manufacturer, and the replacement should be done by a qualified technician or engineer or professionals of the similar products.</p>
	<p>In order to avoid a hazard due to inadvertent resetting of the Earth Leakage Circuit Breaker (ELCB), this electric water heater must not be supplied through an external switching device, such as timer or connected to a circuit that is regularly switched "On" and "Off " by the utility.</p>
	<p>Electric water heater is equipped with adjustable flow capacity safety valve. For safety use, please do not change its installation location and do not block its water outlet.</p>
	<p>This electric water heater can be used for other purpose, eg. Washing hands, dishes or foods, and so on.  (Multi directional water supply is not available).</p>



## Ground resistance measurement method:

- Connect the wire of measuring instrument according to the manual. Please check the diagram.
- Connect E1 to the ground wire, and connect E2, P2 to the auxiliary electrode of steel bar in the soil. The distance of E1, E2, P2 and steel bar should be greater than 20m. It requires the measurement site should avoid strong electric field, in order to reduce the measurement error.
- There are 4 terminals E1, E2, P1, P2 on grounding resistance measuring instrument. E1 and P1 are usually connected for convenience use. You only need to connect the E1 to the ground terminal and E2, P2 connected to the auxiliary electrode steel bar in the soil.
- If there is not soil to drill the steel bar in, you can connect P2, E2 to neutral terminal of the fire hose or floors, which can be considered as the ground resistance.
- Then, press the POWER button, select the appropriate test range (if not clear about the scope of the resistance, choose the biggest range, and then choose the smallest range.), press the PRESS key, the screen display number is the resistance value of grounding resistance of the house.

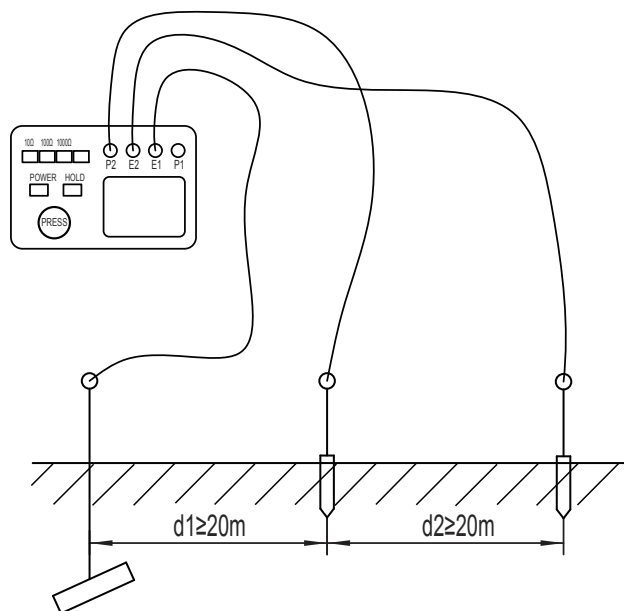

### NOTE

After-sales engineers should test the ground resistance for the customers at least once per year to insure the grounding of the water heater is reliable.

## 1. PRODUCT INTRODUCTION

### 1.1 Technical Performance Parameters

Series	DSK**ES *			
Model	DSK45E5KW	DSK45E5KB	DSK38E5KW	DSK38E5KB
Rated Voltage	220V ~			
Rated Frequency	50 Hz			
Rated Power	4500W	4500W	3800W	3800W
Rated Current	0~20.5A	0~20.5A	0~17.3A	0~17.3A
Dia. Of Wire Core	2.5mm <sup>2</sup>	2.5mm <sup>2</sup>	2.5mm <sup>2</sup>	2.5mm <sup>2</sup>
Air Switch	≥25A	≥25A	≥25A	≥25A
Rated Pressure	0 MPa			
Minimum Flow Rate	1.5 Liters/minute			
Minimum Pressure	0.03 MPa			
Maximum Pressure	0.3 MPa			
Protection Class	I			
Water Proof Class	IP25			
Products Size	200×400×97 mm			
Knob Quantity	1			

## 1.2 Parts Identification

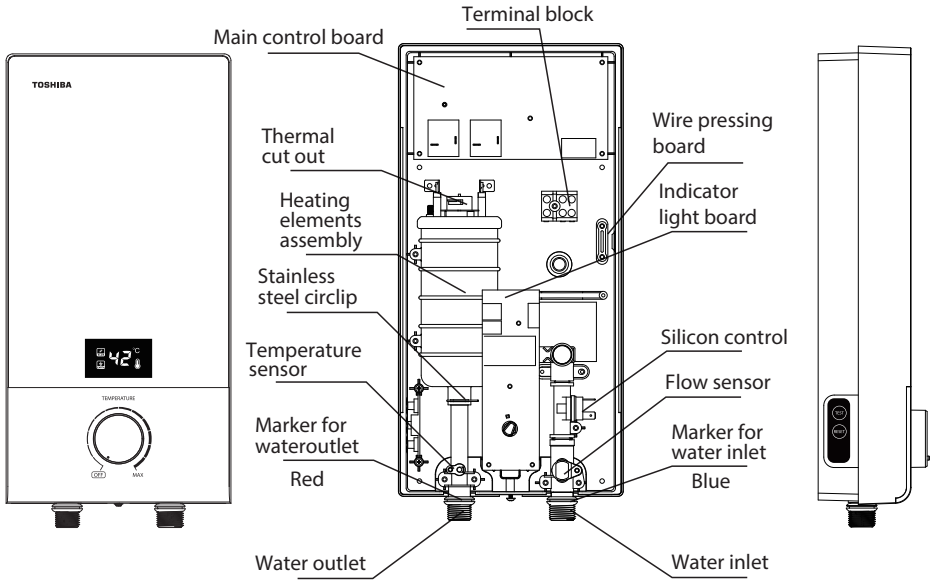

↑ PRODUCT STRUCTURE FOR DSK\*\*ES5\*\*

## 2.3 Internal Wire Diagram

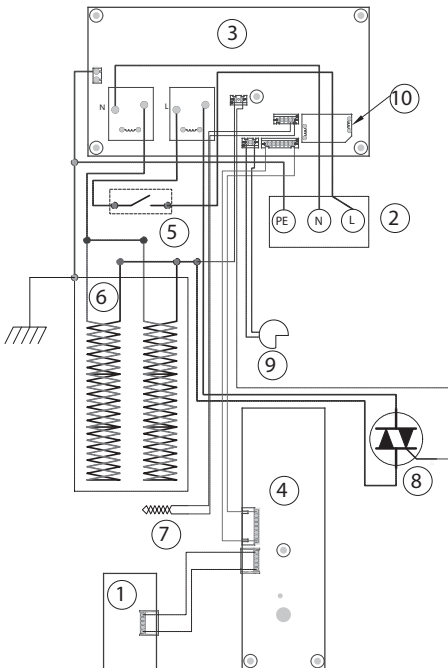

WIRING DIAGRAM FOR DSK\*\* ES5\*\*

- ① : Key board
- ② : Terminal Block
- ③ : Main Control Board
- ④ : Indicator Light
- ⑤ : Thermal Cut Out
- ⑥ : Heating Elements
- ⑦ : Temperature Sensor
- ⑧ : Silicon Control
- ⑨ : Flow Sensor
- ⑩ : Mutual inductor

## 2. UNIT INSTALLATION

### 2.1 Installation Instruction

- ① Check the capacity of power circuit; (220V~, ≥25A)
- ② Power cord installation;
- ③ Water heater installation;
- ④ Plumbing connection;
- ⑤ Power supply connection;
- ⑥ Water Supply.

### 2.2 Power Cord Installation

#### Step 1

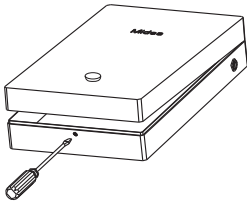

Remove the screws at the bottom of the unit. Lift up the Main Switch Knob and Power Knob to make it free. Remove the front plate gently.

#### Step 2

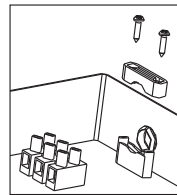

Remove the power cord wire pressing plate and keep the screws.

#### Step 3

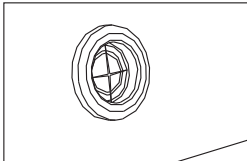

Gash the middle of the film of the power cord jacket with a sharp knife in order to put into power lines.

#### Step 4

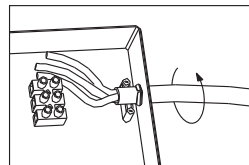

Screw the power cord into the jacket for installation of wire pressing plate.

#### Step 5

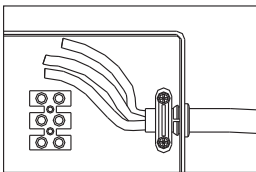

Tighten the wire pressing plate with screws to primary position, ensure that the power cord not be pulled out more than 60N.

#### Step 6

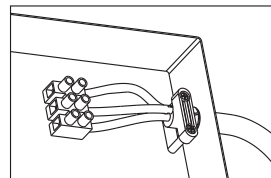

Connect the power cord to wiring terminals; the method is as shown in picture.



## NOTE

The installation position of neutral line (blue), live line (brown/red) and earth line (green/yellow) should be corresponding to the other end on wiring terminals.

### 2.3 Water Heater Installation

- ① Determine installation position of the unit according to length of power cord / position of air switch (Distance between bottom and floor should be  $\geq 1.6\text{m}$ ).
- ② Make sure the distance between the unit and surrounding wall is not less than 300mm, so that to have enough space for maintenance purpose.
- ③ Determine the position of four fixing screws (attached with the unit), make four holes with corresponding depth in the wall by means of a drill and drive a wall plug into the hole.
- ④ Fix the back cover to the wall with 4 screws, connect the power cord and install the flow valve, the inlet pipe and the outlet pipe. (See Fig.1)
- ⑤ Open the flow valve to allow the water go through the heater then turn the power on. Test the machine unit it works well. then close the front cover and lock with screws from the bottom.

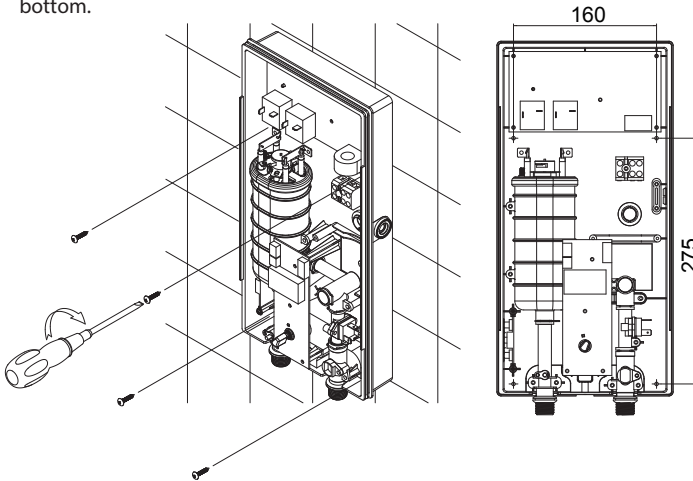

(Fig.1)

### 2.4 Plumbing Connection

- ① Water valve with filter should be installed at water inlet of the unit, sealing ring with filter should be used at end face. (See Fig.2).
- ② Shower flexible tube should be connected with water outlets and shower head separately, attached sealing ring should be used at end face.



## WARNING

Metallic / chromed hose and conductive control valve shall not be used.

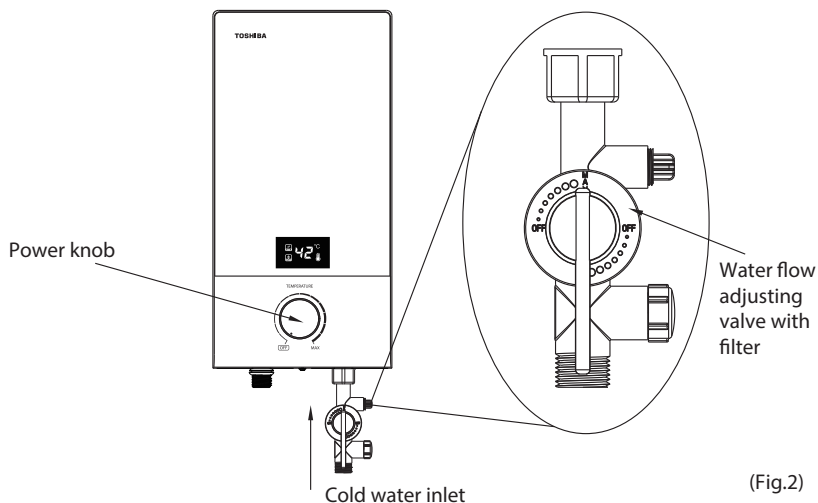

## NOTE

Water flow adjusting valve with filter must be used when install the unit. Blue marker stands for water inlet, red marker stands for water outlet. Do not overexert to avoid damaging the water heater.

### 2.5 Power Supply Connection

- ① Adjust power knob to "OFF";
- ② Choose air switch with leakage protection according to power of water heater;
- ③ When connecting the water heater to electric network, please pay attention to connect live line (red/brown), neutral line (blue) and earth line (yellow/green) with corresponding line in electric network.



## NOTE

A private power cord should be used for this unit. After connecting to electric network, please check the earth condition. Otherwise you may receive an electric shock. This can lead to a serious injury or death.

### 2.6 Water Supply

After all the plumbing is finished connecting, open water inlet valve of the product and supply water to the unit to drain away air inside until there is stable water flow comes out from shower head. Check whether there is leakage at joints or not. If there is, check whether the connecting parts are fastened or not, then re-supply water.

### 3. TROUBLESHOOTING

SYMPTOMS	REASONS	SUGGESTIONS
Switch on the power supply, The screen displays nothing	<ol style="list-style-type: none"> <li>1. Power supply error,</li> <li>2. PCB error;</li> <li>3. Electricity leaks.</li> </ol>	<ol style="list-style-type: none"> <li>1. Check whether power is cut</li> <li>2. Contact authorized service personnel for repair.</li> </ol>
The heating indicator light is off and the outlet water is cold.	<ol style="list-style-type: none"> <li>1. The power knob is off;</li> <li>2. PCB error ;</li> <li>3. The water flow insufficient 1.5L/min;</li> <li>4. Impurities clogging the flow sensor of the rotor</li> </ol>	<ol style="list-style-type: none"> <li>1. Rotate power knob</li> <li>2. Repair or replacement the PCB</li> <li>3. Adjustable water flow</li> <li>4. Change the flow sensor</li> <li>5. Open the flow sensor and clean the rotor</li> </ol>
The heating indicator light is on and the outlet water is cold	<ol style="list-style-type: none"> <li>1. The thermal cut out is cut off</li> <li>2. Heating elements is broken</li> </ol>	<ol style="list-style-type: none"> <li>1. Press the reset handle of the thermal cut out after checking and troubleshooting</li> <li>2. Change the heating elements</li> </ol>
No water flows out from the shower head.	<ol style="list-style-type: none"> <li>1. The running water supply is cut off;</li> <li>2. The inlet valve of running water is not open</li> </ol>	<ol style="list-style-type: none"> <li>1. Wait for restoration of running water supply;</li> <li>2. Open the inlet valve of running water</li> </ol>
Outlet water temperature sometimes is hot, sometimes is cold.	<ol style="list-style-type: none"> <li>1. Water pressure is not stable</li> <li>2. Outlet water temperature is too high, overheating protection again and again.</li> </ol>	Adjust the heating power lower, make the water flow bigger
The display "E1" or "E3" flashes.	<ol style="list-style-type: none"> <li>1. The screen flashing "E1" indicates the temperature sensor failure.</li> <li>2. The screen flashing "E3" indicates heating element dry burning and Triac abnormal.</li> </ol>	Contact authorized service personnel for repair.
The "EARTH" on the screen goes out and heater doesn't work	The heater is not connected to the ground wire.	Test the ground resistance with a grounding resistance meter. Connect ground wire properly



TOSHIBA THAILAND CO.,LTD.  
201 Vibhavadee Rangsit Road, Chatujak,Bangkok 10900