

INSTRUCTION MANUAL

TOASTER OVEN

TL2-SAC25GZC(GR)

Please review this instruction manual before operating.

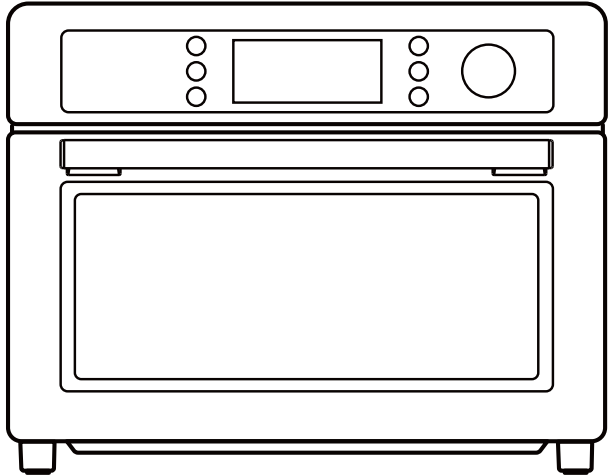

TOSHIBA

IMPORTANT SAFEGUARDS

Basic safety precautions	01
Before first use	03

PRODUCT INSTRUCTION

Names of parts	04
----------------------	----

OPERATION

How to use	05
Mute function	07
Airfry function	07
Airfry menu function	08
Toast function.....	09
Bake function	10
Broil function	11

Roast function 12

Pizza function 13

Cookies function 14

Bagel function 15

Reheat function 16

Warm function 17

Proof function 18

Slow cook function 19

Dehydrate function 20

Wifi function 21

TSmartLife app function instruction 21

Care and cleaning 22

Specification 23

Attributions 23

IMPORTANT SAFEGUARDS

BASIC SAFETY PRECAUTIONS

When using electrical appliance, basic safety precautions should always be followed, including the following:



This appliance is not intended for use by persons (including children) with reduced physical, sensory or mental capabilities, or lack of experience and knowledge, unless they have been given supervision or instruction concerning use of the appliance by a person responsible for their safety.



Children should be supervised to ensure that they do not play with the appliance.



If the supply cord is damaged, it must be replaced by the manufacturer, its service agent or similarly qualified persons in order to avoid a hazard.



Avoid contacting moving parts.



The appliances are not intended to be operated by means of an external timer or separate remote-control system.



The temperature of accessible surfaces may be high when the appliance is operating.



Accessible parts may become hot during use. Young children should be kept away.



The appliance is intended to be used freestanding.



Remove plug from outlet when the appliance is not in use, before on or taking off parts, and before cleaning. Allow to cool before handling.



Extreme caution should be exercised when using containers constructed of other metal or glass.



This appliance is intended to be used in household and similar applications such as:

- staff kitchen areas in shops, offices and other working environments;
- by clients in hotels, motels and other residential type environments;
- farm houses;
- bed and breakfast type environments.



WARNING: Ensure that the appliance is switched off electric shock.



Do not place any of the following materials in the oven: paper, cardboard, plastic, and the like.

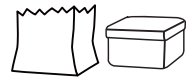

Do not store any materials, other than manufacturers recommended accessories in this oven when not in use.



The surfaces are liable to get hot during use.

**READ CAREFULLY AND
KEEP FOR FUTURE REFERENCE**

BEFORE FIRST USE

1. Remove all accessories and shipping materials packed inside the Oven.

2. Wash the Baking rack and Baking tray in warm soapy water. Wipe the inside of the Oven with a damp cloth or sponge. Blot dry with paper towels to make sure that the unit is dry before using.



3. Place Oven on a flat counter or other stable surface.
DO NOT OPERATE ON THE SAME CIRCUIT WITH
ANOTHER APPLIANCE.



4. Make sure that the crumb tray is properly installed before using.

For the first time only. For the function setting on roast, set the temperature to MAX and the timer to 15 minutes. This will burn off any oils still on the oven.



CAUTION

The oven may smoke during this process. This is normal for a new oven and will not last more than 10-15 min.

PRODUCT INSTRUCTION

NAMES OF PARTS

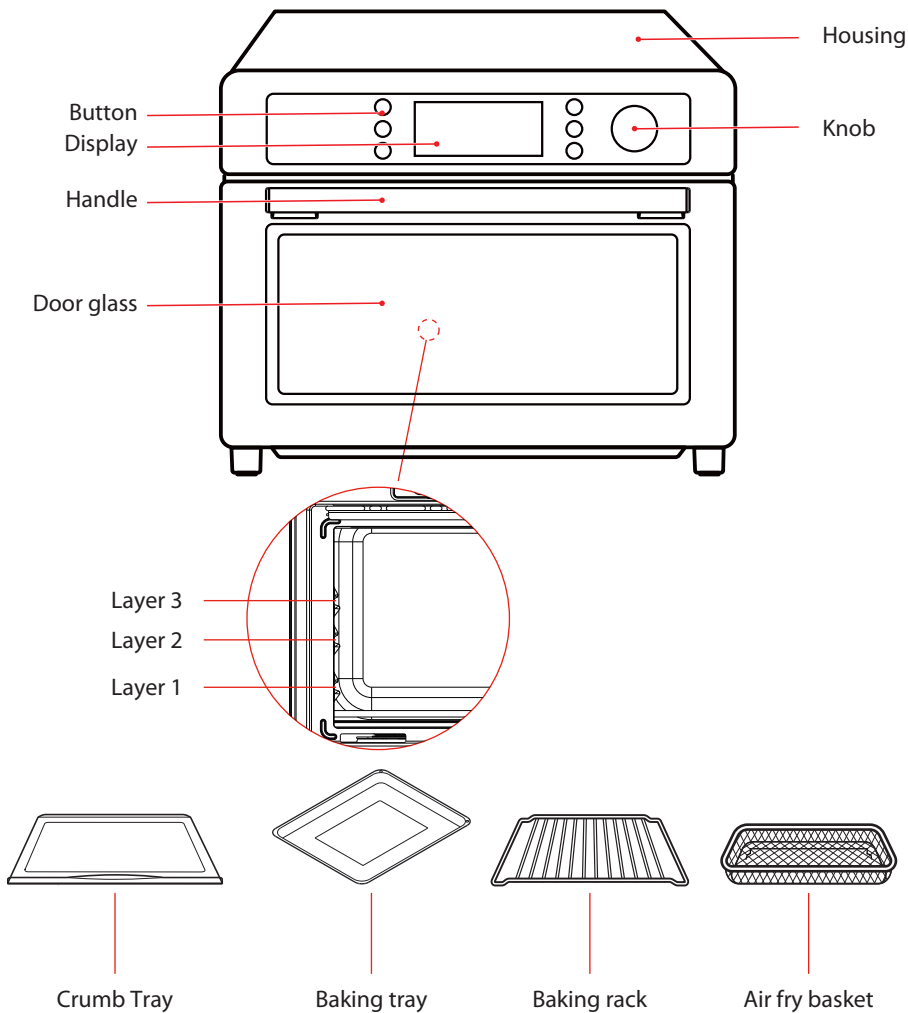

NOTE

All pictures in this manual are for illustrative purposes only; these may be slightly different from the purchased equipment, please refer to the actual product.

HOW TO USE



CAUTION

THE OVEN SURFACES ARE HOT DURING AND AFTER USE.

INSTRUCTIONS

- 1 Place the Baking rack in position that will accommodate the height of the food to be cooked.
- 2 The food must be put into the baking tray to avoid the fire danger that caused by the accumulation of food chipping on the heating pipes
Make sure that you always use an ovenproof container in the oven, never use plastic or cardboard containers in the Oven.
- 3 Clean the heating pipe periodically.
- 4 Never use glass or ceramic pans or lids.
- 5 DO NOT let juices run to the bottom of the oven. Use the Crumb Tray when cooking.
- 6 Set the temperature as suggested by the recipe or as desired.
- 7 Securely shut the door and set the cooking time to begin operating the oven.
- 8 When you use the baking rack, please put the baking rack the suitable level, please put the convex upward.
- 9 Please don't unplug the power cord when the oven finish working. The fan will stop delay working 1 min.

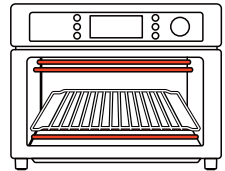

About Rack Levels

Baking rack can place different baking layers, and is suitable for baking different foods.

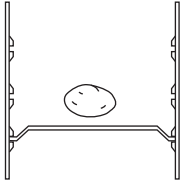

1. The concave side of the baking rack on the lower layer, which is suitable for baking potatoes.

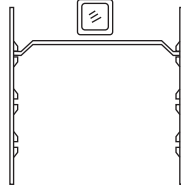

2. The concave side of the baking rack on the upper layer, which is suitable for baking bread slices.

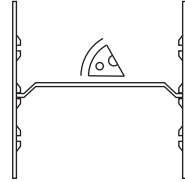

3. The convex side of the baking rack on the middle layer, which is suitable for baking pizza.

When the oven is electrified, the buzzer will ring once. The default function is AIRFRY. In the process of cooking, you can press "OK/START/PAUSE" to pause cooking.

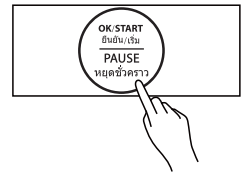

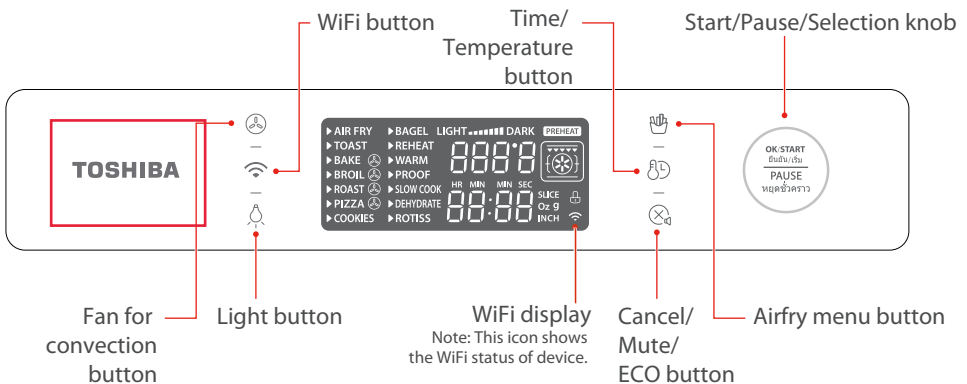

CONTROL PANEL



FUNCTION INSTRUCTION

MUTE FUNCTION

When you want the oven to go silent, long press “” for 3 seconds. The display screen will show “off”. Then the machine will be in the mute function. Long press “” 3 seconds, the mute function will be canceled. The display screen will show “on”.

ECO FUNCTION

To enter ECO mode:

1. In waiting state, press “” once, the screen will turn off.
2. In waiting state or the end of cooking, the screen will turn off if there is no operation in 5 minutes.

To cancel ECO mode:

In Eco mode, You can press any button or open the door to cancel it.

AIRFRY FUNCTION

- 1 Power on to enter initial state, rotate “OK/START/PAUSE” knob to the right once. The screen displays “AIRFRY” and “”.

- 2 Press and rotate “OK/START/PAUSE” knob to adjust the temperature. The default temperature is 200°C. This temperature is the cooking temperature after preheating.

- 3 Press “” button, rotate “OK/START/PAUSE” knob to adjust cooking time. The default cooking time is 15 minutes. This time is the cooking time after preheating.

- 4 Press “OK/START/PAUSE” button to preheat. (If no preheating is selected, you can turn the knob once. The preheating icon is off, indicating no preheating)



- 5 After preheating, put the food into the cooking machine and close the door. Press the “OK/START/PAUSE” button to start cooking.

- 6 You can press the “” button and rotate the “OK/START/PAUSE” knob to adjust the temperature and the time during cooking process.

- 7 After the cooking finishes, the machine will beep 3 times and the display screen will show “End”. Pay attention to the high temperature of both the food and the machine when you take out the food.



AIRFRY MENU FUNCTION

1 When the function is AirFry, press the “” button once, it will into the AirFry menu. The display screen will show “A01 and” ”.

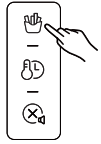

2 Rotate the “OK/START/PAUSE” knob and you can choose functions from A01-A11 in the menu. The default function is A01 (Frozen French fries).



3 Press the “” button and rotate the “OK/START/PAUSE” knob to adjust the temperature. The default temperature of A01 is 200°C. This temperature is the cooking temperature after preheating.

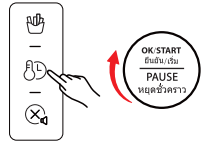

4 Press the “” button and rotate the “OK/START/PAUSE” knob to set the cooking time. The default cooking time of A01 is 18 minutes. This time is the cooking time after preheating.



5 Press the “OK/START/PAUSE” button to preheat. (A01/A11 does not need to preheat)



6 After preheating, put the food into the cooking machine and close the door. Press the “OK/START/PAUSE” button to start cooking. (If A01 is selected, put french fries in the Air Fry basket. It is recommended to use the default temperature and cooking time, or you can adjust the temperature and cooking time after start. If A04 is selected, the buzzer will sound 3 times to remind you to turn over when there is 10min left.)



7 You can press the “” button and rotate the “OK/START/PAUSE” knob to adjust the temperature and the time during cooking process.



- 8 After the cooking finishes, the machine will beep 3 times and the display screen will show “End”. Pay attention to the high temperature of both the food and the machine when you take out the food.

Display	AIR FRY Menu
A01	Frozen French fries
A02	Chicken wings
A03	Chicken Drumsticks
A04	Chicken leg
A05	Cod fillets
A06	Fried fish fillets

Display	AIR FRY Menu
A07	Fried Calamari
A08	Potato cheese strips
A09	Vegetables
A10	Potato wedges
A11	Spring rolls

TOAST FUNCTION

- 1 Power on to enter initial state, rotate the “OK/START/PAUSE” knob to the right twice. The screen displays “TOAST” and “”. The oven will enter the TOAST function.



- 2 Press and rotate the “OK/START/PAUSE” knob to choose the slice number of toast. The default number is 4 slices.



- 3 Press “” button, rotate “OK/START/PAUSE” knob to choose the degrees of toastiness. The default setting is 4.



- 4 Press “OK/START/PAUSE” to start cooking. The default temperature is 230°C. The temperature and time can’t be adjusted during cooking.



- 5 The buzzer will sound 3 times to remind you when cooking is finished, the screen displays “End”. Always pay attention when taking out food, because the food and oven are very hot.

BAKE FUNCTION

1 Power on to enter initial state, rotate the "OK/START/PAUSE" knob to the right thrice. The screen displays "BAKE" and " " and the fan is off (default). You can choose to turn on fan " ". After that, the screen displays "BAKE " and " ".



2 Press and rotate the "OK/START/PAUSE" knob to set temperature. The default temperature is 175°C. If the temperature is equal to or higher than 185°C, The display screen will show "BAKE" and " ".



3 Press " " button, rotate "OK/START/PAUSE" knob to set cooking time. The default cooking time is 25min.

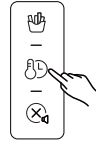

4 Press "OK/START/PAUSE" to start cooking.



5 During cooking, press " " and rotate "OK/START/PAUSE" to adjust temperature and cooking time.



6 The buzzer will sound 3 times to remind you when cooking is finished, the screen displays "End". Always pay attention when taking out food, because the food and oven are very hot.

BROIL FUNCTION

- 1 Power on to enter initial state, rotate the "OK/START/PAUSE" knob to the right four times. The screen displays "BROIL" and " " and the fan is off (default). You can choose to turn on fan " ". After that, the screen displays "BROIL " and " ".



- 2 Press and rotate "OK/START/PAUSE" knob to set temperature. The default temperature is 175°C.



- 3 Press " " button, rotate "OK/START/PAUSE" knob to set cooking time. The default cooking time is 10min.



- 4 Press "OK/START/PAUSE" to start cooking.



- 5 During cooking, press " " and rotate "OK/START/PAUSE" to adjust temperature and cooking time.



- 6 The buzzer will sound 3 times to remind you when cooking is finished, the screen displays "End". Always pay attention when taking out food, because the food and oven are very hot.

ROAST FUNCTION

- 1 Power on to enter initial state, rotate the "OK/START/PAUSE" knob to the right five times, the screen displays "ROAST" and "□" and the fan is off (default). You can choose to turn on fan "🌀". After that, the screen displays "ROAST 🌀" and "🌀".



- 2 Press and rotate "OK/START/PAUSE" knob to set temperature. The default temperature is 175°C.



- 3 Press "🕒" button, rotate "OK/START/PAUSE" knob to set cooking time. The default cooking time is 10min.



- 4 Press "OK/START/PAUSE" to start cooking.



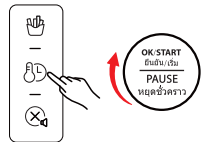

- 5 During cooking, press "🕒" and rotate "OK/START/PAUSE" to adjust temperature and cooking time.



- 6 The buzzer will sound 3 times to remind you when cooking is finished, the screen displays "End". Always pay attention when taking out food, because the food and oven are very hot.

PIZZA FUNCTION

- 1 Power on to enter initial state, rotate the “OK/START/PAUSE” knob to the right six times, the fan “” displays (default), and the screen displays “PIZZA ” and “”. The oven will enter the PIZZA function.



- 2 Press and rotate “OK/START/PAUSE” knob to set the size of pizza (6 inches, 9 inches, and 12 inches). The default size is 9 inches.



- 3 Press “” button, rotate the “OK/START/PAUSE” knob to set temperature, temperature flashes. The default temperature is 165°C for 9 inches.



- 4 Press “” button, rotate “OK/START/PAUSE” knob to adjust cooking time, then the time flashes. The default time for 9 inches is 14min.



- 5 Press “OK/START/PAUSE” to start preheating, the screen displays “”.



- 6 After preheating, put the food in and close the oven door. Press “OK/START/PAUSE” to start cooking.



- 7 During cooking, press “” and rotate “OK/START/PAUSE” to adjust temperature and cooking time.



- 8 The buzzer will sound 3 times to remind you when cooking is finished, the screen displays “End”. Always pay attention when taking out food, because the food and oven are very hot.

COOKIES FUNCTION

1 Power on to enter initial state, rotate the "OK/START/PAUSE" knob to the right seven times, the screen displays "COOKIES" and "☐", the oven will enter COOKIES function.



2 Press and rotate "OK/START/PAUSE" knob to set temperature. The default temperature is 170°C.



3 Press "🕒" button, rotate "OK/START/PAUSE" knob to set time. The default time is 15min.



4 Press "OK/START/PAUSE" to start preheating, the screen displays "☐☐☐☐".



5 After preheating, put the food in and close the oven door. Press "OK/START/PAUSE" to start cooking.



6 During cooking, press "🕒" and rotate "OK/START/PAUSE" to adjust temperature and cooking time.



7 The buzzer will sound 3 times to remind you when cooking is finished, the screen displays "End". Always pay attention when taking out food, because the food and oven are very hot.

BAGEL FUNCTION

- 1 Power on to enter initial state, rotate the “OK/START/PAUSE” knob to the right eight times, the screen displays “BAGEL” and “”. The oven will enter BAGEL function.



- 2 Press and rotate “OK/START/PAUSE” knob to set the quantity (2, 4 and 6). The default value is 4.



- 3 Press “” button, rotate “OK/START/PAUSE” knob to set power level. The default power level is 4.



- 4 Press “OK/START/PAUSE” to start cooking. The default temperature /cooking time is 200°C/5min20sec. The cooking time is adjustable and the temperature is not adjustable.



- 5 The buzzer will sound 3 times to remind you when cooking is finished, the screen displays “End”. Always pay attention when taking out food, because the food and oven are very hot.

REHEAT FUNCTION

- 1 Power on to enter initial state, rotate the "OK/START/PAUSE" knob to the right nine times, the screen displays "REHEAT" and "□" and the fan is off (default). You can choose to turn on fan "🌀". After that, the screen displays "REHEAT" and "🌀".



- 2 Press and rotate "OK/START/PAUSE" knob to set temperature. The default temperature is 175°C.



- 3 Press "🕒" button, rotate "OK/START/PAUSE" knob to set cooking time. The default cooking time is 3min.



- 4 Press "OK/START/PAUSE" to start cooking.



- 5 During cooking, press "🕒" and rotate "OK/START/PAUSE" to adjust temperature and cooking time.



- 6 The buzzer will sound 3 times to remind you when cooking is finished, the screen displays "End". Always pay attention when taking out food, because the food and oven are very hot.

WARM FUNCTION

- 1 Power on to enter initial state, rotate the "OK/START/PAUSE" knob to the right ten times, the screen displays "WARM" and "🕒". The oven will enter WARM function.



- 2 Press and rotate "OK/START/PAUSE" knob to set temperature. The default temperature is 80°C.



- 3 Press "🕒" button, rotate "OK/START/PAUSE" knob to set cooking time. The default cooking time is 1 hour.



- 4 Press "OK/START/PAUSE" to start working.



- 5 During cooking, press "🕒" and rotate "OK/START/PAUSE" to adjust temperature and cooking time.



- 6 The buzzer will sound 3 times to remind you when cooking is finished, the screen displays "End". Always pay attention when taking out food, because the food and oven are very hot.

PROOF FUNCTION

1 Power on to enter initial state, rotate the “OK/START/PAUSE” knob to the right eleven times, the screen displays “PROOF” and “□”. The to the enter PROOF function.



2 Press and rotate “OK/START/PAUSE” knob to set temperature. The default temperature is 40°C.



3 Press “” button, rotate “OK/START/PAUSE” knob to set cooking time. The default cooking time is 50min.



4 Press “OK/START/PAUSE” to start working.



5 During cooking, press “” and rotate “OK/START/PAUSE” to adjust temperature and cooking time.

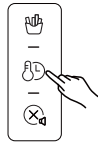

6 The buzzer will sound 3 times to remind you when cooking is finished, the screen displays “End”. Always pay attention when taking out food, because the food and oven are very hot.

SLOW COOK FUNCTION

- 1 Power on to enter initial state, rotate the "OK/START/PAUSE" knob to the right twelve times, the screen displays "SLOW COOK" and "🍲". The oven will enter SLOW COOK function.



- 2 Press and rotate "OK/START/PAUSE" knob to set temperature. The default temperature is 100°C.



- 3 Press "🍲" button, rotate "OK/START/PAUSE" knob to set cooking time. The default cooking time is 1 hour.



- 4 Press "OK/START/PAUSE" to start working.



- 5 During cooking, press "🍲" and rotate "OK/START/PAUSE" to adjust temperature and cooking time.



- 6 The buzzer will sound 3 times to remind you when cooking is finished, the screen displays "End". Always pay attention when taking out food, because the food and oven are very hot.

DEHYDRATE FUNCTION

- 1 Power on to enter initial state, rotate the "OK/START/PAUSE" knob to the right thirteen times, the screen displays "DEHYDRATE" and "🕒". Then the oven will enter DEHYDRATE function.



- 2 Press and rotate "OK/START/PAUSE" knob to set temperature. The default temperature is 70°C.



- 3 Press "🕒" button, rotate "OK/START/PAUSE" knob to set cooking time. The default cooking time is 4 hours.



- 4 Press "OK/START/PAUSE" to start cooking.



- 5 During cooking, press "🕒" and rotate "OK/START/PAUSE" to adjust temperature and cooking time.



- 6 The buzzer will sound 3 times to remind you when cooking is finished, the screen displays "End". Always pay attention when taking out food, because the food and oven are very hot.

WiFi FUNCTION

Deactivate WiFi module: Press "🔒" button and "OK/START/PAUSE" button on the knob at the same time to shut off the WiFi module if you do not need the device connected for a long time. Once the WiFi module shut off, all the WiFi functions will not be workable, the screen displays "oFF". And Press "🔒" button and "OK/START/PAUSE" button on the knob again to Activate the WiFi module.

Activate WiFi module: When wifi module is shut off, please press "🔒" button and "OK/START/PAUSE" button on the knob at the same time to activate the WiFi module in order to power on the WiFi function on the device so that you could enable the WiFi connection and connect the device and the APP, the screen displays "on".

Enable WiFi connection: Plug in at the first time, hold "📶" button for 3 seconds, the display will shows "AP", and then you can follow the steps shown on the TSmartLife to finish the WiFi connection.

Disable WiFi connection: Hold the "📶" button for 8 seconds , unbind the device from APP.

TSmartLife APP FUNCTION INSTRUCTION

Remote Control

All the cooking functions can be controlled through TSmartLife app. But for safety restriction, start cooking operation will not start the oven automatically until you confirm and press the START button on the oven.

*Please take attention to the notices from TSmartLife app.

Online Recipes

Online recipes have been pre-programmed by manufacturer. Select a recipe and follow the steps to prepare you food, it will set the recommended cooking time and temperature automatically.

CARE AND CLEANING

With reasonable care and cleaning, your appliance will retain its appearance and remain fully functioning for a long time. We will explain here how you should correctly care for and clean your appliance. Do not use glass cleaners or metal/glass scrapers for cleaning.

1 Before cleaning, unplug the toaster oven and allow it to cool completely.

2 Wash all the attachments with mild and soaped water including the baking rack and the baking tray. Do not use abrasive cleansers, scrubbing brushes, or chemical cleaner. This will cause damage to the non-stick coating of the baking tray.

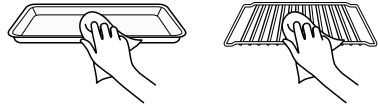

3 Using a wet cloth to wipe the inner of the oven. To clean the door, use a wet cloth saturated with detergent or soap.



4 Never immerse the unit in water or other liquid.

5 Any other servicing should be performed by an authorized service representative.

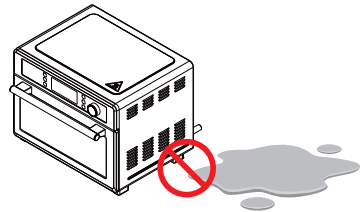

CAUTION

Warning: Hot Surface!

Advertencia: ¡Superficie Caliente!

Avertissement: Surface Chaude!

SPECIFICATIONS

SPECIFIC	DATA
MODEL	TL2-SAC25GZC(GR)
CUBAGE	25L
VOLTAGE	220~ 230 V
AC FREQUENCY	50 Hz
POWER	1500~1600 W

ATTRIBUTIONS

Apple App Store is a trademark of Apple Inc.

Google, Android and Google Play are trademarks of Google LLC.

Wi-Fi® is a registered trademark of Wi-Fi Allinace®.

Amazon, Alexa and all related logos and motion marks are trademarks of Amazon.com, Inc. or its affiliates.

iOS is a registered trademark of Cisco Systems, Inc. and/ or its affiliates in the United States and certain other countries.

The Bluetooth® word mark and logos are registered trademarks owned by Bluetooth SIG, Inc. and any use of such marks by Atovast Corporation is under license.

#DetailsMatter