

USER MANUAL

RICE COOKER
RC-18DRVTH(H)

TOSHIBA



CONTENTS

SAFETY INSTRUCTIONS	02
SPECIFICATIONS	10
PRODUCT OVERVIEW	11
PRODUCT INSTALLATION	12
OPERATION INSTRUCTIONS	14
CLEANING AND MAINTENANCE	22
TROUBLESHOOTING	24

SAFETY INSTRUCTIONS

Intended Use

The following safety guidelines are intended to prevent unforeseen risks or damage from unsafe or incorrect operation of the appliance. Please check the packaging and appliance on arrival to make sure everything is intact to ensure safe operation. If you find any damage, please contact the retailer or dealer. Please note modifications or alterations to the appliance are not allowed for your safety concern. Unintended use may cause hazards and loss of warranty claims.

Explanation of Symbols



Danger

This symbol indicates that there are dangers to the life and health of persons due to extremely flammable gas.



Warning of electrical voltage

This symbol indicates that there is a danger to life and health of persons due to voltage.



Warning

The signal word indicates a hazard with a medium level of risk which, if not avoided, may result in death or serious injury.



Caution

The signal word indicates a hazard with a low degree of risk which, if not avoided, may result in minor or moderate injury.



Attention

The signal word indicates important information (e.g. damage to property), but not danger.



Observe instructions

This symbol indicates that a service technician should only operate and maintain this appliance in accordance with the operating instructions.

Read these operating instructions carefully and attentively before using/commissioning the unit and keep them in the immediate vicinity of the installation site or unit for later use!

SAFETY CAUTIONS

- This is to explain the extent of injuries and damages that may occur if the instructions are not followed.

WARNING

- Probable causes of “severe injuries” or “death”.

CAUTION

- Probable causes of “bodily harm” or “property damages”.
- The explanation are divided into sections according to instruction details.



“PROHIBITION”
cases



“OBSERVATION”
cases



“CAUTION”
cases

WARNING

To prevent fires, burns, electric shocks, electricity leakage, short circuits

- Warning: Avoid spilling to the connector.
- Children should be supervised to ensure that they do not play with the appliance.
- The heating element surface is subject to residual heat after use, do not touch.

This appliance is not intended for use by persons (including children) with reduced physical, sensory or mental capabilities, or lack of experience and knowledge, unless they have been given supervision or instruction concerning use of the appliance by a person responsible for their safety.

This appliance is for household use only. Do not use outdoors.

- Don't place the appliance to the place close to heat-sensitive curtains.

- This appliance is intended to be used in house-hold and similar locations such as:
 - Staff kitchen areas in shops, office and other working environments;
 - farm houses;
 - by clients in hotels, motels and other residential type environments;
 - bed and breakfast type environments.
- If the supply cord is damaged, it must be replaced by a special cord or assembly available from the manufacturer or its service agent.
- Please turn off and unplug the appliance before cleaning, maintenance or relocation and whenever it is not in use.

Misuse may cause potential injury

- Stop using immediately if abnormalities/malfunctions are found. Unplug immediately and contact the Store from which the product was bought or Toshiba service center for examination and repair.
 - The power plug / cord is abnormally hot.
 - The cooker has a burnt smell.
 - The cooker is partly cracked, loosen, wobbling.
 - The inner pot, outer lid, or inner lid is broken or deformed.
 - The cooking heater becomes bent.
- Do not disassemble, repair, or modify the cooker by yourself. For any repair, please consult the Store from which the product was bought or Toshiba service center.
- Do not insert any foreign object into the air vent or blank gaps at bottom of the cooker. Especially metal articles e.g. pins, wire, etc.
- Do not immerse the cooker body and the power plug and cord in water or pour water over them.
Do not place them in a place exposed to water.
- Do not allow anyone unfamiliar with this cooker handling to use it by themselves. Do not use the cooker where children can reach, particularly keep your eyes on children during cooking or right after cooked.
- While cooking, do not open the inner lid or move/carry the rice cooker to other places.

Use the power plug / cord correctly.

- Use a separate socket of 220-240V. Using the cooker with other appliances will result in overheating leading to fire hazards. Do not connect the product to the power source which is not specified in the operation manual.
 - If an extension cord is necessary, use it separately.
 - Fully insert the plug into the socket.
 - Periodically remove dust from the power plug. Accumulation of dust, due to humidity, will cause insulation failure leading to fire hazards. Use dry cloth to wipe dust away.
 - Make sure there is no metallic articles or trash (e.g., pin, etc.) left at the pointed end of cooker-plug.
 - Do not allow children to flap the plug.
 - Hold the power plug head when pulling it out from the outlet. If not, it may catch fire, due to an electric shock, a short circuit, etc. Insert the power plug into the power outlet as far as the base of the power plug.
 - Always unplug when not in use. If not, due to insulation deterioration, it may cause an electric shock, electricity leakage, fire hazards, etc.
- ※ Illustration in the instruction manual might be different from the product you purchased.

To prevent fires, burns, electric shocks, electric leakage, short circuit, etc.

Use the power plug/cord correctly, (continued)

- Do not use damaged cords/power plugs, etc., or those with loose insertion.
- Do not let steam reach the power plug or other electrical appliances. Especially be careful when using any kitchen storage shelf.
- Do not use any power cords other than the cooker attachments and do not use the cooker attached cords for other appliances.
- Do not place the power plug or cord in the place with high temperature, flooded water, and high humidity or touch it with sharp-edge object.

- If power cord damaged, purchase specified replacement from the producer.
- Handle the power cords with care. Do not pull, tuck, twist, bend them with force in unnatural ways or turn on electricity while they are still coiled. Do not place heavy objects on their tops. Do not modify or deform them in any way.
- Do not insert or pull out the power plug or the cooker-plug with wet hands. Make sure your hands are dry before touching the power plug.
- Do not touch the product, cord, or power plug with wet hands. Do not operate the product if the cord or power plug is damaged, or the power plug is inserted improperly.

Use the power plug/cord correctly, (continued)

- The steam vent is hot. Keep your face or hands away from it. Be careful, especially with babies and infants.
- Make sure to install the steam vent.
- Do not use the cooker for any purposes other than those indicated in the instruction manual.
Because it may cause food or steam contained inside spill or burst out, resulting in burn wounds/injuries.
«Examples of inappropriate cooking ways »
- Putting materials that may block the steam vent, for example, cooking sheets, aluminum foil, lye-removing sheets, food wraps, or thin-layer ingredients such as greens, tomatoes, beans, etc.
- Cooking the food that's easy to spill out e.g., jams, beans, etc.
- Putting ingredients in plastic bags and heating in the cooker.

CAUTION

To prevent electricity leakage, electric shocks, bodily harm, burn wounds, fire hazards, and property damages.

To prevent boiling over or spilling out

- Congee is to be cooked with lots of water, so we don't use "White Rice" or "Quick Cook" menu.
Please cook rice porridge by "Congee" menu.
- Do not add water too much more than the indicated water level scale.
The standard is within 2 mm against the indicated water level scale.

To prevent burn wounds / injuries.

- While using or after using, do not touch hot parts including the inner lid, the cooking heater, the inner pot, the steam vent, the heat sink, etc.
- When not in use, do not press the "START" key or "KEEP WARM/REHEAT" key.
Because the cooking heater, the inner pot, the outer pot, the inner lid will be at high temperature.
- While moving the cooker, do not touch the hook button.
- Do not shake the cooker while holding the handle.
- While cooking, do not set up the handles.
- Do not turn on the cooker, when the pot is empty.
Because it may cause overheating, breakdowns, and malfunctions.
- To maintain or repair, do it after unplugging and the cooker has cooled down.
There may be hot water still gathering in the steam vent.
- After cooking, beware of steam or hot water dripping from the inner lid, while opening it.
- Before take out the inner pot, press the "KEEP WARM/REHEAT" key.
Although the inner pot is taken out during cooking or warming, the power will not be automatically cut off.
- Please use a dry dishcloth, mittens, etc. to take out the hot inner pot.

To prevent electricity leakage, electric shocks, bodily harm, burn wounds, fire hazards, and property damages.

Do not use the cooker in the following places

- A place where near the naked flame, wet area, or hot and high humidity area.
Also beware for the accessories and attachments.
- An uneven/unstable place or on heat-sensitive carpets, mats, etc. They may cause burn wounds, fire hazards.
- On materials that may block the air vent, for example paper, cloth, carpet, etc.
- A place where the lid cannot be fully opened. It may cause burn injuries and damages.
- The high electromagnetic area.
- A place close to walls, furniture, etc.

When putting the cooker on a kitchen storage shelf, be careful not to let steam be confined.

For safe use

- Do not use any other things instead of the inner pot which is specifically designed for the cooker.
- Do not bring any flammable object, hazardous object, chemicals, or flammable gas near or in the product.
- Read the instruction manual carefully and thoroughly before using the product.
- Always inspect that the product is in a good operating condition before using by following the recommendation in the instruction manual.
- Remove all packing materials.

PLEASE OBSERVE AND FOLLOW

- Do not use the cooker in the following places.
- They may cause malfunctions, deformation, discoloration, etc.
 - A place which is exposed to direct sunlight
 - A place where oil, etc., splashes
- Do not put any dishcloth on the lid, especially on the steam vent.
- Steam may be confined, resulting in malfunctions, deformation, discoloration, etc. of the lid, the steam vent, and operation parts.
- Keep the cooker and surroundings clean and ready to use. Dust, bugs, etc. entering inside of function-maintaining parts (such as the air vent, etc.,) may cause malfunctions of the cooker.
- Wipe away water droplets or any foreign substances.
- If using while foreign substances are left, stuck to the cooking heater, the temperature sensor, the outer part of inner pot, the packing of inner lid, etc., rice will not be well cooked, resulting in malfunctions.
- Do not use the inner pot with a gas range, IH cooking appliances, microwave ovens, etc. It may cause deformation, discoloration, malfunctions, etc.
- Stop using if the cooker becomes loose, cracked, or falls down.
- Please contact the store from which the product was bought or Toshiba service center for examination and repair.

Do not use the cooker in the following ways to prevent coating inside the inner pot from getting scratched and getting unstuck

- Do not put dishes in the inner pot and use it as a washing-up bowl.
- Do not use a scrubbing brush or dish washer to wash the inner pot.
- Do not use any cleanser, bleaching agent to wash the inner pot. (use neutral detergent for kitchen use.)
- Rice seasoned and cooked with various ingredients cannot be kept warm. (Please wash right after using seasonings.)
- Do not use vinegar.
- Do not scrub with a scoop or strike with a sieve.
- Do not use a metal ladle or a whisk.

SPECIFICATIONS

Model Name	RC-18DRVTH(H)
Capacity	1.8L
Power Consumption (Cooking)	830-1024W
Power Supply	220-240V~
Frequency	50/60Hz

PRODUCT OVERVIEW

Product Features

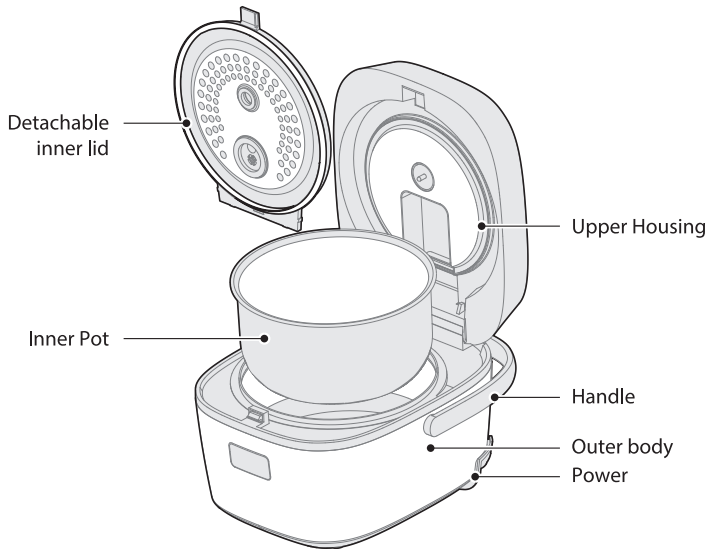

Accessories



Standable rice spoon



Suspensible spoon



Measurement cup



Steamer

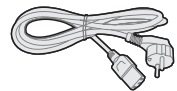

Power cord

NOTE

All the pictures in this manual are for explanation purpose only. Any discrepancy between the real object and the illustration in the drawing shall be subject to the real subject. Remove parts from the component before performing installation.

PRODUCT INSTALLATION

Unpacking

Remove all packing materials.

Wash the cooking pot, inner lid, steam port and other accessories, and then dry thoroughly before using.

Electrical Requirements

WARNING

Electrical Shock Hazard

- Plug into a grounded 3 prong outlet.
- Do not remove the ground prong.
- Do not use an adapter.
- Do not use an extension cord.

Failure to do so can result in death, fire or electrical shock.

AC 220-240V, grounded electrical supply is required. It is recommended that a separate circuit serving only the rice cooker is used. Sharing the power supply with other appliances will result in overheating.

Power Supply Cord

NOTE

This Rice Cooker has a 3-prong grounded plug. To reduce the risk of electrical shock, the plug will fit into an outlet only one way. If the plug does not fit in the outlet, contact a qualified electrician. Do not modify the plug.

A short power supply cord is used to reduce the risks of becoming entangled in, or tripping over a longer cord, or of the cord being grabbed by children.

If the power supply cord is too short, have a qualified electrician or technician install an outlet near the appliance. Do NOT use an extension cord.

Location Requirements

This rice cooker is designed for household use only; the cooker should not be used for commercial use.

Use indoors on a stable, level, non-heat sensitive surface such as a countertop in a location where the lid can be fully opened; do NOT use outdoors.

Do not place the rice cooker on an area of the countertop that is exposed to direct sunlight, or where it might be splashed with cooking oil.

Power Supply Cord

Steam and heat emitted from the rice cooker may damage or discolor nearby walls or cabinets. It is recommended that the rice cooker be placed a minimum distance of 12" (30.5 cm) from walls or cabinets.

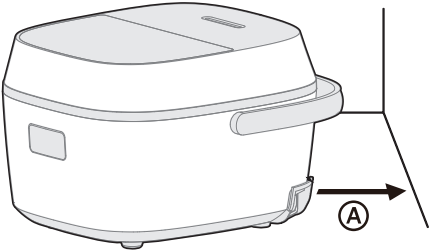

Ⓐ At least 12" (30.5 cm)

OPERATION INSTRUCTIONS

Operation Panel

⚠ WARNING

Fire/Burn Hazard

Unplug immediately and do not use rice cooker if:

- The power supply cord becomes abnormally hot during use.
- Smoke is emitted from the rice cooker or a burning odor is detected.
- The rice cooker is cracked or there are loose or rattling parts.
- The cooking pot, outer lid or inner lid is broken or deformed.

Failure to do so may result in fire, electric shock or injury.

Controls

🚫 IMPORTANT

To select a cooking program, the rice cooker must first be plugged into a grounded 3 prong electrical outlet (ON).

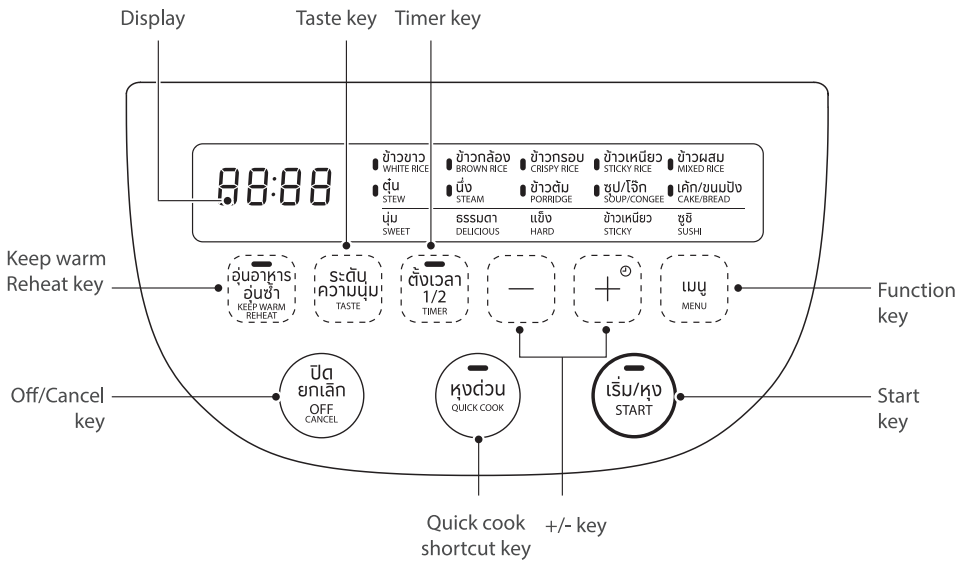

Function	Operation guide
START	In standby mode, press the [START] key to start the current working state, and the product starts to work.
Keep warm/ Reheat	Press the [Keep Warm/Reheat] key to enter the keep warm state, press it again to enter the "Reheat" state, the key light flashes, and the 25-minute rice reheating function is activated. To switch or cancel the current function, press the [Off/Cancel] key to reselect.
Off/Cancel	In any state, press the [Off/Cancel] key to cancel the current working state and return to standby state.
Taste	Before starting the program, you can press the [Taste] key to change the taste of the food, such as "SWEET", "DELICIOUS", "HARD", "STICKY", and "SUSHI". Note: Only the "White Rice" function can change the taste of food.
White Rice Brown Rice Crispy Rice Sticky Rice Mixed Rice Stew Steam Porridge Soup/Congee Cake/Bread	Press the [MENU] key to select the relevant function. The screen displays the preset cooking time. Press the [START] key to enter the cooking state. To switch or cancel the current function, press the [Off/Cancel] key to reselect. After completion, it enters the keep warm state.
Delay time	Cooking delay: Press the [Timer] button, press once, Timer 1 will display, press twice, Timer 2 will display, press [Timer] button again, "Timer 1" and "Timer 2" will flash on the screen in circle. Press the [+] [-] keys to adjust the delay time. After adjustment, the set time will be automatically memorized. Then press the [MENU] key to select the cooking function. Press the [START] key, and the product starts counting down the delay time. When the countdown ends, cooking is complete. Note: The delay time range is 0:00-23:50. Delay cannot be set for Cake/Bread, Keep warm/Reheat functions.

How to Open/Close Upper Cover

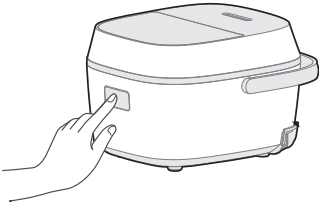

Open the upper cover

- Do not press the upper cover from above. You only need to press the button and open the upper cover when there is a "click" sound.

Press the front center



Close the top cover

- To prevent forgetting to install the movable cover, the upper cover cannot be closed if the movable cover is not installed.
- Before closing the upper cover, please confirm that there is no foreign matter where the lock is fixed.
- Press until it clicks.

How to Cook Rice

1 Use the measuring cup provided with the product to measure the rice.



1 cup of rice can cook about 2 bowls of rice (the diameter of the bowl rim is about 11.5cm)



Correct
Rice should be level
with the rim of the cup

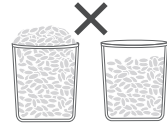

Higher or lower than the rim
will make it unable to
accurately control the water
level

Note: A rice cooker of 1.0L capacity can cook up to 5.5 cups of rice, a 1.5L cooker cooks up to 8 cups of rice, and a 1.8L cooker cooks up to 10 cups of rice, it may cause overflow or undercooked rice;

2. The size of a regular household bowl is 11.5cm.

2 Wash the rice

Wash the rice 2 or 3 times for a better taste

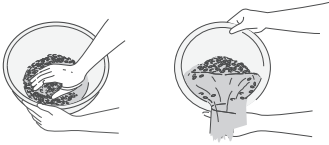

3 Select water level

Adjust the amount of water according to the number of cups (you can increase or decrease the amount of water within about 1mm above or below the scale.)

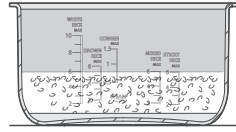

4 Wipe off the water droplets and foreign matter attached to the outside of the inner pot, install the inner pot, and close the upper cover

If there are foreign objects or water droplets attached, the rice will not be cooked smoothly, resulting in problems such as the lid not closing and steam leakage.



Wipe off the moisture on the outside of the inner pot



Press until there is a "click" sound

5 Select the function and start cooking

Press [START]



Working Hours

Cooking capacity and cooking time estimation

Select "cooking mode" and "water level" according to the type of rice to be cooked.

Function	Taste	Cooking capacity Unit: cup	Approx. Cooking time Unit: min (Default cooking time)
White Rice	SWEET	2~10	55-70(60)
	DELICIOUS		35-55(50)
	HARD		35-50(40)
	STICKY		40-60(60)
	SUSHI		35-55(50)
Brown Rice	/	2~6	60-90(70)
Crispy Rice		2~6	50-60(60)
Sticky Rice		2~6	45-80(60)
Mixed Rice		2~6	60-90(70)
Stew		/	120(120)
Steam		/	Setting time +15 (30)
Porridge		0.5~1.5	Setting time (90)
Soup/Congee		0.5~1.5	Setting time (120)
Cake/Bread		/	50(50)
Quick Rice		2~10	30-50(30)
Reheat		/	25-30(25)

- The minimum and maximum water levels on the inner pot water level are different from the amount of rice that can be cooked.
- The actual cooking time will vary by about 10 minutes depending on the amount of rice, water temperature, water volume, etc. Please treat cooking times as estimates. (The cooking conditions are that the AC voltage is 220-240V, the room temperature and water temperature are 23°C, with standard water volume)
- If you want to cook thinner congee, please reduce the amount of rice or increase the amount of water. But do not add water beyond the maximum mark for cooking congee.
- The cooking capacity are vary for different modes, please refer to the water line of the inner pot when cook.

Cooking Steps

- 1** Press [MENU] to select the corresponding function
The display will change in the following sequence
<White Rice><Brown Rice> <Crisy Rice><Sticky Rice>
<Mixed Rice> <Stew><Steam><Porridge>
<Soup/Congee><Cake/Bread>

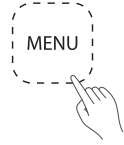

- 2** Under the [White Rice] menu, press [TASTE] to
select <SWEET><DELICIOUS><HARD>
<STICKY><SUSHI>



- 3** Press [START] to enter the cooking state

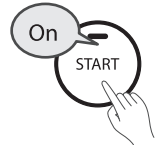

Cooking Delay

Preparation

Confirm whether it matches the current Beijing time

Wash the rice, add or reduce water, put the inner pot into the body, and close the top cover

- If it does not match the current time, cooking cannot be completed at the scheduled time.

Press the "Timer" key and select "Timer 1" or "Timer 2"

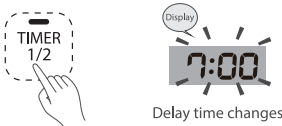

- Each time you press the Timer key, the display will switch between "Timer 1" and "Timer 2"

Operation

Press "+ -" to set the cooking completion time

Clock displays in 24-hour mode
7:00 AM 7:00
6:00 PM 18:00

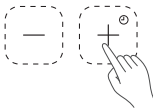

[Example of finishing cooking at 7:00a.m.]

- Set in units of 10 minutes; hold + or - key to quickly adjust the time.
- ※ It is best to set the delay time outside 2 hours, or some menus may start cooking directly.

The rice cooker will memorize the preset time, so you can skip the operation next time you want to cook rice at the same preset time.

Confirm cooking mode

- Select the type of rice you want to cook and set the cooking mode.



- When cooking congee, be sure to set the rice cooking function to <CONGEE>. If you use other cooking modes, it may cause overflow and burns.

Cooking will be completed when the scheduled time is reached

- Press [START] to complete the delay setting



A prompt sound will emit after pressing [START]

To cancel a delay
In case of an
operation error



Notes for Delay Cooking

- If the cooked rice is soft, please reduce the amount of water according to your preference.
- During delay cooking, the starch in the rice will settle, so the rice at the bottom may have a light brown color. This phenomenon can be reduced by washing the rice thoroughly.
- When the room temperature and water temperature are low or when there is a large amount of water, the cooking completion time may be delayed by about 10 minutes.
- The cooking can be delayed for 24 hours. Please adjust the delay time according to the type of food. Generally, it is not recommended to delay for more than 14 hours (not more than 8 hours in summer)

“O” indicates that cooking can be delayed

(it may cause the rice to deteriorate, rot or corrode the inner pot)

White Rice					Brown Rice	Crispy Rice	Sticky Rice
Sweet	Delicious	Hard	Sticky	Sushi			
O	O	O	O	O	O	O	O
Mixed Rice	Stew	Steam	Porridge	Soup/Congee	Cake/Bread		
O	O	O	O	O	X		

Keep Warm/Reheat

- Automatically enters the keep-warm state after cooking.
- In standby mode, press the “Keep Warm/Reheat” key to enter the Keep Warm mode, the Keep Warm time is displayed, and the Keep Warm light is on.
- ※ The product can keep warm for 24 hours, but it is recommended not to exceed 8 hours.

How to Adjust Current Time (Clock)

- Plug in the power plug, press and hold the “+” key and the time will flash.
- Press “+/-” to adjust the time.
- Press “START” or wait 10 seconds for successful adjustment, or press the CANCEL key to exit the setting.
- ※ The clock cannot be adjusted during cooking, keeping warm, and delaying.

CLEANING AND MAINTENANCE



Tips

1. Please wipe off the water on the housing cover with a cloth.
2. The water, rice, debris, etc. on the inner pot and coil tray need to be cleaned away.
3. You can perform simple cleaning according to the following steps when using it for the first time, and perform regular cleaning subsequently according to the usage.

Removing Movable Cover

Grasp the edge of the cover with your left hand, and push the inner cover slider in the direction of the arrow with your right hand; pull forward with your left hand to take out the movable cover.

In order to prevent you from cooking without the movable cover, the upper cover cannot be closed when the movable cover is removed.

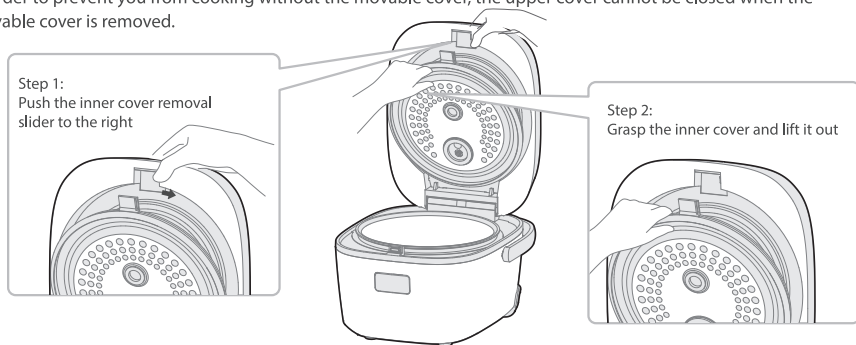

Note: In order to prevent you from cooking without the movable cover, the upper cover cannot be closed when the movable cover is removed.

Disassembly/Assembly of Steam Valve Cover

- 1** Grasp the movable cover and open the lock

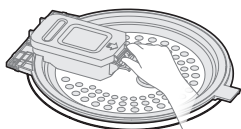

- 2** Insert the buckle of the steam valve seat into the small hole of the steam valve cover and fasten the lock.

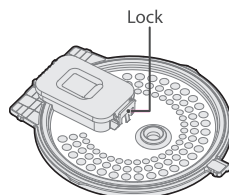
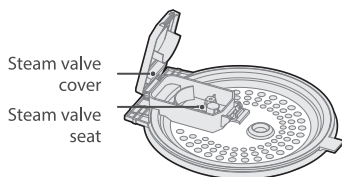

Note: When the steam port sealing ring on the inside of the steam valve cover comes out, press it in so that it does not protrude from the slot.

Cleaning Pot/Inner Pot/Steamer

1 Wipe with a clean soft cloth



Note: After the inside of the pot is cleaned, be sure to wipe dry the water to avoid using when there is water inside.

2 Soak in clean water for 10 minutes to allow the remaining rice to fully absorb water and then rinse



Note: Do not wash the inner pot with a wire ball to avoid scratching the inner pot coating

3 Wipe dry inner pot and steamer after cleaning.



TROUBLESHOOTING

How to deal with cooking failure

Please check before applying for repair. If the reason cannot be found out after investigation, please consult with the store where you buy the electric cooker.

This time		Investigate the reasons (reference page)
Rice	Soft In pasty state Agglomerated Not tasty	<ul style="list-style-type: none"> ● Please reduce water volume for cooking. ● Please scarify the rice completely and promptly after the cooking is done. ● Please reduce water volume for cooking in the case of using new rice. ● Soaking rice or making appointment for cooking before cooking will make the cooked rice soft. ● Roughly rubbing the rice during washing or drying out with shallow basket will rip o-rice and make the rice in pasty state. ● Whether hot water or alkaline ionized water of pH value above 9 is used?
	Hard Loose Not tasty	<ul style="list-style-type: none"> ● Please increase water volume for cooking. ● Please soak the rice in advance before cooking. ● Whether the higher hardness of mineral water is used?
	Burnt ※ Slight burnt of fawn is not faulty.	<p>It can easily get burnt in the following conditions.</p> <ul style="list-style-type: none"> ● Inadequate rice washing. ● Long soaking time. Cooking appointment. ● Cooking washing-free rice. Cleaning for 1-2 times can relieve the coking situation. ● Cook milled rice with embryo or soup rice, and adding seasoning. ● Where there is dirt or foreign matters on temperature sensor or temperature sensor on upper housing.
	Badly cooked Not tasty	<ul style="list-style-type: none"> ● Whether cooking is operated when the inner cooking pot/slot or detachable inner lid is not cooled down? Please cool down them before cooking. ● Rice cooked under the <QUICK COOK> mode will be softer or harder. ● Whether the detachable inner lid is blocked with foreign matters, and whether there is foreign matter attached to temperature sensor of upper housing, main temperature controller, sealing ring, edge of inner cooking pot and suction port/exhaust port? ● Whether inner cooking pot or detachable inner lid is deformed? Whether the inner lid or steam valve is uninstalled? ● Whether the power is cut of during cooking?
Rice in heat preservation	With unpleasant Odor ※ If any unpleasant odor, please be sure to clean by boiling, and use after cleaning and maintenance. (Page 23)	<ul style="list-style-type: none"> ● Whether the following heat preservation is done? Long-time heat preservation, heat preservation of cold rice, heat preservation with serving spatula in pot and repeated long-time heat preservation. ● Heat preservation is suitable for coarse food grain rice, polished rice and germinant brown rice. However, compared with white rice, their scent or color can be easily changed. It is recommended to use up quickly or store in refrigerator. ● Whether there is dirt on detachable inner lid, steam valve and body? Especially for the detachable inner lid and steam valve, please take of to clean after cooking every time, and wipe of water. ● Whether rice is not fully washed or long-time appointed cooking is selected? ● Whether the rice is still left in pot after cutting of the heat preservation? Take out the inner cooking pot and place it back during heat preservation, and press CANCEL button, and cut of power supply due to long-time power outage.
	Half-cold rice	<ul style="list-style-type: none"> ● Please reheat before eating.
	Pasty	<ul style="list-style-type: none"> ● Please reduce water volume for cooking and then heat preservation. ● Please scarify the rice completely and promptly after the cooking is done. ● Please place rice together to prevent rice grains from being left on side of inner cooking pot, and frequently stir the rice.
	Drying and discoloration	<ul style="list-style-type: none"> ● Whether there are foreign matters attached on sealing ring, edge of inner cooking pot and outer casing cover? ● Whether there are foreign matters attached on outside of inner cooking pot and the main temperature controller? ● Whether steam valve has been indeed installed well? ● Whether long-time heat preservation or reheating is repeated?

Please perform an inspection before applying for repair.

This time		Investigate the reasons (reference page)
Switch on upper housing	Difficult to close Impossible to close	<ul style="list-style-type: none"> ● Whether the detachable inner lid has been installed well? If the detachable inner lid not installed, the upper housing cannot be closed to prevent forgetting the installation of the detachable inner lid. ● Whether the plug-in part under the detachable inner lid is plugged in? ● Whether there are foreign matters attached on opening buckle plate? ● Whether the detachable inner lid plate is blocked with foreign matters?
	Open upper housing during cooking	<ul style="list-style-type: none"> ● Please press the central part on the front side of upper housing until a sound of "clatter". ● Whether there are foreign matters attached on opening buckle plate?
Preset	Promptly start Cooking Fail to cook at the appointed time Fail to make appointment	<ul style="list-style-type: none"> ● Cooking will promptly start for appointment within 1-2 hours. ● Whether the a.m. and p.m. are confused? The clock is of 24-hour display mode. ● Whether the current time is wrong? ● Whether lithium batteries are run down? ● If the room temperature and water temperature are lower or water volume is larger, cooking inishing time may be delayed for about 10 minutes. ● Whether inner cooking pot is installed before presetting appointment time? ● Whether the appointment is not set or the COOK button is not pressed?
Cooking and heat preservation	Steam leakage ※ Please confirm after inishing cooking.	<ul style="list-style-type: none"> ● Whether there are foreign matters attached on sealing ring, edge of inner cooking pot and outer casing cover? ● Whether there are foreign matters attached on upper housing and opening buckle plate? ● Whether the sealing ring is damaged and whether inner lid or inner cooking pot is deformed? ● Whether the detachable inner lid is installed?
	There are water drops nearby exhaust nozzle of steam valve	<ul style="list-style-type: none"> ● Steam will be converted to water drops attached after cooling. Not failure.
	Water drops on detachable inner lid and inner cooking pot	<ul style="list-style-type: none"> ● To prevent rice from getting dry, there may be water drops attached to the detachable inner lid and inner cooking pot, and this is not a failure.
	Condensed water dropped from sealing ring and other parts after opening upper housing	<ul style="list-style-type: none"> ● Sometimes, condensed water will drop on outer casing cover and other parts based on the time, room temperature and other conditions when the upper housing is opened. Please wipe them of. ● Condensed water will low into inner cooking pot (rice), rather than into frame when the cover is not completely opened or is slightly opened with hands. ● In case of cutting of heat preservation or pulling out power plug with rice in, detachable inner lid will cause condensation and there will be much condensed water attached. ● Whether there are foreign matters attached on the main temperature controller and outside inner cooking pot?
	Spilling	<ul style="list-style-type: none"> ● Whether there is very little rice or very much water, or rice is washed inadequately? ● Is the congee cooking mode right? ● Whether there are foreign matters attached on temperature sensor on the upper housing and main temperature controller? ● Whether there is dirt inside steam valve? ● Whether steam valve and detachable inner lid is installed well? ● Whether the detachable inner lid is blocked with foreign matters?
	Thin film generated inside inner cooking pot	<ul style="list-style-type: none"> ● Sticky rice paper-shaped thin film is the dried dissolved sugar (starchiness) in rice, which is not a fault.
Display Button	Fail to press button for operation	<ul style="list-style-type: none"> ● Whether the power plug is plugged in? Whether the inner cooking pot is well placed?
	The light goes out It stops halfway	<ul style="list-style-type: none"> ● Pressing CANCEL button by mistake or long-time power outage will cut of the power.
Others	Displayed residual time is diferent from the actual cooking time	<ul style="list-style-type: none"> ● Sometimes, there may be diference with the actual cooking time, which is not a fault. Please refer to the "About display of cooking time" for details.
	With scent of plastic and others	<ul style="list-style-type: none"> ● When starting to use, there may be an odor, which will gradually disappear with the use. Eliminate the unpleasant odor by ventilating and cleaning by boiling.
	Some parts on plastic spare parts are presented in linear or wave shape	<ul style="list-style-type: none"> ● It is track of plastic, which is not a fault. It does not influence cooking or heat preservation.
	There is a gap between upper housing and body	<ul style="list-style-type: none"> ● There will be gap more or less between upper housing and body, but the machine is closed with the sealing ring.
	There is the scratch or dirt on coating outside the inner cooking pot	<ul style="list-style-type: none"> ● As the using time increases, there will be scratch or dirt on coating on the outer side of the inner cooking pot, which, however, will not influence cooking and heat preservation, and the pot can be normally used.
	Tripping of circuit breaker during cookin	<ul style="list-style-type: none"> ● In the case of being used together with other electric products, sometimes it may exceed the rated current of the circuit breaker. Please use a separate power socket.

Warm check

 Warm check	Check electric cookers which have been used frequently in many years!	Please use under regularly confirming of "Important Safety Instructions" and "Notes". Wrong using method and long-time use will deteriorate spare parts due to influence from heat, moist, dust and others, with the possible hidden danger and fault.	
	Whether there is such symptom? Please clean up dust on power plug or power socket.	<ul style="list-style-type: none"> ● Abnormal heating of power plug or power cord. ● The body gives off scorched flavor. ● Part of the body is broken, wry or squeaking. ● Deformation or damage of inner cooking pot, outer cover and inner cover. ● There are other abnormalities or faults. 	Please stop using

When there is the power outage

- Continue the cooking or keep warm after electrifying.

However, there may appear poor cooking, power supply cut-off, delay of appointed finishing time and other conditions.

※ It is the same as the condition when the power plug is pulled out halfway or circuit breaker trips.

Error Code and Troubleshooting

Please unplug the power plug (power side) from the socket and handle it as follows.

Indicator status	Display	Possible reason	Approach
Always on	E1	Bottom sensor open circuit	If the fault persists after unplugging the power plug and turning it on again, please send it to local after-sales service for repair
	E2	Bottom sensor short circuit	
	E3	IGBT sensor open circuit	
	E4	IGBT sensor short circuit	
	E5	Upper lid sensor open circuit	
	E6	Upper lid sensor short circuit	
	EU	Communication reception failure	
Flashing	EU	Communication sending failure	
Always on	[2	IGBT overheating protection	Check whether the air inlet and outlet are blocked and whether the fan rotates smoothly. If the problem persists after powering on again, send it to after-sales service for repair
Always on	[4	No pot protection	Check to ensure that the inner pot is placed in and then power on again. If the fault still occurs, send it to after-sales service for repair

Troubleshooting

When you think the product is faulty, please check the following conditions for confirmation before sending it to a service center for repair.

Fault	Possible reasons	Solutions
Too soft, too hard, too thick, too thin, undercooked, burnt rice, soup overflowing, insufficient boiling	Failure to add water according to the water level	Add water according to water level
	Function selection error	Select the corresponding function
	Foreign matters on the electric hot plate	Remove foreign matters from the electric hot plate and start cooking again
	Inner pot deformed	Contact after-sales service to replace the inner pot
Odor, discoloration, and dryness when kept warm	Foreign matters mixed between the sealing ring and the edge of the inner pot	Remove foreign matters
	Product leaks	Contact after-sales service to replace the sealing ring
	Keep warm for too long	It is recommended to keep warm within 5 hours
Abnormal noises during work	Water on the inner pot not wiped dry	Wipe the water on the inner pot before use
	Sound of relay switching on and off during operation	The sound from the relay is a normal phenomenon of the electrical appliance



According to Waste of Electrical and Electronic Equipment (WEEE) directive. WEEE should be separately collected and treated. It at any time in future you need to dispose of this product please do NOT dispose of this product with household waste. Please send this product to WEEE collecting points where available.

#DetailsMatter

Contact Information
TOSHIBA CONTACT CENTER 0-2511-7777
www.toshiba-lifestyle.com/th

