

TOSHIBA

TOSHIBA REFRIGERATOR USER MANUAL (FOR HOUSEHOLD USE ONLY)

MODEL

GR-D706CP / GR-D706 / GR-D706X / GR-D706XK

GR-D906 / GR-D906K

GR-D145 / GR-D175

GR-D147 / GR-D187

GR-D149 / GR-D189

GR-C149F / GR-C189F

GR-W149 / GR-W189

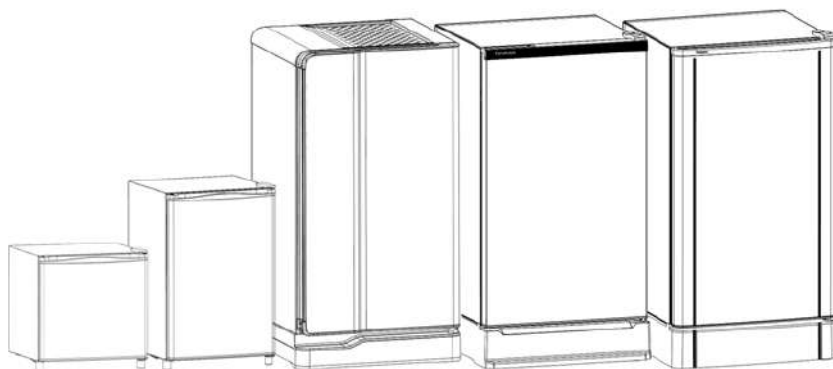

THANK YOU VERY MUCH FOR CHOOSING TOSHIBA REFRIGERATOR.

PLEASE READ THIS INSTRUCTION FOR THE CORRECT AND EFFECTIVE USE OF YOUR REFRIGERATOR.

KEEP THIS OWNER'S MANUAL IN A HANDY PLACE FOR FUTURE REFERENCE.

MAKE SURE THAT YOU RECEIVED YOUR WARRANTY.

TOSHIBA REFRIGERATOR USES R600A REFRIGERANT (NON-CFC) AND CYCLOPENTANE INSULATION.

IMPORTANT SAFETY INFORMATION

SAFETY WARNINGS

 INDICATES THE FORBIDDEN OPERATION.

 INDICATES THE INFORMATION WHICH SHOULD BE FOLLOWED STRICTLY.

INSTALLATION SAFETY CAUTION

- DO NOT PLACE FLAMMABLE MATERIALS, DANGEROUS MATERIALS, CHEMICALS OR FLAMMABLE GASES NEAR OR IN THE REFRIGERATOR.
- DO NOT INSTALL THE REFRIGERATOR NEAR OPEN FLAMES, WET PLACES, HIGH HEAT OR HUMIDITY AND DO NOT INSTALL THE REFRIGERATOR WHERE CHILDREN CAN REACH IT.
- DO NOT INSTALL THE REFRIGERATOR IN AREAS WITH HIGH ELECTROMAGNETIC AND DO NOT PLACE THE REFRIGERATOR ON THE SLANT OR INSECURE FLOOR.

SAFETY CAUTION

- DO NOT DISASSEMBLE, REPAIR, MODIFY OR ALTER THE REFRIGERATOR. (UNLESS INDICATED IN THE OPERATION MANUAL)
- DO NOT PULL OR INSERT THE POWER PLUG AND MAGNETIC PLUG WHILE YOUR BODY IS WET AND DO NOT ALLOW THE APPLIANCE TO GET WET OR COME INTO CONTACT WITH WATER.
- DO NOT TOUCH THE APPLIANCE, POWER CORD, OR POWER PLUG WHILE YOUR BODY IS WET.
- DO NOT PULL THE POWER PLUG OUT OF THE SOCKET WHILE THE APPLIANCE IS OPERATING.
- DO NOT USE THE APPLIANCE IF THE POWER CORD OR POWER PLUG IS DAMAGED OR THE POWER PLUG IS NOT INSERTED IMPROPERLY.
- DO NOT MODIFY, REPAIR OR CHANGE THE ELECTRICAL WIRES, PLUGS OR USE ANY OTHER ELECTRICAL WIRES WHICH ARE NOT INCLUDED WITH THE PRODUCT (EXCEPT THE GROUND WIRE).
- DO NOT BEND, BREAK, TWIST, OR PULL THE POWER CORD WHILE THE REFRIGERATOR IS OPERATING.
- DO NOT PLACE THE REFRIGERATOR OR OBJECTS ON THE POWER CORD AND DO NOT PINCH THE POWER PLUG OR THE POWER CORD.
- DO NOT PLACE THE POWER PLUG OR POWER CORD IN THE PLACE WITH HIGH TEMPERATURE, FLOODED WATER AND HIGH HUMIDITY OR TOUCH IT WITH SHARP-EDGE OBJECT.
- DO NOT USE WITH A POWER SUPPLY OTHER THAN THAT SPECIFIED IN THE USER MANUAL.
- DO NOT USE ANY EXTENSION CORD TO CONVERT THE PLUG TO THE OUTLET.
- DO NOT INSERT THE PLUG OF THE APPLIANCE INTO THE OUTLET WITH OTHER ELECTRICAL APPLIANCES.
- DO NOT USE THE APPLIANCE FOR OTHER PURPOSES OTHER THAN THOSE SPECIFIED IN THE USER MANUAL.
- DO NOT ALLOW CHILDREN TO USE THE APPLIANCE ALONE. CHILDREN SHOULD BE SUPERVISED TO ENSURE THAT THEY SHALL NOT PLAY WITH THE APPLIANCES.
- DO NOT PLACE OBJECTS ON THE APPLIANCE AND DO NOT COVER THE APPLIANCE WHILE IT IS OPERATE. (EXCEPT AS SPECIFIED IN THE UDER MANUAL).
- DO NOT TOUCH EXTREMELY HOT OR COLD PARTS OF THE APPLIANCE.
- THERE MUST BE GOOD VENTILATION IN THE AREA WHERE THE REFRIGERATOR IS INSTALLED AND THE SURROUNDING WALLS AND FREE FROM OBSTRUCTIONS.
- DO NOT USE ANY TOOLS OR DEVICES TO ACCELERATE THE DEFROSTING OF ICE OTHER THAN THOSE SPECIFIED BY THE MANUFACTURER.
- DO NOT DAMAGE THE COOLING SYSTEM, SUCH AS USING A SHARP OBJECT TO SCRAPE THE FREEZER COMPARTMENT OR CAUSING REFRIGERANT TO LEAK.
- DO NOT USE OTHER ELECTRICAL APPLIANCES THAT ARE NOT RECOMMENDED BY THE MANUFACTURER IN THE FOOD STORAGE COMPARTMENT.

INSTALLATION SAFETY CAUTION

- CONNECT THE GROUND WIRE AT THE SPECIFIED POSITION ON THE PRODUCT.

SAFETY CAUTION

- READ THE OPERATION MANUAL CAREFULLY BEFORE USING THE PRODUCT AND REMOVE ALL PACKING MATERIALS.
- CHECK THAT THE APPLIANCE IS IN GOOD CONDITION BEFORE USE AND IN ACCORDANCE WITH THE INSTRUCTIONS.
- THIS ELECTRICAL APPLIANCE IS NOT INTENDED FOR USE BY PERSONS (INCLUDING CHILDREN) WITH REDUCED PHYSICAL, SENSORY OR MENTAL CAPABILITIES OR LACK OF EXPERIENCE AND KNOWLEDGE, UNLESS THEY HAVE BEEN GIVEN SUPERVISION OR INSTRUCTION CONCERNING USE OF THE APPLIANCE BY A PERSON RESPONSIBLE FOR THEIR SAFETY.

- INSERT THE ELECTRIC PLUG INTO THE POWER OUTLET AS FAR AS THE BASE OF THE ELECTRIC PLUG. TO UNPLUG, HOLD THE BODY OF THE ELECTRIC PLUG AND PULL IT OFF.

- WIPE DUST OR MOISTURE AT THE ELECTRIC PLUG'S PINS THOROUGHLY BEFORE INSERTING IT INTO THE POWER OUTLET.

- PULL THE ELECTRIC PLUG OUT OF THE POWER OUTLET WHEN THE PRODUCT IS NOT IN USE.

- PULL THE ELECTRIC PLUG OUT OF THE POWER OUTLET BEFORE MAINTAINING OR CLEANING THE PRODUCT.

SPECIFIC WARNINGS

USE WITH A POWER SUPPLY OF 220V- 240V, FREQUENCY 50HZ.

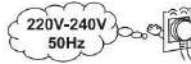

WHEN NOT USING THE LONG TIME, TAKE OUT THE POWER PLUG AND CLEAN THE INSIDE, LEAVE THE DOOR OPEN TO DRY THE INSIDE OF THE REFRIGERATOR COMPLETELY.

DO NOT USE HOT WATER OR SHARP-END TOOLS TO GET RID OF ICE COVERING THE EVAPORATOR. AS THIS WILL DAMAGE TO COOLING SYSTEM AND COMPRESSOR. WE WOULD NOT BE RESPONSIBLE FOR THE CLAIMS, IF THIS KIND OF INCIDENT OCCUR.

DO NOT PLACE ANY OBJECTS WEIGHING MORE THAN 20 KILOGRAMS OR CONTAINERS CONTAINING WATER ON THE TOP OF REFRIGERATOR AS THE WATER MAY SPILLED ON ELECTRICAL PARTS AND MAY CAUSE AN ELECTRIC SHORT CIRCUIT OR LEAKAGE.



DO NOT USE OIL OR DETERGENT TO CLEAN THE REFRIGERATOR BECAUSE IT WILL CAUSE A STAINS.



DO NOT PLACE ANY OBJECTS HOT TEMPERATURE MORE THAN 60°C ON THE TOP OF REFRIGERATOR, AS THIS WILL CAUSE HEAT WHICH MAY BE SOME PARTS ARE DEFORMED.

WHEN GAS LEAKAGE, DO NOT PULL OFF THE MAIN PLUG OR ADJUST THE TEMPERATURE CONTROL TO PREVENT ELECTRICAL SPARKS THAT CAN CAUSE EXPLOSIONS.



OBJECTS WITH UNEVEN WEIGHT SHOULD BE SUPPORTED WITH A FLAT, STURDY MATERIAL BEFORE PLACED ON THE TOP OF REFRIGERATOR TO DISTRIBUTE WEIGHT

AFTER UNPLUG, WAIT AT LEAST 5 MINUTES BEFORE PLUGGING IT BACK IN TO EXTEND ITS LIFESPAN AND PREVENT COMPRESSOR DAMAGE.

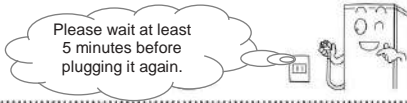

THE REFRIGERATOR SHOULD BE INSTALLED ALLOW AT LEAST 10 CM (4 INCHES) FROM SIDES AND BACK, 30 CM (12 INCHES) VERTICALLY FOR PROPER AIR CIRCULATION.

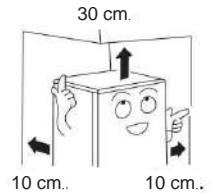

DO NOT SWING OR HANG ON THE DOOR. BECAUSE IT WILL CAUSE THE CABINET TO FALL OR THE DOOR TO FALL.



DO NOT STORE CHEMICALS, FLAMMABLE MATERIALS, MATERIALS CONTAINING LACQUER, GASOLINE OR THINNER IN THE REFRIGERATOR BECAUSE THESE MATERIALS HAVE LOW FLASH POINTS.

DO NOT TOUCH AN EVAPORATOR SURFACE, FOOD OR METAL CONTAINERS INSIDE AN EVAPORATOR WITH WET HANDS.



GLASS BEVERAGES BOTTLES SHOULD NOT BE FROZEN IN THE FREEZER BECAUSE THE BOTTLE MAY BREAK OR EXPLODE.

THE REPLACEMENT, REPAIR AND ASSEMBLY OF ELECTRICAL SYSTEMS AND COOLING SYSTEMS MUST BE CARRIED OUT ONLY BY TOSHIBA THAILAND CO., LTD. DEALERS OR SERVICE PERSONNEL.

IN CASE THE GLASS SHELF IS BROKEN, PLEASE EXERCISE CAUTION WHEN CLEANING THE BROKEN GLASS.



WARNING : RISK OF FIRE / FLAMMABLE MATERIALS. THIS APPLIANCE CONTAINS FLAMMABLE REFRIGERANT R600A (ISO-BUTANE)

IN CASE THE COOLING SYSTEM IS DAMAGED AND THERE IS A GAS LEAK

1. DO NOT UNPLUG OR TOUCH THE REFRIGERATOR.
2. VENTILATE BY OPENING DOORS AND WINDOWS.
3. AVOID USING ELECTRICAL EQUIPMENT THAT CAUSES SPARKS.



HUMID CLIMATE : (SYMBOL 6332 ACCORDING TO IEC 60417 (2015-26))

ELECTRICITY MUST BE SUPPLIED TO ELECTRICAL APPLIANCES THROUGH A RESIDUAL CURRENT DEVICE (RCD) SPECIFIED NOT TO EXCEED 30 mA.

THIS ELECTRICAL APPLIANCE IS SUITABLE FOR USE IN COUNTRIES WITH TROPICAL CLIMATES AND MAY ALSO BE USED IN OTHER COUNTRIES.

IDENTIFICATION AND FUNCTION OF PARTS

MODEL
GR-D147 / GR-D187
GR-D149 / GR-D189
GR-W149 / GR-W189

THE DOOR FOR MODEL
GR-C149F / GR-C189F

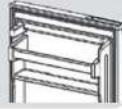

EGG SUPPORTER CAN BE
CHANGED TO STORE
OTHER THINGS.
(HAVE ONLY MODEL
GR-D145 / GR-D175)

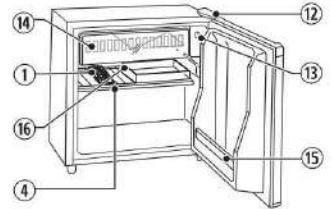
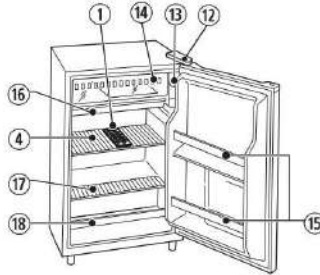
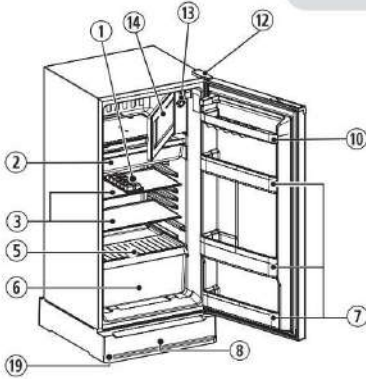
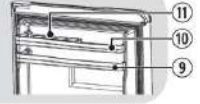

- | | | | |
|---|--|-----------------------------------|---|
| 1) ICE TRAY | 6) CRISPER | 12) UPPER HINGE COVER | 17) WIRE SHELF (LOWER) |
| 2) MEAT PAN | 7) BOTTLE POCKET | 13) TEMPERATURE CONTROL
BUTTON | 18) BARRIER PANEL(UNDER) |
| 3) GLASS SHELF
(PLASS SHELF HAVE ONLY MODEL
GR-C149F / GR-C189F
GR-W149 / GR-W189) | 8) REFRIGERATOR STAND | 14) EVAPERATOR DOOR | 19) ADJUST LEGS |
| 4) WIRE SHELF | 9) POKETSUPPORT
(HAVE ONLY MODEL GR-D175) | 15) BOTTLE POCKET | TURN CLOCKWISE TO
LIFT THE CABINET,
COUNTER CLOCKWISE
ROTATION TO REDUCE
THE LEVEL. |
| 5) LOWER SHELF | 10) EGG-POCKET | 16) DRAIN PAN | |
| | 11) EGG RACK | | |

*NO.19 IS USED TO PLACE THE CABINET AT THE CORRECT LEVEL (EXCEPT MODELS GR-D145/GR-D175).

NOTE : SPECIFICATIONS ARE SUBJECTED TO CHANGE WITHOUT NOTICE.

PARTS AND QUANTITY OF PARTS WILL VARY DEPENDING ON THE MODEL.

REFRIGERATOR DETAIL

MODEL	GR-D706CP	GR-D706	GR-D906	GR-D145	GR-D175	GR-D147	GR-D187	GR-D149	GR-D189	GR-W149 GR-C149F	GR-W189 GR-C189F
REFRIGERATOR TYPE	REFRIGERATOR										
DEFROST SYSTEM	MANUAL			SEMI-AUTOMATIC							
STAR TYPE OF FREEZER	-	-	-	0	0	0	0	0	0	0	0
VOLUMP (LITTER)	49	49	88.6	140	170	145.9	181.6	145.9	181.6	145.9	181.6
ELECTRIC POWER (WATT)	72	62	62	67	68	67	68	67	68	67	68
VOLTAGE (VOLT)	220-240										
FREQUENCY (HERZE)	50										
ELECTRIC PHASE	1										
REFRIGERANT TYPE	R600a										

TEMPERATURE CONTROL

THE COOLING LEVEL CAN BE ADJUSTED ACCORDING TO THE REQUIREMENTS AS SHOWN IN THE TABLE.

MODEL GR -D147 / GR-D187
GR-D149 / GR-D189
GR-C149F / GR-C189F
GR-W149 / GR-W189

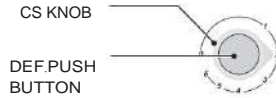

MODEL GR -D145 / GR-D175

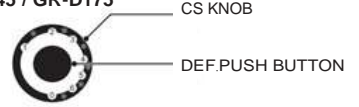

TEMPERATURE CONTROL	OFF	1	2-3	4-5	6
COOLING LEVEL	TURN OFF	LOW COOL	NORMAL COOL	HIGH COOL	VERY COOL

MODEL GR-D706CP / GR-D706 / GR-D706X / GR-D706XK / GR-D906 / GR-D906K

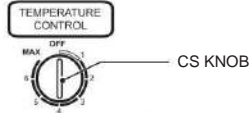

TEMPERATURE CONTROL	OFF	1-2	3-4	5-6	MAX
COOLING LEVEL	TURN OFF	LOW COOL	NORMAL COOL	HIGH COOL	VERY COOL

MAINTENANCE

PARTS THAT REQUIRE REGULAR MAINTENANCE

INTERIOR PARTS OF REFRIGERATOR	OUTSIDE OF REFRIGERATOR	DOOR GASKET
IF THERE IS DIRTY POSITION, USING WARM WATER AND CLOTH TO CLEAN IT OUT. BUT IF IT TOO STRONG. MIX WARM WATER WITH A FEW OF SOPE TO CLEAN IT OUT THEN FOLLOW BY CLEAN CLOTH. IF THERE IS SALAD OR OTHER OIL STAIN SHOULD BE CLEAN IMMEDIATELY AS CAN DAMAGE THE PARTS.	SHOULD BE CLEAN AT LEAST ONCE A MONTH, USING SOFT CLOTH CLEAN THE OUTSIDE OF REFRIGERATOR. BUT IF IT TOO STRONG. MIX WARM WATER WITH A FEW OF SOPE TO CLEAN IT OUT THEN FOLLOW BY CLEAN CLOTH. ON THE HANDLE, USE A DRY CLOTH TO CLEAN.	AT LEAST 2 WEEKS FOR CLEANING, USING SOFT BRUSH AND WARM WATER CLEAN IF SOFTLY FOLLOW BY SOFT AND CLEAN CLOTH.

CHANGING THE DEODORIZER

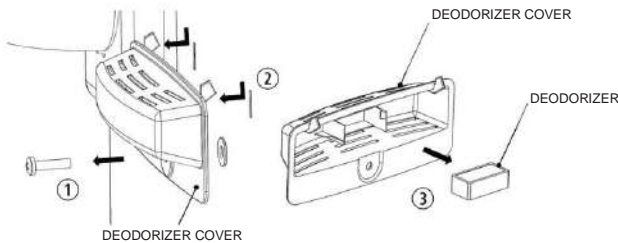

(MODEL: GR-D147 / GR-D187)

- 1) REMOVE THE DEODORIZER COVER BY UNSCREWING THE SCREW.
- 2) REMOVE THE DEODORIZER COVER BY SLIDING IT DOWN. THEN PULL IT OUT ACCORDING THE ARROW POINT.
- 3) REMOVE THE DEODORIZER BY PULLING IT OUT.

DEFROST METHOD

MANUAL METHOD (POUR WATER)

(MODEL : GR-D706CP / GR-D706 / GR-D706X / GR-D706XK / GR-D906 / GR-D906K)
WHEN AN ICE COVERING THE INSIDE OF AN EVAPERATOR IS VERY THICKNESS.

- 1) ICE SHOULD BE MELTED WHEN THERE IS ICE COVERING THE INSIDE OF AN EVAPERATOR IS VERY THICKNESS BY TURN KNOB TO OFF (COUNTER CLOCKWISE).
- 2) THE COOLING SYSTEM WILL STOP WORKING. WHEN THE ICE MELTS, WATER FROM MELTING ICE WILL BE CONTAINED IN A DRAIN PAN. DRAIN THE WATER AND CLEAN IT. AFTER THAT ASSEMBLE DRAIN PAN AND TURN KNOB TO NORMAL POSITION OR YOUR PREFER COOLING.

DEFROST METHOD

MANUAL METHOD (POUR WATER)

(MODEL: GR-D706CP / GR-D706 / GR-D706X / GR-D706XK / GR-D906 / GR-D906K)

•WHEN YOU WANT TO CANCEL DEFROST, TURN KNOB TO YOUR PREFER COOLING (SHOULD BE ALLOW TIME AT LEAST 5 MINUTES AFTER DEFROSTING)

•FOR MODEL: GR-D706CP / GR-D706 / GR-D706X / GR-D706XK WHEN DEFROSTING, SHOULD BE PLACE THE DRAIN PAN IN THE POSITION THAT IS ALIGNED OF EVAPERATOR.

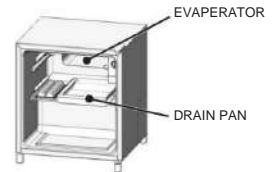

PLACE THE DRAIN PAN IN THE POSITION LINE OF EVAPERATOR

SEMI-AUTOMATIC METHOD (EVAPORATE WATER)

(MODEL: GR-D145 / GR-D147 / GR-D149 / GR-D175

GR-D187 / GR-D189 / GR-C149F / GR-C189F / GR-W149 / GR-W189)

WHEN AN ICE COVERING THE INSIDE OF AN EVAPERATOR IS THICKNESS THAN THE DEFROST MARKING BY PRESS THE DEFROST BUTTON.

WHEN DEFROSTING PROCESS IS COMPLETED, THE DEFROST BUTTON WILL AUTOMATICALLY PULL BACK TO NORMAL POSITION.

•IF AN ICE COVERING THE INSIDE OF EVAPERATOR TOO MUCH. THE WATER FROM DEFROSTING WILL DROP TO DRAIN PAN BACK MORE THAN AUTOMATIC EVAPERATION. THEREFOR, IT IS NECESSARY FOR THE USER TO DRAIN.

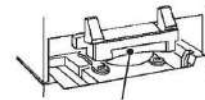
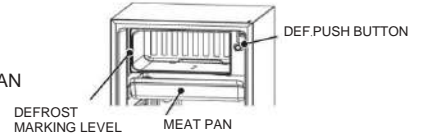

EXCEPT MODEL: GR-D147 / GR-D149 / GR-C149F / GR-W149

FOR MODEL: GR-D147 / GR-D149 / GR-C149F / GR-W149

BEFORE DEFROSTING, SHOULD BE BRING STORED FOOD OUT FROM THE MEAT PAN. AFTERTHAT, PRESS THE DEFROST BUTTON, WHEN THE ICE MELTS PULL OUT THE

DIASSEMBLY OF PARTS

PLASTIC PARTS INSIDE THE CABINET

(MODEL : GR-D145 / GR-D147 / GR-D149 / GR-D175 / GR-D187 / GR-D189 / GR-C149F / GR-C189F / GR-W149 / GR-W189)

EGG POCKET / BOTTLE POCKET	MEAT PAN / GLASS SHELF	DRAIN PAN BACK
<p>USE THE OTHER HAND TO HOLD IT AND PUSH IT UPWARD IN THE ACCORDING THE ARROW POINT. DO THIS ON BOTH SIDES.</p> <p>EGG POCKET</p> <p>BOTTLE POCKET</p> <p>POCKET BAR •C149F ASSEMBLY TOP, BOTTOM SHELF. •C189F ASSEMBLY TOP, SECOND AND BOTTOM SHELF.</p> <p>ASSEMBLY POCKET BAR BY LET SLANT SIDE TURN TO FRONT SIDE.</p> <p>POCKET BAR •C149F ASSEMBLY WITH SECOND SHELF. •C189F ASSEMBLY WITH THERD SHELF.</p>	<p>USE YOUR HAND TO PULL OUT THE MEAT PAN IN THE ACCORDING THE ARROW POINT. DO THIS ON BOTH SIDE.</p>	<p>USE YOUR HAND TO PULL IT TOWARDS YOU ACCORING TO THE ARROW TO PULL OUT OF PIN DRAIN PAN BACK FROM THE HOLD LOCK. (SHOULD BE TAKE OFF AND CLEANED REGULARLY TO PREVENT MUSTY SMAELL.</p>

HOW TO CHECK BEFORE REQUEST SERVICE

WHEN THE REFRIGERATOR DOES NOT WORK, DOES NOT COOLING

- CHECK THE PLUG AND SOCKET ARE IN GOOD CONDITION AND ARE TIGHTLY CONNECTED?
- CHECK THE ELECTRICAL SYSTEM IN THE HOUSE IS OFF?
- CHECK THE FUSE AT THE MAIN DISTRIBUTION BOARD IS BROKEN?
- IS THE TEMPERATURE SET TOO LOW OR IS THERE TOO MUCH STUFF IN THE REFRIGERATOR?
- IS THE REFRIGERATOR INSTALLED IN A LOCATION AWAYS FROM SUNLIGHT OR HEAT EMITTING OBJECTS?
- IS THE DOOR FREQUENTLY OPENED AND CLOSED?
- IS THERE HOT FOOD STORED IN THE REFRIGERATOR?
- IS THE DOOR CLOSED PROPERLY?



WHEN THE REFRIGERATOR IS NOISE

- IS THE REFRIGERATOR INSTALLATION POSITION CORRECT?
- IS THE DRAIN TRAY FIRMLY FIXED?
- ARE CONTAINERS PLACE SIDEWAY IN THE REFRIGERATOR?
- ARE THERE OTHER OBJECTS TOUCHING OF THE REFRIGERATOR?

VAPOUR ON THE SIDES OF THE REFRIGERATOR

- SOMETIMES, CONDENSATION MAY FORM ON THE SIDES OF THE REFRIGERATOR, ESPECIALLY WHEN THE HUMIDITY IS HIGH. USE A DRY CLOTH TO WIPE IT.

CONDENSATION OCCURS INSIDE THE REFRIGERATOR

- IS THE DOOR FREQUENTLY OPENED AND CLOSED OR HAS IT BEEN LEFT OPEN FOR A LONG TIME?
- IS THERE HIGH MOISTURE FOOD STORED IN THE REFRIGERATOR WITHOUT WRAPPING IT?
- IS THE TEMPERATURE SET TO A LOW SETTING OR IS THERE TOO MUCH FOOD IN THE REFRIGERATOR?
- IF THERE ARE WATER DROPLETS INSIDE THE REFRIGERATOR, WIPE THEM OFF WITH A DRY CLOTH.



DISPOSE THE REFRIGERATOR

- TOSHIBA REFRIGERATOR IS CYCLOPENTENE INSULATION (C_5CH_{10}) AND REFRIGERANT IS R600a WHEN YOU WANT TO DISPOSE, SHOULD BE AWAY FROM HEAT OR FLAME.
- WHEN YOU WANT TO DISPOSIND A REFRIGERATOR, SHALL BE DONE IN ACCORDANCE WITH THE NATIONAL OR LOCAL REGULATIONS TO PRESERVE THE ENVIRONMENT. MORE DETAILS PLEASE CONTACT YOUR LOCAL CITY OFFICE OR YOUR HOUSEHOLD WASTE DISPOSAL SERVICE.

HOW TO MOVING THE REFRIGERATOR

- MUST TAKE OFF AN ELECTRICAL PLUG BEFORE MOVE. REMOVE STORED FOOD FROM THE REFRIGERATOR.
- SHOULD BE DRAIN OUT WATER IN DRAIN PAN BACK AND CLEAN UP.
- STICK TAPE AT DOOR AND CABINET TO PREVENT DOOR OPEN WHILE MOVING.
- SHOULD BE MOVING THE REFRIGERATOR BY 2 PERSONS.
- DO NOT TRANSPORTING THE REFRIGERATOR IN A LYING POSITION. IF THERE ARE ANY LOADING RESTRICTIONS, PLACE THE REFRIGERATOR AT A 45 DEGREE ANGLE (FIGURE 1)



FIGURE 1

HOW TO REPLACE LAMP

CAUTION :



- BEFORE TAKING OFF LAMP NEED TO TAKE OFF ELECTRICAL PLUG FIRSTLY.
- WHEN ASSEMBLING LAMP, ROTATE THE LAMP INTO THE LAMP SOCKET TIGHTLY TO PREVENT SPARK, BECAUSE THIS REFRIGERATOR CONTAINS REFRIGERANT IS R600a, WHICH IS FLAMABLE MATERIAL.
- PLEASE BE CAREFUL WHEN YOU TOUCH LAMP, IT WILL BE HIGH TEMPERATURE.
- PLEASE DON'T USE REFRIGERATOR WITHOUT LAMP OR REPLACEMENT NOT COMPLETE.

MODEL : GR-D706CP / GR-D706 / GR-D706K / GR-D906 / GR-D906K

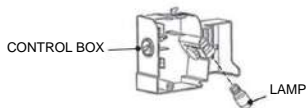

1. TAKE LAMP OFF BY TURN COUNTERCLOCKWISE.
2. REPLACE A NEW LAMP (E14 240V / 15W) BY TURN CLOCKWISE.

MODEL : GR-D145 / GR-D175

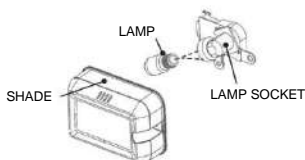

1. USE A SCREWDRIVER TO TAKE OFF SCREW FIXED A SHADE TAKE SHADE OUT.
2. TAKE LAMP OFF BY TURN COUNTERCLOCKWISE.
3. REPLACE A NEW LAMP (E14 240V / 15W) BY TURN CLOCKWISE.
4. RE-ASSEMBLY AND FIXING SHADE BY SCREW.

MODEL : GR-D147 / GR-D187 / GR-D149 / GR-D189 / GR-C149F / GR-C189F / GR-W149 / GR-W189
THE POSITION OF LAMP IS UNDER THE CONTROL BOX IT ON THE SIDE OF EVAPERATOR.

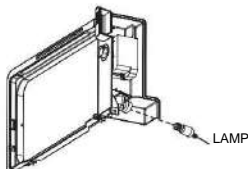

1. TAKE LAMP OFF BY TURN COUNTERCLOCKWISE.
2. REPLACE A NEW LAMP (E14 240V / 15W) BY TURN CLOCKWISE.

PRODUCT WARRANTY

REGISTRATION AND WARRANTY CARD

PLEASE READ AND UNDERSTAND THE DETAILS IN THE PRODUCT WARRANTY. ONE PART MUST BE RETURNED TO THE COMPANY. OTHERWISE, IT WILL BE CONSIDERED THAT YOU WAIVE. AND THE OTHER PART, PLEASE KEEP IT TO SHOW YOUR RIGHTS EVERY TIME YOU USE THE SERVICE.

REQUEST FOR SURVICE

IF YOU ENCOUNTER ANY PROBLEMS WITH YOUR TOSHIBA REFRIGERATOR, PLEASE CONTACT YOUR AUTHORIZED TOSHIBA DEALER OR SERVICE CENTER NEAR YOUR HOUSE.

TOSHIBA *บ้านที่ติดสุขชีวิต*

Distributor
Toshiba Thailand Co., Ltd.
201 Vibhavadi Rangsit Road, Chatuchak Subdistrict,
Chatuchak District, Bangkok 10900
Tel: 0-2511-7999 Fax: 0-2513-0305
Information Service Center 0-2511-7777
www.toshiba-lifestyle.com/th

Manufacturer
Thai Toshiba Industry Co., Ltd.
129/1-5 Tiwanon Road, Tha Sai Subdistrict, Mueang District,
Nonthaburi Province 11000
Tel: 0-2588-3010, 0-2589-0160-8 Fax: 0-2589-7028