

INSTRUCTION MANUAL

MICROWAVE OVEN

MW3-SAC24SE(BK)

Please review this instruction manual before operating.

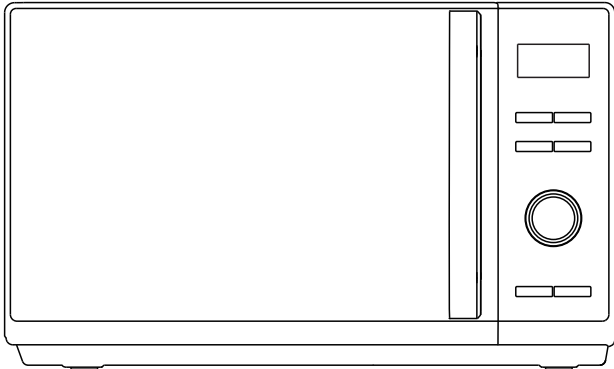

TOSHIBA

CONTENTS

IOT SMART CONTROL

Product wireless network connection	EN-01
How connect your devices to TSmartLife	EN-02

PRODUCT SAFETY

Precautions to avoid possible exposure to excessive microwave energy	EN-04
Important safety instructions.....	EN-06
Specification.....	EN-05
To reduce the risk of injury to persons grounding installation	EN-11
Cleaning	EN-13
Utensils	EN-14
Materials you can use in microwave oven	EN-15
Materials can not be used in microwave oven	EN-17

PRODUCT SETTING

Setting up your oven	EN-18
----------------------------	-------

INSTRUCTION FOR USE

Before using for the first time	EN-21
Operation	EN-22
1. Power levels	EN-23
2. Clock setting	EN-23
3. Kitchen timer	EN-24
4. Microwave cook	EN-25

5. Grill or combination	EN-27
6. Convection with preheat	EN-28
7. Convection without preheat	EN-29
8. Auto menu	EN-32
9. Weight defrost	EN-35
10. Time defrost	EN-35
11. Multi-stage cooking.....	EN-38
12. Speedy cooking	EN-39
13. Inquiring function.....	EN-39
14. Lock function	EN-40

CLEANING AND MAINTENANCE

Cleaning	EN-42
Trouble shooting	EN-44





NOTE

BEFORE OPERATING THIS PRODUCT, READ, UNDERSTAND, AND FOLLOW THESE INSTRUCTIONS. BE SURE TO SAVE THIS BOOKLIST FOR FUTURE REFERENCE.

IOT SMART CONTROL



PRODUCT WIRELESS NETWORK CONNECTION

a Connect the network

Press and hold " | 

" for 3 seconds, till a beep sounds, "AP" and flashing "" show on display. If it fails, "N0" will display, and the oven will return to standby after 30 seconds.

b Disconnect from the network

Press and hold " | 

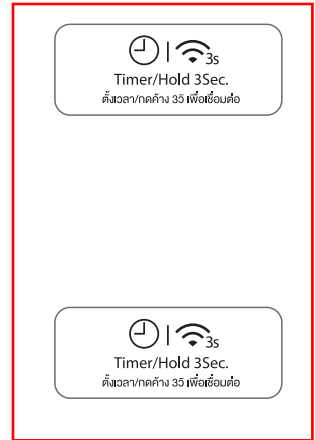
" for 8 seconds, till a beep sounds, "--" flashes for few seconds, if the link has been removed successfully, the screen will display "8888" and then return to standby after 3 seconds. If it fails, "FFFF" will display, and the oven will return to standby after 3 seconds.

HOW CONNECT YOUR DEVICES TO TSmartLife

1 Download The TSmartLife App

Scan QR code or find us on your App store.

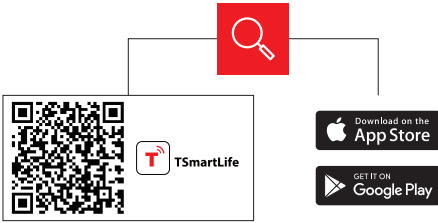

2 Register and Log in

Log in for existing users or sign up for new users.

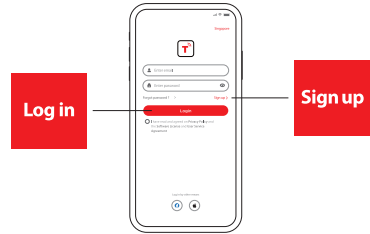

3 Connect your Devices to TSmartLife

STEP 1.

Connect to wireless network and enable Bluetooth.

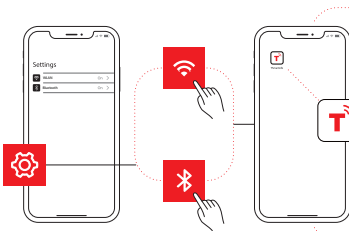

STEP 2.

Open the TSmartLife App. Power on selected device.

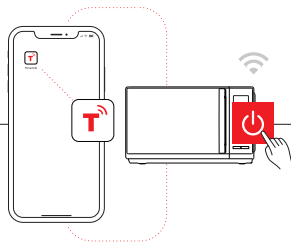

STEP 3.

Add your device using one of the following methods:

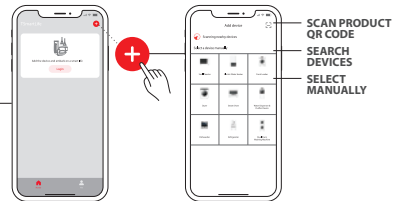

STEP 4.

Ensure device and App are under same wireless network.

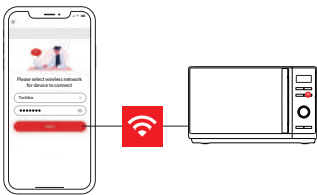

STEP 5.

Press “🕒 | 📶” button for 3 seconds on the panel. Following instruction to set up, it will connect automatically.



STEP 6.

Rename your device and try to remote control it.



HOW CONNECT YOUR DEVICES TO TSmartLife

TIPS

- Make sure your devices are powered on.
- Keep your mobile phone close to your device during connection.
- Connect your mobile phone to the wireless network at home.
- Enable the 2.4GHz frequency on your wireless network router. 5GHz Wi-Fi network is not available at current stage.
- The device is unable to connect to wireless network that requires authentication and also appears in public areas such as hotels and restaurants.
- It is recommended to use a wireless network name that only contains letters and numbers. If your wireless network name contains special characters, modify it in the router. Disable WLAN+ (Android) or WLAN Assistant (iOS) when connecting your devices to the network.
- To reconnect a device to the wireless network, click "+" on the App home screen and add the device again by the category and model according to the App prompts.

PRECAUTIONS TO AVOID POSSIBLE EXPOSURE TO EXCESSIVE MICROWAVE ENERGY

- (a). Do not attempt to operate this oven with the door open since this can result in harmful exposure to microwave energy. It is important not to break or tamper with the safety interlocks.
- (b). Do not place any object between the oven front face and the door or allow soil or cleaner residue to accumulate on sealing surfaces.
- (c). **WARNING:** If the door or door seals are damaged, the oven must not be operated until it has been repaired by a competent person.

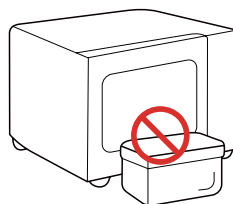

ADDENDUM

If the apparatus is not maintained in a good state of cleanliness, its surface could be degraded and affect the lifespan of the apparatus and lead to a dangerous situation.

SPECIFICATIONS

Model	MW3-SAC24SE(BK)
Capacity :	24 L
Voltage Input :	230 V~
Frequency :	50 Hz
Protection Against Electric Shock Class :	I
Microwave Rated Power Input :	1,450 W
Grill Rated Power Input :	1000 W
Convection Rated Power Input :	1680 W
Microwave Rated Power Output :	900 W
Microwave Frequency :	2,450 MHz
Net Weight :	15 kg
Dimension (WxLxH) :	469 x 415 x 280 mm

IMPORTANT SAFETY INSTRUCTIONS



WARNING

To reduce the risk of fire, electric shock, injury to persons or exposure to excessive microwave oven energy when using your appliance, follow basic precautions, including the following:



Read and follow the specific: "**PRECAUTIONS TO AVOID POSSIBLE EXPOSURE TO EXCESSIVE MICROWAVE ENERGY**".



This appliance is not intended for use by persons (including children) with reduced physical, sensory or mental capabilities, or lack of experience and knowledge, unless they have been given supervision or instruction concerning use of the appliance by a person responsible for their safety.



Children should be supervised to ensure that they do not play with the appliance.





If the supply cord is damaged, it must be replaced by the manufacturer, its service agent or similarly qualified persons in order to avoid a hazard.



WARNING: Ensure that the appliance is switched off before replacing the lamp to avoid the possibility of electric shock.

IMPORTANT SAFETY INSTRUCTIONS

 **WARNING:** It is hazardous for anyone other than a competent person to carry out any service or repair operation that involves the removal of a cover which gives protection against exposure to microwave energy.

 **WARNING:** Liquids and other foods must not be heated in sealed containers since they are liable to explode.

 When heating food in plastic or paper containers, keep an eye on the oven due to the possibility of ignition.

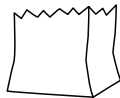

 Only use utensils that are suitable for use in microwave ovens.

 If smoke is emitted, switch off or unplug the appliance and keep the door closed in order to stifle any flames.

 Microwave heating of beverages can result in delayed eruptive boiling, therefore care must be taken when handling the container.

 The contents of feeding bottles and baby food jars shall be stirred or shaken and the temperature checked before consumption, in order to avoid burns.

IMPORTANT SAFETY INSTRUCTIONS



The oven should be cleaned regularly and any food deposits removed. Please keep the waveguide area clean. Use soft damp cloth to clean it up when there is food splash residue on the waveguide area or the cavity. Failure to clean food residue may cause innocuous sparking or some smoke in the microwave cavity, discoloration of the cavity may also occur.

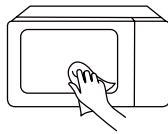

Only use the temperature probe recommended for this oven. (for ovens provided with a facility to use a temperature-sensing probe.)



The microwave oven must be operated with the decorative door open. (for ovens with a decorative door.)



This appliance is intended to be used in household and similar applications such as:

1. staff kitchen areas in shops, offices and other working environments;
2. by clients in hotels, motels and other residential type environments;
3. farm houses;
4. bed and breakfast type environments.





The microwave oven is intended for heating food and beverages. Drying of food or clothing and heating of warming pads, slippers, sponges, damp cloth and similar may lead to risk of injury, ignition or fire.

IMPORTANT SAFETY INSTRUCTIONS

 The appliance is intended to be used freestanding.

 The rear surface of appliances shall be placed against a wall.

 The temperature of accessible surfaces may be high when the appliance is operating.

 **WARNING:** When the appliance is operated in the combination mode, children should only use the oven under adult supervision due to the temperatures generated.

 Eggs in their shell and whole hard-boiled eggs should not be heated in microwave ovens since they may explode, even after microwave heating

has ended.

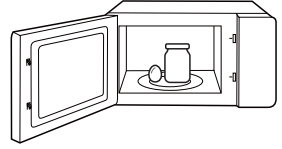

 The appliance must not be installed behind a decorative door in order to avoid overheating. (This is not applicable for appliances with decorative door.)

 The microwave oven shall not be placed in a cabinet unless it has been tested in a cabinet.

 Metallic containers for food and beverages are not allowed during microwave cooking.

 The appliance shall not be cleaned with a steam cleaner.

IMPORTANT SAFETY INSTRUCTIONS



The appliances are not intended to be operated by means of an external timer or separate remote-control system.



Failure to maintain the oven in a clean condition could lead to deterioration of the surface that could adversely affect the life of the appliance and possibly result in a hazardous situation.

**READ CAREFULLY AND KEEP FOR
FUTURE REFERENCE**

TO REDUCE THE RISK OF INJURY TO PERSONS GROUNDING INSTALLATION

This appliance must be grounded. In the event of an electrical short circuit, grounding reduces the risk of electric shock by providing an escape wire for the electric current.

This appliance is equipped with a cord having a grounding wire with a grounding plug. The plug must be plugged into an outlet that is properly installed and grounded.

WARNING - Improper use of the grounding can result in a risk of electric shock. Consult a qualified electrician or serviceman if the grounding instructions are not completely understood or if doubt exists as to whether the appliance is properly grounded. If it is necessary to use an extension cord, use only a 3-wire extension cord.



DANGER

Electric Shock Hazard:

Touching some of the internal components can cause serious personal injury or death. Do not disassemble this appliance.

TO REDUCE THE RISK OF INJURY TO PERSONS GROUNDING INSTALLATION



WARNING

Electric Shock Hazard:

Improper use of the grounding can result in electric shock. Do not plug into an outlet until appliance is properly installed and grounded.

1. A short power-supply cord is provided to reduce the risks resulting from becoming entangled in or tripping over a longer cord.
2. If a long cord or extension cord is used:
 - (1). The marked electrical rating of the cord set or extension cord should be at least as great as the electrical rating of the appliance.
 - (2). The extension cord must be a grounding-type 3-wire cord.
 - (3). The longer cord should be arranged so that it will not drape over the counter top or tabletop where it can be pulled on by children or tripped over unintentionally.

CLEANING

Be sure to unplug the appliance from the power supply.

1. Clean the cavity of the oven after using with a slightly damp cloth.
2. Clean the accessories in the usual way in soapy water.
3. The door frame and seal and neighbouring parts must be cleaned carefully with a damp cloth when they are dirty.
4. Do not use harsh abrasive cleaners or sharp metal scrapers to clean the oven door glass since they can scratch the surface, which may result in shattering of the glass.
5. Cleaning Tip---For easier cleaning of the cavity walls that the food cooked can touch: Place half a lemon in a bowl, add 300ml (1/2 pint) water and heat on 100% microwave power for 10 minutes. Wipe the oven clean using a soft, dry cloth.

UTENSILS



CAUTION

Personal Injury Hazard:

It is hazardous for anyone other than a competent person to carry out any service or repair operation that involves the removal of a cover which gives protection against exposure to microwave energy. See the instructions on "**Materials you can use in microwave oven**" or "**Materials can not be used in microwave oven**"

There may be certain non-metallic utensils that are not safe to use for microwaving. If in doubt, you can test the utensil in question following the procedure below.

Utensil Test:

1. Fill a microwave-safe container with 1 cup of cold water (250ml) along with the utensil in question.
2. Cook on maximum power for 1 min.
3. Carefully feel the utensil. If the empty utensil is warm, do not use it for microwave cooking.
4. Do not exceed 1 min cooking time.

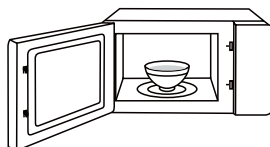





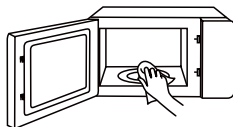











NOTE









KEEP THE CAVITY AND
WAVEGUIDE COVER CLEAN













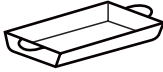



MATERIALS YOU CAN USE IN MICROWAVE OVEN

UTENSILS	REMARKS
 Browning dish	Follow manufacturer's instructions. The bottom of browning dish must be at least 3/16 inch (5mm) above the turntable. Incorrect usage may cause the turntable to break. 
 Dinnerware	Microwave-safe only. Follow manufacturer's instructions. Do not use cracked or chipped dishes. 
 Glass jars	Always remove lid. Use only to heat food until just warm. Most glass jars are not heat resistant and may break. 
 Glassware	Heat-resistant oven glassware only. Make sure there is no metallic trim. Do not use cracked or chipped dishes. 
 Oven cooking bags	Follow manufacturer's instructions. Do not close with metal tie. Make slits to allow steam to escape. 
 Paper plates and cups	Use for short-term cooking/warming only. Do not leave oven unattended while cooking. 
 Paper towels	Use to cover food for reheating and absorbing fat. Use with supervision for a short-term cooking only. 
 Parchment paper	Use as a cover to prevent splattering or a wrap for steaming. 

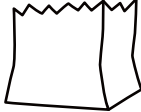
MATERIALS YOU CAN USE IN MICROWAVE OVEN

UTENSILS	REMARKS
 <p data-bbox="175 427 241 451">Plastic</p>	<p data-bbox="353 331 901 472">Microwave-safe only. Follow the manufacturer's instructions. Should be labeled "Microwave Safe". Some plastic containers soften, as the food inside gets hot. "Boiling bags" and tightly closed plastic bags should be slit, pierced or vented as directed by package.</p> 
 <p data-bbox="150 612 266 636">Plastic wrap</p>	<p data-bbox="353 533 901 612">Microwave-safe only. Use to cover food during cooking to retain moisture. Do not allow plastic wrap to touch food.</p> 
 <p data-bbox="135 775 281 799">Thermometers</p>	<p data-bbox="353 724 891 756">Microwave-safe only (meat and candy thermometers).</p> 
 <p data-bbox="157 938 259 962">Wax paper</p>	<p data-bbox="353 874 823 932">Use as a cover to prevent splattering and retain moisture.</p> 

MATERIALS CAN NOT BE USED IN MICROWAVE OVEN

UTENSILS	REMARKS
 <p>Aluminum tray</p>	May cause arcing. Transfer food into microwave-safe dish. 
 <p>Food carton with metal handle</p>	May cause arcing. Transfer food into microwave-safe dish. 
 <p>Metal or metal trimmed utensils</p>	Metal shields the food from microwave energy. Metal trim may cause arcing. 
 <p>Metal twist ties</p>	May cause arcing and could cause a fire in the oven. 
 <p>Paper bags</p>	May cause a fire in the oven. 
 <p>Plastic foam</p>	Plastic foam may melt or contaminate the liquid inside when exposed to high temperature. 
 <p>Wood</p>	Wood will dry out when used in the microwave oven and may split or crack. 

SETTING UP YOUR OVEN

(In case of any differences between the appliance and the pictures in this manual, the product shall prevail.)

NAMES OF MICROWAVE OVEN PARTS AND ACCESSORIES

Remove the oven and all materials from the carton and oven cavity.

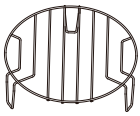

Grill Rack (Can not be used in microwave function and must be placed on the glass tray)

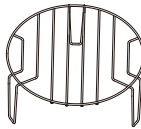

Grill Rack (Can not be used in microwave function and must be placed on the glass tray)

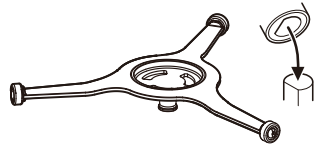

Turntable Ring Assembly



Instruction Manual

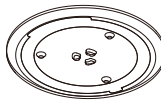

Glass turntable

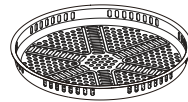

Bake Tray (Can't be used in microwave function and can be placed on the grill rack)

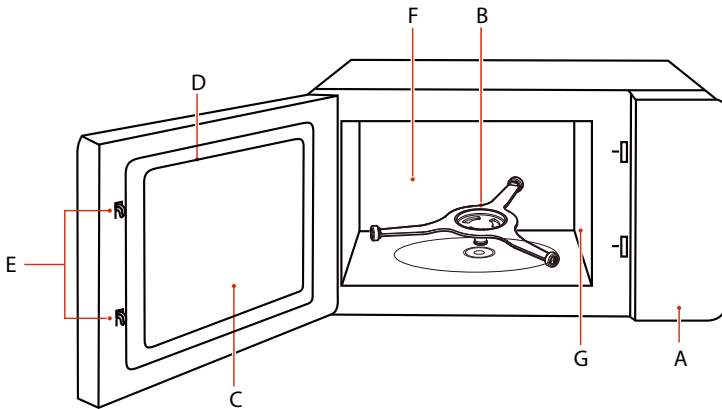

- A. Control panel
- B. Turntable Ring Assembly
- C. Observation window
- D. Door assembly

- E. Safety interlock system
- F. Oven cavity
- G. Waveguide cover

SETTING UP YOUR OVEN

TURNTABLE INSTALLATION

Clean the cooking compartment and place the turntable.

For new installations, make sure all packaging and shipping tape has been removed from the turntable shaft.

Before using the appliance to prepare food for the first time, you will need to put the turntable in place correctly. You must clean the cooking compartment and accessories. You can also refer them to the cleaning section.

How to put the turntable in place:

1. Place the turntable ring assembly ② into the recess in the cooking compartment.
2. Place the glass tray ① on the turntable ring assemblies ②.

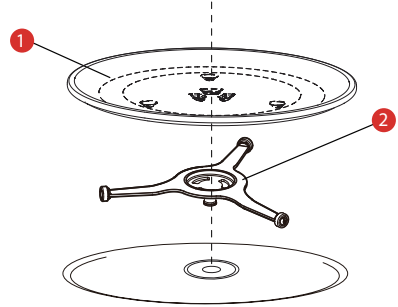

- 1) Glass Tray
2) Turntable Ring Assembly

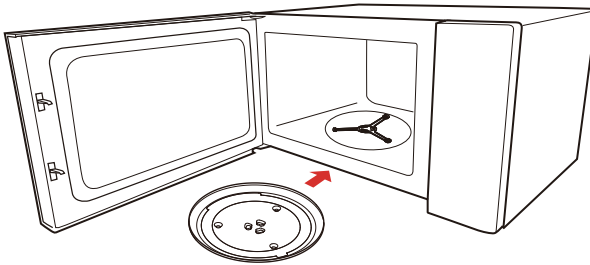

NOTE

- Never use the appliance without the turntable. Make sure that it is properly engaged. The turntable can turn clockwise or anti-clockwise.
- Never place the glass tray upside down. The glass tray should never be restricted.
- Both glass tray and turntable ring assembly must always be used during cooking.
- All food and containers of food are always placed on the glass tray for cooking.
- Never restrict the movement of the turntable.
- If glass tray or turntable ring assembly cracks or breaks, contact your nearest authorized service center.

COUNTERTOP INSTALLATION

Remove all packing material and accessories. Examine the oven for any damage such as dents or broken door. Do not install if oven is damaged.

Cabinet: Remove any protective film found on the microwave oven cabinet surface. Do not remove the waveguide cover that is attached to the oven cavity to protect the magnetron.

INSTALLATION

1. Select a level surface that provide enough open space for the intake and/or outlet vents.
 - a. The minimum installation height is 85cm.
 - b. The rear surface of appliance shall be placed against a wall. Leave a minimum clearance of 30cm above the oven. A minimum clearance of 20cm is required between the oven and any adjacent walls.
 - c. Do not remove the legs from the bottom of the oven.
 - d. Blocking the intake and/or outlet openings can damage the oven.
 - e. Place the oven as far away from radios and TV as possible.
Operation of microwave oven may cause interference to your radio or TV reception.

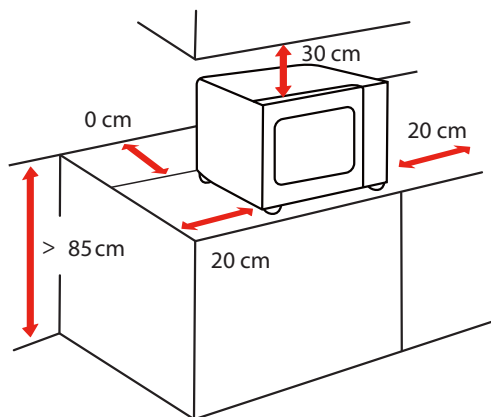

2. Plug microwave oven into a standard household outlet. Be sure the voltage and the frequency is the same as the voltage and the frequency on the rating label.



NOTE

- Do not install oven over a range cooktop or other heat-producing appliance. If installed near or over a heat source, the oven could be damaged and the warranty would be void.

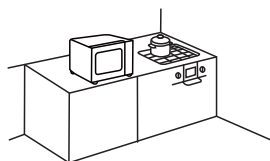

The accessible surface may be hot during operation

INSTRUCTION FOR USE

BEFORE USING FOR THE FIRST TIME

It is normal that the oven may produce unpleasant odors when it is used for the first time.

This section tells you what you need to do before using your microwave to prepare food for the first time. Read the section entitled "**PRODUCT SAFETY**" beforehand.

Before you can use your new appliance, you will need to put the turntable in place correctly. You must also clean the cooking compartment and accessories.



- Never use the appliance without the turntable.
- Make sure that it is properly engaged. The turntable can turn clockwise or anti-clockwise.

FIRST USE

Empty burning tips: Burn empty for 5 minutes before first use, to remove the anti-corrosion protective coating in the heating tube and the chamber.

Operation methods: Use the grill functions to burn empty for 5 minutes.

Notes: It is normal to have odor or smoke during empty burning.

End of empty burning: Unplug the power cord and fully open the oven door for quick heat dissipation. After the oven has cooled down completely, you can use the microwave oven normally.

OPERATION

CONTROL PANEL AND FEATURES

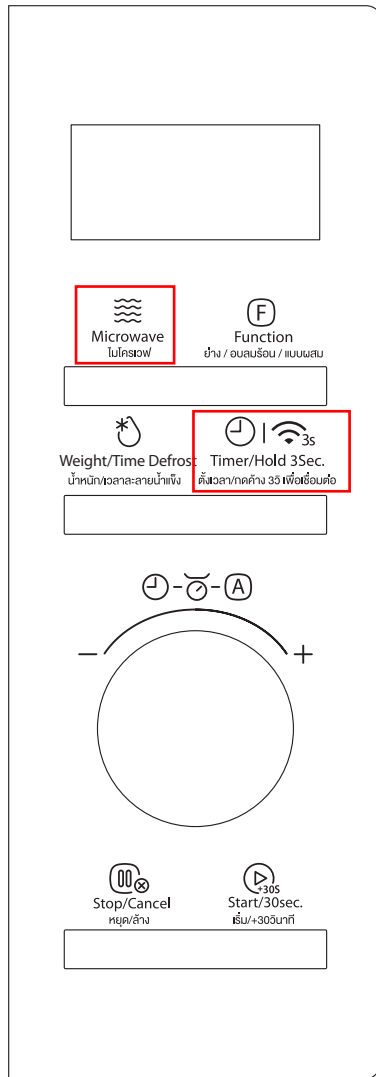

(You can also control the oven by app control)

NOTE

- App control: Download the TSmartLife first, then connect the app with your oven by the insert of TSmartLife APP connection guide.

1. POWER LEVELS

Microwave Power

LEVEL	POWER	DISPLAY
1	100%	P100
2	80%	P80
3	50%	P50
4	30%	P30
5	10%	P10

2. CLOCK SETTING

When the microwave oven is plugged into an outlet, "0:00" will display.

a Press  twice.



b Turn the knob to set the hour figures, it should be within 0-23.

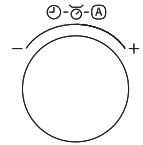

c Press  to confirm.



d Turn the knob to set the minute figures, it should be within 0-59.

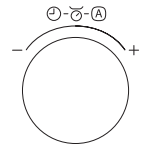

e Press  to confirm.



- When the oven is power on, if the clock is not be set, it will not work.
- In the process of setting clock, if there is not any operation in 5 minutes or press  directly, display will automatically return to the previous clock setting.

3. KITCHEN TIMER

When the microwave oven is plugged into an outlet, "0:00" will display.

a Press  once.



b Turn the knob to set the time, the maximum value is 95:00.

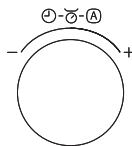

c Press  to start counting down.





- The Kitchen Timer setting is different from the Clock setting; it is simply a timer.
- During the Kitchen Timer function, no cooking function can be set into operation.

4. MICROWAVE COOK

Please do NOT use metal accessories under microwave function.
There are two ways to use the microwave function.

Panel control:

- a** Press  more times to choose the power level.
or
Press  once, and then turn the knob to set the power level.

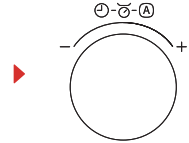

 NOTE	Press once: P100 Press twice: P80 Press three times: P50 Press four times: P30 Press five times: P10
--	--

- b** Press  to confirm the power level.



- c** Turn the knob to set the cooking time, the maximum value is 95:00.

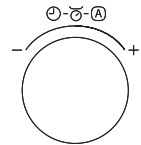

- d** Press  to start cooking.



App Control:



- To ensure safety, the app control function is only allowed within 10 minutes of closing the oven door in standby mode. After manually or remotely starting the microwave oven, you can continue to use the app control functions to modify the parameters.

- 1 Tap the  icon to enter the microwave heating function setting page.

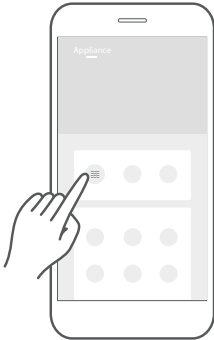

- 2 Swipe up and down to adjust microwave power.

Tap this area to exit the cooking parameter tab and return to device function page.

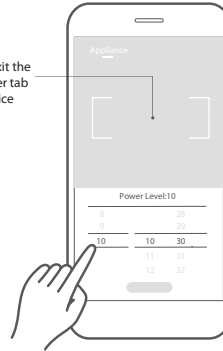

- 3 Swipe up and down the hour and minute selection to adjust cooking time.

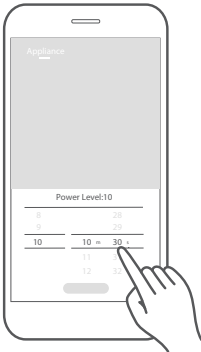

- 4 Click "Start" to start cooking.

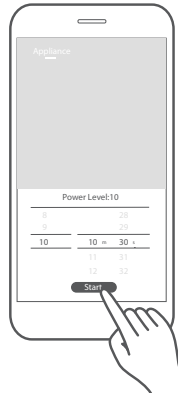

- Do not swipe too fast when sliding the wheel up and down to select parameters. Tap the "Start" button when the numbers stop scrolling.

5. GRILL OR COMBINATION

Please do NOT use metal accessories under combination function except for metal accessories equipped with the product.

There are two ways to use the grill/combine function.

Panel control:

Press (F) more times to choose the mode.



a or

Press (F) once, and then turn the knob to choose the mode. "G-1, C-1, ..., C-4, 110°C, 120°C,, 200°C" will display in order. ("G-1" is grill, "C-1~C-4" are combination).

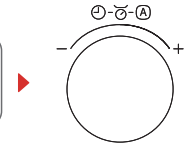

NOTE

Press once: G-1

Press twice: C-1

Press three times: C-2

Press four times: C-3

Press five times: C-4

Press six times or more: 110°C-200°C

b Press (▶+30s) to confirm the mode .



c Turn the knob to set the cooking time, the maximum value is 95:00.

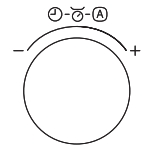

d Press (▶+30s) to start cooking.



NOTE

- When half of the time has finished, the buzzer will sound to remind you to turn the food over during grill function. If no operation, the oven will continue working.

Combi. mode	Microwave	Grill	Convection
C-1	•		•
C-2	•	•	
C-3		•	•
C-4	•	•	•

6. CONVECTION WITH PREHEAT

Non-microwave function, grill rack, grill pan available .

a Press **(F)** more times to choose the convection.

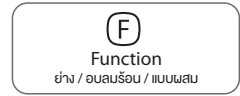

or

Press **(F)** once, and then turn the knob to choose the convection.
 110°C, 120°C.....200°C are available.
 Press six to fifteen times: 110°C-200°C

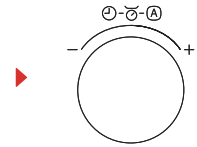

b Press **(▶+30s)** twice to start preheating.
 When preheating is completed, the temperature will flash,
 open the door and place food in the oven.



c Turn the knob to set the cooking time, the maximum
 value is 95:00.

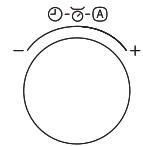

d Press **(▶+30s)** to start cooking.



7. CONVECTION WITHOUT PREHEAT

Non-microwave function, grill rack, grill pan available .

Press **(F)** more times to choose the convection temperature.



a or

Press **(F)** once, and then turn the knob to choose the convection temperature. 110°C, 120°C.....200°C are available.

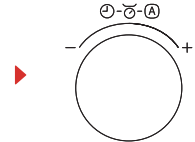

b Press  to confirm the temperature.



c Turn the knob to set the cooking time, the maximum value is 95:00.

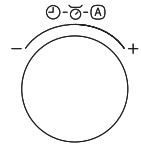

d Press  to start cooking.



App Control:



- To ensure safety, the app control function is only allowed within 10 minutes of closing the oven door in standby mode. After manually or remotely starting the microwave oven, you can continue to use the app control functions to modify the parameters.

GRILL

- 1 Tap the  icon to enter the grill function setting page.

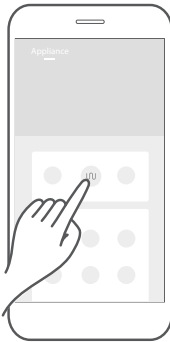

- 2 Swipe up and down to adjust the cooking time.

Tap this area to exit the cooking parameter tab and return to device function page.

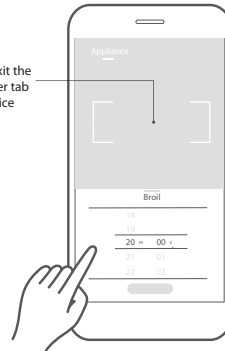

- 3 Click **"Start"** to start cooking.

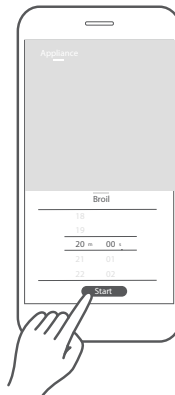

- Do not swipe too fast when sliding the wheel up and down to select parameters. Tap the **"Start"** button when the numbers stop scrolling.

CONVECTION

- 1 Tap “” to enter the convection setting page. Then swipe up and down to adjust the parameter.

Tap this area to exit the cooking parameter tab and return to device function page.

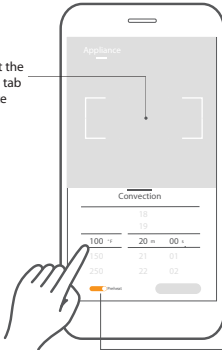

If preheat is desired, please open it first.

- 2 Click "Start" to start cooking.

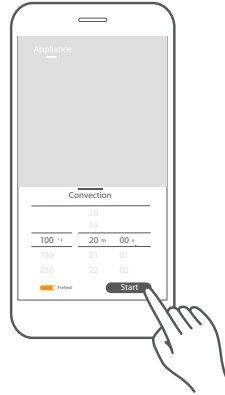

COMBINATION

- 1 Tap “C-1~C-4” to enter the mode setting page. Then swipe up and down to adjust the parameter.

Tap this area to exit the cooking parameter tab and return to device function page.

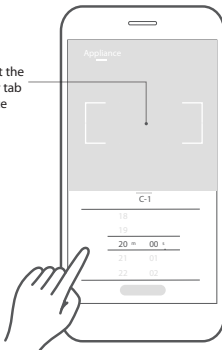

- 2 Click "Start" to start cooking.

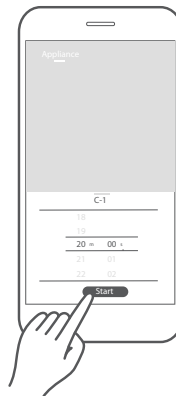



8. AUTO MENU

There are two ways to use the menu function.

Panel control:

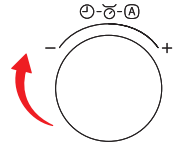
- a** In standby mode, Turn the knob right to set the menu.
"A-1" to "A-11" will display in order.



- b** Press  to confirm the menu.



- c** Turn the knob to set the weight of the food.

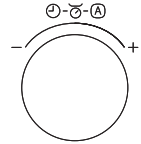

- d** Press  to start cooking.



MENU	WEIGHT/ PORTION	DISPLAY	POWER LEVEL	COOKING TIME
A-1 AUTO REHEAT	150g	150g	P100 (Micro.)	2'00"
	250g	250g		3'00"
	350g	350g		4'00"
	450g	450g		5'00"
	600g	600g		6'00"
A-2 POTATO (raw -> cooked)	1	1	P100 (Micro.)	5'00"
	2	2		8'30"
	3	3		12'30"

MENU	WEIGHT/ PORTION	DISPLAY	POWER LEVEL	COOKING TIME
A-3 MEAT (raw -> cooked)	150g	150g	P80 (Micro.)	3'00"
	300g	300g		4'30"
	450g	450g		6'00"
	600g	600g		8'00"
A-4 VEGETABLE (raw -> cooked)	150g	150g	P100 (Micro.)	3'00"
	350g	350g		5'00"
	500g	500g		6'30"
A-5 FISH (raw -> cooked)	150g	150g	P80 (Micro.)	3'00"
	250g	250g		4'00"
	350g	350g		5'30"
	450g	450g		6'30"
A-6 PASTA (raw -> cooked)	50g(with cold water 450g)	50g	P80 (Micro.)	18'00"
	100g(with cold water 800g)	100g		20'00"
	150g(with cold water 1200g)	150g		22'00"
A-7 SOUP	200g	200g	P100 (Micro.)	2'00"
	400g	400g		3'50"
	600g	600g		5'30"
A-8 CAKE (raw -> cooked)	475g	475g	CONVEC.150°C (With preheat)	55'00"
A-9 PIZZA (frozen -> cooked)	100g	100g	P100 (Micro.)+ CONVEC.200°C	1'30"/4'30"
	200g	200g		2'00"/6'00"
	300g	300g		2'30"/7'30"
A10 CHICKEN (raw -> cooked)	500g	500g	P100 (Micro.)+ CONVEC.200°C	5'00"/29'00"
	750g	750g		7'00"/32'00"
	1000g	1000g		9'00"/35'00"
	1200g	1200g		11'00"/38'00"
A-11 FRENCH FRIES (frozen -> cooked)	300g	300g	CONVEC.210°C	24'00"

App Control:



NOTE

- To ensure safety, the app control function is only allowed within 10 minutes of closing the oven door in standby mode. After manually or remotely starting the microwave oven, you can continue to use the app control functions to modify the parameters.

- 1 Tap the desired menu icon to enter the menu setting page. Then swipe up and down to adjust the cooking value.

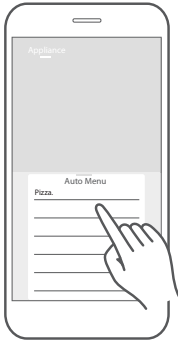

- 2 Click **"Start"** to start cooking.



NOTE

- Do not swipe too fast when sliding the wheel up and down to select parameters. Tap the **"Start"** button when the numbers stop scrolling.

9. WEIGHT DEFROST

Please do NOT use metal accessories under microwave function.

There are two ways to use the defrost function.

Panel control:

a Press  once, "dEF1" will display.



b Turn the knob to set the weight of food, it should be within "100g-2000g".
Adding weight by 100g each time.

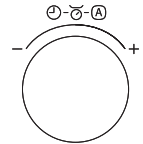

c Press  to start defrosting.



NOTE

- The buzzer will sound twice to remind you of turning over the food during defrosting.

10. TIME DEFROST

Please do NOT use metal accessories under microwave function.

a Press  twice, "dEF2" will display.



b Turn the knob to set the defrost time, it should be within "0:05~95:00".

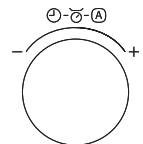

C Press



to start defrosting.



NOTE

- The buzzer will sound to remind you of turning over the food when half of the time has passed.
- The default power level is P30, it can not be changed.

App Control:



NOTE

- To ensure safety, the app control function is only allowed within 10 minutes of closing the oven door in standby mode. After manually or remotely starting the microwave oven, you can continue to use the app control functions to modify the parameters.

WEIGHT DEFROST

- 1 Tap the  icon to enter the weight defrost function setting page. Then Swipe up and down to adjust the weight.

Tap this area to exit the cooking parameter tab and return to device function page.

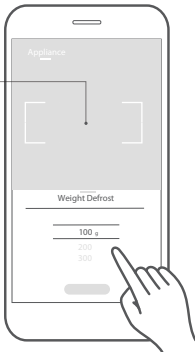

- 2 Click "Start" to start cooking.

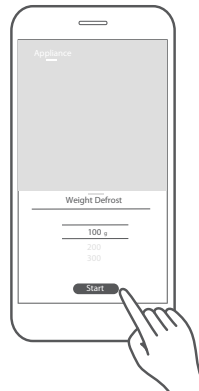

TIME DEFROST

- 1 Tap the  icon to enter the time defrost function setting page. Then swipe up and down to adjust the time.

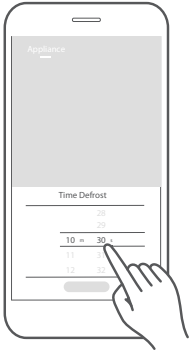

- 2 Click **"Start"** to start cooking.

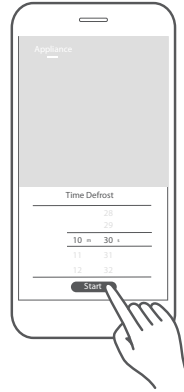

- Do not swipe too fast when sliding the wheel up and down to select parameters. Tap the **"Start"** button when the numbers stop scrolling.

11. MULTI-STAGE COOKING

Please do NOT use metal accessories under microwave function.

a Press  twice, "dEF2" will display.



b Turn the knob to set the defrost time, the maximum value is 95:00.

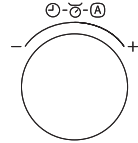

c Press  to choose the cooking mode .



d Press  to confirm.



e Turn the knob to set the cooking time, the maximum value is 95:00.

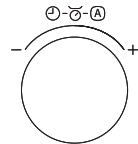

f Press  to start cooking.



- Two cooking stages can be set in multi-stage cooking.
- If you set defrost function, it will work automatically in the first stage.
- Kitchen Timer, Auto menu, Speedy cooking and Preheat cannot be set as one of the multi-stage.

12. SPEEDY COOKING

Please do NOT use metal accessories under microwave function.

- a Turn the knob left once to choose the cooking mode with 100% power level for 5 seconds directly.

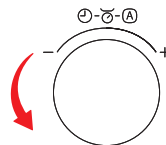

- b Turn the knob to set the time, the maximum value is 95:00.

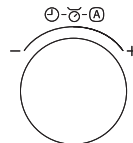

- c Press  to start cooking.



- a Press  once to cook with 100% power level with 30 seconds directly.



13. INQUIRING FUNCTION

- a When oven is cooking, press , the current time will appear for three seconds in the display.



14. LOCK FUNCTION

This function locks the microwave to avoid unintended use.

When the microwave is plugged into an outlet and is in standby mode, the default mode is set as unlocked.

There are 2 ways to use the lock function:

- a** To lock the microwave so that it cannot be operated by children or other unintended users, press  pad for 3 seconds, the locked icon will display.



- b** To unlock, press  pad for 3 seconds.



App Control:



NOTE

- To ensure safety, the app control function is only allowed within 10 minutes of closing the oven door in standby mode. After manually or remotely starting the microwave oven, you can continue to use the app control function to modify the parameters.

- 1** Tap the  icon on the "Appliance" page and then press "confirm" to activate the child lock function.

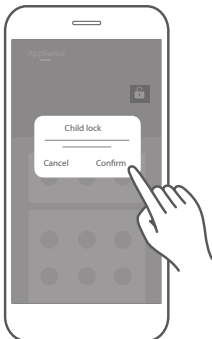

- 2** Tap and hold the locked button for 3 seconds to release the child lock function.

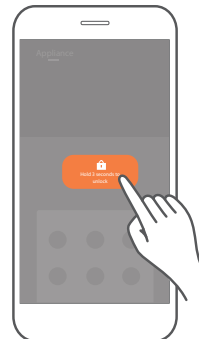

Other Function Of App Control:



- To ensure safety, the app control function is only allowed within 10 minutes of closing the oven door in standby mode. After manually or remotely starting the microwave oven, you can continue to use the app control function to modify the parameters.

RECIPES

The Recipes page displays cloud recipes, cooking parameters have been verified by professional chefs. Recipe page is continuously being updated to provide more cooking variety.

- 1 Tap the recipe picture to enter the recipe details page.

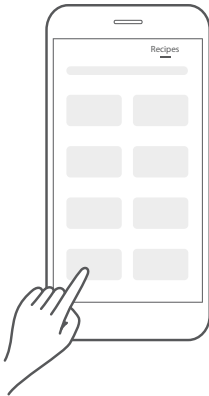

- 2 Swipe up and down to view the required ingredients and detailed cooking steps. Tap "Cook Now" to start cooking.

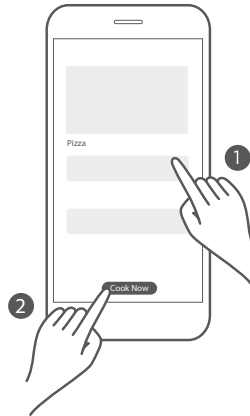

CLEANING AND MAINTENANCE

CLEANING

With good care and cleaning, your appliance will retain its appearance and remain fully functioning for a long time to come. Here are the instructions on how to properly care for the microwave oven.



WARNING

- Scratched glass in the appliance door may develop into a crack. Do not use a glass scraper, sharp or abrasive cleaning aids or detergents.
- The surface of the appliance may become damaged if it is not cleaned properly. Microwave energy may escape. Clean the appliance on a regular basis, and remove any food remnants immediately.
- Do not immerse the appliance in water or clean under a jet of water.

Cleaning agent

To ensure that the different surfaces are not damaged by using the wrong cleaning agent, see the information in the table. Wash new sponge or cloth thoroughly before use.

Do not use:



Harsh or abrasive cleaning agents



Metal or glass scrapers to clean the door panels

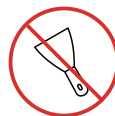

Metal or glass scrapers to clean the door seal



Hard scouring pads or sponges



Cleaning agents with a high alcohol content

APPLIANCE FRONT

Hot soapy water:

Clean using a dish cloth and then dry with a soft cloth. Do not use metal or glass scrapers for cleaning.

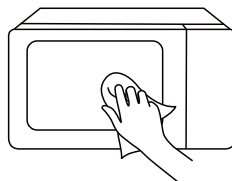

APPLIANCE FRONT WITH STAINLESS STEEL

Hot soapy water:

Clean using a dish cloth and then dry with a soft cloth. Remove splashes and patches of limescale, grease, starch and albumin immediately. Corrosion can form under these patches or splashes. Do not use glass cleaners or metal or glass scrapers for cleaning.

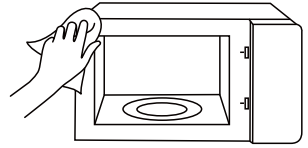

COOKING COMPARTMENT MADE OF STAINLESS STEEL

Hot soapy water or vinegar solution:

Clean using a dish cloth and then dry with a soft cloth. Do not use oven spray or any other aggressive oven cleaners or abrasive materials. Scouring pads, rough sponges and pan cleaners are also unsuitable. These items scratch the surface. Allow the interior surfaces to dry completely.

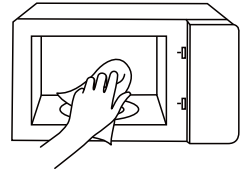

RECESS IN THE COOKING COMPARTMENT

Damp cloth:

Water must not be allowed to run into the appliance through the turntable drive. Dry the turntable drive with a cloth.

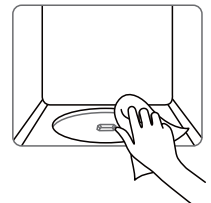

TURNTABLE AND ROLLER RING

Hot soapy water:

When placing the turntable back into its recess, it must engage properly.

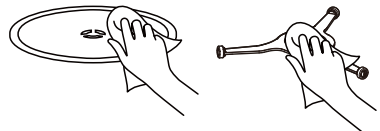

DOOR PANELS

Glass cleaner:

Clean with a dish cloth. Do not use glass scrapers.

TROUBLE SHOOTING

Normal	
Microwave oven interfering TV reception	Radio and TV reception may be interfered when microwave oven operating. It is similar to the interference of small electrical appliances, like mixer, vacuum cleaner, and electric fan. It is normal.
Dim oven light	In low power microwave cooking, oven light may become dim. It is normal.
Steam accumulating on door, hot air out of vents	In cooking, steam may come out of food. Most will get out from vents. But some may accumulate on cool place like oven door. It is normal.
Oven started accidentally with no food in.	It is forbidden to run the unit without any food inside. It is very dangerous.

Trouble	Possible Cause	Remedy
Oven cannot be started.	(1) Power cord is not plugged in tightly.	Unplug. Then plug again after 10 seconds.
	(2) Fuse blowing or circuit breaker works.	Replace fuse or reset circuit breaker (repaired by professional personnel of our company)
	(3) Trouble with outlet.	Test outlet with other electrical appliances.
Oven does not heat.	(4) Door is not closed well.	Close door well.



According to Waste of Electrical and Electronic Equipment (WEEE) directive, WEEE should be separately collected and treated. If at any time in future you need to dispose of this product please do NOT dispose of this product with household waste. Please send this product to WEEE collecting points where available.

#DetailsMatter

For more information
TOSHIBA CONTACT CENTER 0-2511-7777
www.toshiba-lifestyle.com/th

