

INSTRUCTION MANUAL

MICROWAVE OVEN

MW3-EM20PE(BK)

Please review this instruction manual before operating.

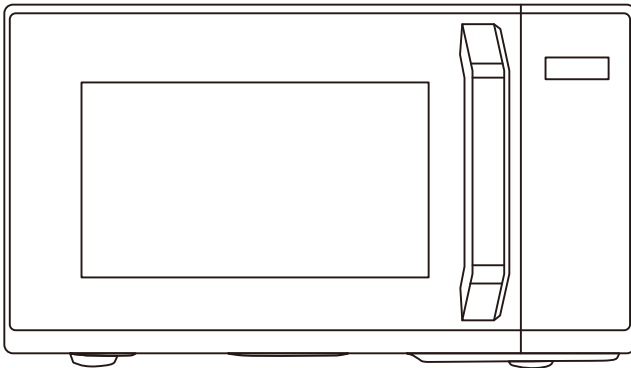

TOSHIBA

CONTENTS

PRODUCT SAFETY

Precautions to avoid possible exposure to excessive microwave energy	EN-01
Specifications	EN-02
Important safety instructions	EN-03
To reduce the risk of injury to persons grounding installation.....	EN-07
Cleaning.....	EN-09
Utensils.....	EN-10
Materials you can use in microwave oven	EN-11
Materials can not be used in microwave oven	EN-13

PRODUCT SETTING

Setting up your oven	EN-14
----------------------------	-------

INSTRUCTION FOR USE

Before using for the first time	EN-17
Operation	EN-18
1. Power levels	EN-19
2. Setting the clock.....	EN-19
3. Kitchen timer.....	EN-20
4. Microwave cooking	EN-20
5. Weight defrost	EN-21
6. Time defrost	EN-22
7. Multi-stage cooking	EN-22
8. Memory function	EN-24
9. Speedy cooking	EN-25
10. Inquiring function.....	EN-25

11. Lock function EN-26
12. Eco function EN-26
13. Mute function EN-26
14. Auto menu EN-27

CLEANING AND MAINTENANCE

Cleaning..... EN-28
Trouble shooting EN-30
Two year limited warranty..... EN-31



BEFORE OPERATING THIS PRODUCT, READ,
UNDERSTAND, AND FOLLOW THESE INSTRUCTIONS.
BE SURE TO SAVE THIS BOOKLIST FOR FUTURE
REFERENCE.

■ PRODUCT SAFETY

PRECAUTIONS TO AVOID POSSIBLE EXPOSURE TO EXCESSIVE MICROWAVE ENERGY

- (a). Do not attempt to operate this oven with the door open since this can result in harmful exposure to microwave energy. It is important not to break or tamper with the safety interlocks.
- (b). Do not place any object between the oven front face and the door or allow soil or cleaner residue to accumulate on sealing surfaces.
- (c). **WARNING:** If the door or door seals are damaged, the oven must not be operated until it has been repaired by a competent person.

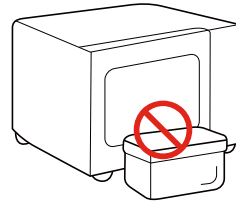

ADDENDUM

If the apparatus is not maintained in a good state of cleanliness, its surface could be degraded and affect the lifespan of the apparatus and lead to a dangerous situation.

SPECIFICATIONS

MODEL	MW3-EM20PE(BK)
VOLTAGE FREQUENCY	230 V ~50 Hz
MICROWAVE RATED POWER INPUT	1270 W
MICROWAVE RATED POWER OUTPUT	800 W

IMPORTANT SAFETY INSTRUCTIONS



WARNING

To reduce the risk of fire, electric shock, injury to persons or exposure to excessive microwave oven energy when using your appliance, follow basic precautions, including the following:



Read and follow the specific: "**PRECAUTIONS TO AVOID POSSIBLE EXPOSURE TO EXCESSIVE MICROWAVE ENERGY**".



This appliance is not intended for use by persons (including children) with reduced physical, sensory or mental capabilities, or lack of experience and knowledge, unless they have been given supervision or instruction concerning use of the appliance by a person responsible for their safety.



Children should be supervised to ensure that they do not play with the appliance.



If the supply cord is damaged, it must be replaced by the manufacturer, its service agent or similarly qualified persons in order to avoid a hazard.





WARNING: Ensure that the appliance is switched off before replacing the lamp to avoid the possibility of electric shock.



WARNING: Children are allowed to use the microwave oven alone only when accompanied by an adult to give instructions and explain the correct and safe use and the dangers that may arise if used incorrectly.

IMPORTANT SAFETY INSTRUCTIONS

 **WARNING:** It is hazardous for anyone other than a competent person to carry out any service or repair operation that involves the removal of a cover which gives protection against exposure to microwave energy.

 **WARNING:** Liquids and other foods must not be heated in sealed containers since they are liable to explode.

 When heating food in plastic or paper containers, keep an eye on the oven due to the possibility of ignition.

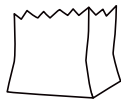

 Only use utensils that are suitable for use in microwave ovens.

 If smoke is emitted, switch off or unplug the appliance and keep the door closed in order to stifle any flames.

 Microwave heating of beverages can result in delayed eruptive boiling, therefore care must be taken when handling the container.

 The contents of feeding bottles and baby food jars shall be stirred or shaken and the temperature checked before consumption, in order to avoid burns.

 Failure to maintain the oven in a clean condition could lead to deterioration of the surface that could adversely affect the life of the appliance and possibly result in a hazardous situation.

IMPORTANT SAFETY INSTRUCTIONS

 The oven should be cleaned regularly and any food deposits removed. Please keep the waveguide area clean. Use soft damp cloth to clean it up when there is food splash residue on the waveguide area or the cavity. Failure to clean food residue may cause innocuous sparking or some smoke in the microwave cavity, discoloration of the cavity may also occur.

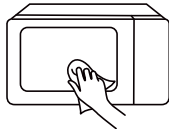

 Only use the temperature probe recommended for this oven. (for ovens provided with a facility to use a temperature-sensing probe.)

 The surface temperature may be high when this appliance is in use.

 The microwave oven must be operated with the decorative door open. (for ovens with a decorative door.)

 This appliance is intended to be used in household and similar applications such as:

1. staff kitchen areas in shops, offices and other working environments;
2. by clients in hotels, motels and other residential type environments;
3. farm houses;
4. bed and breakfast type environments.

 The microwave oven is intended for heating food and beverages. Drying of food or clothing and heating of warming pads, slippers, sponges, damp cloth and similar may lead to risk of injury, ignition or fire.

IMPORTANT SAFETY INSTRUCTIONS

 The appliance is intended to be used freestanding.

 The rear surface of appliances shall be placed against a wall.

 Eggs in their shell and whole hard-boiled eggs should not be heated in microwave ovens since they may explode, even after microwave heating has ended.

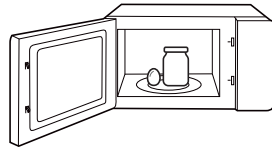



 The appliance must not be installed behind a decorative door in order to avoid overheating. (This is not applicable for appliances with decorative door.)

 The microwave oven shall not be placed in a cabinet unless it has been tested in a cabinet.

 Metallic containers for food and beverages are not allowed during microwave cooking.

 The appliance shall not be cleaned with a steam cleaner.

 This appliance should be set apart from other appliances.

 This appliance is not designed to be operated by an external timer or a separate remote control system.

**READ CAREFULLY AND KEEP FOR
FUTURE REFERENCE**

TO REDUCE THE RISK OF INJURY TO PERSONS GROUNDING INSTALLATION

This appliance must be grounded. In the event of an electrical short circuit, grounding reduces the risk of electric shock by providing an escape wire for the electric current.

This appliance is equipped with a cord having a grounding wire with a grounding plug. The plug must be plugged into an outlet that is properly installed and grounded.

WARNING - Improper use of the grounding can result in a risk of electric shock. Consult a qualified electrician or serviceman if the grounding instructions are not completely understood or if doubt exists as to whether the appliance is properly grounded.

If it is necessary to use an extension cord, use only a 3-wire extension cord.



Electric Shock Hazard:

Touching some of the internal components can cause serious personal injury or death. Do not disassemble this appliance.

TO REDUCE THE RISK OF INJURY TO PERSONS GROUNDING INSTALLATION



Electric Shock Hazard:

Improper use of the grounding can result in electric shock. Do not plug into an outlet until appliance is properly installed and grounded.

1. A short power-supply cord is provided to reduce the risks resulting from becoming entangled in or tripping over a longer cord.
2. If a long cord or extension cord is used:
 - (1). The marked electrical rating of the cord set or extension cord should be at least as great as the electrical rating of the appliance.
 - (2). The extension cord must be a grounding-type 3-wire cord.
 - (3). The longer cord should be arranged so that it will not drape over the counter top or tabletop where it can be pulled on by children or tripped over unintentionally.

CLEANING

Be sure to unplug the appliance from the power supply.

1. Clean the cavity of the oven after using with a slightly damp cloth.
2. Clean the accessories in the usual way in soapy water.
3. The door frame and seal and neighbouring parts must be cleaned carefully with a damp cloth when they are dirty.
4. Do not use harsh abrasive cleaners or sharp metal scrapers to clean the oven door glass since they can scratch the surface, which may result in shattering of the glass.
5. Cleaning Tip---For easier cleaning of the cavity walls that the food cooked can touch: Place half a lemon in a bowl, add 300ml (1/2 pint) water and heat on 100% microwave power for 10 minutes. Wipe the oven clean using a soft, dry cloth.

UTENSILS



CAUTION

Personal Injury Hazard:

It is hazardous for anyone other than a competent person to carry out any service or repair operation that involves the removal of a cover which gives protection against exposure to microwave energy. See the instructions on "**Materials you can use in microwave oven**" or "**Materials can not be used in microwave oven**".

There may be certain non-metallic utensils that are not safe to use for microwaving. If in doubt, you can test the utensil in question following the procedure below.

Utensil Test:

1. Fill a microwave-safe container with 1 cup of cold water (250ml) along with the utensil in question.
2. Cook on maximum power for 1 min.
3. Carefully feel the utensil. If the empty utensil is warm, do not use it for microwave cooking.
4. Do not exceed 1 min cooking time.

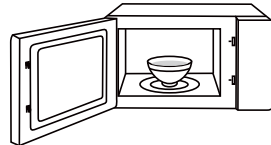





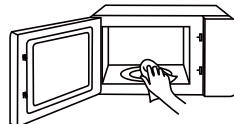











NOTE









KEEP THE CAVITY AND
WAVEGUIDE AREA CLEAN





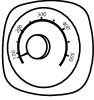







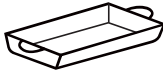



MATERIALS YOU CAN USE IN MICROWAVE OVEN

UTENSILS	REMARKS
 Browning dish	Follow manufacturer's instructions. The bottom of browning dish must be at least 3/16 inch (5mm) above the turntable. Incorrect usage may cause the turntable to break. 
 Dinnerware	Microwave-safe only. Follow manufacturer's instructions. Do not use cracked or chipped dishes. 
 Glass jars	Always remove lid. Use only to heat food until just warm. Most glass jars are not heat resistant and may break. 
 Glassware	Heat-resistant oven glassware only. Make sure there is no metallic trim. Do not use cracked or chipped dishes. 
 Oven cooking bags	Follow manufacturer's instructions. Do not close with metal tie. Make slits to allow steam to escape. 
 Paper plates and cups	Use for short-term cooking/warming only. Do not leave oven unattended while cooking. 
 Paper towels	Use to cover food for reheating and absorbing fat. Use with supervision for a short-term cooking only. 
 Parchment paper	Use as a cover to prevent splattering or a wrap for steaming. 

MATERIALS YOU CAN USE IN MICROWAVE OVEN

UTENSILS	REMARKS
 <p data-bbox="440 709 503 730">Plastic</p>	<p data-bbox="615 611 1162 751">Microwave-safe only. Follow the manufacturer's instructions. Should be labeled "Microwave Safe". Some plastic containers soften, as the food inside gets hot. "Boiling bags" and tightly closed plastic bags should be slit, pierced or vented as directed by package.</p> 
 <p data-bbox="412 892 531 913">Plastic wrap</p>	<p data-bbox="615 810 1162 890">Microwave-safe only. Use to cover food during cooking to retain moisture. Do not allow plastic wrap to touch food.</p> 
 <p data-bbox="396 1058 544 1079">Thermometers</p>	<p data-bbox="615 1003 1154 1024">Microwave-safe only (meat and candy thermometers).</p> 
 <p data-bbox="417 1213 524 1234">Wax paper</p>	<p data-bbox="615 1150 1084 1203">Use as a cover to prevent splattering and retain moisture.</p> 

MATERIALS CAN NOT BE USED IN MICROWAVE OVEN

UTENSILS	REMARKS	
 Aluminum tray	May cause arcing. Transfer food into microwave-safe dish.	
 Food carton with metal handle	May cause arcing. Transfer food into microwave-safe dish.	
 Metal or metal trimmed utensils	Metal shields the food from microwave energy. Metal trim may cause arcing.	
 Metal twist ties	May cause arcing and could cause a fire in the oven.	
 Paper bags	May cause a fire in the oven.	
 Plastic foam	Plastic foam may melt or contaminate the liquid inside when exposed to high temperature.	
 Wood	Wood will dry out when used in the microwave oven and may split or crack.	

PRODUCT SETTING ■

SETTING UP YOUR OVEN

(In case of any differences between the appliance and the pictures in this manual, the product shall prevail.)

NAMES OF MICROWAVE OVEN PARTS AND ACCESSORIES

Remove the oven and all materials from the carton and oven cavity.

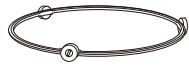

Turntable Ring Assembly

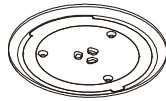

Glass turntable

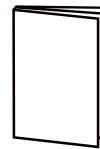

Instruction Manual

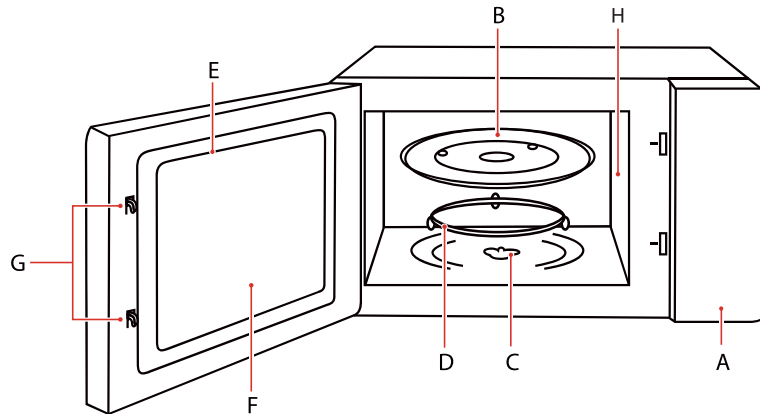

- | | |
|----------------------------|----------------------------|
| A. Control panel | E. Door assembly |
| B. Glass turntable | F. Observation window |
| C. Turntable shaft | G. Safety interlock system |
| D. Turntable ring assembly | H. Waveguide Cover |

SETTING UP YOUR OVEN

TURNTABLE INSTALLATION

Cleaning the cooking compartment and putting the turntable in place.

For new installations, make sure all packaging and shipping tape has been removed from the turntable shaft.

Before using the appliance to prepare food for the first time, you will need to put the turntable in place correctly. You must clean the cooking compartment and accessories.

How to put the turntable in place:

1. Place the turntable ring assembly ③ into the recess in the cooking compartment.
2. Place the glass turntable ① on the turntable ring assembly ③. Fit the raised, curved lines in the center of the glass turntable bottom between the three spokes of the shaft. Make sure that the glass turntable ① engages in the turntable shaft ② in the center of the cooking compartment floor. The rollers on the shaft should fit inside the turntable bottom ridge.

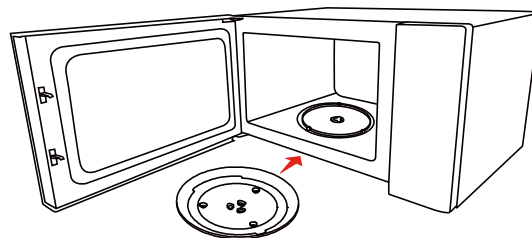
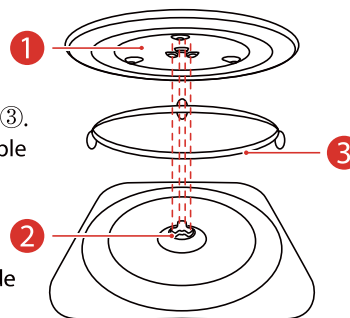

NOTE

- Never use the appliance without the turntable. Make sure that it is properly engaged. The turntable can turn clockwise or anti-clockwise.
- Never place the glass turntable upside down. The glass turntable should never be restricted.
- Both glass turntable and turntable ring assembly must always be used during cooking.
- All food and containers of food are always placed on the glass turntable for cooking.
- Never restrict the movement of the turntable.
- If glass turntable or turntable ring assembly cracks or breaks, contact your nearest authorized service center.

COUNTERTOP INSTALLATION

Remove all packing material and accessories. Examine the oven for any damage such as dents or broken door. Do not install if oven is damaged.

Cabinet: Remove any protective film found on the microwave oven cabinet surface. Do not remove the waveguide cover that is attached to the oven cavity to protect the magnetron.

INSTALLATION

1. Select a level surface that provide enough open space for the intake and/or outlet vents.
 - a. The minimum installation height is 85cm.
 - b. The rear surface of appliance shall be placed against a wall. Leave a minimum clearance of 30cm above the oven. A minimum clearance of 20cm is required between the oven and any adjacent walls.
 - c. Do not remove the legs from the bottom of the oven.
 - d. Blocking the intake and/or outlet openings can damage the oven.
 - e. Place the oven as far away from radios and TV as possible.

Operation of microwave oven may cause interference to your radio or TV reception.

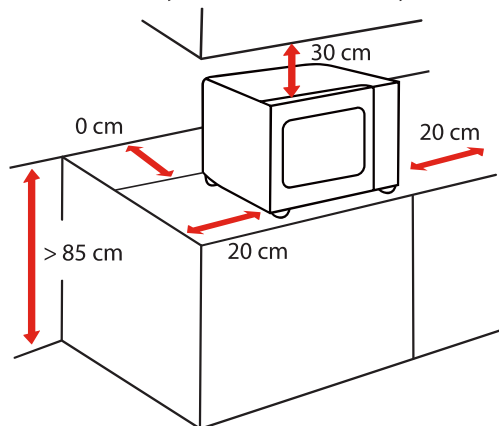

2. Plug microwave oven into a standard household outlet. Be sure the voltage and the frequency is the same as the voltage and the frequency on the rating label.



NOTE

- Do not install oven over a range cooktop or other heat-producing appliance. If installed near or over a heat source, the oven could be damaged and the warranty would be void.

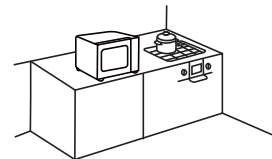

The accessible surface may be hot during operation

■ INSTRUCTION FOR USE

BEFORE USING FOR THE FIRST TIME

It is normal that the oven may produce unpleasant odors when it is used for the first time.

This section tells you what you need to do before using your microwave to prepare food for the first time. Read the section entitled "**PRODUCT SAFETY**" beforehand.

Before you can use your new appliance, you will need to put the turntable in place correctly. You must also clean the cooking compartment and accessories.



NOTE

- Never use the appliance without the turntable.
- Make sure that it is properly engaged. The turntable can turn clockwise or anti-clockwise.

OPERATION

CONTROL PANEL AND FEATURES

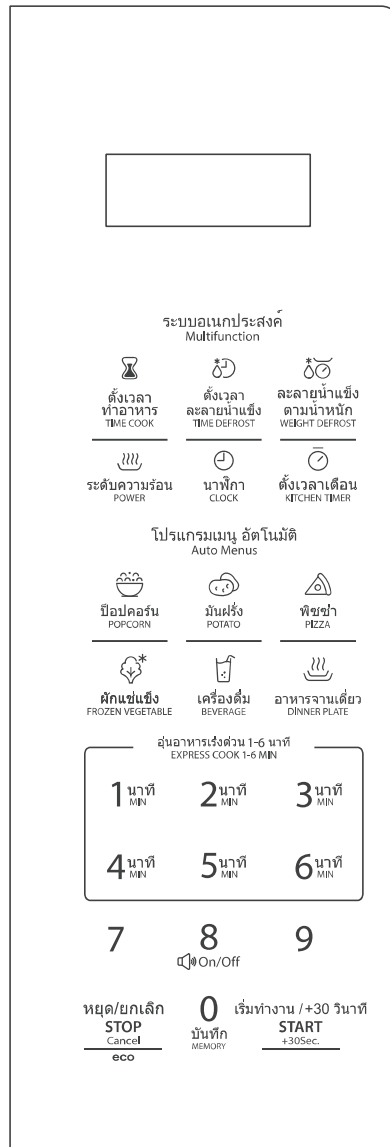

1. POWER LEVELS

11 power levels are available

PRESS NUMBER KEY	POWER	DISPLAY
1,0	100%	PL10
9	90%	PL9
8	80%	PL8
7	70%	PL7
6	60%	PL6
5	50%	PL5
4	40%	PL4
3	30%	PL3
2	20%	PL2
1	10%	PL1
0	0%	PL0

2. SETTING THE CLOCK

When the microwave oven is plugged into an outlet , "0:00" will display.

- a Press Clock once, 00:00 will appear on the display.



- b Press number keys to set the time, it should be within 1:00~12:59.
For example, press 1,2,0,5 to set the time to "12:05".



- c Press Clock to confirm.



NOTE

- In the process of setting clock, if the " ^{STOP} Cancel " pad is pressed or if there is no operation within 1 minute, the display will automatically return to the previous clock setting.

3. KITCHEN TIMER

When the microwave oven is plugged into an outlet, "0:00" will display.

- a Press Kitchen Timer once, 00:00 will appear on the display.



- b Press number keys to set the time, the maximum value is 99:99.



- c Press **START** +30Sec. to start counting down.



NOTE

• During the Kitchen Timer function, no cooking function can be set into operation.

4. MICROWAVE COOKING

- a Press Time Cook once, 00:00 will appear on the display.



- b Press number keys to set the time, the maximum value is 99:99.



- c Press Power once, PL10 will appear on the display.



d Press number keys to set the power level.



e Press **START** +30Sec. to start cooking.



5.WEIGHT DEFROST

a Press Weight Defrost once, "dEF1" will display



b Press number keys to set the defrost weight.
It should be within 100~2000 g.



c Press **START** +30Sec. to start defrosting.



6. TIME DEFROST

- a Press Time Defrost once, "dEF2" will display.



- b Press number keys to set the defrost time.
The maximum value is 99:99.



- c Press **START** +30Sec. to start defrosting.



- The default power level is PL3, it cannot be changed.

7. MULTI-STAGE COOKING

- a Press Time Defrost once, "dEF2" will display.



- b Press number keys to set the defrost time.
The maximum value is 99:99.



c Press **Time Cook** once, "00:00" will appear on the display.



d Press number keys to set the cooking time.



e Press **Power** once, PL10 will appear on the display.



f Press number keys to set the power level.



g Press **START** $+30\text{Sec.}$ to start cooking.



NOTE

- Two cooking stages can be set in multi-stage cooking.
- If you set the defrost function, it will work in the first stage.
- Auto menu can't be set as one of the multi-stage.

8. MEMORY FUNCTION

- a Press **MEMORY** to program and choose up to three cooking procedures. Each procedure will be indicated by 1, 2 or 3 in the display.



- b Press **START** +30Sec. to start cooking. Two cooking stages can be set for each procedure.



To program a procedure, follow the steps listed below.

Example: Cook food at 80% Power Level for 3 minutes and 20 seconds; save as memory 2.

- Press **MEMORY** twice; screen displays 2.



- Press **Time Cook** once, "00:00" displays.



- Press 3,2,0 to set the cooking time to 03:20.



- Press **Power** once, PL10 displays.



- Press 8 to set the power level to PL8.

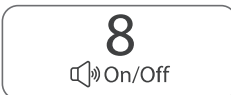

- Press **START** _{+30Sec.} to save the procedure.
Oven beeps once, screen will display "2".



- Press **START** _{+30Sec.} again to start the procedure.



NOTE

- Auto Menu can't be set in memory function.
- If the power is not cut off, the procedure will be saved all the time.

9. SPEEDY COOKING

- a In standby mode, press number keys "1-6" to start microwave cooking for "1-6" minutes with PL10 power level directly.



or

- b In standby mode, press **START** _{+30Sec.} to start cooking with PL10 power level for 30 seconds directly.



10. INQUIRING FUNCTION

- a When oven is cooking or in paused mode, press Clock, the current time will appear for three seconds in the display.



11. LOCK FUNCTION

To lock the microwave so that it can't be operated by children or other unintended users.

- a To lock, in standby mode, press **STOP** Cancel for 3 seconds, there will be a long beep,  will display denoting enter the locked state.



- b To unlock, in locked state, press **STOP** Cancel for 3 seconds, there will be a long beep denoting exit the locked state.



12. ECO FUNCTION

- a To enter ECO mode:
In standby mode, press **STOP** Cancel once, the screen will turn off.



- b To cancel ECO mode:
In ECO mode, press any key or open the door to cancel it.

13. MUTE MODE

To press any key without sound (the default mode is sound on).

- a To enter mute mode:
In standby mode, press **8** once, "OFF" will appear on the display denoting enter the mute mode.

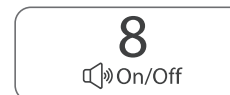

- b To exit mute mode:
In mute mode, press **8** once, the buzzer sound once, "on" will appear on the display.

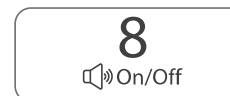

14. AUTO MENU

- a Press the desired menu key repeatedly to set the weight of it.
For example, press POPCORN twice to cook the popcorn for 100 g.



- c Press **START** +30Sec. to start cooking.



AUTO MENU CHART

MENU	DISPLAY	WEIGHT/ PORTION
Popcorn	50	50g
	100	100g
Potato	1	1
	2	2
	3	3
Pizza	100	100g
	200	200g
	400	400g
Frozen vegetable	150	150g
	350	350g
	500	500g
Beverage	1	1cup
	2	2cups
	3	3cups
Dinner Plate	250	250g
	350	350g
	500	500g

CLEANING AND MAINTENANCE ■

CLEANING

With good care and cleaning, your appliance will retain its appearance and remain fully functioning for a long time to come. We will explain here how you should correctly care for and clean your appliance.



- Scratched glass in the appliance door may develop into a crack. Do not use a glass scraper, sharp or abrasive cleaning aids or detergents.
- The surface of the appliance may become damaged if it is not cleaned properly. Microwave energy may escape. Clean the appliance on a regular basis, and remove any food remnants immediately.
- Do not immerse the appliance in water or clean under a jet of water.

Cleaning agent

To ensure that the different surfaces are not damaged by using the wrong cleaning agent, observe the information in the table. Wash new sponge cloths thoroughly before use.

Do not use:



Harsh or abrasive cleaning agents



Metal or glass scrapers to clean the door panels



Metal or glass scrapers to clean the door seal



Hard scouring pads or sponges



Cleaning agents with a high alcohol content

APPLIANCE FRONT

Hot soapy water:

Clean using a dish cloth and then dry with a soft cloth. Do not use metal or glass scrapers for cleaning.

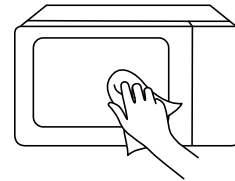

APPLIANCE FRONT WITH STAINLESS STEEL

Hot soapy water:

Clean using a dish cloth and then dry with a soft cloth. Remove splashes and patches of limescale, grease, starch and albumin immediately. Corrosion can form under these patches or splashes. Do not use glass cleaners or metal or glass scrapers for cleaning.

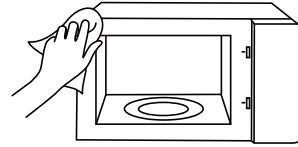

COOKING COMPARTMENT MADE OF STAINLESS STEEL

Hot soapy water or vinegar solution:

Clean using a dish cloth and then dry with a soft cloth. Do not use oven spray or any other aggressive oven cleaners or abrasive materials. Scouring pads, rough sponges and pan cleaners are also unsuitable. These items scratch the surface. Allow the interior surfaces to dry completely.

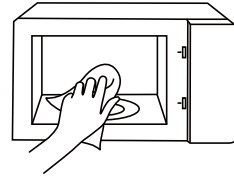

RECESS IN THE COOKING COMPARTMENT

Damp cloth:

Water must not be allowed to run into the appliance through the turntable drive. Dry the turntable drive with a cloth.

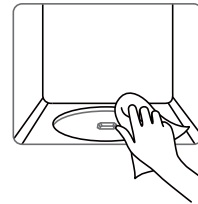

TURNTABLE AND ROLLER RING

Hot soapy water:

When placing the turntable back into its recess, it must engage properly.

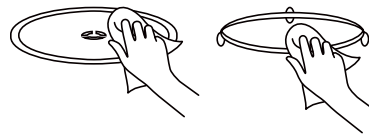

DOOR PANELS

Glass cleaner:

Clean with a dish cloth. Do not use glass scrapers.

TROUBLE SHOOTING

Normal	
Microwave oven interfering TV reception	Radio and TV reception may be interfered when microwave oven operating. It is similar to the interference of small electrical appliances, like mixer, vacuum cleaner, and electric fan. It is normal.
Dim oven light	In low power microwave cooking, oven light may become dim. It is normal.
Steam accumulating on door, hot air out of vents	In cooking, steam may come out of food. Most will get out from vents. But some may accumulate on cool place like oven door. It is normal.
Oven started accidentally with no food in.	It is forbidden to run the unit without any food inside. It is very dangerous.

Trouble	Possible Cause	Remedy
Oven cannot be started.	(1) Power cord is not plugged in tightly.	Unplug. Then plug again after 10 seconds.
	(2) Fuse blowing or circuit breaker works.	Replace fuse or reset circuit breaker (repaired by professional personnel of our company)
	(3) Trouble with outlet.	Test outlet with other electrical appliances.
Oven does not heat.	(4) Door is not closed well.	Close door well.

TWO YEAR LIMITED WARRANTY

This product carries a warranty stating that it will be free from defects in material and workmanship for a period of two year from the date of purchase. This warranty is valid for the original retail purchaser from the date of initial retail purchase and is not transferable. Keep your original sales receipt.

IMPORTANT:

1. This warranty does not cover damages resulting from accident, misuse or abuse, lack of reasonable care, the affixing of any attachments not provided with the product, loss of parts, or subjecting the appliance to any but the specified voltage. (Read directions carefully.)
2. This warranty is void if this product is ever used for other than private household purposes.
3. This warranty is void if this product is ever used outside of Thailand.

If service is required during the warranty period, properly pack your unit. We recommend using the original carton and packing materials.

If additional assistance is needed, please contact customer assistance at:

Service@ttc.toshiba.co.th
02-511-7777

Model Number : _____

Serial Number : _____

Product registration is not mandatory. Failure to complete and return the card or form does not diminish the consumer' s warranty rights.

SAVE THIS FOR YOUR RECORDS

Made in China

#DetailsMatter