

# INSTRUCTION MANUAL

## MICROWAVE OVEN

MM-EM25PE(BM)

Please review this instruction manual before operating.

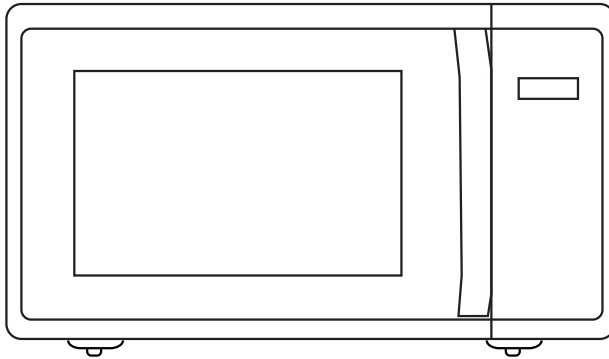

**TOSHIBA**

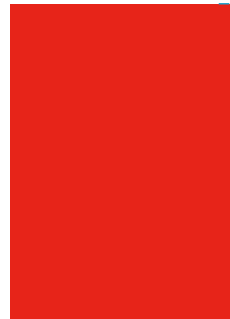

# CONTENTS

## PRODUCT SAFETY

Precautions to avoid possible exposure to excessive microwave energy .....	EN-01
Important safety instructions .....	EN-03
To reduce the risk of injury to persons grounding installation.....	EN-07
Cleaning .....	EN-09
Utensils.....	EN-10
Materials you can use in microwave oven .....	EN-11
Materials can not be used in microwave oven .....	EN-13

## PRODUCT SETTING

Setting up your oven .....	EN-14
----------------------------	-------

## INSTRUCTION FOR USE

Before using for the first time .....	EN-18
Operation .....	EN-19
1. Microwave power level* .....	EN-20
2. Clock setting.....	EN-20
3. Kitchen timer.....	EN-21
4. Microwave cooking .....	EN-21
5. Express cook.....	EN-23
6. Weight defrost function.....	EN-23
7. Time defrost function.....	EN-24
8. Auto menu function - popcorn .....	EN-24

9. Auto menu function - potato.....	EN-25
10. Auto menu function - frozen vegetable.....	EN-25
11. Auto menu function - beverage.....	EN-25
12. Auto menu function - dinner plate.....	EN-25
13. Auto menu function - pizza.....	EN-26
14. Multi-stage cooking.....	EN-26
15. Lock function for children.....	EN-27
16. Memory function.....	EN-27
17. Inquiring function.....	EN-28
18. Cooking end reminding function.....	EN-28
19. Other specifications.....	EN-28
Cleaning.....	EN-29

## MAINTENANCE

Trouble shooting.....	EN-31
-----------------------	-------



**NOTE**

BEFORE OPERATING THIS PRODUCT, READ, UNDERSTAND, AND FOLLOW THESE INSTRUCTIONS. BE SURE TO SAVE THIS BOOKLIST FOR FUTURE REFERENCE.

## PRODUCT SAFETY

### PRECAUTIONS TO AVOID POSSIBLE EXPOSURE TO EXCESSIVE MICROWAVE ENERGY

---

- (a). Do not attempt to operate this oven with the door open since open door operation can result in harmful exposure to microwave energy.  
It is important not to defeat or tamper with the safety interlocks.

- (b). Do not place any object between the oven front face and the door or allow soil or cleaner residue to accumulate on sealing surfaces.

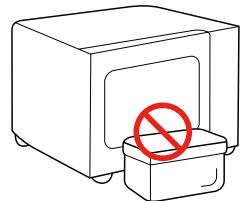

- (c). **WARNING:** If the door or door seals are damaged, the oven must not be operated until it has been repaired by a competent person.

#### ADDENDUM

---

If the apparatus is not maintained in a good state of cleanliness, its surface could be degraded and affect the life span of the apparatus and lead to a dangerous situation.

## SPECIFICATIONS

---

Model	MM-EM25PE(BM)
Voltage Frequency	220V~ 50Hz
Microwave Input Power	1250W
Microwave Output Power	800W



### NOTE

All pictures in this manual are for illustrative purposes only; these may be slightly different from the purchased equipment, please refer to the actual product.

# IMPORTANT SAFETY INSTRUCTIONS



## WARNING

To reduce the risk of fire, electric shock, injury to persons or exposure to excessive microwave oven energy when using your appliance, follow basic precautions, including the following:



Read and follow the specific: "**PRECAUTIONS TO AVOID POSSIBLE EXPOSURE TO EXCESSIVE MICROWAVE ENERGY**".



This appliance is not intended for use by persons (including children) with reduced physical, sensory or mental capabilities, or lack of experience and knowledge, unless they have been given supervision or instruction concerning use of the appliance by a person responsible for their safety.



Children should be supervised to ensure that they do not play with the appliance.

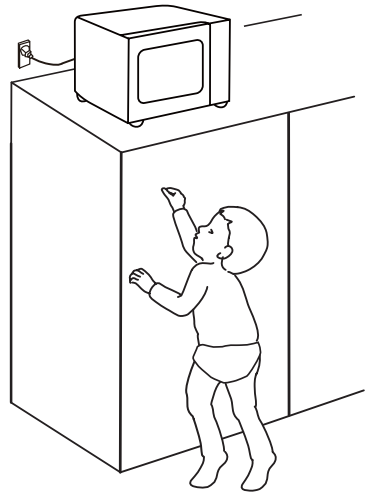

# IMPORTANT SAFETY INSTRUCTIONS

 If the supply cord is damaged, it must be replaced by the manufacturer, its service agent or similarly qualified persons in order to avoid a hazard.

---

 **WARNING:** Ensure that the appliance is switched off before replacing the lamp to avoid the possibility of electric shock.

---

 **WARNING:** It is hazardous for anyone other than a competent person to carry out any service or repair operation that involves the removal of a cover which gives protection against exposure to microwave energy.

---

 **WARNING:** Liquids and other foods must not be heated in sealed containers since they are liable to explode.

 When heating food in plastic or paper containers, keep an eye on the oven due to the possibility of ignition.



 Only use utensils that are suitable for use in microwave ovens.

---

 If smoke is emitted, switch off or unplug the appliance and keep the door closed in order to stifle any flames.

---

 Microwave heating of beverages can result in delayed eruptive boiling, therefore care must be taken when handling the container.

---

 The contents of feeding bottles and baby food jars shall be stirred or shaken and the temperature

# IMPORTANT SAFETY INSTRUCTIONS

checked before consumption, in order to avoid burns.

 The oven should be cleaned regularly and any food deposits removed. Please keep the waveguide area clean. Use soft damp cloth to clean it up when there is food splash residue on the waveguide area or the cavity. Failure to clean food residue may cause innocuous sparking or some smoke in the microwave cavity, discoloration of the cavity may also occur.

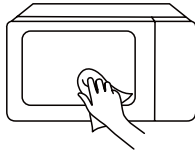

 Failure to maintain the oven in a clean condition could lead to deterioration of the surface that could adversely affect the life of the appliance and possibly result in a hazardous situation.

 Only use the temperature probe recommended for this oven. (for ovens provided with a facility to use a temperature-sensing probe.)

 The microwave oven must be operated with the decorative door open. (for ovens with a decorative door.)

 This appliance is intended to be used in household and similar applications such as:

1. staff kitchen areas in shops, offices and other working environments;
2. by clients in hotels, motels and other residential type environments;
3. farm houses;
4. bed and breakfast type environments.

# IMPORTANT SAFETY INSTRUCTIONS

 The microwave oven is intended for heating food and beverages. Drying of food or clothing and heating of warming pads, slippers, sponges, damp cloth and similar may lead to risk of injury, ignition or fire.

---

 The appliance is intended to be used freestanding.

---

 The rear surface of appliances shall be placed against a wall.

---

 Eggs in their shell and whole hard-boiled eggs should not be heated in microwave ovens since they may explode, even after microwave heating has ended.

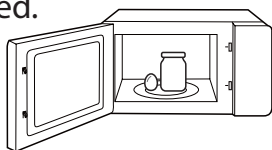

 The appliance must not be installed behind a decorative door in order to avoid overheating. (This is not applicable for appliances with decorative door.)

---

 The microwave oven shall not be placed in a cabinet unless it has been tested in a cabinet.

---

 Metallic containers for food and beverages are not allowed during microwave cooking.

---

 The appliance shall not be cleaned with a steam cleaner.

READ CAREFULLY AND KEEP FOR  
FUTURE REFERENCE

# TO REDUCE THE RISK OF INJURY TO PERSONS GROUNDING INSTALLATION

This appliance must be grounded. In the event of an electrical short circuit, grounding reduces the risk of electric shock by providing an escape wire for the electric current.

This appliance is equipped with a cord having a grounding wire with a grounding plug. The plug must be plugged into an outlet that is properly installed and grounded.

**WARNING** - Improper use of the grounding can result in a risk of electric shock. Consult a qualified electrician or serviceman if the grounding instructions are not completely understood or if doubt exists as to whether the appliance is properly grounded.

If it is necessary to use an extension cord, use only a 3-wire extension cord.



**DANGER**

Electric Shock Hazard:

Touching some of the internal components can cause serious personal injury or death. Do not disassemble this appliance.

# TO REDUCE THE RISK OF INJURY TO PERSONS GROUNDING INSTALLATION



**WARNING**

## Electric Shock Hazard:

Improper use of the grounding can result in electric shock. Do not plug into an outlet until appliance is properly installed and grounded.

1. A short power-supply cord is provided to reduce the risks resulting from becoming entangled in or tripping over a longer cord.
2. If a long cord or extension cord is used:
  - (1). The marked electrical rating of the cord set or extension cord should be at least as great as the electrical rating of the appliance.
  - (2). The extension cord must be a grounding-type 3-wire cord.
  - (3). The longer cord should be arranged so that it will not drape over the counter top or tabletop where it can be pulled on by children or tripped over unintentionally.

# CLEANING

Be sure to unplug the appliance from the power supply.

1. Clean the cavity of the oven after using with a slightly damp cloth.
2. Clean the accessories in the usual way in soapy water.
3. The door frame and seal and neighbouring parts must be cleaned carefully with a damp cloth when they are dirty.
4. Do not use harsh abrasive cleaners or sharp metal scrapers to clean the oven door glass since they can scratch the surface, which may result in shattering of the glass.
5. Cleaning Tip---For easier cleaning of the cavity walls that the food cooked can touch: Place half a lemon in a bowl, add 300ml (1/2 pint) water and heat on 100% microwave power for 10 minutes. Wipe the oven clean using a soft, dry cloth.

# UTENSILS



## CAUTION

### Personal Injury Hazard:

It is hazardous for anyone other than a competent person to carry out any service or repair operation that involves the removal of a cover which gives protection against exposure to microwave energy.

See the instructions on "**Materials you can use in microwave oven**" or "**Materials can not be used in microwave oven**"

There may be certain non-metallic utensils that are not safe to use for microwaving. If in doubt, you can test the utensil in question following the procedure below.

### Utensil Test:

1. Fill a microwave-safe container with 1 cup of cold water (250ml) along with the utensil in question.
2. Cook on maximum power for 1 min.
3. Carefully feel the utensil. If the empty utensil is warm, do not use it for microwave cooking.
4. Do not exceed 1 min cooking time.

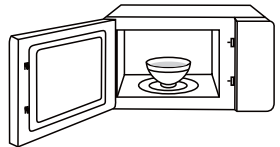





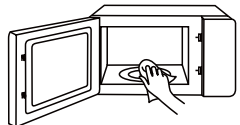











## NOTE









KEEP THE CAVITY AND WAVEGUIDE AREA CLEAN

















# MATERIALS YOU CAN USE IN MICROWAVE OVEN

UTENSILS	REMARKS
 Browning dish	Follow manufacturer's instructions. The bottom of browning dish must be at least 3/16 inch (5mm) above the turntable. Incorrect usage may cause the turntable to break. 
 Dinnerware	Microwave-safe only. Follow manufacturer's instructions. Do not use cracked or chipped dishes. 
 Glass jars	Always remove lid. Use only to heat food until just warm. Most glass jars are not heat resistant and may break. 
 Glassware	Heat-resistant oven glassware only. Make sure there is no metallic trim. Do not use cracked or chipped dishes. 
 Oven cooking bags	Follow manufacturer's instructions. Do not close with metal tie. Make slits to allow steam to escape. 
 Paper plates and cups	Use for short-term cooking/warming only. Do not leave oven unattended while cooking. 
 Paper towels	Use to cover food for reheating and absorbing fat. Use with supervision for a short-term cooking only. 
 Parchment paper	Use as a cover to prevent splattering or a wrap for steaming. 

# MATERIALS YOU CAN USE IN MICROWAVE OVEN

UTENSILS	REMARKS
 <p data-bbox="169 454 240 478">Plastic</p>	<p data-bbox="349 359 900 494">Microwave-safe only. Follow the manufacturer's instructions. Should be labeled "Microwave Safe". Some plastic containers soften, as the food inside gets hot. "Boiling bags" and tightly closed plastic bags should be slit, pierced or vented as directed by package.</p> 
 <p data-bbox="147 638 262 662">Plastic wrap</p>	<p data-bbox="349 558 900 638">Microwave-safe only. Use to cover food during cooking to retain moisture. Do not allow plastic wrap to touch food.</p> 
 <p data-bbox="131 805 278 829">Thermometers</p>	<p data-bbox="349 750 889 774">Microwave-safe only (meat and candy thermometers).</p> 
 <p data-bbox="152 965 256 989">Wax paper</p>	<p data-bbox="349 901 819 949">Use as a cover to prevent splattering and retain moisture.</p> 

# MATERIALS CAN NOT BE USED IN MICROWAVE OVEN

UTENSILS	REMARKS
 <p>Aluminum tray</p>	May cause arcing. Transfer food into microwave-safe dish. 
 <p>Food carton with metal handle</p>	May cause arcing. Transfer food into microwave-safe dish. 
 <p>Metal or metal trimmed utensils</p>	Metal shields the food from microwave energy. Metal trim may cause arcing. 
 <p>Metal twist ties</p>	May cause arcing and could cause a fire in the oven. 
 <p>Paper bags</p>	May cause a fire in the oven. 
 <p>Plastic foam</p>	Plastic foam may melt or contaminate the liquid inside when exposed to high temperature. 
 <p>Wood</p>	Wood will dry out when used in the microwave oven and may split or crack. 

## SETTING UP YOUR OVEN

### NAMES OF MICROWAVE OVEN PARTS AND ACCESSORIES

Remove the oven and all materials from the carton and oven cavity.

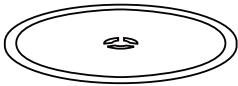

**Glass Tray**

(Can be used under all functions)

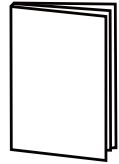

**Instruction Manual**

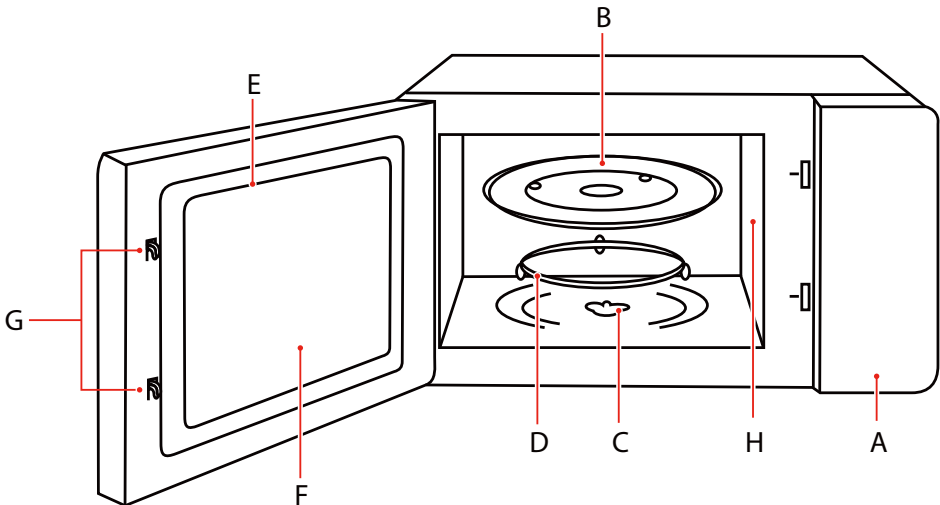

A. Control panel

B. Glass tray

C. Turntable shaft

D. Turntable ring assembly

E. Door assembly

F. Observation window

G. Safety interlock system

H. Waveguide cover

# SETTING UP YOUR OVEN

## TURNTABLE INSTALLATION

Cleaning the cooking compartment and putting the turntable in place.

For new installations, make sure all packaging and shipping tape has been removed from the turntable shaft.

Before using the appliance to prepare food for the first time, you will need to put the turntable in place correctly. You must clean the cooking compartment and accessories.

How to put the turntable in place:

1. Place the turntable ring assembly ③ into the recess in the cooking compartment.

2. Place the glass tray ① on the turntable ring assemblies ③.

Fit the raised, curved lines in the center of the glass tray bottom between the three spokes of the shaft. Make sure that the glass tray ① engages in the turntable shaft ② in the center of the cooking compartment floor. The rollers on the shaft should fit inside the turntable bottom ridge.

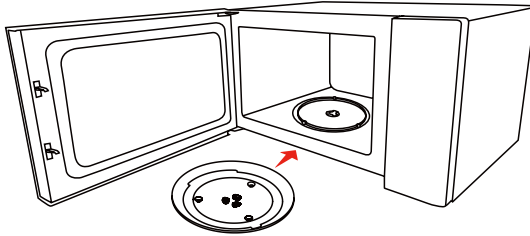
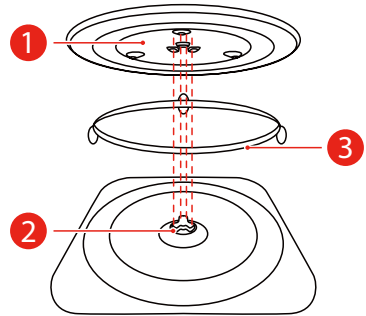

### NOTE

- Never use the appliance without the turntable. Make sure that it is properly engaged. The turntable can turn clockwise or anti-clockwise.
- Never place the glass tray upside down. The glass tray should never be restricted.
- Both glass tray and turntable ring assembly must always be used during cooking.
- All food and containers of food are always placed on the glass tray for cooking.
- Never restrict the movement of the turntable.
- If glass tray or turntable ring assembly cracks or breaks, contact your nearest authorized service center.

# SETTING UP YOUR OVEN

## COUNTERTOP INSTALLATION

Remove all packing material and accessories. Examine the oven for any damage such as dents or broken door. Do not install if oven is damaged.

Cabinet: Remove any protective film found on the microwave oven cabinet surface. Do not remove the **waveguide cover** that is attached to the oven cavity to protect the magnetron.

## INSTALLATION

1. Select a level surface that provide enough open space for the intake and/or outlet vents.
  - a. The minimum installation height is 85cm.
  - b. The rear surface of appliance shall be placed against a wall. Leave a minimum clearance of 30cm above the oven. A minimum clearance of 20cm is required between the oven and any adjacent walls.
  - c. Do not remove the legs from the bottom of the oven.
  - d. Blocking the intake and/or outlet openings can damage the oven.
  - e. Place the oven as far away from radios and TV as possible.

Operation of microwave oven may cause interference to your radio or TV reception.

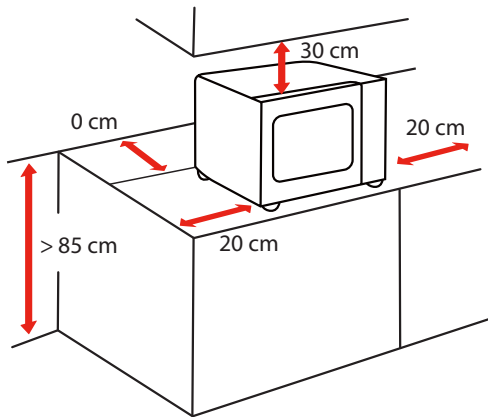

SIDE	DISTANCE (CM)
Top	30cm
Left	20cm
Right	20cm
Behind	0cm
Front	Open

# SETTING UP YOUR OVEN

2. Plug your oven into a standard household outlet. Be sure the voltage and the frequency is the same as the voltage and the frequency on the rating label.



**WARNING**

- Do not install oven over a range cooktop or other heat-producing appliance. If installed near or over a heat source, the oven could be damaged and the warranty would be void.

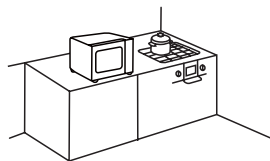

The accessible surface may be hot during operation.

# INSTRUCTION FOR USE

## BEFORE USING FOR THE FIRST TIME

The appliance may produce unpleasant odors when it is used for the first time.

This section tells you what you need to do before using your microwave to prepare food for the first time. Read the section entitled "**IMPORTANT SAFETY INSTRUCTIONS**" beforehand on page 3.

Before you can use your new appliance, you will need to put the turntable in place correctly. You must also clean the cooking compartment and accessories.



**NOTE**

- Never use the appliance without the turntable.
- Make sure that it is properly engaged. The turntable can turn clockwise or anti-clockwise.

# OPERATION

## CONTROL PANEL AND FEATURES

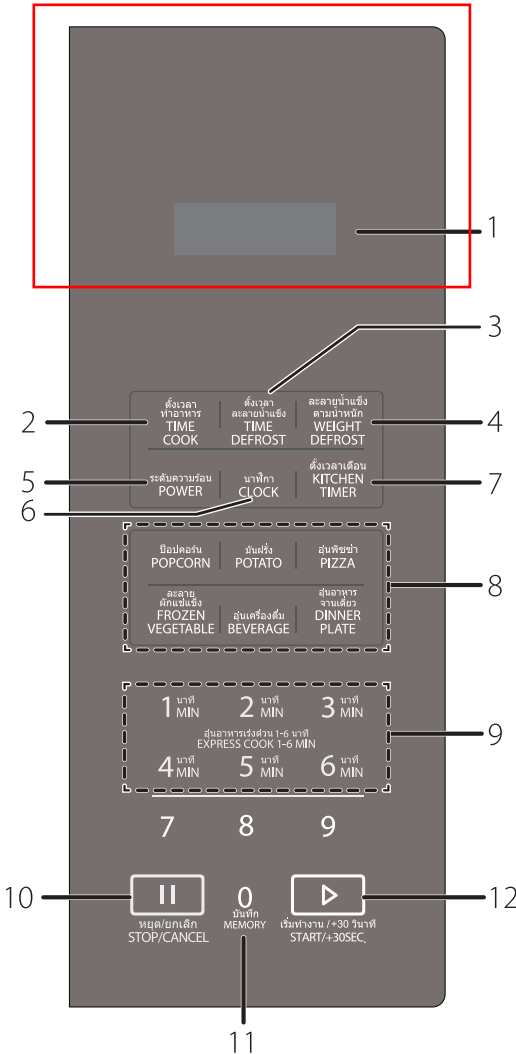

1. DIGITAL DISPLAY
2. TIME COOK  
Press to set Cooking time.
3. TIME DEFROST
4. WEIGHT DEFROST
5. POWER  
Press to select Microwave power level.
6. CLOCK  
Press to set Clock.
7. KITCHEN TIMER
8. Auto Menu
  - POPCORN
  - POTATO
  - PIZZA
  - FROZEN VEGETABLE
  - BEVERAGE
  - DINNER PLATE
9. Express Cook1-6MIN  
Press 1 to 6 to start the cooking instantly.  
1 to 6 represent the cooking time in terms of minute.
10. STOP/CANCEL  
Press to set specific cooking mode memory.
11. 0/MEMORY
12. START/+30SEC.  
For starting cooking or adding cooking time of 30sec. by every press.

## 1. MICROWAVE POWER LEVEL\*

11 power levels are available. Press "**POWER**" to select Level 10. Press the digit on the Control Panel to select Level 9 to 0. When you select "PL0", there is no power, only FAN will work to remove odor in the cabinet.

### Microwave Power Chart

LEVEL	POWER	DISPLAY
10	100%	PL10
9	90%	PL9
8	80%	PL8
7	70%	PL7
6	60%	PL6
5	50%	PL5
4	40%	PL4
3	30%	PL3
2	20%	PL2
1	10%	PL1
0	0%	PL0

\*The Microwave Power Level could only be set after setting the cooking time. Please refer to **MICROWAVE COOKING** for reference.

## 2. CLOCK SETTING

a The clock system is 12-hour system.

b Press "**CLOCK**", "00:00" will display.



c Press the number keys and enter the current time. For example, time is 12:10 now, please press "1, 2, 1, 0" in turn.



d Press "**CLOCK**" to finish clock setting. ":" will flash and the clock will be lighted.



e If the numbers input are not within the range of 1:00--12:59, the setting will be invalid until valid numbers are input.



**NOTE**

- In the process of clock setting, if the “**STOP/CANCEL**” button is pressed or if there is no operation within 1 minute, the oven will go back to the former setting automatically.
- If the clock need to be reset, please repeat step b to step d.

### 3. KITCHEN TIMER

- a Press “**KITCHEN TIMER**”, the screen will display 00:00.

ตั้งเวลาเตือน  
KITCHEN  
TIMER

- b Press the number keys and enter the timer time. (The maximum setting time is 99 minutes and 99 seconds.)

1 นาที MIN 2 นาที MIN 3 นาที MIN

- c Press “**START/+30SEC.**” to confirm setting.



เริ่มทำงาน (+30 นาที)  
START/+30SEC.

- d When the timer time arrives, the buzzer will ring 5 times.  
If the clock has been set (12-hour system), the screen will display the current time.



**NOTE**

- The kitchen timer is different from 12-hour system. Kitchen Timer is for you to count down the cooking time, when the cooking is not doing by the oven.
- During kitchen timer, any program cannot be set.

### 4. MICROWAVE COOKING

- a Press “**TIME COOK**” once, the screen will display “00:00”.

ตั้งเวลา  
ทำอาหาร  
TIME  
COOK

- b Press number keys to input the cooking time. (The maximum cooking time is 99 minutes and 99 seconds.)

1 นาที MIN 2 นาที MIN 3 นาที MIN

- c Press “**POWER**” once, the screen will display “PL10”. The default power is 100% power. Now you can press number keys to adjust the power level.

ระดับความร้อน  
POWER

▶ 1 นาที MIN 2 นาที MIN 3 นาที MIN

- d Press "**START/+30SEC.**" to start cooking.



**Example: To cook the food with 50% microwave power for 15 minutes.**

- Press "**TIME COOK**" once. "00:00" displays.



- Press "1", "5", "0", "0" in order.



- Press "**POWER**" once, then press "5" to select 50% microwave power.

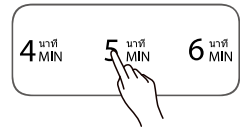

- Press "**START/+30SEC.**" to start cooking.



**NOTE**

- In the process of cooking setting, if the "**STOP/CANCEL**" button is pressed or if there is no operation within 1 minute, the oven will go back to the former setting automatically.
- If "PL0" selected, the oven will work with fan for no power. You can use this level to remove the odor of the oven.
- During microwave cooking, "**POWER**" can be pressed to change the power you need. After pressing "**POWER**", the current power flashes for 3 seconds, you can press number button to change the power. The oven will work with the selected power for the rest time.

## 5. EXPRESS COOK

- a In waiting state, instant cooking at 100% power level can be started by select a cooking time from 1 to 6 minutes by pressing number pads 1 to 6. Press "**START/+30SEC.**" to increase the cooking time. The maximum cooking time is 99 minutes and 99 seconds.



- b In waiting state, instant cooking at 100% power level with 30 seconds cooking time can be started by pressing "**START/+30SEC.**" Each press on the same button will increase cooking time by 30 seconds. The maximum cooking time is 99 minutes and 99 seconds.



- During microwave cooking and time defrost, time can be added by pressing "**START/+30SEC.**" button.

## 6. WEIGHT DEFROST FUNCTION

- a Press "**WEIGHT DEFROST**", screen will display "dEF1".



- b Press numerical buttons to input weight to be defrosted. Input the weight ranged between 100~2000 g.



- c If the weight input is not within 100~2000, the input will be invalid.

- d Press "**START/+30SEC.**" to start defrosting and the cooking time remained will be displayed.



## 7. TIME DEFROST FUNCTION

- a Press "**TIME DEFROST**", screen will display "dEF2".

ตั้งเวลา  
ละลายน้ำแข็ง  
TIME  
DEFROST

- b Press number pads to input defrosting time. The effective time range is 0:01~99:99

1 นาที MIN    2 นาที MIN    3 นาที MIN

- c Press "**START/+30SEC.**" to start defrosting. The remained cooking time will be displayed.



เริ่มทำงาน / +30 นาที  
START/+30SEC.



- The default microwave power is power level 3.
- Power level cannot be check or change during defrosting.

## 8. AUTO MENU FUNCTION - POPCORN

- a Press "**POPCORN**" repeatedly until the number you wish appears in the display, "50", "100" grams will display in order. For example, press "**POPCORN**" once, "50" appears.

ป๊อปคอร์น  
POPCORN

- b Press "**START/+30SEC.**" to cook, buzzer sounds once. When cooking finishes, buzzer will sound five times and then turn back to waiting state.



เริ่มทำงาน / +30 นาที  
START/+30SEC.

### Important Information About Microwave Popcorn Feature :

1. When selecting 100g of popcorn, it is suggested that you fold down a triangle on each corner of the bag before cooking. Refer to the picture at right.
- c 2. If/When the popcorn bag expands and no longer rotates properly, please press "**STOP/CANCEL**" button once and open the oven door and adjust the bag position to ensure even cooking.

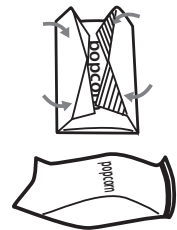

## 9. AUTO MENU FUNCTION - POTATO

Press "**POTATO**" repeatedly until the number you wish appears in the display, "1", "2", "3" will display in order.

- a "1" SET : 1 potato (approximate 230 gram)
- "2" SETS: 2 potatoes (approximate 460 gram)
- "3" SETS: 3 potatoes (approximate 690 gram)

For example, press "**POTATO**" once, "1" appears.

มันฝรั่ง  
POTATO

- b Press "**START/+30SEC.**" to cook, buzzer sounds once. When cooking finishes, buzzer sounds five times and then turn back to waiting state.



เริ่มทำงาน / +30 วินาที  
START/+30SEC.

## 10. AUTO MENU FUNCTION - FROZEN VEGETABLE

- a Press "**FROZEN VEGETABLE**" repeatedly until the number you wish appears in the display, "150", "350", "500" grams will display in order. For example, press "**FROZEN VEGETABLE**" once, "150" appears.

ละลาย  
ผักแช่แข็ง  
FROZEN  
VEGETABLE

- b Press "**START/+30SEC.**" to cook, buzzer sounds once. When cooking finishes, buzzer sounds five times and then turn back to waiting state.



เริ่มทำงาน / +30 วินาที  
START/+30SEC.

## 11. AUTO MENU FUNCTION - BEVERAGE

- a Press "**BEVERAGE**" repeatedly until the number you wish appears in the display, "1", "2", "3" cup will display in order. One cup is about 120ml.

For example, press "**BEVERAGE**" once, "1" appears.

อุ่นเครื่องดื่ม  
BEVERAGE

- b Press "**START/+30SEC.**" to cook, buzzer sounds once. When cooking finishes, buzzer sounds five times and then turn back to waiting state.



เริ่มทำงาน / +30 วินาที  
START/+30SEC.

## 12. AUTO MENU FUNCTION - DINNER PLATE

- a Press "**DINNER PLATE**" repeatedly until the number you wish appears in the display, "250", "350", "500" grams will display in order. For example, press "**DINNER PLATE**" once, "250" appears.

อุ่นอาหาร  
จานเดียว  
DINNER  
PLATE

- b Press **"START/+30SEC."** to cook, buzzer sounds once. When cooking finishes, buzzer sounds five times and then turn back to waiting state.



### 13. AUTO MENU FUNCTION - PIZZA

- a Press **"PIZZA"** repeatedly until the number you wish appears in the display, "100", "200", "400" grams will display in order. For example, press **"PIZZA"** once, "100" appears.



- b Press **"START/+30SEC."** to cook, buzzer sounds once. When cooking finishes, buzzer sounds five times and then turn back to waiting state.



### 14. MULTI-STAGE COOKING

At most 2 stages can be set for cooking. In multi-stage cooking, if one stage is defrosting, then defrosting shall be placed at the first stage automatically.



**NOTE** • Auto cooking cannot work in the multi-stage cooking.

**Example: If you want to cook with 80% microwave power for 5 minutes + 60% microwave power for 10 minutes. The cooking steps are as following:**

- Press **"TIME COOK"** once, then press **"5", "0", "0"** to set the cooking time;



- Press **"POWER"** once, then press **"8"** to select 80% microwave power.



- Press **"TIME COOK"** once, then press **"1", "0", "0"** to set the cooking time;

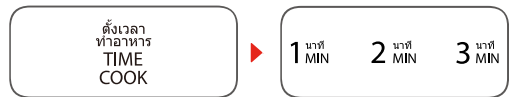

- Press **"POWER"** once, then press **"6"** to select 60% microwave power.



- Press **"START/+30SEC."** to start cooking.



## 15. LOCK FUNCTION FOR CHILDREN

### Lock:

- a** In waiting state, press **"STOP/CANCEL"** for 3 seconds, there will be a long "beep" denoting the entering into the children-lock state; meanwhile, screen will display " \_ \_ \_ \_ \_".



### Lock quitting:

- b** In locked state, press **"STOP/CANCEL"** for 3 seconds, there will be a long "beep" denoting that lock is released.



## 16. MEMORY FUNCTION

- a** Press **"0(Memory)"** to choose memory 1-3 procedure. The screen will display 1, 2, 3.



- b** If the procedure has been set, press **"START/+30SEC."** to use it. If not, continue to set the procedure. Only one or two stages can be set.



- c** After finishing the setting, press **"START/+30SEC."** once to save the procedure. If press **"START/+30SEC."** again, it will start cooking.



**Example: To set the following procedure as the second memory, that is memory 2. To cook the food with 80% microwave power for 3 minutes and 20 seconds. The steps are as follow:**

- In waiting state, press **"0(Memory)"** twice, stop pressing until the screen displays "2".



- Press **"TIME COOK"** once, then press "3", "2", "0" in order.



- Press “**POWER**” once, “PL10” displays, then press “8” and “PL8” displays.



- Press “**START/+30SEC.**” to save the setting. Buzzer sounds once and “2” displays. If you press “**START/+30SEC.**” again, the procedure will be saved as the memory 2 and operated.



- If the electricity is not cut off, the procedure will be saved all the time. If it is, the procedure need to reset.

- If you want to run the saved procedure, in waiting state, press “**0(Memory)**” twice, screen displays “2”, then press “**START/+30SEC.**” to run.



## 17. INQUIRING FUNCTION

- a** In cooking state, press “**CLOCK**”, the screen will display clock for three seconds.



- b** In the microwave cooking state, press “**POWER**” to inquire microwave power level, and the current microwave power will be displayed. After three seconds, the oven will turn back to the previous state. In multi-stage state, the inquiring way can be done by the same way as above.



## 18. COOKING END REMINDING FUNCTION

- a** When the cooking is over, the buzzer will sound 5 “beep” to alert user the cooking is finished.

## 19. OTHER SPECIFICATIONS

- a** In standby state, if the set clock digital tube displays current time, the icon “:” would flash; otherwise, it shows “0:00”.
- b** In setting function state, the screen displays corresponding setting.
- c** In working or pause state, the screen displays surplus cooking time.

# CLEANING

With good care and cleaning, your appliance will retain its appearance and remain fully functioning for a long time to come. We will explain here how you should correctly care for and clean your appliance.



**WARNING**

- Scratched glass in the appliance door may develop into a crack. Do not use a glass scraper, sharp or abrasive cleaning aids or detergents.
- The surface of the appliance may become damaged if it is not cleaned properly. Microwave energy may escape. Clean the appliance on a regular basis, and remove any food remnants immediately.
- Do not immerse the appliance in water or clean under a jet of water.

## Cleaning agent

To ensure that the different surfaces are not damaged by using the wrong cleaning agent, observe the information below. Wash new sponge cloths thoroughly before use.

### Do not use:



Harsh or abrasive cleaning agents



Metal or glass scrapers to clean the door panels

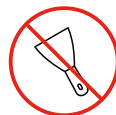

Metal or glass scrapers to clean the door seal



Hard scouring pads or sponges



Cleaning agents with a high alcohol content

## APPLIANCE FRONT

### Hot soapy water:

Clean using a dish cloth and then dry with a soft cloth. Do not use metal or glass scrapers for cleaning.

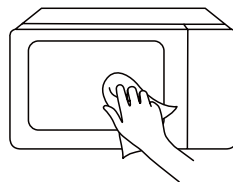

# CLEANING

## APPLIANCE FRONT PLATE

---

### Hot soapy water:

Clean using a dish cloth and then dry with a soft cloth. Remove splashes and patches of limescale, grease, starch and albumin immediately. Corrosion can form under these patches or splashes. Do not use glass cleaners or metal or glass scrapers for cleaning.

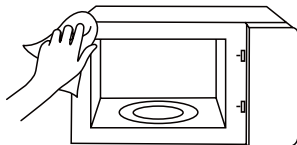

## APPLIANCE CAVITY

---

### Hot soapy water or vinegar solution:

Clean using a dish cloth and then dry with a soft cloth. Do not use oven spray or any other aggressive oven cleaners or abrasive materials. Scouring pads, rough sponges and pan cleaners are also unsuitable. These items scratch the surface. Allow the interior surfaces to dry completely.

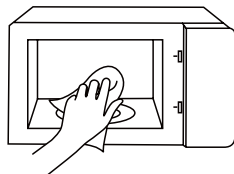

## RECESS IN THE COOKING COMPARTMENT

---

### Damp cloth:

Water must not be allowed to run into the appliance through the turntable drive. Dry the turntable drive with a cloth.

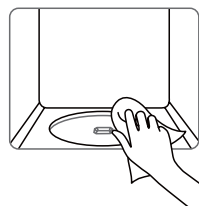

## TURNTABLE AND ROLLER RING

---

### Hot soapy water:

When placing the turntable back into its recess, it must engage properly.



## DOOR PANEL

---

### Glass cleaner:

Clean with a dish cloth. Do not use glass scrapers.

# MAINTENANCE

## TROUBLE SHOOTING

### NORMAL

Microwave oven interfering TV reception	Radio and TV reception may be interfered when microwave oven operating. It is similar to the interference of small electrical appliance, like mixer, vacuum cleaner, and electric fan. It is normal.
Dim oven light	In low power microwave cooking, oven light may become dim. It is normal.
Steam accumulating on door, hot air out of vents	In cooking, steam may come out of food. Most will get out from vents. But some may accumulate on cool place like oven door. It is normal.
Oven started accidentally with no food in.	It is forbidden to run the until without any food inside. It is very dangerous.

### TROUBLE

### POSSIBLE CAUSE

### POSSIBLE REMEDY

	a. Power cord not plugged in tightly.	a. Unplug. Then plug again after 10 seconds.
Oven can not be started.	b. Fuse blowing or circuit breaker works.	b. Replace fuse or reset circuit breaker (repaired by professional personnel of our company)
	c. Trouble with outlet.	c. Test outlet with other electrical appliances.
Oven does not heat.	Door not closed well.	Close door well.



According to Waste of Electrical and Electronic Equipment (WEEE) directive, WEEE should be separately collected and treated. If at any time in future you need to dispose of this product please do NOT dispose of this product with household waste. Please send this product to WEEE collecting points where available.



**#DetailsMatter**