

Nikon

with **WARRANTY**

Speedlight

SB-5000

.....
User's Manual (with Warranty)



Nikon Manual Viewer 2

Install the Nikon Manual Viewer 2 app on your smartphone or tablet to view Nikon digital camera manuals, anytime, anywhere. Nikon Manual Viewer 2 can be downloaded free of charge from the App Store and Google Play.

En

Preparation

About the SB-5000 and This User's Manual

Thank you for purchasing the Nikon Speedlight SB-5000. To get the most out of your Speedlight, please read this user's manual thoroughly before use.

For your safety

Before using the Speedlight for the first time, read the safety instructions in "For Your Safety" (□A-7 – A-10).

Included items

Check that all items listed below are included with the SB-5000. If any items are missing, inform the store where the SB-5000 was purchased or the seller immediately.

- Speedlight Stand AS-22
- Nikon Diffusion Dome SW-15H
- Fluorescent Filter SZ-4FL
- User's manual (this manual)
- Soft Case SS-5000
- Accessory pouch
- Incandescent Filter SZ-4TN
- Warranty (printed on the back cover of this manual)

For a complete guide to using your Speedlight, see the reference manual. To download the PDF file of the Speedlight reference manual, access the link below.

<http://downloadcenter.nikonimglib.com/>

SB-5000

Model Name: N1502

About the SB-5000

The SB-5000 is a high-performance Speedlight compatible with Nikon Creative Lighting System (CLS) with a guide number of 34.5/113 (ISO 100, m/ft) (at the 35 mm zoom head position in Nikon FX format with standard illumination pattern). In addition to conventional optical control, radio control is possible in wireless multiple flash-unit photography.

CLS-compatible cameras

Nikon digital SLR (Nikon FX/DX format) cameras (except D1 series and D100), F6, CLS-compatible COOLPIX cameras

About this user's manual

This manual has been compiled with the assumption that the SB-5000 will be used in combination with a camera compatible with CLS and a CPU lens. To get the most out of your Speedlight, please read this user's manual thoroughly before use.

- For details about camera functions and settings, see the camera user's manual.
- Illustrations and monitor content shown in this manual may differ from the actual product.

Icons used in this manual



-  Describes a point to which you should pay particular attention in order to avoid Speedlight malfunctions or mistakes.
-  Includes information or tips to make Speedlight use easier.
-  Reference to other pages in this manual

Table of Contents

A

Preparation

About the SB-5000 and This User's Manual	A-1
For Your Safety.....	A-7
Wireless Regulation Data.....	A-11
Check before Use	A-13

B

Operation

Speedlight Parts.....	B-1
Settings and the LCD.....	B-5
i Menu.....	B-9
Unified Flash Control	B-12
Basic Operations	B-14
Menu Items and Settings.....	B-22

C

Flash Modes

i-TTL Mode.....	C-2
Manual Flash Mode	C-4
Auto Aperture Flash Mode.....	C-6
Non-TTL Auto Flash Mode.....	C-6
Distance-priority Manual Flash Mode.....	C-6
Repeating Flash Mode.....	C-7

A

Preparation

D**Wireless Multiple Flash-unit Photography**

SB-5000 Wireless Multiple Flash-unit Photography	
Examples	D-1
SB-5000 Wireless Multiple Flash-unit Photography Using	
Radio Control	D-4
SB-5000 Wireless Multiple Flash-unit Photography Using	
Optical Control	D-5
SB-5000 Functions for Wireless Multiple Flash-unit	
Photography	D-7
Setting the Master Flash Unit	D-9
Setting a Remote Flash Unit	D-11
Preparation for Photography	D-12
Advanced Wireless Lighting	D-17
Setting up Remote Flash Units	D-23
Using Optical Control and Radio Control Concurrently	D-27
Checking Status in Wireless Multiple Flash-unit	
Photography	D-29

E**Functions**

Switching Illumination Patterns	E-1
Bounce Flash Operation	E-3
Taking Close-up Photographs	E-5
Flash Photography with Color Filters	E-7
Flash Photography Support Functions	E-12
Functions to Be Set on the Camera	E-17

Tips on Speedlight Care and Reference Information

Troubleshooting	F-1
Tips on Speedlight Care.....	F-6
Notes on Batteries	F-8
About the LCD Panel.....	F-9
Optional Accessories.....	F-10
Specifications.....	F-17
Warranty Terms - NIKON WORLDWIDE SERVICE WARRANTY	F-25

For Your Safety

A



Preparation





To prevent damage to your Nikon product or injury to yourself or others, read the following safety precautions in their entirety before using this equipment. Keep these safety instructions where all those who use the product will read them.



This icon marks warnings and information that should be read before using this Nikon product to prevent possible injury.

WARNINGS

-  **Turn off in the event of malfunction.** Should you notice smoke or an unusual smell coming from the product, remove the batteries immediately, taking care to avoid burns. Continued operation could result in injury. After removing the power source, take the product to a Nikon-authorized service representative for inspection.
-  **Do not disassemble or subject to powerful physical shocks.** Touching the product's internal parts could result in injury. Repairs should be performed only by qualified technicians. Should the product break open as the result of a fall or other accident, take it to a Nikon-authorized service representative for inspection, after disconnecting the product from the camera and/or removing the batteries.
-  **Keep dry.** Do not immerse in or expose to water or rain. Failure to observe this precaution could result in fire or electric shock.

-  **Do not handle with wet hands.** Failure to observe this precaution could result in electric shock.
-  **Do not use in the presence of flammable gas or dust.** Use of electronic equipment in the presence of flammable gas or dust could result in explosion or fire.
-  **Keep out of reach of children.** Failure to observe this precaution could result in injury.
-  **Do not clean with organic solvents such as paint thinner or benzene, spray with insecticide, or store with naphtha or camphor moth balls.** Failure to observe this precaution could damage or discolor the product's plastic parts.
-  **Observe caution when handling batteries.** Batteries may leak, overheat, or rupture if improperly handled. When handling batteries for use in this product, follow all instructions and warnings printed on or included with the batteries and observe the following precautions:
- Do not combine old and new batteries or batteries of different makes or types.
 - Do not attempt to recharge non-rechargeable batteries. When recharging Ni-MH batteries, follow the instructions and use compatible chargers only.
 - Insert batteries in the correct orientation.
 - Batteries may become hot if the flash is fired multiple times in quick succession. When removing the batteries, take precaution to avoid burns.

- Do not short or disassemble batteries or attempt to remove or otherwise damage the battery insulation or casing.
- Do not expose to flame or excessive heat, immerse in or expose to water, or subject to physical force.
- Do not transport or store with metal objects such as necklaces or hairpins.
- Batteries are prone to leakage when fully discharged. To avoid damage to the product, be sure to remove the batteries when no charge remains or if the product will not be used for an extended period.
- Discontinue use immediately should you notice any change in the batteries, such as discoloration or deformation.
- If liquid from damaged batteries comes in contact with clothing, eyes or skin, rinse immediately with plenty of water.
- Dispose of used batteries in accord with local regulations. Prior to disposal, insulate the terminals with tape. Fire, overheating or rupture may result should metal objects come into contact with the terminals.

 **Observe caution when using the flash**

- Using a flash in close contact with the skin or other objects could cause burns.
- Using the flash close to subject's eyes could cause temporary visual impairment. Stay at least 1 m (3.3 ft) from the subject when using the flash.
- Do not aim the flash at the operator of a motor vehicle. Failure to observe this precaution could result in accidents.

Notice for customers in Canada

CAN ICES-3B / NMB-3B

Notice for customers in Europe



This symbol indicates that electrical and electronic equipment is to be collected separately.

The following apply only to users in European countries:

- This product is designated for separate collection at an appropriate collection point. Do not dispose of as household waste.
- Separate collection and recycling helps conserve natural resources and prevent negative consequences for human health and the environment that might result from incorrect disposal.
- For more information, contact the retailer or the local authorities in charge of waste management.

A

Preparation

Wireless Regulation Data

A

Preparation

This product complies with radio regulations in the country of purchase, and its wireless features are not intended for use in other countries. Nikon will not be held liable for use of these features outside the country of purchase. If you are unable to determine the original country of purchase, consult with a Nikon-authorized service representative.

Notice for Customers in the U.S.A. and Canada

This device complies with Part 15 of FCC Rules and Industry Canada's licence-exempt RSSs. Operation is subject to the following two conditions: (1) this device may not cause interference, and (2) this device must accept any interference, including interference that may cause undesired operation of the device.

Trade Name: **Nikon**
Model: SB-5000 (SB-5000
contains communication module
Type1EK.)
Type1EK
FCC ID: VPYLB1EK
IC: 772C-LB1EK

FCC CAUTION

1. Changes or modifications not expressly approved by the party responsible for compliance could void the user's authority to operate the equipment.
2. The FCC requires the user to be notified that any changes or modifications made to this device that are not expressly approved by Nikon Corporation may void the user's authority to operate the equipment.

Radio Frequency Exposure Compliance

This equipment complies with FCC radiation exposure limits set forth for an uncontrolled environment and meets the FCC radio frequency (RF) Exposure Guidelines. This equipment has very low levels of RF energy that is deemed to comply without testing of specific absorption rate (SAR).

FCC Radio Frequency Interference Statement

Note: This equipment has been tested and found to comply with the limits for a Class B digital device, pursuant to Part 15 of the FCC Rules. These limits are designed to provide reasonable protection against harmful interference in a residential

installation. This equipment generates, uses and can radiate radio frequency energy and, if not installed and used in accordance with the instructions, may cause harmful interference to radio communications. However, there is no guarantee that interference will not occur in a particular installation. If this equipment does cause harmful interference to radio or television reception, which can be determined by turning the equipment off and on, the user is encouraged to try to correct the interference by one or more of the following measures:

- Reorient or relocate the receiving antenna.
- Increase the separation between the equipment and receiver.
- Connect the equipment into an outlet on a circuit different from that to which the receiver is connected.
- Consult the dealer or an experienced radio/TV technician for help.

Nikon Inc.,
1300 Walt Whitman Road, Melville,
New York 11747-3064, U.S.A.
Tel.: 631-547-4200

Notices for Customers in Europe Declaration of Conformity

Nikon SB-5000

Manufacturer: Nikon Corporation

A copy of the original DoC for our products as it relates to R&TTE can be found at the following website: http://imaging.nikon.com/support/pdf/DoC_SB-5000.pdf

R&TTE Directive

This product conforms to the regulations governing radio-frequency devices in the following countries and can not be used in other jurisdictions. Nikon accepts no responsibility for the use of this device in countries other than those listed below.

AT	BE	BG	CY	CZ	DK	EE	FI
FR	DE	GR	HU	IE	IT	LV	LT
LU	MT	NL	PL	PT	RO	SK	SI
ES	SE	GB	IS	LI	NO	CH	TR
HR							

Notice for Customers in Nigeria

Connection and use of this communications equipment is permitted by the Nigerian Communications Commission

Notice for Customers in Jamaica

This product contains a Type Approved Module by Jamaica: SMA – “Type1EK”.

Check before Use

A

Preparation

Tips on using the Speedlight

Take trial shots

Take trial shots before photographing important occasions such as weddings or graduations.

Use your Speedlight with Nikon equipment

The Nikon Speedlight SB-5000's performance has been optimized for use with Nikon brand cameras/accessories including lenses.

Cameras/accessories made by other manufacturers may not meet Nikon's criteria for specifications, and incompatible cameras/accessories could damage the SB-5000's components. Nikon cannot guarantee the SB-5000's performance when used with non-Nikon products.

Life-long learning

As part of Nikon's "life-long learning" commitment to ongoing product support and education, continually updated information is available online at the following websites:

- For users in the United States:
<http://www.nikonusa.com/>
- For users in Europe and Africa:
<http://www.europe-nikon.com/support/>
- For users in Asia, Oceania and the Middle East:
<http://www.nikon-asia.com/>

Visit these sites to keep up-to-date with the latest product information, tips, answers to frequently asked questions (FAQs) and general advice on digital imaging and photography. Additional information may be available from the Nikon representative in your area. See the URL below for contact information:

<http://imaging.nikon.com/>

Operation

Speedlight Parts

B
Operation

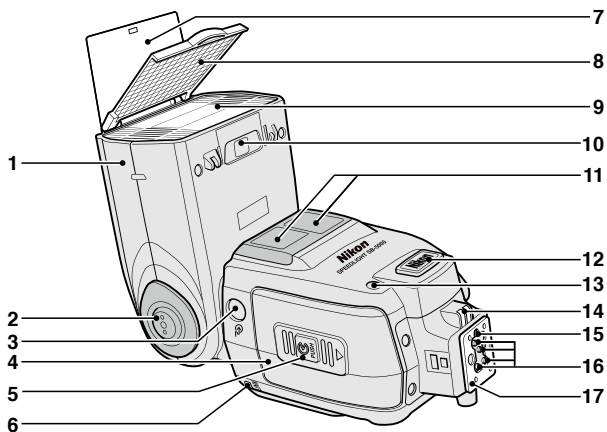

- 1 Flash head
- 2 Flash head tilting/rotating lock release button (☞B-18)
- 3 Light sensor window for wireless remote flash (☞D-25)
- 4 Battery-chamber cover
- 5 Battery-chamber cover lock release (☞B-14)
- 6 **LINK** indicator
- 7 Built-in bounce card (☞E-4)
- 8 Built-in wide panel (☞E-6)
- 9 Flash panel
- 10 Filter detector (☞E-10)
- 11 AF-assist illuminator (☞E-13)
- 12 External power source terminal (supplied with cover) (☞F-16)
- 13 Light sensor for non-TTL auto flash (☞C-6)
- 14 External AF-assist illuminator contacts
- 15 Locking pin
- 16 Accessory shoe contacts
- 17 Mounting foot

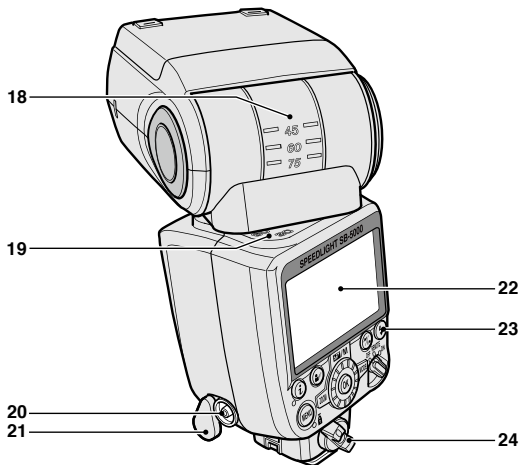

- | | | | |
|----|-------------------------------------|----|--|
| 18 | Flash head tilting angle scale | 25 | Modeling illumination button |
| 19 | Flash head rotating angle scale | • | Controls modeling illumination (☞E-14) |
| 20 | Sync terminal | 26 | i button |
| 21 | Sync terminal cover | • | Displays i menu settings (☞B-9) |
| 22 | LCD panel (☞B-5) | 27 | MENU button |
| 23 | Flash-ready indicator (☞B-21, D-29) | • | Displays menu settings (☞B-22) |
| 24 | Mounting foot lock lever (☞B-16) | | |

Settings and the LCD

Icons on the LCD show the status of settings. Displayed icons vary according to selected flash modes and settings.

- The basic control of SB-5000 functions is as follows:

B

Operation

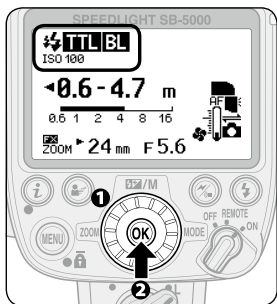

- 1 Use the rotary multi selector to highlight the item to be configured and choose desired setting.
- 2 Press the **OK** button to confirm setting.
 - Once confirmed, the highlighted item returns to normal display.
 - To return to normal display without changing settings, press the **OK** button.
 - If the **OK** button is not pressed, the highlighted item is selected and returns to normal display after 8 seconds.

Normal and highlighted display

Normal display

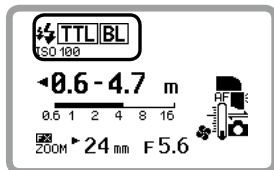

Highlighted display

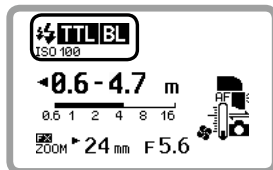

Highlighted display indicates that the item is being selected. Settings can be changed while highlighted. The LCD returns to normal display as shown at the left after settings are changed and confirmed.

Rotary multi selector

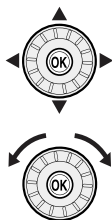

The rotary multi selector can be operated by pressing up, down, left, right or by rotating it. In this user's manual, up, down, left, right on the rotary multi selector are indicated as ▲, ▼, ◀, ▶.

■ Highlighting items

[MODE] Flash mode

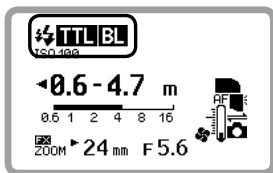

Pressing the rotary multi selector ► highlights the flash mode (□B-20).

[/ M] Flash compensation value/Flash output level in manual flash mode

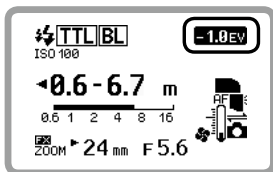

Pressing the rotary multi selector ▲ highlights the flash compensation value (□E-12).
This highlights the flash output level in manual flash mode (□C-4).

[ZOOM] Zoom head position

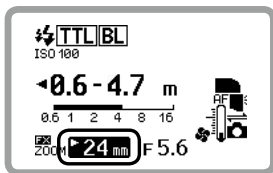

Pressing the rotary multi selector ◀ highlights the zoom head position (□E-12).

- The zoom head position is automatically set to match the lens focal length when the SB-5000 is attached to a camera.

■ Selecting items

Pressing the rotary multi selector ▲▼◀▶ highlights the items to be configured.

In **i** menu and other menus, items can be selected by rotating the rotary multi selector (B-9, B-22).

■ Changing settings

Rotating the rotary multi selector changes the settings for highlighted items.

- For numerical values, rotating the rotary multi selector clockwise increases the value, and rotating it counterclockwise decreases the value.

🔒 Activating key lock

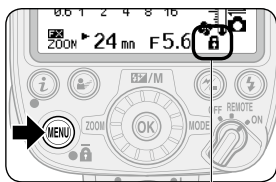

Key lock icon

Press the **MENU** button for 2 seconds. The key lock icon appears on the LCD and the dial and buttons are locked.

- The power switch, the test firing button and the modeling illumination button remain unlocked.
- To cancel key lock, press the **MENU** button again for 2 seconds.

i Menu

With **i** menu, items to be configured can be selected.

Using **i** menu

B
Operation

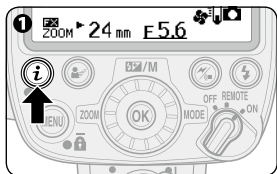

❶ Press the **i** button to display **i** menu.

❷ Press the rotary multi selector **▲ ▼** to highlight the item to be configured.



- Alternatively, rotate the rotary multi selector to select items.

❸ Press the **OK** button to confirm the selection.

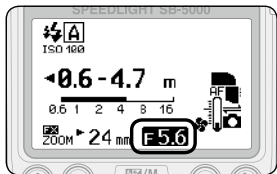
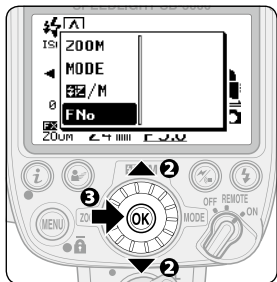

- Alternatively, press the rotary multi selector **▶** to confirm the selection.
- **i** menu is closed and the selected item is highlighted. Use the rotary multi selector to change settings (□B-6).



i menu functions and settings icons

ZOOM	Zoom head position
MODE	Flash mode
 / M	Flash compensation value/Flash output level in manual flash mode
F No	Aperture (in non-TTL auto flash mode)
m	Flash-to-subject distance (in distance-priority manual flash mode)
Times	Number of flash firings (in repeating flash mode)
Hz	Frequency of flash firings (in repeating flash mode)
	Amount of underexposure due to insufficient flash output (in i-TTL mode, underexposure occurred)
ZOOM 	Activate power zoom function

[With wireless multiple flash-unit photography]

CHANNEL	Channels
MASTER	Master flash unit setting
GR:	Remote flash unit group setting (in master mode)
 ON/--	Flash function activated/canceled status in multiple flash-unit repeating flash mode
	Group A, B setting (quick wireless control)
GR: 	Group C setting (quick wireless control)
GROUP	Remote flash unit group setting (in remote mode)

- Displayed items vary depending on function, flash mode and camera in use.

Two-button reset

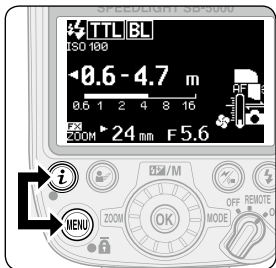

Press the **MENU** button and the **i** button simultaneously for 2 seconds to reset all settings except menu settings to default.

- This resets only the settings for the item to which the power switch is set.
- When reset is complete, the LCD is highlighted and then returns to normal display.

Unified Flash Control

When the SB-5000 is attached to a camera compatible with unified flash control, flash function settings can be shared by the SB-5000 and the camera. While the SB-5000 settings can be configured on the camera, the settings configured on the SB-5000 are also applied to the camera. The following settings can be configured.

■ Single flash-unit mode

- Flash mode
- Flash compensation value/flash output level in manual flash mode
- Flash-to-subject distance (in distance-priority manual flash mode)
- Number and frequency of flash firings (in repeating flash mode)

■ Master mode

- Wireless flash options
- Remote flash control
- Flash function settings of each flash unit
- Channel (with optical control)

SB-5000

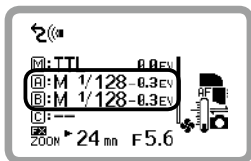
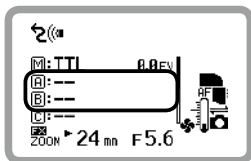

Flash function settings for remote flash units are changed on the SB-5000.

Camera

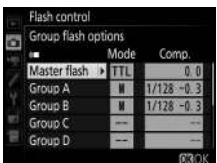
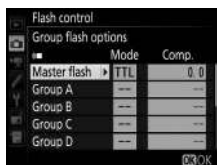

Settings are shared.

Changed settings are applied to the camera.

- If flash function settings are made on the SB-5000 when not attached to a camera, the configured settings will be applied to the camera after the SB-5000 is attached.

Basic Operations

This section covers basic procedures in i-TTL mode in combination with a CLS-compatible camera.

STEP 1 Inserting the batteries

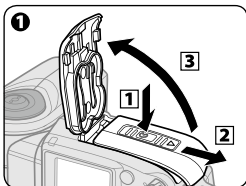

① While pressing the battery-chamber cover lock release, slide the battery-chamber cover and open it.

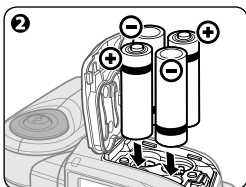

② Insert the batteries following the [+] and [-] marks.

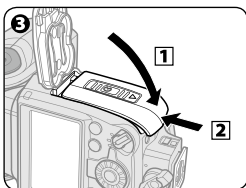

③ Push and slide the battery-chamber cover to close it.

Compatible batteries and replacement/recharging

When replacing batteries, use 4 fresh AA-size batteries or fully-charged rechargeable batteries of the same brand. Refer to the following table to determine when to replace batteries with fresh ones or recharge batteries according to how long the flash-ready indicator takes to come on. Do not mix old and new batteries or batteries of different types or makes.

Battery type	Time the flash-ready indicator takes to come on
1.5 V LR6 (AA-size) alkaline battery	20 s or more
1.2 V HR6 (AA-size) rechargeable Ni-MH battery	10 s or more

- For minimum recycling time and number of flashes for each battery type, refer to “Specifications” (□F-20).
- Alkaline battery performance may vary greatly depending on the manufacturer.
- 1.5 V R6 (AA-size) carbon-zinc batteries are not recommended.
- Using an optional external power source increases the number of flashes and provides shorter recycling times (□F-15).

Additional precautions regarding batteries

- Read and follow battery cautions in “For Your Safety” (□A-7 – A-10).
- Be sure to read and follow the warnings for the battery on the section, “Notes on Batteries” (□F-8), before using the battery.

Low battery power indicator



When battery power is low, the icon shown at the left appears on the LCD and the SB-5000 stops functioning. Replace or recharge batteries.

STEP 2 Attaching the SB-5000 to the camera

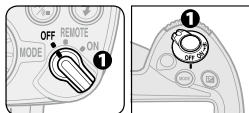

❶ Make sure the SB-5000 and the camera are turned off.

❷ Make sure the mounting foot lock lever is on the left (white dot).

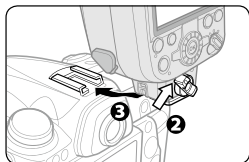

❸ Slide the SB-5000's mounting foot into the camera's accessory shoe.

❹ Turn the mounting foot lock lever to L.

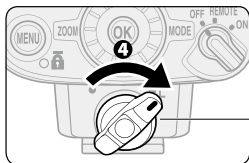

Lock the Speedlight in place

Turn the mounting foot lock lever clockwise until it stops at the mounting foot lock index.

✓ Cameras with auto pop-up flash units

Turn the SB-5000 on when it is attached to a camera with a built-in, auto pop-up flash unit. When the SB-5000 is turned off, the camera's built-in flash may pop-up automatically and strike the SB-5000. It is recommended to detach the SB-5000 from the camera when not in use.

B

Operation

■ Detaching the SB-5000 from the camera

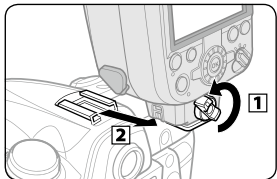

Make sure the SB-5000 and the camera are turned off, 1 turn the mounting foot lock lever 90° to the left, and then 2 slide the SB-5000's mounting foot from the camera's accessory shoe.

- If the SB-5000's mounting foot cannot be removed from the camera's accessory shoe, turn the mounting foot lock lever 90° to the left again, and slide the SB-5000 slowly out.
- Do not forcibly remove the SB-5000.

STEP 3 Adjusting the flash head

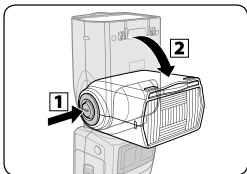

1 While holding down the flash head tilting/rotating lock release button, **2** adjust the flash head to the forward-facing position.

- The flash head is locked when tilted 90° up or set in the forward-facing position.

STEP 4 Turning the camera and SB-5000 on

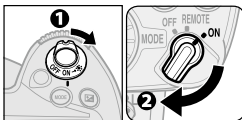

1 Turn the camera on.

2 Set the SB-5000's power switch to [ON].

LCD example

- The image below is the SB-5000 LCD with the following settings: flash mode: i-TTL; image area: FX format; illumination pattern: standard; ISO sensitivity: 100; zoom head position: 24 mm; aperture f-number: 5.6
- Icons on the LCD may differ depending on the SB-5000 settings and the camera and lens in use.

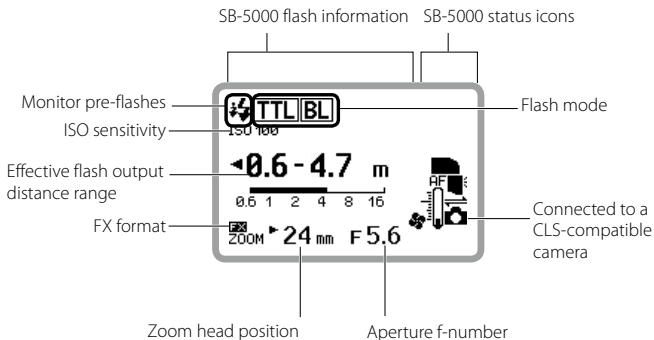

- ⚡ (monitor pre-flashes) appears on the LCD when the SB-5000 is in communication with a CLS-compatible camera.
- When the SB-5000 is in communication with the camera, ISO sensitivity, effective flash output distance range, FX format/DX format, zoom head position and aperture f-number are displayed depending on the information received from the camera.
- An **FX** above the **zoom** indicator appears on the LCD when the zoom head position is set manually.
- Some flash modes are only displayed when the SB-5000 is attached to the camera.

STEP 5 Selecting the flash mode

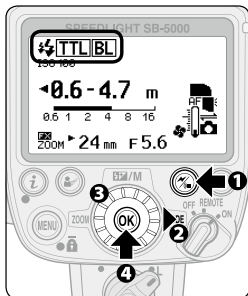

- 1 Press the wireless setting button to choose single flash-unit mode.
- 2 Press the rotary multi selector **▶** to highlight the flash mode.
- 3 Use the rotary multi selector to display **TTL BL** (□B-6).
- 4 Press the OK button.

Changing the flash mode

Pressing the rotary multi selector **▲▶** or rotating it clockwise changes the available flash mode icons displayed on the LCD.



- Pressing the rotary multi selector **▼◀** or rotating it counterclockwise changes the available flash mode icons displayed on the LCD in reverse order.
- Only available flash modes are displayed on the LCD.
- Flash mode can also be configured in **i** menu (□B-9).

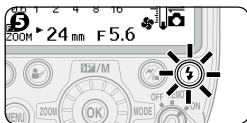

5 **Make sure that the flash-ready indicator on the SB-5000 or in the camera's viewfinder is on before taking a picture.**

- Set the flash compensation value if necessary (E-12).

Menu Items and Settings

Various operations for the SB-5000 can be easily set using the LCD.

- Displayed icons vary according to the combination of camera and status of the SB-5000.
- Depending on functions in use, some menu items and settings do not function even though they can be configured and set (for example, flash mode deselection in remote mode). Such items are indicated with grid marks on both sides.

B

Operation

Menu settings

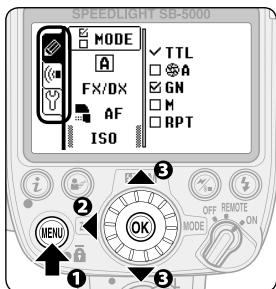

- 1 Press the **MENU** button to display the menu settings screen.
- 2 Press the rotary multi selector ◀ to highlight the menu tabs.
- 3 Press the rotary multi selector ▲ ▼ to highlight the menu tab to be configured, and then press the OK button.
- 4 Press the rotary multi selector ▲ ▼ to highlight the menu item to be configured, and then press the OK button.

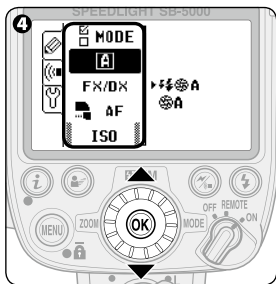

- Press the rotary multi selector ◀ to return display to menu tab selection.

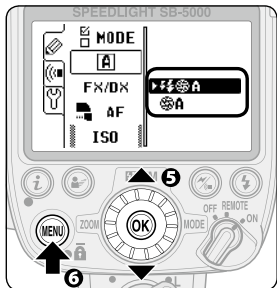

5 Press the rotary multi selector ▲▼ to highlight the desired setting, and then press the OK button.

- Press the rotary multi selector ◀ to return display to menu item selection.

6 Press the MENU button to close the menu settings.

- The LCD returns to normal display.
- Alternatively, rotate the rotary multi selector to select items.
- Alternatively, press the rotary multi selector ▶ to confirm the selection.

Item being configured

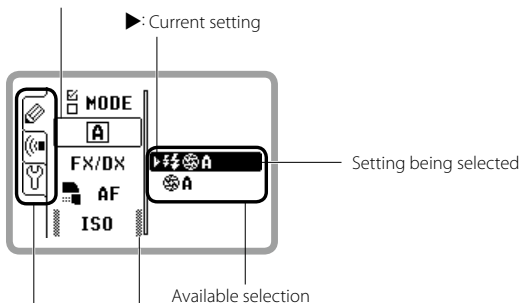

Menu tabs





Items indicated with grid marks can be configured but do not affect flash operation.



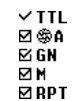

Available menu functions and settings

(**Bold**: default)

Custom menu

Settings for photography

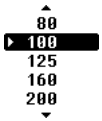
	<p>Flash mode deselection (B-20, C-1) Uncheck flash modes not necessary for single flash-unit photography. The mode in use cannot be deselected. i-TTL mode cannot be deselected.</p>
	<p>i-TTL mode Auto aperture flash mode Distance-priority manual flash mode Manual flash mode Repeating flash mode Press the rotary multi selector ► to uncheck and check the check boxes <input checked="" type="checkbox"/>.</p>
	<p>Non-TTL auto flash mode option (C-6)</p>
	<p>Auto aperture flash with monitor pre-flashes Auto aperture flash without monitor pre-flashes</p>
	<p>FX/DX format selection Enables selection of image area settings when the zoom head position is manually set</p>
	<p>FX ↔ DX: Automatically set according to the camera's image area FX: Nikon FX format (36 × 24) DX: Nikon DX format (24 × 16)</p>

	AF-assist illumination/canceling flash function (☞E-13)
	ON: Both AF-assist illumination and flash function activated OFF: AF-assist illumination canceled, flash function activated AF ONLY: AF-assist illumination activated, flash function canceled (only AF-assist illuminator lights up)
	ISO sensitivity manual setting Enables manual setting of ISO sensitivity within the range of 3 to 8000 when ISO sensitivity information has not been received from the camera (non-CLS compatible SLR camera is in use)
	100: ISO 100
 Reset custom settings	
	YES: Reset to default NO: Do not reset

☰ Wireless item menu

Settings for wireless multiple flash-unit photography using radio control

CHANNEL	Channel setting (☰D-12)
CH5 CH10 ▶CH15	CH5 CH10 CH15
LINK MODE	Link mode setting (☰D-13)
▶PAIRING PIN	PAIRING: Pairing PIN: PIN code
PAIR	Pairing (☰D-15)
EXECUTE	EXECUTE: Start pairing
PIN	PIN code setting Displays current 4-digit PIN code. PIN codes can also be entered with the rotary multi selector.
0 0 0 0	0000
NAME	Remote flash unit name (☰B-27, D-11) Displays registered name in remote mode. Up to 8 characters can be entered.
SB_5000_	SB-5000

Entering remote flash unit name



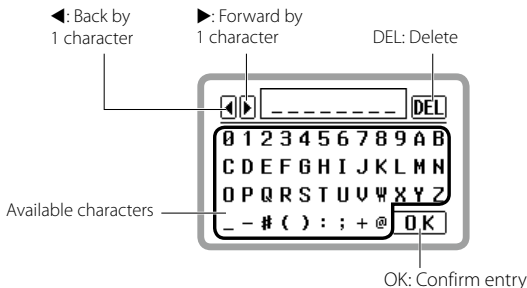





Select characters or function icons with the rotary multi selector, and then press the **OK** button.





🔑 Setup menu







Basic settings to make using the SB-5000 easier

	Illumination pattern (☑E-1)
CW ▶STD EVEN	CW: Center-weighted STD: Standard EVEN: Even
	Test firing flash output level in i-TTL mode (☑E-13)
▶M1/128 M1/32 M1/1	M1/128: Approx. 1/128 M1/32: Approx. 1/32 M1/1: Full

	Canceling power zoom function
ON 	ON: Power zoom function canceled (zoom head position must be manually set) OFF: Power zoom function activated (manual setting of zoom head position not possible)
	Zoom head position in bounce flash photography
TELE WIDE 	TELE: Locked at the maximum telephoto position WIDE: Locked at the maximum wide-angle position OFF
	Cooling system (☞E-17) Enables activation and canceling of the cooling system. Select ON for continuous flash firing.
 OFF	ON: Automatic control activated OFF: Automatic control canceled
	LCD panel contrast (☞F-9) Displays contrast levels on the LCD in a 9-step graph
	5 levels in 9 steps

	<p>Flash-ready indicator and AF-assist illuminator in remote mode (☞D-29)</p> <p>Enables selection of flash/light up of flash-ready indicator and AF-assist illuminator in remote mode to save power</p>
<p>ALL ▶REAR FRONT</p>	<p>ALL: Back indicator lights up, front illuminator flashes slowly in remote mode</p> <p>REAR: Only back indicator lights up</p> <p>FRONT: Only front illuminator flashes slowly in remote mode</p>
	<p>Sound monitor (☞D-29)</p>
<p>▶ON OFF</p>	<p>ON OFF</p>
	<p>Standby function (☞E-15)</p> <p>Enables adjustment of the time before the standby function is activated</p>
<p>▶AUTO 40 80 160 300 --</p>	<p>AUTO: Standby function activated when the time interval on the camera's standby timer* expires</p> <p>40: 40 s</p> <p>80: 80 s</p> <p>160: 160 s</p> <p>300: 300 s</p> <p>--: Standby function canceled</p>

* The standby timer is called "auto meter off" on some camera models.

	LCD panel illumination (□F-9) Enables activation and canceling of LCD panel illumination
	ON: Activated OFF: Canceled
	Measurement unit (m/ft)
	m: meters ft: feet
	Version of firmware
14.001	14.001
	Reset setup menu settings Resets setup menu settings to default
	YES NO

Flash Modes

This section explains the SB-5000 flash modes.

- Use the rotary multi selector to change the flash mode (☞B-20).
- Flash mode can also be configured in **i** menu (☞B-9).

Auto setting of ISO sensitivity, aperture and focal length

When using the SB-5000 with a CLS-compatible camera and a CPU lens, ISO sensitivity, aperture and focal length are automatically set according to the lens and camera information.

- For details about ISO sensitivity range, see the camera user's manual.
- Flash compensation value can be set on the SB-5000. Press the rotary multi selector ▲ to highlight the flash compensation value and rotate the rotary multi selector to choose a flash compensation value.

i-TTL Mode

Information obtained by monitor pre-flashes and exposure control information are integrated by the camera to automatically adjust flash output levels.

- i-TTL mode is recommended for standard photography.
- To take pictures using the SB-5000 in i-TTL mode, see “Basic Operations” (C-B-14).
- Either the i-TTL balanced fill-flash mode or the standard i-TTL mode option is available.
- Use auto aperture flash or non-TTL auto flash mode for a camera that is not compatible with i-TTL mode.

i-TTL balanced fill-flash

The flash output level is automatically adjusted for well-balanced exposure of the main subject and background. **TTL|BL** appears on the LCD. The i-TTL balanced fill-flash can be selected only when the SB-5000 is attached to a camera.

Standard i-TTL

The main subject is correctly exposed regardless of background brightness. This is useful when you want to highlight the main subject. **TTL** appears on the LCD.

Camera's metering mode and i-TTL mode

When the camera's metering mode is changed to spot metering while i-TTL balanced fill-flash is in use, the i-TTL mode automatically changes to the standard i-TTL mode.

i-TTL mode LCD example

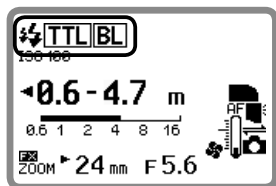

 : Monitor pre-flashes

 : i-TTL

 : Balanced fill-flash

Effective flash output distance range in i-TTL mode

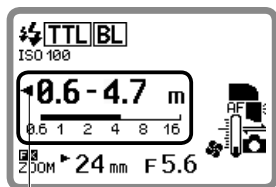

This icon means that the flash output cannot be effectively adjusted for a shorter distance.

The effective flash output distance range is indicated by numbers and a bar chart on the LCD.

- The actual flash-to-subject distance should be within the range displayed.
- The range varies depending on the camera's image area setting, illumination pattern, ISO sensitivity, zoom head position and aperture.

Manual Flash Mode

In manual flash mode, aperture and flash output level are manually selected. This allows for control of exposure and flash-to-subject distance.

- The flash output level can be set from M1/1 (full output) to M1/256 to suit creative preferences.
- Monitor pre-flash and the indication of insufficient flash output for correct exposure are not available in manual flash mode.

Manual flash mode LCD example

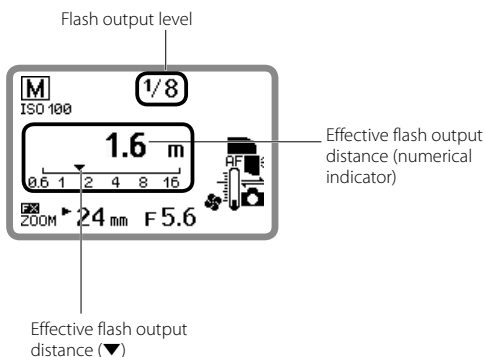

Taking a picture in manual flash mode



- ❶ Press the rotary multi selector **▲** to highlight the flash output level.
- ❷ Use the rotary multi selector to choose a flash output level, and then press the **OK** button (B-6).
 - Flash output level can also be configured in **i** menu (B-9).
 - The flash-to-subject distance indicated matches the selected flash output level and aperture.
- ❸ Check that the flash-ready indicator is on, and then shoot.

When no lens aperture information is transmitted

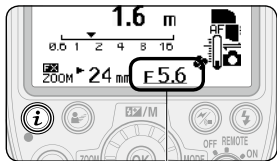

Aperture; underlined when aperture is set on the SB-5000

When lens aperture information is not transmitted to the SB-5000, aperture can be set in **i** menu.

Auto Aperture Flash Mode

The SB-5000's light sensor for non-TTL auto flash measures the flash that is reflected on the subject, and the SB-5000 controls the flash output level according to the lens and camera information transmitted to the SB-5000, including ISO sensitivity, exposure compensation value and aperture.

- When no aperture information is transmitted to the SB-5000, the flash mode is automatically set to non-TTL auto flash.

Non-TTL Auto Flash Mode

The SB-5000's light sensor for non-TTL auto flash measures the flash that is reflected on the subject, and the SB-5000 controls the flash output level according to the reflected flash data.

Distance-priority Manual Flash Mode

In this flash mode, when the flash-to-subject distance value is entered, the SB-5000 automatically controls flash output level according to the camera settings.

Repeating Flash Mode

In repeating flash mode, the SB-5000 fires repeatedly during a single exposure, creating stroboscopic multiple-exposure effects.

- Be sure to use fresh or fully charged batteries and allow enough time for the flash unit to recycle between each repeating flash session.
- Because of the lower shutter speeds, use of a tripod is recommended to prevent camera/flash unit shake.
- Indication of insufficient flash output for correct exposure is not available in repeating flash mode.



Wireless Multiple Flash-unit Photography

In wireless multiple flash-unit photography, multiple flash units fire simultaneously. Different flash unit positions and function settings provide diverse lighting effects.

With the SB-5000, wireless multiple flash-unit photography using optical control or radio control is possible.

- In wireless multiple flash-unit photography, the Speedlight attached to a camera is the master flash unit. Other Speedlights function as remote flash units.

SB-5000 Wireless Multiple Flash-unit Photography Examples

■ Using radio control

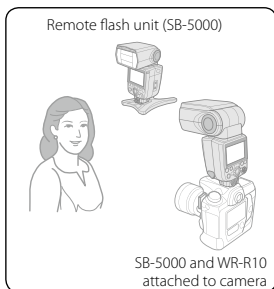

Setting the flash functions on the SB-5000 attached to a camera

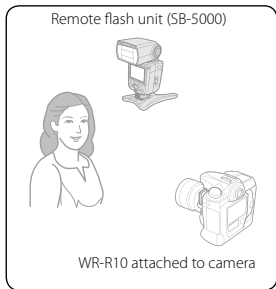

Setting the flash functions on a camera

■ Using optical control

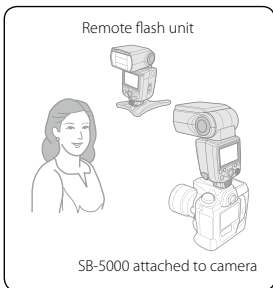

Setting the flash functions on the SB-5000 attached to a camera

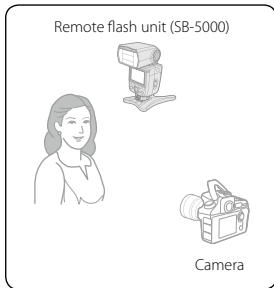

Setting the flash functions on a camera

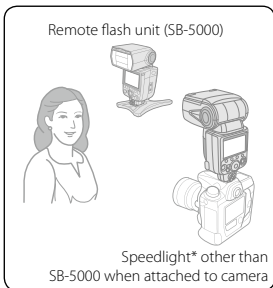

Setting the flash functions on a Speedlight other than an SB-5000 when attached to a camera

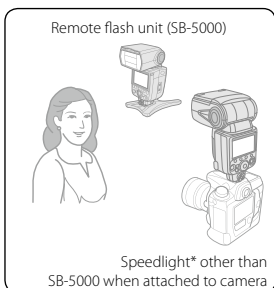

Using direct remote wireless multiple flash-unit photography

* A model with the master flash function such as SB-910

■ Using optical control and radio control concurrently

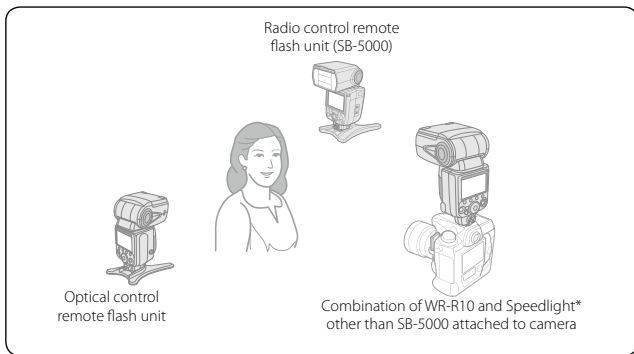

* A model with the master flash function such as SB-910

- For master flash unit setting, see D-9.
- For remote flash unit setting, see D-11.

D

SB-5000 Wireless Multiple Flash-unit Photography Using Radio Control

With the SB-5000, Advanced Wireless Lighting using radio control is possible. Because communication is possible within a range of 30 m (98 ft) and the light sensor window for wireless remote flash on remote flash units does not have to face the master flash unit, positioning of flash units is more flexible than with optical control. Up to 6 groups, total of 18 remote flash units can be set up, expanding creative expression. In addition, wireless multiple flash-unit photography in bright daylight, which is difficult with optical control, is also possible as sunlight has no effect.

D

Wireless Multiple Flash-unit Photography

A compatible camera (D5 or D500), the Wireless Remote Controller WR-R10 and the WR adapter WR-A10 (both optional) are required for wireless multiple flash-unit photography using radio control. For details, see the respective user's manuals.

- Only the SB-5000 can be used as a remote flash unit.
- Up to 6 groups of remote flash units (A, B, C, D, E, F) can be set up, but only 3 groups of remote flash units (A, B, C) can be set with quick wireless control.
- Single or multiple remote flash units can be allocated for 1 group.
- The master flash unit and each remote flash unit group can operate with a flash compensation value that is different to the other flash units or groups. In group flash mode, they can also operate with different flash modes.

SB-5000 Wireless Multiple Flash-unit Photography Using Optical Control

With the SB-5000, Advanced Wireless Lighting and direct remote wireless multiple flash-unit photography (remote mode only) are possible using optical control.

- Advanced Wireless Lighting is recommended for standard multiple flash-unit photography.
- Direct remote wireless multiple flash-unit photography is particularly suited to photographing fast-moving subjects.

■ Advanced Wireless Lighting

- A Speedlight compatible with Advanced Wireless Lighting (SB-5000, SB-910, SB-700, SB-500, etc.) can be used as a remote flash unit.
- Up to 3 groups of remote flash units (A, B, C) can be set up.
- Single or multiple remote flash units can be allocated for 1 group.
- The master flash unit and each remote flash unit group can operate with a flash compensation value that is different to the other flash units or groups. In group flash mode, they can also operate with different flash modes.

■ Direct remote wireless multiple flash-unit photography

- This is the same as the “SU-4 type wireless multiple flash-unit photography” of the SB-910 and SB-700.
- The camera’s built-in flash or the Speedlight attached to the camera can be used as the master flash unit.
- Be sure to cancel the master flash unit monitor pre-flash function or select a master flash unit flash mode that does not activate monitor pre-flashes.
- The flash mode is set on each remote flash unit. Set the same flash mode on each remote flash unit when using multiple remote flash units.

Using optical control and radio control concurrently is also possible. For details, see D-27.

SB-5000 Functions for Wireless Multiple Flash-unit Photography

		When used in master mode	When used in remote mode	
Flash photography with Advanced Wireless Lighting	Flash mode	<ul style="list-style-type: none"> Group flash i-TTL Auto aperture flash Manual flash Flash function canceled Quick wireless control Multiple flash-unit repeating flash 	The flash mode is set on the master flash unit (each group can fire with a flash mode different to other groups in group flash mode)	
	Flash exposure compensation	Possible	The flash compensation value is set on the master flash unit (each group can fire with a compensation value different to other groups)	
	Radio control	Group	Up to 6 groups (A, B, C, D, E, F)	
		Channel*	3 channels (CH5, CH10, CH15)	
		Link mode	Pairing, PIN code	
	Optical control	Group	Up to 3 groups (A, B, C)	
Channel*		4 channels (1 – 4)		

D

Wireless Multiple Flash-unit Photography

		When used in master mode	When used in remote mode
Direct remote wireless multiple flash-unit photography	Flash mode	–	<ul style="list-style-type: none"> • AUTO (auto) • M (manual) • OFF (flash function canceled)
	Flash exposure compensation	–	–

* Use only 1 channel from among these. Remote flash units can be triggered by other master flash units. Use a different channel number if another photographer is using the same type of wireless remote flash setup close by.

Notes on canceling the master flash unit flash function

With optical control, when the master flash unit flash function is canceled and only the remote flash units fire, the master flash unit emits a number of weak light signals to trigger the remote flash units. This operation will normally not affect the correct exposure of the subject, although the exposure might be affected if the subject is close and a high ISO sensitivity has been set. To limit this effect, tilt the master flash unit's flash head upward.

Setting the Master Flash Unit

Setting the flash functions of each Speedlight on the SB-5000 attached to a camera:

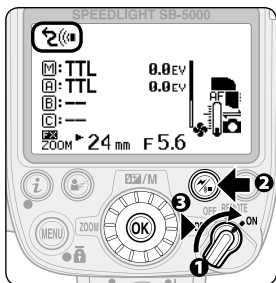

- 1 Set the power switch to [ON].
- 2 Press the wireless setting button to choose radio or optical control master mode.
- 3 Press the rotary multi selector ► on the master flash unit to display the desired flash mode.

Control type information

Optical control	Radio control	Flash mode
		Group flash
		Quick wireless control
		Multiple flash-unit repeating flash

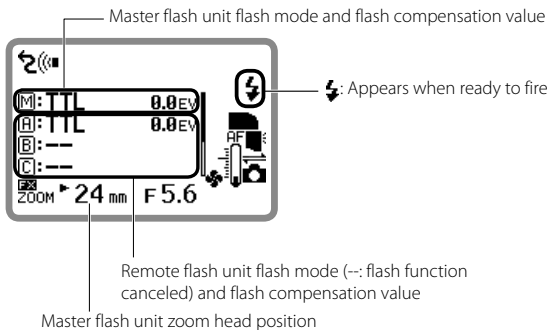
Master mode LCD example (radio control, group flash)

Setting a Remote Flash Unit

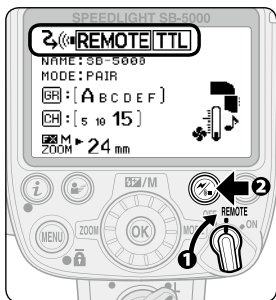

- ❶ Set the power switch to [REMOTE].
- ❷ Press the wireless setting button to choose radio control, optical control or direct remote mode.
 - When using radio control, the remote flash unit name and link mode are displayed.

Control type information

	Optical control remote mode
	Direct remote mode
	Radio control remote mode

Remote mode LCD example (radio control)

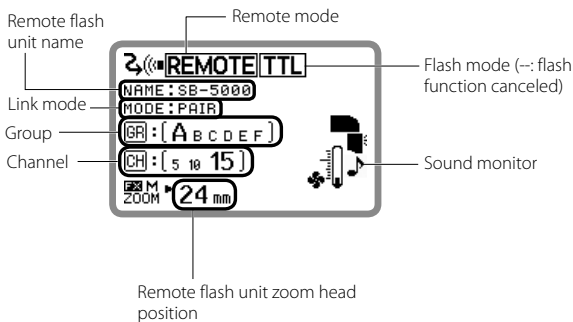

Preparation for Photography

Radio control only

Setting the link for radio control

When using radio control, set the link in the wireless item menu.

- Set the SB-5000 in radio control remote mode before setting the link (D-11).

STEP 1 Setting the channel

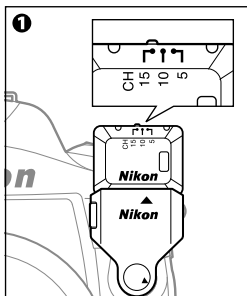

- 1 Check the channel set on the WR-R10.

- For details about WR-R10 settings, see the WR-R10 user's manual.

- 2 Choose [CHANNEL] from the wireless item menu (D-22).

- 3 Press the rotary multi selector ▲▼ to choose the same channel as the WR-R10, and then press the OK button.

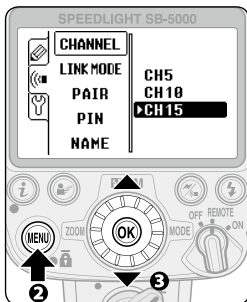

STEP 2 Setting the link mode



- 1 Check the link mode set on the camera with the WR-R10 attached.

- For details about how to check the link mode, see the camera user's manual.

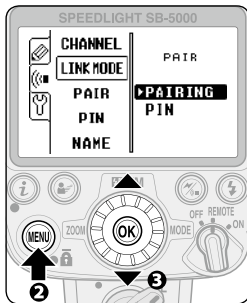

- 2 Choose [LINK MODE] from the wireless item menu (B-22).

- 3 Press the rotary multi selector ▲ ▼ to choose the same link mode as the camera with the WR-R10 attached, and then press the OK button.

D

Pairing

- Execute pairing beforehand between devices that conduct communication.
- Once the SB-5000 and the WR-R10 are paired, it is not necessary to pair them again.
- To use multiple SB-5000 units, each unit must be paired with the WR-R10.
- When another WR-R10 is attached to the camera, re-execute pairing with it.

PIN code

- Set the same PIN code beforehand for devices that conduct communication.
- To use multiple SB-5000 units, set the same PIN code for all SB-5000 units and the WR-R10. The PIN code of the WR-R10 can be set on the camera.
- To increase the number of SB-5000 units, the link can be established only by entering the same PIN code to all the units to be added.
- Even when another WR-R10 is attached to the camera, resetting the PIN code is not necessary.

STEP 3 Setting the link

■ When link mode is set to pairing

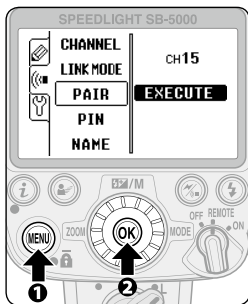

① Choose [PAIR] from the wireless item menu (B-22).

② Check that [EXECUTE] is highlighted, and then press the OK button while pressing the pairing button on the WR-R10 attached to the camera.

- An execution indicator appears on the LCD and the LINK indicator flashes slowly in green while pairing.

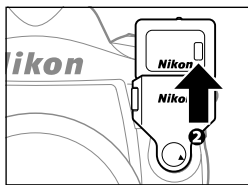



Pairing succeeded

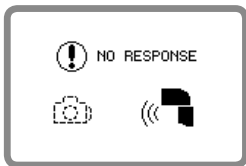

Pairing failed

③ Check that pairing has succeeded.

- When pairing succeeds, a completion indicator appears on the LCD and the **LINK** indicator flashes slowly in green and orange.
- When pairing fails, an error indicator appears on the LCD. Check the channel setting and try again.
- For details about WR-R10 settings, see the WR-R10 user's manual.

For link setting with PIN code, see the Speedlight reference manual, which can be downloaded from the Nikon website.

Advanced Wireless Lighting

With the SB-5000, 3 Advanced Wireless Lighting options are available: group flash, which enables desired flash function settings for each flash unit; quick wireless control, with easy setting for wireless multiple flash-unit photography; and multiple flash-unit repeating flash.

Group flash

In group flash mode, the master flash unit and each remote flash unit group can operate with a flash compensation value and a flash mode that is different to the other flash units or groups.

- Group flash mode can be selected by pressing the rotary multi selector ► when using the SB-5000 as the master flash unit.
- Setting the flash functions of each Speedlight on the camera is also possible.

Taking a picture with Advanced Wireless Lighting

1. Master flash unit setting

Setting the flash functions of each Speedlight on the SB-5000:

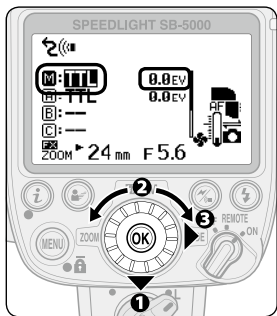

- ❶ Press the rotary multi selector ▼ on the master flash unit to highlight [M] (master flash unit).
- ❷ Rotate the rotary multi selector to choose a master flash unit flash mode.
- ❸ Press the rotary multi selector ► to highlight the flash compensation value and rotate the rotary multi selector to choose a flash compensation value.
- ❹ Press the rotary multi selector ◀ to highlight the flash mode, and then press the OK button.
- ❺ Press the rotary multi selector ▼ to highlight [A] (group A).
- ❻ Repeat procedures ❷, ❸ and ❹ to set the flash mode and flash compensation value of remote flash unit group A.
- ❼ Set the other remote flash unit groups in the same manner.

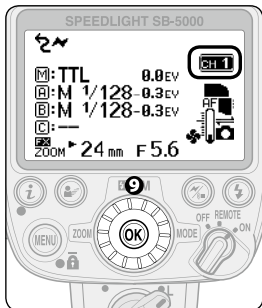
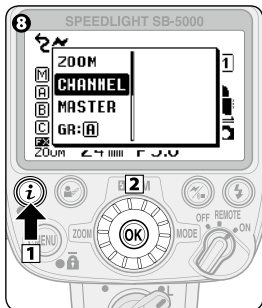

With optical control only

8 Choose [CHANNEL] in *i* menu (□B-9).

- 1 Press the *i* button to display *i* menu and 2 use the rotary multi selector to choose [CHANNEL].

9 Use the rotary multi selector to choose a channel, and then press the OK button (□B-6).

- Flash mode and flash compensation value can also be configured in *i* menu (□B-9).

2. Remote flash unit setting

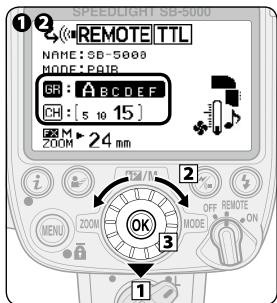

- Group name and channel number being set appears larger.

1 **1** Press the rotary multi selector ▼ on the remote flash unit to highlight the group, **2** rotate the rotary multi selector to choose a group, and then **3** press the OK button.

- Alternatively, press the rotary multi selector ◀ ▶ to choose a group.

2 **1** Press the rotary multi selector ▼ to highlight the channel, **2** rotate the rotary multi selector to choose a channel, and then **3** press the OK button.

- Alternatively, press the rotary multi selector ◀ ▶ to choose a channel.

With radio control

- Be sure to choose the same channel number as set on the Wireless Remote Controller WR-R10.

With optical control

- Be sure to choose the same channel number as set on the master flash unit.

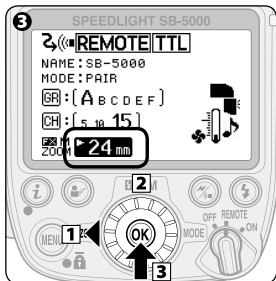

③ **1** Press the rotary multi selector ◀ to highlight the zoom head position, **2** use the rotary multi selector to choose a zoom head position, and then **3** press the OK button (☐B-6).

④ **Check the status of the flash units, and then shoot.**

- Group, channel and zoom head position can also be configured in **i** menu (☐B-9).

Setting the flash functions on a camera

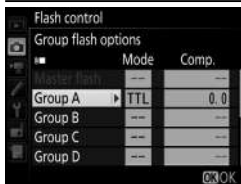

Use camera menu to make settings.

- For details, see the camera user's manual.

Quick wireless control

The flash output level ratios of 2 remote flash unit groups (A and B) and the flash function activate/cancel of group C can be easily set with quick wireless control.

- Quick wireless control can be selected by pressing the rotary multi selector ► when using the SB-5000 as the master flash unit.
- The master flash unit does not fire in quick wireless control photography.

Multiple flash-unit repeating flash

Multiple flash-unit repeating flash photography is possible in Advanced Wireless Lighting.

- Multiple flash-unit repeating flash mode can be selected by pressing the rotary multi selector ► when using the SB-5000 as the master flash unit.

For direct remote wireless multiple flash-unit photography, see the Speedlight reference manual, which can be downloaded from the Nikon website.

Setting up Remote Flash Units

- Place all remote flash units in the same group close together and facing the same direction.
- Use the provided Speedlight Stand AS-22 for stable positioning of the remote flash units. Attach and detach the SB-5000 to and from the AS-22 in the same way it is attached to/detached from the camera's accessory shoe.
- When carrying the Speedlight Stand with the SB-5000 attached, be sure to hold the SB-5000 in your hand.
- Be sure to check the status of the flash units before photographing.
- Set the zoom head position of the remote flash units wider than the angle of view, so that the subject will receive sufficient illumination even when the angle of the flash head is off axis from the subject. When the flash-to-subject distance is very short, set the zoom head position wide enough to achieve sufficient light.

When using radio control

- As a basic guide, the effective distance between the master and remote flash units is approx. 30 m (98 ft) or less. These ranges vary slightly depending on ambient environment.
- Position the remote flash units facing the desired direction.
- Up to 18 remote flash units can be used together.
- Be sure to press the test firing button on the master flash unit attached to a camera to test fire the remote flash units after setting up the camera, WR-R10 and Speedlight.
- When radio control remote mode is set, the standby function is canceled while communicating with the camera. Make sure that there is sufficient battery power. When not communicating with the camera, the standby function is automatically activated regardless of the standby function setting in the setup menu (□B-22).

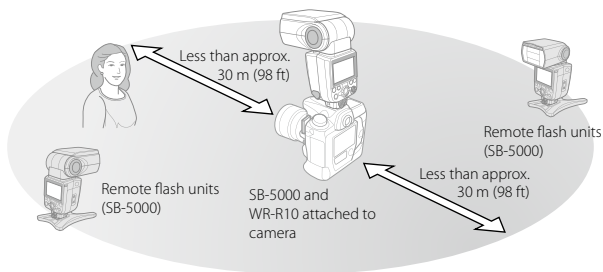

■ When using optical control

- Position the remote flash units so that light from the master flash unit can reach the light sensor window for wireless remote flash of the remote flash units. This is particularly important when holding a remote flash unit in the hand.
- Be sure to press the master flash unit test firing button to test fire the remote flash units after setting up.

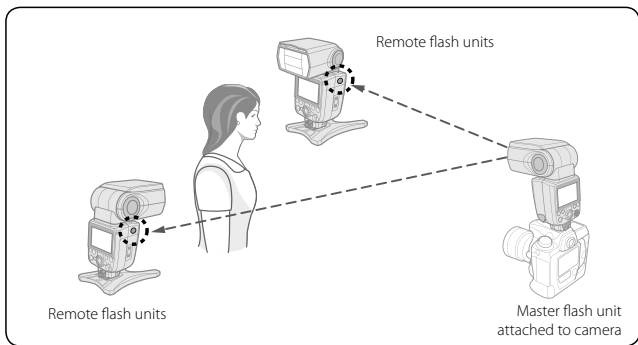

- As a basic guide, the effective distance between the master flash unit and remote flash units is approx. 10 m (32 ft) or less in the front position, and approx. 7 m (22 ft) at both sides (in Advanced Wireless Lighting). These ranges vary slightly depending on ambient light.

- There is no limit to the number of remote flash units that can be used together. However, when using many remote flash units, light may be unintentionally picked up by the light sensor of the master flash unit and interfere with correct functioning. The practical number of remote flash units for wireless multiple flash-unit photography is 3. In Advanced Wireless Lighting, for practical purposes, the number of remote flash units should be limited to around 3 for 1 group.

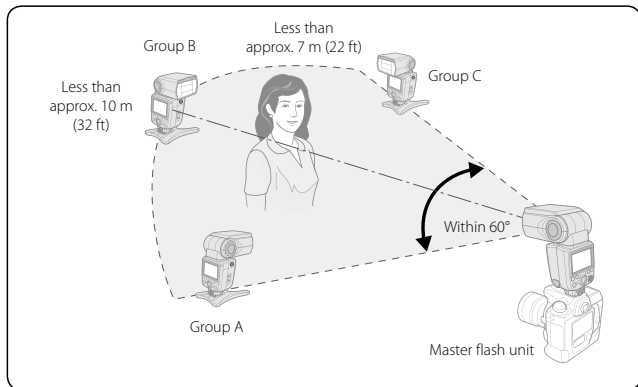

- Take care not to let light from the remote flash units enter the camera lens or the master flash unit light sensor for non-TTL auto flash.
- Do not place an obstacle between the master flash unit and remote flash units as it can interfere with transmission of data.
- When optical control remote mode is set, the standby function is canceled. Make sure that there is sufficient battery power.

Using Optical Control and Radio Control Concurrently

The following combinations enable group flash using optical control and radio control concurrently.

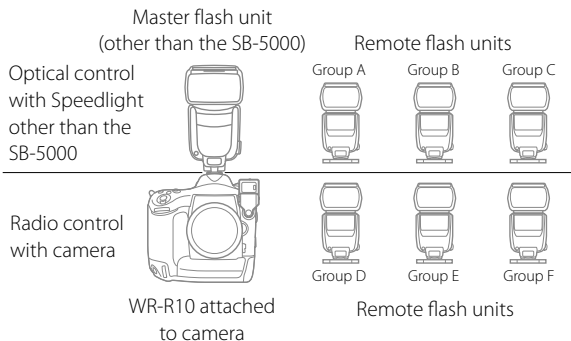

■ Master flash unit (optical control)

Former Speedlight models with the master flash function, such as SB-910, attached to a camera can be used as the master flash unit to control remote flash unit groups A, B and C.

- The SB-5000 cannot be used as the master flash unit when using optical control and radio control concurrently.

■ Remote flash unit groups A, B and C (optical control)

Up to 3 groups of remote flash units (A, B, C) can be set up for optical control.

- Former Speedlight model attached to a camera is the master flash unit.
- Choose optical control remote mode when using the SB-5000 as remote flash unit in groups A, B and C.

■ Camera and WR-R10 (radio control)

A radio control-compatible camera (D5 or D500) with the WR-R10 attached controls the remote flash unit groups D, E and F.

- For details, see the camera user's manual.

■ Remote flash unit groups D, E and F (radio control)

Up to 3 groups of remote flash units (D, E, F) can be set up for radio control.



- Camera with the WR-R10 attached controls the flash function.
- For details, see the camera user's manual.

Checking Status in Wireless Multiple Flash-unit Photography

With wireless multiple flash-unit photography, the SB-5000's flash-ready indicator, AF-assist illuminator, sound monitor and LCD panel, as well as **LINK** indicator (radio control only) can be used to check the status before and after taking a picture.

- The sound monitor can be used to check the operational status of a remote flash unit. This function can be activated or canceled in the setup menu (□B-22).
- When the SB-5000 is used in remote mode, the flash-ready indicator and the AF-assist illuminator can be turned off in the setup menu to reduce power consumption. In default setting, only the flash-ready indicator lights up (□B-22).

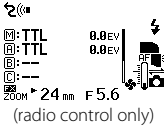
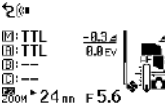
Master flash unit

Flash-ready indicator	LCD panel	Status
Lights up	 <p>(radio control only)</p>	Ready to fire
Goes out and lights up when ready to fire	—	Fired properly
Flashes slowly for approx. 3 s		Underexposure due to insufficient flash output may have occurred. To compensate, use a wider aperture (smaller f-number) or higher ISO sensitivity, or move the flash unit closer to the subject and reshoot.
Does not light up or flash		The camera is not compatible with radio control. Check the camera in use.

Remote flash unit

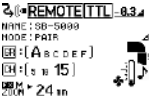
Flash-ready indicator	AF-assist illuminator	Sound monitor	LCD panel	Status
Lights up	Flashes slowly	1 long beep	–	Ready to fire
Lights up	Flashes slowly or does not light up or flash at all	2 short beeps	–	Fired properly
Flashes quickly for approx. 3 s	Flashes quickly for approx. 3 s	8 long beeps		Underexposure due to insufficient flash output may have occurred. To compensate, use a wider aperture (smaller f-number) or higher ISO sensitivity, or move the flash unit closer to the subject and reshoot.
Lights up	Flashes quickly for approx. 6 s	12 long beeps in 2 different tones	–	The remote flash unit light sensor has failed to receive the command. With optical control, this is because the light sensor cannot detect when to stop firing in sync with the master flash unit, either due to a reflection from the remote flash unit itself or light from another remote flash unit that may have entered the light sensor window. Change the direction or position of the remote flash unit and reshoot.

LINK indicator

LINK indicator	Status
Lights up (green)	In radio communication
Flashes slowly (orange)	Proper communication is not possible. Check the camera's wireless setting. Check if the same channel as the WR-R10 is set. Check if the same link mode as the camera is set. When link mode is set to PIN code, check if the same PIN code as the camera is set.

Functions

Switching Illumination Patterns

In flash photography, the center of the image is most illuminated, while the edges are darker. The SB-5000 provides 3 types of illumination patterns with different light falloff at edges. Select the suitable pattern according to the photography environment.

Standard

The basic illumination pattern for common flash photography environments

Even

The light falloff at the edge of the image is less than with the standard illumination pattern.

- Suitable for group photographs, in which sufficient light is required without light falloff at the edges.

Center-weighted

The center-weighted pattern provides larger guide numbers at the center of the image than the standard illumination pattern (the light falloff at the edge will be greater than the standard illumination pattern).

- Suitable for shots, such as portraits, in which the light falloff at the edge of an image can be ignored.

Setting the illumination pattern



The illumination pattern can be changed in the setup menu (B-22).

- The selected illumination pattern is indicated with an icon on the LCD.



Bounce Flash Operation

Bounce flash is a photographic technique using light that is bounced off a ceiling or wall using a tilted or rotated flash head. This provides the effects listed below compared to those with direct light from a flash unit:

- Overexposure to a subject that is closer than other subjects can be reduced.
 - Background shadows can be softened.
 - Glare on faces, hair and clothes can be reduced.
-
- The shadows can be softened further using the Nikon Diffusion Dome.

Nikon Diffusion Dome

- By attaching the included Nikon Diffusion Dome over the flash head, light can be further diffused during bounce flash photography to create extremely soft light with virtually no shadow.
- The same effect can be achieved with the camera in either horizontal or vertical position.
- Light is more effectively diffused when the built-in wide panel is used (□E-6).

Attaching the Nikon Diffusion Dome

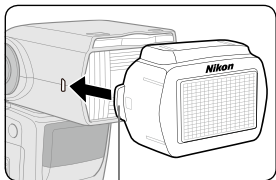

Detaching knob

Attach the Nikon Diffusion Dome as shown in the diagram, with the Nikon logo facing up.

- Detach the Nikon Diffusion Dome while pulling the detaching knob outward.

Using the built-in bounce card

- In bounce flash photography, use the SB-5000's built-in bounce card to make a portrait subject's eyes look more vibrant by reflecting the light in them.
- Tilt the flash head up 90°.

Setting the built-in bounce card

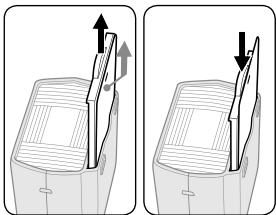

Pull out the bounce card and the built-in wide panel and, while holding the bounce card, slide the built-in wide panel back into place inside the flash head.

- Pull out the bounce card until it stops in the locked position.
- To insert the bounce card, pull out the built-in wide panel again and slide both back into place together.

Taking Close-up Photographs

When the flash-to-subject distance is less than approx. 2 m (6.5 ft), tilting down the flash head is recommended to ensure sufficient illumination of the lower part of the subject in close-up photography.

- The bounce-down icon appears when the flash head is tilted down.
- When using a long lens, be careful that the light from the flash is not obstructed by the lens barrel.
- Vignetting may occur in close-up flash photography due to the illumination pattern, lens in use, focal length setting, etc. Therefore, make test shots if taking an important picture.

Effect of the built-in wide panel

With the built-in wide panel, the flash from the SB-5000 is diffused. This softens shadows and prevents glare on faces, etc.

Setting the built-in wide panel

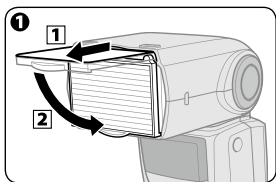

❶ **1** Carefully pull the built-in wide panel all the way out and **2** position it over the flash panel.

❷ **2** Slide the bounce card back into place inside the flash head.

- To replace the built-in wide panel, lift it up and slide it into the flash head as far as it will go.

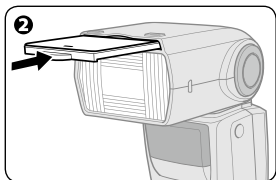

✎ If the built-in wide panel is broken

- The built-in wide panel may break if subjected to strong knocks while on the flash head.
- In this case, contact your retailer or Nikon-authorized service representative.

Flash Photography with Color Filters

Color compensation filters, a fluorescent filter and an incandescent filter are included with the SB-5000 for use with flash photography under incandescent/tungsten and fluorescent lighting. The color of ambient light and the flash light can be matched to provide natural color.

- Color filters (Color Filter Set SJ-5 and Color Filter Holder SZ-4) that change the color of the light emitted by the SB-5000 are available separately (□F-10).

Using color compensation filters and color filters

Filters	Purpose
Fluorescent filter (Fluorescent Filter SZ-4FL), included	Balance the color of light from the flash to match that of fluorescent lighting
Incandescent filter (Incandescent Filter SZ-4TN), included	Balance the color of light from the flash to match that of incandescent or tungsten lighting
Color filters (Color Filter Set SJ-5), optional	Create interesting effects by changing the color of the light emitted by the flash

Color compensation with included and optional filters

The included Incandescent Filter SZ-4TN and the optional SJ-5 incandescent filters TN-A1 and TN-A2 differ in color compensation. The color of images taken with the SZ-4TN and SJ-5 incandescent filters are slightly different even when the same light source is used. The color can be adjusted with the camera's white balance fine tuning.

■ How to attach color compensation filters (included)

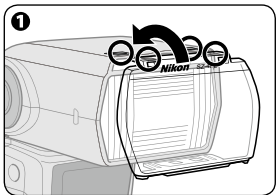

❶ Place the filter on the flash head and insert into the slit at the top.

- Place the filter with the Nikon logo facing up, as shown in the diagram.

❷ Check the LCD.

- Filter type is displayed.
- The information is transmitted from the SB-5000 to the camera.

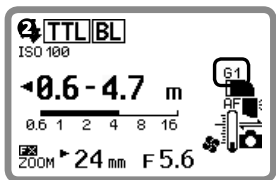

G1	Fluorescent filter
A1	Incandescent filter

How to attach SJ-5 color filters (optional)

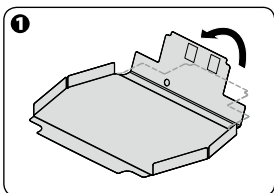

1 Fold along the line marked on the filter.

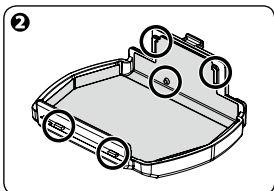

2 Attach the filter to Color Filter Holder SZ-4 (optional) as shown in the diagram.

- Insert the filter edges into the slits on the holder, and then align the filter positioning hole with the holder pin.
- Align the filter identification code (silver marks) with the black bar on the holder.
- Attach the filter to the filter holder without creasing the filter or leaving any gaps.

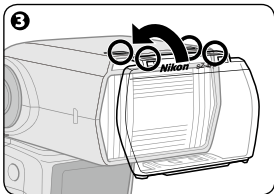

3 Place the filter holder on the flash head with the Nikon logo facing up, as shown in the diagram, and insert it into the slit at the top.

- Be sure to attach the filter to the filter holder before placing the filter holder on the flash head.

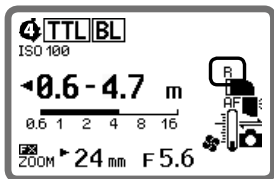

Red filter is attached

4 Check the LCD.

- The filter type is displayed.
- Be sure that nothing obstructs the filter detector.

G1	FL-G1 (fluorescent filter)	R	RED
G2	FL-G2 (fluorescent filter)	B	BLUE
A1	TN-A1 (incandescent filter)	Y	YELLOW
A2	TN-A2 (incandescent filter)	A	AMBER

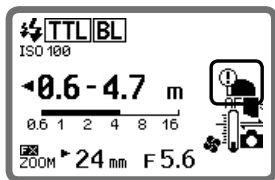

Warning indicator

- When the filter is not properly attached, the warning indicator shown left appears. Remove the filter and reattach.

Notes on using SJ-5 color filters

- These filters are consumable items. Replace them when they deteriorate or their colors fade.
- The heat generated from the flash head can warp the filters. However, this will not affect their performance.
- Scratches on the filters will have no effect on performance unless the filters fade in color.
- To remove dust or dirt, wipe the filter lightly with a soft, clean cloth.

Color compensation filters, color filters and camera's white balance settings

When a color compensation filter is attached to the SB-5000 while the camera's white balance is set to auto or flash, filter information is automatically transmitted to the camera, and the camera's optimum white balance is automatically adjusted to give the correct color temperature.

- When an SJ-5 color filter is attached to the SB-5000, set the camera's white balance to auto, flash or direct sunlight.
- When using the SB-5000 with a camera not equipped with filter detection (D2 series, D1 series, D200, D100, D80, D70 series, D60, D50, D40 series), set the camera's white balance according to the filter in use.
- For details about white balance, see the camera user's manual.

Flash Photography Support Functions

Flash exposure compensation

Exposure compensation for a flash-illuminated subject without affecting background exposure can be achieved by adjusting the SB-5000's flash output level.

- Some plus compensation may be necessary to make the main subject brighter, and some minus compensation to make it darker.
- Flash exposure compensation is possible in i-TTL, auto aperture flash, non-TTL auto flash and distance-priority manual flash modes.

Power zoom function

The SB-5000 automatically adjusts the zoom head position to match the lens focal length.

- Power zoom function is automatically activated when lens focal length information is transmitted from the attached camera to the SB-5000.
- Zoom head positions that can be automatically adjusted differ depending on the settings.

AF-assist illumination

When light is too low for normal autofocus operation, the SB-5000's AF-assist illumination enables autofocus photography.

- The SB-5000's AF-assist illumination is compatible with the multi-point AF system.
- AF-assist illumination cannot be used with non-CLS-compatible cameras and COOLPIX cameras.

Test firing

Pressing the test firing button determines whether the SB-5000 fires properly.

- The flash output level during test firing varies depending on settings and flash mode.
- In master mode with wireless multiple flash-unit photography using optical control, test firing of the SB-5000 is not possible. When the master flash unit test firing button is pressed, the remote flash units test fire one after another, beginning with group A.
- In master mode with wireless multiple flash-unit photography using radio control, when the master flash unit test firing button is pressed, the master flash unit test fires first, then the remote flash units test fire one after another, beginning with group A.

■ Modeling illumination

When the modeling illumination button is pressed, the flash fires repeatedly at a reduced flash output level. This is useful for checking the glare and shadows cast on a subject before actually taking the picture.

- The flash fires as a modeling illuminator for up to approx. 1 second.
- When the depth-of-field preview button on a camera compatible with modeling illumination is pressed, the modeling illuminator fires. For details, see the camera user's manual.

■ Advanced Wireless Lighting (D-17)

- When the master flash unit's modeling illumination button is pressed, the master flash unit fires as a modeling illuminator at a fixed flash output level (except when the flash function is canceled).
- When the camera's depth-of-field preview button is pressed, the master flash unit and remote flash unit groups whose flash functions are activated fire as modeling illuminators according to the set flash output level and the selected mode.

With optical control only

- When a remote flash unit group is highlighted on the master flash unit and the master flash unit's modeling illumination button is pressed, only the remote flash units in the selected group fire as modeling illuminators (except group A and B in quick wireless control).

■ Direct remote wireless multiple flash-unit photography

- Modeling illumination is not possible.

Standby function



If the SB-5000 and camera are not used for a specified time, the standby function is automatically activated to conserve battery power.

- The standby function is activated when the time interval on the camera's standby timer* expires (default setting). For details about the standby timer, see the camera user's manual.
- The standby activation lead time can be adjusted in the setup menu (□□B-22).
- * The standby timer is called "auto meter off" on some camera models.

To cancel standby

- Press the camera's shutter-release button halfway.
- Set the SB-5000's power switch to a position other than [OFF].
- Press the SB-5000's test firing button.

Thermal cut-out

The SB-5000 features a function that offers protection against damage to the flash panel and body from overheating. This function does not stop the flash head temperature rising. Be careful not to let the SB-5000 overheat during continuous flash use.

- The thermal cut-out indicator appears when the temperature of the flash head rises as a result of the flash being fired numerous times in quick succession. All operations except power ON/OFF and menu settings are suspended to prevent heat damage to the flash panel and body.

LCD at normal temperature

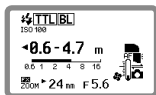

Thermal cut-out indicator



High temperature

- Wait until the SB-5000 cools down.
- Operation can be resumed once the warning is no longer displayed.
- On rare occasions, the thermal cut-out indicator might appear or disappear without the temperature changing depending on the zoom head position. This is not a malfunction.

■ Cooling system

The SB-5000's cooling system effectively cools down the flash head. It can extend the time before the thermal cut-out function starts operating. Choose [ON] or [OFF] in the setup menu.

- When it is set to [ON], an operating noise is produced after flash firing. If this causes problems, set the function to [OFF].
- When it is set to [ON], the batteries may become unusable before the estimates given (□F-20).
- While the cooling system is operating, the standby function is canceled.

Functions to Be Set on the Camera

The following functions are available when used with cameras so equipped. Set these functions on the camera. They cannot be set on the SB-5000 directly.

- For details about camera functions and settings, see the camera user's manual.
- Auto FP high-speed sync
- Flash value lock (FV lock)
- Slow sync
- Red-eye reduction
- Rear-curtain sync

Tips on Speedlight Care and Reference Information

This section explains troubleshooting, Speedlight care, specifications and optional accessories.

Troubleshooting

If a warning indicator appears, or any trouble occurs, use the following chart to determine the cause of the problem before taking the Speedlight to a retailer or Nikon-authorized service representative for repair.



Problems with the SB-5000





Problem	Cause	Solution	
The power cannot be turned on.	The batteries are not correctly installed.	Insert the batteries correctly.	B-14
	Battery power is weak.	Replace the batteries.	B-15
The flash-ready indicator does not light up.	The standby function is activated.	<ul style="list-style-type: none"> Press the camera shutter-release button halfway. Set the SB-5000's power switch to a position other than [OFF]. Press the SB-5000's test firing button. 	E-15
	Battery power is weak.	Replace the batteries.	B-15
The SB-5000 does not fire.	The flash function is canceled in the custom settings.	Activate the flash function in the custom settings.	B-22



Problem	Cause	Solution	
The effective flash output distance range does not appear.	The flash head is not set to the forward-facing position.	Set the flash head to the forward-facing position.	B-18
	Aperture and ISO sensitivity information has not been received from the camera.	<ul style="list-style-type: none"> • Check camera settings. • Detach and reattach the SB-5000 to the camera. 	—
	The SB-5000 cannot receive focal length information from the camera.	Turn the SB-5000 and camera off, and then turn them on again.	—
Zoom head position is not set automatically.	The built-in wide panel is in use or the Nikon Diffusion Dome is attached.	Remove the built-in wide panel or the Nikon Diffusion Dome.	E-3 E-6
	Power zoom function is canceled.	Activate the power zoom function.	E-12
Remote flash unit does not fire.	The distance between the master flash unit and the remote flash unit is too long, or there is an obstacle between them.	Change the positioning of the master flash unit and remote flash units.	D-23
	The light from the master flash unit has not entered the remote flash unit light sensor window for wireless remote flash in wireless multiple flash-unit photography using optical control.		
	A link with the remote flash unit has not been established in wireless multiple flash-unit photography using radio control.	Reset the link.	D-12

Problem	Cause	Solution	
The SB-5000 does not work properly.	Microcomputer may have malfunctioned if this occurs even when fresh batteries are properly installed.	<ul style="list-style-type: none"> Remove the batteries and insert them again, keeping the SB-5000's power switch set to a position other than [OFF]. If the problem continues, contact your retailer or Nikon-authorized service representative. 	B-14
Nonstandard display			
Dials or buttons do not operate.	Key lock is activated.	Cancel key lock.	B-8
The SB-5000 does not operate.	Thermal cut-out is active.	Wait until the SB-5000 cools down.	E-16

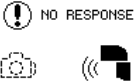
Warning indicators

Warning indicator	Cause	Solution	
	All operations have stopped due to low battery power.	Replace the batteries.	B-15
 	The flash function is canceled, and all operations except power ON/OFF and menu settings have been suspended because the SB-5000 has overheated and could become damaged.	<ul style="list-style-type: none"> Allow the SB-5000 to cool down, keeping the SB-5000's power switch set to a position other than [OFF]. If the cooling system is canceled, activate it in the setup menu. 	B-22 E-16

Warning indicator	Cause	Solution	
	All functions other than the power switch are inoperable because of power abnormalities.	Turn off the power, remove the batteries, and contact your retailer or Nikon-authorized service representative.	—
The flash-ready indicator flashes slowly after firing.	Underexposure may have occurred.	Use a wider aperture or move the flash unit closer to the subject and reshoot.	D-30
The remote flash unit emits 8 long beeps.	Underexposure may have occurred.	Use a wider aperture, move the flash unit closer to the subject or change the position of the flash unit and reshoot.	D-31
	Pairing has failed.	Check the channel and link mode setting and try again.	D-12
	The SB-5000 is attached to a camera not compatible with radio control.	Choose wireless multiple flash-unit photography using optical control.	D-5

Warning indicator	Cause	Solution	
	The attached color filter has not been detected.	Confirm whether the color filter is correctly attached.	E-7
F 5.6	There is no flash output that corresponds with the camera aperture used.	Reset the aperture.	—
F EE	The aperture is not at its maximum f-number.	Set the maximum f-number.	—
F	The camera is turned off.	Turn the camera on.	—
ZOOM Err	Power zoom function does not work properly.	<ul style="list-style-type: none"> • Turn the SB-5000 off and on again. • If the warning indicator remains, contact your retailer or Nikon-authorized service representative. 	—

Tips on Speedlight Care

Cleaning

- Dirt on the flash panel can cause it to break when the flash is fired. Clean the flash panel regularly.
- Use a blower to remove dust and lint, then wipe gently with a soft, dry cloth. After using the SB-5000 at the beach or seaside, wipe off sand or salt with a cloth lightly dampened in distilled water and then dry the product thoroughly by wiping it gently with a dry cloth.
- On rare occasions, the LCD may turn on or go dark, due to static electricity. This is not a malfunction. The display will soon return to normal.
- The SB-5000 contains a large amount of precision electronics. Do not subject it to shock or vibration. Do not apply strong pressure to the LCD panel.
- Never use thinner, benzene or other organic solvents when cleaning the Speedlight, as this may damage the Speedlight or cause it to catch fire. Using these agents may also impair your health.

Storage

To prevent mold or mildew, store the SB-5000 in a dry, well-ventilated area. If it is to be placed in storage for 2 weeks or more, remove the batteries to prevent damage caused by the batteries leaking. Take the device from storage about once a month and fire it 2 or 3 times to keep the condenser inside the unit from deteriorating. Do not store the device with naphtha or camphor moth balls, or in locations that:

- are in the vicinity of equipment that produces strong electromagnetic fields, or
- are exposed to extremely high temperatures that could cause product malfunction, such as next to a heater or in an enclosed vehicle on a hot day

Usage

- Sudden changes in temperature, such as those that occur when entering or leaving a heated building on a cold day, can cause condensation inside the device. To prevent condensation, place the device in a plastic bag or other sealed container before exposing it to sudden changes in temperature.
- Do not use the device in the vicinity of equipment that produces strong electromagnetic fields, such as transmission towers or high-voltage power lines. Failure to observe this precaution could cause product malfunction.

Notes on Batteries

- The large amounts of current used by the Speedlight may result in rechargeable batteries becoming unusable before reaching the manufacturer's stated recharge/discharge limit.
- When replacing the batteries, turn the product off and insert the replacement batteries in the correct orientation.
- Dirt on the battery terminals can interrupt the flow of current. Clean dirt from the terminals before inserting the batteries.
- After being fired multiple times in quick succession, the Speedlight may stop operating to allow the batteries to cool depending on battery specifications. Normal operation can be resumed once the batteries have cooled sufficiently.
- Batteries tend to lose capacity at low temperatures, recover lost voltage when allowed to rest, and slowly discharge when not in use. Be sure to check the battery level before use and replace the batteries before they are fully discharged.
- Do not store batteries in locations subject to high temperatures or high humidity.
- For information on handling and recharging rechargeable batteries, see the documentation provided by the manufacturers of the batteries and the battery charger.
- Do not attempt to recharge non-rechargeable batteries. Failure to observe this precaution could cause the batteries to rupture.



Recycling rechargeable batteries

Used batteries are a valuable resource; to protect the environment, recycle used batteries in accord with local regulations.

About the LCD Panel

■ Characteristics of the LCD panel

- Due to the directional characteristics of LCDs, the LCD panel is difficult to read when viewed from above. However, it can be seen clearly from a somewhat lower angle.
- The LCD panel becomes darker at high temperatures, but returns to normal when the temperature decreases.
- The LCD's response time slows down at low temperatures, but returns to normal when the temperature increases.

■ LCD panel illuminator ON/OFF

Any button or switch will activate the SB-5000 illuminator (when the SB-5000 power is on) to make the LCD panel easier to read.

- The illuminator goes off if the SB-5000 is not operated for 16 seconds.
- The LCD panel illumination can be canceled in the setup menu (☰B-22).
- Even when the LCD panel illumination is canceled in the setup menu, the SB-5000's LCD panel illuminator lights up when the camera's control panel illuminator lights up.

■ Adjusting the LCD panel's contrast

The contrast of the LCD panel can be adjusted in the setup menu (☰B-22).

- There are 9 contrast levels.

Optional Accessories

■ Speedlight Stand AS-22

Same as that provided with this SB-5000.



■ Color Filter Set SJ-5

A total of 8 types of 20 filters are included. These are used with the separately available Color Filter Holder SZ-4.

Compatible Speedlight

SB-5000

Filter parts

- 1 Filter positioning hole
- 2 Filter identification code (silver marks)
- 3 Filter type
- 4 Folding line

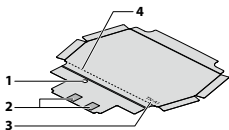

Contents of this set

8 types of 20 filters and a filter case

Filters	Purpose
Fluorescent filters (FL-G1 × 2, FL-G2 × 2)	Balance the color of light from the flash to match that of fluorescent lighting
Incandescent filters (TN-A1 × 2, TN-A2 × 2)	Balance the color of light from the flash to match that of incandescent or tungsten lighting
Color filters (RED × 4, BLUE × 4, YELLOW × 2, AMBER × 2)	Create interesting effects by changing the color of the light emitted by the flash

- Corresponding light source for each type of color compensation filter differs slightly. FL-G1 provides a greater compensation effect than FL-G2, and TN-A1, greater than TN-A2. Select the appropriate filter according to the results.
- When using a SJ-5 color filter, be sure to attach it to the optional Color Filter Holder SZ-4.

■ Color Filter Holder SZ-4

Used with SJ-5 color filters

■ Water Guard WG-AS4

Used to help prevent water entering the camera's accessory shoe contact when the SB-5000 is attached to a Nikon D5 digital SLR camera

- The Water Guard is to help prevent water dripping from the Speedlight into the camera's accessory shoe contact.
- It is not designed to protect the unit itself from water.

Compatible Speedlight

SB-5000

Water Guard parts

- 1 Fixing nails

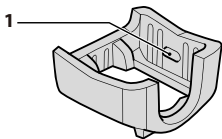
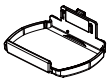

Attaching the Water Guard

- 1 **Make sure the SB-5000 and the camera are turned off.**
- 2 **Make sure the mounting foot lock lever is on the left (white dot).**
- 3 **Cover the Speedlight's mounting foot with the WG-AS4.**
 - Lightly pushing the WG-AS4 will secure the fixing nails to the Speedlight's mounting groove.
- 4 **Slide the Speedlight with the Water Guard into the camera's accessory shoe.**
 - Check that the Water Guard is properly attached and there are no openings or gaps.
- 5 **Turn the Speedlight's mounting foot lock lever to the right to L.**

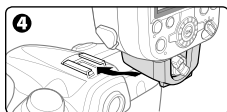
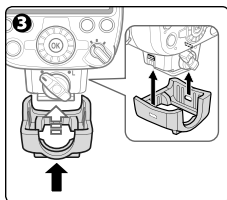
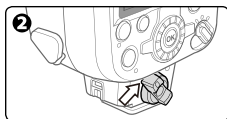

Detaching the Water Guard

- 1 **Make sure the SB-5000 and the camera are turned off, turn the mounting foot lock lever 90° to the left, and then slide the SB-5000's mounting foot from the camera's accessory shoe.**
- 2 **Detach the Water Guard by pulling the Water Guard body downward.**

Care

Wipe any water from the Water Guard before storing.

Specifications

Dimensions (W × H × D): approx. 39 × 21.5 × 48 mm
(1.6 × 0.9 × 1.9 in.)

Weight: approx. 8 g (0.3 oz.)

Specifications and design are subject to change without notice.

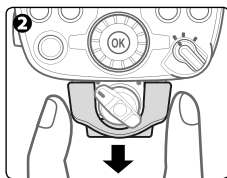
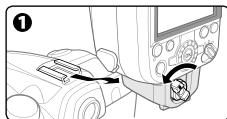

■ Wireless Slave Flash Controller SU-4

Useful for wireless multiple flash-unit photography, the SU-4 features a built-in, movable light sensor and an accessory shoe for attachment of a remote flash unit. The SU-4's light sensor triggers the remote flash unit to fire in sync with the master flash unit.



■ Soft Case SS-DC2 (accessory pouch)

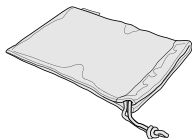

■ TTL Remote Cord SC-28/17 (approx. 1.5 m/4.9 ft)

The SC-28/17 enables i-TTL mode when the SB-5000 is used off-camera. The flash shoe comes with a tripod socket.

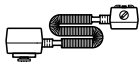

■ TTL Remote Cord SC-29 (approx. 1.5 m/4.9 ft)

The SC-29 enables i-TTL mode when the SB-5000 is used off-camera. The SC-29 features an AF-assist illumination function.

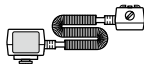

External power source

Use of an optional external power source provides a stable power supply, increases the number of flashes and shortens recycling time.

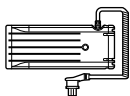

Nikon High-performance
Battery Pack SD-9

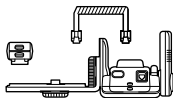

Power Bracket Unit
SK-6/SK-6A



Nikon DC
Unit SD-7



Nikon High-performance
Battery Pack
SD-8A

- Batteries are required in the SB-5000 body even when an external power source is used.
- Use of other external power source brands may cause accidents, or could damage the Speedlight components. Nikon cannot guarantee the Speedlight performance when used with non-Nikon products.
- The flash panel and flash head may become hot if the flash is fired multiple times in quick succession.
- When the SB-5000 is used with the SK-6/SK-6A, autofocus operation with the SB-5000's AF-assist illumination is not possible.
- When used with the SD-8A or SK-6/SK-6A, the SB-5000 may fire using power provided only by the batteries in the SB-5000 and not from the SD-8A or SK-6/SK-6A. This is not a malfunction.

Connecting to an external power source

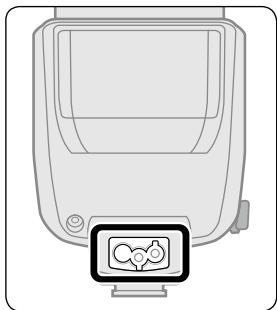

To use an external power source, remove the external power source terminal cover and connect the power cord to the terminal.

- Do not use Power Cord SC-16 when connecting the SB-5000 to the Nikon DC Unit SD-7; use the SC-16A instead.

✓ Using High-performance Battery Pack SD-9 or SD-8A

Conducting continuous flash photography at 8 fps using the SD-9 with 8 batteries or SD-8A with 6 batteries can cause the front part of the flash head to heat up. In flash photography, attaching the SD-9 or SD-8A to the camera may cause some lineal noise to appear in the image. If this is the case, set a lower ISO sensitivity or detach the SD-9 or SD-8A from the camera and use separately.

Specifications

Electronic construction	Automatic Insulated Gate Bipolar Transistor (IGBT) and series circuitry
Guide number (at 35 mm zoom head position, in FX format, standard illumination pattern)	34.5/113 (ISO 100, m/ft)
Effective flash output distance range (in i-TTL, auto aperture flash or non-TTL auto flash mode)	0.6 m to 20 m (2 ft to 65.6 ft) (varies depending on camera's image area setting, illumination pattern, ISO sensitivity, zoom head position, and lens aperture in use)
Illumination pattern	There are 3 illumination patterns: standard, even, center-weighted The light distribution angle is automatically adjusted to the camera's image area in both FX and DX formats
Available flash mode	<ul style="list-style-type: none"> • i-TTL • Auto aperture flash • Non-TTL auto flash • Distance-priority manual flash • Manual flash • Repeating flash
Other available functions	Test firing, monitor pre-flashes, AF-assist illumination for multi-point AF and modeling illumination
Nikon Creative Lighting System (CLS)	A number of flash operations are available with compatible cameras: i-TTL mode, Advanced Wireless Lighting, modeling illumination, FV lock, Flash Color Information Communication, auto FP high-speed sync, AF-assist illumination for multi-point AF and unified flash control

Multiple flash-unit photography operation	<ul style="list-style-type: none"> • Advanced Wireless Lighting • Direct remote wireless multiple flash-unit photography (remote mode)
Bounce capability	<p>Flash head tilts down to 7° or up to 90° with click-stops at -7°, 0°, 45°, 60°, 75°, 90°</p> <p>Flash head rotates horizontally 180° to the left and right with click-stops at 0°, 30°, 60°, 75°, 90°, 120°, 150°, 180°</p>
Power ON/OFF	<p>Rotate the power switch to turn the SB-5000 on or off</p> <p>Standby function can also be set</p>
Power source	<p>Use 4 AA-size batteries of the same brand from any of the following types:</p> <ul style="list-style-type: none"> • 1.5 V LR6 (AA-size) alkaline batteries • 1.2 V HR6 (AA-size) rechargeable Ni-MH batteries <p>For minimum number of flashes and recycling time for each battery type, see F-20</p>
Flash-ready indicator	<p>The SB-5000 is fully recycled: lights up</p> <p>Insufficient flash output for correct exposure (in i-TTL, auto aperture flash, non-TTL auto flash or distance-priority manual flash mode, or AUTO mode in direct remote wireless multiple flash-unit photography): flashes slowly</p>
AF-assist illuminator (in remote mode)	<p>The SB-5000 is fully recycled: flashes slowly and goes out</p> <p>Insufficient flash output for correct exposure (in i-TTL, auto aperture flash or non-TTL auto flash mode, or AUTO mode in direct remote wireless multiple flash-unit photography): flashes slowly</p>

Flash duration (approx.)	1/980 s at M1/1 (full) output 1/1110 s at M1/2 output 1/2580 s at M1/4 output 1/5160 s at M1/8 output 1/8890 s at M1/16 output 1/13470 s at M1/32 output 1/18820 s at M1/64 output 1/24250 s at M1/128 output 1/30820 s at M1/256 output
Mounting foot lock lever	Provides secure attachment of the SB-5000 to camera's accessory shoe using locking plate and locking pin to prevent unintentional detachment
Flash exposure compensation	-3.0 EV to +3.0 EV in increments of 1/3 EV steps in i-TTL, auto aperture flash, non-TTL auto flash or distance-priority manual flash mode
Menu settings	24 items
Other functions	ISO sensitivity manual setting, redisplay of amount of underexposure due to insufficient flash output in i-TTL mode, reset to the default settings, key lock, thermal cut-out, firmware update
Dimensions (W × H × D)	Approx. 73 × 137 × 103.5 mm (2.9 × 5.4 × 4.1 in.)
Weight	Approx. 520 g (18.4 oz) (with 1.5 V LR6 (AA-size) alkaline batteries × 4) Approx. 420 g (14.9 oz) (Speedlight only)

Accessories supplied	Speedlight Stand AS-22, Nikon Diffusion Dome SW-15H , Fluorescent Filter SZ-4FL, Incandescent Filter SZ-4TN, Soft Case SS-5000, Accessory pouch
-----------------------------	--

- Products and brand names are trademarks or registered trademarks of their respective companies.

Specifications and design are subject to change without notice. Nikon will not be held liable for damages that may result from any mistakes that this manual may contain. Unless otherwise stated, all figures are compliant with Camera and Imaging Products Association (CIPA) standards or guidelines.

Minimum number of flashes/recycling time for each battery type

Batteries	Min. recycling time (approx.)*1	Min. number of flashes*2/recycling time*1
1.5 V LR6 (AA-size) alkaline battery	2.6 s	150/2.6 – 30 s
1.2 V HR6 (AA-size) rechargeable Ni-MH battery	1.8 s	190/1.8 – 30 s

*1 Time between flash firing at full power and the flash-ready indicator illuminating when flash is fired once every 30 seconds

*2 Number of times flash can be fired at full power with flash-ready indicator illuminating within 30 seconds

- Compliant with Camera and Imaging Products Association (CIPA) standards.
- While AF-assist illumination, power zoom and LCD panel illumination are off.
- Figures are for fresh batteries; actual results may vary with performance and other factors even among batteries of identical ages and makes.

Effective flash output distance range (for i-TTL mode, auto aperture flash mode, non-TTL auto flash mode)

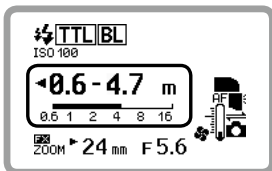

The effective flash output distance range of the SB-5000 is between 0.6 m and 20 m (2 ft and 65.6 ft). The effective flash output distance range differs depending on the camera's image area setting, illumination pattern, ISO sensitivity, zoom head position and aperture.

- The effective flash output distance range for each setting is displayed on the LCD panel.





Warranty Terms - NIKON

WORLDWIDE SERVICE WARRANTY

- 1) Your Nikon product is guaranteed against any manufacturing defects for one full year from the date of purchase.
- 2) To validate the warranty card, you are requested to fill in all necessary information (Customer's name, address, and date of purchase). The warranty card together with the original purchase receipt must be presented to the Nikon authorized service facility before any repair can be made under warranty.
- 3) All costs, including mail, transportation, insurance and other incidental charges in relation to repair work, are at your expense. All other claims of any nature are not covered.
- 4) THIS WARRANTY DOES NOT APPLY TO ANY OF THE FOLLOWINGS:
 - DEFECTS ON MALFUNCTIONS CAUSED BY DAMAGE RESULTING FROM IMPROPER CARE, MISUSE OR ABUSE OF THIS PRODUCT, OR OPERATION OF THIS PRODUCT CONTRARY TO THE INSTRUCTIONS CONTAINED IN THE OWNER'S MANUAL.
 - DAMAGE OR DEFECT CAUSED BY ACCIDENT, SAND, WATER OR BATTERY LEAKAGE.
 - DAMAGE CAUSED DURING TRANSPORTATION OR MAIL.
 - DAMAGE CAUSED BY ANY MODIFICATION OR SERVICING PERFORMED BY PERSON(S) OTHER THAN NIKON AUTHORIZED SERVICE FACILITY.
 - ACCESSORIES, INCLUDING BATTERIES AND AC ADAPTER, AND OTHER CONSUMABLES.
 - ANY ELECTRONIC DATA LOSS DUE TO MALFUNCTIONING OR REPAIR OF THIS PRODUCT.
 - ANY CONSEQUENTIAL OR INCIDENTAL DAMAGES RESULTING FROM ANY BREACH OF WARRANTY, EXPRESS OR IMPLIED, APPLICABLE TO THIS PRODUCT.
- 5) The warranty card is issued only at the time of original purchase. It is nontransferable and will not be re-issued.

For information on authorized Nikon service facilities, visit <http://imaging.nikon.com/support/index.htm>

Nikon User Support

If you need any technical assistance with the operation of your Nikon product(s), please contact one of the Nikon representatives. For information on the Nikon representatives in your area, please visit <http://www.nikon-asia.com/support>.

Nikon Worldwide Service Warranty Card

Model name

SB-5000

Serial No.

Purchase date

■ Name and address of customer

■ Dealer

■ Manufacturer

NIKON CORPORATION

No reproduction in any form of this manual, in whole or in part (except for brief quotation in critical articles or reviews), may be made without written authorization from NIKON CORPORATION.

NIKON CORPORATION

© 2015 Nikon Corporation

Printed in Singapore



TT6B02(11)
8MSA8811-02