

Nikon

DIGITAL CAMERA

Z 5

User's Manual

Getting to Know the Camera	1
First Steps	5
Basic Photography and Playback	15
Technical Notes	20
Kit Lens	47

En

- Read this manual thoroughly before using the camera.
- To ensure proper use of the camera, be sure to read "For Your Safety" (page xv).
- After reading this manual, keep it in a readily accessible place for future reference.



Scan for detailed operating instructions.

nikon download center Z 5



Package Contents

Be sure all items listed here were included with your camera.

- Camera



- BF-N1 body cap



- DK-29 rubber eyecup
(comes attached to camera)



- EN-EL15c rechargeable Li-ion battery with terminal cover
- MH-25a battery charger (comes with either an AC wall adapter or power cable of a type and shape that varies with the country or region of sale)
- Strap
- Warranty (printed on the back cover of this manual)
- User's Manual*
- UC-E24 USB cable
- BS-1 accessory shoe cover

- Memory cards are sold separately.
- Purchasers of the lens kit option should confirm that the package also includes a lens. Manuals for the lens may also be provided.

Z 5 Model Name: N1933

✔ The Nikon Download Center



A pdf version of this manual is available from the Nikon Download Center, together with an English-language *reference manual* with detailed operating instructions, which can be viewed online in html. Visit the Nikon Download Center to download firmware updates, NX Studio and other Nikon software, and manuals for Nikon products including cameras, NIKKOR lenses, and flash units.
<https://downloadcenter.nikonimglib.com/>



About This Manual

■ Symbols

The following symbols and conventions are employed in this manual. Use them to help locate the information you need.

	This icon marks notes, information that should be read before using this product.
	This icon marks tips, additional information you may find helpful when using this product.
	This icon marks references to other sections in this manual.

■ Conventions

- This camera uses SD, SDHC, and SDXC memory cards, referred to throughout this manual as “memory cards”. SD, SDHC, and SDXC may also on occasion be referred to as “SD memory cards”.
- Throughout this manual, battery chargers are referred to as “battery chargers” or “chargers”.
- Throughout this manual, the display in camera monitor and viewfinder during shooting is referred to as the “shooting display”; in most cases, the illustrations show the monitor.
- Throughout this manual, smartphones and tablets are referred to as “smart devices”.
- Throughout this manual, the term “default settings” is used to refer to the settings in effect at shipment. The explanations in this manual assume that default settings are used.

⚠ For Your Safety



“For Your Safety” contains important safety instructions. Be sure to read them before using the camera. For more information, see “For Your Safety” (□ xv).

■ Nikon User Support

Visit the site below to register your camera and keep up-to-date with the latest product information. You will find answers to frequently asked questions (FAQs) and can contact us for technical assistance.

<https://www.europe-nikon.com/support>

Table of Contents

Package Contents.....	ii
About This Manual	iv
Menu List	viii
For Your Safety	xv
Notices.....	xx
Getting to Know the Camera	1
<hr/>	
Parts of the Camera.....	1
Camera Body	1
First Steps	5
<hr/>	
Charging the Battery	5
Inserting the Battery.....	7
Removing the Battery	7
Inserting Memory Cards.....	8
Removing Memory Cards	8
Attaching a Lens	9
Detaching Lenses.....	10
Choose a Language and Set the Clock	11
Basic Photography and Playback	15
<hr/>	
Taking Photographs ( Auto)	15
Shooting Movies ( Mode)	17
Playback.....	18
Viewing Photos.....	18
Viewing Movies	19

Technical Notes **20**

Specifications	20
Nikon Z 5 Digital Camera	20
Approved Memory Cards.....	33
Portable Chargers (Power Banks)	34
Trademarks and Licenses.....	35
Notices	39
Bluetooth and Wi-Fi (Wireless LAN)	41

Kit Lens **47**

NIKKOR Z 24–70mm f/4 S Lens	47
Parts of the Lens: Names and Functions	47
Specifications	48
NIKKOR Z 24–200mm f/4–6.3 VR Lens	49
Parts of the Lens: Names and Functions	49
Specifications	50
NIKKOR Z 24–50mm f/4–6.3 Lens	52
Parts of the Lens: Names and Functions	52
Specifications	53
Warranty Terms - Nikon Europe Service Warranty	55

Menu List

The camera offers the following menus. For a more complete description of individual menu items, refer to the “Menu Guide” chapter in the *Online Manual*.

PLAYBACK MENU	PHOTO SHOOTING MENU
Delete	Reset photo shooting menu
Playback folder	Storage folder
Playback display options	File naming
Dual-format recording PB slot	Role played by card in Slot 2
Image review	Choose image area
After delete	Image quality
Rotate tall	Image size
Copy image(s)	NEF (RAW) recording
Slide show	ISO sensitivity settings
Rating	White balance
	Set Picture Control
	Manage Picture Control
	Color space
	Active D-Lighting
	Long exposure NR
	High ISO NR
	Vignette control

PHOTO SHOOTING MENU

Diffraction compensation
Auto distortion control
Flicker reduction shooting
Metering
Flash control
Flash mode
Flash compensation
Focus mode
AF-area mode
Vibration reduction
Auto bracketing
Multiple exposure
HDR (high dynamic range)
Interval timer shooting
Time-lapse movie
Focus shift shooting
Silent photography

MOVIE SHOOTING MENU

Reset movie shooting menu
File naming
Destination
Choose image area
Frame size/frame rate
Movie quality
Movie file type
ISO sensitivity settings
White balance
Set Picture Control
Manage Picture Control
Active D-Lighting
High ISO NR
Vignette control
Diffraction compensation
Auto distortion control
Flicker reduction

MOVIE SHOOTING MENU

Metering

Focus mode

AF-area mode

Vibration reduction

Electronic VR

Microphone sensitivity

Attenuator

Frequency response

Wind noise reduction

Headphone volume

Timecode

CUSTOM SETTING MENU

Reset custom settings

a Autofocus

a1 AF-C priority selection

a2 AF-S priority selection

a3 Focus tracking with lock-on

a4 Auto-area AF face/eye
detection

a5 Focus points used

a6 Store points by orientation

a7 AF activation

a8 Limit AF-area mode
selection

a9 Focus point wrap-around

a10 Focus point options

a11 Low-light AF

a12 Built-in AF-assist
illuminatora13 Manual focus ring in AF
mode

CUSTOM SETTING MENU**b Metering/exposure**

b1	EV steps for exposure cntrl
b2	Easy exposure compensation
b3	Center-weighted area
b4	Fine-tune optimal exposure

c Timers/AE lock

c1	Shutter-release button AE-L
c2	Self-timer
c3	Power off delay

CUSTOM SETTING MENU**d Shooting/display**

d1	CL mode shooting speed
d2	Max. continuous release
d3	Sync. release mode options
d4	Exposure delay mode
d5	Shutter type
d6	File number sequence
d7	Apply settings to live view
d8	Framing grid display
d9	Peaking highlights
d10	View all in continuous mode

CUSTOM SETTING MENU

e Bracketing/flash

e1	Flash sync speed
e2	Flash shutter speed
e3	Exposure comp. for flash
e4	Auto  ISO sensitivity control
e5	Modeling flash
e6	Auto bracketing (mode M)
e7	Bracketing order

CUSTOM SETTING MENU

f Controls

f1	Customize  menu
f2	Custom controls
f3	OK button
f4	Shutter spd & aperture lock
f5	Customize command dials
f6	Release button to use dial
f7	Reverse indicators

g Movie

g1	Customize  menu
g2	Custom controls
g3	OK button
g4	AF speed
g5	AF tracking sensitivity
g6	Highlight display

SETUP MENU	SETUP MENU
Format memory card	Beep options
Save user settings	Touch controls
Reset user settings	HDMI
Language	Location data
Time zone and date	Wireless remote (WR) options
Monitor brightness	Assign remote (WR) Fn button
Monitor color balance	Airplane mode
Viewfinder brightness	Connect to smart device
Viewfinder color balance	Connect to PC
Limit monitor mode selection	Conformity marking
Information display	Battery info
AF fine-tuning options	USB power delivery
Non-CPU lens data	Energy saving
Clean image sensor	Slot empty release lock
Image Dust Off ref photo	Save/load menu settings
Pixel mapping	Reset all settings
Image comment	Firmware version
Copyright information	

RETOUCH MENU

NEF (RAW) processing

Trim

Resize

D-Lighting

Red-eye correction

Straighten

Distortion control

Perspective control

Monochrome

Image overlay

Trim movie

MY MENU

Add items

Remove items

Rank items

Choose tab

For Your Safety

To prevent damage to property or injury to yourself or to others, read “For Your Safety” in its entirety before using this product.

Keep these safety instructions where all those who use this product will read them.

⚠ DANGER: Failure to observe the precautions marked with this icon carries a high risk of death or severe injury.

⚠ WARNING: Failure to observe the precautions marked with this icon could result in death or severe injury.

⚠ CAUTION: Failure to observe the precautions marked with this icon could result in injury or property damage.

⚠ WARNING

Do not use while walking or operating a vehicle.

Failure to observe this precaution could result in accidents or other injury.

Do not disassemble or modify this product. Do not touch internal parts that become exposed as the result of a fall or other accident.

Failure to observe these precautions could result in electric shock or other injury.

Should you notice any abnormalities such as the product producing smoke, heat, or unusual odors, immediately disconnect the battery or power source.

Continued operation could result in fire, burns or other injury.

Keep dry. Do not handle with wet hands. Do not handle the plug with wet hands.

Failure to observe these precautions could result in fire or electric shock.

Do not let your skin remain in prolonged contact with this product while it is on or plugged in.

Failure to observe this precaution could result in low-temperature burns.

Do not use this product in the presence of flammable dust or gas such as propane, gasoline or aerosols.

Failure to observe this precaution could result in explosion or fire.

Do not directly view the sun or other bright light source through the lens.

Failure to observe this precaution could result in visual impairment.

Do not aim the flash or AF-assist illuminator at the operator of a motor vehicle.

Failure to observe this precaution could result in accidents.

Keep this product out of reach of children.

Failure to observe this precaution could result in injury or product malfunction. In addition, note that small parts constitute a choking hazard. Should a child swallow any part of this product, seek immediate medical attention.

Do not entangle, wrap or twist the straps around your neck.

Failure to observe this precaution could result in accidents.

Do not use batteries, chargers, or AC adapters not specifically designated for use with this product. When using batteries, chargers, and AC adapters designated for use with this product, do not:

- **Damage, modify, forcibly tug or bend the cords or cables, place them under heavy objects, or expose them to heat or flame.**
- **Use travel converters or adapters designed to convert from one voltage to another or with DC-to-AC inverters.**

Failure to observe these precautions could result in fire or electric shock.

Do not handle the plug when charging the product or using the AC adapter during thunderstorms.

Failure to observe this precaution could result in electric shock.

Do not handle with bare hands in locations exposed to extremely high or low temperatures.

Failure to observe this precaution could result in burns, or frostbite.

 **CAUTION**

Do not leave the lens pointed at the sun or other strong light sources.

Light focused by the lens could cause fire or damage to product's internal parts. When shooting backlit subjects, keep the sun well out of the frame. Sunlight focused into the camera when the sun is close to the frame could cause fire.

Turn this product off when its use is prohibited. Disable wireless features when the use of wireless equipment is prohibited.

The radio-frequency emissions produced by this product could interfere with equipment onboard aircraft or in hospitals or other medical facilities.

Remove the battery and disconnect the AC adapter if this product will not be used for an extended period.

Failure to observe this precaution could result in fire or product malfunction.

Do not fire the flash in contact with or in close proximity to the skin or objects.

Failure to observe this precaution could result in burns or fire.

Do not leave the product where it will be exposed to extremely high temperatures, for an extended period such as in an enclosed automobile or in direct sunlight.

Failure to observe this precaution could result in fire or product malfunction.

Do not look directly at the AF-assist illuminator.

Failure to observe this precaution could have adverse effects on vision.

Do not transport cameras or lenses with tripods or similar accessories attached.

Failure to observe this precaution could result in injury or product malfunction.

DANGER (Batteries)

Do not mishandle batteries.

Failure to observe the following precautions could result in the batteries leaking, overheating, rupturing, or catching fire:

- Use only rechargeable batteries approved for use in this product.
 - Do not expose batteries to flame or excessive heat.
 - Do not disassemble.
 - Do not short-circuit the terminals by touching them to necklaces, hairpins, or other metal objects.
 - Do not expose batteries or the products in which they are inserted to powerful physical shocks.
 - Do not step on batteries, pierce them with nails, or strike them with hammers.
-

Charge only as indicated.

Failure to observe this precaution could result in the batteries leaking, overheating, rupturing, or catching fire.

If battery liquid comes into contact with the eyes, rinse with plenty of clean water and seek immediate medical attention.

Delaying action could result in eye injuries.

Follow the instructions of airline personnel.

Batteries left unattended at high altitudes in an unpressurized environment may leak, overheat, rupture, or catch fire.

 **WARNING (Batteries)**

Keep batteries out of reach of children.

Should a child swallow a battery, seek immediate medical attention.

Keep batteries out of reach of household pets and other animals.

The batteries could leak, overheat, rupture, or catch fire if bitten, chewed, or otherwise damaged by animals.

Do not immerse batteries in water or expose to rain.

Failure to observe this precaution could result in fire or product malfunction. Immediately dry the product with a towel or similar object should it become wet.

Discontinue use immediately should you notice any changes in the batteries, such as discoloration or deformation. Cease charging EN-EL15c rechargeable batteries if they do not charge in the specified period of time.

Failure to observe these precautions could result in the batteries leaking, overheating, rupturing, or catching fire.

When batteries are no longer needed, insulate the terminals with tape.

Overheating, rupture, or fire may result should metal objects come into contact with the terminals.

If battery liquid comes into contact with a person's skin or clothing, immediately rinse the affected area with plenty of clean water.

Failure to observe this precaution could result in skin irritation.

Notices

- No part of the manuals included with this product may be reproduced, transmitted, transcribed, stored in a retrieval system, or translated into any language in any form, by any means, without Nikon's prior written permission.
- Nikon reserves the right to change the appearance and specifications of the hardware and software described in these manuals at any time and without prior notice.
- Nikon will not be held liable for any damages resulting from the use of this product.
- While every effort has been made to ensure that the information in these manuals is accurate and complete, we would appreciate it were you to bring any errors or omissions to the attention of the Nikon representative in your area (address provided separately).

● **Notice Concerning Prohibition of Copying or Reproduction**

Note that simply being in possession of material that has been digitally copied or reproduced by means of a scanner, digital camera, or other device may be punishable by law.

• **Items prohibited by law from being copied or reproduced**

Do not copy or reproduce paper money, coins, securities, government bonds, or local government bonds, even if such copies or reproductions are stamped "Sample".

The copying or reproduction of paper money, coins, or securities which are circulated in a foreign country is prohibited.

Unless the prior permission of the government has been obtained, the copying or reproduction of unused postage stamps or post cards issued by the government is prohibited.

The copying or reproduction of stamps issued by the government and of certified documents stipulated by law is prohibited.

- **Cautions on certain copies and reproductions**

The government has issued cautions on copies or reproductions of securities issued by private companies (shares, bills, checks, gift certificates, etc.), commuter passes, or coupon tickets, except when a minimum of necessary copies are to be provided for business use by a company. Also, do not copy or reproduce passports issued by the government, licenses issued by public agencies and private groups, ID cards, and tickets, such as passes and meal coupons.

- **Comply with copyright notices**

Under copyright law, photographs or recordings of copyrighted works made with the camera cannot be used without the permission of the copyright holder. Exceptions apply to personal use, but note that even personal use may be restricted in the case of photographs or recordings of exhibits or live performances.

- **Use Only Nikon Brand Electronic Accessories**

Nikon cameras are designed to the highest standards and include complex electronic circuitry. Only Nikon brand electronic accessories (including lenses, chargers, batteries, AC adapters, and flash accessories) certified by Nikon specifically for use with this Nikon digital camera are engineered and proven to operate within the operational and safety requirements of this electronic circuitry.

The use of non-Nikon electronic accessories could damage the camera and may void your Nikon warranty. The use of third-party rechargeable Li-ion batteries not bearing the Nikon holographic seal shown at right could interfere with normal operation of the camera or result in the batteries overheating, igniting, rupturing, or leaking.



For more information about Nikon brand accessories, contact a local authorized Nikon dealer.

✔ Before Taking Important Pictures

Before taking pictures on important occasions (such as at weddings or before taking the camera on a trip), take a test shot to ensure that the camera is functioning normally. Nikon will not be held liable for damages or lost profits that may result from product malfunction.

✔ Life-Long Learning

As part of Nikon's "Life-Long Learning" commitment to ongoing product support and education, continually-updated information is available on-line at the following sites:

- **For users in the U.S.A.:** <https://www.nikonusa.com/>
- **For users in Europe:** <https://www.europe-nikon.com/support/>
- **For users in Asia, Oceania, the Middle East, and Africa:**
<https://www.nikon-asia.com/>

Visit these sites to keep up-to-date with the latest product information, tips, answers to frequently-asked questions (FAQs), and general advice on digital imaging and photography. Additional information may be available from the Nikon representative in your area. See the following URL for contact information: <https://imaging.nikon.com/>

Getting to Know the Camera

Parts of the Camera

Camera Body

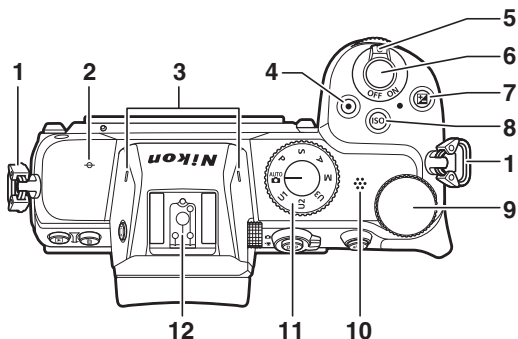

1 Eyelet for camera strap

2 \ominus (focal plane mark)

3 Stereo microphone (□17)

4 Movie-record button (□17)

5 Power switch (□11, 15)

6 Shutter-release button (□15)

7 button

8 **ISO** button

9 Main command dial

10 Speaker

11 Mode dial

12 Accessory shoe (for optional flash unit)

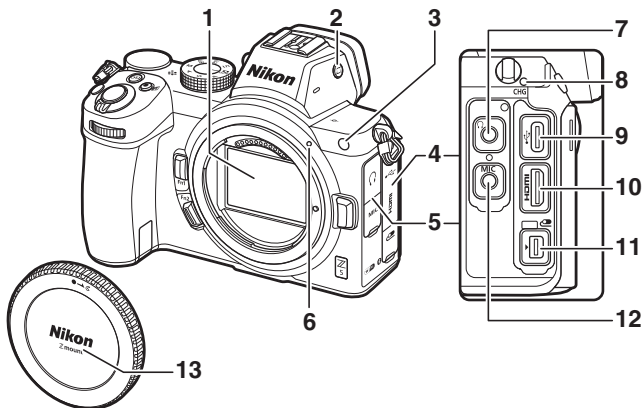

1 Image sensor

2 |□| button

3 AF-assist illuminator
Red-eye reduction lamp
Self-timer lamp

4 Cover for accessory terminal
and USB and HDMI connectors

5 Cover for headphone and
microphone connectors

6 Lens mounting mark (□9)

7 Headphone connector

8 Charge lamp

9 USB connector

10 HDMI connector

11 Accessory terminal

12 Connector for external
microphone

13 Body cap (□9)

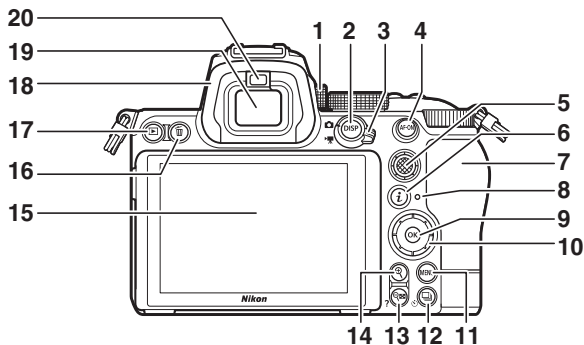

- | | |
|----|--------------------------------|
| 1 | Diopter adjustment control |
| 2 | DISP button |
| 3 | Photo/movie selector (15, 17) |
| 4 | AF-ON button |
| 5 | Sub-selector |
| 6 | i button |
| 7 | Memory card slot cover (8) |
| 8 | Memory card access lamp |
| 9 | OK button |
| 10 | Multi selector |

- | | |
|----|--------------------|
| 11 | MENU button |
| 12 | (C) button |
| 13 | ? button |
| 14 | Q button |
| 15 | Monitor |
| 16 | button |
| 17 | button (18) |
| 18 | Rubber eyecup |
| 19 | Viewfinder |
| 20 | Eye sensor |

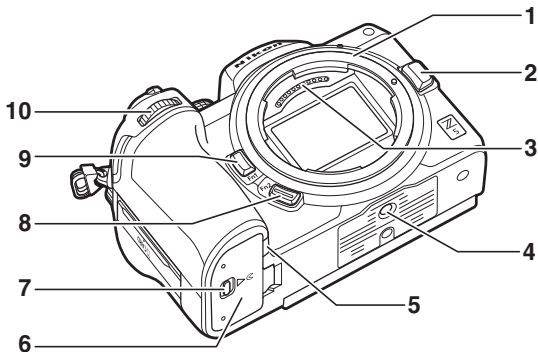

- | | |
|--|---|
| <p>1 Lens mount (☞9)</p> <p>2 Lens release button (☞10)</p> <p>3 CPU contacts</p> <p>4 Tripod socket</p> <p>5 Power connector cover</p> | <p>6 Battery-chamber cover</p> <p>7 Battery-chamber cover latch</p> <p>8 Fn2 button</p> <p>9 Fn1 button</p> <p>10 Sub-command dial</p> |
|--|---|

☑ Product Serial Number

The serial number for this product can be found by opening the monitor.

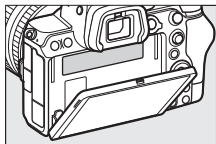

First Steps

Charging the Battery

Charge the supplied EN-EL15c battery in the supplied MH-25a battery charger before use. Insert the battery and plug the charger in (depending on the country or region, the charger comes with either an AC wall adapter or a power cable).

✔ The Battery and Charger

Read and follow the warnings and cautions in "For Your Safety" (□ xv).

- **AC wall adapter:** After inserting the AC wall adapter into the charger AC inlet (①), slide the AC wall adapter latch as shown (②) and rotate the adapter 90° to fix it in place (③).

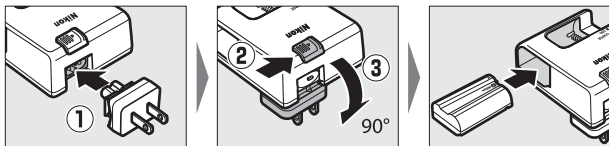

- **Power cable:** After connecting the power cable with the plug in the orientation shown, insert the battery and plug the cable in.

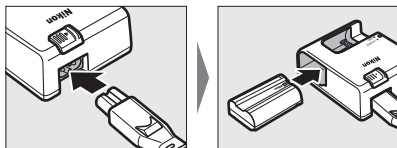

- An exhausted battery will fully charge in about 2 hours and 35 minutes.

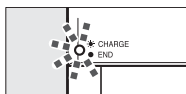

Battery charging (flashes)

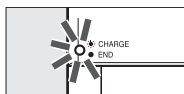

Charging complete (steady)

☑ If the CHARGE Lamp Flashes Rapidly

If the **CHARGE** lamp flashes rapidly (8 times a second):

- **A battery charging error has occurred:** Unplug the charger and remove and reinsert the battery.
- **The ambient temperature is too hot or too cold:** Use the battery charger at temperatures within the designated temperature range (0–40 °C/+32–104 °F).

If the problem persists, unplug the charger and end charging. Bring the battery and charger to a Nikon-authorized service representative.

Inserting the Battery

- Turn the camera off before inserting or removing the battery.
- Using the battery to keep the orange battery latch pressed to one side, slide the battery into the battery chamber until the latch locks it in place.

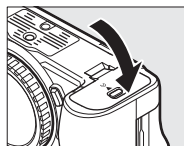
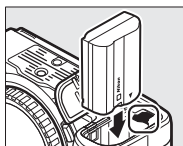
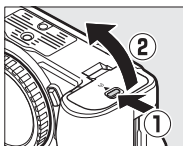

Removing the Battery

To remove the battery, turn the camera off and open the battery-chamber cover. Press the battery latch in the direction shown by the arrow to release the battery and then remove the battery by hand.

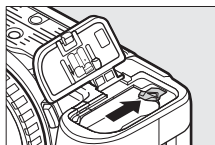

Inserting Memory Cards

- Turn the camera off before inserting or removing memory cards.
- The camera is equipped with two memory card slots: Slot 1 (①) and Slot 2 (②), allowing use of two memory cards. If you are using only one memory card, insert it into Slot 1.

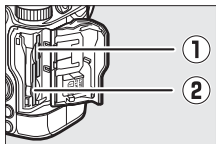

- Holding the memory card in the orientation shown, slide it straight into the slot until it clicks into place.

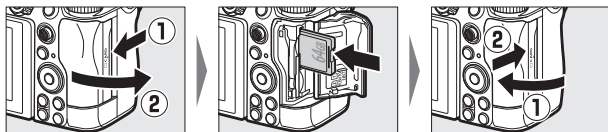

Removing Memory Cards

After confirming that the memory card access lamp is off, turn the camera off, open the memory card slot cover, and press the card in to eject it (①). The card can then be removed by hand (②).

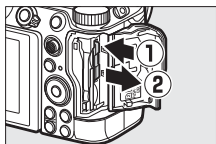

Attaching a Lens

- The camera can be used with Z mount lenses. The lens generally used in this manual for illustrative purposes is a NIKKOR Z 24–70mm f/4 S.
- Be careful to prevent dust entering the camera.
- Confirm that the camera is off before attaching the lens.
 - Remove the camera body cap (①, ②) and rear lens cap (③, ④).

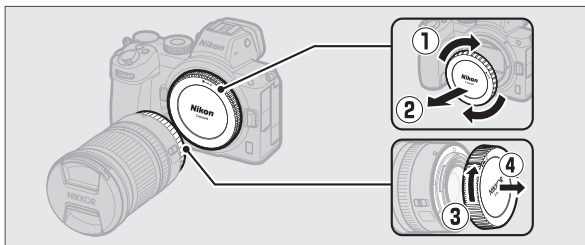

- Align the mounting marks on the camera (⑤) and lens (⑥).
Do not touch the image sensor or lens contacts.

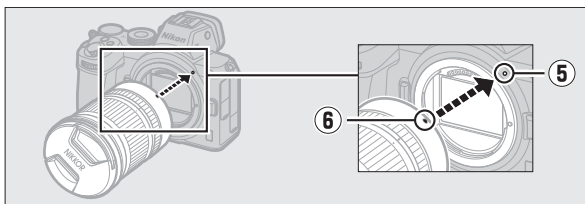

- Rotate the lens as shown until it clicks into place (7).

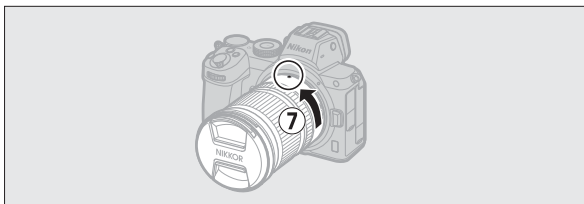

- Remove the front lens cap before taking pictures.

✓ F Mount Lenses

- Be sure to attach the FTZ mount adapter (available separately) before using F mount lenses.
 - Attempting to attach F mount lenses directly to the camera could damage the lens or image sensor.
-

Detaching Lenses

- After turning the camera off, press and hold the lens release button (1) while turning the lens in the direction shown (2).
- After removing the lens, replace the lens caps and camera body cap.

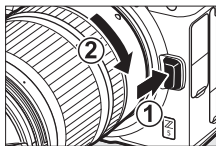

Choose a Language and Set the Clock

The language option in the setup menu is automatically highlighted the first time menus are displayed. Choose a language and set the camera clock.

1 Turn the camera on.

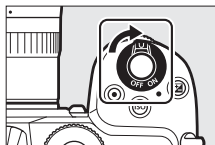

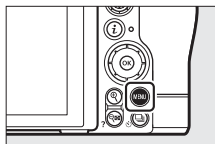

2 Highlight [Language] in the setup menu and press .



The **[Language]** item is automatically highlighted in the setup menu the first time the **MENU** button is pressed after purchase.



3 Select a language.

Press  or  to highlight the desired language and press  (the languages available vary with the country or region in which the camera was originally purchased).

4 Highlight [Time zone and date] and press .



5 Choose a time zone.

- Select [Time zone] in the [Time zone and date] display.
- Highlight a time zone in the [Time zone] display and press .
- The display shows a time zone map listing the selected cities in the chosen zone and the difference between the time in the chosen zone and UTC.



6 Turn daylight saving time on or off.

- Select [**Daylight saving time**] in the [**Time zone and date**] display.
- Highlight [**On**] (daylight saving time on) or [**Off**] (daylight saving time off) and press **OK**.
- Selecting [**On**] advances the clock one hour; to undo the effect, select [**Off**].



7 Set the clock.

- Select [**Date and time**] in the [**Time zone and date**] display.
- Press **OK** after using the multi selector to set the clock to the date and time in the selected time zone (note that the camera uses a 24-hour clock).



8 Choose a date format.

- Select [**Date format**] in the [**Time zone and date**] display.
- Highlight the desired date (year, month, and day) display order and press **OK**.

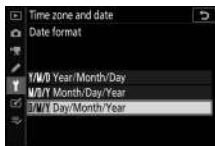

9 Exit the menus.

Lightly press the shutter-release button halfway to exit to shooting mode.



✔ The ☺ Icon

A flashing ☺ icon in the shooting display indicates that the camera clock has been reset. The date and time recorded with new photographs will not be correct; use the **[Time zone and date] > [Date and time]** option in the setup menu to set the clock to the correct time and date. The camera clock is powered by an independent clock battery. The clock battery charges when the main battery is inserted in the camera. It takes about 2 days to charge. Once charged, it will power the clock for about a month.

✔ SnapBridge

Use the SnapBridge app to synchronize the camera clock with the clock on a smartphone or tablet (smart device). See SnapBridge online help for details.

Basic Photography and Playback

Taking Photographs (AUTO Auto)

Select **AUTO** (auto) mode for simple “point-and-shoot” photography.

✓ Lenses with Retractable Barrels

Lenses with retractable barrels must be extended before use. Rotate the lens zoom ring as shown until the lens clicks into the extended position.

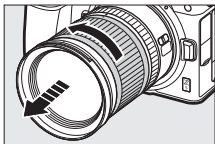

1 Turn the camera on.

The monitor turns on.

2 Select photo mode by rotating the photo/movie selector to .

3 Rotate the mode dial to **AUTO** .

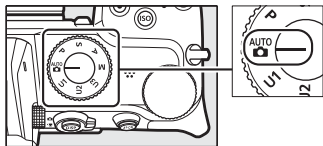

4 Press the shutter-release button halfway to focus.

- The focus point will be displayed in green when the camera focuses. If the camera is unable to focus, the AF-area brackets will flash.
- The AF-assist illuminator may light to assist the focus operation if the subject is poorly lit.
- You can also focus by pressing the **AF-ON** button.

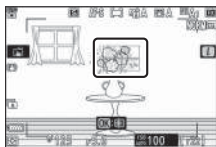

5 Smoothly press the shutter-release button the rest of the way down to take the photograph.

- You can also take a photograph by touching the monitor. Touch your subject to focus and lift your finger to release the shutter.

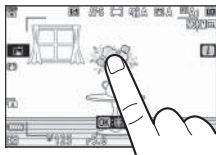

Shooting Movies (AUTO Mode)

^{AUTO}
AUTO (auto) mode can also be used for simple, “point-and-shoot” movie recording.

1 Turn the camera on.

The monitor turns on.

2 Select movie mode by rotating the photo/movie selector to .

Note that optional flash units cannot be used when the camera is in movie mode.

3 Rotate the mode dial to ^{AUTO} AUTO.

4 Press the movie-record button to start recording.

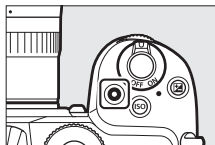

5 Press the movie-record button again to end recording.

Playback

Press the  button to view photos and movies recorded with the camera.

Viewing Photos

Photos can be viewed by following the steps below.

1 Press the button.

- A picture will be displayed in the monitor or viewfinder.
- The memory card containing the picture currently displayed is shown by an icon.

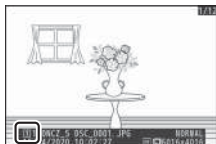
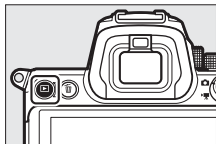



2 Press or to view additional pictures.



- When pictures are displayed in the monitor, you can view other pictures by flicking a finger left or right over the display.
- To end playback and return to shooting mode, press the shutter-release button halfway.

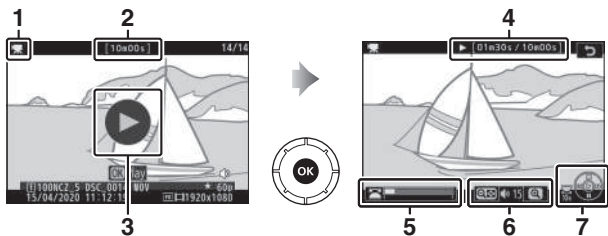

Viewing Movies

Movies are indicated by a  icon. Tap the  icon in the display or press the  button to start playback (a progress bar shows your approximate position in the movie).



- 1  icon
- 2 Length
- 3  icon
- 4 Current position/total length
- 5 Progress bar
- 6 Volume
- 7 Guide

Technical Notes

Specifications

Nikon Z 5 Digital Camera

Type	
Type	Digital camera with support for interchangeable lenses
Lens mount	Nikon Z mount
Lens	
Compatible lenses	<ul style="list-style-type: none">• Z mount NIKKOR lenses• F mount NIKKOR lenses (mount adapter required; restrictions may apply)
Effective pixels	
Effective pixels	24.3 million
Image sensor	
Type	35.9 × 23.9 mm CMOS sensor (Nikon FX format)
Total pixels	24.93 million
Dust-reduction system	Image sensor cleaning, Image Dust Off reference data (requires NX Studio)

Storage

Image size (pixels)	<ul style="list-style-type: none">• [FX (36 × 24)] selected for image area:<ul style="list-style-type: none">- 6016 × 4016 (Large: 24.2 M)- 4512 × 3008 (Medium: 13.6 M)- 3008 × 2008 (Small: 6.0 M)• [DX (24 × 16)] selected for image area:<ul style="list-style-type: none">- 3936 × 2624 (Large: 10.3 M)- 2944 × 1968 (Medium: 5.8 M)- 1968 × 1312 (Small: 2.6 M)• [1:1 (24 × 24)] selected for image area:<ul style="list-style-type: none">- 4016 × 4016 (Large: 16.1 M)- 3008 × 3008 (Medium: 9.0 M)- 2000 × 2000 (Small: 4.0 M)• [16:9 (36 × 20)] selected for image area:<ul style="list-style-type: none">- 6016 × 3384 (Large: 20.4 M)- 4512 × 2536 (Medium: 11.4 M)- 3008 × 1688 (Small: 5.1 M)• Photographs taken while filming movies at a frame size of 3840 × 2160: 3840 × 2160• Photographs taken while filming movies at other frame sizes: 1920 × 1080
File format (image quality)	<ul style="list-style-type: none">• NEF (RAW): 12 or 14 bit (lossless compressed or compressed)• JPEG: JPEG-Baseline compliant with fine (approx. 1:4), normal (approx. 1:8), or basic (approx. 1:16) compression; size-priority and optimal-quality compression available• NEF (RAW)+JPEG: Single photograph recorded in both NEF (RAW) and JPEG formats

Storage	
Picture Control System	Auto, Standard, Neutral, Vivid, Monochrome, Portrait, Landscape, Flat, Creative Picture Controls (Dream, Morning, Pop, Sunday, Somber, Dramatic, Silence, Bleached, Melancholic, Pure, Denim, Toy, Sepia, Blue, Red, Pink, Charcoal, Graphite, Binary, Carbon); selected Picture Control can be modified; storage for custom Picture Controls
Media	SD (Secure Digital) and UHS-II compliant SDHC and SDXC memory cards
Double card slots	The card in Slot 2 can be used for overflow or backup storage or for separate storage of NEF (RAW) and JPEG images; pictures can be copied between cards.
File system	DCF 2.0, Exif 2.31
Viewfinder	
Viewfinder	1.27-cm/0.5-in. approx. 3690k-dot (Quad VGA) OLED electronic viewfinder with color balance and auto and 11-level manual brightness controls
Frame coverage	Approx. 100% horizontal and 100% vertical
Magnification	Approx. 0.8× (50 mm lens at infinity, -1.0 m^{-1})
Eyepoint	21 mm (-1.0 m^{-1} ; from center surface of viewfinder eyepiece lens)
Diopter adjustment	$-4 - +2 \text{ m}^{-1}$
Eye sensor	Automatically switches between monitor and viewfinder displays

Monitor	
Monitor	8-cm/3.2-in., approx. 1040k-dot tilting TFT touch-sensitive LCD with 170° viewing angle, approximately 100% frame coverage, and color balance and 11-level manual brightness controls
Shutter	
Type	Electronically-controlled vertical-travel focal-plane mechanical shutter; electronic front-curtain shutter; electronic shutter
Speed	$1/8000$ – 30 s (choose from step sizes of $1/3$ and $1/2$ EV), bulb, time, X200
Flash sync speed	$X=1/200$ s; synchronizes with shutter at $1/200$ s or slower; auto FP high-speed sync supported
Release	
Release mode	Single frame, Continuous L, Continuous H, Self-timer
Approximate frame advance rate	<ul style="list-style-type: none"> • Continuous L: Approx. 1 – 4 fps • Continuous H: Approx. 4.5 fps * Maximum frame advance rate as measured by in-house tests.
Self-timer	2 s, 5 s, 10 s, 20 s; 1–9 exposures at intervals of 0.5, 1, 2, or 3 s

Exposure	
Metering system	TTL metering using camera image sensor
Metering mode	<ul style="list-style-type: none"> • Matrix metering • Center-weighted metering: Weight of 75% given to 12 mm circle in center of frame; weighting can instead be based on average of entire frame • Spot metering: Meters 4 mm circle (about 1.5% of frame) centered on selected focus point • Highlight-weighted metering
Range	-3 – +17 EV * Figures are for ISO 100 and f/2.0 lens at 20 °C/68 °F
Mode	<ul style="list-style-type: none"> • : Auto, P: programmed auto with flexible program, S: shutter-priority auto, A: aperture-priority auto, M: manual • U1, U2 and U3: user settings modes
Exposure compensation	-5 – +5 EV (choose from step sizes of 1/3 and 1/2 EV) available in modes P, S, A, and M
Exposure lock	Luminosity locked at detected value
ISO sensitivity (Recommended Exposure Index)	ISO 100–51200 (choose from step sizes of 1/3 and 1/2 EV); can also be set to approx. 0.3, 0.5, 0.7, or 1 EV (ISO 50 equivalent) below ISO 100 or to approx. 0.3, 0.5, 0.7, or 1 EV (ISO 102400 equivalent) above ISO 51200; auto ISO sensitivity control available
Active D-Lighting	Auto, Extra high, High, Normal, Low, and Off

Exposure	
Multiple exposure	Add, average, lighten, darken
Other options	HDR (high dynamic range), photo mode flicker reduction
Autofocus	
Type	Hybrid phase-detection/contrast AF with AF assist
Detection range	-3 – +19 EV * Without low-light AF: -2 – +19 EV * Measured in photo mode at ISO 100 and a temperature of 20 °C/68 °F using single-servo AF (AF-S) and a lens with a maximum aperture of f/2.0
Lens servo	<ul style="list-style-type: none"> • Autofocus (AF): Single-servo AF (AF-S); continuous-servo AF (AF-C); full-time AF (AF-F; available only in movie mode); predictive focus tracking • Manual focus (M): Electronic rangefinder can be used
Focus points	273 focus points * Number of focus points available in photo mode with single-point AF selected for AF-area mode and FX selected for image area
AF-area mode	Pinpoint (available in photo mode only), single-point, and dynamic-area AF (available in photo mode only); wide-area AF (S); wide-area AF (L); auto-area AF
Focus lock	Focus can be locked by pressing shutter-release button halfway (single-servo AF/ AF-S) or by pressing the center of the sub-selector

Vibration reduction (VR)

Camera on-board VR	5-axis image sensor shift
Lens on-board VR	Lens shift (available with VR lenses)

Flash

Flash control	TTL: i-TTL flash control; i-TTL balanced fill-flash is used with matrix, center-weighted, and highlight-weighted metering, standard i-TTL fill-flash with spot metering
Flash mode	Front-curtain sync, slow sync, rear-curtain sync, red-eye reduction, red-eye reduction with slow sync, off
Flash compensation	-3 – +1 EV (choose from step sizes of $\frac{1}{3}$ and $\frac{1}{2}$ EV) available in modes P , S , A , and M
Flash-ready indicator	Lights when optional flash unit is fully charged; flashes as underexposure warning after flash is fired at full output
Accessory shoe	ISO 518 hot-shoe with sync and data contacts and safety lock
Nikon Creative Lighting System (CLS)	i-TTL flash control, radio-controlled Advanced Wireless Lighting, optical Advanced Wireless Lighting, modeling illumination, FV lock, Color Information Communication, auto FP high-speed sync, unified flash control

White balance

White balance	Auto (3 types), natural light auto, direct sunlight, cloudy, shade, incandescent, fluorescent (7 types), flash, choose color temperature (2500 K–10,000 K), preset manual (up to 6 values can be stored), all with fine-tuning except choose color temperature
----------------------	--

Bracketing	
Bracketing	Exposure and/or flash, white balance, and ADL
Movie	
Metering system	TTL metering using camera image sensor
Metering mode	Matrix, center-weighted, or highlight-weighted
Frame size (pixels) and frame rate	<ul style="list-style-type: none"> • 3840 × 2160 (4K UHD): 30p (progressive)/25p/24p • 1920 × 1080: 60p/50p/30p/25p/24p * Actual frame rates for 60p, 50p, 30p, 25p, and 24p are 59.94, 50, 29.97, 25, and 23.976 fps respectively * Quality selection (normal/★) available at all sizes except 3840 × 2160, when quality is fixed at ★
File format	MOV, MP4
Video compression	H.264/MPEG-4 Advanced Video Coding
Audio recording format	Linear PCM (for movies recorded in MOV format) or AAC (for movies recorded in MP4 format)
Audio recording device	Built-in stereo or external microphone with attenuator option; sensitivity adjustable
Exposure compensation	-3 – +3 EV (choose from step sizes of $\frac{1}{3}$ and $\frac{1}{2}$ EV) available in modes P , S , A , and M

Movie	
ISO sensitivity (Recommended Exposure Index)	<ul style="list-style-type: none"> • M: Manual selection (ISO 100–25600; choose from step sizes of $\frac{1}{3}$ and $\frac{1}{2}$ EV); auto ISO sensitivity control (ISO 100–25600) available with selectable upper limit • P, S, A: Auto ISO sensitivity control (ISO 100–25600) with selectable upper limit • : Auto ISO sensitivity control (ISO 100–25600)
Active D-Lighting	Same as photo settings, Extra high, High, Normal, Low, and Off
Other options	Time-lapse movie recording, electronic vibration reduction, time codes

Playback	
Playback	Full-frame and thumbnail (4, 9, or 72 images or calendar) playback with playback zoom, playback zoom cropping, movie playback, photo and/or movie slide shows, histogram display, highlights, photo information, location data display, auto image rotation, and picture rating

Interface	
USB	Type C USB connector (SuperSpeed USB); connection to built-in USB port is recommended
HDMI output	Type C HDMI connector
Accessory terminal	Built-in (can be used with MC-DC2 remote cords and other optional accessories)
Audio input	Stereo mini-pin jack (3.5 mm diameter; plug-in power supported)
Audio output	Stereo mini-pin jack (3.5 mm diameter)

Wi-Fi/Bluetooth

Wi-Fi	<ul style="list-style-type: none">• Standards:<ul style="list-style-type: none">- IEEE 802.11b/g/n (Africa, Asia, Bolivia, Europe, and Oceania)- IEEE 802.11b/g/n/a/ac (U.S.A., Canada, Mexico)- IEEE 802.11b/g/n/a (other countries in the Americas)• Operating frequency:<ul style="list-style-type: none">- 2412–2462 MHz (channel 11; Africa, Asia, Bolivia, Europe, and Oceania)- 2412–2462 MHz (channel 11) and 5180–5825 MHz (U.S.A., Canada, Mexico)- 2412–2462 MHz (channel 11) and 5180–5805 MHz (other countries in the Americas)• Maximum output power (EIRP):<ul style="list-style-type: none">- 0.7 dBm (2.4 GHz)- 6.2 dBm (5 GHz)• Authentication: Open system, WPA2-PSK
Bluetooth	<ul style="list-style-type: none">• Communication protocols: Bluetooth Specification Version 4.2• Operating frequency:<ul style="list-style-type: none">- Bluetooth: 2402–2480 MHz- Bluetooth Low Energy: 2402–2480 MHz• Maximum output power (EIRP):<ul style="list-style-type: none">- Bluetooth: –4.8 dBm- Bluetooth Low Energy: –6.3 dBm
Range (line of sight)	Approximately 10 m (32 ft)* * Without interference. Range may vary with signal strength and presence or absence of obstacles.

Power source	
Battery	<p>One EN-EL15c rechargeable Li-ion battery*</p> <p>* EN-EL15b/EN-EL15a/EN-EL15 batteries can also be used. Note, however, that fewer pictures can be taken on a single charge than with the EN-EL15c. The EH-7P charging AC adapter can be used to charge EN-EL15c/EN-EL15b batteries only.</p>
Battery pack	<p>MB-N10 battery pack (available separately); takes two EN-EL15c* batteries</p> <p>* EN-EL15b/EN-EL15a/EN-EL15 batteries can be used in place of the EN-EL15c. The number of pictures that can be taken on a single charge (i.e., battery endurance) will however drop compared to the EN-EL15c.</p>
Charging AC adapter	EH-7P charging AC adapter (available separately)
AC adapter	EH-5d/EH-5c/EH-5b AC adapter; requires EP-5B power connector (available separately)
Tripod socket	
Tripod socket	1/4 in. (ISO 1222)
Dimensions/weight	
Dimensions	Approx. 134 × 100.5 × 69.5 mm/5.3 × 4.0 × 2.8 in. (width × height × depth)
Weight	Approx. 675 g (1 lb. 7.9 oz.) with battery and memory card but without body cap; approx. 590 g/1 lb. 4.9 oz. (camera body only)

Operating environment

Temperature	0 °C–40 °C (+32 °F–104 °F)
Humidity	85% or less (no condensation)

- Unless otherwise stated, all measurements are performed in conformity with Camera and Imaging Products Association (CIPA) standards or guidelines.
- All figures are for a camera with a fully-charged battery.
- The sample images displayed on the camera and the images and illustrations in the manuals are for expository purposes only.
- Nikon reserves the right to change the appearance and specifications of the hardware and software described in this manual at any time and without prior notice. Nikon will not be held liable for damages that may result from any mistakes that this manual may contain.

■ MH-25a Battery Charger

Rated input	AC 100 to 240 V, 50/60 Hz, 0.23–0.12 A
Rated output	DC 8.4 V/1.2 A
Supported batteries	EN-EL15c/EN-EL15b/EN-EL15a/EN-EL15 Rechargeable Li-ion Battery
Charging time	Approx. 2 hours 35 minutes * Time required to charge battery at an ambient temperature of 25 °C (77 °F) when no charge remains
Operating temperature	0 °C–40 °C (+32 °F–104 °F)
Dimensions	Approx. 95 × 33.5 × 71 mm/3.7 × 1.3 × 2.8 in. (width × height × depth), excluding projections
Length of power cable	Approx. 1.5 m (4.9 ft), if supplied
Weight	Approx. 115 g (4.1 oz), excluding supplied power connector (power cable or AC wall adapter)

The symbols on this product represent the following:

~ AC, — DC, □ Class II equipment (the construction of the product is double-insulated)

■ EN-EL15c Rechargeable Li-ion Battery

Type	Rechargeable lithium-ion battery
Rated capacity	7.0 V/2280 mAh
Operating temperature	0 °C–40 °C (+32 °F–104 °F)
Dimensions	Approx. 40 × 56 × 20.5 mm/1.6 × 2.2 × 0.8 in. (width × height × depth)
Weight	Approx. 80 g (2.9 oz), excluding terminal cover

Approved Memory Cards

- The camera can be used with SD, SDHC, and SDXC memory cards.
- UHS-I and UHS-II are supported.
- Cards rated UHS Speed Class 3 or better are recommended for movie recording and playback. Slower speeds may result in recording or playback being interrupted.
- When choosing cards for use in card readers, be sure they are compatible with the device.
- Contact the manufacturer for information on features, operation, and limitations on use.



Portable Chargers (Power Banks)

Portable chargers can be used to power the camera or charge the camera battery. The following table lists the portable chargers that have been tested and approved for use, together with the approximate number of shots that can be taken with, and the approximate number of times the camera battery can be charged using, each device.

Manufacturer	Model number	Number of shots ¹	Number of charges ²
Anker	PowerCore+ 26800 PD 45W	2120	3

- 1 Camera and Imaging Products Association (CIPA) standard. **[Viewfinder only]** selected for monitor mode. Measured at 23 °C/ 73.4 °F (±2 °C/3.6 °F) with a NIKKOR Z 24–70mm f/4 S lens under the following test conditions: one photograph taken at default settings once every 30 s. The “number of shots” is the number of shots that can be taken using a fully-charged portable charger to supply power to a camera with a fully-charged battery (EN-EL15c).
 - 2 The number of times the camera battery (EN-EL15c) can be fully charged using a portable charger at full charge.
- The only batteries that can be charged from portable chargers are the EN-EL15c and EN-EL15b.
 - See the documentation provided with the portable charger for information on use.
 - Use a USB cable with two Type-C connectors supplied with the portable charger when employing the device to power the camera or charge the camera battery.
 - Up-to-date information on portable chargers is available on the website of the manufacturers. Availability may vary with country or region.

Trademarks and Licenses

- The SD, SDHC, and SDXC logos are trademarks of SD-3C, LLC.
- Windows is either a registered trademark or a trademark of Microsoft Corporation in the United States and/or other countries.
- Apple®, App Store®, the Apple logos, iPhone®, iPad®, Mac, and macOS are trademarks of Apple Inc. registered in the U.S. and/or other countries.
- Android, Google Play and the Google Play logo are trademarks of Google LLC. The Android robot is reproduced or modified from work created and shared by Google and used according to terms described in the Creative Commons 3.0 Attribution License.
- IOS is a trademark or registered trademark of Cisco Systems, Inc., in the United States and/or other countries and is used under license.
- HDMI, the HDMI logo and High-Definition Multimedia Interface are trademarks or registered trademarks of HDMI Licensing, LLC.

HDMI

- The Bluetooth® word mark and logo are registered trademarks owned by Bluetooth SIG, Inc., and any use of such marks by Nikon is under license.
- Wi-Fi and the Wi-Fi logo are trademarks or registered trademarks of the Wi-Fi Alliance.
- All other trade names mentioned in this manual or the other documentation provided with your Nikon product are trademarks or registered trademarks of their respective holders.

Use of the Made for Apple badge means that an accessory has been designed to connect specifically to the Apple products identified in the badge, and has been certified by the developer to meet Apple performance standards. Apple is not responsible for the operation of this device or its compliance with safety and regulatory standards. Please note that the use of this accessory with an Apple product may affect wireless performance.

✔ FreeType License (FreeType2)

Portions of this software are copyright © 2012 The FreeType Project (<https://www.freetype.org>). All rights reserved.

✔ MIT License (HarfBuzz)

Portions of this software are copyright © 2018 The HarfBuzz Project (<https://www.freedesktop.org/wiki/Software/HarfBuzz>). All rights reserved.

☑ Unicode® Character Database License (Unicode® Character Database)

The software for this product uses the Unicode® Character Database License open-source software. The terms of the software license are as follows:

COPYRIGHT AND PERMISSION NOTICE

Copyright © 1991-2019 Unicode, Inc. All rights reserved.

Distributed under the Terms of Use in

<https://www.unicode.org/copyright.html>.

Permission is hereby granted, free of charge, to any person obtaining a copy of the Unicode data files and any associated documentation (the "Data Files") or Unicode software and any associated documentation (the "Software") to deal in the Data Files or Software without restriction, including without limitation the rights to use, copy, modify, merge, publish, distribute, and/or sell copies of the Data Files or Software, and to permit persons to whom the Data Files or Software are furnished to do so, provided that either

- (i) this copyright and permission notice appear with all copies of the Data Files or Software, or
- (ii) this copyright and permission notice appear in associated Documentation.

THE DATA FILES AND SOFTWARE ARE PROVIDED "AS IS", WITHOUT WARRANTY OF ANY KIND, EXPRESS OR IMPLIED, INCLUDING BUT NOT LIMITED TO THE WARRANTIES OF MERCHANTABILITY, FITNESS FOR A PARTICULAR PURPOSE AND NON-INFRINGEMENT OF THIRD PARTY RIGHTS. IN NO EVENT SHALL THE COPYRIGHT HOLDER OR HOLDERS INCLUDED IN THIS NOTICE BE LIABLE FOR ANY CLAIM, OR ANY SPECIAL INDIRECT OR CONSEQUENTIAL DAMAGES, OR ANY DAMAGES WHATSOEVER RESULTING FROM LOSS OF USE, DATA OR PROFITS, WHETHER IN AN ACTION OF CONTRACT, NEGLIGENCE OR OTHER TORTIOUS ACTION, ARISING OUT OF OR IN CONNECTION WITH THE USE OR PERFORMANCE OF THE DATA FILES OR SOFTWARE.

Except as contained in this notice, the name of a copyright holder shall not be used in advertising or otherwise to promote the sale, use or other dealings in these Data Files or Software without prior written authorization of the copyright holder.

☑ AVC Patent Portfolio License

THIS PRODUCT IS LICENSED UNDER THE AVC PATENT PORTFOLIO LICENSE FOR THE PERSONAL AND NON-COMMERCIAL USE OF A CONSUMER TO (i) ENCODE VIDEO IN COMPLIANCE WITH THE AVC STANDARD ("AVC VIDEO") AND/OR (ii) DECODE AVC VIDEO THAT WAS ENCODED BY A CONSUMER ENGAGED IN A PERSONAL AND NON-COMMERCIAL ACTIVITY AND/OR WAS OBTAINED FROM A VIDEO PROVIDER LICENSED TO PROVIDE AVC VIDEO. NO LICENSE IS GRANTED OR SHALL BE IMPLIED FOR ANY OTHER USE. ADDITIONAL INFORMATION MAY BE OBTAINED FROM MPEG LA, L.L.C. SEE <https://www.mpegla.com>

Notices

Notices for Customers in the U.S.A.

The Battery Charger

IMPORTANT SAFETY INSTRUCTIONS—SAVE THESE INSTRUCTIONS

DANGER—TO REDUCE THE RISK OF FIRE OR ELECTRIC SHOCK, CAREFULLY FOLLOW THESE INSTRUCTIONS

For connection to a supply not in the U.S.A., use an attachment plug adapter of the proper configuration for the power outlet if needed. This power unit is intended to be correctly oriented in a vertical or floor mount position.

Federal Communications Commission (FCC) Radio Frequency Interference Statement

This equipment has been tested and found to comply with the limits for a Class B digital device, pursuant to Part 15 of the FCC rules. These limits are designed to provide reasonable protection against harmful interference in a residential installation. This equipment generates, uses, and can radiate radio frequency energy and, if not installed and used in accordance with the instructions, may cause harmful interference to radio communications. However, there is no guarantee that interference will not occur in a particular installation. If this equipment does cause harmful interference to radio or television reception, which can be determined by turning the equipment off and on, the user is encouraged to try to correct the interference by one or more of the following measures:

- Reorient or relocate the receiving antenna.
- Increase the separation between the equipment and receiver.
- Connect the equipment into an outlet on a circuit different from that to which the receiver is connected.
- Consult the dealer or an experienced radio/television technician for help.



Nikon
Z 5

CAUTIONS

Modifications

The FCC requires the user to be notified that any changes or modifications made to this device that are not expressly approved by Nikon Corporation may void the user's authority to operate the equipment.

Interface Cables

Use the interface cables sold or provided by Nikon for your equipment. Using other interface cables may exceed the limits of Class B Part 15 of the FCC rules.

Nikon Inc., 1300 Walt Whitman Road, Melville, New York 11747-3064, U.S.A. Tel.: 631-547-4200

Power Cable

At voltages over AC 125 V (U.S.A. only): The power cable must be rated for the voltage in use, be at least AWG no. 18 gauge, and have SVG insulation or better with a NEMA 6P-15 plug rated for AC 250 V 15 A.

Notice for Customers in Canada

CAN ICES-3 B / NMB-3 B

Notices for Customers in Europe

CAUTION: RISK OF EXPLOSION IF BATTERY IS REPLACED BY AN INCORRECT TYPE. DISPOSE OF USED BATTERIES ACCORDING TO THE INSTRUCTIONS.

This symbol indicates that electrical and electronic equipment is to be collected separately.



The following apply only to users in European countries:

- This product is designated for separate collection at an appropriate collection point. Do not dispose of as household waste.
- Separate collection and recycling helps conserve natural resources and prevent negative consequences for human health and the environment that might result from incorrect disposal.
- For more information, contact the retailer or the local authorities in charge of waste management.

This symbol on the battery indicates that the battery is to be collected separately.



The following apply only to users in European countries:

- All batteries, whether marked with this symbol or not, are designated for separate collection at an appropriate collection point. Do not dispose of as household waste.
- For more information, contact the retailer or the local authorities in charge of waste management.

Bluetooth and Wi-Fi (Wireless LAN)

This product is controlled by the United States Export Administration Regulations (EAR). The permission of the United States government is not required for export to countries other than the following, which as of this writing are subject to embargo or special controls: Cuba, Iran, North Korea, Sudan, and Syria (list subject to change).

The use of wireless devices may be prohibited in some countries or regions. Contact a Nikon-authorized service representative before using the wireless features of this product outside the country of purchase.

The Bluetooth transmitter in this device operates in the 2.4 GHz band.

Notice for Customers in the U.S.A. and Canada

This device complies with part 15 of FCC Rules and Innovation, Science and Economic Development Canada's licence-exempt RSSs. Operation is subject to the following two conditions: (1) this device may not cause harmful interference, and (2) this device must accept any interference received, including interference that may cause undesired operation.

FCC WARNING

The FCC requires the user to be notified that any changes or modifications made to this device that are not expressly approved by Nikon Corporation may void the user's authority to operate the equipment.

Compliance with FCC requirement 15.407(c)

Data transmission is always initiated by software, which is then passed down through the MAC, through the digital and analog baseband, and finally to the RF chip. Several special packets are initiated by the MAC. These are the only ways the digital baseband portion will turn on the RF transmitter, which it then turns off at the end of the packet. Therefore, the transmitter will be on only while one of the aforementioned packets is being transmitted. In other words, this device automatically discontinues transmission in case of either absence of information to transmit or operational failure.

Frequency Tolerance: ± 20 ppm

FCC Radio Frequency Interference Statement

Note: This equipment has been tested and found to comply with the limits for a Class B digital device, pursuant to part 15 of the FCC Rules. These limits are designed to provide reasonable protection against harmful interference in a residential installation. This equipment generates, uses and can radiate radio frequency energy and, if not installed and used in accordance with the instructions, may cause harmful interference to radio communications. However, there is no guarantee that interference will not occur in a particular installation. If this equipment does cause harmful interference to radio or television reception, which can be determined by turning the equipment off and on, the user is encouraged to try to correct the interference by one or more of the following measures:

- Reorient or relocate the receiving antenna.
- Increase the separation between the equipment and receiver.
- Connect the equipment into an outlet on a circuit different from that to which the receiver is connected.
- Consult the dealer or an experienced radio/TV technician for help.

Co-location

This transmitter must not be co-located or operated in conjunction with any other antenna or transmitter.

Nikon Inc., 1300 Walt Whitman Road, Melville, New York 11747-3064, U.S.A.
Tel.: 631-547-4200

FCC/ISED RF Exposure Statement

The available scientific evidence does not show that any health problems are associated with using low power wireless devices. There is no proof, however, that these low power wireless devices are absolutely safe. Low power Wireless devices emit low levels of radio frequency energy (RF) in the microwave range while being used. Whereas high levels of RF can produce health effects (by heating tissue), exposure of low-level RF that does not produce heating effects causes no known adverse health effects. Many studies of low-level RF exposures have not found any biological effects. Some studies have suggested that some biological effects might occur, but such findings have not been confirmed by additional research. This product has been tested and found to comply with FCC/ISED radiation exposure limits set forth for an uncontrolled environment and meets the FCC radio frequency (RF) Exposure Guidelines and RSS-102 of the ISED radio frequency (RF) Exposure rules. Please refer to the SAR test report that was uploaded to FCC website.

Compliance with RSS-247 Issue 2 §6.4

Data transmission is always initiated by software, which is the passed down through the MAC, through the digital and analog baseband, and finally to the RF chip. Several special packets are initiated by the MAC. These are the only ways the digital baseband portion will turn on the RF transmitter, which it then turns off at the end of the packet. Therefore, the transmitter will be on only while one of the aforementioned packets is being transmitted. In other words, this device automatically discontinues transmission in case of either absence of information to transmit or operational failure.

Notice for Customers in Canada

For indoor use only (5150-5350MHz).

Notice for Customers in Europe and in Countries Complying with the Radio Equipment Directive

Hereby, Nikon Corporation declares that the radio equipment type Z 5 is in compliance with Directive 2014/53/EU.



The full texts of the EU declarations of conformity are available at the following internet addresses:

https://imaging.nikon.com/support/pdf/DoC_N1933.pdf

Notice for Customers in the UK

Hereby, Nikon Corporation declares that the radio equipment type Z 5 is in compliance with Radio Equipment Regulations 2017.

The full text of the UKCA declaration of conformity is available at the following internet address:

https://imaging.nikon.com/support/pdf/UKCA_DoC_N1933.pdf

Wi-Fi

- Operating frequency:
 - 2412–2462 MHz (channel 11)
- Maximum output power (EIRP):
 - 2.4 GHz band: 0.7 dBm
 - 5 GHz band: 6.2 dBm

Bluetooth

- Operating frequency:
 - Bluetooth: 2402–2480 MHz
 - Bluetooth Low Energy: 2402–2480 MHz
- Maximum output power (EIRP):
 - Bluetooth: –4.8 dBm
 - Bluetooth Low Energy: –6.3 dBm

This product complies with the UK PSTI Act 2022 and the statement of compliance and security update period is available at the following internet address:

https://www.nikonimsgsupport.com/eu/BV_article?lang=en_GB&articleNo=000066765

Notice for Customers in Singapore

Trade Name: **Nikon**
Model: Z 5

This device complies with radio-frequency regulations. The content of certification labels not affixed to the device is given below.

Complies with
IMDA Standards
DA103423

Notice for Customers in Nigeria

Connection and use of this communications
equipment is permitted by the Nigerian
Communications Commission

Security

Although one of the benefits of this product is that it allows others to freely connect for the wireless exchange of data anywhere within its range, the following may occur if security is not enabled:

- **Data theft:** Malicious third-parties may intercept wireless transmissions to steal user IDs, passwords, and other personal information.
- **Unauthorized access:** Unauthorized users may gain access to the network and alter data or perform other malicious actions. Note that due to the design of wireless networks, specialized attacks may allow unauthorized access even when security is enabled.
- **Unsecured networks:** Connecting to open networks may result in unauthorized access. Use secure networks only.

☑ **Conformity Marking**

The standards with which the camera complies can be viewed using the [Conformity marking] option in the setup menu.

☑ **Certificates**

• ประเทศไทย

เครื่อง โทรคมนาคมและอุปกรณ์นี้ มีความสอดคล้องตามข้อกำหนดของ กสทช

• Maroc/

المغرب

AGREE PAR L'ANRT MAROC
Numéro d'agrément : MR23610 ANRT2020



• México

IFETEL: RCPMU1M18-0171

1MW

La operación de este equipo está sujeta a las siguientes dos condiciones:

- (1) es posible que este equipo o dispositivo no cause interferencia perjudicial y
- (2) este equipo o dispositivo debe aceptar cualquier interferencia, incluyendo la que pueda causar su operación no deseada.

• Paraguay



CONATEL

Emap S.A. (Casa Nissei)

Avda Adrian Jara, Esq. Regimiento Piribebuy, Ciudad del Este, Paraguay.

Tel: 595 61 500 115

Fax: 595 61 500 115

• عُمان

Oman-TRA
D090024
R/9266/20

• الإمارات العربية المتحدة

TRA
REGISTERED No:
ER61596/18
DEALER No:
DA39487/15

Specifications

Mount	Nikon Z mount
Focal length	24 – 70 mm
Maximum aperture	f/4
Lens construction	14 elements in 11 groups (including 1 ED lens element, 1 aspherical ED element, 3 aspherical elements, elements with Nano Crystal Coat, and a fluorine-coated front lens element)
Angle of view	<ul style="list-style-type: none">• FX format: 84° – 34° 20′• DX format: 61° – 22° 50′
Focal length scale	Graduated in millimeters (24, 28, 35, 50, 70)
Focusing system	Internal focusing system
Minimum focus distance	0.3 m (0.99 ft) from focal plane at all zoom positions
Diaphragm blades	7 (rounded diaphragm opening)
Aperture range	f/4 – 22
Filter-attachment size	72 mm (P = 0.75 mm)
Dimensions	Approx. 77.5 mm maximum diameter × 88.5 mm (distance from camera lens mount flange when lens is retracted)
Weight	Approx. 500 g (1 lb 1.7 oz)

Nikon reserves the right to change the appearance, specifications, and performance of this product at any time and without prior notice.

NIKKOR Z 24–200mm f/4–6.3 VR Lens

Note that lens kits may not be available in some countries or regions.

Parts of the Lens: Names and Functions

The parts of the NIKKOR Z 24–200mm f/4–6.3 VR are listed below.

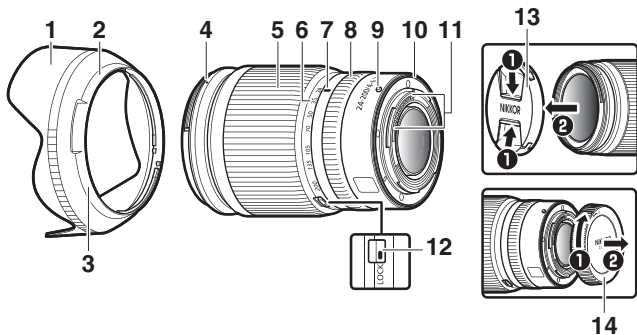

- | | |
|---|--------------------------|
| 1 | Lens hood |
| 2 | Lens hood lock mark |
| 3 | Lens hood alignment mark |
| 4 | Lens hood mounting mark |
| 5 | Zoom ring |
| 6 | Focal length scale |
| 7 | Focal length mark |

- | | |
|----|--------------------------|
| 8 | Control ring |
| 9 | Lens mounting mark |
| 10 | Rubber lens-mount gasket |
| 11 | CPU contacts |
| 12 | Zoom lock switch |
| 13 | Lens cap (front cap) |
| 14 | Lens cap (rear cap) |

Specifications

Mount	Nikon Z mount
Focal length	24 – 200 mm
Maximum aperture	f/4 – 6.3
Lens construction	19 elements in 15 groups (including 2 ED elements, 1 aspherical ED element, 2 aspherical elements, and elements with an ARNEO coat and a fluorine-coated front lens element)
Angle of view	<ul style="list-style-type: none">• FX format: 84°–12° 20'• DX format: 61°–8°
Focal length scale	Graduated in millimeters (24, 35, 50, 70, 105, 135, 200)
Focusing system	Internal focusing system
Vibration reduction	Lens shift using voice coil motors (VCMs)
Minimum focus distance (measured from focal plane)	<ul style="list-style-type: none">• 24 mm zoom position: 0.5 m (1.64 ft)• 35 mm zoom position: 0.54 m (1.78 ft)• 50 mm zoom position: 0.55 m (1.81 ft)• 70 mm zoom position: 0.58 m (1.91 ft)• 105 mm zoom position: 0.65 m (2.14 ft)• 135 mm zoom position: 0.68 m (2.24 ft)• 200 mm zoom position: 0.7 m (2.30 ft)
Maximum reproduction ratio	0.28×
Diaphragm blades	7 (rounded diaphragm opening)

Aperture range	<ul style="list-style-type: none"> • 24 mm zoom position: f/4 – 22 • 200 mm zoom position: f/6.3 – 36 <p>The minimum aperture displayed may vary depending on the size of the exposure increment selected with the camera.</p>
Filter-attachment size	67 mm (P = 0.75 mm)
Dimensions	Approx. 76.5 mm/3.1 in. maximum diameter × 114 mm/4.5 in. (distance from camera lens mount flange)
Weight	Approx. 570 g (1 lb 4.2 oz)

Nikon reserves the right to change the appearance, specifications, and performance of this product at any time and without prior notice.

NIKKOR Z 24–50mm f/4–6.3 Lens

Note that lens kits may not be available in some countries or regions.

Parts of the Lens: Names and Functions

The parts of the NIKKOR Z 24–50mm f/4–6.3 are listed below.

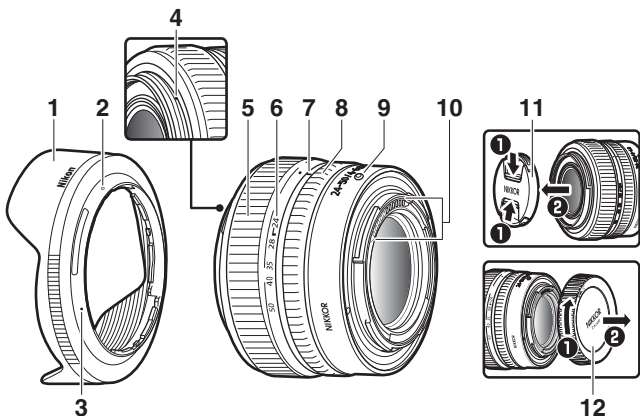

1 Lens hood*

2 Lens hood lock mark

3 Lens hood alignment mark

4 Lens hood mounting mark

5 Zoom ring

6 Focal length scale

7 Focal length mark

8 Control ring

9 Lens mounting mark

10 CPU contacts

11 Lens cap (front cap)

12 Lens cap (rear cap)

* Available separately.

Specifications

Mount	Nikon Z mount
Focal length	24 – 50 mm
Maximum aperture	f/4 – 6.3
Lens construction	11 elements in 10 groups (including 2 ED elements and 3 aspherical elements)
Angle of view	<ul style="list-style-type: none">• FX format: 84°–47°• DX format: 61°–31° 30'
Focal length scale	Graduated in millimeters (24, 28, 35, 40, 50)
Focusing system	Internal focusing system
Minimum focus distance	0.35 m (1.15 ft) from focal plane at all zoom positions
Maximum reproduction ratio	0.17× (50 mm zoom position)
Diaphragm blades	7 (rounded diaphragm opening)
Aperture range	<ul style="list-style-type: none">• 24 mm zoom position: f/4 – 22• 50 mm zoom position: f/6.3 – 36
Filter-attachment size	52 mm (P = 0.75 mm)
Dimensions	Approx. 73.5 mm (2.9 in.) maximum diameter × 51 mm (2.1 in.) (distance from camera lens mount flange when lens is retracted)
Weight	Approx. 195 g (6.9 oz)

Nikon reserves the right to change the appearance, specifications, and performance of this product at any time and without prior notice.



A series of 20 horizontal lines for writing, spaced evenly down the page.

Warranty Terms - Nikon Europe Service Warranty

Dear Nikon Customer,

We thank you for your purchasing this Nikon product. Should your Nikon product require warranty service, please contact the dealer from whom it was purchased or a member of our authorized service network within the sales territory of Nikon Europe B.V. (e.g. Europe/Russia/others). See details under:

<https://www.europe-nikon.com/support>

In order to avoid any unnecessary inconvenience, we advise you to read the user manuals carefully before contacting the dealer or our authorized service network.

Your Nikon equipment is guaranteed against any manufacturing defects for one full year from the date of original purchase. If during this period of guarantee the product proves defective due to improper material or workmanship, our authorized service network within the sales territory of Nikon Europe B.V. will, without charge for labor and parts, repair the product in the terms and conditions set as below. Nikon reserves the right (at its sole discretion) to replace or repair the product.

1. This warranty is only provided upon presentation of the completed warranty card and original invoice or purchase receipt indicating the date of purchase, product type and dealer's name, together with the product. Nikon reserves the right to refuse free-of-charge warranty service if the above documents cannot be presented or if the information contained in it is incomplete or illegible.

2. This warranty will not cover:

- necessary maintenance and repair or replacement of parts due to normal wear and tear.
- modifications to upgrade the product from its normal purpose as described in user manuals, without the prior written consent of Nikon.
- transport costs and all risks of transport relating directly or indirectly to the warranty of the products.
- any damage resulting from modifications or adjustments which may be made to the product, without the prior written consent of Nikon, in order to comply with local or national technical standards in force in any other country than the ones for which the product was originally designed and/or manufactured.

3. The warranty will not be applicable in the case of:

- damage caused by misuse including but not limited to failure to use the product for its normal purpose or according to the user instructions on the proper use and maintenance, and to installation or use of the product inconsistent with the safety standards in force in the country where it is used.
- damage caused by accidents including but not limited to lightning, water, fire, misuse or neglect.
- defacing, illegibility or removal of the model or serial number on the product.
- damage resulting from repairs or adjustments which have been conducted by unauthorized service organizations or persons.
- defects in any system into which the product is incorporated or with which it is used.

4. This service warranty does not affect the consumer's statutory rights under applicable national laws in force, nor the consumer's right against the dealer arising from their sales/ purchase contract.

Notice: An overview of all authorized Nikon Service Stations can be found online by following this Link
(URL = <https://www.europe-nikon.com/service/>).

No reproduction in any form of this manual, in whole or in part (except for brief quotation in critical articles or reviews), may be made without written authorization from NIKON CORPORATION.

NIKON CORPORATION

© 2020 Nikon Corporation



SB4E04(11)
6MOA5811-04