

Nikon

DIGITAL CAMERA

D3400

User's Manual

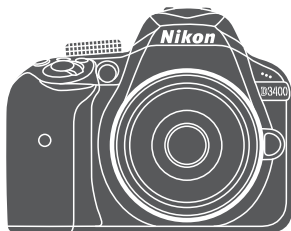

- Read this manual thoroughly before using the camera.
- To ensure proper use of the camera, be sure to read “For Your Safety” (page xi).
- After reading this manual, keep it in a readily accessible place for future reference.

En

SnapBridge

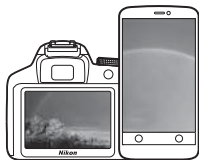

Your images. The world. Connected

Welcome to SnapBridge — Nikon's new family of services to enrich your image experience. SnapBridge eliminates the barrier between your camera and compatible smart device, through a combination of *Bluetooth*® low energy (BLE) technology and a dedicated app. The stories you capture with your Nikon camera and lenses are automatically transferred to the device as they are taken. They can even be uploaded effortlessly to cloud storage services, inviting access across all your devices. You can share your excitement, when and where you want.

Download the SnapBridge app to get started!

Take advantage of the wide-ranging convenience by downloading the SnapBridge app onto your smart device now. Through a few simple steps, this app connects your Nikon cameras with a compatible iPhone®, iPad® and/or iPod touch® or smart devices running on the Android™ operating system. SnapBridge is available free of charge from the Apple App Store®, on Google Play™, and from the following website:

<http://snapbridge.nikon.com>

For the latest information on SnapBridge, visit the Nikon website for your area (☎ xix).



Download on the
App Store



GET IT ON
Google Play

The exciting image experience that SnapBridge offers...



Automatic picture transfer from camera to smart device thanks to the constant connection between the two devices — making online photo sharing easier than ever

NIKON IMAGE SPACE



Upload of photos and thumbnail images to the NIKON IMAGE SPACE cloud service

A range of services that enriches your imaging life, including:

- Imprinting up to two pieces of credit information (e.g. copyright, comments, text and logos) on pictures
- Automatic update of camera's date and time info and location info
- Receive camera's firmware updates

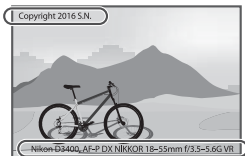

For a complete guide to using your camera, see the *Reference Manual* (□ vi). To get the most from your camera, please be sure to read this *User's Manual* thoroughly and keep it where it will be read by all who use the product.

Symbols and Conventions

To make it easier to find the information you need, the following symbols and conventions are used:



This icon marks cautions; information that should be read before use to prevent damage to the camera.



This icon marks notes; information that should be read before using the camera.



This icon marks references to other pages in this manual.

Menu items, options, and messages displayed in the camera monitor are shown in **bold**.

Camera Settings

The explanations in this manual assume that default settings are used.

Nikon User Support for India and Australia

Contact a Nikon representative for technical assistance with the operation of your Nikon product or products. For information on the Nikon representatives in your area, visit <http://www.nikon-asia.com/support>.

Nikon Manual Viewer 2



Install the Nikon Manual Viewer 2 app on your smartphone or tablet to view Nikon digital camera manuals, anytime, anywhere. Nikon Manual Viewer 2 can be downloaded free of charge from the App Store and on Google Play. Download of the app and any product manuals requires an Internet connection, for which fees may be levied by your phone or Internet service provider.

For Your Safety

Before using the camera for the first time, read the safety instructions in "For Your Safety" (□ xi–xiv).

Package Contents

Be sure all items listed here were included with your camera.

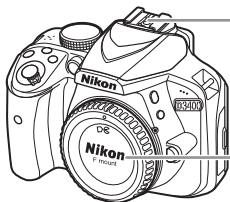

- DK-25 rubber eyecup (comes attached to camera)



- BF-1B body cap

- D3400 camera
- EN-EL14a rechargeable Li-ion battery (with terminal cover)
- MH-24 battery charger (plug adapter supplied in countries or regions where required; shape depends on country of sale)
- AN-DC3 strap
- User's Manual (this booklet)
- Warranty

Purchasers of the lens kit option should confirm that the package also includes a lens. *Memory cards are sold separately* (84). Cameras purchased in Japan display menus and messages in English and Japanese only; other languages are not supported. We apologize for any inconvenience this may cause.

Quick Start Guide

Follow these steps for a quick start with the D3400.

- 1 Attach the camera strap (10).**
Attach the strap as shown. Repeat for the second eyelet.

- 2 Charge the battery (10).**

- 3 Insert the battery and memory card (12).**

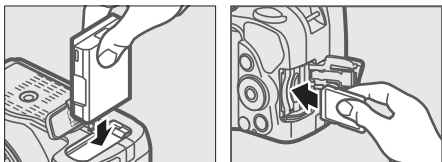

- 4 Attach a lens (15).**

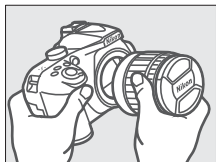

- 5 Turn the camera on (17).**



6 Choose a language and set the clock (📖 17).

After choosing a language, you will be prompted to connect the camera and smart device. To exit without connecting, press the **MENU** button. Follow the on-screen instructions to set the clock.

7 Frame the photograph (📖 27).

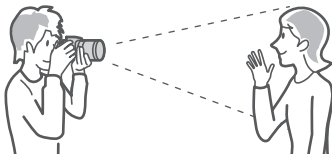

8 Press the shutter-release button halfway (📖 30).

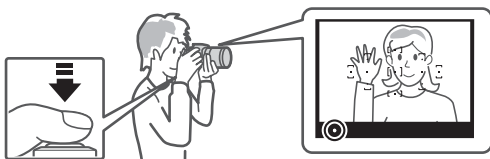

9 Shoot (📖 31).

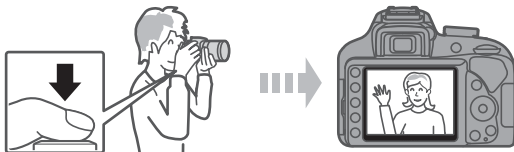

The Reference Manual

For more information on using your Nikon camera, download a pdf copy of the camera *Reference Manual* from the website listed below. The *Reference Manual* can be viewed using Adobe Reader.

- 1 On your computer, launch a web browser and open the Nikon manual download site at
<http://downloadcenter.nikonimglib.com/>
- 2 Navigate to the page for the desired product and download the manual.

ViewNX-i and Capture NX-D Software

Use ViewNX-i to fine-tune photos or to copy pictures to a computer for viewing. ViewNX-i is available for download from the following website:

<http://downloadcenter.nikonimglib.com/>

Use Capture NX-D to fine-tune pictures that have been copied to a computer and to convert NEF (RAW) images to other formats.







Capture NX-D is available for download from:

<http://downloadcenter.nikonimglib.com/>

You can also visit this website for the latest information on Nikon software, including system requirements.











Table of Contents

Package Contents	iii
For Your Safety	xi
Notices.....	xv
Bluetooth	xx
Introduction	1
<hr/>	
Getting to Know the Camera	1
The Camera Body.....	1
The Viewfinder	4
The Mode Dial.....	5
The  (i/ⓘ) Button.....	6
The Information Display.....	7
First Steps	10
<hr/>	
Attach the Camera Strap.....	10
Charge the Battery	10
Insert the Battery and a Memory Card	12
Attach a Lens.....	15
Camera Setup.....	17
Focus the Viewfinder.....	25
The Battery Level and Number of Exposures Remaining.....	26

Basic Photography and Playback	27
<hr/>	
“Point-and-Shoot” Modes (AUTO and ).....	27
Viewing Photographs	35
Deleting Unwanted Photographs.....	37
Recording Movies	38
Viewing Movies.....	42
Deleting Unwanted Movies.....	44
Guide Mode	45
<hr/>	
The Guide	45
Guide Mode Menus	46
Using the Guide	49
Matching Settings to the Subject or Situation (Scene Mode)	51
<hr/>	
 Portrait.....	51
 Landscape	51
 Child	51
 Sports	52
 Close up	52
 Night Portrait	52

Special Effects

53

 Night Vision.....	53
 VI Super Vivid.....	54
 POP Pop.....	54
 Photo Illustration.....	54
 Toy Camera Effect.....	54
 Miniature Effect.....	54
 Selective Color.....	54
 Silhouette.....	55
 High Key.....	55
 Low Key.....	55
Options Available in Live View.....	56

P, S, A, and M Modes

62

Mode P (Programmed Auto).....	63
Mode S (Shutter-Priority Auto).....	63
Mode A (Aperture-Priority Auto).....	64
Mode M (Manual).....	65
Exposure Compensation.....	67

Camera Menus

69

Menu Options.....	70
Using Camera Menus.....	73

ViewNX-i

76

Installing ViewNX-i.....	76
Using ViewNX-i.....	77
Copying Pictures to the Computer.....	77

Compatible Lenses	80
Other Accessories	82
Caring for the Camera	85
Storage.....	85
Cleaning.....	85
Caring for the Camera and Battery: Cautions	86
Error Messages	90
Specifications	94
Battery Life.....	110

For Your Safety

To prevent damage to property or injury to yourself or to others, read “For Your Safety” in its entirety before using this product.

Keep these safety instructions where all those who use this product will read them.

 **DANGER:** Failure to observe the precautions marked with this icon carries a high risk of death or severe injury.

 **WARNING:** Failure to observe the precautions marked with this icon could result in death or severe injury.

 **CAUTION:** Failure to observe the precautions marked with this icon could result in injury or property damage.



WARNING

- **Do not use while walking or operating a motor vehicle.**

Failure to observe this precaution could result in accidents or other injury.

- **Do not disassemble or modify this product. Do not touch internal parts that become exposed as the result of a fall or other accident.**

Failure to observe these precautions could result in electric shock or other injury.

- **Should you notice any abnormalities such as the product producing smoke, heat, or unusual odors, immediately disconnect the battery or power source.**

Continued operation could result in fire, burns or other injury.

- **Keep dry. Do not handle with wet hands. Do not handle the plug with wet hands.**

Failure to observe these precautions could result in fire or electric shock.

- **Do not let your skin remain in prolonged contact with this product while it is on or plugged in.**

Failure to observe this precaution could result in low-temperature burns.

- **Do not use this product in the presence of flammable dust or gas such as propane, gasoline or aerosols.**

Failure to observe this precaution could result in explosion or fire.

- **Do not directly view the sun or other bright light source through the lens or camera.**

Failure to observe this precaution could result in visual impairment.

- **Do not aim the flash or AF-assist illuminator at the operator of a motor vehicle.**

Failure to observe this precaution could result in accidents.

- **Keep this product out of reach of children.**

Failure to observe this precaution could result in injury or product malfunction. In addition, note that small parts constitute a choking hazard. Should a child swallow any part of this product, seek immediate medical attention.

- **Do not entangle, wrap or twist the straps around your neck.**

Failure to observe this precaution could result in accidents.

- **Do not use batteries, chargers, or AC adapters not specifically designated for use with this product. When using batteries, chargers, and AC adapters designated for use with this product, do not:**

- **Damage, modify, forcibly tug or bend the cords or cables, place them under heavy objects, or expose them to heat or flame.**
- **Use travel converters or adapters designed to convert from one voltage to another or with DC-to-AC inverters.**

Failure to observe these precautions could result in fire or electric shock.

- **Do not handle the plug when charging the product or using the AC adapter during thunderstorms.**

Failure to observe this precaution could result in electric shock.

- **Do not handle with bare hands in locations exposed to extremely high or low temperatures.**

Failure to observe this precaution could result in burns, or frostbite.



CAUTION

- **Do not leave the lens pointed at the sun or other strong light sources.**

Light focused by the lens could cause fire or damage to product's internal parts. When shooting backlit subjects, keep the sun well out of the frame. Sunlight focused into the camera when the sun is close to the frame could cause fire.

- **Turn this product off when its use is prohibited. Disable wireless features when the use of wireless equipment is prohibited.**

The radio-frequency emissions produced by this product could interfere with equipment onboard aircraft or in hospitals or other medical facilities.

- **Remove the battery and disconnect the AC adapter if this product will not be used for an extended period.**

Failure to observe this precaution could result in fire or product malfunction.

- **Do not touch moving parts of the lens or other moving parts.**

Failure to observe this precaution could result in injury.

- **Do not fire the flash in contact with or in close proximity to the skin or objects.**

Failure to observe this precaution could result in burns or fire.

- **Do not leave the product where it will be exposed to extremely high temperatures, for an extended period such as in an enclosed automobile or in direct sunlight.**

Failure to observe this precaution could result in fire or product malfunction.



DANGER (Batteries)

- **Do not mishandle batteries.**

Failure to observe the following precautions could result in the batteries leaking, overheating, rupturing, or catching fire:

- Use only rechargeable batteries approved for use in this product.
 - Do not expose batteries to flame or excessive heat.
 - Do not disassemble.
 - Do not short-circuit the terminals by touching them to necklaces, hairpins, or other metal objects.
 - Do not expose batteries or the products in which they are inserted to powerful physical shocks.
-

- **Do not attempt to recharge EN-EL14a rechargeable batteries using chargers not specifically designated for this purpose.**

Failure to observe this precaution could result in the batteries leaking, overheating, rupturing, or catching fire.

- **If battery liquid comes into contact with the eyes, rinse with plenty of clean water and seek immediate medical attention.**

Delaying action could result in eye injuries.



WARNING (Batteries)

- **Keep batteries out of reach of children.**

Should a child swallow a battery, seek immediate medical attention.

- **Do not immerse batteries in water or expose to rain.**

Failure to observe this precaution could result in fire or product malfunction. Immediately dry the product with a towel or similar object should it become wet.

- **Discontinue use immediately should you notice any changes in the batteries, such as discoloration or deformation. Cease charging EN-EL14a rechargeable batteries if they do not charge in the specified period of time.**

Failure to observe these precautions could result in the batteries leaking, overheating, rupturing, or catching fire.

- **Prior to disposal, insulate battery terminals with tape.**

Overheating, rupture, or fire may result should metal objects come into contact with the terminals. Recycle or dispose of batteries in accord with local regulations.

- **If battery liquid comes into contact with a person's skin or clothing, immediately rinse the affected area with plenty of clean water.**

Failure to observe this precaution could result in skin irritation.

Notices

- No part of the manuals included with this product may be reproduced, transmitted, transcribed, stored in a retrieval system, or translated into any language in any form, by any means, without Nikon's prior written permission.
- Nikon reserves the right to change the appearance and specifications of the hardware and software described in these manuals at any time and without prior notice.
- Nikon will not be held liable for any damages resulting from the use of this product.
- While every effort has been made to ensure that the information in these manuals is accurate and complete, we would appreciate it were you to bring any errors or omissions to the attention of the Nikon representative in your area (address provided separately).

Notice for Customers in Canada

CAN ICES-3 B / NMB-3 B

Notices for Customers in Europe

CAUTION: RISK OF EXPLOSION IF BATTERY IS REPLACED BY AN INCORRECT TYPE. DISPOSE OF USED BATTERIES ACCORDING TO THE INSTRUCTIONS.

This symbol indicates that electrical and electronic equipment is to be collected separately.



This symbol on the battery indicates that the battery is to be collected separately.



The following apply only to users in European countries:

- This product is designated for separate collection at an appropriate collection point. Do not dispose of as household waste.
- Separate collection and recycling helps conserve natural resources and prevent negative consequences for human health and the environment that might result from incorrect disposal.
- For more information, contact the retailer or the local authorities in charge of waste management.

The following apply only to users in European countries:

- All batteries, whether marked with this symbol or not, are designated for separate collection at an appropriate collection point. Do not dispose of as household waste.
- For more information, contact the retailer or the local authorities in charge of waste management.

Notices for Customers in the U.S.A.

The Battery Charger

IMPORTANT SAFETY INSTRUCTIONS—SAVE THESE INSTRUCTIONS

DANGER—TO REDUCE THE RISK OF FIRE OR ELECTRIC SHOCK, CAREFULLY FOLLOW THESE INSTRUCTIONS

For connection to a supply not in the U.S.A., use an attachment plug adapter of the proper configuration for the power outlet if needed. This power unit is intended to be correctly oriented in a vertical or floor mount position.

Federal Communications Commission (FCC) Radio Frequency Interference Statement

This equipment has been tested and found to comply with the limits for a Class B digital device, pursuant to Part 15 of the FCC rules. These limits are designed to provide reasonable protection against harmful interference in a residential installation. This equipment generates, uses, and can radiate radio frequency energy and, if not installed and used in accordance with the instructions, may cause harmful interference to radio communications. However, there is no guarantee that interference will not occur in a particular installation. If this equipment does cause harmful interference to radio or television reception, which can be determined by turning the equipment off and on, the user is encouraged to try to correct the interference by one or more of the following measures:

- Reorient or relocate the receiving antenna.
- Increase the separation between the equipment and receiver.
- Connect the equipment into an outlet on a circuit different from that to which the receiver is connected.
- Consult the dealer or an experienced radio/television technician for help.



Nikon
D3400

CAUTIONS

Modifications

The FCC requires the user be notified that any changes or modifications made to this device that are not expressly approved by Nikon Corporation may void the user's authority to operate the equipment.

Interface Cables

Use the interface cables sold or provided by Nikon for your equipment. Using other interface cables may exceed the limits of Class B Part 15 of the FCC rules.

Nikon Inc., 1300 Walt Whitman Road,
Melville, New York 11747-3064, U.S.A.
Tel.: 631-547-4200

Notice Concerning Prohibition of Copying or Reproduction

Note that simply being in possession of material that has been digitally copied or reproduced by means of a scanner, digital camera, or other device may be punishable by law.

- **Items prohibited by law from being copied or reproduced**

Do not copy or reproduce paper money, coins, securities, government bonds, or local government bonds, even if such copies or reproductions are stamped "Sample."

The copying or reproduction of paper money, coins, or securities which are circulated in a foreign country is prohibited.

Unless the prior permission of the government has been obtained, the copying or reproduction of unused postage stamps or post cards issued by the government is prohibited.

The copying or reproduction of stamps issued by the government and of certified documents stipulated by law is prohibited.

- **Cautions on certain copies and reproductions**

The government has issued cautions on copies or reproductions of securities issued by private companies (shares, bills, checks, gift certificates, etc.), commuter passes, or coupon tickets, except when a minimum of necessary copies are to be provided for business use by a company. Also, do not copy or reproduce passports issued by the government, licenses issued by public agencies and private groups, ID cards, and tickets, such as passes and meal coupons.

- **Comply with copyright notices**

Under copyright law, photographs or recordings of copyrighted works made with the camera can not be used without the permission of the copyright holder. Exceptions apply to personal use, but note that even personal use may be restricted in the case of photographs or recordings of exhibits or live performances.

Disposing of Data Storage Devices

Please note that deleting images or formatting memory cards or other data storage devices does not completely erase the original image data. Deleted files can sometimes be recovered from discarded storage devices using commercially available software, potentially resulting in the malicious use of personal image data. Ensuring the privacy of such data is the user's responsibility.

Before discarding a data storage device or transferring ownership to another person, erase all data using commercial deletion software, or format the device and then completely refill it with images containing no private information (for example, pictures of empty sky). Care should be taken to avoid injury when physically destroying data storage devices.

Before discarding the camera or transferring ownership to another person, you should also use the **Reset all settings** option in the camera setup menu to delete any personal network information.

AVC Patent Portfolio License

THIS PRODUCT IS LICENSED UNDER THE AVC PATENT PORTFOLIO LICENSE FOR THE PERSONAL AND NON-COMMERCIAL USE OF A CONSUMER TO (i) ENCODE VIDEO IN COMPLIANCE WITH THE AVC STANDARD ("AVC VIDEO") AND/OR (ii) DECODE AVC VIDEO THAT WAS ENCODED BY A CONSUMER ENGAGED IN A PERSONAL AND NON-COMMERCIAL ACTIVITY AND/OR WAS OBTAINED FROM A VIDEO PROVIDER LICENSED TO PROVIDE AVC VIDEO. NO LICENSE IS GRANTED OR SHALL BE IMPLIED FOR ANY OTHER USE. ADDITIONAL INFORMATION MAY BE OBTAINED FROM MPEG LA, L.L.C. SEE <http://www.mpegla.com>

Use Only Nikon Brand Electronic Accessories

Nikon cameras are designed to the highest standards and include complex electronic circuitry. Only Nikon brand electronic accessories (including chargers, batteries, AC adapters, and flash accessories) certified by Nikon specifically for use with this Nikon digital camera are engineered and proven to operate within the operational and safety requirements of this electronic circuitry.

The use of non-Nikon electronic accessories could damage the camera and may void your Nikon warranty. The use of third-party rechargeable Li-ion batteries not bearing the Nikon holographic seal shown at right could interfere with normal operation of the camera or result in the batteries overheating, igniting, rupturing, or leaking.

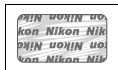

For more information about Nikon brand accessories, contact a local authorized Nikon dealer.

Use Only Nikon Brand Accessories

Only Nikon brand accessories certified by Nikon specifically for use with your Nikon digital camera are engineered and proven to operate within its operational and safety requirements. THE USE OF NON-NIKON ACCESSORIES COULD DAMAGE YOUR CAMERA AND MAY VOID YOUR NIKON WARRANTY.

Before Taking Important Pictures

Before taking pictures on important occasions (such as at weddings or before taking the camera on a trip), take a test shot to ensure that the camera is functioning normally. Nikon will not be held liable for damages or lost profits that may result from product malfunction.

Life-Long Learning

As part of Nikon's "Life-Long Learning" commitment to ongoing product support and education, continually-updated information is available online at the following sites:

- **For users in the U.S.A.:** <http://www.nikonusa.com/>
- **For users in Europe and Africa:** <http://www.europe-nikon.com/support/>
- **For users in Asia, Oceania, and the Middle East:** <http://www.nikon-asia.com/>

Visit these sites to keep up-to-date with the latest product information, tips, answers to frequently-asked questions (FAQs), and general advice on digital imaging and photography. Additional information may be available from the Nikon representative in your area. See the following URL for contact information: <http://imaging.nikon.com/>

Bluetooth

This product is controlled by the United States Export Administration Regulations (EAR). The permission of the United States government is not required for export to countries other than the following, which as of this writing are subject to embargo or special controls: Cuba, Iran, North Korea, Sudan, and Syria (list subject to change).

The use of wireless devices may be prohibited in some countries or regions. Contact a Nikon-authorized service representative before using the wireless features of this product outside the country of purchase.

Notice for Customers in the U.S.A. and Canada

This device complies with Part 15 of FCC Rules and Industry Canada licence-exempt RSS standard(s). Operation is subject to the following two conditions: (1) this device may not cause interference, and (2) this device must accept any interference, including interference that may cause undesired operation of the device.

FCC WARNING

The FCC requires the user to be notified that any changes or modifications made to this device that are not expressly approved by Nikon Corporation may void the user's authority to operate the equipment.

FCC Radio Frequency Interference Statement

Note: This equipment has been tested and found to comply with the limits for a Class B digital device, pursuant to part 15 of the FCC Rules. These limits are designed to provide reasonable protection against harmful interference in a residential installation. This equipment generates, uses and can radiate radio frequency energy and, if not installed and used in accordance with the instructions, may cause harmful interference to radio communications. However, there is no guarantee that interference will not occur in a particular installation. If this equipment does cause harmful interference to radio or television reception, which can be determined by turning the equipment off and on, the user is encouraged to try to correct the interference by one or more of the following measures:

- Reorient or relocate the receiving antenna.
- Increase the separation between the equipment and receiver.
- Connect the equipment into an outlet on a circuit different from that to which the receiver is connected.
- Consult the dealer or an experienced radio/TV technician for help.

Co-location

This transmitter must not be co-located or operated in conjunction with any other antenna or transmitter.

Nikon Inc., 1300 Walt Whitman Road, Melville, New York 11747-3064, U.S.A.
Tel.: 631-547-4200

FCC/IC RF Exposure Statement

The available scientific evidence does not show that any health problems are associated with using low power wireless devices. There is no proof, however, that these low power wireless devices are absolutely safe. Low power wireless devices emit low levels of radio frequency energy (RF) in the microwave range while being used. Whereas high levels of RF can produce health effects (by heating tissue), exposure of low-level RF that does not produce heating effects causes no known adverse health effects. Many studies of low-level RF exposures have not found any biological effects. Some studies have suggested that some biological effects might occur, but such findings have not been confirmed by additional research. The D3400, which is equipped with a TYPE1FJ (FCC ID:VPYLB1FJ / IC ID:772C-LB1FJ), has been tested and found to comply with FCC/IC radiation exposure limits set forth for an uncontrolled environment and meets the FCC radio frequency (RF) Exposure Guidelines in Supplement C to OET65 and RSS-102 of the IC radio frequency (RF) Exposure rules. Please refer to the SAR test report that was uploaded to FCC website.

Notices for Customers in Europe

Hereby, Nikon Corporation declares that the radio equipment type D3400 is in compliance with Directive 2014/53/EU. The full text of the EU declaration of conformity is available at the following internet address:

http://imaging.nikon.com/support/pdf/DoC_D3400.pdf.



Notice for Customers in Singapore

Trade Name: **Nikon**
Model: D3400

This device complies with radio-frequency regulations. The content of certification labels not affixed to the device is given below.

Complies with
IMDA Standards
DA103423

Notice for Customers in Nigeria

Connection and use of this communications
equipment is permitted by the Nigerian
Communications Commission

Security

Although one of the benefits of this product is that it allows others to freely connect for the wireless exchange of data anywhere within its range, the following may occur if security is not enabled:

- **Data theft:** Malicious third-parties may intercept wireless transmissions to steal user IDs, passwords, and other personal information.
- **Unauthorized access:** Unauthorized users may gain access to the network and alter data or perform other malicious actions. Note that due to the design of wireless networks, specialized attacks may allow unauthorized access even when security is enabled.
- **Unsecured networks:** Connecting to open networks may result in unauthorized access. Use secure networks only.

Introduction

Getting to Know the Camera

Take a few moments to familiarize yourself with camera controls and displays. You may find it helpful to bookmark this section and refer to it as you read through the rest of the manual.

The Camera Body

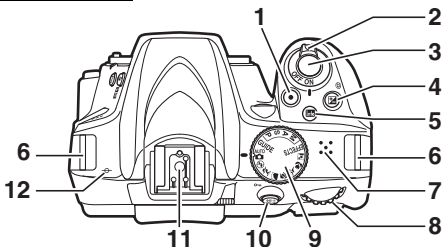

1	Movie-record button	39	8	Command dial	
2	Power switch	18, 23	9	Mode dial	5
3	Shutter-release button	30, 31	10	AEL/AFL button	71
4	AF-ON button	65, 67	11	Accessory shoe (for optional flash units)	
5	Info (information) button	7, 26	12	Focal plane mark (-e-)	
6	Eyelets for camera strap	10			
7	Speaker				

The Speaker

Do not place the speaker in close proximity to magnetic devices. Failure to observe this precaution could affect the data recorded on the magnetic devices.

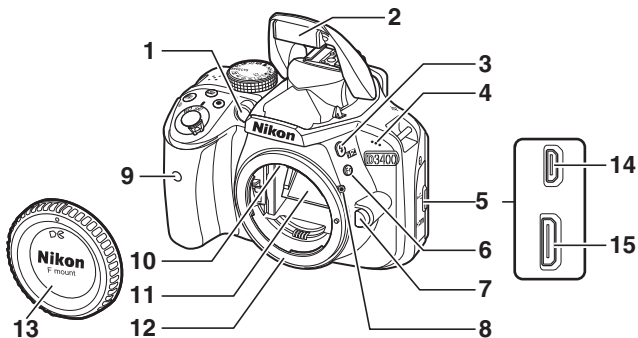

<p>1 AF-assist illuminator Self-timer lamp Red-eye reduction lamp</p>	<p>9 Infrared receiver for ML-L3 remote control.....84</p>
<p>2 Built-in flash.....33</p>	<p>10 CPU contacts</p>
<p>3 / button.....62</p>	<p>11 Mirror</p>
<p>4 Microphone41</p>	<p>12 Lens mount 15</p>
<p>5 Connector cover</p>	<p>13 Body cap..... iii, 15, 83</p>
<p>6 Fn button71</p>	<p>14 USB connector77</p>
<p>7 Lens release button..... 16</p>	<p>15 HDMI connector</p>
<p>8 Mounting mark 15</p>	

✓ Close the Connector Cover

Close the connector cover when the connectors are not in use. Foreign matter in the connectors can interfere with data transfer.

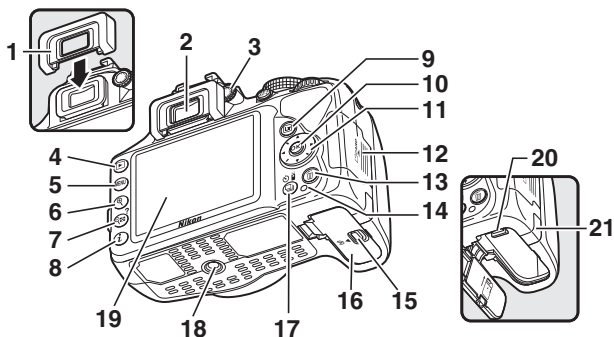

1 Rubber eyecup	13 button 37
2 Viewfinder eyepiece..... 4, 25	14 Memory card access lamp..... 31
3 Diopter adjustment control 25	15 Battery-chamber cover latch 12, 13
4 button..... 35	16 Battery-chamber cover 12, 13
5 MENU button..... 69	17 / / button..... 6
6 button 33, 35	18 Tripod socket
7 / / button 35, 73	19 Monitor 7, 27, 35
8 button 9	20 Battery latch..... 12, 13
9 button..... 27, 38	21 Power connector cover for optional power connector
10 (OK) button..... 73	
11 Multi selector 73	
12 Memory card slot cover..... 12, 13	

The Viewfinder

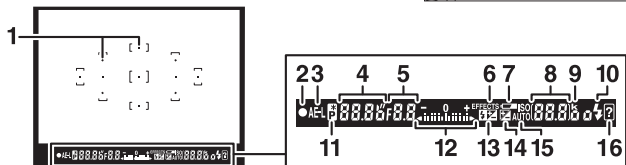
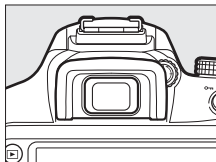

<p>1 Focus points.....29</p> <p>2 Focus indicator.....30</p> <p>3 Autoexposure (AE) lock indicator</p> <p>4 Shutter speed66</p> <p>5 Aperture (f-number)66</p> <p>6 Special effects mode indicator...53</p> <p>7 Low battery warning26</p> <p>8 Number of exposures remaining26</p> <p>Number of shots remaining before memory buffer fills</p> <p>White balance recording indicator</p> <p>Exposure compensation value67</p> <p>Flash compensation value</p> <p>ISO sensitivity9</p>	<p>9 “k” (appears when memory remains for over 1000 exposures)26</p> <p>10 Flash-ready indicator.....33</p> <p>11 Flexible program indicator</p> <p>12 Exposure indicator66</p> <p>Exposure compensation display67</p> <p>Electronic rangefinder</p> <p>13 Flash compensation indicator.....9</p> <p>14 Exposure compensation indicator67</p> <p>15 Auto ISO sensitivity indicator</p> <p>16 Warning indicator90</p>
---	--



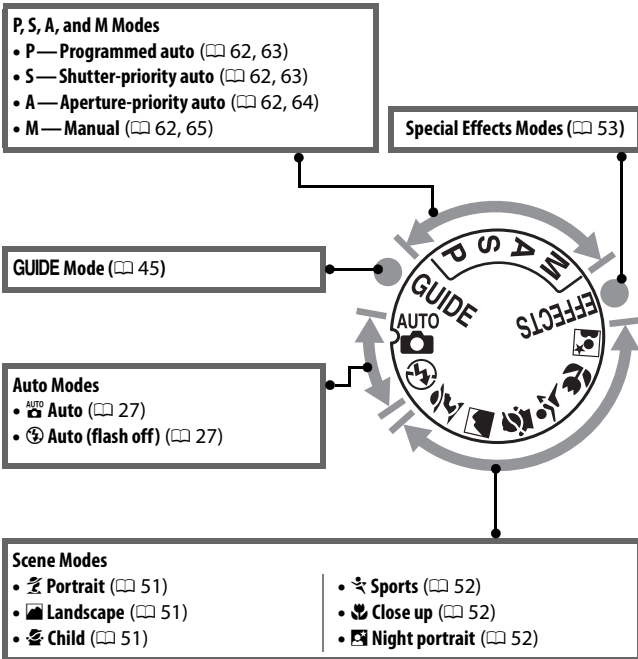

Note: Display shown with all indicators lit for illustrative purposes.

The Mode Dial

The camera offers a choice of the following shooting modes and **GUIDE** mode:







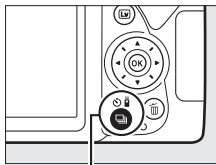

The (/) Button

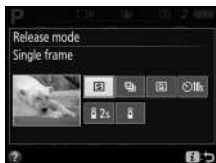
To choose how the shutter is released (release mode), press the  (/) button, then use the multi selector to highlight the desired option and press .



 (/) button



Mode	Description
	Single frame: Camera takes one photograph each time shutter-release button is pressed.
	Continuous: The camera takes photographs while the shutter-release button is pressed.
	Quiet shutter release: As for single-frame, except that camera noise is reduced.
	Self-timer: Take pictures using the self-timer. The timer starts when the shutter-release button is pressed all the way down, and the shutter is released after about 10 seconds.
 2s	Delayed remote (ML-L3): Shutter is released 2 s after shutter-release button on optional ML-L3 remote control is pressed.
	Quick-response remote (ML-L3): Shutter is released when shutter-release button on optional ML-L3 remote control is pressed.

The Information Display

Viewing settings: To view the information display, press the **info** button.

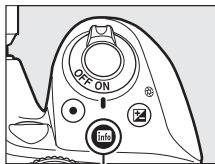

info button



1	Shooting mode AUTO auto/ auto (flash off)..... 27 Scene modes..... 51 Special effects mode..... 53 P, S, A, and M modes..... 62	4	Vignette control indicator 70
2	Eye-Fi connection indicator 71	5	Date stamp indicator 71
3	Bluetooth connection indicator..... 19 Airplane mode 71	6	Vibration reduction indicator 70
		7	Flash control indicator Flash compensation indicator for optional flash units
		8	Release mode6
		9	"Beep" indicator 71

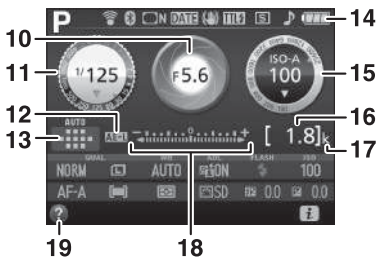

<p>10 Aperture (f-number)66 Aperture display66</p> <p>11 Shutter speed66 Shutter-speed display66</p> <p>12 Autoexposure (AE) lock indicator</p> <p>13 AF-area mode indicator9 Focus point.....29</p> <p>14 Battery indicator26</p> <p>15 ISO sensitivity9 ISO sensitivity display Auto ISO sensitivity indicator</p>	<p>16 Number of exposures remaining26 White balance recording indicator</p> <p>17 "k" (appears when memory remains for over 1000 exposures)26</p> <p>18 Exposure indicator66 Exposure compensation indicator67</p> <p>19 Help icon90</p>
--	--

Note: Display shown with all indicators lit for illustrative purposes.

Turning the Monitor Off

To clear shooting information from the monitor, press the  button or press the shutter-release button halfway. The monitor will turn off automatically if no operations are performed for about 8 seconds (the **Auto off timers** option in the setup menu, can be used to choose how long the monitor remains on).

Changing settings: To change the settings at the bottom of the display, press the **i** button, then highlight items using the multi selector and press **OK** to view options for the highlighted item. You can also change settings by pressing the **i** button during live view.

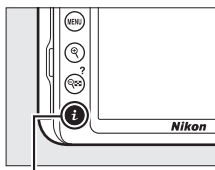

i button

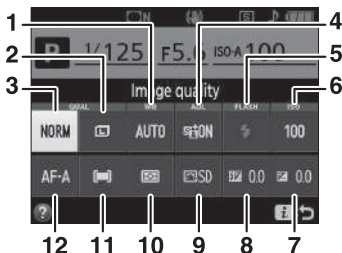

1	White balance	Adjust settings for different types of lighting.
2	Image size	Choose a size for new photos.
3	Image quality	Choose a file format and compression ratio.
4	Active D-Lighting	Improves the level of detail in highlights and shadows under high-contrast conditions.
5	Flash mode	Choose the flash mode.
6	ISO sensitivity	Control the camera's sensitivity to light.
7	Exposure compensation	Adjust exposure from the value metered by the camera, making the entire frame brighter or darker.
8	Flash compensation	Adjust flash level.
9	Set Picture Control	Picture Controls determine how new photos are processed. Choose a Picture Control according to the type of scene or your creative intent.
10	Metering	Choose how the camera meters exposure.
11	AF-area mode	Choose how the focus area is selected.
12	Focus mode	Choose how the camera focuses.

First Steps

Attach the Camera Strap

Attach the strap securely to the two camera eyelets.

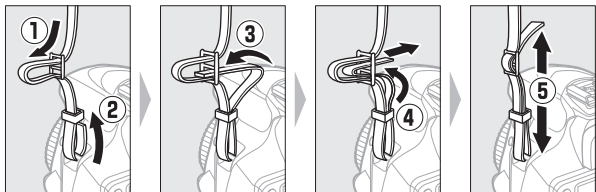

Charge the Battery

If a plug adapter is supplied, raise the wall plug and connect the plug adapter as shown below at left, making sure the plug is fully inserted. Insert the battery and plug the charger in. An exhausted battery will fully charge in about an hour and 50 minutes.

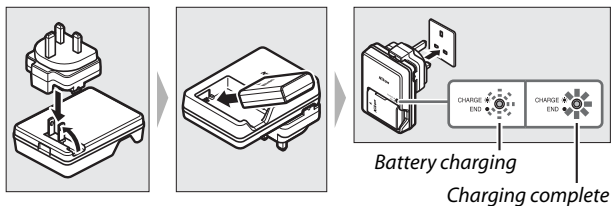

✓ During Charging

Do not move the charger or touch the battery during charging. Failure to observe this precaution could in very rare instances result in the charger showing that charging is complete when the battery is only partially charged. Remove and reinsert the battery to begin charging again.

Charging the Battery

Read and follow the warnings and cautions on pages xi–xiv and 86–89 of this manual. Charge the battery indoors at ambient temperatures of 5 °C–35 °C (41 °F–95 °F). Do not use the battery at ambient temperatures below 0 °C/32 °F or above 40 °C/104 °F; failure to observe this precaution could damage the battery or impair its performance. Capacity may be reduced and charging times may increase at battery temperatures from 0 °C/32 °F to 15 °C/59 °F and from 45 °C/113 °F to 60 °C/140 °F. The battery will not charge if its temperature is below 0 °C (32 °F) or above 60 °C (140 °F). If the **CHARGE** lamp flashes quickly (about eight times a second) during charging, confirm that the temperature is in the correct range and then unplug the charger and remove and reinsert the battery. If the problem persists, cease use immediately and take battery and charger to your retailer or a Nikon-authorized service representative.

Do not short the charger terminals. Failure to observe this precaution could result in overheating and damage to the charger.

Use the charger with compatible batteries only. Unplug when not in use.

Insert the Battery and a Memory Card

Before inserting or removing the battery or memory cards, confirm that power switch is in the **OFF** position. Insert the battery as shown, using the battery to keep the orange battery latch pressed to one side. The latch locks the battery in place when the battery is fully inserted.

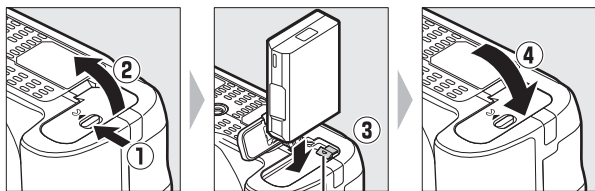

Battery latch

Holding the memory card in the orientation shown, slide it in until it clicks into place.

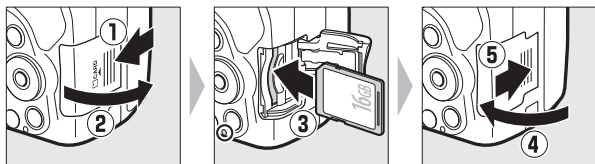

The Clock Battery

The camera clock is powered by an independent, rechargeable power source, which is charged as necessary when the main battery is installed. Three days of charging will power the clock for about a month. If a message warning that the clock is not set is displayed when the camera is turned on, the clock battery is exhausted and the clock has been reset. Set the clock to the correct time and date.

■ ■ Removing the Battery and Memory Cards

Removing the Battery

To remove the battery, turn the camera off and open the battery-chamber cover. Press the battery latch in the direction shown by the arrow to release the battery and then remove the battery by hand.

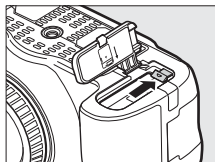

Removing Memory Cards

After confirming that the memory card access lamp is off, turn the camera off, open the memory card slot cover, and press the card in to eject it (1). The card can then be removed by hand (2).

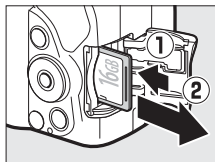

🔧 Formatting Memory Cards

If this is the first time the memory card will be used in the camera or if the card has been formatted in another device, select **Format memory card** in the setup menu and follow the on-screen instructions to format the card (📖 71). *Note that this permanently deletes any data the card may contain.* Be sure to copy any photographs and other data you wish to keep to a computer before proceeding.



✔ Memory Cards

- Memory cards may be hot after use. Observe due caution when removing memory cards from the camera.
- Do not remove memory cards from the camera, turn the camera off, or remove or disconnect the power source during formatting or while data are being recorded, deleted, or copied to a computer. Failure to observe these precautions could result in loss of data or in damage to the camera or card.
- Do not touch the card terminals with your fingers or metal objects.
- Do not bend, drop, or subject to strong physical shocks.
- Do not apply force to the card casing. Failure to observe this precaution could damage the card.
- Do not expose to water, heat, high levels of humidity, or direct sunlight.
- Do not format memory cards in a computer.

Attach a Lens

Be careful to prevent dust from entering the camera when the lens or body cap is removed.

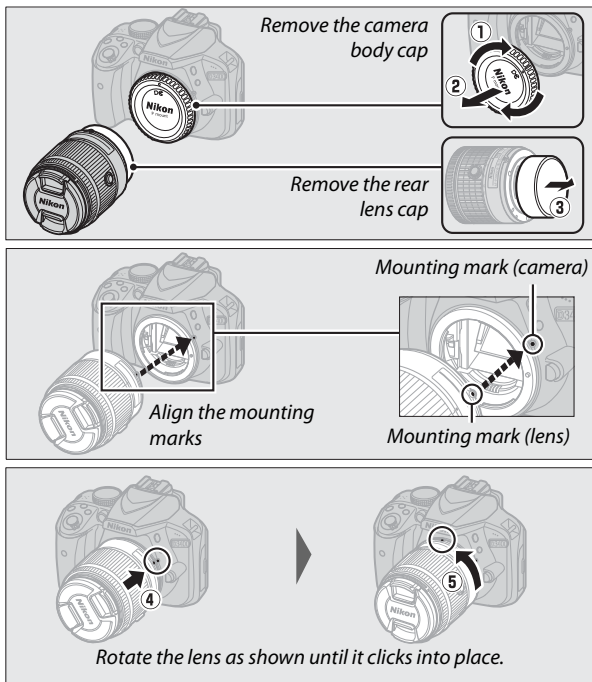

Be sure to remove the lens cap before taking pictures.

Detaching the Lens

Be sure the camera is off when removing or exchanging lenses. To remove the lens, press and hold the lens release button (①) while turning the lens clockwise (②). After removing the lens, replace the lens caps and camera body cap.

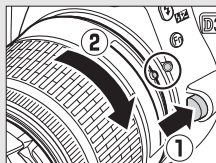

Lenses with Retractable Lens Barrel Buttons

Before using the camera, unlock and extend the lens. Keeping the retractable lens barrel button pressed (①), rotate the zoom ring as shown (②).

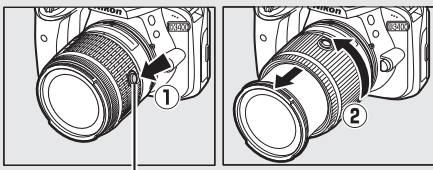

Retractable lens barrel button

Pictures can not be taken when the lens is retracted; if an error message is displayed as a result of the camera having been turned on with the lens retracted, rotate the zoom ring until the message is no longer displayed.



Retracting Lenses with Retractable Lens Barrel Buttons

To retract the lens when the camera is not in use, hold the retractable lens barrel button (①) and rotate the zoom ring to the "L" (lock) position as shown (②). Retract the lens before removing it from the camera, and be careful not to press the retractable lens barrel button when attaching or removing the lens.

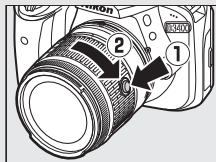

Camera Setup

■ ■ *Setup Using a Smartphone or Tablet*

Before proceeding, check the camera to ensure that the battery is fully charged and the memory card has space available. On your smartphone or tablet (below “smart device”), install the SnapBridge app as described inside the front cover and enable Bluetooth. Note that the actual connection to the camera will be made using the SnapBridge app; do not use Bluetooth settings in the settings app on your smart device. The instructions that follow refer to version 2.0 of the SnapBridge app; for information on the latest version, see the *SnapBridge Connection Guide* (pdf), available for download from the following website:



<http://downloadcenter.nikonimglib.com>

The actual camera and smart device displays may differ from those shown below.

- 1 Camera:** Turn the camera on. A language-selection dialog will be displayed.



Use the multi selector and **OK** button to navigate the menus.

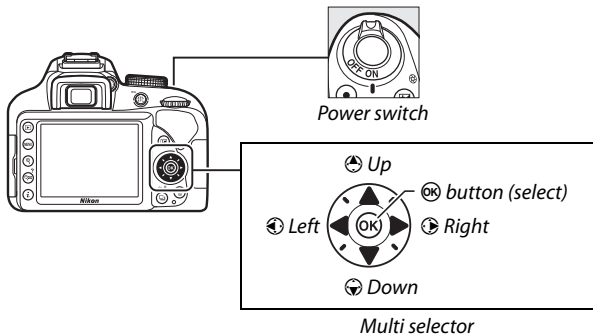

Press **Up** and **Down** to highlight a language and press **OK** to select. The language can be changed at any time using the **Language** option in the setup menu.

-
- 2 Camera:** When the dialog at right is displayed, press **OK**. If the dialog at right is not displayed or if you wish to configure the camera again, highlight **Connect to smart device** in the setup menu and press **OK**. If you do not wish to use a smart device to configure the camera, set the clock manually (📖 24).

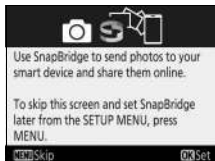

-
- 3 Camera/smart device:** Start pairing.

The camera will wait for a connection; launch the SnapBridge app on the smart device and follow the on-screen instructions to tap the name of the camera you want to pair with.

-
- 4 Camera:** Confirm that the camera displays the message shown at right and ready the smart device.

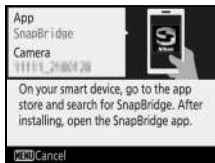

-
- 5 Smart device:** Launch the SnapBridge app and tap **Pair with camera**. If prompted to choose a camera, tap the camera name.



- 6 Smart device:** Tap the camera name in the “Pair with camera” dialog. Users who are pairing a camera with an iOS device for the first time will first be presented with pairing instructions; after reading the instructions, scroll to the bottom of the display and tap **Understood**. If you are then prompted to choose an accessory, tap the camera name again (there may be some delay before the camera name is displayed).

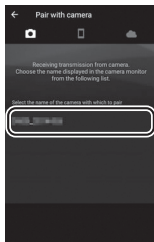

- 7 Camera/smart device:** Confirm that the camera and smart device display the same six-digit number. Some versions of iOS may not display a number; if no number displayed, proceed to Step 8.

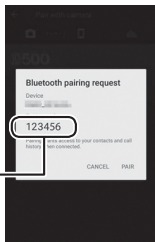

- 8** Camera/smart device: Press **OK** on the camera and tap **PAIR** on the smart device (the display varies with the device and operating system).

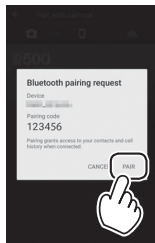

- 9** Camera/smart device: Complete pairing.



- **Camera:** Press **OK** when the message at right is displayed.

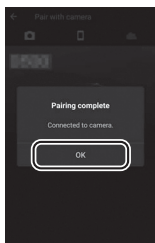

- **Smart device:** Tap **OK** when the message at right is displayed.



10 **Camera:** Follow the on-screen instructions to complete setup.

- **To allow the camera to add location data to photos,** select **Yes** in response to “Download location data from smart device?” and then enable location services on the smart device and enable **Auto link options > Synchronize location data** in the SnapBridge app  tab.
- **To synchronize the camera clock with the time provided by the smart device,** select **Yes** in response to “Sync clock with smart device?” and then enable **Auto link options > Synchronize clocks** in the SnapBridge app  tab.

The smart device and camera are now connected. Any pictures you take with the camera will automatically be uploaded to the smart device.

■ ■ Setup from the Camera Menus

The camera clock can be set manually.

1 Turn the camera on.

A language-selection dialog will be displayed.



Use the multi selector and **OK** button to navigate the menus.

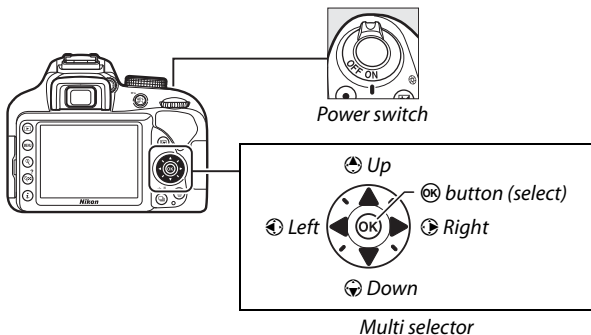

Press **Up** and **Down** to highlight a language and press **OK** to select. The language can be changed at any time using the **Language** option in the setup menu.

- 2** Press MENU when the dialog at right is displayed.

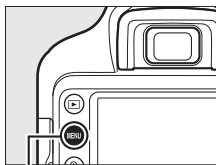
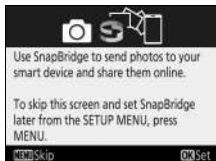

MENU button

- 3** Set the camera clock.

Use the multi selector and **OK** button to set the camera clock.



Select time zone



Select date format

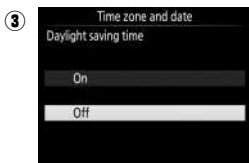

Select daylight saving time option

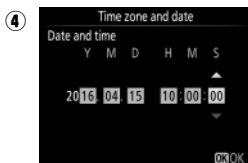

Set time and date (note that the camera uses a 24-hour clock)

The clock can be adjusted at any time using the **Time zone and date** > **Date and time** option in the setup menu.

Focus the Viewfinder

After removing the lens cap, rotate the diopter adjustment control until the focus points are in sharp focus. When operating the control with your eye to the viewfinder, be careful not to put your fingers or fingernails in your eye.

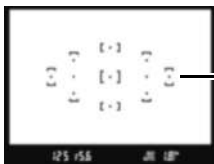
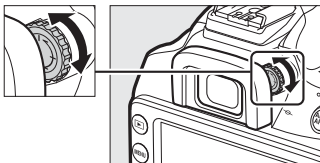

Viewfinder not in focus

Focus points

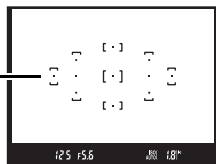

Viewfinder in focus

The camera is now ready for use. Proceed to page 27 for information on taking photographs.

The Battery Level and Number of Exposures Remaining

Press the **info** button and check the battery level and number of exposures remaining in the information display.

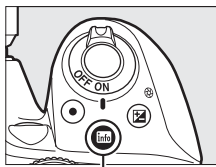

info button



Number of exposures remaining

Battery Level

If the battery is low, a warning will also be displayed in the viewfinder. If the information display does not appear when the **info** button is pressed, the battery is exhausted and needs to be recharged.





Information display	Viewfinder	Description
	—	Battery fully charged.
	—	Battery partially discharged.
		Low battery. Ready fully-charged spare battery or prepare to charge battery.
 (flashes)	 (flashes)	Battery exhausted. Charge battery.

Number of Exposures Remaining

Values over 1000 are shown in thousands, indicated by the letter "k".

Basic Photography and Playback

“Point-and-Shoot” Modes (AUTO and)

This section describes how to take photographs in  and  modes.  and  are automatic “point-and-shoot” modes in which the majority of settings are controlled by the camera in response to shooting conditions; the only difference between the two is that the flash will not fire in  mode.



- 1 Rotate the mode dial to  or .

Mode dial

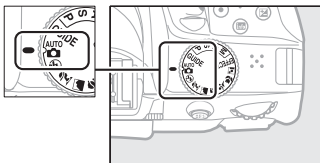

Photographs can be framed in the viewfinder or in the monitor (live view). To start live view, press the  button.

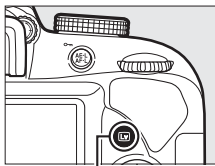

 button



Framing pictures in the viewfinder



Framing pictures in the monitor (live view)

2 Ready the camera.

Viewfinder photography: When framing photographs in the viewfinder, hold the handgrip in your right hand and cradle the camera body or lens with your left. Bring your elbows in against the sides of your chest.



Live view: When framing photographs in the monitor, hold the handgrip in your right hand and cradle the lens with your left.



Framing Photographs in Portrait (Tall) Orientation

When framing photographs in portrait (tall) orientation, hold the camera as shown below.



Framing photographs in the viewfinder



Framing photographs in the monitor

3 Frame the photograph.

Viewfinder photography: Frame a photograph in the viewfinder with the main subject in at least one of the 11 focus points.

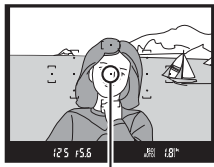

Focus point

Live view: At default settings, the camera automatically detects faces and selects the focus point. If no face is detected, the camera will focus on subjects near the center of the frame.



Focus point

Using a Zoom Lens

Before focusing, rotate the zoom ring to adjust the focal length and frame the photograph. Use the zoom ring to zoom in on the subject so that it fills a larger area of the frame, or zoom out to increase the area visible in the final photograph (select longer focal lengths on the lens focal length scale to zoom in, shorter focal lengths to zoom out).

Zoom in

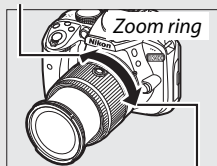

Zoom out

4 Press the shutter-release button halfway.

Viewfinder photography: Press the shutter-release button halfway to focus (if the subject is poorly lit, the flash may pop up and the AF-assist illuminator may light).



In-focus indicator

When the focus operation is complete, a beep will sound (a beep may not sound if the subject is moving) and the in-focus indicator (●) will appear in the viewfinder.

In-focus indicator	Description
●	Subject in focus.
● (flashes)	Camera unable to focus using autofocus. See page 91.

Live view: The focus point flashes green while the camera focuses. If the camera is able to focus, the focus point will be displayed in green; otherwise, the focus point will flash red.



5 Shoot.

Smoothly press the shutter-release button the rest of the way down to take the photograph. The memory card access lamp will light and the photograph will be displayed in the monitor for a few seconds. *Do not eject the memory card or remove or disconnect the power source until the lamp has gone out and recording is complete.*

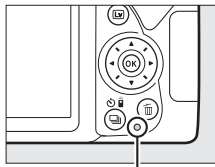

Memory card access lamp



To end live view, press the **[Lv]** button.

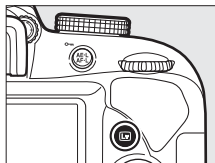

The Shutter-Release Button

The camera has a two-stage shutter-release button. The camera focuses when the shutter-release button is pressed halfway. To take the photograph, press the shutter-release button the rest of the way down.





Focus: press halfway











Shoot: press all the way down

Pressing the shutter-release button halfway also ends playback and readies the camera for immediate use.

Automatic Scene Selection (Scene Auto Selector)

If live view is selected in  or  mode, the camera will automatically analyze the subject and select the appropriate shooting mode when the shutter-release button is pressed halfway to focus using autofocus. The selected mode is shown in the monitor.



	Portrait	Human portrait subjects
	Landscape	Landscapes and cityscapes
	Close up	Subjects close to the camera
	Night portrait	Portrait subjects framed against a dark background
	Auto	Subjects suited to  or  mode or that do not fall into the categories listed above
	Auto (flash off)	

The Standby Timer (Viewfinder Photography)

The viewfinder and information display will turn off if no operations are performed for about eight seconds, reducing the drain on the battery. Press the shutter-release button halfway to reactivate the display. The length of time before the standby timer expires automatically can be selected using the **Auto off timers** option in the setup menu ( 71).



Exposure meters off



Exposure meters on

The Count Down Display (Live View)

A count down will be displayed 30 s before live view ends automatically (the timer turns red 5 s before the auto off timer expires (**Auto off timers**;  71) or if live view is about to end to protect the internal circuits). Depending on shooting conditions, the timer may appear immediately when live view is selected.

🔍 The Built-in Flash

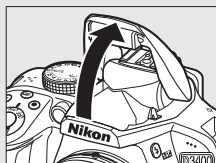

If additional lighting is required for correct exposure in **AUTO** mode, the built-in flash will pop up automatically when the shutter-release button is pressed halfway. If the flash is raised, photographs can only be taken when the flash-ready indicator (⚡) is displayed. If the flash-ready indicator is not displayed, the flash is charging; remove your finger briefly from the shutter-release button and try again.

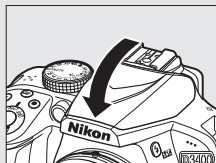

When the flash is not in use, return it to its closed position by pressing it gently downward till the latch clicks into place.



🔍 Live View Zoom Preview

To magnify the view in the monitor up to about 8.3 × for precise focus, press the  button. While the view through the lens is zoomed in, a navigation window will appear in a gray frame at the bottom right corner of the display. Use the multi selector to scroll to areas of the frame not visible in the monitor, or press  (?) to zoom out.

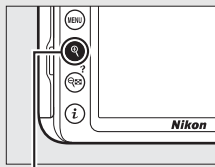

 button



Navigation window

Shooting in Live View

Although they will not appear in the final picture, jagged edges, color fringing, moiré, and bright spots may appear in the monitor, while bright regions or bands may appear in some areas with flashing signs and other intermittent light sources or if the subject is briefly illuminated by a strobe or other bright, momentary light source. In addition, distortion may occur with moving subjects, particularly if the camera is panned horizontally or an object moves horizontally at high speed through the frame. Flicker and banding visible in the monitor under fluorescent, mercury vapor, or sodium lamps can be reduced using **Flicker reduction** (📖 71), although they may still be visible in the final photograph at some shutter speeds. Avoid pointing the camera at the sun or other strong light sources. Failure to observe this precaution could result in damage to the camera's internal circuitry. Live view ends automatically if the mode dial is rotated to **GUIDE** or the mode dial is rotated from **GUIDE** to another setting.

To prevent light entering via the viewfinder from appearing in the photograph or interfering with exposure, we recommend that you cover the viewfinder with your hand or other objects such as an optional eyepiece cap before taking pictures without your eye to the viewfinder.

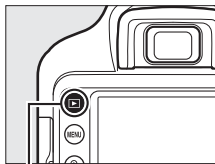

Viewing Photographs

Pressing  displays a picture in the monitor.





 button





Press  or  to view additional pictures.



Thumbnail Playback

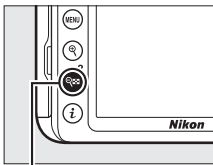

To display images in “contact sheets” of four, nine, or 72 images (thumbnail playback), press the  (?) button. Use the multi selector or command dial to highlight images and press  to display the highlighted image full frame. Press  to reduce the number of images displayed.



 (?) button



Calendar Playback

To view images taken on a selected date (calendar playback), press the  (?) button when 72 images are displayed. Press the  (?) button to toggle between the date list and the list of thumbnails for the selected date. Use the multi selector to highlight dates in the date list or to highlight pictures in the thumbnail list. Press  when the cursor is in the date list to return to 72-frame playback.

Date list



Thumbnail list

Deleting Unwanted Photographs

To delete the photograph currently displayed in the monitor, press the  button. *Note that photographs can not be recovered once deleted.*

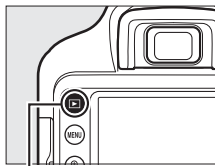

1 Display the photograph.

Display the photograph you wish to delete.



 button

2 Delete the photograph.

Press the  button. A confirmation dialog will be displayed; press the  button again to delete the image and return to playback.

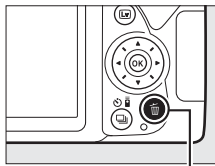

 button



Recording Movies

Movies can be recorded in live view mode.

1 Press the **[Lv]** button.

The view through the lens will be displayed in the monitor.

✓ The Icon

A  icon indicates that movies can not be recorded.

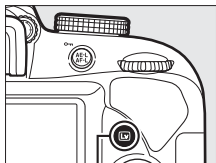

[Lv] button

2 Ready the camera.

Hold the handgrip in your right hand and cradle the camera body or lens with your left.



3 Focus.

Press the shutter-release button halfway to focus.



4 Start recording.

Press the movie-record button to start recording. A recording indicator and the time available are displayed in the monitor.

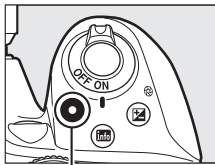

Movie-record button

Recording indicator



Time remaining

5 End recording.

Press the movie-record button again to end recording. Recording will end automatically when the maximum length is reached, the memory card is full, or another mode is selected. Press the  button to end live view.

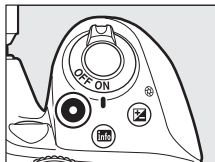

Maximum Length

The maximum size for individual movie files is 4 GB; maximum length varies with the options selected for **Movie settings > Frame size/frame rate** and **Movie quality** in the shooting menu (□ 70) as shown below. Note that depending on memory card write speed, shooting may end before this length is reached.

Movie quality	Frame size/frame rate ¹	Maximum length ²	
High quality	 1920 × 1080; 60p	10 min.	
	 1920 × 1080; 50p		
	 1920 × 1080; 30p	20 min.	
	 1920 × 1080; 25p		
	 1920 × 1080; 24p		
	 1280 × 720; 60p		
 1280 × 720; 50p	20 min.		
Normal		 1920 × 1080; 60p	
		 1920 × 1080; 50p	
		 1920 × 1080; 30p	29 min. 59 s
		 1920 × 1080; 25p	
		 1920 × 1080; 24p	
	 1280 × 720; 60p		
	 1280 × 720; 50p		

1 Listed value. Actual frame rates for 60p, 50p, 30p, 25p, and 24p are 59.94, 50, 29.97, 25, and 23.976 fps respectively.

2 Movies recorded in miniature effect mode are up to three minutes long when played back.

☑ Recording Movies

Flicker, banding, or distortion may be visible in the monitor and in the final movie under fluorescent, mercury vapor, or sodium lamps or with subjects that are in motion, particularly if the camera is panned horizontally or an object moves horizontally at high speed through frame (flicker and banding can be reduced using **Flicker reduction**; □ 71). Jagged edges, color fringing, moiré, and bright spots may also appear. Bright regions or bands may appear in some areas of the frame with flashing signs and other intermittent light sources or if the subject is briefly illuminated by a strobe or other bright, momentary light source. Avoid pointing the camera at the sun or other strong light sources. Failure to observe this precaution could result in damage to the camera's internal circuitry.



The camera can record both video and sound; do not cover the microphone during recording. Note that the built-in microphone may record lens noise during autofocus and vibration reduction.

Flash lighting can not be used during movie recording.

☑ The Count Down Display

A count down will be displayed 30 s before live view ends automatically. Depending on shooting conditions, the timer may appear immediately when movie recording begins. Note that regardless of the amount of recording time available, live view will still end automatically when the timer expires.

Viewing Movies

Press  to start playback and then scroll through pictures until a movie (indicated by a  icon) is displayed.

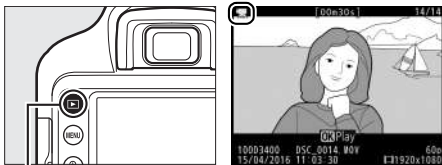





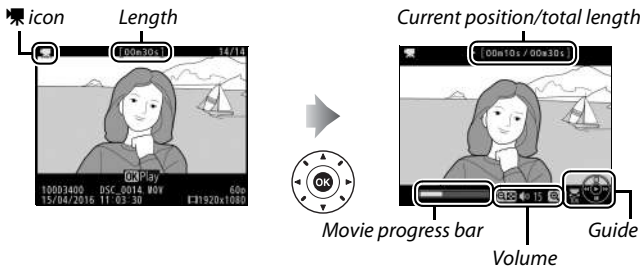









 button

Press  to start playback; your current position is indicated by the movie progress bar.



The following operations can be performed:

To	Use	Description
Pause		Pause playback.
Play		Resume playback when movie is paused or during rewind/advance.
Advance/rewind		Speed increases with each press, from 2x to 4x to 8x to 16x; keep pressed to skip to beginning or end of movie (first frame is indicated by  in top right corner of monitor, last frame by ). If playback is paused, movie rewinds or advances one frame at a time; hold for continuous rewind or advance.
Start slow-motion playback		Press  while the movie is paused to start slow-motion playback.
Skip 10 s		Rotate the command dial to skip ahead or back 10 s.
Adjust volume		Press  to increase volume,  (?) to decrease.
Return to full-frame playback		Press  or  to exit to full-frame playback.

Deleting Unwanted Movies

To delete the movie currently displayed in the monitor, press the  button. *Note that movies can not be recovered once deleted.*

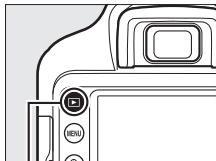

1 Display the movie.

Display the movie you wish to delete.



 button

2 Delete the movie.

Press the  button. A confirmation dialog will be displayed; press the  button again to delete the movie and return to playback.

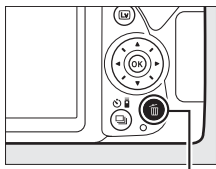

 button



Guide Mode Menus

To access these menus, highlight **Shoot**, **View/delete**, **Retouch**, or **Set up** and press **OK**.



■ Shoot

Easy operation

	Auto
	No flash
	Distant subjects
	Close-ups
	Sleeping faces
	Moving subjects
	Landscapes
	Portraits
	Night portrait
	Photograph night landscapes

Advanced operation

	Soften backgrounds	Adjust aperture.
	Bring more into focus	
	Freeze motion (people)	Select a shutter speed.
	Freeze motion (vehicles)	
	Show water flowing	
	Capture reds in sunsets*	Adjust white balance to vividly capture the colors in sunsets.
	Take bright photos*	Adjust exposure compensation to take bright (high key) or dark (low key) photos.
	Take dark (low key) photos*	

* Affects other **Advanced operation** items. To restore default settings, turn the camera off and then on again.

“Start Shooting”

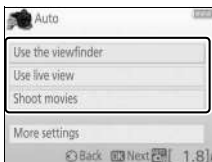

Highlight an option and press **OK**.

- Use the viewfinder
- Use live view
- Shoot movies

“More Settings”

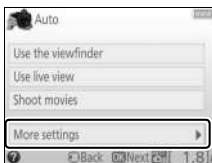

If **More settings** is displayed, you can highlight this option and press **OK** to access the following settings (the settings available vary with the shooting option selected):

- Flash settings > Flash mode
- Flash settings > Flash compensation
- Release mode
- ISO sensitivity settings > ISO sensitivity
- ISO sensitivity settings > Auto ISO sensitivity control
- Set Picture Control
- Exposure compensation
- White balance

■ View/Delete

View single photos

View multiple photos

Choose a date

View a slide show

Delete photos

■ Guide Mode

Guide mode is reset to **Easy operation > Auto** when the mode dial is rotated to another setting or the camera is turned off.

■ ■ Retouch

Trim

Filter effects (cross screen)

Filter effects (soft)

Photo illustration

Miniature effect

Selective color

■ ■ Set Up

Image quality

Image size

Auto off timers

Date stamp

Display and sound settings

Monitor brightness

Info background color

Auto info display

Beep

Movie settings

Frame size/frame rate

Movie quality

Microphone

Wind noise reduction

Flicker reduction

Playback display options

Clock and language

Format memory card

HDMI

Airplane mode

Smart device connection

Eye-Fi upload *











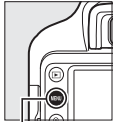







Slot empty release lock











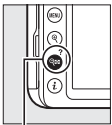

* Only available when compatible Eye-Fi memory card is inserted.

With the exceptions of **Flicker reduction**, **Clock and language**, **Format memory card**, **HDMI**, **Airplane mode**, **Smart device connection**, **Eye-Fi upload**, and **Slot empty release lock**, changes to settings apply in guide mode only and are not reflected in other shooting modes.

Using the Guide

The following operations can be performed while the guide is displayed:

To	Use	Description
Return to top level of guide	 MENU button	Press MENU to turn the monitor on or return to the top level of the guide.
Turn monitor on		
Highlight a menu		Press  ,  ,  , or  to highlight a menu.
Highlight options		Press  ,  ,  , or  to highlight options in the menus.
		Press  ,  ,  , or  to highlight options in displays like that shown below. 
Select highlighted menu or option		Press  to select the highlighted menu or option.

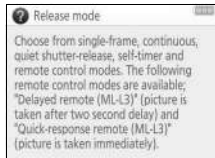
To	Use	Description
Return to previous display		Press  to return to the previous display.
		To cancel and return to the previous display from displays like that shown below, highlight  and press  .
View help	  (?) button	<p>If a  icon is displayed at the bottom left corner of the monitor, help can be displayed by pressing the  (?) button. Press  or  to scroll through the display, or press  (?) again to exit.</p>   (help) icon
		

Sports

Fast shutter speeds freeze motion for dynamic sports shots in which the main subject stands out clearly.

Note: The built-in flash and AF-assist illuminator turn off.

Close up

Use for close-up shots of flowers, insects, and other small objects (a macro lens can be used to focus at very close ranges).

Night Portrait

Use for a natural balance between the main subject and the background in portraits taken under low light.

Preventing Blur

Use a tripod to prevent blur caused by camera shake at slow shutter speeds.

Special Effects

Special effects can be used when taking photographs and shooting movies.

The following effects can be selected by rotating the mode dial to **EFFECTS** and rotating the command dial until the desired option appears in the monitor.

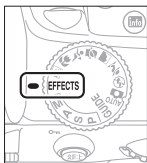

Mode dial

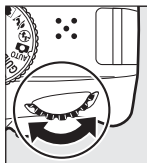

Command dial

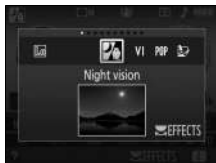

Monitor

 Night Vision

 Miniature Effect

VI Super Vivid

 Selective Color

POP Pop

 Silhouette

 Photo Illustration

 High Key

 Toy Camera Effect

 Low Key

Night Vision

Use under conditions of darkness to record monochrome images at high ISO sensitivities.

Note: Autofocus is available in live view only; manual focus can be used if the camera is unable to focus. The built-in flash and AF-assist illuminator turn off.

VI Super Vivid

Overall saturation and contrast are increased for a more vibrant image.

POP Pop

Overall saturation is increased for a more lively image.

Photo Illustration

Sharpen outlines and simplify coloring for a poster effect that can be adjusted in live view (☞ 56).

Note: Movies shot in this mode play back like a slide show made up of a series of stills.

Toy Camera Effect

Create photos and movies that appear to have been shot with a toy camera. The effect can be adjusted in live view (☞ 57).

Miniature Effect

Create photos that appear to be pictures of dioramas. Works best when shooting from a high vantage point. Miniature effect movies play back at high speed, compressing about 45 minutes of footage shot at 1920 × 1080/30p into a movie that plays back in about three minutes. The effect can be adjusted in live view (☞ 58).

Note: Sound is not recorded with movies. The built-in flash and AF-assist illuminator turn off.

Selective Color

All colors other than the selected colors are recorded in black and white. The effect can be adjusted in live view (☞ 60).

Note: The built-in flash turns off.

Silhouette

Silhouette subjects against bright backgrounds.

Note: The built-in flash turns off.

High Key

Use with bright scenes to create bright images that seem filled with light.

Note: The built-in flash turns off.

Low Key





Use with dark scenes to create dark, low-key images with prominent highlights.

Note: The built-in flash turns off.

Preventing Blur

Use a tripod to prevent blur caused by camera shake at slow shutter speeds.

NEF (RAW)

NEF (RAW) recording is not available in , VI, POP, , , , and  modes. Pictures taken when an NEF (RAW) or NEF (RAW) + JPEG fine option is selected in these modes will be recorded as JPEG images. JPEG images created at these settings will be recorded as fine-quality images.

and Modes

Autofocus is not available during movie recording. The live view refresh rate will drop, together with the frame rate for continuous release mode; using autofocus during live view photography will disrupt the preview.

Options Available in Live View

Settings for the selected effect are adjusted in the live view display.

■ ■ *Photo Illustration*

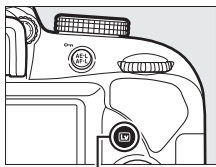

1 Select live view.

Press the  button. The view through the lens will be displayed in the monitor.





 button

2 Adjust outline thickness.

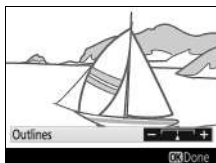
Press  to display the options shown at right. Press  or  to make outlines thicker or thinner.



3 Press .

Press  to exit when settings are complete. To exit live view, press the  button.

1 Select live view.

Press the **Lv** button. The view through the lens will be displayed in the monitor.

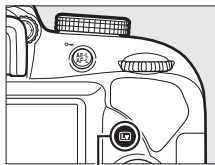

Lv button

2 Adjust options.

Press **OK** to display the options shown at right. Press **▲** or **▼** to highlight **Vividness** or **Vignetting** and press **◀** or **▶** to change. Adjust vividness to make colors more or less saturated, vignetting to control the amount of vignetting.



3 Press **OK.**

Press **OK** to exit when settings are complete. To exit live view, press the **Lv** button.

1 Select live view.

Press the **Lv** button. The view through the lens will be displayed in the monitor.

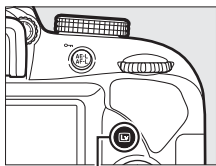

Lv button

2 Position the focus point.



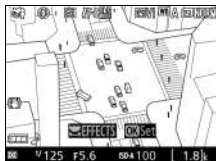

Use the multi selector to position the focus point in the area that will be in focus and then press the shutter-release button halfway to focus. To temporarily clear miniature effect options from the display and enlarge the view in the monitor for precise focus, press **Q**. Press **Q** (?) to restore the miniature effect display.

**3 Display options.**

Press **Q** to display miniature effect options.





4 Adjust options.

Press  or  to choose the orientation of the area that will be in focus and press  or  to adjust its width.



5 Press .

Press  to exit when settings are complete. To exit live view, press the  button.

1 Select live view.

Press the **Lv** button. The view through the lens will be displayed in the monitor.

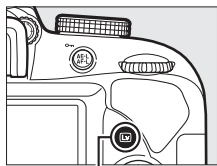

Lv button

2 Display options.

Press **⊗** to display selective color options.



**3 Select a color.**

Frame an object in the white square in the center of the display and press **⊙** to choose the color of the object as one that will remain in the final image (the camera may have difficulty detecting unsaturated colors; choose a saturated color). To zoom in on the center of the display for more precise color selection, press **⊗**. Press **⊞ (?)** to zoom out.

Selected color





4 Choose the color range.

Press  or  to increase or decrease the range of similar hues that will be included in the final image. Choose from values between 1 and 7; note that higher values may include hues from other colors.

Color range





5 Select additional colors.

To select additional colors, rotate the command dial to highlight another of the three color boxes at the top of the display and repeat Steps 3 and 4 to select another color. Repeat for a third color if desired. To deselect the highlighted color, press  (To remove all colors, press and hold . A confirmation dialog will be displayed; select **Yes**).



6 Press .

Press  to exit when settings are complete. During shooting, only objects of the selected hues will be recorded in color; all others will be recorded in black-and-white. To exit live view, press the  button.



P, S, A, and M Modes

P, **S**, **A**, and **M** modes can be selected by rotating the mode dial and offer different degrees of control over shutter speed and aperture:



	Mode	Description
P	Programmed auto (☞ 63)	Recommended for snapshots and in other situations in which there is little time to adjust camera settings. Camera sets shutter speed and aperture for optimal exposure.
S	Shutter-priority auto (☞ 63)	Use to freeze or blur motion. User chooses shutter speed; camera selects aperture for best results.
A	Aperture-priority auto (☞ 64)	Use to blur background or bring both foreground and background into focus. User chooses aperture; camera selects shutter speed for best results.
M	Manual (☞ 65)	User controls both shutter speed and aperture. Set shutter speed to “Bulb” or “Time” for long time-exposures.

Using the Built-in Flash

For flash photography, press the  () button to raise the flash.

Mode A (Aperture-Priority Auto)

In aperture-priority auto, you choose the aperture while the camera automatically selects the shutter speed that will produce the optimal exposure. Rotate the command dial left for larger apertures (lower f-numbers), right for smaller apertures (higher f-numbers).

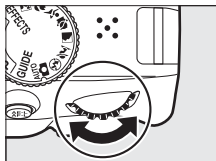

Command dial



Mode M (Manual)

In manual mode, you control both shutter speed and aperture. Checking the exposure indicator (📖 66), adjust shutter speed and aperture. Shutter speed is selected by rotating the command dial (right for faster speeds, left for slower). To adjust aperture, keep the  button pressed while rotating the command dial (left for larger apertures/lower f-numbers and right for smaller apertures/higher f-numbers).

Shutter speed

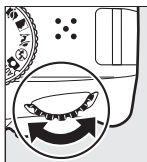

Command dial

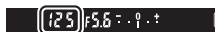

Aperture

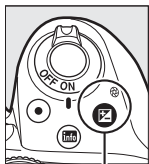

 button

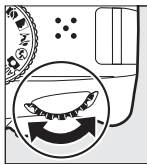

Command dial



Shutter Speed and Aperture

Shutter speed and aperture are shown in the viewfinder and information display.

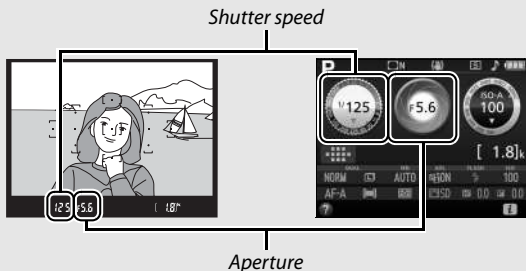

Fast shutter speeds ($1/1600$ s in this example) freeze motion.



Slow shutter speeds (here 1 s) blur motion.





Large apertures (such as $f/5.6$; remember, the lower the f -number, the larger the aperture) blur details in front of and behind the main subject.



Small apertures ($f/22$ in this case) bring both background and foreground into focus.

The Exposure Indicator

Optimal exposure	Underexposed by $1/3$ EV	Overexposed by over 2 EV
		

Exposure Compensation

In **P**, **S**, **A**, scene, and  modes, exposure compensation is used to alter exposure from the value suggested by the camera, making pictures brighter or darker (📖 96). In general, positive values make the subject brighter while negative values make it darker.



-1 EV





*No exposure
compensation*

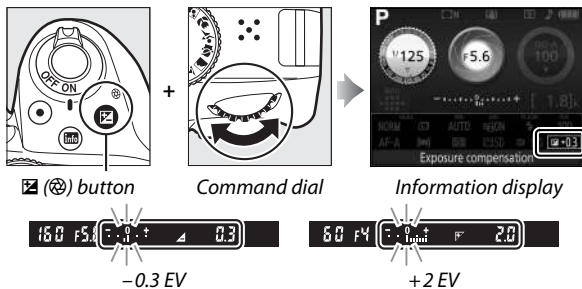

+1 EV

To choose a value for exposure compensation, keep the  button pressed and rotate the command dial until the desired value is selected in the viewfinder or information display.



Normal exposure can be restored by setting exposure compensation to ± 0 . In **P**, **S**, **A**, and **M** modes, exposure compensation is not reset when the camera is turned off. In scene and  modes, exposure compensation will be reset when another mode is selected or the camera is turned off.

The Information Display

Exposure compensation options can also be accessed from the information display ( 9).

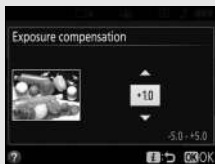

Camera Menus

Most shooting, playback, and setup options can be accessed from the camera menu. To view the menus, press the MENU button.

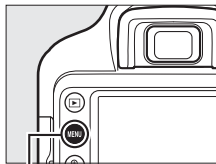

MENU button

Tabs

Choose from the following menus:

- : **Playback** (📖 70)
- : **Shooting** (📖 70)
- : **Setup** (📖 71)
- : **Retouch** (📖 72)
- : **Recent settings** (📖 72)

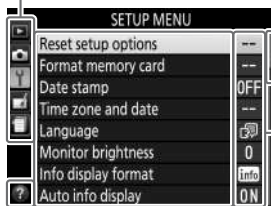

Slider shows position in current menu.

Current settings are shown by icons.

Menu options

Options in current menu.

Help icon (📖 73)

Menu Options

■ ■ ▶ *Playback Menu: Managing Images*

Delete	Rotate tall
Playback folder	Slide show
Playback display options	Rating
Image review	Select to send to smart device
Auto image rotation	

■ ■ 📷 *Shooting Menu: Shooting Options*

Reset shooting menu	Auto distortion control
Image quality	Focus mode
Image size	AF-area mode
ISO sensitivity settings	Built-in AF-assist illuminator
White balance	Metering
Set Picture Control	Flash cntrl for built-in flash/ Optional flash
Color space	Optical VR *
Active D-Lighting	Movie settings
Noise reduction	
Vignette control	

* Available only with lenses that support this item.

■ Y Setup Menu: Camera Setup

Reset setup options
Format memory card
Date stamp
Time zone and date ¹
Language ¹
Monitor brightness
Info display format
Auto info display
Auto off timers
Self-timer
Remote on duration (ML-L3)
Lock mirror up for cleaning ²
Image Dust Off ref photo
Image comment
Copyright information
Beep
Flicker reduction

Buttons
Rangefinder
Manual focus ring in AF mode ³
File number sequence
Storage folder
File naming
HDMI
Location data
Airplane mode
Connect to smart device
Send to smart device (auto)
Bluetooth
Eye-Fi upload ⁴
Conformity marking
Slot empty release lock
Reset all settings
Firmware version

1 Default varies with country of purchase.

2 Not available when battery is low.

3 Available only with lenses that support this item.

4 Only available when compatible Eye-Fi memory card is inserted.

Retouch Menu: Creating Retouched Copies

NEF (RAW) processing	Monochrome
Trim	Image overlay
Resize	Color outline
D-Lighting	Photo illustration
Quick retouch	Color sketch
Red-eye correction	Miniature effect
Straighten	Selective color
Distortion control	Painting
Perspective control	Edit movie
Fisheye	Side-by-side comparison *
Filter effects	

* Available only if retouch menu is displayed by pressing **z** and selecting **Retouch** when a retouched image or original is displayed in full-frame playback.

Recent Settings

The recent settings menu lists the twenty most recently used settings.

For More Information

Information on individual menu options is available using the camera's on-board help (☐ 73).

Using Camera Menu

The multi selector and **OK** button are used to navigate the camera menus.

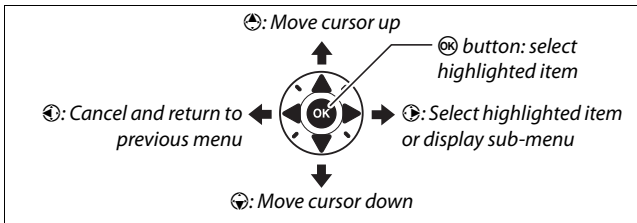

Follow the steps below to navigate the menus.

1 Display the menus.

Press the **MENU** button to display the menus.

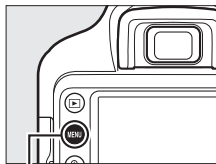

MENU button

The **?** (Help) Icon

If a **?** icon is displayed at the bottom left corner of the monitor, a description of the currently selected option or menu can be displayed by pressing the **Q** (?) button. Press **⬆️** or **⬇️** to scroll through the display. Press **Q** (?) again to return to the menu.

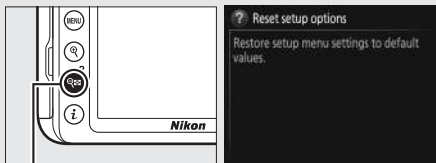

Q (?) button

2 Highlight the icon for the current menu.

Press  to highlight the icon for the current menu.



3 Select a menu.

Press  or  to select the desired menu.

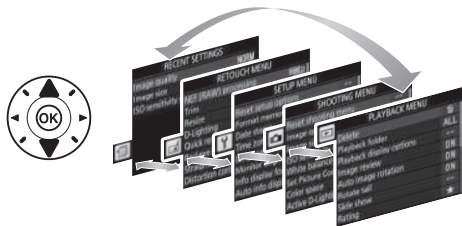

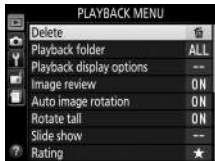

4 Position the cursor in the selected menu.

Press  to position the cursor in the selected menu.



5 Highlight a menu item.

Press  or  to highlight a menu item.

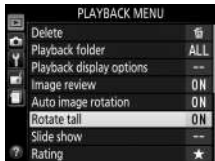

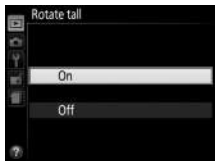

6 Display options.

Press  to display options for the selected menu item.



7 Highlight an option.

Press  or  to highlight an option.

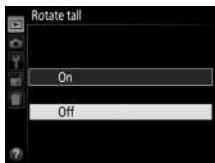





8 Select the highlighted item.

Press  to select the highlighted item. To exit without making a selection, press the MENU button.



Note the following:

- Menu items that are displayed in gray are not currently available.
- While pressing  generally has the same effect as pressing , there are some cases in which selection can only be made by pressing .
- To exit the menus and return to shooting mode, press the shutter-release button halfway ( 31).

ViewNX-i

Installing ViewNX-i

To fine-tune photos and upload and view pictures, download the latest version of the ViewNX-i installer from the following website and follow the on-screen instructions to complete installation. An Internet connection is required. For system requirements and other information, see the Nikon website for your region.

<http://downloadcenter.nikonimglib.com/>

Capture NX-D

Use Nikon's Capture NX-D software to fine-tune photos or to change settings for NEF (RAW) pictures and save them in other formats.

Capture NX-D is available for download from:

<http://downloadcenter.nikonimglib.com/>

Using ViewNX-i

Copying Pictures to the Computer

Before proceeding, be sure you have installed ViewNX-i (📖 76).

1 Connect the USB cable.

After turning the camera off and ensuring that a memory card is inserted, connect a USB cable (available separately) as shown and then turn the camera on.

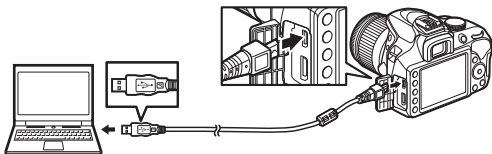

✔ USB Hubs

Connect the camera directly to the computer; do not connect the cable via a USB hub or keyboard.

✍ Use a Reliable Power Source

To ensure that data transfer is not interrupted, be sure the camera battery is fully charged.

✍ Connecting Cables

Be sure the camera is off when connecting or disconnecting interface cables. Do not use force or attempt to insert the connectors at an angle.

2 Start Nikon Transfer 2 component of ViewNX-i.

If a message is displayed prompting you to choose a program, select Nikon Transfer 2.

✔ During Transfer

Do not turn the camera off or disconnect the USB cable while transfer is in progress.

✔ Windows 7

If the following dialog is displayed, select Nikon Transfer 2 as described below.

- 1 Under **Import pictures and videos**, click **Change program**. A program selection dialog will be displayed; select Nikon Transfer 2 and click **OK**.



- 2 Double-click .

✔ Windows 10 and Windows 8.1

Windows 10 and Windows 8.1 may display an AutoPlay prompt when the camera is connected. Tap or click the dialog and then tap or click **Nikon Transfer 2** to select Nikon Transfer 2.

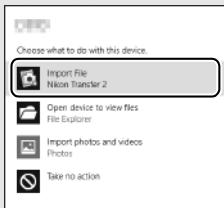
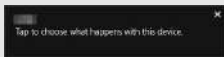

✔ OS X

If Nikon Transfer 2 does not start automatically, confirm that the camera is connected and then launch Image Capture (an application that comes with OS X) and select Nikon Transfer 2 as the application that opens when the camera is detected.

3 Click **Start Transfer**.

Pictures on the memory card will be copied to the computer.



Start Transfer

4 Terminate the connection.

When transfer is complete, turn the camera off and disconnect the USB cable.

For More Information



Consult online help for more information on using ViewNX-i.

Technical Notes

Read this chapter for information on compatible accessories, cleaning and storing the camera, and what to do if an error message is displayed or you encounter problems using the camera.

Compatible Lenses

This camera supports autofocus with AF-P and type E and G AF-S lenses only. AF-S lenses have names beginning with **AF-S** and AF-P lenses with **AF-P**; for information on determining lens type (D, E, G, or CPU), see page 81. Autofocus is not supported with other autofocus (AF) lenses. The following table lists the features available with compatible lenses in viewfinder photography:

Camera setting Lens ¹	Focus mode			Shooting mode		Metering system	
	AF	MF (with electronic rangefinder)	MF	M	Other modes		 
E type lens	✓	✓	✓	✓	✓	✓	✓ ²
Type G AF-S/AF-P NIKKOR	✓	✓	✓	✓	✓	✓	✓ ²
Type G AF NIKKOR	—	✓	✓	✓	✓	✓	✓ ²
D type lens	—	✓	✓	✓ ³	—	—	—
PC-E NIKKOR series ^{4,5}	—	✓ ⁶	✓	✓	✓	✓	✓ ²
PC Micro 85mm f/2.8D ⁷	—	✓ ⁶	✓	✓ ³	—	✓	✓ ²
Other AF NIKKOR (except lenses for F3AF)	—	✓ ⁸	✓	✓ ³	—	—	—
AI-P NIKKOR	—	✓ ⁹	✓	✓ ³	—	—	—

- 1 Assumes a combined aperture of f/5.6 or faster when AF-S teleconverter is attached.
- 2 Spot metering meters selected focus point.
- 3 Exposure indicator disabled.
- 4 The shift knob for the PC-E NIKKOR 24mm f/3.5D ED may contact the camera body when the lens is revolved.
- 5 Shifting and/or tilting the lens interferes with exposure.

- 6 Can not be used with shifting or tilting.
- 7 Optimal exposure will only be achieved if the lens is at maximum aperture and the lens is not shifted or tilted.
- 8 When AF 80–200mm f/2.8, AF 35–70mm f/2.8, AF 28–85mm f/3.5–4.5 (New), or AF 28–85mm f/3.5–4.5 lenses are zoomed all the way in at the minimum focus distance, the in-focus indicator (●) may be displayed when the image on the matte screen in the viewfinder is not in focus. Before shooting, confirm that the image in the viewfinder screen is in focus.
- 9 With maximum aperture of f/5.6 or faster.

✓ IX NIKKOR Lenses

IX NIKKOR lenses can not be used. Attempting to attach an IX NIKKOR lens could damage the lens or camera.

▣ Identifying CPU and Type G, E, and D Lenses

CPU lenses can be identified by the presence of CPU contacts, type G, E, and D lenses by a letter on the lens barrel.

CPU contacts

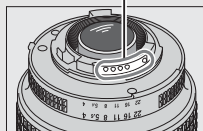

CPU lens

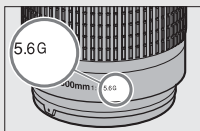

Type G or E lens

Aperture ring

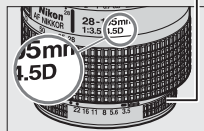

Type D lens

Other Accessories

At the time of writing, the following accessories were available for the D3400.

Power sources	<ul style="list-style-type: none">• EN-EL14a Rechargeable Li-ion Battery (☐ 10): Additional EN-EL14a batteries are available from local retailers and Nikon-authorized service representatives. EN-EL14 batteries can also be used.• MH-24 Battery Charger (☐ 10): Recharge EN-EL14a and EN-EL14 batteries.• EP-5A Power Connector, EH-5b AC Adapter: These accessories can be used to power the camera for extended periods (EH-5a and EH-5 AC adapters can also be used). A power connector EP-5A is required to connect the camera to the EH-5b, EH-5a, or EH-5.
Filters	<ul style="list-style-type: none">• Filters intended for special-effects photography may interfere with autofocus or the electronic rangefinder.• The D3400 can not be used with linear polarizing filters. Use C-PL or C-PL II circular polarizing filters instead.• NC filters are recommended for protecting the lens.• To prevent ghosting, use of a filter is not recommended when the subject is framed against a bright light, or when a bright light source is in the frame.• Center-weighted metering is recommended with filters with exposure factors (filter factors) over 1 × (Y44, Y48, Y52, O56, R60, X0, X1, C-PL, ND2S, ND4, ND4S, ND8, ND8S, ND400, A2, A12, B2, B8, B12). See the filter manual for details.

Viewfinder eyepiece accessories	<ul style="list-style-type: none"> • DK-5 Eyepiece Cap: Prevents light entering via the viewfinder from appearing in the photograph or interfering with exposure. • DK-20C Eyepiece Correction Lenses: Lenses are available with diopters of -5, -4, -3, -2, 0, $+0.5$, $+1$, $+2$, and $+3$ m^{-1} when the camera diopter adjustment control is in the neutral position (-1 m^{-1}). Use eyepiece correction lenses only if the desired focus can not be achieved with the built in diopter adjustment control (-1.7 to $+0.5$ m^{-1}). Test eyepiece correction lenses before purchase to ensure that the desired focus can be achieved. The rubber eyecup can not be used with eyepiece correction lenses. • DG-2 Magnifier: The DG-2 magnifies the scene displayed in the center of the viewfinder for greater precision during focusing. Eyepiece adapter required (available separately). • DK-22 Eyepiece Adapter: The DK-22 is used when attaching the DG-2 magnifier. • DR-6 Right-Angle Viewing Attachment: The DR-6 attaches at a right angle to the viewfinder eyepiece, allowing the image in the viewfinder to be viewed at right angles to the lens (for example, from directly above when the camera is horizontal).
Body cap	BF-1B Body Cap/BF-1A Body Cap: The body cap keeps the mirror, viewfinder screen, and image sensor free of dust when a lens is not in place.
Accessory shoe covers	BS-1 Accessory Shoe Cover: A cover protecting the accessory shoe. The accessory shoe is used for optional flash units.
USB cables	UC-E20 USB Cable (□ 77)
HDMI cables	HC-E1 HDMI Cable: An HDMI cable with a type C connector for connection to the camera and a type A connector for connection to HDMI devices.

Remote controls

ML-L3 Wireless Remote Control (□ 6): The ML-L3 uses a 3 V CR2025 battery.

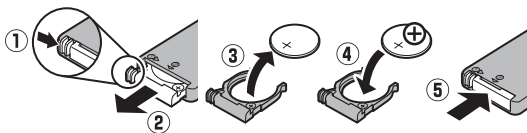

Pressing the battery-chamber latch to the right (①), insert a fingernail into the gap and open the battery chamber (②). Ensure that the battery is inserted in the correct orientation (④).

Approved Memory Cards

The camera supports SD, SDHC, and SDXC memory cards, including SDHC and SDXC cards compliant with UHS-I. Cards rated SD Speed Class 6 or better are recommended for movie recording; using slower cards may result in recording being interrupted. When choosing cards for use in card readers, be sure they are compatible with the device. Contact the manufacturer for information on features, operation, and limitations on use.



Optional Accessories

Availability may vary with country or region. See our website or brochures for the latest information.

Caring for the Camera

Storage

When the camera will not be used for an extended period, remove the battery and store it in a cool, dry area with the terminal cover in place. To prevent mold or mildew, store the camera in a dry, well-ventilated area. Do not store your camera with naphtha or camphor moth balls or in locations that:

- are poorly ventilated or subject to humidities of over 60%
- are next to equipment that produces strong electromagnetic fields, such as televisions or radios
- are exposed to temperatures above 50 °C (122 °F) or below -10 °C (14 °F)

Cleaning

Camera body	Use a blower to remove dust and lint, then wipe gently with a soft, dry cloth. After using the camera at the beach or seaside, wipe off sand or salt with a cloth lightly dampened in distilled water and dry thoroughly. Important: <i>Dust or other foreign matter inside the camera may cause damage not covered under warranty.</i>
Lens, mirror, and viewfinder	These glass elements are easily damaged. Remove dust and lint with a blower. If using an aerosol blower, keep the can vertical to prevent the discharge of liquid. To remove fingerprints and other stains, apply a small amount of lens cleaner to a soft cloth and clean with care.
Monitor	Remove dust and lint with a blower. When removing fingerprints and other stains, wipe the surface lightly with a soft cloth or chamois leather. Do not apply pressure, as this could result in damage or malfunction.

Do not use alcohol, thinner, or other volatile chemicals.

Caring for the Camera and Battery: Cautions

Do not drop: The product may malfunction if subjected to strong shocks or vibration.

Keep dry: This product is not waterproof, and may malfunction if immersed in water or exposed to high levels of humidity. Rusting of the internal mechanism can cause irreparable damage.

Avoid sudden changes in temperature: Sudden changes in temperature, such as those that occur when entering or leaving a heated building on a cold day, can cause condensation inside the device. To prevent condensation, place the device in a carrying case or plastic bag before exposing it to sudden changes in temperature.

Keep away from strong magnetic fields: Do not use or store this device in the vicinity of equipment that generates strong electromagnetic radiation or magnetic fields. Strong static charges or the magnetic fields produced by equipment such as radio transmitters could interfere with the monitor, damage data stored on the memory card, or affect the product's internal circuitry.

Do not leave the lens pointed at the sun: Do not leave the lens pointed at the sun or other strong light source for an extended period. Intense light may cause the image sensor to deteriorate or produce a white blur effect in photographs.

Turn the product off before removing or disconnecting the power source: Do not unplug the product or remove the battery while the product is on or while images are being recorded or deleted. Forcibly cutting power in these circumstances could result in loss of data or in damage to product memory or internal circuitry. To prevent an accidental interruption of power, avoid carrying the product from one location to another while the AC adapter is connected.

Cleaning: When cleaning the camera body, use a blower to gently remove dust and lint, then wipe gently with a soft, dry cloth. After using the camera at the beach or seaside, wipe off any sand or salt using a cloth lightly dampened in pure water and then dry the camera thoroughly.

The lens and mirror are easily damaged. Dust and lint should be gently removed with a blower. When using an aerosol blower, keep the can vertical to prevent discharge of liquid. To remove fingerprints and other stains from the lens, apply a small amount of lens cleaner to a soft cloth and wipe the lens carefully.

See the *Reference Manual* for information on cleaning the image sensor.

Do not touch the shutter curtain: The shutter curtain is extremely thin and easily damaged. Under no circumstances should you exert pressure on the curtain, poke it with cleaning tools, or subject it to powerful air currents from a blower. These actions could scratch, deform, or tear the curtain.

Storage: To prevent mold or mildew, store the camera in a dry, well-ventilated area. If you are using an AC adapter, unplug the adapter to prevent fire. If the product will not be used for an extended period, remove the battery to prevent leakage and store the camera in a plastic bag containing a desiccant. Do not, however, store the camera case in a plastic bag, as this may cause the material to deteriorate. Note that desiccant gradually loses its capacity to absorb moisture and should be replaced at regular intervals.

To prevent mold or mildew, take the camera out of storage at least once a month. Turn the camera on and release the shutter a few times before putting it away.

Store the battery in a cool, dry place. Replace the terminal cover before putting the battery away.

Notes on the monitor: The monitor is constructed with extremely high precision; at least 99.99% of pixels are effective, with no more than 0.01% being missing or defective. Hence while these displays may contain pixels that are always lit (white, red, blue, or green) or always off (black), this is not a malfunction and has no effect on images recorded with the device.

Images in the monitor may be difficult to see in a bright light.

Do not apply pressure to the monitor, as this could cause damage or malfunction. Dust or lint on the monitor can be removed with a blower. Stains can be removed by wiping lightly with a soft cloth or chamois leather. Should the monitor break, care should be taken to avoid injury from broken glass and to prevent liquid crystal from the monitor touching the skin or entering the eyes and mouth.

Moiré: Moiré is an interference pattern created by the interaction of an image containing a regular, repeating grid, such as the pattern of weave in cloth or windows in a building, with the camera image sensor grid. If you notice moiré in your photographs, try changing the distance to the subject, zooming in and out, or changing the angle between the subject and the camera.

Servicing the Camera and Accessories

The camera is a precision device and requires regular servicing. Nikon recommends that the camera be inspected by the original retailer or Nikon-authorized service representative once every one to two years, and that it be serviced once every three to five years (note that fees apply to these services). Frequent inspection and servicing are particularly recommended if the camera is used professionally. Any accessories regularly used with the camera, such as lenses or optional flash units, should be included when the camera is inspected or serviced.



The battery and charger: Batteries may leak or explode if improperly handled. Read and follow the warnings and cautions on pages xi–xiv of this manual. Observe the following precautions when handling batteries and chargers:





- Use only batteries approved for use in this equipment.
- Do not expose the battery to flame or excessive heat.
- Keep the battery terminals clean.
- Turn the product off before replacing the battery.
- Remove the battery from the camera or charger when not in use and replace the terminal cover. These devices draw minute amounts of charge even when off and could draw the battery down to the point that it will no longer function. If the battery will not be used for some time, insert it in the camera and run it flat before removing it and storing it in a location with an ambient temperature of 15 °C to 25 °C (59 °F to 77 °F; avoid hot or extremely cold locations). Repeat this process at least once every six months.
- Turning the camera on and off repeatedly when the battery is fully discharged will shorten battery life. Batteries that have been fully discharged must be charged before use.
- The internal temperature of the battery may rise while the battery is in use. Attempting to charge the battery while the internal temperature is elevated will impair battery performance, and the battery may not charge or charge only partially. Wait for the battery to cool before charging.
- Continuing to charge the battery after it is fully charged can impair battery performance.
- A marked drop in the time a fully charged battery retains its charge when used at room temperature indicates that it requires replacement. Purchase a new EN-EL14a battery.
- Charge the battery before use. When taking photographs on important occasions, ready a spare battery and keep it fully charged. Depending on your location, it may be difficult to purchase replacement batteries on short notice. Note that on cold days, the capacity of batteries tends to decrease. Be sure the battery is fully charged before taking photographs outside in cold weather. Keep a spare battery in a warm place and exchange the two as necessary. Once warmed, a cold battery may recover some of its charge.
- Used batteries are a valuable resource; recycle in accord with local regulations.







Error Messages







This section lists the indicators and error messages that appear in the viewfinder and monitor.

Warning Icons

A flashing  in the monitor or  in the viewfinder indicates that a warning or error message can be displayed in the monitor by pressing the  (?) button.

Indicator		Solution
Monitor	Viewfinder	
Lens not attached	 (flashes)	<ul style="list-style-type: none">• Attach compatible lens.• If lens is not type E or G, select mode M.
Before taking photos, rotate the zoom ring to extend the lens.	 (flashes)	A lens with a retractable lens barrel button is attached with the lens barrel retracted. Press the retractable lens barrel button and rotate the zoom ring to extend the lens.
Shutter release disabled. Recharge battery.	 (flashes)	Turn camera off and recharge or replace battery.
This battery cannot be used. It does not communicate properly with this camera. To use the camera safely, choose a battery designated for use in this camera.	 (flashes)	Use Nikon-approved battery.
Initialization error. Turn camera off and then on again.	 (Err) (flashes)	Turn camera off, remove and replace battery, and then turn camera on again.

Indicator		Solution
Monitor	Viewfinder	
Battery level is low. Complete operation and turn camera off immediately.	—	End cleaning and turn camera off and recharge or replace battery.
Clock not set	 (flashes)	Set camera clock.
No memory card inserted	(-E-)/  (flashes)	Turn camera off and confirm that card is correctly inserted.
Memory card is locked. Slide lock to “write” position.	 (flashes)	Memory card is locked (write protected). Slide card write-protect switch to “write” position.
This memory card cannot be used. Card may be damaged. Insert another card.	 /([Err]) (flashes)	<ul style="list-style-type: none"> • Use approved card. • Format card. If problem persists, card may be damaged. Contact Nikon-authorized service representative. • Error creating new folder. Delete files or insert new memory card. • Insert new memory card.
This card is not formatted. Format the card.	(F0r) (flashes)	Format card or turn camera off and insert new memory card.
Card is full	FuL/  (flashes)	<ul style="list-style-type: none"> • Reduce quality or size. • Delete photographs. • Insert new memory card.
—	 (flashes)	Camera can not focus using autofocus. Change composition or focus manually.

Indicator		Solution
Monitor	Viewfinder	
Subject is too bright	 (flashes)	<ul style="list-style-type: none"> • Use a lower ISO sensitivity. • Use commercial ND filter. • In mode: <ul style="list-style-type: none"> S Increase shutter speed A Choose a smaller aperture (higher f-number)  Choose another shooting mode
Subject is too dark		<ul style="list-style-type: none"> • Use a higher ISO sensitivity. • Use flash. • In mode: <ul style="list-style-type: none"> S Lower shutter speed A Choose a larger aperture (lower f-number)
No “Bulb” in S mode	 (flashes)	Change shutter speed or select mode M .
No “Time” in S mode	- - /  (flashes)	
—	 (flashes)	Flash has fired at full power. Check photo in monitor; if underexposed, adjust settings and try again.
—	  (flashes)	<ul style="list-style-type: none"> • Use the flash. • Change distance to subject, aperture, flash range, or ISO sensitivity. • Lens focal length is less than 18 mm: use a longer focal length.

Indicator		Solution
Monitor	Viewfinder	
Error. Press shutter release button again.	Err (flashes)	Release shutter. If error persists or appears frequently, consult Nikon-authorized service representative.
Start-up error. Contact a Nikon-authorized service representative.		Consult Nikon-authorized service representative.
Metering error		
Unable to start live view. Please wait for camera to cool.	—	Wait for the internal circuits to cool before resuming live view or movie recording.
Folder contains no images.	—	Folder selected for playback contains no images. Select folder containing images from Playback folder menu or insert memory card containing images.
Cannot display this file.	—	File can not be played back on camera.
Cannot select this file.	—	Images created with other devices can not be retouched.
This movie cannot be edited.	—	<ul style="list-style-type: none"> • Movies created with other devices can not be edited. • Movies must be at least two seconds long.
No image for retouching.	—	Memory card does not contain NEF (RAW) images for use with NEF (RAW) processing .
Network access not available until camera cools.	—	Turn camera off and try again after waiting for camera to cool.

Specifications



■ Nikon D3400 Digital Camera

Type	
Type	Single-lens reflex digital camera
Lens mount	Nikon F mount (with AF contacts)
Effective angle of view	Nikon DX format; focal length equivalent to approx. 1.5× that of lenses with FX format angle of view
Effective pixels	
Effective pixels	24.2 million
Image sensor	
Image sensor	23.5 × 15.6 mm CMOS sensor
Total pixels	24.72 million
Dust-reduction System	Image Dust Off reference data (Capture NX-D software required)
Storage	
Image size (pixels)	<ul style="list-style-type: none">• 6000 × 4000 (Large)• 4496 × 3000 (Medium)• 2992 × 2000 (Small)
File format	<ul style="list-style-type: none">• NEF (RAW): 12 bit, compressed• JPEG: JPEG-Baseline compliant with fine (approx. 1 : 4), normal (approx. 1 : 8), or basic (approx. 1 : 16) compression• NEF (RAW)+JPEG: Single photograph recorded in both NEF (RAW) and JPEG formats
Picture Control System	Standard, Neutral, Vivid, Monochrome, Portrait, Landscape, Flat; selected Picture Control can be modified
Media	SD (Secure Digital) and UHS-I compliant SDHC and SDXC memory cards
File system	DCF 2.0, Exif 2.3, PictBridge

Viewfinder	
Viewfinder	Eye-level pentamirror single-lens reflex viewfinder
Frame coverage	Approx. 95% horizontal and 95% vertical
Magnification	Approx. 0.85 × (50 mm f/1.4 lens at infinity, -1.0 m ⁻¹)
Eyepoint	18 mm (-1.0 m ⁻¹ ; from center surface of viewfinder eyepiece lens)
Diopter adjustment	-1.7 – +0.5 m ⁻¹
Focusing screen	Type B BriteView Clear Matte Mark VII screen
Reflex mirror	Quick return
Lens aperture	Instant return, electronically controlled
Lens	
Autofocus support	Autofocus is available with AF-P and type E and G AF-S lenses.
Shutter	
Type	Electronically-controlled vertical-travel focal-plane shutter
Speed	1/4000 – 30 s in steps of 1/3 EV; Bulb; Time
Flash sync speed	X = 1/200 s; synchronizes with shutter at 1/200 s or slower
Release	
Release mode	[S] (single frame), [C] (continuous), [Q] (quiet shutter release), [T] (self-timer), [2s] (delayed remote; ML-L3), [Q] (quick-response remote; ML-L3)
Frame advance rate	Up to 5 fps Note: Frame rates assume manual focus, manual or shutter-priority auto exposure, a shutter speed of 1/250 s or faster, and other settings at default values.
Self-timer	2 s, 5 s, 10 s, 20 s; 1–9 exposures

Exposure	
Metering	TTL exposure metering using 420-pixel RGB sensor
Metering method	<ul style="list-style-type: none"> • Matrix metering: 3D color matrix metering II (type E and G lenses) • Center-weighted metering: Weight of 75% given to 8-mm circle in center of frame • Spot metering: Meters 3.5-mm circle (about 2.5% of frame) centered on selected focus point
Range (ISO 100, f/1.4 lens, 20 °C/68 °F)	<ul style="list-style-type: none"> • Matrix or center-weighted metering: 0–20 EV • Spot metering: 2–20 EV
Exposure meter coupling	CPU
Mode	Auto modes (📷 ^{AUTO} auto; 📷 auto, flash off); programmed auto with flexible program (P); shutter-priority auto (S); aperture-priority auto (A); manual (M); scene modes (👤 portrait; 🏞️ landscape; 👦 child; 🏃 sports; 📶 close up; 🌃 night portrait); special effects modes (🌃 night vision; 🌈 super vivid; 🎈 pop; 🖼️ photo illustration; 📷 toy camera effect; 🏠 miniature effect; 🎨 selective color; 🌑 silhouette; 🏠 high key; 🌑 low key)
Exposure compensation	Can be adjusted by –5 – +5 EV in increments of 1/3 EV in P, S, A, M, scene, and 📷 modes
Exposure lock	Luminosity locked at detected value with ^{AEL} / _{AF-L} (🔒) button
ISO sensitivity (Recommended Exposure Index)	ISO 100 – 25600 in steps of 1 EV. Auto ISO sensitivity control available
Active D-Lighting	On, off

Focus	
Autofocus	Nikon Multi-CAM 1000 autofocus sensor module with TTL phase detection, 11 focus points (including one cross-type sensor), and AF-assist illuminator (range approx. 0.5–3 m/1 ft 8 in.–9 ft 10 in.)
Detection range	–1 – +19 EV (ISO 100, 20 °C/68 °F)
Lens servo	<ul style="list-style-type: none"> • Autofocus (AF): Single-servo AF (AF-S); continuous-servo AF (AF-C); auto AF-S/AF-C selection (AF-A); predictive focus tracking activated automatically according to subject status • Manual focus (MF): Electronic rangefinder can be used
Focus point	Can be selected from 11 focus points
AF-area mode	Single-point AF, dynamic-area AF, auto-area AF, 3D-tracking (11 points)
Focus lock	Focus can be locked by pressing shutter-release button halfway (single-servo AF) or by pressing <small>AE-L</small> <small>AF-L</small> (O-m) button
Flash	
Built-in flash	 : Auto flash with auto pop-up P, S, A, M: Manual pop-up with button release
Guide Number	Approx. 7/22, 8/26 with manual flash (m/ft, ISO 100, 20 °C/68 °F)
Flash control	TTL: i-TTL flash control using 420-pixel RGB sensor is available with built-in flash; i-TTL balanced fill-flash for digital SLR is used with matrix and center-weighted metering, standard i-TTL flash for digital SLR with spot metering
Flash mode	Auto, auto with red-eye reduction, auto slow sync, auto slow sync with red-eye reduction, fill-flash, red-eye reduction, slow sync, slow sync with red-eye reduction, rear-curtain with slow sync, rear-curtain sync, off

Flash	
Flash compensation	Can be adjusted by -3 – +1 EV in increments of $\frac{1}{3}$ EV in P, S, A, M , and scene modes
Flash-ready indicator	Lights when built-in flash or optional flash unit is fully charged; flashes after flash is fired at full output
Accessory shoe	ISO 518 hot-shoe with sync and data contacts and safety lock
Nikon Creative Lighting System (CLS)	Nikon CLS supported
Sync terminal	AS-15 sync terminal adapter (available separately)
White balance	
White balance	Auto, incandescent, fluorescent (7 types), direct sunlight, flash, cloudy, shade, preset manual, all except preset manual with fine-tuning
Live view	
Lens servo	<ul style="list-style-type: none"> • Autofocus (AF): Single-servo AF (AF-S); full-time-servo AF (AF-F) • Manual focus (MF)
AF-area mode	Face-priority AF, wide-area AF, normal-area AF, subject-tracking AF
Autofocus	Contrast-detect AF anywhere in frame (camera selects focus point automatically when face-priority AF or subject-tracking AF is selected)
Automatic scene selection	Available in  and  modes
Movie	
Metering	TTL exposure metering using main image sensor
Metering method	Matrix
Frame size (pixels) and frame rate	<ul style="list-style-type: none"> • 1920 × 1080; 60p (progressive), 50p, 30p, 25p, 24p • 1280 × 720; 60p, 50p Actual frame rates for 60p, 50p, 30p, 25p, and 24p are 59.94, 50, 29.97, 25, and 23.976 fps respectively; options support both ★ high and normal image quality

Movie	
File format	MOV
Video compression	H.264/MPEG-4 Advanced Video Coding
Audio recording format	Linear PCM
Audio recording device	Built-in monaural microphone; sensitivity adjustable
ISO sensitivity	ISO 100–25600
Monitor	
Monitor	7.5-cm (3-in.), approx. 921k-dot (VGA) TFT LCD with 170 ° viewing angle, approx. 100% frame coverage, and brightness adjustment
Playback	
Playback	Full-frame and thumbnail (4, 9, or 72 images or calendar) playback with playback zoom, playback zoom cropping, playback face zoom, movie playback, photo and/or movie slide shows, histogram display, highlights, photo information, location data display, auto image rotation, picture rating, and image comment (up to 36 characters)
Interface	
USB	Hi-Speed USB with Micro-USB connector; connection to built-in USB port is recommended
HDMI output	Type C HDMI connector
Bluetooth	
Communication protocols	Bluetooth Specification Version 4.1
Operating frequency	<ul style="list-style-type: none"> • Bluetooth: 2402–2480 MHz • Bluetooth Low Energy: 2402–2480 MHz
Maximum output power	8.1 dBm (EIRP)
Range (line of sight)	Approximately 10 m (32 ft) without interference; range may vary with signal strength and presence or absence of obstacles

Supported languages	
Supported languages	Arabic, Bengali, Bulgarian, Chinese (Simplified and Traditional), Czech, Danish, Dutch, English, Finnish, French, German, Greek, Hindi, Hungarian, Indonesian, Italian, Japanese, Korean, Marathi, Norwegian, Persian, Polish, Portuguese (Portugal and Brazil), Romanian, Russian, Serbian, Spanish, Swedish, Tamil, Telugu, Thai, Turkish, Ukrainian, Vietnamese
Power source	
Battery	One EN-EL14a rechargeable Li-ion battery
AC adapter	EH-5b AC adapter; requires EP-5A power connector (available separately)
Tripod socket	
Tripod socket	1/4 in. (ISO 1222)
Dimensions/weight	
Dimensions (W × H × D)	Approx. 124 × 98 × 75.5 mm (4.9 × 3.9 × 3 in.)
Weight	Approx. 445 g (15.7 oz) with battery and memory card but without body cap; approx. 395 g/14 oz (camera body only)
Operating environment	
Temperature	0 °C–40 °C (+32 °F–104 °F)
Humidity	85% or less (no condensation)

- Unless otherwise stated, all measurements are performed in conformity with Camera and Imaging Products Association (CIPA) standards or guidelines.
- All figures are for a camera with a fully-charged battery.
- The sample images displayed on the camera and the images and illustrations in the manual are for expository purposes only.
- Nikon reserves the right to change the appearance and specifications of the hardware and software described in this manual at any time and without prior notice. Nikon will not be held liable for damages that may result from any mistakes that this manual may contain.

■ ■ *MH-24 Battery Charger*

Rated input	AC 100–240 V, 50/60 Hz, 0.2 A maximum
Rated output	DC 8.4 V/0.9 A
Supported batteries	Nikon EN-EL14a rechargeable Li-ion batteries
Charging time	Approx. 1 hour and 50 minutes at an ambient temperature of 25 °C (77 °F) when no charge remains
Operating temperature	0 °C–40 °C (+32 °F–104 °F)
Dimensions (W × H × D)	Approx. 70 × 26 × 97 mm (2.8 × 1.0 × 3.8 in.), excluding plug adapter
Weight	Approx. 96 g (3.4 oz), excluding plug adapter

The symbols on this product represent the following:

~ AC, --- DC,  Class II equipment (The construction of the product is double-insulated.)

■ ■ *EN-EL14a Rechargeable Li-ion Battery*

Type	Rechargeable lithium-ion battery
Rated capacity	7.2 V/1230 mAh
Operating temperature	0 °C–40 °C (+32 °F–104 °F)
Dimensions (W × H × D)	Approx. 38 × 53 × 14 mm (1.5 × 2.1 × 0.6 in.)
Weight	Approx. 49 g (1.7 oz), excluding terminal cover

■ AF-P DX NIKKOR 18–55mm f/3.5–5.6G VR and AF-P DX NIKKOR 18–55mm f/3.5–5.6G Lenses

Type	Type G AF-P DX lens with built-in CPU and F mount
Focal length	18–55 mm
Maximum aperture	f/3.5–5.6
Lens construction	12 elements in 9 groups (2 aspherical lens elements)
Angle of view	76° – 28° 50′
Focal length scale	Graduated in millimeters (18, 24, 35, 45, 55)
Distance information	Output to camera
Zoom	Manual zoom using independent zoom ring
Focusing	Autofocus controlled by stepping motor; separate focus ring for manual focus
Vibration reduction (AF-P DX NIKKOR 18–55mm f/3.5–5.6G VR only)	Lens shift using voice coil motors (VCMs)
Minimum focus distance	0.25 m (0.9 ft) from focal plane at all zoom positions
Diaphragm blades	7 (rounded diaphragm opening)
Diaphragm	Fully automatic
Aperture range	<ul style="list-style-type: none"> • 18 mm focal length: f/3.5–22 • 55 mm focal length: f/5.6–38 The minimum aperture displayed may vary depending on the size of the exposure increment selected with the camera.
Metering	Full aperture
Filter-attachment size	55 mm (P = 0.75 mm)
Dimensions	Approx. 64.5 mm maximum diameter × 62.5 mm (distance from camera lens mount flange when lens is retracted)
Weight	<ul style="list-style-type: none"> • AF-P DX NIKKOR 18–55mm f/3.5–5.6G VR: Approx. 205 g (7.3 oz) • AF-P DX NIKKOR 18–55mm f/3.5–5.6G: Approx. 195 g (6.9 oz)

AF-P DX NIKKOR 18–55mm f/3.5–5.6G VR, AF-P DX NIKKOR 18–55mm f/3.5–5.6G

The lens generally used in this manual for illustrative purposes is the AF-P DX NIKKOR 18–55mm f/3.5–5.6G VR. AF-P DX NIKKOR 18–55mm f/3.5–5.6G VR and AF-P DX NIKKOR 18–55mm f/3.5–5.6G feature retractable lens barrels.

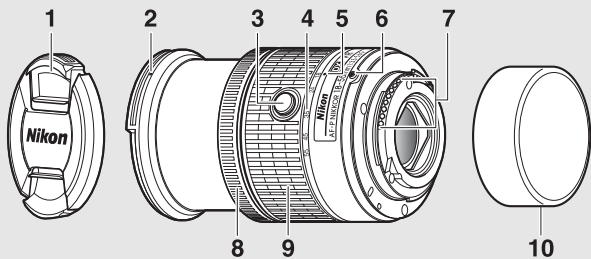

- | | |
|---|-------------------------------------|
| 1 Lens cap | 6 Lens mounting mark15 |
| 2 Lens hood mounting mark | 7 CPU contacts |
| 3 Retractable lens barrel button... 16 | 8 Focus ring |
| 4 Focal length scale | 9 Zoom ring.....29 |
| 5 Focal length mark | 10 Rear lens cap |

■ AF-P DX NIKKOR 70–300mm f/4.5–6.3G ED VR and AF-P DX NIKKOR 70–300mm f/4.5–6.3G ED Lenses

Type	Type G AF-P DX lens with built-in CPU and F mount
Focal length	70–300 mm
Maximum aperture	f/4.5–6.3
Lens construction	14 elements in 10 groups (including 1 ED lens element)
Angle of view	22° 50' – 5° 20'
Focal length scale	Graduated in millimeters (70, 100, 135, 200, 300)
Distance information	Output to camera
Zoom	Manual zoom using independent zoom ring
Focusing	Autofocus controlled by stepping motor; separate focus ring for manual focus
Vibration reduction (AF-P DX NIKKOR 70–300mm f/4.5–6.3G ED VR only)	Lens shift using voice coil motors (VCMs)
Minimum focus distance	1.1 m (3.7 ft) from focal plane at all zoom positions
Diaphragm blades	7 (rounded diaphragm opening)
Diaphragm	Fully automatic
Aperture range	<ul style="list-style-type: none"> • 70 mm focal length: f/4.5–22 • 300 mm focal length: f/6.3–32 <p>The minimum aperture displayed may vary depending on the size of the exposure increment selected with the camera.</p>
Metering	Full aperture
Filter-attachment size	58 mm (P = 0.75 mm)
Dimensions	Approx. 72 mm maximum diameter × 125 mm (distance from camera lens mount flange)
Weight	<ul style="list-style-type: none"> • AF-P DX NIKKOR 70–300mm f/4.5–6.3G ED VR: Approx. 415 g (14.7 oz) • AF-P DX NIKKOR 70–300mm f/4.5–6.3G ED: Approx. 400 g (14.2 oz)

AF-P DX NIKKOR 70–300mm f/4.5–6.3G ED VR, AF-P DX NIKKOR 70–300mm f/4.5–6.3G ED

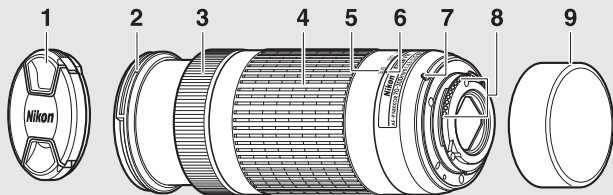

- | | |
|----------------------------------|-------------------------------------|
| 1 Lens cap | 6 Focal length mark |
| 2 Lens hood mounting mark | 7 Lens mounting mark15 |
| 3 Focus ring | 8 CPU contacts |
| 4 Zoom ring 29 | 9 Rear lens cap |
| 5 Focal length scale | |

■ AF-S DX NIKKOR 55–200mm f/4–5.6G ED VR II Lens

Type	Type G AF-S DX lens with built-in CPU and F mount
Focal length	55–200 mm
Maximum aperture	f/4–5.6
Lens construction	13 elements in 9 groups (including 1 ED lens element)
Angle of view	28° 50' – 8°
Focal length scale	Graduated in millimeters (55, 70, 85, 105, 135, 200)
Distance information	Output to camera
Zoom	Manual zoom using independent zoom ring
Focusing	Nikon Internal Focusing (IF) System with autofocus controlled by Silent Wave Motor and separate focus ring for manual focus
Vibration reduction	Lens shift using voice coil motors (VCMs)
Minimum focus distance	1.1 m (3.7 ft) from focal plane at all zoom positions
Diaphragm blades	7 (rounded diaphragm opening)
Diaphragm	Fully automatic
Aperture range	<ul style="list-style-type: none">• 55 mm focal length: f/4–22• 200 mm focal length: f/5.6–32
Metering	Full aperture
Filter-attachment size	52 mm (P = 0.75 mm)
Dimensions	Approx. 70.5 mm maximum diameter × 83 mm (distance from camera lens mount flange when lens is retracted)
Weight	Approx. 300 g (10.6 oz)

Nikon reserves the right to change the appearance and specifications of the hardware and software described in this manual at any time and without prior notice. Nikon will not be held liable for damages that may result from any mistakes that this manual may contain.

AF-S DX NIKKOR 55–200mm f/4–5.6G ED VR II

The AF-S DX NIKKOR 55–200mm f/4–5.6G ED VR II features a retractable lens barrel.

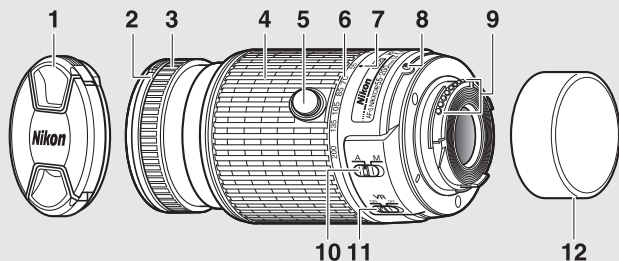

- | | |
|---|--|
| 1 Lens cap | 8 Lens mounting mark15 |
| 2 Lens hood mounting mark | 9 CPU contacts |
| 3 Focus ring | 10 A-M mode switch |
| 4 Zoom ring 29 | 11 Vibration reduction
ON/OFF switch |
| 5 Retractable lens barrel button... 16 | 12 Rear lens cap |
| 6 Focal length scale | |
| 7 Focal length mark | |

Trademark Information

IOS is a trademark or registered trademark of Cisco Systems, Inc., in the United States and/or other countries and is used under license. Windows is either a registered trademark or a trademark of Microsoft Corporation in the United States and/or other countries. Mac, OS X, Apple®, App Store®, the Apple logos, iPhone®, iPad®, and iPod touch® are trademarks of Apple Inc. registered in the U.S. and/or other countries. Android is a trademark of Google Inc. The Android robot is reproduced or modified from work created and shared by Google and used according to terms described in the Creative Commons 3.0 Attribution License. PictBridge logo is a trademark. The SD, SDHC, and SDXC logos are trademarks of the SD-3C, LLC. HDMI, the HDMI logo and High-Definition Multimedia Interface are trademarks or registered trademarks of HDMI Licensing LLC.

HDMI

The Bluetooth® word mark and logos are registered trademarks owned by Bluetooth SIG, Inc. and any use of such marks by Nikon Corporation is under license.

All other trade names mentioned in this manual or the other documentation provided with your Nikon product are trademarks or registered trademarks of their respective holders.

Use of the Made for Apple badge means that an accessory has been designed to connect specifically to the Apple products identified in the badge, and has been certified by the developer to meet Apple performance standards. Apple is not responsible for the operation of this device or its compliance with safety and regulatory standards. Please note that the use of this accessory with an Apple product may affect wireless performance.

Conformity Marking

The standards with which the camera complies can be viewed using the **Conformity marking** option in the setup menu (☐ 71).

FreeType License (FreeType2)

Portions of this software are copyright © 2012 The FreeType Project (<http://www.freetype.org>). All rights reserved.

MIT License (HarfBuzz)

Portions of this software are copyright © 2016 The HarfBuzz Project (<http://www.freedesktop.org/wiki/Software/HarfBuzz>). All rights reserved.

Certificates

Indonesia

44633/SDPPI/2016
4588

44168/SDPPI/2016
4593

México

IFETEL: RCPMUTY16-0164
TYPE1FJ

Módulo WLAN instalado adentro de esta computadora
La operación de este equipo está sujeta a las siguientes
dos condiciones:

- (1) es posible que este equipo o dispositivo no cause interferencia perjudicial y
- (2) este equipo o dispositivo debe aceptar cualquier interferencia, incluyendo la que pueda causar su operación no deseada.

Paraguay

Número del Registro: 2015-12-I-0000358

Este producto contiene un transmisor
aprobado por la CONATEL.

Brasil

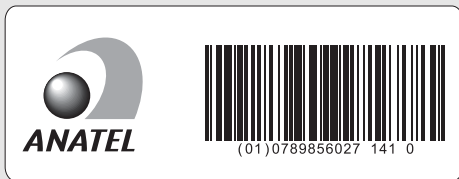

الإمارات العربية المتحدة

TRA
REGISTERED No:
ER45170/16
DEALER No:
DA39487/15

عمان

OMAN-TRA
R/3332/16
D090024

الأردن

TRC/SS/2016/230

Battery Life

The movie footage or number of shots that can be recorded with fully-charged batteries varies with the condition of the battery, temperature, the interval between shots, and the length of time menus are displayed. Sample figures for EN-EL14a (1230 mAh) batteries are given below.

- **Photographs, single-frame release mode (CIPA standard ¹):**

Approximately 1200 shots

- **Movies:** Approximately 60 minutes at 1080/60p²

- 1 Measured at 23 °C/73.4 °F (±2 °C/3.6 °F) with an AF-P DX NIKKOR 18–55mm f/3.5–5.6G VR lens under the following test conditions: lens cycled from infinity to minimum range and one photograph taken at default settings once every 30 s; after photograph is taken, monitor is turned on for 4 s; tester waits for standby timer to expire after monitor is turned off; flash fired at full power once every other shot. Live view not used.
- 2 Measured at 23°C/73.4°F (±2°C/3.6°F) with the camera at default settings and an AF-P DX NIKKOR 18–55mm f/3.5–5.6G VR lens under conditions specified by the Camera and Imaging Products Association (CIPA). Individual movies can be up to 20 minutes in length or 4 GB in size; recording may end before these limits are reached if the camera temperature rises.

The following can reduce battery life:

- Using the monitor
- Keeping the shutter-release button pressed halfway
- Repeated autofocus operations
- Taking NEF (RAW) photographs
- Slow shutter speeds
- Using camera Bluetooth features
- Using the camera with optional accessories connected
- Using VR (vibration reduction) mode with VR lenses
- Repeatedly zooming in and out with an AF-P lens.

To ensure that you get the most from rechargeable Nikon EN-EL14a batteries:

- Keep the battery contacts clean. Soiled contacts can reduce battery performance.
- Use batteries immediately after charging. Batteries will lose their charge if left unused.

No reproduction in any form of this manual, in whole or in part (except for brief quotation in critical articles or reviews), may be made without written authorization from NIKON CORPORATION.

NIKON CORPORATION

Printed in Thailand

© 2016 Nikon Corporation



6MB35611-04