

DIGITAL CAMERA D1

Nikon
DIGITAL CAMERA D1
User's Manual



Nikon

Getting to Know the D1

Parts of the D1

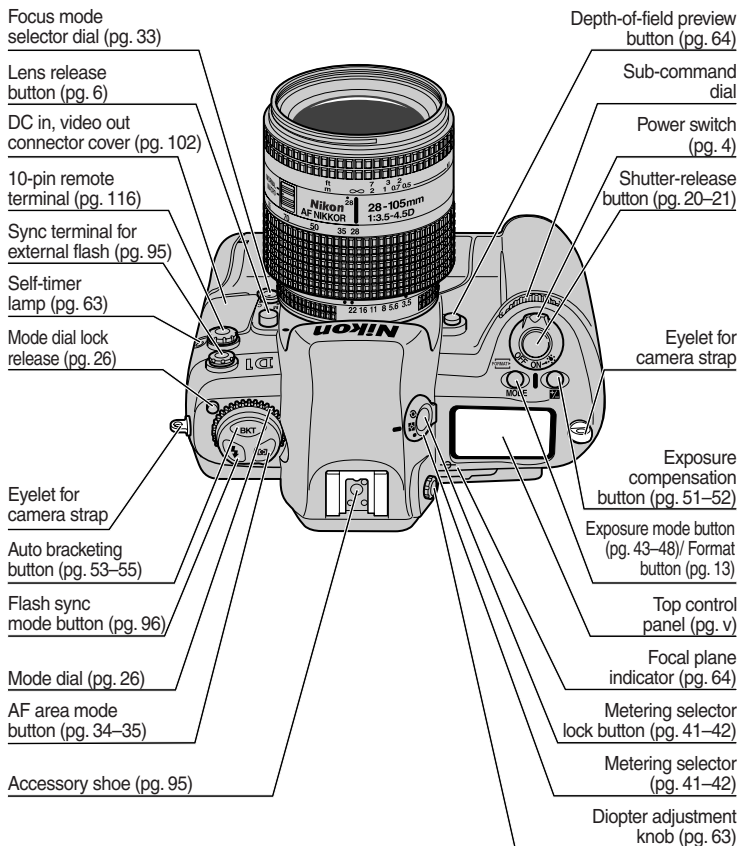

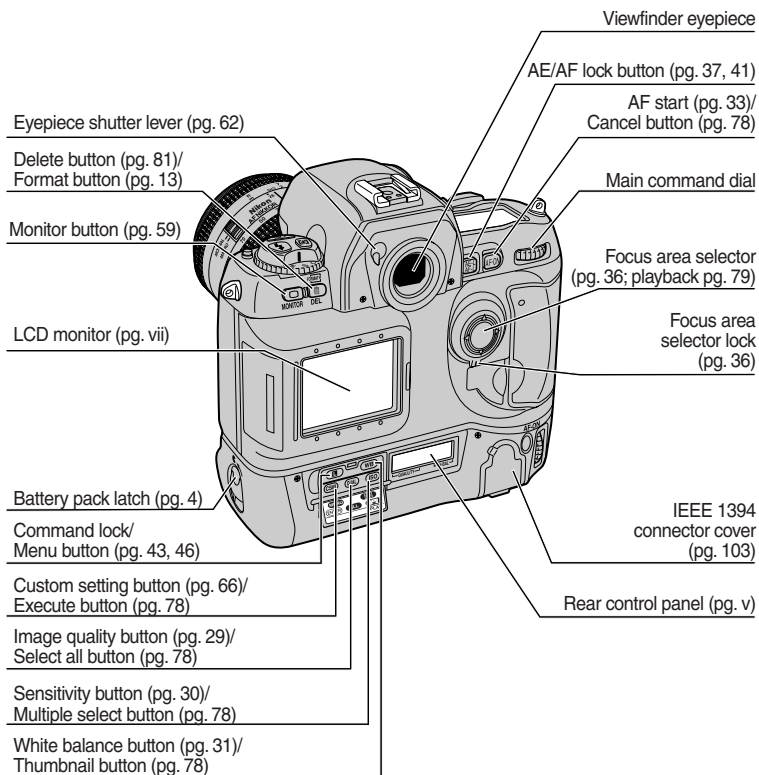

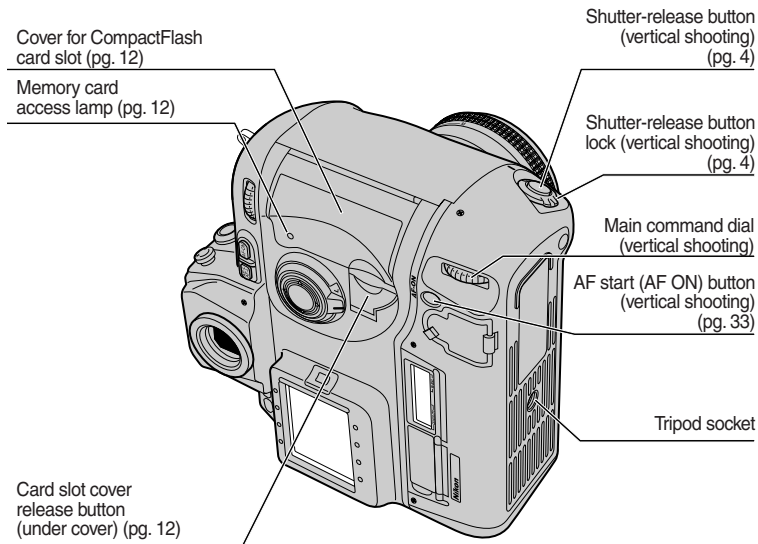

Accessories



Body cap
BF-1A



Cover for
LCD monitor

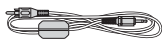

Video cable
EG-D1

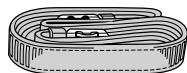

Camera strap
AN-D1

Top Control Panel

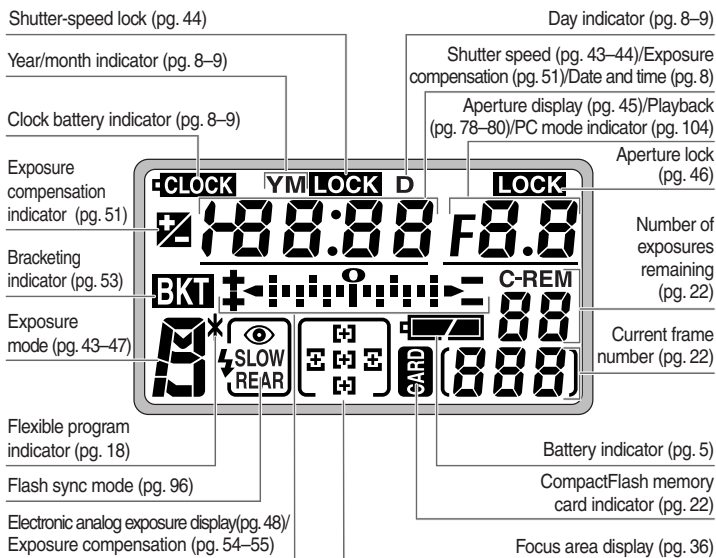

Rear Control Panel

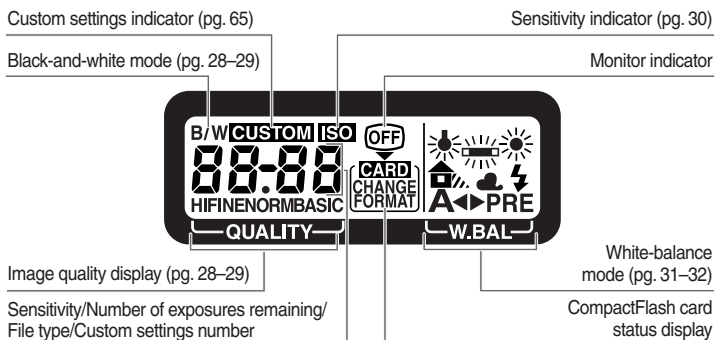

Viewfinder Display

12mm (0.47") reference circle for center-weighted metering (pg. 41)

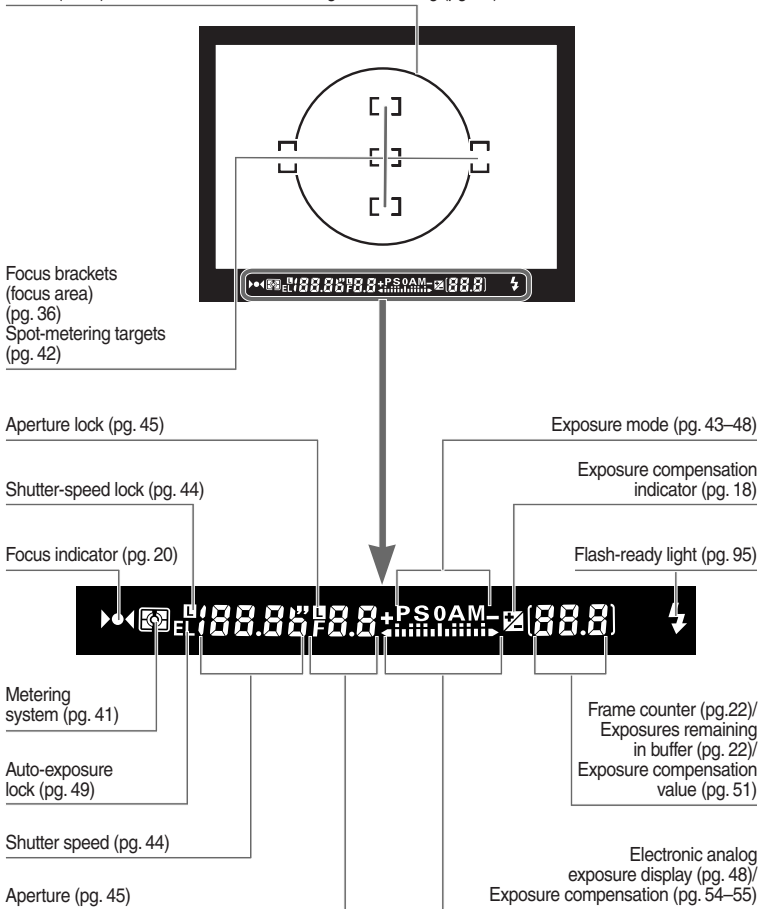

LCD Monitor



1 Frame number

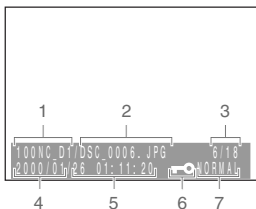

1 Folder name

2 Filename

3 Frame number

4 Date of recording

5 Time of recording

6 Protected file

7 Image quality

Note

The LCD monitor and control panels may darken or turn black at high temperatures. The displays will return to normal when the temperature drops. At low temperatures, the response time of the LCD control panels may drop, but response time will return to normal when the temperature rises.

Caring for the Camera and Battery

Do not drop

The camera and lens may malfunction if subjected to strong shocks or vibration.

Keep dry

This product is not waterproof, and may malfunction if immersed in water or exposed to high levels of humidity. Rusting of the internal mechanism can cause irreparable damage.

Avoid sudden changes in temperature

Sudden changes in temperature, such as occur when entering or leaving a heated building on a cold day, can cause condensation inside the device. To prevent condensation, place the device in its carrying case or a plastic bag before exposing it to sudden changes in temperature.

Keep away from strong magnetic fields

Do not use or store this device in the vicinity of equipment that produces strong electromagnetic radiation or magnetic fields. Strong static charges or the magnetic fields produced by equipment such as radio transmitters could interfere with the color LCD monitor, damage data stored on the flash memory card, or affect the product's internal circuitry.

Do not touch shutter curtain

The shutter curtain is made of extremely thin material and is easily damaged. Under no circumstances should you exert pressure on the curtain, poke it with cleaning tools or other implements, or subject it to strong air currents from a blower. Any of these actions could scratch, deform, or tear the curtain.

Cleaning

- When cleaning the camera body, use a blower to remove dust and lint, then wipe gently with a soft, dry cloth. After using your camera at the beach or seaside, wipe off any sand or salt using a cloth lightly dampened with pure water and then dry your camera thoroughly. In rare instances,

static electricity produced by a brush or cloth may cause the LCD displays to light up or darken. This does not indicate a malfunction, and the display will shortly return to normal.

- When cleaning the lens and mirror, remember that these elements are easily damaged. Dust and lint should be gently removed with a blower. When using an aerosol blower, keep the can vertical (tilting the can could result in liquid being sprayed on the mirror). If you do get a fingerprint or other stain on the lens, apply a small amount of lens cleaner to a soft cloth and wipe the lens carefully.
- See "Technical Notes: Cleaning the CCD" for information on cleaning the CCD.

Storage

- To prevent mold or mildew, store the equipment in a dry, well-ventilated area. Do not store it with naphtha or camphor moth balls, close to equipment that produces strong magnetic fields, or in areas subject to high temperatures, for example near a kerosene heater or in a car on a hot day.
- When leaving the product unattended for a long period of time, remove the battery to prevent leakage and store the camera in a plastic bag containing desiccant. Do not however store the camera case in a plastic bag, as this may cause the material to deteriorate. Note also that desiccant loses its ability to absorb moisture after a period of time, and should be replaced at regular intervals.
- To prevent mold or mildew, take the camera out at least once a month to turn it on and release the shutter a few times.
- Store the battery in a cool, dry place.

Color LCD monitor

- The monitor may contain a few pixels that are always lit or that do not light. This is a characteristic common to all TFT LCD monitors and does not indicate a malfunction. Images recorded with the camera will not be affected.
- Images in the monitor may be difficult to see in a bright light.
- The monitor is lit by a fluorescent backlight. Should the monitor begin to dim or flicker, contact your Nikon service representative.
- Do not apply pressure to the LCD monitor, as this could cause damage or malfunction. Dust or lint adhering to the monitor can be removed with a blower brush. Stains can be removed by rubbing the surface lightly with a soft cloth or chamois leather.
- Should the monitor break, care should be taken to avoid injury due to broken glass and to prevent the liquid crystal from the monitor touching the skin or entering the eyes or mouth.
- Replace the monitor cover when transporting the camera or leaving it unattended.

Attaching the monitor cover

Holding the camera firmly in your right hand, place the monitor cover so that the left side is positioned for attachment. Once the left side is correctly in place, push the right side towards the monitor until it “clicks” into place.

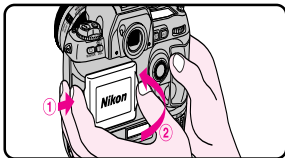

Removing the monitor cover

Holding the camera firmly in your right hand, lightly press the left side of the cover to the right, loosening the lock on the right side. Once the right side is loosened, detach the right side of the cover first, followed by the left side.

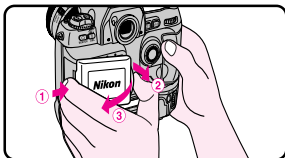

Turn camera off before removing battery or unplugging AC adapter

Do not unplug the product or remove the battery while the camera is on, or while images are being recorded or deleted from memory. Forcibly cutting power to the product in these circumstances could result in loss of data or in damage to internal circuitry or memory. To prevent an accidental interruption of power, avoid carrying the product with you while the AC adapter is connected.

Observe proper precautions when handling batteries

Batteries may leak or explode if improperly handled. Observe the following precautions when handling batteries for use in this product:

- Be sure the product is off before inserting or removing the battery. If you are using the AC adapter, be sure it is unplugged.
- Foreign matter on the battery terminals—for example, sweat or oil—may prevent a contact from being formed. Before installing the battery, clean it thoroughly with a soft, dry cloth.
- When the product is used continuously on battery power for an extended period, the battery may become hot. Due caution should be observed when removing the battery.
- Use only batteries approved for use in this equipment.
- Do not expose the battery to flame or to excessive heat or moisture. Do not short-circuit or disassemble the battery.

Spare batteries

- Keep a spare battery fully charged when taking photographs on important occasions. Depending on your location, you may find it difficult to purchase replacement batteries on short notice.
- On cold days, the capacity of the battery tends to decrease. Be sure the battery is fully charged before taking photographs outside in cold weather. Keep a spare battery in a warm place and exchange the two as necessary. Once warmed, a cold battery may recover some of its charge.

Notice for customers in the U.S.A.

Federal Communications Commission (FCC) Radio Frequency Interference Statement

This equipment has been tested and found to comply with the limits for a Class B digital device, pursuant to Part 15 of the FCC Rules. These limits are designed to provide reasonable protection against harmful interference in a residential installation. This equipment generates, uses, and can radiate radio frequency energy and, if not installed and used in accordance with the instructions, may cause harmful interference to radio communications. However, there is no guarantee that interference will not occur in a particular installation. If this equipment does cause harmful interference to radio or television reception, which can be determined by turning the equipment off and on, the user is encouraged to try to correct the interference by one or more of the following measures:

- Reorient or relocate the receiving antenna.
- Increase the separation between the equipment and receiver.
- Connect the equipment into an outlet on a circuit different from that to which the receiver is connected.
- Consult the dealer or an experienced radio/television technician for help.

CAUTIONS

Modifications

The FCC requires the user to be notified that any changes or modifications made to this device that are not expressly approved by Nikon Corporation may void the user's authority to operate the equipment.

Interface Cables

Use the interface cables sold or provided by Nikon for your equipment. Using other interface cables may exceed the limits of Class B Part 15 of the FCC rules.

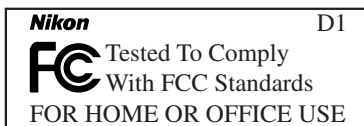

Notice for customers in Canada

CAUTION

This class B digital apparatus meets all requirements of the Canadian Interference Causing Equipment Regulations.

ATTENTION

Cet appareil numérique de la classe B respecte toutes les exigences du Règlement sur le matériel brouilleur du Canada.

Notices

- Reproduction, in whole or in part, of any of the manuals provided with your Nikon product requires prior permission from Nikon.
- The information contained in this manual is subject to change without notice.
- While Nikon makes every effort to produce perfect manuals, we appreciate any opportunity for improvement. Should you find any mistakes, we would be grateful if you were to kindly let us know. The address of Nikon's representative in your area is provided separately.
- Nikon does not accept liability for damages resulting from the use of this product.

Notice Concerning Prohibition of Copying or Reproduction

Note that simply being in possession of material that has been digitally copied or reproduced by means of a scanner, digital camera, or other device may be punishable by law.

• **Items prohibited by law from being copied or reproduced**

Do not copy or reproduce paper money, coins, securities, government bonds, or local government bonds, even if such copies or reproductions are stamped "Sample".

The copying or reproduction of paper money, coins, or securities which are circulated in a foreign country is prohibited.

Unless the prior permission of the government has been obtained, the copying or reproduction of unused postage stamps or post cards issued by the government is prohibited.

The copying or reproduction of stamps issued by a government or of certified documents stipulated by law is prohibited.

• **Cautions on certain copies and reproductions**

The government has issued cautions on copies or reproductions of securities issued by private companies (shares, bills, checks, gift certificates, etc.), commuter passes, or coupon tickets, except when a minimum of necessary copies are to be provided for business use by a company. Also, do not copy or reproduce passports issued by the government, licenses issued by public agencies and private groups, ID cards, and tickets, such as passes and meal coupons.

• **Comply with copyright notices**

The copying or reproduction of copyrighted creative works such as books, music, paintings, woodcut prints, maps, drawings, movies, and photographs is prohibited except when it is done for personal use at home or for similar restricted and non-commercial use.

Trademark Information

Apple and Macintosh are registered trademarks of Apple Computer, Inc.

Microsoft and Windows are registered trademarks of Microsoft Corporation.

CompactFlash is a trademark of SanDisk Corporation.

All other trade names mentioned in this manual or the other documentation provided with your Nikon product are trademarks or registered trademarks of their respective holders.

Contents

Getting to Know the D1	ii
Caring for the Camera and Battery	viii
About This Manual	1
First Steps	3
1 Insert the Battery	4
2 Attach the Lens	6
3 Set the Time and Date	8
4 Choose a Language for the Menus	10
5 Insert the Memory Card	12
6 Take a Photograph	14
6.1 Set the advance mode to S (single frame)	14
6.2 Set image quality to NORM (normal)	14
6.3 Set sensitivity to ISO 200 equivalent	15
6.4 Set white balance to A (auto)	15
6.5 Set the focus mode to S (single servo AF)	16
6.6 Set the AF area mode to single area AF	16
6.7 Select the center focus area	17
6.8 Select matrix metering	17
6.9 Set the exposure mode to programmed auto	18
6.10 Ready the camera	19
6.11 Half-press the shutter release button	20
6.12 Check the indicators in the viewfinder	20
6.13 Take a photograph	21
7 Play the Photograph Back	23
Camera Settings	25
The Mode Dial	26
Image Quality	28
Sensitivity (ISO Equivalency)	30
White Balance	31
Autofocus	33
AF Area Mode	34
Focus Area	36
Focus Lock	37
Getting Good Results with Autofocus	39
Manual Focus	40
Metering	41
Exposure Mode	43
Auto-Exposure Lock	49

Exposure Compensation	51
Auto Bracketing	53
Capture Preview Mode	56
Record-and-Review	58
Playing Photographs Back	60
Self Timer Mode	62
Diopter Adjustment	63
LCD Illuminator	63
Depth-of-Field Preview	64
Focal Plane Position	64
Custom Settings	65
Changing Custom Settings	66
Custom Settings Options	67
Quick Guide to Custom Settings Options	74
Two-Button Reset	76
Playback	77
Playing Photographs Back	78
The Playback Menu	82
Flash Photography	93
Through-the-Lens Flash Photography	94
Flash Sync Modes	96
Compatible Speedlights	98
Using a Speedlight	100
Connections	101
Connecting to a Television or VCR	102
Connecting to a Computer	103
Reading Photographs from Memory Cards	105
Technical Notes	107
Replacing the Focusing Screen	108
Compatible Lenses	109
Cleaning the CCD	112
Optional Accessories	114
Troubleshooting	118
Specifications	123
Exposure Program (Programmed Auto)	127
Index	128

ABOUT THIS MANUAL

Thank you for your purchase of a Nikon D1 digital camera. This chapter describes the basic layout of this manual.

This manual is divided into seven main chapters:

First Steps

Outlines the steps you will take when using your camera for the first time, from installing the batteries to taking photographs at basic settings.

Camera Settings

Details the advanced settings of your camera.

Custom Settings

Describes the options available in the camera's custom settings menu.

Playback

Details how to play back and delete images recorded with your camera.

Flash Photography

Lists the flash options available for the D1.

Connections

Describes how to connect your camera to a computer or television.

Technical Notes

Lists the accessories available for your camera, describes how to care for the camera's CCD, and provides troubleshooting tips.

Tip

When taking photographs on important occasions, take a few trial shots to confirm that the camera is functioning properly. Whenever you are in doubt about how a photograph will turn out, you can take a trial shot and play it back in the camera's LCD monitor.

FIRST STEPS

This chapter covers the steps you will take when using your camera for the first time, from inserting the battery to taking your first photograph. It describes the most commonly used settings for D-Type autofocus (AF) Nikkor lenses, as shown below.

Lens	D-Type AF Nikkor lens
Sensitivity	ISO 200 equivalent
Operating mode	Single-frame shooting (S)
Image quality	Normal
White balance	Auto
Focus mode	Single-servo autofocus (AF-S)
AF area mode	Single area AF
Focus area	Center
Metering	3D color matrix metering
Exposure mode	Programmed auto (P)

1 Insert the Battery

Insert the battery and check the battery indicator.

1.1 Charge the battery

The D1 uses rechargeable EN-4 Ni-MH battery packs (available separately). Be sure the battery is fully charged before inserting it in the camera.

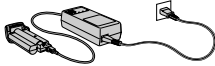

Batteries can be charged in about 90 minutes using the MH-16 Quick Charger (available separately). See the documentation provided with the MH-16 for details. More information about batteries can be found in “Technical Notes: Optional Accessories.”

1.2 Insert the battery in the camera

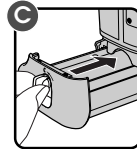
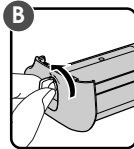
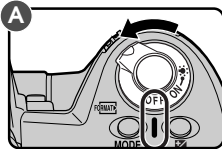

Be sure the camera is off before inserting or removing the battery pack (A). Turn the battery pack latch to the open position (B) and insert the battery in the camera (C).

Tip

The EN-4 rechargeable battery pack can also be recharged using the MH-15 Quick Charger for the F100 film camera or the EH-3 Quick Charger for the E3/E3s digital cameras.

1.3 Turn the battery pack latch to the locked position

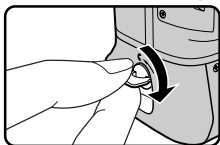

1.4 Check the battery indicator

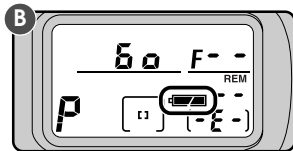
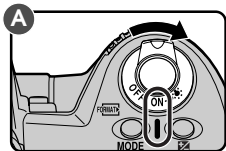

Turn the camera on (A) and confirm the battery level in the control panel on top of the camera (B).

 **Battery fully charged**

 **Low battery**

Ready a fully-charged spare battery. (The display in the viewfinder turns off to save power when no operations are being performed.)

 **Battery exhausted**

No photographs can be taken until the battery has been replaced.

All indicators in the viewfinder and rear control panel, and all indicators in the top control panel other than the exposure mode, battery indicator, and exposure counter, disappear six seconds after the camera is turned on (automatic meter switch-off).

Tip

Reactivating the display

Lightly press (half-press) the shutter-release button to reactivate the display in the control panel and viewfinder. Indicators will be displayed for six seconds after you remove your finger from the button. Note that when using the shutter-release button for vertical shooting, you will need to set the shutter-release button lock release for vertical shooting to the unlocked position.

 The length of time before automatic meter switch-off can be changed using custom settings (see “Custom Settings,” item 15).

2 Attach the Lens

After making sure that the camera is off, mount the lens and set the aperture to its minimum setting (largest f-number).

2.1 Attach the lens to the camera body

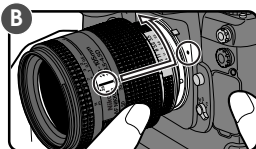
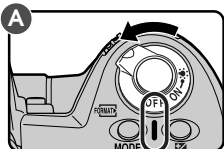

Turn the camera off (A). Align the mounting mark on the lens with the mounting mark on the camera body, then, being careful not to touch the lens-release button, turn the lens counter-clockwise until it locks into place (B).

If no lens is attached, or if a non-CPU lens is attached (see “Technical Notes: Compatible Lenses”), **F--** will appear in the top control panel and viewfinder when the camera is turned on (if the exposure mode is set to programmed auto or shutter-priority auto, the exposure mode indicator will also blink).

2.2 Set aperture to its minimum setting

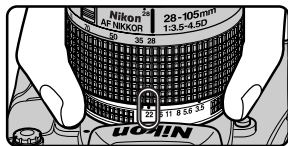

Set the lens to minimum aperture (maximum f-number).

If the lens is not set to the minimum aperture, a blinking **FEE** indicator will appear in the viewfinder and in the control panel on top of the camera when the camera is turned on. The shutter can not be released while this indicator is displayed.

Tip

To get the most from your camera, use a D-Type AF Nikkor lens (see “Technical Notes: Compatible Lenses” for more information).

2.3 Lock the aperture ring



If you do not intend to set aperture manually using the lens aperture ring, lock the lens aperture (the aperture ring can not be used unless changes have been made to default settings as described in “Custom Settings,” item 22).

Detaching the lens

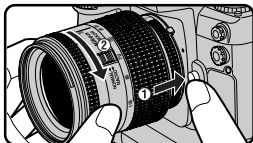

Before detaching the lens, turn the camera off. Then turn the lens clockwise while holding down the lens-release button.

When no lens is attached...

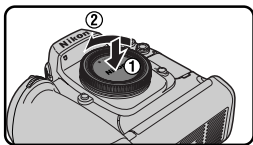

If the camera's lens mount is not covered, dust may find its way onto the mirror or viewfinder screen. This can be prevented by attaching the BF-1A body cap to the camera when no lens is in place (note that the BF-1 body cap can not be used with the D1).

Note

When attaching or detaching the lens or body cap, be careful that dirt or other foreign matter does not enter the camera body. The presence of foreign matter inside the camera could affect your photographs. When changing lenses or replacing the body cap, hold the camera with the base down or tilted so that the lens mount faces the ground. Be sure to replace the body cap when no lens is in place.

3 Set the Time and Date

The D1 records the time and date for each photograph taken. Before using your camera, set the internal clock-calendar to the current time and date.

3.1 Check the time and date in the control panel

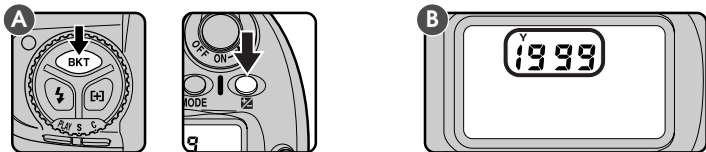

After turning the camera on, press the auto-bracketing button (**BKT**) and exposure compensation button (☒) simultaneously. The year indicator will be displayed in the control panel on top of the camera (B). Press the exposure-compensation button (☒) once to display the month and day, a second time to display the hour and minute. Pressing the button a third time will clear the time and date from the display).

Note

The clock-calendar is powered by an independent battery with a life of about ten years. When no charge remains, the clock-battery replacement indicator will appear in the control panel on top of the camera. Take the camera to a Nikon-authorized service center, where the clock battery can be replaced for a fee.

3.2 Set the time and date

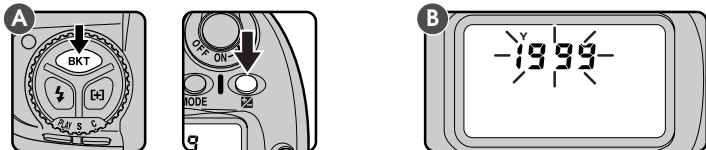

To set the time and date, turn the camera on and hold the auto-bracketing button down for more than two seconds while pressing the exposure compensation button (A). The year indicator in the control panel on top of the camera will flash (B). Set the year using the main command dial. Pressing the exposure-compensation button will cause the month, day, hour, and minute to be displayed in turn; the item currently displayed can be set using the main command dial. Press the exposure compensation button when the minute is displayed to clear the time and date from the display, putting any changes into effect (the display disappears automatically, cancelling changes to settings, if no operations are performed for three minutes).

Note

The time/date display is cleared from the control panel when the shutter-release button is pressed half way. Changes to the time and date will not be saved.

4 Choose a Language for the Menus

Camera menus and messages can be displayed in English, German, French, or Japanese. To select the language used:

4.1 Display the playback menu

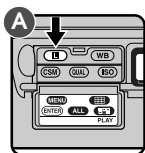
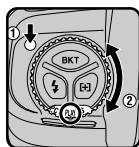

Holding the mode dial lock-release down, turn the mode dial to PLAY (playback mode). Turn the camera on and press the **L** button (A) to display the playback menu (B).

4.2 Choose SET UP from the playback menu

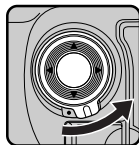

Unlock the focus-area selector and press ▼ until SET UP is highlighted. Press the focus-area selector to the right to display the SET UP menu.

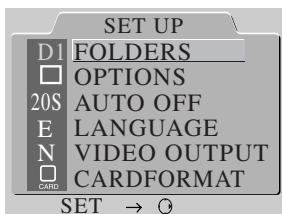
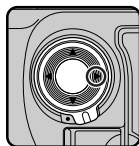

4.3 Choose a language from the LANGUAGE menu

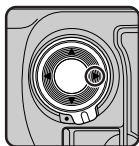
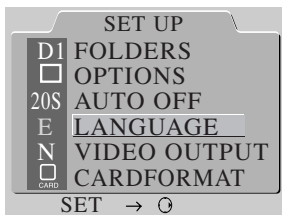
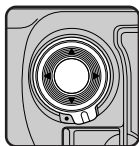

Using the focus-area selector, highlight LANGUAGE and press the selector to the right to display the LANGUAGE menu. Highlight the desired language and press the focus-area selector to the right (or press the **CSM** button) to put your choice into effect.

5 Insert the Memory Card

The D1 digital camera uses compact flash-memory cards to record photographs and other information. Before taking photographs, you will need to insert a memory card in the camera's card slot.

5.1 Open the card slot

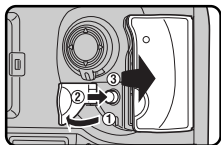

After making sure the camera is off, open the door covering the card-slot cover release button (1) and press the card-slot cover release button (2) to open the card slot (3).

5.2 Insert the memory card, fold the eject button over, and close the cover

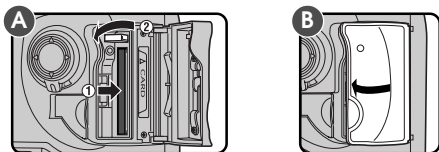

Insert the memory card in the slot (A), being sure that the card terminals are fully inserted in the connector at the back of the slot. The card should be inserted facing the ▲CARD label next to the card slot.

✓ **Important:** *Do not attempt to insert the card upside down or backwards. Do not use force when inserting the card. Either action could damage your camera.*

Fold the eject button over and close the cover (B). If the button is not folded over when the cover is closed, closing the door may partially eject the card, causing errors in recording photographs or during playback.

Note

The following CompactFlash memory cards have been tested and approved for use in the D1:

- Nikon EC-CF CompactFlash memory cards
 - SanDisk Corporation SDCFB-4/8/15/30/40/48/64/96 CompactFlash memory cards
- Operation is not guaranteed with other cards. IBM microdrive cards are not supported.

Removing memory cards

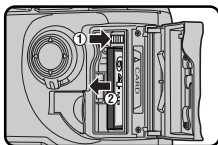
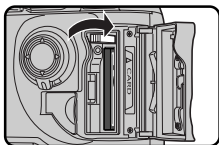

When removing memory cards, turn the camera off and open the card-slot cover. After confirming that the access lamp is off, stand the eject button up and press it down to eject the card. *Do not attempt to remove the card while the access lamp is on.* Doing so could result in loss of data or in damage to the camera or the card.

✓ **Important:** *The compact flash card may become hot while in use. Observe due caution when removing memory cards from the camera.*

Formatting memory cards

Memory cards must be formatted before they can be used to record photographs. When formatting memory cards, first make sure the camera is on, then hold the **FORMAT** buttons down simultaneously for two seconds. A blinking FOR indicator will appear in the top control panel. To format the memory card, press the two buttons again.

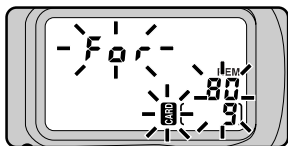
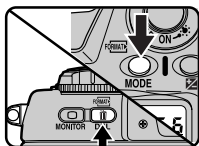

✓ **Note:** *Formatting memory cards permanently erases any data they may contain. Before formatting the card, be sure to make copies of data you would like to keep.*

When the card is formatted, the frame-number display in the control panel on top of the camera will show **1**, and the number of exposures remaining will appear in both control panels (when a hundred or more exposures remain, the control panels will show **FL**).

6 Take a Photograph

This section describes how to take a photograph using the most commonly-used settings.

6.1 Set the advance mode to S (single frame)

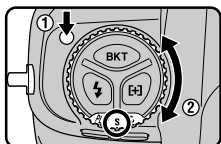

Hold the mode dial lock-release down and turn the mode dial to S (single frame). See “Camera Settings: The Mode Dial” for more information.

6.2 Set image quality to NORM (normal)

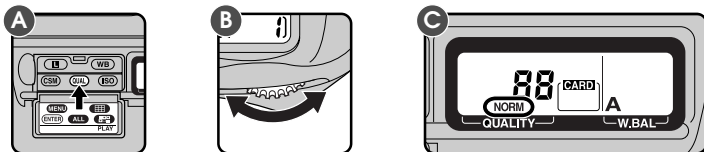

After turning the camera on, hold the **QUAL** button down (A) and turn the main command dial (B). The image-quality display in the rear control panel (C) will cycle through the image-quality settings as shown below. Stop when the display shows NORM (normal).

HI — FINE — NORM — BASIC

See “Camera Settings: Image Quality” for more information.

6.3 Set sensitivity to ISO 200 equivalent

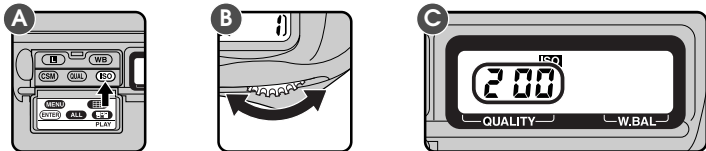

Hold the **ISO** button down (A) and turn the main command dial (B). The sensitivity display in the rear control panel will cycle through the sensitivity settings as shown below. Stop when the display shows 200 (ISO 200 equivalent).

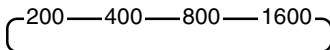

See “Camera Settings: Sensitivity” for more information.

6.4 Set white balance to A (auto)

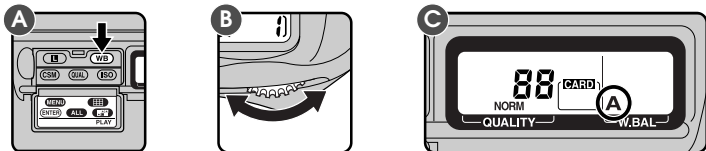

Hold the **WB** button down (A) and turn the main command dial (B). The white-balance display in the rear control panel will cycle through the white-balance settings as shown below. Stop when the display shows A (auto white balance).

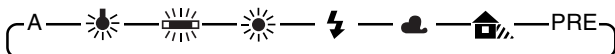

See “Camera Settings: White Balance” for more information.

6.5 Set the focus mode to S (single servo AF)

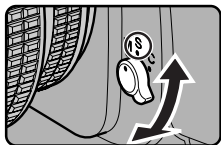

Turn the focus mode selector until it clicks into place pointing to S (single servo AF). For more information on focus settings, see “Camera Settings.”

6.6 Set the AF area mode to single area AF

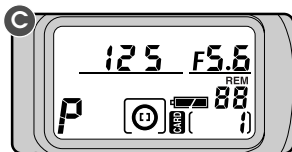
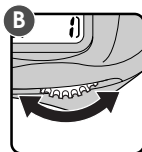
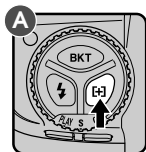

Hold down the AF area mode button (A) and turn the main command dial (B). Stop when [] (single area AF) appears in the control panel on top of the camera (C). AF area mode is detailed in “Camera Settings: AF Area Mode.”

Autofocus

In autofocus (AF) mode, the camera focuses automatically when the shutter-release button is pressed half way, or when the AF start button is pressed. Two autofocus modes are available: S (single-servo AF) and C (continuous AF). In single-servo AF, the shutter can only be released when the camera is in focus.

Do not use the focus ring when autofocus is in effect.

CSM Autofocus can be set to start only when the AF start button is pressed (see “Custom Settings,” item 4).

6.7 Select the center focus area

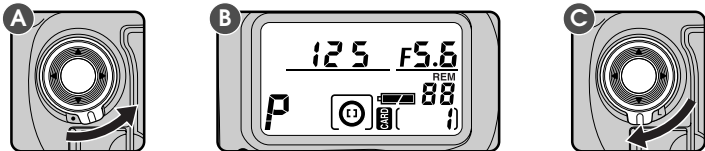

Unlock the focus area selector (A) and push the focus-area selector up, down, left, and right until the focus area display in the control panel on top of the camera shows center focus (B).

The focus area can only be selected while the focus area display is shown in the control panel. To activate the focus area display, half-press the shutter-release button.

After selecting the focus area, lock the focus area selector (C).

More information on focus area can be found in “Camera Settings: Focus Area.”

6.8 Select matrix metering

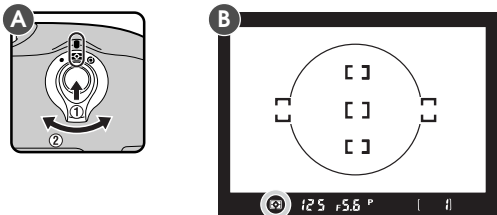

Hold down the metering selector lock release and turn the metering selector to  (matrix metering). The matrix metering indicator will appear in the viewfinder (B).

Metering

The D1 offers three metering modes: matrix, center-weighted, and spot (see “Camera Settings: Metering” for details). In matrix mode 3D color metering is used, which sets exposure based on a variety of data from all areas of the frame provided by a CCD sensor with 1005 (67 vertical \times 15 horizontal) metering pixels. This system is particularly effective with brightly-colored (white or yellow) or dark-colored (black or dark green) subjects that occupy a substantial portion of the frame, producing photographs closer to what is seen by the naked eye. 3D color metering can however only be used with D-Type lenses. When another type of lens is in place, the system used is color matrix metering, which does not take distance information from the lens into account.

6.9 Set the exposure mode to programmed auto

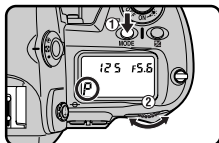

Hold the MODE button down and turn the main command dial until the exposure-mode indicator in control panel on top of the camera shows **P** (programmed auto). When the shutter-release button is half-pressed, aperture and shutter-speed will be shown in the control panel.

Flexible program

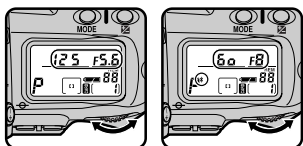

When the exposure mode is set to programmed auto, the main command dial can be rotated to select new combinations of aperture and shutter speed. This makes it possible to approximate the effects of aperture-priority auto or shutter-priority auto in programmed mode. While flexible program is in effect, an asterisk will appear next to the exposure mode indicator (**P**) in the top control panel. Flexible program can be cancelled by: rotating the command dial until the asterisk disappears, changing the exposure mode, turning the power off, or performing a two-button reset (see “Custom Settings: Two-Button Reset”).

Exposure mode

The D1 offers a choice of four exposure modes: programmed auto, shutter-priority auto, aperture-priority auto, and manual. In programmed auto, the camera automatically adjusts exposure to produce the best results, as shown in “Technical Notes: Exposure Program (Programmed Auto).” Use this mode in combination with flexible program, exposure compensation (see “Camera Settings: Exposure Compensation”), or auto bracketing (see “Camera Settings: Auto Bracketing”) for programmed photography that is at once sophisticated and simple. Other exposure modes can be selected according to your subject and shooting conditions, allowing you to adjust depth of field, or blur or freeze moving objects. See “Camera Settings: Exposure Mode” for details.

When a non-CPU lens is in use, the exposure mode will automatically be set to **A** (aperture-priority auto; see “Camera Settings: Exposure Mode”). The exposure-mode indicator in the control panel on top of the camera will show a flashing **P**, the exposure-mode indicator in the viewfinder, **A**. The aperture display in the control panel and viewfinder will show **F--**. Aperture must be set manually using the aperture ring on the lens.

6.10 Ready the camera



Hold the camera as shown above, with your elbow propped lightly against your body for support. Hold the hand-grip with your right hand and cradle the camera or lens with your left. The shutter-release button for portrait photographs can be used when the camera is in vertical shooting mode (B).

The recommended stance for taking photographs is with one foot a half pace in front of the other and your upper body in a stable position.

Camera shake and shutter speed

To prevent blurring caused by camera shake, the shutter speed should be faster than the inverse of the focal length of the lens, in seconds (for example, if the lens has a focal length of 50mm, shutter speed should be faster than $1/50$ sec.). Use of a tripod is recommended when shooting at lower shutter speeds.

6.11 Half-press the shutter release button

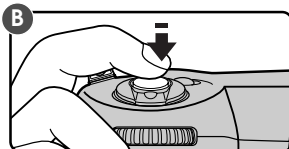

Center the focus brackets on your subject (A) and lightly press the shutter-release button half way (B). The camera will adjust focus automatically, and the results of the autofocus operation will appear in the viewfinder.

- The subject is in focus.
 - ▶ The camera is focused on an area between the camera and the subject.
 - ◀ The camera is focused on an area behind the subject.
 - ▶ ◀ The camera is unable to focus using autofocus. See “Camera Settings: Autofocus” for instructions.

To focus on a subject that will not be in the center of the final composition, change the focus area (see “Camera Settings: Focus Area”) or use focus lock (see “Camera Settings: Focus Lock”).

6.12 Check the indicators in the viewfinder

With the shutter-button held half way, check the indicators in the viewfinder. By default, aperture and shutter speed are displayed in the smallest possible increments (see “Custom Settings,” item 2, for information on changing the size of the increments used for displaying aperture, shutter speed, and exposure compensation).

If the subject is too bright or too dark, one of the following indicators will appear in the viewfinder or the control panel on top of the camera.

- HI** Subject is too bright. Use a Neutral Density (ND) filter.
- Lo** Subject is too dark. Use a flash.

Note

The viewfinder shows approximately 96% of the image actually exposed on the CCD. The area that appears in the final photograph will be slightly larger than the scene viewed through the viewfinder.

6.13 Take a photograph

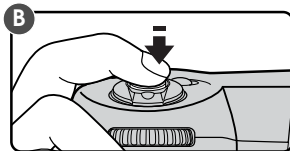

With the shutter-release button held halfway down, check the focus indicator in the viewfinder one final time (A) to confirm that the ● indicator is showing and the camera is in focus (if your subject has moved since the photograph was composed, autofocus will automatically track the subject so that it stays in focus). Then carefully press the shutter-release button the rest of the way to take a photograph (B).

By default, the photograph will automatically be recorded on the compact flash-memory card when the shutter-release button is pressed all the way down. You can, however, set the camera to “capture-preview mode” to preview the photograph in the viewfinder before it is recorded on the memory card. See “Camera Settings: Capture Preview Mode.”

Notes

If the subject in the viewfinder appears to be out of focus even when the in-focus indicator (●) appears in the viewfinder, adjust viewfinder diopter as described in “Camera Settings: Diopter Adjustment.”

Avoid taking photographs with the camera focused on the sun or another strong light source, as excessive light may cause deterioration in the camera’s charge-coupled device (CCD). It may also produce a white blur effect in the final photograph.

The D1 is equipped with a combined electronic (CCD) and mechanical shutter. This shutter operates differently from the mechanical shutters found in film cameras, with the result that the interval between the sound made by the shutter and that made by the mirror will not decrease past a certain point, even at high shutter speeds.

When the number of exposures remaining reaches 0

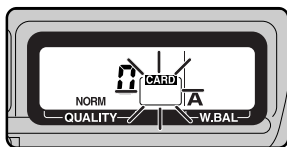
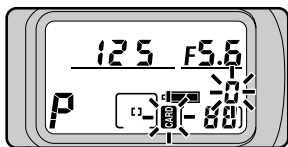

When there is not enough memory available on the compact flash-memory card to store further photographs at current settings, the number of exposures remaining will show zero and the Cd (card) indicator in the viewfinder and the CARD indicators in the control panels will flash. In this case you will need to delete photographs (see "Playback") or insert another memory card (see "Insert the Memory Card" in this chapter) before more photographs can be taken.

Note

The frame number shown in the control panel on top of the camera corresponds to the number of photographs in the current folder. When a new folder is created, the current frame number will return to 1. New folders are created when:

- the number of photographs in the current folder reaches the maximum of 999
- a file number of 999 is reached in sequential numbering mode (see "Custom Settings," item 29)
- you create a new folder using the NEW option in the FOLDERS menu (see "Playback: The Playback Menu")



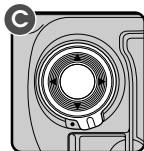
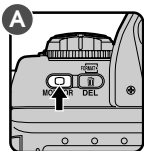

7 Play the Photograph Back

Photographs taken with the D1 can be played back on the camera's LCD monitor. If desired, photographs can also be deleted.

7.1 Turn the monitor on





Press the  button to turn the monitor on (A). The most recently taken photograph will be displayed (B).

Other photographs in memory, if any, can be viewed by pressing the focus area selector (C). Press  to view photographs taken before the photo currently displayed, or  to view photographs taken after the current photograph. Pressing  when you reach the oldest photograph will display the most recent photograph in memory; when the most recent photo is displayed, press  to view the oldest photograph in memory. If the card contains no photographs, the message “CARD CONTAINS NO PHOTOGRAPHS” will be displayed.

For more information on playback, see “Playback.”

Tip

In playback mode, the monitor will turn off automatically to save power if no operations are performed for a specified period of time. The length of time before the monitor turns off can be set using custom settings (see “Custom Settings,” item 18) or the auto-off menu (see “Playback”).



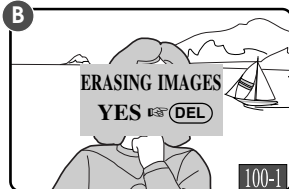
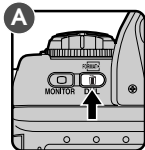

After the monitor has turned off, the display can be restored by pressing the  button before automatic meter switch-off (see “Custom Settings,” item 15). Pressing the  button after this time will display the most recent photograph in memory.

7.2 Delete a photograph

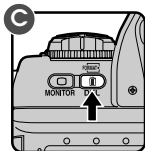

To delete the photograph currently displayed in the LCD monitor, press the  button (A). A confirmation dialog will be displayed (B).



Press the  button again (C) to delete the photograph and return to single image playback, where the next photograph in memory will be displayed. To return to playback without deleting the photograph, press any of the buttons on the rear of the camera except the  and  buttons. Press the  button or lightly press the shutter-release button to end playback without deleting the photograph.

For more information on deleting photographs, see “Playback.”

CAMERA SETTINGS

This chapter details most of the camera settings you will use when taking photographs. Information on custom settings, playback, and flash photography are provided in separate chapters.

The Mode Dial

The mode dial is used to set the camera operating mode. The D1 can be operated in single-frame or continuous shooting modes, self-timer mode, playback mode, and PC mode.

To set the operating mode, hold the mode dial lock button down and turn the mode dial to the desired setting.

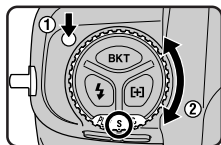

The following operating modes are available:

- S Single-frame shooting:** One photograph is taken each time the shutter-release button is pressed. The next photograph can not be taken until the current photograph has been recorded to the flash memory card and the card access lamp has gone out.
- C Continuous shooting:** Photographs are taken at a maximum rate of 4.5 frames per second while the shutter-release button is held down. Photographs are stored in a temporary memory buffer, which can hold a maximum of twenty-one photographs. When this limit is reached, the camera will be unable to record more photographs until at least one of the images in the buffer has been transferred to the memory card.

Note

The frame advance rate quoted above for continuous shooting mode is the average obtained at a temperature of 20°C (68°F) using continuous servo AF, manual exposure mode, a shutter speed faster than $\frac{1}{250}$ sec., and an aperture other than the maximum aperture.

Should the D1's battery become exhausted while you are photographing in continuous shooting mode, the camera will stop shooting, save images held in the temporary memory buffer to the memory card, and turn off.

CSM The advance rate for continuous shooting can be changed using custom settings (see "Custom Settings," item 25). You can also set the size of the memory buffer to any value between one and twenty-one frames ("Custom Settings," item 26).

While photos are being transferred from the buffer to the memory card, you will only be able to take as many photographs as have already been transferred from the buffer to the card. When the shutter-release button is pressed half way, the number of consecutive photographs that can be taken before the buffer fills up is displayed in the viewfinder and the control panel on top of the camera (see above).

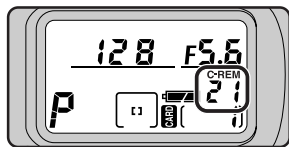

- ☺ **Self timer:** This mode is ideal for photographs in which the photographer wishes to appear (see “Self Timer Mode” in this chapter).
- PLAY **Playback mode:** In this mode, photographs can be played back on the LCD monitor (see “Playback”).
- PC **PC mode:** This mode is used when the camera is connected to a computer (see “Connections”).

✓ **Important:** *When taking photographs in continuous shooting mode, do not turn the camera off until all photographs in the buffer have been transferred to the memory card. Doing so could result in loss of data. Similarly, do not remove the memory card or battery from the camera or disconnect the AC Adapter while images are being transferred from the buffer to the card. Doing so could result in loss of data or in damage to the camera or the card. Be sure the camera is off and the access lamp has gone out before removing the memory card.*

The time duration for writing to the CompactFlash card will vary depending on the card speed and content of your images. The following chart shows typical writing time in each recording mode, but the actual time may vary slightly.

Image Quality	One image shot	21 continuous image shots
BASIC	2 seconds	25 seconds
NORMAL	2.5 seconds	45 seconds
FINE	5 seconds	95 seconds
HI (RGB)	30 seconds	10 minutes 30 seconds
HI (YCbCr)	20 seconds	7 minutes
HI (RAW)	15 seconds	2 minutes 30 seconds*

*Except for RAW files, the bit depth is 8 bit. RAW, uncompressed files are recorded at a bit depth of 12, and saved in 16-bit format. Therefore, the time shown is for 10 images, as the file space required is about twice that of other file types.

Image Quality

The image quality setting controls the image type (color or black-and-white), file type (RGB TIFF, YCbCr TIFF, RAW data, or JPEG), and compression ratio.

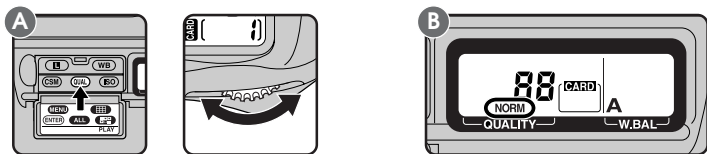

To choose the compression ratio, turn the main command dial while holding down the **QUAL** button (A). Image quality settings are displayed in the rear control panel (B) in the order shown below.



- HI High image quality, no compression:** Images are not compressed when saved. Images can be stored as TIFF files (RGB and YCbCr) or RAW data.
- FINE Fine image quality, low compression:** Images are JPEG-compressed at a compression ratio of 1:4.
- NORM Normal image quality, medium compression:** Images are JPEG-compressed at a compression ratio of 1:8.
- BASIC Basic image quality, high compression:** Images are JPEG-compressed at a compression ratio of 1:16.

RAW, YCbCr

RAW data format

Raw 12-bit data from the CCD are saved directly to the memory card. This file type can only be read using *Nikon Capture* software available separately from Nikon. The RAW data format is only available when “RAW data format available” is selected using Custom Setting 28 (see “Custom Settings”).

YCbCr format

Models color data using measures of luminance (Y) and chrominance (Cb, Cr). This file type can be read using *Nikon View DX* or *Nikon Capture* software.

To choose between black-and-white and color photography, or to select the file type used at an image quality of HI, hold down the **QUAL** button and turn the sub-command dial to cycle through the settings as shown below.

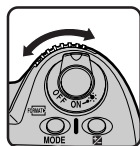
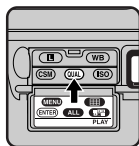

- HI** YCbCr TIFF ➔ YCbCr TIFF (B&W) ➔ RGB TIFF
 ➔ RGB TIFF (B&W) ➔ RAW ➔ YCbCr TIFF
- FINE** FINE ➔ FINE (B&W) ➔ FINE
- NORM** NORM ➔ NORM (B&W) ➔ NORM
- BASIC** BASIC ➔ BASIC (B&W) ➔ BASIC

When black-and-white is chosen, the rear control panel shows **B/W**. RAW and TIFF formats are displayed in the rear control panel as shown below.



RAW



YCbCr TIFF



RGB TIFF

The approximate number of images that can be saved on 96 and 64 MB Nikon memory cards in each format are shown below.

Format and file size	Approx. number of frames (96 MB card)	Approx. number of frames (64 MB card)
HI (RAW, approx. 4 MB)	23	15
HI (YCbCr TIFF, approx. 5.2 MB)	18	12
HI (RGB TIFF, approx. 7.8 MB)	12	8
FINE (approx. 1.3 MB)	66	44
NORM (approx. 650 KB)	132	88
BASIC (approx. 320 KB)	265	177

Note

File size for black-and-white and color images is identical.

Sensitivity (ISO Equivalency)

Sensitivity can be set higher than the default setting (ISO 200 equivalent) when taking photographs in low light conditions. Four settings (ISO 200, 400, 800, and 1,600 equivalent) are available.

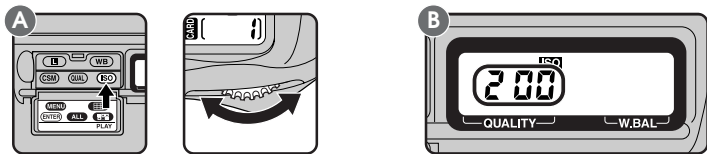

To choose a sensitivity setting, turn the main command dial while holding down the **ISO** button (A). Sensitivity settings are displayed in the rear control panel (B) in the order shown below:

200 — 400 — 800 — 1600

To confirm the current sensitivity setting, press the **ISO** button. The current setting for sensitivity will be displayed in the rear control panel.

Notes

The default setting of ISO 200 equivalent is recommended in most circumstances. Photographs taken at other settings may include a slight amount of noise.

CSM Sensitivity can be further increased by a factor of +1 or +2 over ISO 1600, making fast shutter speeds possible when lighting is poor (see “Custom Settings,” item 31). Note that in this case photographs may display higher levels of noise. It is recommended that you take a trial photograph and check the results before shooting in this mode.

At a setting of +1, the sensitivity display in the rear control panel shows **HI-1**; at a setting of +2, **HI-2** is shown.





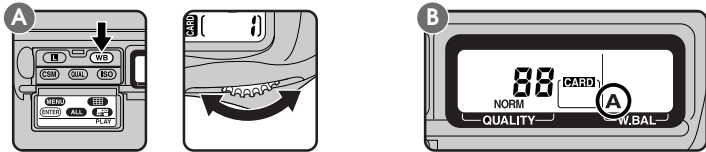

White Balance

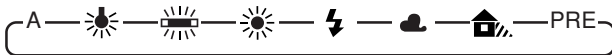
The human eye is able to adapt to changes in lighting, and consequently to humans a white object will still look white whether viewed in sunlight or under overcast skies, or indoors under incandescent or fluorescent lighting. A digital camera, in contrast, must adjust colors according to the lighting in order that colors that appear white when viewed directly appear white in the final photograph. This adjustment is called “white balance.”



To set white balance, turn the main command dial while holding down the **WB** button (A). White balance settings are displayed in the rear control panel (B) as follows:



- A Auto white balance:** The 1005-pixel CCD adjusts white balance automatically for light sources with color temperatures between approximately 4200K and approximately 7000K.
-  **Incandescent:** Use this setting when taking photographs indoors under incandescent light. Color temperature is fixed at approximately 3000K.
-  **Fluorescent:** Use this setting when taking photographs indoors under fluorescent light. Color temperature is fixed at approximately 4200K.
-  **Direct sunlight:** Use this setting when taking photographs in direct sunlight. Color temperature is fixed at approximately 5200K (daylight).
-  **Flash:** Use this setting with Nikon Speedlights. Color temperature is fixed at approximately 5400K.
-  **Overcast:** Use this setting when taking photographs under overcast skies. Color temperature is fixed at approximately 6000K (daylight).
-  **Shade:** Use this setting when taking photographs in the shade in sunny weather. Color temperature is fixed at approximately 7000K (daylight).
- PRE Preset white balance:** White balance can be set using a white object as a reference point.

Tip

While auto white balance is suited to most lighting conditions, other settings can be used when you want to fix white balance to a value suited to a particular light source.

The D1 uses through-the-lens (TTL) metering to set white balance in auto and preset modes. This allows white balance to be set accurately when the subject is lit differently from the camera.

Using preset white balance

Preset white balance is useful when taking photographs under colored lighting. To set white balance:

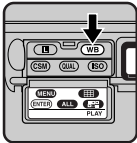
- 1 Light a white object with the same lighting that will be used in the final photograph.
- 2 Select a white balance of PRE as described on the previous page, then hold the **WB** button down for 2 seconds. The PRE indicator in the rear control panel will flash.The diagram shows the camera's rear control panel with a black arrow pointing to the 'WB' button. Other buttons labeled include 'L', 'CSM', 'GULL', 'ISO', 'MENU', 'DISP', 'M.FOCUS', and 'PLAY'.
- 3 Using manual focus (see “Manual Focus,” below) and auto exposure (exposure mode **P**, **S**, or **A**), focus the camera on the white object and press the shutter-release button. Note that the desired results may not be obtained if the image is extremely over- or under-exposed.

At a white balance adjustment setting of PRE, the camera remembers the value for white calculated the last time the setting was used and adjusts white balance based on that information. To correctly measure white balance under entirely different lighting, you must measure white balance several times to get a proper reading for white. For example, if you take a photo under red lighting using the PRE setting to adjust white balance so that white appears white, the camera retains that information. If you then take a picture under blue lighting, you will have to measure white balance several times to completely replace the information stored in the camera.

Note

Color temperature

The perceived color of a light source varies with the viewer and other conditions. Color temperature is an objective measure of the color of a light source, defined with reference to the temperature to which an object would have to be heated to radiate light in the same wavelengths. While light sources with a color temperature in the neighborhood of 5,000–5,500°K appear to be white, light sources with a lower color temperature, such as incandescent light bulbs, appear to be slightly yellow or red. Light sources with a higher color temperature seem to be tinged with blue.

Manual white-balance adjustment

Fine adjustments can be made manually to fixed white balance settings.



To adjust white balance, select a white balance other than PRE. Then, holding down the **WB** button, turn the sub-command dial to raise or lower the white balance setting by ± 3 in increments of 1 (A). Raising white balance adjustment makes your images appear bluer; lowering the adjustment makes images appear more yellow or red. At settings other than 0, a \blacktriangleleft \blacktriangleright indicator will appear in the rear control panel (B).

Autofocus

When the focus-mode selector (A) is set to S (single servo AF) or C (continuous servo AF), the camera focuses automatically when the shutter-release button is half-pressed (B), or the  button is held down (see below).

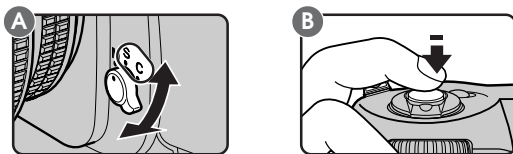



- S Single servo AF** (focus priority): When the subject is at rest, the camera focuses when the shutter-release button is pressed half way. Focus remains locked as long as the shutter-release button is held in this position (focus lock). If the subject was moving when the shutter-release button was pressed half way, the camera will focus continuously as long as the subject continues to move and the shutter-release button is kept lightly pressed (focus tracking). Focus will lock when the subject comes to a halt. The shutter can only be released when the in-focus indicator (●) appears in the viewfinder (focus priority).
- C Continuous servo AF** (release priority): The camera focuses continuously as long as the shutter-release button is held half way down, and focus will automatically track moving subjects (focus tracking). The shutter can be released even when the in-focus indicator (●) is not displayed in the viewfinder (release priority).

Tip

CSM You can set the camera to perform an autofocus operation only when the  button or AF-ON button is pressed. See “Custom Settings,” item 4.

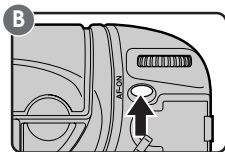
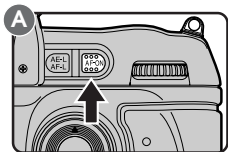
The “AF start” buttons



An alternative means of activating the autofocus operation is to press the  button (A) or, when the shutter-release button lock for vertical shooting is disabled, the AF-ON button (B). Both buttons perform the same function as pressing the shutter-release button half way.

AF Area Mode

Autofocus can be set to focus only on the selected focus area (single area AF) or to shift focus from one area to the next depending on the movement of the subject (dynamic AF). By default, when dynamic AF is used in combination with continuous servo AF, the camera first focuses on the subject in the selected focus area and then shifts the focus area to keep this subject in focus. In single servo AF, the camera first focuses on the object closest to the camera and then shifts the focus area to track the subject as it moves (closest subject priority). The defaults for dynamic AF can be changed using custom settings.

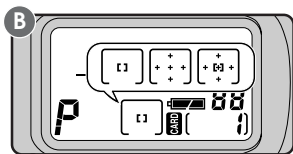
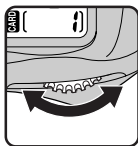
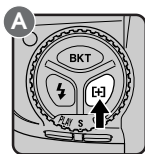



Tip

CSM By default, closest subject priority is used when single servo AF is combined with dynamic AF, and is not used when continuous servo AF is in effect. Custom Setting 9 can be used to turn closest subject priority off when single servo AF is in effect. Similarly, Custom Setting 10 can be used to turn closest subject priority on when continuous servo AF is used. See “Custom Settings,” items 9 and 10.







To select between single area and dynamic AF, turn the main command dial while holding down the [+] button (A). The AF area mode is displayed in the control panel on top of the camera (B).

 **Single area AF:** The camera focuses on the subject in the area selected for autofocus (see “Autofocus Area,” above). This mode is useful when focusing on subjects that are relatively stationary.

 **Dynamic AF:** The camera first focuses on the subject in the area selected for autofocus. If the subject moves to another focus area, the camera will automatically shift the focus area to follow it (the focus area shown in the viewfinder will not, however, change). This makes it possible to focus on subjects that are moving irregularly.

 **Dynamic AF with closest subject priority:** The camera first focuses on the closest object to the photographer that falls in one of the five focus areas, and then tracks this subject as it moves to other focus areas. No focus area indicators are shown in the viewfinder or in the control panel on top of the camera. This mode does not work well with telephoto lenses or poorly-lit subjects; use single area AF instead.

Autofocus modes

Focus mode	AF area mode	Closest subject priority	Focus area selection	LCD display	Focus area shown in viewfinder?
Single servo AF	Single area AF	NA	Manual		Yes
	Dynamic area AF	On (default)	Automatic		No
		Off (CSM 9)	Manual		Yes
Continuous servo AF	Single area AF	NA	Manual		Yes
	Dynamic area AF	Off (default)	Manual		Yes
		On (CSM 10)	Automatic		No

Focus Area

The D1 has five focus areas which together cover a wide area of the frame. By choosing the focus area according to your composition and the position of your subject, you can focus on an off-center subject without using focus lock.

To select a focus area, unlock the focus-area selector by rotating the lock release to the unlocked position (A). You can move the focus area left or right, up or down by pressing the focus-area selector in the corresponding direction.

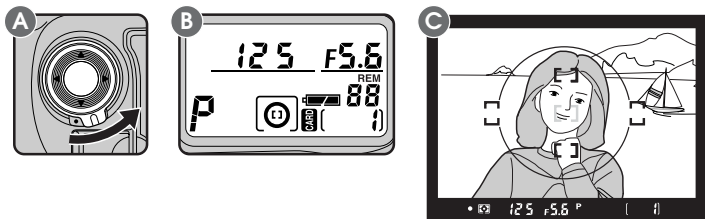

The selected focus area appears in the control panel on top of the camera (B) and is shown in red in the viewfinder (C). The focus area can be locked by rotating the focus-area selector lock release to the locked position.

Note: *The focus area can not be selected manually when closest subject priority is in effect. The focus area indicator is not displayed in the viewfinder or in the control panel on top of the camera when closest subject priority is in effect (see “AF Area Mode”).*

Tip

Focus area can still be selected when another type of finder screen is inserted in the camera.

CSM By default, if the top focus area is selected, the focus area will not change when the top of the focus-area selector is pressed. Similarly, pressing the selector to the right when the right area is selected has no effect. This setting can be changed so that pressing the top of the selector when the top area is selected activates the bottom area, pressing the selector to the right when the right area is selected activates the left area, etc. This allows you to shift focus from the right to left side, top to bottom, without changing the position of your finger on the focus-area selector. See “Custom Settings,” item 6.



Focus Lock

Focus lock can be used to focus on a subject not in any of the five focus areas, or on other occasions when you would otherwise be unable to focus on the subject using autofocus.

The procedure for using focus lock differs depending on whether you are using single or continuous servo AF. Follow the steps below.

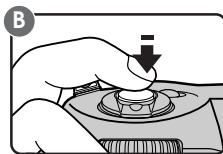
- 1 Position the subject in the focus area (A) and press the shutter-release button half way (B).



- 2^a In single servo AF, confirm that the in-focus indicator (●) appears in the viewfinder. Focus will remain locked at the current setting as long as the shutter-release button is held half way down. To lock exposure as well as focus, press the  button. Focus and exposure will remain locked as long as the  button is held down, even if you remove your finger from the shutter-release button.

Tip

CSM The  button can be set to lock only focus, rather than both focus and exposure. See “Custom Settings,” item 21.

- 2b** In continuous servo AF, after confirming that the in-focus indicator (●) appears in the viewfinder, press the **AF-ON** button. Both exposure and focus will be locked as long as the **AF-ON** button is held down, even if you remove your finger from the shutter-release button.

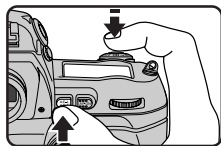

- 3** Keeping focus locked, recompose your photograph (A) and press the shutter-release button the rest of the way down to shoot (B).

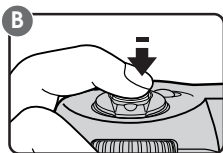

Do not change the distance between the camera and the subject while focus lock is in effect. If your subject moves, release focus lock and focus again at the new distance.

Tip

If you keep the shutter-release button pressed half way down after taking a photograph, focus lock will remain in effect, allowing you to take a succession of photographs at the same focus setting. If you keep the **AF-ON** button pressed, you can take a succession of photographs at the same focus and auto exposure settings.

Getting Good Results with Autofocus

Autofocus performs best when:

- The subject is well lit. To use autofocus with very dark subjects, use the AF-assist illuminator built into the Nikon SB-28DX Speedlight (available separately) and select the center focus area.
- There is contrast between the subject and the background. For example, autofocus may not perform well on subjects that are the same color as the background.
- The objects in the focus brackets are all at the same distance from the camera. For example, autofocus may not perform well when you are photographing an object inside a cage, as the bars of the cage will be closer to the camera than the object in the cage, and both the bars and the object in the cage will be in the focus brackets.
- The subject is not dominated by regular geometrical patterns. For example, the camera may have difficulty focusing on a row of windows in a skyscraper.
- The subject is evenly lit.

If the in-focus indicator (●) does not appear in the viewfinder when the shutter-release button is pressed half way, focus manually or use focus lock to focus on another subject at the same distance, then recompose your photograph (see “Focus Lock”).

Manual Focus

Manual focus can be used in situations in which autofocus will not produce the expected results, or when the lens attached to the camera is not an AF Nikkor lens.

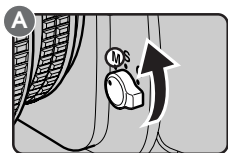

To use manual focus, set the focus mode selector to **M** (A). Adjust focus using the lens focusing ring (B) until the image displayed on the clear matte field in the viewfinder is in focus.

Using the electronic range finder



Set the focus mode selector to **M** and half-press the shutter-release button. Before the focus indicator in the viewfinder disappears, rotate the lens focusing ring (A) until the in-focus indicator (●) is displayed.

If the ► indicator appears in the viewfinder, the camera is focused on a point between the camera and the subject. The ◀ indicator appears when the camera is focused on a point behind the subject. Note that a photograph can be taken even when the in-focus indicator is not displayed in the viewfinder.

Note

The D1's built-in electronic range finder is compatible with most Nikkor lenses (including AF Nikkor lenses when used with manual focus) with a maximum aperture of f/5.6 or faster, and can be used when focusing on subjects in any of the five focus areas (see "Focus Area," above).

Metering

The D1 offers a choice of three metering methods, which can be chosen according to how your subject is lit:

-  **Color matrix metering/3D color matrix metering:** The D1 uses a 3D color matrix metering system. In this system, metering is performed by a CCD sensor with 1,005 (67 vertical × 15 horizontal) metering pixels, which sets exposure using a selection of data from all areas of the frame. This system is particularly effective with brightly-colored (white or yellow) or dark-colored (black or dark green) subjects that occupy a substantial portion of the frame, producing photographs closer to what is seen by the naked eye. 3D color metering can however only be used with D-type lenses. When another type of lens is in place, color matrix metering is used. Unlike 3D matrix metering, this system does not make use of range information from the lens.

Spot or center-weighted metering is recommended when you use AE-lock (see “AE Lock”) or exposure compensation (see “Exposure Compensation”).

-  **Center-weighted metering:** The camera measures light in the entire frame, but assigns the greatest weight to a circular area in the center of the viewfinder 8mm (0.31”) in diameter (the 12mm/0.47” circle in the center of the viewfinder, shown at right, can be used as a reference when center-weighted metering is selected).

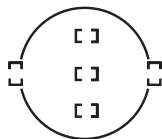

Tip

CSM The size of the area given the greatest weight in center-weighted metering can be set to 6mm (0.24”), 10mm (0.39”), or 13mm (0.51”) (see “Custom Settings,” item 14). Alternatively, you can set center-weighted metering to use the average of the entire frame. The default setting is 8mm.

- **Spot metering:** The camera measures light only in a circle 4mm (0.15") in diameter and centered on the current focus area. The area metered occupies approximately two percent of the entire frame. This method can be used with back-lit subjects or on other occasions when the background is much darker or much brighter than your subject.

As a rule, spot metering measures light in the current focus area, ensuring that your subject is properly exposed. When closest-subject priority is used with dynamic AF area selection, or when a non-CPU lens is attached, light will be measured in the center focus area only.

To choose a metering method, hold the metering selector lock release down and rotate the metering selector to the desired setting.

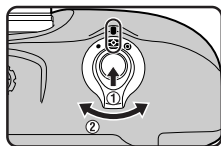

Tip

Some lenses do not support one or more of the above metering systems. See “Technical Notes: Compatible Lenses” for more information.

Exposure Mode

The D1 offers a choice of four exposure modes: programmed auto, shutter-priority auto, aperture-priority auto, and manual. This section discusses shutter-priority auto, aperture-priority auto, and manual exposure modes. For more information on programmed auto, see “First Steps.”

S — Shutter-priority auto

In shutter-priority auto, you set the shutter speed; the camera automatically adjusts the aperture to produce the best exposure. Shutter speed can be set to a value between 30 and $1/16,000$ seconds. High shutter speeds can be used to freeze motion, low shutter speeds to blur moving objects.



To use shutter-priority auto:

- 1 Holding the MODE button down, rotate the main command dial until **S** appears in the control panel on top of the camera.

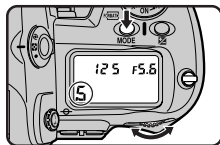

Note

Photographs can only be taken in shutter-priority auto when the lens aperture ring is set to its maximum f-number. At other aperture settings, the aperture display in the viewfinder and the control panel on top of the camera will show a blinking **FEE** and the shutter will lock.

Shutter-priority auto can only be used with CPU lenses. If another type of lens is attached, exposure mode is automatically set to aperture priority auto. The exposure mode display in the control panel on top of the camera will show a blinking **S**, and **A** will appear in the viewfinder. The aperture display in the viewfinder and the control panel on top of the camera will show **F--**, indicating that aperture must be set manually using the aperture ring on the lens.

Noise may appear in photographs taken at slow shutter speeds (speeds of roughly one second or slower).

- 2 Rotate the main command dial to choose a shutter speed.

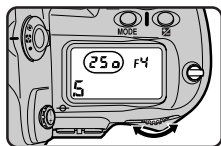

Shutter-speed lock

If desired, you can lock shutter speed to the selected setting so that it does not change accidentally when you use the main command dial for other purposes. If you hold the **L** button down while turning the main command dial to select the shutter speed (A), shutter speed will be locked when you release the **L** button, and lock indicators will appear in the viewfinder and the control panel on top of the camera (B). To release the lock, hold the **L** button down and turn the main command dial.

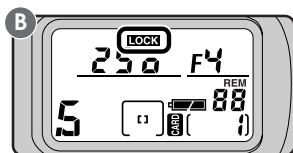
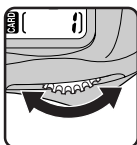
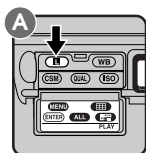

Tips

CSM The steps used in adjusting shutter speed and aperture can be changed using Custom Setting 2. See “Custom Settings.”

CSM You can choose the sub-command dial as the control for selecting shutter speed and aperture. See “Custom Settings,” item 12.

If the subject will be over- or under-exposed at the selected shutter speed, a warning will appear in the viewfinder and in the control panel on top of the camera when the shutter-release button is pressed half way.

HI The photograph will be overexposed. Select a higher shutter speed. If the warning persists, use a Neutral Density (ND) filter

Lo The photograph will be underexposed. Select a lower shutter speed or use a flash. The electronic analog exposure display will show the amount the photograph will be under- or over-exposed.

A — Aperture-priority auto

In aperture-priority auto, you set the aperture and the camera automatically adjusts the shutter speed to produce the best exposure. Small apertures (high f-numbers) can be used to increase the depth of field, bringing background and foreground into focus. Large apertures (low f-numbers) can be used to blur the background. Larger apertures can also be used to increase the range of the flash.



To use aperture-priority auto:

- 1 Holding the MODE button down, rotate the main command dial until **A** appears in the control panel on top of the camera.
- 2 Rotate the sub-command dial to choose an aperture between the minimum and maximum settings possible for the lens.

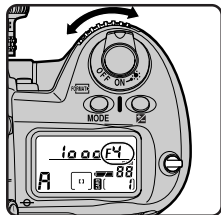
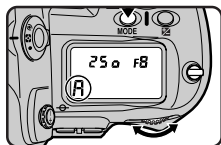

Note

With CPU lenses, the lens aperture ring must be set to its maximum f-number when aperture-priority auto is used. At other settings, the aperture display in the viewfinder and the control panel on top of the camera will show a blinking **FEE** and the shutter will lock.

When a non-CPU lens is used, aperture can be adjusted using the lens aperture ring. The aperture display in the viewfinder and the control panel on top of the camera will show **F--** to indicate that aperture must be set manually using the aperture ring.

CSM Custom Setting 22 can be used to allow aperture to be set with the aperture ring on CPU lenses. See “Custom Settings,” item 22.

Aperture lock

If desired, you can lock aperture to the selected setting so that it does not change accidentally when you use the sub-command dial for other purposes. If you hold the **L** button down while turning the sub-command dial to select the aperture (A), aperture will be locked when you release the **L** button, and lock indicators will appear in the viewfinder and the control panel on top of the camera (B). To release the lock, hold the **L** button down and turn the sub-command dial.

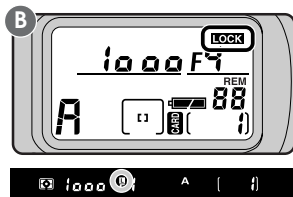
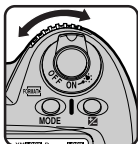
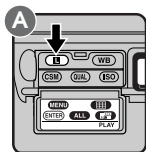

Tips

CSM The steps used in adjusting shutter speed and aperture can be changed using Custom Setting 2. See “Custom Settings.”

CSM You can choose the sub-command dial as the control for selecting shutter speed and aperture. See “Custom Settings,” item 12.

If the subject will be over- or under-exposed at the selected aperture, a warning will appear in the viewfinder and in the control panel on top of the camera when the shutter-release button is pressed half way.

HI The photograph will be overexposed. Select a higher f-number (smaller aperture). If the warning persists, use a Neutral Density (ND) filter.

Lo The photograph will be underexposed. Select a lower f-number (larger aperture) or use a flash.

The electronic analog exposure display will show the amount the photograph will be under- or over-exposed.

M — Manual

In manual exposure mode, you control both aperture and shutter speed. Shutter speed can be set for a long time exposure (**bulb**) or to fixed values between 30 and $1/16,000$ seconds. Aperture can be set to any value between the minimum and maximum values for the lens. Using the electronic analog exposure display in the viewfinder or the control panel on top of the camera, you can adjust exposure to suit your objective and shooting conditions.



To use manual exposure:

- 1 Holding the MODE button down, rotate the main command dial until **M** appears in the control panel on top of the camera.
- 2 Rotate the main command dial to choose a shutter speed (A). Aperture is set by rotating the sub-command dial (B).

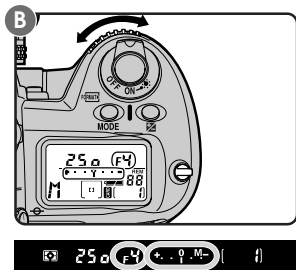
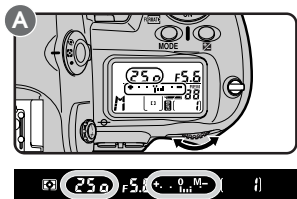
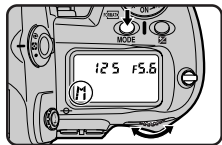

Tips

At a shutter-speed setting of **bulb**, the shutter will remain open as long as the shutter-release button is held down (long time exposure). Note however that if the shutter is open for more than one second at any setting, noise may appear in the final photograph.

Aperture and shutter speed can be locked using the **L** button, as described in “Shutter-priority auto” and “Aperture-priority auto.”

CSM The steps used in adjusting shutter speed and aperture can be changed using Custom Setting 2. See “Custom Settings.”

CSM You can reverse the roles of the main- and sub-command dials for selecting shutter speed and aperture. See “Custom Settings,” item 12.

- 3 Check exposure in the electronic analog exposure display in the viewfinder or the control panel on top of the camera, and readjust settings to achieve the desired result.

Reading the electronic analog exposure display

The electronic analog exposure display shows the amount the image will be over- or under-exposed if a photograph is taken at current settings. The display varies depending on whether exposure compensation is displayed in increments of $\frac{1}{3}$, $\frac{1}{2}$, or 1 EV (the illustrations below show the electronic analog exposure display in the control panel on top of the camera).

$\frac{1}{3}$ EV Increments

+2 +1 0 -1 -2



Overexposed ← → Underexposed

$\frac{1}{2}$ or 1 EV Increments

Overexposed ← → Underexposed



+3 +2 +1 0 -1 -2 -3

Some examples of how to read the display are given below.

$\frac{1}{3}$ EV Increments	$\frac{1}{2}$ or 1 EV Increments
Optimal exposure + -	Optimal exposure + -
Underexposed by $\frac{2}{3}$ EV + -	Underexposed by 1 EV + -
Overexposed by more than 2 EV + -	Overexposed by more than 3 EV + -

If the limits of the camera's metering system are exceeded, the electronic analog exposure display will flash.

Note

When using an AF Micro-Nikkor lens

When setting aperture by means of the sub-command dial, you need not take the exposure ratio into account *if you are using an external exposure meter*. Compensation that takes the exposure ratio into account is only necessary if you are using the lens aperture ring.

Auto-Exposure Lock

When spot or center-weighted metering is used in combination with programmed auto, shutter-priority auto, or aperture-priority auto, the camera determines exposure automatically with reference to lighting conditions in a limited area of the frame. Auto-exposure lock is used when you want auto exposure to be based on a subject that will not be in the focus area in the final composition.

To use auto-exposure lock:

- 1 With the metering selector lock release held down, rotate the metering selector to select center-weighted or spot metering.

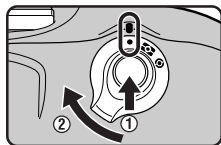

- 2 After positioning the subject in the focus area, press the shutter-release button half way and confirm that the in-focus indicator (●) appears in the viewfinder (A). With the shutter-release button held half way down, press and hold the **AE-L/AF-L** button (B).

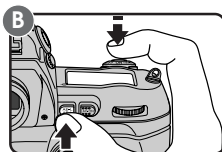

Exposure is calculated based on lighting conditions in the current focus area (spot metering) or in an 8mm circle in the center of the viewfinder (center-weighted metering).

Notes

Matrix metering is not recommended for use with auto-exposure lock, as it is unlikely to produce the desired results.

Note that if autofocus (single servo AF or continuous servo AF) is in effect, focus will lock when the **AF-ON** button is pressed. Check to see that the in-focus indicator (●) is displayed in the viewfinder. If desired, camera settings can be changed so that only auto-exposure is locked when the **AE-L/AF-L** button is pressed (see “Custom Settings,” item 21).

If spot metering is used in combination with closest-subject priority (see “AF Area Mode”), exposure will be based on lighting conditions in the center focus area.

- 3 With the **AE-L/AF-L** button held down, recompose your photograph (A) and shoot (B).

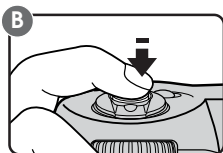
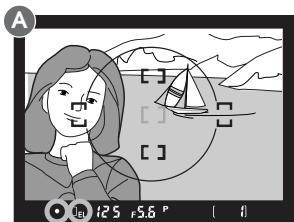

While the **AE-L/AF-L** button is held down, you can adjust shutter speed (when shutter-priority auto is selected as the exposure mode), aperture (aperture-priority auto), or flexible program (programmed auto). The aperture (in shutter-priority auto), shutter speed (aperture priority auto), or flexible program are automatically adjusted to produce the exposure set using auto-exposure lock. The adjusted values for shutter speed and aperture are displayed in the viewfinder and the control panel on top of the camera.

Metering can not be changed while exposure lock is in effect. Any changes to metering will take effect only after the **AE-L/AF-L** button is released.

Tips

- CSM** Camera settings can be changed so that auto-exposure locks when the shutter-release button is pressed half way. See “Custom Settings,” item 7.
- CSM** The size of the area given the greatest weight in center-weighted metering can be set to 6mm (0.24”), 10mm (0.39”), or 13mm (0.51”) (see “Custom Settings,” item 14). Alternatively, you can set center-weighted metering to use the average of the entire frame. The default setting is 8mm.
- CSM** Camera settings can be changed so that auto-exposure lock remains in effect after you release the **AE-L/AF-L** button. In this case, normal auto-exposure will be restored the next time the **AE-L/AF-L** button is pressed. See “Custom Settings,” item 21.

Exposure Compensation

Exposure compensation is used to deliberately change exposure from the optimum value as determined by the camera. This can be used, for example, to shoot subjects containing sharp lighting contrasts at a variety of different exposures. Exposure compensation is possible in any exposure mode.

- 1 Press the  button and rotate the main command dial. Exposure compensation adjusted in increments of $\frac{1}{3}$ EV, to a maximum of +5 EV or a minimum of -5 EV.

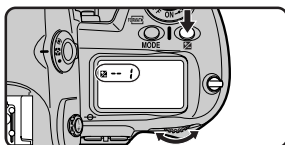

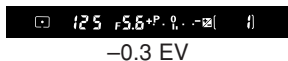

Viewfinder display



At values other than 0, a  indicator appears in the viewfinder and in the control panel on top of the camera. The electronic analog exposure display will show the amount of compensation, and the “0” indicator at the center of the display will blink to show that exposure compensation is in effect.

Tips

To display exposure compensation as a numerical value, press the  button. The current exposure compensation will appear next to the  indicator.

In general, the best results are achieved using a positive value for exposure compensation when your principal subject is darker than the background, and a negative value when the subject is brighter than the background.

CSM Exposure compensation can be set to change in increments of $\frac{1}{2}$ EV or 1 EV. See “Custom Settings,” item 2.

CSM Camera settings can be changed so that exposure compensation can be adjusted by turning the main or sub-command dial, even when the  button is not pressed. See “Custom Settings,” item 13.

2 Compose your photograph, focus, and shoot.

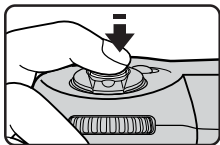

Normal exposure can be restored by setting exposure compensation to a value of 0.0, or by performing a two-button reset (see, “Two-Button Reset”). Exposure compensation is not reset when the camera is turned off.

Auto Bracketing

Bracketing is used to take a series of photographs of the same subject using a variety of exposure values that “bracket” optimum value as determined by the camera (or, in manual mode, by the photographer). This can be used to take multiple shots of the same subject at different exposure settings without stopping to adjust exposure compensation manually. Up to three photographs can be taken at exposure settings varying from +2 to -2 EV (these values are added to the value chosen for exposure compensation using the exposure compensation function described on the previous pages). Bracketing can be used in any exposure mode.

- 1 Holding down the BKT button (A), rotate the main command dial until **BKT** appears in the control panel on top of the camera (B). The  indicator in the viewfinder and in the control panel on top of the camera will blink.

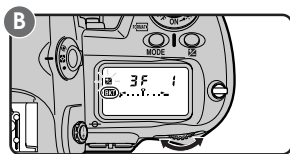
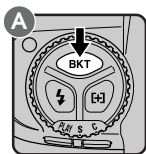

- 2 Holding the BKT button down (A), rotate the sub-command dial to choose a bracketing program (B). The bracketing programs available depend on Custom Setting 2 (see overleaf).

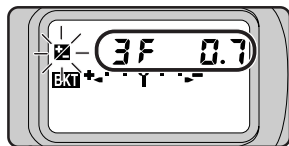
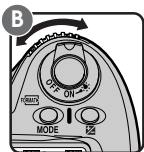
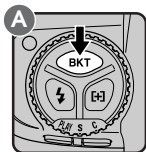

Note

Changes to exposure are effected by changing the shutter speed (manual and aperture-priority auto exposure modes), the aperture (shutter-priority auto), or both shutter speed and aperture (programmed auto).

Flash and auto-exposure bracketing

If a Speedlight is attached when bracketing is in effect, both flash level (TTL level as determined for the main subject) and auto-exposure will be changed for each exposure regardless of the exposure mode. Camera settings can be changed so that only one of flash-exposure bracketing or auto-exposure bracketing will be performed. See “Custom Settings,” item 11.

When Custom Setting 2 is set to $\frac{1}{3}$ increments (default):

Setting	Control Panel Exposure Display	Number of Shots/ Bracketing (EVs)
-2F1.0	+ ▶	2 (± 0 , -1.0)
-2F0.7	+ ▶	2 (± 0 , -0.7)
-2F0.3	+ . . . ▶	2 (± 0 , -0.3)
+2F1.0	◀ -	2 (± 0 , +1.0)
+2F0.7	◀ -	2 (± 0 , +0.7)
+2F0.3	◀ . . . -	2 (± 0 , +0.3)
-3F1.0	+ ! . ▶	3 (-1.0, -2.0, ± 0)
-3F0.7	+ . . . ! ▶	3 (-0.7, -1.3, ± 0)
-3F0.3	+ . . . ! ▶	3 (-0.3, -0.7, ± 0)
+3F1.0	◀ . ! -	3 (+1.0, ± 0 , +2.0)
+3F0.7	◀ . ! . . -	3 (+0.7, ± 0 , +1.3)
+3F0.3	◀ . ! . -	3 (+0.3, ± 0 , +0.7)
3F1.0	◀ ▶	3 (± 0 , -1.0, +1.0)
3F0.7	◀ ▶	3 (± 0 , -0.7, +0.7)
3F0.3	◀ . . . ▶	3 (± 0 , -0.3, +0.3)

When Custom Setting 2 is set to increments of $\frac{1}{2}$:

Setting	Control Panel Exposure Display	Number of Shots/ Bracketing (EVs)
-2F1.0	+ ▶	2 (± 0 , -1.0)
-2F0.5	+ ▶	2 (± 0 , -0.5)
+2F1.0	◀ -	2 (± 0 , +1.0)
+2F0.5	◀ -	2 (± 0 , +0.5)
-3F1.0	+ ! . ▶	3 (-1.0, -2.0, ± 0)
-3F0.5	+ ! ▶	3 (-0.5, -1.0, ± 0)
+3F1.0	◀ . ! -	3 (+1.0, ± 0 , +2.0)
+3F0.5	◀ . ! . . . -	3 (+0.5, ± 0 , +1.0)
3F1.0	◀ ▶	3 (± 0 , -1.0, +1.0)
3F0.5	◀ ▶	3 (± 0 , -0.5, +0.5)

When Custom Setting 2 is set to increments of 1:

Setting	Control Panel Exposure Display	Number of Shots/ Bracketing (EVs)
-2F1.0	+ ▶-	
+2F1.0	▶. -	
-3F1.0	+ ! . ▶-	
+3F1.0	▶. ! -	
3F1.0	▶. ▶-	

- 3** To take the first photograph in the series, compose a photograph, focus, and shoot. If the camera is set to continuous shooting mode (operating mode **C**), the camera will take the specified number of shots while the shutter-release button is held down and then stop automatically. In single-frame shooting or when the self timer is on (see “Self Timer Mode”), photographs are taken one at a time each time the shutter-release button is fully pressed. Bracketing can be cancelled before all the photographs in the series have been taken by holding down the **BKT** button and rotating the main command dial until **BKT** is no longer displayed in the control panel. The bracketing program currently selected will be recalled the next time bracketing is used.

Tips

The shutter-speed and aperture values displayed during shooting reflect the exposure compensation value for the current photograph.

Bracketing can be combined with exposure compensation (see “Exposure Compensation”). This can be used to achieve exposure compensations of more than +2.0 or less than -2.0 during bracketing.

If the camera is turned off before you have taken all the photographs in the sequence, you can continue from where you left off when the camera is turned back on. If the memory card fills up before you have completed the sequence, you can continue from where you left off after deleting images or inserting a new memory card.

CSM By default, the camera shoots photographs with a negative compensation value before shooting those with a positive compensation value. This can be changed using Custom Setting 3 (see “Custom Settings”).

Capture Preview Mode

When the camera is set to single-frame shooting, or the self timer is used, you can use capture-preview mode to view photographs in the LCD monitor before they are saved to the memory card. This makes it possible to delete unwanted photographs before they are saved.

To use capture preview:

- 1 Pressing the **CSM** button, rotate the main command dial to select item 1 in the custom settings menu (at default settings, “1-0,” for “Item 1, option 0,” will be displayed in the rear control panel).

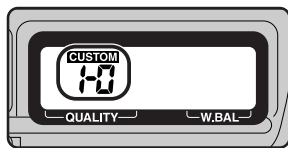
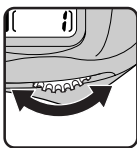
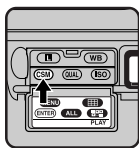

- 2 With the **CSM** button held down, rotate the sub-command dial to set the menu option to “1” (“capture-preview mode enabled”).

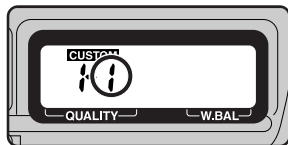
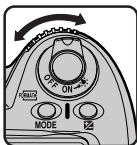
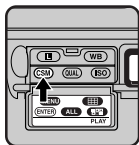

When you release the **CSM** button, CUSTOM will be displayed in the rear control panel.

- 3 Set the camera to single-frame shooting or self-timer mode.

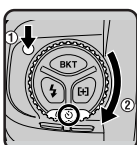
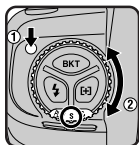

Photographs taken at these settings will be displayed in the LCD monitor before they are saved to the memory card. If the camera has been set to display the histogram and image highlights (see “Playback”), these will be shown as well. If the camera is connected to a television set, photos will also be displayed on the television screen.



If no other operation is performed, the monitor will stay on for the length of time specified in Custom Setting 18 or the playback menu “Auto Off” option (if this time is shorter than the time required to record the photograph, the monitor will remain on for five seconds after the image has been recorded to the card). The monitor will then turn off automatically to save power.

The operations that can be performed while the photograph is on display are as follows:

To record the photograph

Press the **CSM** button. The monitor will turn off and the photograph will be recorded to the memory card.

To delete the photograph before it is recorded to the memory card

Half-press the shutter-release button, or press the  or  button. The photograph will be deleted without being recorded to the memory card and the monitor will turn off.

To turn the monitor on or off

Press the  button to turn the monitor on or off. When the monitor is turned off, a monitor indicator will appear in the rear control panel, indicating that the photograph has yet to be deleted or recorded to the memory card. The photograph will be displayed again when the monitor is turned on.

Notes

Capture preview is only available in single-frame shooting or self-timer modes. Photographs are not displayed when the camera is set to continuous shooting or PC mode.

If, after the monitor has been turned off, another photograph is taken while the monitor indicator is displayed in the rear control panel, the current photograph will be deleted and the photograph just taken will appear in the monitor.

Record-and-Review

When the camera is set to single-frame shooting, or the self timer is used, you can choose to have photographs displayed automatically in the monitor immediately after they have been saved to the memory card. This allows you to delete unwanted photographs immediately after they have been taken.

To use record-and-review:

- 1 Pressing the **CSM** button, rotate the main-command dial to select item 1 in the custom settings menu (at default settings, “1-0,” for “Item 1, option 0,” will be displayed in the rear control panel).

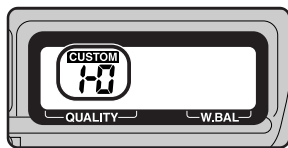
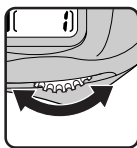
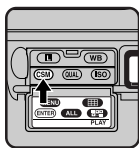

- 2 With the **CSM** button held down, rotate the sub-command dial to set the menu option to “2” (“record-and-review mode enabled”).

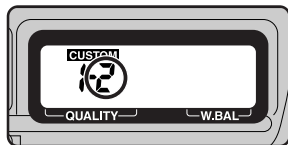
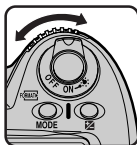
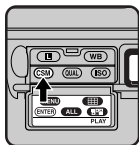

When you release the **CSM** button, CUSTOM will be displayed in the rear control panel.

- 3 Set the camera to single-frame shooting or self-timer mode.

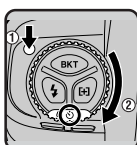
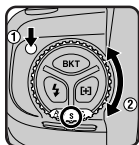

Photographs taken at these settings will be displayed in the LCD monitor. If the camera has been set to display the histogram and image highlights (see “Playback”), these will be shown as well. If the camera is connected to a television set, photos will also be displayed on the television screen.

If no other operation is performed, the monitor will stay on for the length of time specified in Custom Setting 18 or the playback menu “Auto Off” option (if this time is shorter than the time required to record the photograph, the monitor will remain on for five seconds after the image has been recorded to the card). The monitor will then turn off automatically to save power.

The operations that can be performed while the photograph is on display are as follows:

To delete the photograph

Press the  button. A confirmation dialog will be displayed; if you press  again, the photograph will be deleted and the monitor will turn off.

To end the display

After the camera has finished recording or deleting the photograph and the memory card access lamp has gone out, press any button other than the auto-bracketing button, the flash-sync mode button, or the AF-area mode button. The photograph will disappear from the display and the monitor will turn off.

To turn the monitor on or off

Press the  button to turn the monitor on or off. When the monitor is turned off, a monitor indicator will appear in the rear control panel, indicating that the photograph is still on display. The photograph will appear again when the monitor is turned on.

Notes

Record-and-review is only available in single-frame shooting or self-timer modes. Photographs are not displayed when the camera is set to continuous shooting or PC mode.

If, after the monitor has been turned off, another photograph is taken while the monitor indicator is displayed in the rear control panel, the current photograph will be cleared from the display and the photograph just taken will appear in the monitor. The current photograph is not deleted when cleared from the display.

Playing Photographs Back

Photographs already stored on the memory card can be played back without setting the camera to playback (**PLAY**) mode. This playback feature can be used in single-frame shooting, continuous shooting, and self-timer modes.

To play photographs back:

- 1 Press the shutter-release button half way to wake the camera up.

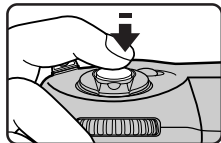

- 2 Press the monitor button.

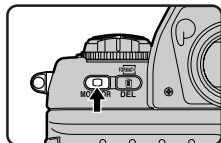

The most recent photograph in memory will be displayed. If the camera has been set to display the histogram and image highlights (see “Playback”), these will be shown as well. If the camera is connected to a television set, photos will also be displayed on the television screen (the camera’s LCD monitor must be on for photographs to be displayed).



Notes

If no photographs have been stored in the memory card, the message “CARD CONTAINS NO IMAGES” will be displayed.

The focus area selector can not be used to select the focus area while playback is in progress.

Photographs can not be played back in PC mode.

The operations that can be performed while playing photographs back are as follows:

To end playback





Press the  button or half-press the shutter-release button. The photograph currently on display will disappear and the monitor will turn off.

To stop the monitor from turning off automatically

If no other operation is performed, the monitor will stay on for the length of time specified in Custom Setting 18 or the playback menu “Auto Off” option. The monitor will then turn off automatically to save power.

After the monitor has turned off, the display can be restored by pressing the  button before automatic meter switch-off (see “Custom Settings,” item 15).



To delete the photograph currently displayed

Press the  button. A confirmation dialog will be displayed; press  again to delete the photograph. To return to single-image playback without deleting the photograph, press any of the buttons on the rear of the camera except the  and  buttons.

To view other photographs in memory

Press the focus area selector up () or down (.

To view information on the current photograph

Press the focus area selector to the left () or right () to hide or display information on the current photograph.

Notes

The left and right edges of photographs are not shown when the photographs are displayed in capture preview, record-and-review, or using the single-image playback feature described above.

Self Timer Mode

The D1's built-in self timer is ideal for photographs in which photographers wish to appear themselves. The camera should be placed on a stable, level surface (a tripod is recommended).

To use the self timer:

- 1 Holding down the mode dial lock release, rotate the mode dial to select .

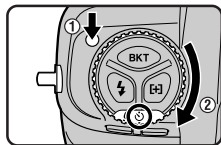

- 2 Compose the picture and focus.

With single-servo AF, check that the in-focus indicator (●) appears in the viewfinder. Photographs can not be taken when the camera is not focused.

- 3 In exposure modes other than manual (M), you should close the viewfinder eyepiece shutter (A) to prevent light entering via the eyepiece from affecting the results of the auto-exposure operation. You can then press the shutter-release button all the way down to start the self timer (B).

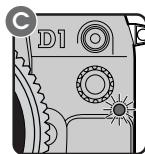
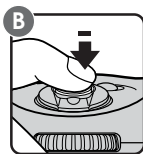
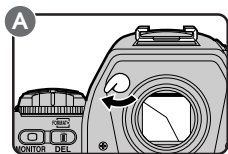

After the shutter-release button is pressed, the self-timer lamp on front of the camera (C) will blink for eight seconds. Two seconds after the lamp stops blinking, the shutter will release automatically and a photograph will be taken.

To turn the self timer off before a photo is taken, set the mode dial to a mode other than .

Tips

Do not stand in front of the lens when adjusting camera settings in single-servo or continuous-servo autofocus modes.

If a shutter speed of **bulb** (long time exposure) is chosen in self-timer mode, shutter speed will be set to approximately $1/_{10}$ sec.

CSM The timer can be set to delays of 2, 5, or 20 seconds using Custom Setting 16 (see "Custom Settings").

Diopter Adjustment

The viewfinder is equipped with diopter adjustment to accommodate individual differences in vision.

Pull the diopter knob out and rotate it until the focus brackets in the viewfinder are in sharp focus. Diopter can be adjusted between -3 DP and $+1$ DP. Corrective lenses (available separately) allow diopter to be adjusted between -3 DP and $+2$ DP.

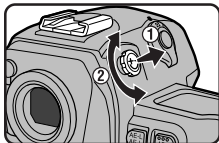

✓ **Important:** *Be careful not to accidentally put your finger in your eye when operating the diopter dial.*

LCD Illuminator

The rear control panel and the control panel on top of the camera are equipped with an illuminator so that you can view camera settings in the dark.

To turn the illuminator on, rotate the power switch to . The illuminator will remain on while the switch is held in this position. After the switch is released, the illuminator will remain on while exposure indicators are displayed, or until the shutter is released.

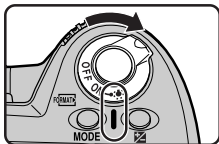

Tip

CSM The illuminator can be set to turn on when any button is pressed. See “Custom Settings,” item 17.

Depth-of-Field Preview

To check the depth of field for the aperture setting in the current exposure mode, hold down the depth-of-field preview button.

The lens will be stopped down to the aperture selected by the camera in programmed-auto or shutter-priority auto exposure modes, or to the value selected by the user in aperture-priority auto or manual modes. The view through the viewfinder will give you an approximate idea of the depth of field that can be obtained at the current aperture.

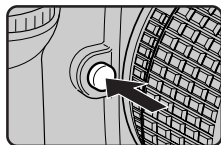

Focal Plane Position

The position of the focal plane inside the camera is indicated by a mark on the camera body.

The distance between the camera and the subject should be measured from this mark whenever distance is measured manually. The distance between the lens mounting flange and the focal plane is 46.5 mm (1.83").

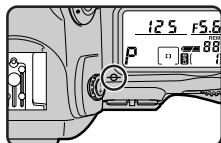

CUSTOM SETTINGS

Custom settings are available for a variety of camera functions. Settings can be changed singly or in combination according to your preferences and the task at hand.

Changing Custom Settings

To make changes to custom settings:

- 1 Select the desired item by rotating the main command dial while holding down the **CSM** button. The rear control panel will show the item number and the option currently selected for that item (e.g., “1-0” for “Item 1, option 0”).

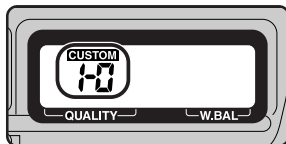
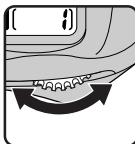
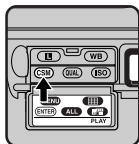

The D1 offers a total of 32 items (0–31), each with its own menu of options.

- 2 Select an option for the chosen item by rotating the sub-command dial.

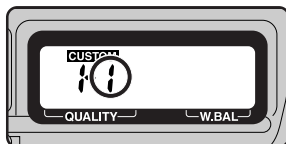
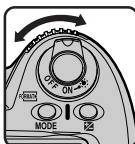
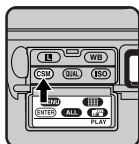

After you release the **CSM** button, **CUSTOM** will appear in the rear control panel.

Tip

To return custom settings to their default values, perform a two-button reset as described in “Two-Button Reset” at the end of this chapter. Only settings in the current custom set (see “Custom Settings Options,” item 0) will be reset.

Custom Settings Options

0. Custom Settings

The camera can store up to two sets of custom settings (Set A and Set B). Using Custom Setting 0, you can recall either of these sets. Any changes to settings apply to the current set.

- Option: A** Custom Set A (default)
B Custom Set B

1. Image Status

The camera offers a choice of capture modes for single-frame shooting and self-timer modes: “capture preview” (photographs are displayed in the monitor before being saved to the memory card) and “record-and-review” (photographs are displayed in the monitor after being saved to the memory card). Either mode allows you to delete unwanted photographs immediately after shooting.

- Option: 0** Photograph is not displayed (default)
1 Capture-Preview Mode
2 Record-and-Review Mode

2. EV Steps for Exposure Control

This setting controls the size of the increments for adjusting shutter-speed, aperture, exposure compensation, and auto exposure bracketing.

- Option: 3** $\frac{1}{3}$ increments (default)
2 $\frac{1}{2}$ increments
1 Increments of 1

3. Bracketing Order

In auto bracketing, photographs are taken in the order given in “Camera Settings: Auto Bracketing” when the default option (0) is in effect. Selecting option 1 causes bracketing to proceed from negative to positive compensation values.

- Option: 0** Default (see “Camera Settings: Auto Bracketing”)
1 Negative-to-positive bracketing

4. Autofocus Activation

By default, autofocus is performed when the shutter-release button is pressed half way. It can also be set to start only when the  button is pressed.

- Option: 0** Autofocus is performed when the shutter-release button is pressed half way (default)
1 Autofocus is only performed when the  button is pressed

5. Anti-Vibration Mode (Delay Exposure until Mirror Shock Has Subsided)

By default, the image is captured at the same time the shutter is released. To minimize mirror shock, you can set the camera to capture the image after the shutter is released.

Option: 0 No delay (default)

1 Release delay in effect

6. Focus Area Selection

At default settings, the focus area display is bounded by the four outer focus areas. Thus, for example, pressing the focus selector toward the top when the top focus area is already selected will have no effect. This can be changed so that the focus area “wraps around” from top to bottom and right to left. In this case, pressing the focus selector toward the top when the top focus area is highlighted selects the bottom focus area, and vice-versa. Similarly, pressing the selector to the right when the right area is highlighted selects the left focus area.

Option: 0 Default (focus area does not wrap around)

1 Wrap-around in effect

7. AE Lock

By default, auto-exposure only locks when the  button is pressed. This can be changed so that auto-exposure locks when the shutter-release button is pressed half way.

Option: 0 Auto exposure locks only when the  button is pressed (default)

1 Auto-exposure locks when the shutter-release button is pressed half way

8. Mirror Up

This setting can be used to leave the mirror in the up position so that the CCD can be cleaned. See “Technical Notes: Cleaning the CCD.”

Option: 0 Mirror down during cleaning (default)

1 Mirror up during cleaning

9. Dynamic AF Mode in Single-Servo AF

This item can be used to activate or deactivate closest subject priority when dynamic AF is used with single-servo autofocus.

Option: 0 Closest subject priority enabled (default)

1 Closest subject priority disabled

10. Dynamic AF Mode in Continuous-Servo AF

This item can be used to activate or deactivate closest subject priority when dynamic AF is used with continuous-servo autofocus.

Option: 0 Closest subject priority disabled (default)

1 Closest subject priority enabled

11. Auto Exposure/Flash Exposure Bracketing

By default, when a Speedlight is used with auto bracketing (see “Camera Settings: Auto Bracketing”), flash exposure bracketing and auto-exposure bracketing will be performed simultaneously. Using this item, you can change camera settings so that only flash exposure bracketing or only auto-exposure bracketing is performed.

Option: AS Flash exposure bracketing and auto-exposure bracketing performed together (default)

AE Only auto-exposure bracketing is performed

Sb Only flash exposure bracketing is performed

12. Command Dial Functions

By default, the main command dial is used to change shutter speed in shutter-priority and manual exposure modes, the sub-command dial to change aperture in aperture priority and manual exposure modes. This relationship can be reversed using this item.

Option: 0 Main command dial controls shutter speed, sub-command dial controls aperture (default)

1 Sub-command dial controls shutter speed, main command dial controls aperture

13. Exposure Compensation Settings

This item allows exposure compensation to be set without pressing the  button.

Option: 0 Exposure compensation is set by pressing the  button and turning the main command dial (default)

1 Exposure compensation can be set by turning the sub-command dial (programmed auto or shutter-priority auto) or main command dial (aperture-priority auto or manual). If the roles of the main command and sub-command dials are switched using Custom Setting 12, exposure compensation will be assigned to the sub-command dial in programmed auto, aperture-priority auto, and manual modes, and to the main command dial in shutter-priority auto.

14. Center-Weighted Metering Area

By default, center-weighted metering assigns the greatest weight to a circle in the center of the viewfinder 8 mm (0.32") in diameter. The diameter of the area assigned the greatest weight can be changed to 6 mm (0.24"), 10 mm (0.39"), or 13 mm (0.51"), or exposure can be based on the average lighting for the entire frame.

- Option:**
- 6 Greatest weight assigned to a 6 mm circle
 - 8 Greatest weight assigned to an 8 mm circle (default)
 - 10 Greatest weight assigned to a 10 mm circle
 - 13 Greatest weight assigned to a 13 mm circle
 - A Exposure based average for entire frame

15. Time Delay for Auto Meter-Switch-Off

By default, exposure indicators are displayed in the control panel on top of the camera for six seconds after the camera is turned on. This can be changed to four, eight, or sixteen seconds.

- Option:**
- 4 Four-second delay
 - 6 Six-second delay (default)
 - 8 Eight-second delay
 - 16 Sixteen-second delay

16. Self-Timer Duration

When photographs are taken using the self-timer, the default delay between the time the shutter-release button is pressed all the way down and the time the shutter is released is ten seconds. The timer can also be set to delays of two, five, or twenty seconds.

- Option:**
- 2 Two-second delay
 - 5 Five-second delay
 - 10 Ten-second delay (default)
 - 20 Twenty-second delay

17. LCD Illumination

By default, the LCD illuminator comes on when the power switch is turned to . Using this item, the illuminator can be set to come on when any button is pressed.

- Option:**
- 0 LCD illuminator comes on when power switch is turned to  (default)
 - 1 LCD illuminator comes on when any button is pressed

18. LCD Monitor Auto Power Off

The time the LCD monitor will remain on if no operations are performed during playback can be set using this item.

- Option:**
- 0 Twenty seconds (default)
 - 1 One minute
 - 2 Five minutes
 - 3 Ten minutes

19. Aperture Setting

On certain lenses, aperture varies with focal length or lens-to-film distance. For example, some Zoom-Nikkor lenses' maximum aperture varies with focal length, while some Micro-Nikkor lenses' maximum aperture varies with lens-to-film distance. By default, the aperture set using the sub-command dial in aperture-priority or manual exposure modes is preserved as either focal length or lens-to-film distance changes. Using this item, the camera can be set to maintain aperture a constant number of steps from the maximum aperture for the current focal length or lens-to-film distance. Suppose an aperture of $f/8$ is selected with an AF Zoom-Nikkor 70-210 mm $f/4$ -5.6D lens zoomed out to 70 mm. When the lens is zoomed to this position, $f/8$ is two steps from the maximum aperture of $f/4$. At default settings, the aperture will remain a constant $f/8$ even when the lens is zoomed out to 210 mm. If the camera is set to maintain aperture a constant number of steps from the maximum aperture for the current focal length, however, the aperture at 210 mm will be $f/11$, two steps from $f/5.6$, the maximum aperture for this focal length.

Option: 0 Aperture does not change with focal length or lens-to-film distance (default)

- 1 Aperture is maintained at a value a constant number of steps from the maximum aperture for the current focal length or lens-to-film distance

20. Shutter Release Indication via Self-Timer Lamp

The self-timer lamp on the front of the camera can be set to light immediately before the shutter is released, even when the self timer is not used.



Option: 0 Self-timer lamp does not light when shutter is released (default)

- 1 Self-timer lamp lights immediately before shutter is released

21. Button

By default, both auto exposure and autofocus are locked when the  button is pressed and remain locked when it is held down. Using this item, you can change settings so that auto exposure remains locked when the button is released, or so that only one of auto exposure or autofocus is locked while the button is held down.

Option: 0 Both auto exposure and autofocus are locked while the  button is pressed (default)

- 1 Only auto exposure is locked while the  button is pressed
- 2 Only autofocus is locked while the  button is pressed
- 3 Auto exposure is locked when the  button is pressed, and remains locked until the button is pressed a second time

22. Aperture Selection

By default, aperture can only be set using the sub-command dial in aperture-priority auto and manual exposure modes. Using this item, you can change settings so that aperture can only be adjusted using the lens aperture ring.

Option: 0 Aperture can only be adjusted using sub-command dial (default)

- 1 Aperture can only be adjusted with lens aperture ring

23. Sharpening

The D1 can be set to increase or decrease the sharpness of edges in photographs recorded using the camera.

Option: 0 Normal (default)

- 1 Low
- 2 High
- 3 None

24. Tone Compensation

This setting controls the image compensation performed by the camera when a photograph is taken. Compensation is performed by means of curves which define the relationship between the tone distribution in the original image and the compensated result. By default, the D1 automatically adjusts tonal range and distribution for optimal results when matrix metering is used. At settings other than RAW (when data from the CCD are recorded directly to the memory card without adjustment), you can choose from auto, normal, low-contrast, and high-contrast settings. You can also use custom curves created and downloaded to the camera using *Nikon Capture* software for the D1 (available separately). The default custom curve is linear.

Option: 0 Auto (default)—camera adjusts curves to produce optimal contrast (matrix metering only; when another metering method is used, this option is equivalent to option 1, i.e. normal tone compensation)

- 1 Normal—this curve is suitable for scenes with a normal distribution of shadows, mid-tones, and highlights
- 2 Low-contrast—use this curve to prevent highlights in brightly-lit scenes from being “washed out”
- 3 High-contrast—use this curve to bring out hazy background details
- 4 User-defined custom curve

25. Shooting Speed in Continuous Shooting Mode

This item can be used to adjust the frame advance rate in continuous shooting mode.

Option: Ch Approx. 4.5 frames per second (default)

- 3 Approx. 3 fps
- 2 Approx. 2 fps
- 1 Approx. 1 fps

CL Each photograph is written to the memory card before the following photograph is taken. Photographs are not stored in the temporary memory buffer.

26. Maximum Number of Consecutive Shots in Continuous Shooting Mode

This item determines the number of photographs that can be stored in the temporary memory buffer in continuous shooting mode (see “Camera Settings: The Mode Dial”).

Option: 21 Twenty-one standard photographs, ten photographs in RAW format (default)

1–20 Specified number of photographs, from one to twenty (one to nine in RAW format)

27. LCD Monitor Display Mode

By default, only image data are displayed when photographs are played back. Using this item, you can also show the histogram and/or highlights (see “Playback” for more information on histograms and highlights).

Option: 0 Image only (default)

1 Image and histogram

2 Image and highlights

3 Image, histogram, and highlights

28. Save RAW Images

The RAW data format is only available at an image quality of HI when this item is set to 1.

Option: 0 RAW data format not available (default)

1 RAW data format available

29. Auto File Numbering Mode

The D1 stores photographs in numbered files and folders. Because no two photographs or folders on any given memory card will have the same number at the same time, there is no possibility of confusion so long as you continue to use a single memory card without formatting it. If you format the card or use a new card, however, a number previously assigned may be used again. If you then copy a folder or photograph to a computer, an earlier folder or photograph with the same number may be overwritten. This can be prevented using option 1. With this option, when a new card is inserted, numbering will continue from the highest number available on the previous card. Choose option 0 to restore normal filename assignment.

Option: 0 Normal filename assignment (default)

1 Sequential filename assignment

Note

If you select option 1, Sequential filename assignment, it is important to remember to turn the camera off before removing the power source. If the batteries are removed, or if the AC adapter is disconnected while the camera is on, sequential filename assignment will be reset, with the result that two files could have the same name, albeit in different folders.

30. Shooting Mode in PC Mode

The normal frame-advance mode when the camera is connected to a computer is single frame shooting, but the continuous shooting can be chosen using this item.

- Option: S** Single frame shooting (default)
C Continuous shooting



31. Sensitivity Up

By default, sensitivity can be set to a values equivalent to ISO 200, 400, 800, or 1,600. Sensitivity up can be used to increase sensitivity by a factor of +1 or +2 over ISO 1600. These settings can be used to achieve high shutter speeds at night-time sporting events, or to achieve optimal exposure when taking photographs of poorly-lit subjects. Note, however, that high sensitivity settings increase the amount of noise that appears in the final photograph. It is recommended that you take a trial photograph to check the results when shooting at high sensitivity settings.

- Option: 0** Sensitivity can be set to values equivalent to 200, 400, 800, or 1,600 (default)
- 1 Sensitivity set to +1 (sensitivity display in rear control panel shows **HI-1**)
 - 2 Sensitivity set to +2 (sensitivity display in rear control panel shows **HI-2**)

Quick Guide to Custom Settings Options

Copy the following table and keep it with your camera for reference.

Custom Setting	Option	Meaning	Custom Setting	Option	Meaning
0: Custom settings	A	Custom Set A	6: Focus area selection	0	Default
	b	Custom Set B		1	Wrap-around
1: Image status	0	Disabled	7: AE lock	0	Only  button locks AE
	1	Capture Preview Mode		1	AE locks when shutter-release button pressed half way
	2	Record-and-Review Mode	8: Mirror up		0
2: EV steps for exposure control	3	$\frac{1}{3}$	1	Mirror up	
	2	$\frac{1}{2}$	9: Dynamic AF mode (single-servo AF)	0	Closest subject priority enabled
	1	1		1	Closest subject priority disabled
3: Bracketing order	0	Default	10: Dynamic AF mode (continuous-servo AF)	0	Closest subject priority disabled
	1	Negative-to-positive		1	Closest subject priority enabled
4: Autofocus activation	0	Shutter-release button activates AF			
	1	AF activated by  button only			
5: Anti-vibration mode	0	Disabled			
	1	Enabled			

Custom Setting	Option	Meaning	Custom Setting	Option	Meaning
11: Auto exposure/flash exposure bracketing	AS	Flash and auto exposure	23: Sharpening	0	Normal
	AE	Auto exposure only		1	Low
	Sb	Flash exposure only		2	High
0	Default	3		None	
12: Command dial functions	1	Roles of main and sub command dials reversed	24: Tone compensation	0	Auto
	0	Default		1	Normal
13: Exposure compensation settings	1	Exposure compensation set by turning main or sub command dial		2	Contrast-
	0	Default		3	Contrast+
14: Center-weighted metering area	6, 8, 10, 13, A	Diameter of metering area in mm ("A" is average for entire frame)		4	Custom
	15: Time delay for auto meter-switch-off	4, 6, 8, 16	Delay in seconds	Ch	4.5 fps
				3	3 fps
				2	2 fps
16: Self-timer duration	2, 5, 10, 20	Duration in seconds	1	1 fps	
			CL	Rapid single frame	
			26: Maximum number of consecutive shots in continuous shooting mode	21	21 (10 shots in RAW format)
				1-20	1-20 (1-9 shots in RAW format)
17: LCD illumination	0	LCD illuminates when power switch set to 	27: LCD monitor display mode	0	Image only
				1	Image and histogram
				2	Image and highlights
18: LCD monitor auto power off	0, 1, 2, 3	20 seconds, 1 minute, 5 minutes, 10 minutes		3	Image, histogram, and highlights
			28: Save RAW images	0	RAW format not available
				1	RAW format available
			19: Aperture setting	0, 1	Fixed, Variable
1	Sequential numbering				
20: Shutter-release indication via self-timer lamp	0, 1	Disabled, Enabled	30: Shooting mode in PC mode	S	Single-frame shooting
				C	Continuous shooting
			21:  button	0, 1, 2, 3	Locks AE and AF, AE lock only, AF lock only, Press once to lock AE. Press again to release.
1	+1.0				
2	+2.0				
22: Aperture selection	0, 1	Sub-command dial, Lens aperture ring			

Two-Button Reset

Two-button reset restores camera and custom settings to their default values.

To reset camera settings, hold the **CSM** and **ISO** buttons down together for more than two seconds.

The following camera settings will be reset to their default values:

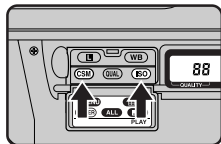

Setting	Default
Image quality	Normal (color)
Sensitivity	ISO 200 equivalent
White balance	A (auto white balance; manual white balance adjustment set to 0)
AF area mode	Single area AF
Focus area	Center
Exposure mode	Programmed auto
Flexible program	None
Shutter-speed lock	Off
Aperture lock	Off
Auto-exposure lock	Off
Exposure compensation	± 0
Auto bracketing	Off
Flash synchro mode	Front-curtain sync

To reset custom settings for the current custom set (A or B) to their default values, hold the **CSM** and **ISO** buttons down together for more than two seconds. The **CUSTOM** indicator in the rear control panel will start to blink. Release both buttons while the indicator is blinking and then press the buttons again. Both camera settings and custom settings for the current custom set will be restored to their default values.











PLAYBACK

This chapter describes the D1's playback options, including viewing photographs and photograph information, deleting photographs, and the playback menu.

Playing Photographs Back

Playback Controls

The buttons next to the rear control panel and the  button have two functions, one for changing camera settings and another in playback mode.

Button	Name in playback mode	Function in playback mode
	Menu 	Display/hide playback menu
	Thumbnail 	Display thumbnails
	Execute 	Select menu item
	Select All 	Select all thumbnails
	Multiple Select 	Select multiple images
	Cancel	Cancel operation and return to previous menu

Single-Frame Playback

Photographs stored in the memory card can be played back one at a time on the LCD monitor.

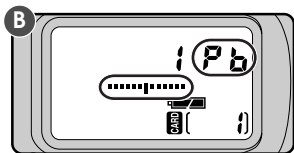
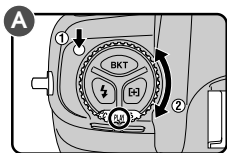

- 1 Holding down the mode dial lock release, turn the mode dial to PLAY (playback mode). Playback indicators will appear in the control panel on top of the camera (B).



An hourglass icon will be displayed while the camera reads the most recent photograph in memory. The image is displayed together with the folder number and frame number (see right).



Tip

The  button controls the LCD monitor. Press the  button to turn the monitor on and off. If the camera is connected to a television, the television will continue to display images even when the monitor is off.

- 2 After rotating the focus area selector lock to the unlocked position, use the focus area selector to view other photographs or photo information.

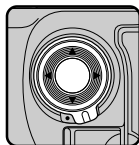

Pressing the focus area selector up or down displays the other photographs in memory one at a time. To scroll quickly to a particular frame number without viewing intervening photos, hold the selector down for more than two seconds. Photographs will be reduced to thumbnails in the center of the LCD monitor for rapid display, with the frame number appearing at the bottom of each photograph. The camera will scroll quickly through photographs while the focus area selector is held down. Release the selector when the desired frame is reached.

To display or hide information for the current photograph, including date of recording and camera settings at the time the photograph was made, press the selector to the right or left. The display changes as shown below.

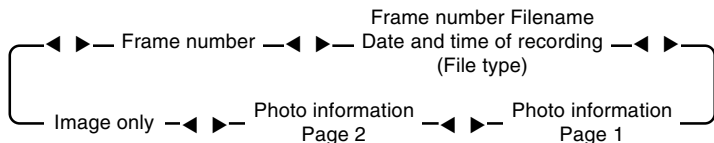

Photograph information includes: the model of camera used, the camera firmware version, metering, shutter speed, aperture, exposure compensation, sensitivity, image type (color or black-and-white), white balance, white-balance adjustment, tone curve, edge enhancement, and focal length. The information actually displayed depends on the lens used.

Tips

The first and last photographs in memory are linked. Pressing the focus-area selector towards the top when the last photo in memory is selected takes you to the first photo; pressing the selector towards the bottom when the first photo is selected takes you to the last photo.

The brightness of the LCD monitor can be adjusted using the sub-command dial.



Thumbnail Playback

The D1 can display the photographs stored in the flash memory card as thumbnail images. In this mode, up to nine images can be displayed at a time.

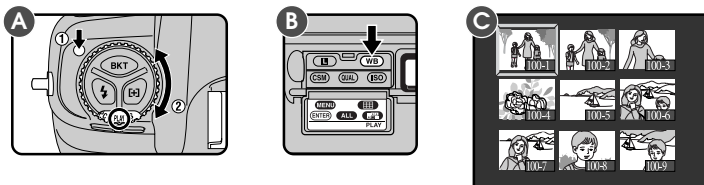
- 1 Holding down the mode dial lock release, turn the mode dial (A) to PLAY (playback mode) and press the  button (B) to display a menu of up to nine preview images (C).



The currently selected thumbnail will be highlighted.

- 2 If there are more than nine photos in memory, use the main command dial to page through the previews, nine at a time (A). Use the focus area selector to highlight the photo you want to view (B), then press the  button or the  button to view it at full size (C).

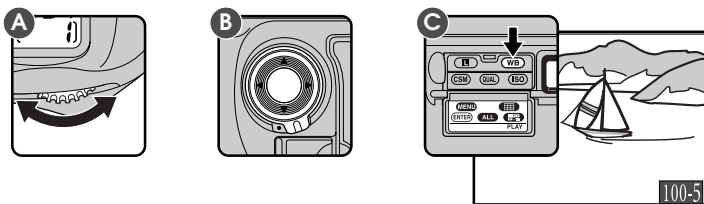





Tip

When images are displayed in playback mode, the monitor will turn off automatically if no operations are performed for the length of time specified in Custom Setting 18 or the playback menu "Auto Off" setting (see "The Playback Menu," below). The display can be restored by pressing the shutter-release button lightly within the time specified in Custom Setting 15 (default is six seconds).

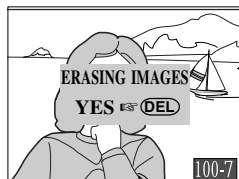
Deleting Images

To delete the image currently displayed, or to delete the image currently selected in the thumbnail display, press the  button. Note that *once deleted, photos cannot be recovered*; be sure to make copies of any photographs you wish to keep, prior to deletion.



This dialog appears when the  button is pressed. Press the  button again to delete the selected photograph. To return to playback without deleting the photograph, press any of the buttons on the rear of the camera except the  and  buttons.

Notes

If there are no photographs in the current folder, the message, "card contains no image data" will be displayed. Although you will not be able to play photographs back, you can still use the options available in the SET UP submenu of the playback menu (see "The Playback Menu," below). To view or delete images in other folders, select "D1 NC_D1" or "DCF_ALL" using the FOLDERS item in the SET UP submenu.

The D1 can not display photographs taken with other digital cameras full screen. It can display thumbnail previews of photographs taken with cameras that conform to the Design Rule for Camera File Systems (DCF).

The left and right edges of photographs are not shown when the photographs are played back in the LCD monitor.

The Playback Menu

The playback menu offers options for deleting multiple images, creating slide shows, protecting photographs from deletion, and hiding photographs during playback. It also includes options for setting up photos for printing at print services or on printers that support the Digital Print Order Format (DPOF).

To use the playback menu:

- 1 Holding down the mode dial lock release, turn the mode dial to PLAY (playback mode).

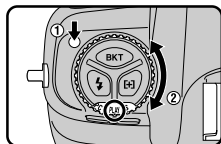

- 2 Press the **MENU** button (A) to display the playback menu (B).

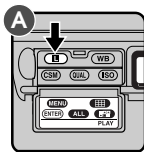

- 3 Menu items can be highlighted by pressing the top of the focus area selector to move up through the list, or the bottom of the selector to move down through the list.

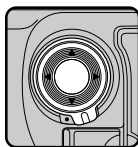

- 4 To select the currently highlighted item, press the **ENTER** button or press the focus area selector to the right.

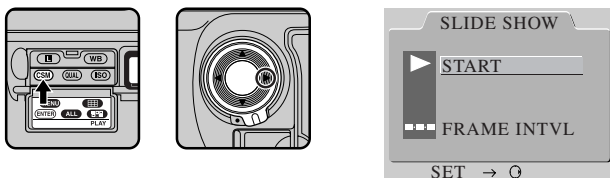

A submenu of options for the currently selected item will be displayed. To return to the playback menu without making any changes to settings, press the focus area selector to the left or press the **EXIT** button.

- 5 To make changes to settings, highlight the desired option (A) and press the **ENTER** button (B) or press the focus-area selector to the right.

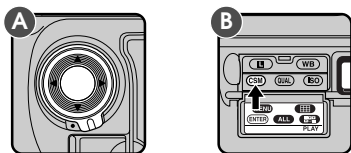

Delete

The DELETE submenu contains the following options:

- SELECTED:** Delete multiple selected photographs
- ALL:** Delete all photographs in the current folder
- PRINT SET:** Delete print-order files created using the PRINT option

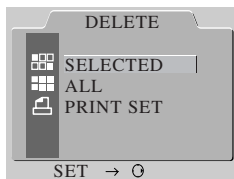

SELECTED

When this option is selected, a thumbnail menu showing the images in the current folder will be displayed. Choose the photographs to be deleted from the thumbnail menu and press the **ENTER** button. A confirmation dialog will be displayed; select YES to permanently delete the selected photographs. Select NO or press the **DISP** button to cancel the operation and return to the thumbnail menu.

ALL

When this option is selected, a confirmation dialog will be displayed. Selecting YES in this dialog permanently deletes all photographs in the current folder with the exception of those protected with the PROTECT option or hidden using HIDE IMAGE. Select NO or press the **DISP** button to cancel the operation and return to the DELETE submenu.

PRINT SET

When this item is highlighted, pressing the focus-area selector to the right or pressing the **ENTER** button deletes the current print order file created using the PRINT SETUP option.

Tip

Selecting photographs from a thumbnail menu

To select multiple photos from a thumbnail menu, highlight images with the focus area selector and press the **DISP** button, or press **ALL** to select all images. Selected images are marked with an icon; to deselect an image, highlight it and press the **DISP** button. To complete the operation, highlight the last of the images to be selected and press the **ENTER** button. To exit from the thumbnail menu, press the **MENU** or **DISP** button.

Slideshow

The SLIDE SHOW submenu contains the following options:

- START:** Start a slide show
FRAME INTVL: Select the time each image will be displayed

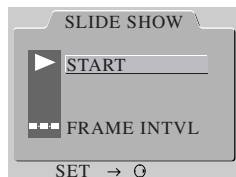

START

When this option is selected, the camera will display the photographs in memory one at a time in the order they were taken (photographs hidden using the HIDE IMAGE option will not be displayed).

To pause the slide show, press the **ENTER** button; a pause screen will be displayed. Selecting **RESTART** in the pause screen will restart the slideshow. Press the **STOP** button to end the slideshow and return to the playback menu.

When the slideshow finishes, a pause screen will be displayed. To exit the slideshow and return to playback mode, press the **MENU** button.

FRAME INTVL

This option is available in the SLIDE SHOW submenu and the slideshow pause screen. Selecting this option brings up a menu of interval settings. The interval controls the time between photographs in the slide show (the default interval is two seconds). When an interval setting is selected, the slideshow will begin or continue from where it was interrupted. Press the **STOP** button to end the slideshow and return to the playback menu.

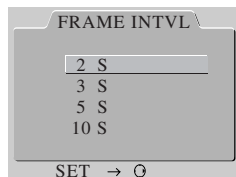

Notes

When a slideshow is in progress, the camera will power off automatically if no operation is performed for ten minutes.



The actual interval between images varies with the size of the images that must be displayed.

Protect

The PROTECT option in the playback menu allows you to change the protected status of selected images. Images can be chosen from a thumbnail menu, where protected images are marked with a  icon. Protected images can not be deleted (although they are erased when the memory card is formatted), and have read-only status when viewed on a computer.









Hide Image

The HIDE IMAGE option in the playback menu allows you to change the hidden status of selected images. Images to be hidden or revealed can be chosen from a thumbnail menu, where hidden images are marked with  and  icons. Hidden images can not be deleted (although they are erased when the memory card is formatted), and are not displayed during playback or slide shows. They are treated as hidden, read-only files when viewed on a computer.



Tip

Selecting photographs from a thumbnail menu

To select multiple photos from a thumbnail menu, highlight images with the focus area selector and press the  button, or press  to select all images. Selected images are marked with an icon; to deselect an image, highlight it and press the  button. To complete the operation, highlight the last of the images to be selected and press the  button. To exit from the thumbnail menu, press the  or  button.

Print Setup

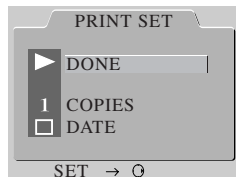

The PRINT SET option in the playback menu allows images to be selected for printing using a printer or print service that supports the Digital Print Order Format, or DPOF. Data concerning the images and other information to be printed are saved in print order files on the flash memory card. The requested images and information can then be printed when the card is inserted in a DPOF-compatible device.





When PRINT SET is selected, a thumbnail menu will appear, where you can select images that will be printed, or remove images that have already been selected. Images selected for printing are marked by a  icon. After you have selected the images to be printed, the menu of print options shown above will be displayed.

The options available are as follows:

DONE: Select this item to confirm the print order and exit the print setup menu.

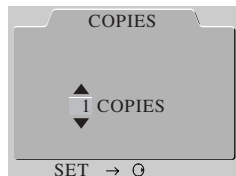
COPIES: The number of copies of the selected images that will be printed can be set by highlighting this item and pressing the  button. The number of copies to be printed can be selected from the COPIES menu (shown at right) using the focus area selector. Press the  button to save changes and return to the PRINT SET menu, or press the  button to cancel the operation and exit from the COPIES menu.



DATE: If this item is checked, the date of recording will be printed on the photographs. The item can be checked or unchecked by highlighting it and pressing the  button.

Setup

The SET UP menu contains the following options:

- FOLDERS:** Create new folders for recording photographs or select folders for playback.
- OPTIONS:** Select whether to display a histogram and/or highlights when images are displayed in single image playback, capture preview, and record-and-review.
- AUTO OFF:** Set the length of time before the monitor turns off automatically in playback mode.
- LANGUAGE:** Choose a language for the menus and messages displayed by the camera.
- VIDEO OUTPUT:** Select the video format used when the camera is connected to a television set or VCR.
- CARDFORMAT:** Format memory cards for use in the D1.

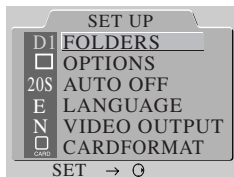

These options are described in detail on the pages that follow.

Folders

The FOLDERS submenu contains the following options:

- NEW:** Create a new folder
- D1 NC_D1:** Select for playback all folders created by the D1 (default)
- DCF ALL:** Select all folders conforming to the Design Rule for Camera File Systems (DCF) for playback.
- nnn* NC_D1:** Select only the current folder for playback (the number of the current folder is shown to the left of this menu item).

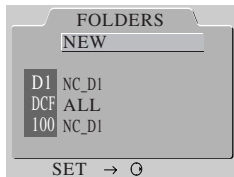

NEW

Create a folder with the folder name NC_D1 and a new folder number. Selecting NEW displays the dialog shown at right, where you can select a folder number by pressing the focus-area selector up or down. Press the selector to the right or press the **(ENTER)** button to create a new folder using the specified number; press the selector to the left or press the **(EXIT)** button to exit without creating a new folder.

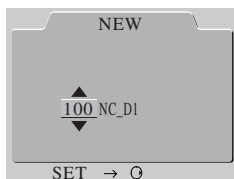

Photographs taken after a new folder is created will be stored in the new folder.

D1 NC_D1

Images in all folders created by the D1 will be displayed during playback. Images in folders created by other cameras are not displayed.

DCF ALL

When this option is selected, images in all folders that conform to the Design Rule for Camera File Systems can be viewed in playback mode.

nnn NC_D1 (*nnn* is the number of the current folder)

Only images in the current folder will be displayed during playback. The folder number of the current folder is shown to the left of the menu item.

Notes

Creating a new folder automatically resets the frame number display in the control panel on top of the camera to 1.

When creating new folders with the NEW command, the D1 only uses the last folder created to store all subsequent photographs. Thus, if you use the NEW option to create in succession the three folders "101 NC_D1," "102 NC_D1," and "103 NC_D1," the D1 will store images in the folder "103 NC_D1."

Remember that the current folder option "*nnn* NC_D1" will display only the images in the last folder created. To view or delete images in folders other than the current folder, select "D1 NC_D1" or "DCF ALL" from the FOLDERS menu.

Options

The OPTIONS submenu contains the following items:

HISTOGRAM: When this item is checked, a histogram is displayed when images are played back.

HIGHLIGHT: When this item is checked, highlights are indicated by a blinking display when images are played back.



To check or deselect items in the OPTIONS menu, highlight the item using the focus area selector and press the **(ENTER)** button.

HISTOGRAM

When this item is checked, a histogram is shown with images displayed in single-frame playback, capture preview, or record-and-review. The histogram shows the distribution of shadows, mid-tones, and highlights in the image. The horizontal axis corresponds to brightness, starting with black at the left end of the scale and shading through to white at the right end. The vertical axis shows the number of pixels of a given brightness in the image.

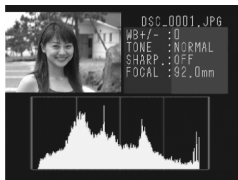

When the histogram is displayed, the playback screen also shows the image, reduced to occupy one-quarter of the monitor, together with photo information. In single-image playback, press the focus-area selector to the right or left to view more information on the current photograph (additional information is not available in capture-preview or record-and-review modes). In capture-preview mode, the scale of the histogram's horizontal axis is reduced by one half.

Note

Choosing a new setting in the OPTIONS submenu automatically changes the option selected for Custom Setting 27 in the current custom set (see "Custom Settings").

HIGHLIGHT

When this item is checked, the brightest portions of the image (image highlights) blink on and off. In capture-preview and record-and-review modes, the image and highlights are displayed separately, with both the image and the highlight display reduced to occupy one-quarter of the monitor. Additional photo information is not displayed when the focus selector is pressed to the left or right.



Both histogram and highlights can be displayed simultaneously.

Auto Off

The AUTO OFF submenu is used to set the length of time the camera will remain on in playback mode if no operations are performed. Highlight your choice using the focus-area selector, then press the **(ENTER)** button to put your choice into effect.

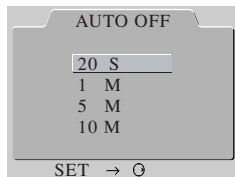

Language

The LANGUAGE submenu can be used to select the language for the playback menu from German (Deutsch), English, French (Français), and Japanese. Highlight the desired language using the focus area selector and press the **(ENTER)** button to put your choice into effect.



Notes

Choosing a new setting in the AUTO OFF submenu automatically changes the option selected for Custom Setting 18 in the current custom set (see "Custom Settings").

When the camera is connected to the AC adapter (available separately), the monitor will turn off automatically if no operations are performed for ten minutes. If the camera is connected to a television set, images will continue to be displayed on the television for ten minutes after the LCD monitor has turned off.

Video Output

The VIDEO OUTPUT submenu contains the following items:

- NTSC:** Select NTSC when connecting the camera to a television or VCR that complies with the NTSC standard
- PAL:** Select PAL when connecting the camera to a television or VCR that complies with the PAL standard

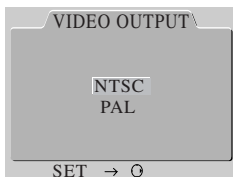

Card format

The CARDFORMAT option in the setup menu can be used to format memory cards for use in the D1. The card format menu is shown at right.

To format the memory card, highlight **FORMAT** using the focus area selector and press the **ENTER** button. *Note that formatting permanently deletes all files on the card, including those that are protected or hidden.* Be sure to back up any photographs you would like to keep.

To exit from the format menu without formatting the memory card, press the **ESC** button or highlight **NO** and press the **ENTER** button.



Tip

Memory cards can also be formatted by simultaneously pressing the **FORMAT** buttons. See "First Steps: Insert the Memory Card."

FLASH PHOTOGRAPHY

The D1 can be used with the SB-28DX (available separately) for sophisticated flash photographs using the D1's unique 3D multi-sensor balanced fill-flash control.

Through-the-Lens Flash Photography

When the SB-28DX Speedlight (available separately) is attached to the D1 and set to TTL (through-the-lens) mode, it automatically selects a flash mode designed for the D1 (TTL mode is only available when the SB-28DX is attached). The following settings are available:

3D multi-sensor balanced fill-flash for D1

Multi-sensor balanced fill-flash for D1

This mode is available when a CPU lens is attached. Matrix metering is used to balance flash output with ambient lighting for the main subject and background. When the shutter-release button is pressed, the SB-28DX emits a series of nearly invisible preflashes (monitor preflashes) that are reflected from objects in all areas of the frame and picked up by the camera's five-segment TTL multi sensor. This information is analyzed in combination with such data as the camera's sensitivity (ISO equivalency) setting, aperture, focal length, and exposure compensation value. Based on this information, the flash output level is automatically compensated to balance flash output with ambient light. When a D-Type lens is attached, distance information is added to the calculation for still more precise flash control (3D multi-sensor balanced fill-flash).

Center-weighted fill-flash for D1

This mode is used with non-CPU lenses. When a non-CPU lens is attached, the camera automatically chooses center-weighted metering, and consequently flash output is roughly balanced with ambient lighting for the main subject and background. If the frame includes a highly reflective object, or if the background is non-reflective, the camera may be unable to adjust exposure correctly. In such cases, standard TTL flash control can be used. Standard TTL flash is automatically selected when spot metering is used.

Standard TTL flash for D1

Standard TTL flash control is available with all lens types. Standard TTL flash control does not take the brightness of the background into account, but adjusts flash output so that the main subject is correctly exposed. This makes it suitable for photographs in which the main subject is emphasized at the expense of other details, or when you are using exposure compensation with flash photography. This mode is automatically selected when spot metering is used.

Accessory shoe

The SB-28DX, SB-28, SB-27, SB-26, SB-25, SB-24, SB-23, SB-22s, and SB-29 Speedlights can be attached directly to the accessory shoe without a sync cable. The shoe is equipped with a safety lock that keeps the Speedlight affixed to the camera when Speedlights provided with a locking pin (the SB-28DX, SB-28, SB-27, SB-26, SB-25, SB-22s, and SB-29) are attached.

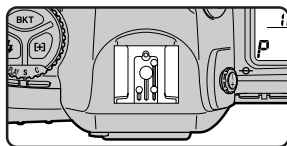

Sync terminal

A sync cable can be attached to the camera's sync terminal.

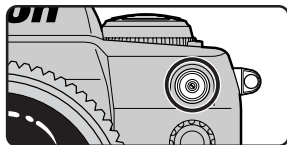

Flash-ready indicator

When the SB-28DX, SB-28, SB-27, SB-26, SB-25, SB-24, SB-23, SB-22s, and SB-29 Speedlights are connected, the flash-ready indicator lights up when the flash is fully charged and ready for use. If the flash-ready indicator blinks for about three seconds after a photograph is taken with a flash set to TTL or external automatic mode, the photograph may be underexposed. Check the photograph in the LCD monitor. If it is underexposed, adjust the focus distance, aperture, or flash range and try again.



Note

Do not attach a flash to the sync terminal when performing rear-curtain sync flash photography with a Speedlight attached to the accessory shoe.

Flash Sync Modes

Five sync modes are available:



Front-curtain sync: This mode is recommended in most situations. When using the SB-26, SB-25, or SB-24, set the sync mode selector on the Speedlight to NORMAL.



Slow sync: A lower shutter speed is used in programmed auto and aperture-priority auto exposure modes to bring out background details.



Rear-curtain sync: Use this mode to suggest motion by creating a stream of light that appears to follow moving objects. When this mode is combined with programmed auto or aperture-priority auto, shutter speed is slowed to achieve the same effect as slow sync. When using the SB-26, SB-25, or SB-24, set the Speedlight's sync mode selector to REAR.



Red-eye reduction: In this mode, a red-eye reduction pre-flash lights for approximately one second before the main flash, causing the pupils in your subjects' eyes to contract and reducing the "red-eye" effect a flash can sometimes cause.



Red-eye reduction with slow sync: This mode combines red-eye reduction with slow sync (available only with SB-28DX, SB-28, SB-27, and SB-26). Set the exposure mode to programmed auto or aperture-priority auto.

Notes

To prevent blurring caused by camera shake, use of a tripod is recommended with slow sync or red-eye reduction with slow sync.

Rear-curtain sync can not be used with a studio flash system.

When red-eye reduction is used, there is a one-second delay between your fully pressing the shutter-release button and the shutter being released. Be careful not to move the camera or to let your subject move during this time. Red-eye reduction works best when your subject is well within the range of the flash and is fully turned to face the camera.

To set the flash sync mode, hold down the flash mode button while turning the main command dial.

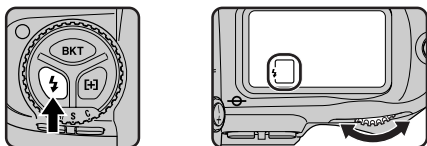

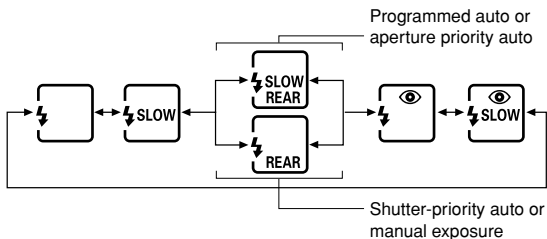

The camera will cycle through the available flash modes in the order shown below.



Compatible Speedlights

The D1 can be used with the Speedlights listed below.

Speedlight	Flash mode							
	TTL ¹		A	M			REAR	
	Balanced fill-flash	Standard TTL ²	Non-TTL auto	Manual	FP high-speed sync	Repeating flash	Rear-curtain sync	Red-eye reduction
SB-28DX (cordless)	✓ ³	✓	✓ ⁴	✓	✓	✓	✓	✓
SB-28 (cordless)	—	—	✓	✓	✓	✓	✓	✓
SB-27 (cordless)	—	—	✓ ⁵	✓	—	—	✓	✓
SB-26 ⁶ (cordless)	—	—	✓	✓	✓	✓	✓	✓
SB-25 (cordless)	—	—	✓	✓	✓	✓	✓	—
SB-24 (cordless)	—	—	✓	✓	—	✓	✓	—
SB-23, SB-21B ⁷ , SB-29 (cordless)	—	—	—	✓	—	✓	✓	—
SB-22S, SB-22, SB-20, SB-16B, SB-15 (cordless)	—	—	✓	✓	—	—	✓	—
SB-11 ⁸ , SB-14	—	—	✓	✓	—	—	✓	—

- 1 Can only be used when the SB-28DX is attached. When other Speedlights are attached and set to TTL, the shutter-release button will lock and no photographs can be taken.
- 2 When spot metering is used, this setting is treated as “standard TTL flash control” (see above).
- 3 The balanced fill-flash mode used depends on the lens. When a D-Type Nikkor lens (IX-Nikkor excepted) is attached, 3D multi-sensor balanced fill-flash is used. When a CPU lens (F3AF excepted) of a type other than type D is attached, multi-sensor balanced fill-flash is used. If a non-CPU lens is attached, center-weighted fill-flash is used.
- 4 The SB-28DX offers two auto modes: non-TTL Auto Flash (A) and Auto Aperture (AA). AA is used when a lens with a CPU (IX-Nikkor and F3AF excepted) is attached, A when another type of lens is attached.

- 5 When using an SB-27 with the D1, set the SB-27 to Forced A mode.
- 6 The SB-26 can be set to slave mode for wireless slave flash photography. When the wireless slave selector is set to D, shutter speed will be set to a value under $1/250$ sec.
- 7 Autofocus can only be used with the SB-21B or SB-29 when a AF-Micro lens (60mm, 105mm, 200mm) is attached.
- 8 When using the SB-11 or SB-14 in A or M mode, connect the SC-13 using the SU-2. While the SB-11 and SB-14 can be connected using the SC-11 or SC-15, the flash-ready indicator will not appear in the viewfinder display and shutter speed will not be adjusted automatically.

 **Important:** Use Nikon Speedlights only. Using another make of flash could damage the internal circuitry of the camera or flash. Before using a Nikon Speedlight other than listed above, contact a Nikon-authorized service representative for more information.

Notes

Refer to your Speedlight manual for detailed instructions. In the table of different camera types given in the SB-28DX manual, the D1 is classified as type A.

The shutter will synchronize with the flash when set to speeds of $1/500$ sec. or slower. When using the Medical Nikkor 120mm f/4 lens, set the shutter speed to $1/125$ sec. or slower.

If the flash-ready indicator blinks for about three seconds after a photograph is taken with the SB-28DX set to TTL, the photograph may be underexposed. Check the photograph in the LCD monitor. If it is underexposed, adjust the focus distance, aperture, or flash range and try again. This underexposure warning may not appear when a Speedlight other than the SB-28DX is used with a shutter speed of $1/500$ sec. If you find that images are underexposed even though no warning appeared in the viewfinder display, try setting the shutter speed to $1/250$ sec.

Sensitivity settings available for TTL flash photography are ISO 200, 400, 800, and 1600 equivalent. If sensitivity up (see "Custom Settings," item 31) is used, the flash may not produce appropriate lighting, depending on the aperture or distance to the subject.

In the case of Speedlights equipped with an AF-Assist Illuminator, the illuminator will only light when the center focus area is used.

When the exposure mode is set to programmed auto, the maximum aperture varies with sensitivity, as shown below:

Sensitivity (ISO equivalent)	200	400	800	1600
Maximum aperture	4.8	5.6	6.7	8

For each increase in sensitivity, aperture is stopped down by half a step. If the lens has a smaller maximum aperture than that given above, the maximum aperture will be the maximum aperture for the lens.

When flash exposure compensation is used,  appears in the viewfinder display, but the amount of compensation is not displayed.

Using a Speedlight

This section describes the steps involved in using a SB-28DX Speedlight for 3D multi-sensor balanced fill-flash photography.

- 1 After attaching the Speedlight, choose any metering method other than spot.
- 2 Choose an exposure mode and confirm shutter speed and aperture.
- 3 Choose a flash sync mode as described above under “Flash Sync Modes.”
- 4 Turn the Speedlight power switch to ON or STBY, and set the Speedlight mode to **DITTLK**.
DITTLK will appear in the Speedlight display.
- 5 Compose a picture, lightly press the shutter-release button, and check focus and flash charge in the viewfinder display.
- 6 After checking the flash range in the Speedlight display, press the shutter-release button all the way down to take a picture.

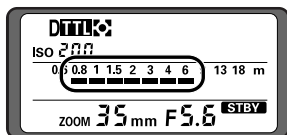
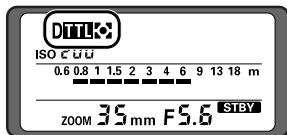

Notes

In shutter-priority auto and manual exposure modes, shutter speed can be set to a value between $1/500$ sec. and thirty seconds. If speed faster than $1/500$ sec. is chosen, the camera will automatically lower shutter speed to $1/500$ sec.

When using slow sync or slow sync with red-eye reduction, set the exposure mode to programmed auto or aperture-priority auto.

If the flash-ready indicator blinks for about three seconds after a photograph is taken with a flash set to TTL or external automatic mode, the photograph may be underexposed. Check the photograph in the LCD monitor. If it is underexposed, adjust the focus distance, aperture, or flash range and try again.

Read all instructions in the Speedlight manual thoroughly.

CONNECTIONS

This chapter describes how to connect the D1 to a computer, television set, or VCR.

Connecting to a Television or VCR

Using the EG-D1 video cable, you can connect the D1 to a television or video cassette recorder (VCR) to view images on the television screen or record them on tape. Follow these steps to play photographs back on a television set:

- 1 Open the cover protecting the camera's VIDEO OUT and DC IN connectors as shown below.

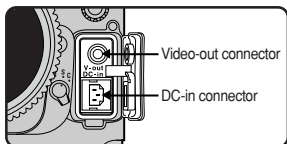
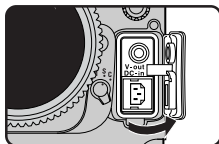

- 2 Connect the cable to the camera by inserting the black plug into the video-out jack as shown at right.



- 3 Connect the yellow plug to the VIDEO IN jack on the television or VCR.

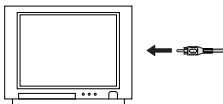

- 4 Tune the television to the video channel. The television will display whatever image is shown in the camera's LCD monitor.

Notes

The VIDEO OUTPUT item in the playback menu offers a choice of NTSC or PAL standards for video output. Select a standard that matches the one used in your television set. See "Playback: The Playback Menu."

While the camera is connected to a television set, all controls function normally and photographs can still be taken.

Video output is linked to the monitor button only when the mode dial is set to PLAY (playback). In other modes, the television will continue to display images even when the LCD monitor is off.

When the camera is powered by the EH-4 AC adapter (available separately), the monitor will turn off if no operations are performed for ten minutes. Images will continue to be displayed on the television for another ten minutes.

Connecting to a Computer

The D1 can be connected directly to a computer via its IEEE 1394 interface, when images can be transferred to the computer using *Nikon View DX* or *Nikon Capture* software (available separately). Using *Nikon Capture*, you can control your camera from your computer for advanced studio photography.

- 1 After checking that the camera is off, open the cover protecting the camera's IEEE 1394 connector and connect a six-pin, IEEE 1394 cable (available separately) to the camera.

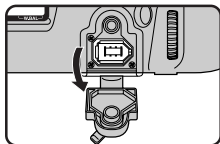

- 2 Check that the other end of the cable is connected to your computer's IEEE 1394 connector. For information on connecting IEEE 1394 peripherals to your computer, refer to the documentation provided with your computer, or with your IEEE 1394 card or expansion board.

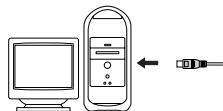

- 3 Turn the camera on. Then, holding down the mode dial lock release, turn the mode dial to **PC** (PC mode).

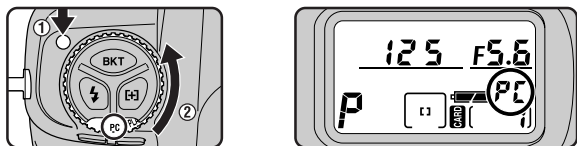

If the camera is properly connected and *Nikon Capture* is running on your computer, the letters “PC” will be displayed in the control panel on top of the camera (“PC” is not displayed when *Nikon View DX* is running). Refer to your software manual for information concerning the operations that can be performed while the camera is connected to a computer.

If the camera is not connected to a computer, or if it is connected when neither *Nikon View DX* nor *Nikon Capture* is installed, the camera will function as it would in single-frame shooting or continuous shooting modes. The only differences are that the frame advance mode (single or continuous) is set using Custom Setting item 30, and that photographs are not displayed on the monitor in capture-preview mode, record-and-review mode, or in single-image playback.

- 4 Before disconnecting the IEEE 1394 cable from the camera, turn the camera off. Do not turn the camera off or disconnect the camera when data transfer is in progress.

Notes

Do not use the camera with the computer while battery power is low or the batteries are exhausted. If the battery indicator changes to low or starts to flash while the camera and computer are connected, wait for data transfer to terminate, then disconnect the camera and replace the batteries or connect the EH-4 AC adapter (sold separately).

It is recommended that the camera be powered by the EH-4 AC adapter (available separately) when you are using the Nikon digital camera D1 with *Nikon View DX*. When using an EN-4 battery pack, be aware that leaving the camera connected when the battery is exhausted may shorten battery life. Should the battery become exhausted, insert a fully charged spare battery without delay or disconnect the camera from the computer. The amount of charge remaining is shown by the battery indicator in the control panel on top of the camera.

Only photographs that conform to the Design Rule for Camera File Systems (DCF) can be transferred from the camera to the computer in PC mode while *Nikon Capture* is running on the computer.

Reading Photographs from Memory Cards

Photographs stored on the memory card can be viewed on a computer by removing the memory card from the camera and reading it using a CompactFlash (CF) card reader or PC card adapter.

To read the memory cards, you will need:

- a PC or Macintosh computer, and
- either a CF card reader or, if your computer is equipped with a PCMCIA Type II or Type III card slot, an EC-AD1 PC-card adapter (available separately from Nikon).

Using a CF Card Reader

The steps involved in connecting a CF card reader and inserting memory cards may be found in the documentation provided with your card reader. Once the card has been inserted, it will function as a disk, as described in Step 3 of “Using a PCMCIA Card Slot,” below.

Using a PCMCIA Card Slot

- 1 To read CompactFlash cards using a PCMCIA Type II or Type III card slot, insert the card into a PC card adapter as shown below.

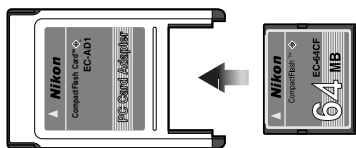

- 2 Insert the adapter into the PC card slot as instructed in the documentation provided with your computer or PC card drive.

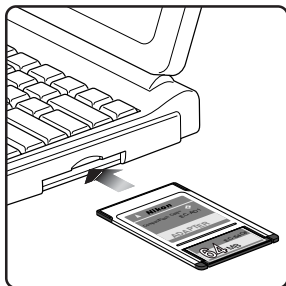

- 3 The card will now function as a disk. Photographs may be found within the folder DCIM in the card's root directory, stored in the folder named nnnNC_D1, where "nnn" is the number shown at the top right corner of the photograph when it is played back on the camera. Photos recorded at an image quality setting of FINE, NORMAL, or BASIC can be viewed in any application that supports the JPEG format. To read photographs recorded at a setting of HI RGB-TIFF, you will need an application that can read TIFF files. RAW and YCbCr TIFF files can only be viewed using *Nikon View DX* or *Nikon Capture* (available separately).

Tips

You can use *Nikon View DX* to browse photographs on a memory card in the same fashion as when the camera is connected to your computer directly. See the *Nikon View DX* reference manual for details.

The D1 can read and play back only those images that conform to the Design Rule for Camera File Systems (DCF). It may not be able to read JPEG or TIFF files created by a computer or by another make of camera. It may also not be able to read camera files that have been renamed or moved to a different folder using a computer.

TECHNICAL NOTES

This chapter contains information on optional accessories, camera care, troubleshooting, and camera specifications.

Replacing the Focusing Screen

The D1 is supplied with a type B BriteView focusing screen.

To change focusing screens:

- 1 After turning the camera off, remove the lens from the camera body (A) and, using the tweezers supplied with the focusing screen, pull the focusing screen latch towards you (B). The screen holder will spring open.

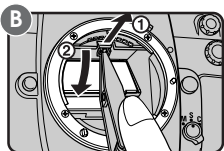
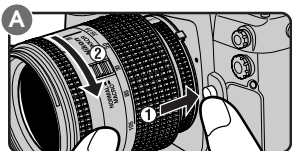

- 2 Grasp the screen tab with the tweezers and remove the screen (A). Holding the tab on the replacement screen in the tweezers, set the replacement screen in the holder (B).

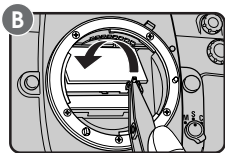
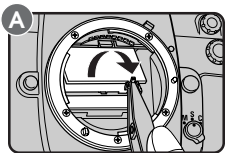

- 3 Using the tweezers, push the front edge of the holder upward until it clicks into place.

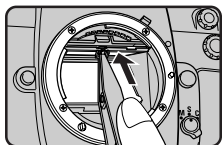

Notes

Do not touch the camera mirror or the surface of the focusing screens.
Use only screens designated for use in the D1 or the Nikon F100 film camera.

Compatible Lenses

CPU lenses are recommended for use in the D1. D-Type lenses are particularly recommended, as you will have access to the complete range of camera functions only when a D-Type lens is attached. The following lenses can be used with the D1.

Lens		Focusing		Exposure mode				Exposure metering mode		
		Auto-focus	Manual with electronic rangefinder	P	S	A	M	Matrix	Center-weighted	Spot
CPU Lenses	D-Type AF Nikkor, AF-S, AF-I Nikkor	✓	✓	✓	✓	✓	✓	✓ (3D Color)	✓	✓ ¹
	PC Micro Nikkor 85mm F2.8D	—	✓ ²	—	—	—	✓ ³	✓ ³ (3D Color)	✓ ³	✓ ^{1, 3}
	AF-I Teleconverter ⁴	✓ ⁵	✓ ⁵	✓	✓	✓	✓	✓ (3D Color)	✓	✓ ¹
	Non D-type AF Nikkor (except lenses for F3AF)	✓	✓	✓	✓	✓	✓	✓ (Color)	✓	✓ ¹
	AI-P Nikkor	—	✓ ⁶	✓	✓	✓	✓	✓ (Color)	✓	✓
Non-CPU Lenses	AI-type Nikkor	—	✓ ⁶	—	—	✓	✓	—	✓	✓
	AI-modified Nikkor	—	✓ ⁶	—	—	—	✓	—	—	—
	Reflex-Nikkor ⁷	—	—	—	—	✓	✓	—	✓	✓
	PC-Nikkor ⁷	—	✓ ²	—	—	✓ ⁸	✓ ⁹	—	✓ ⁸	✓ ⁸
	AI-type Teleconverter	—	✓ ⁵	—	—	✓	✓	—	✓ ¹⁰	✓ ¹⁰
	Bellows Focusing Attachment PB-6 ¹¹	—	✓ ⁵	—	—	✓ ¹²	✓ ¹²	—	✓	✓
	Auto extension rings (PK 11A, 12, 13, PN-11)	—	✓ ⁵	—	—	✓	✓	—	✓	✓

Note

When using a lens without a built-in CPU:

Choose center-weighted or spot metering, and an exposure mode of aperture-priority auto or manual. When an exposure mode of programmed auto or shutter-priority auto is selected, the camera will automatically be set to aperture-priority auto with center-weighted metering, and the exposure-mode indicator (**P** or **S**) in the control panel on top of the camera will blink (the viewfinder display will show **A**). Regardless of the exposure mode, aperture can only be set using the lens aperture ring; turning the sub-command dial has no effect. **F--** will appear in the aperture indicators in the viewfinder and the control panel on top of the camera.

- 1 Metering area corresponds to selected focus area (see "Camera Settings: Metering").
- 2 Without shifting and/or tilting.
- 3 The camera's exposure metering and flash control system do not work properly when shifting and/or tilting the lens, or when an aperture other than the maximum aperture is used.
- 4 Compatible with all AF-S and AF-I Nikkor lenses except the AF-S 17–35 mm f/2.8D IF-ED and AF-S 28–70 mm f/2.8D IF-ED.
- 5 With maximum effective aperture of f/5.6 or faster.
- 6 With maximum aperture of f/5.6 or faster.
- 7 Some lenses can not be used (see below).
- 8 Exposure determined by presetting lens aperture. AE lock must also be performed before shifting.
- 9 Exposure determined by presetting lens aperture. Exposure must also be determined before shifting.
- 10 Exposure compensation required with some lenses (refer to instruction manual provided with teleconverter).
- 11 Auto Extension Ring PK-11A, 12, or 13 required.
- 12 Exposure determined by presetting lens aperture on bellows. Release shutter after exposure metering.



Nikkor lenses that can NOT be used with the D1

The following Nikkor lenses can not be used with the D1:

- TC-16A AF Teleconverter
- Non-AI lenses
- Lenses that require the AU-1 focusing unit (400mm f/4.5, 600mm f/5.6, 800mm f/8, 1200mm f/11)
- Fisheye (6mm f/5.6, 8mm f/8, OP10mm f/5.6)
- 21mm f/4 (old type)
- K2 ring
- ED 180–600mm f/8 (serial numbers 174041–174180)
- ED 360–1200mm f/8 (serial numbers 174031–174127)
- 200–600mm f/9.5 (serial numbers 280001–300490)
- Lenses for the F3AF (80mm f/2.8, 200mm f/3.5, TC-16S Teleconverter)
- PC 28mm f/4 (serial number 180900 or earlier)
- PC 35mm f/2.8 (serial numbers 851001–906200)
- PC 35mm f3.5 (old type)
- 1000mm f/6.3 Reflex (old type)
- 1000mm f/11 Reflex (serial numbers 142361–143000)
- 2000mm f/11 Reflex (serial numbers 200111–200310)

Identifying D-Type Nikkor Lenses with a Built-in CPU

D-Type Nikkor lenses with a built-in CPU can be identified by the CPU contacts (A) and the “D” mark on the lens (B).

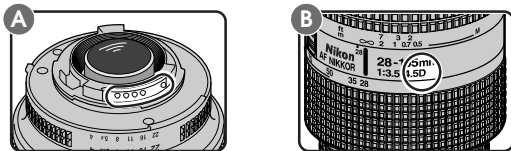

Lens Focal Length and Picture Angle

The size of the area exposed with a 35mm camera is 24×36 mm. In the case of the D1, however, it is 15.6×23.7 mm. Consequently, the picture angle of photographs taken with the D1 will differ from the picture angle for 35mm cameras, even when the focal length of the lens and the distance to the subject are the same.

The diagonal picture angle of a 35mm camera is roughly 1.5 times that of the D1. Consequently when a lens of a given focal length is attached to the D1, the corresponding focal length in 35mm format at the D1's picture angle can be calculated by multiplying the focal length of the lens by 1.5. The following chart shows some examples:

Picture angle	Focal length (mm) in 35mm format modified for picture angle							
	35mm camera	17	20	24	28	35	50	60
D1	25.5	30	36	42	52.5	75	90	127.5

Picture angle	Focal length (mm) in 35mm format modified for picture angle							
	35mm camera	105	135	180	200	300	400	500
D1	157.5	202.5	270	300	450	600	750	900

Tip

“Picture angle”

Picture angle determines how much of the subject appears in the final photograph.

Cleaning the CCD

The charged-coupled device (CCD) that serves as the D1's picture element is fitted with a low-pass filter to prevent moiré. While this filter prevents dirt from getting onto the CCD, any dirt or dust that finds its way onto the filter may, depending on shooting conditions, appear in photographs taken with the camera. In this case you will need to clean the filter.

The low-pass filter is extremely delicate and is easily damaged. It is recommended that you have it cleaned by Nikon-authorized service personnel.

How to tell when the filter needs cleaning (I)

- 1 Set the exposure mode to programmed auto (**P**) or aperture-priority auto (**A**) and choose the smallest aperture setting (largest f-number).
- 2 Take a picture of an evenly-colored, white object, such as a clean, white-colored wall. Load the photograph onto a computer and examine it on the computer monitor. If the photograph contains dark specks or lines, you will need to have the filter cleaned at a Nikon-authorized service center or clean it yourself as described below.

How to tell when the filter needs cleaning (II)

- 1 The EH-4 AC adapter (available separately) is required for this method. Turn the camera off and connect the AC adapter.
- 2 Remove the lens and turn the camera on.
- 3 Keeping the **CSM** button held down, turn the main command dial to select Custom Setting 8, then turn the sub-command dial to select option 1. The mirror will be raised to the up position and the shutter curtain will open.

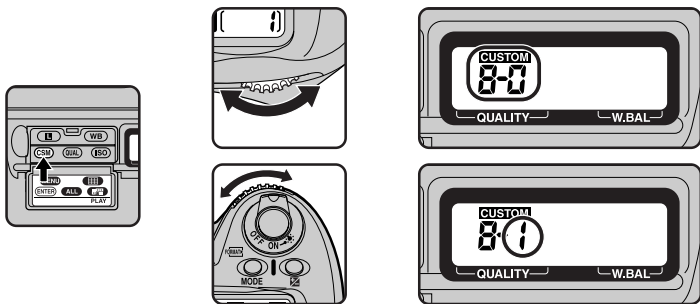

- 4** Holding the camera so that light falls on the low-pass filter, examine it for dust or dirt. If you should find a foreign object on the filter, have it cleaned at a Nikon-authorized service center or clean it yourself as described below. If there is no dirt on the filter, hold the **CSM** button down and turn the main command dial to select Custom Setting 8, then turn the sub-command dial to select option 0. The mirror will return to the down position and the shutter curtain will close.

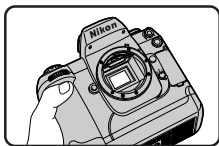

Cleaning the filter

- 1** Raise the camera mirror as described in steps 1–3 of “How to tell when the filter needs cleaning (II).” Note that the EH-4 AC adapter (available separately) is required to perform this operation; if you do not have an AC adapter, you will need to take the camera to a Nikon-authorized service center for cleaning.
- 2** Remove dirt and dust from the filter with a blower. Do not use a blower-brush, as the brush bristles can damage the filter. If you are using an aerosol blower, hold the can upright to prevent liquid from the blower falling on the filter. Dirt that can not be removed with a blower can only be removed by Nikon-authorized service personnel. Under no circumstances should you touch or wipe the filter.
- 3** Keeping the **CSM** button held down, turn the main command dial to select Custom Setting 8, then turn the sub-command dial to select option 0. The mirror will return to the down position and the shutter curtain will close.
- 4** Turn the camera off and replace the lens or body cover, then unplug the AC adapter.

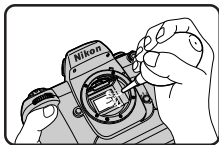

Optional Accessories

At the time of writing, the following accessories were available for the D1:

EN-4 Rechargeable Battery Pack

The EN-4 is a rechargeable nickel-metal hydride (Ni-MH) battery pack designed exclusively for use in the D1.

MH-16 Quick-Charger

The MH-16 can be used to recharge EN-4 battery packs.

EH-4 AC Adapter

The EH-4 can be used with AC power sources of 100–120V or 220–240V and 50–60 Hz. Separate power cables are available for use in North America, the United Kingdom, Europe, Australia, and Japan.

Optional Lenses

A variety of AF Nikkor lenses, including wideangle, telephoto, zoom, micro, defocus image control (DC) or regular lenses, with focal lengths of 16–600mm, are available for the D1.

EC-CF CompactFlash Memory Cards

64MB and 96MB EC-CF CompactFlash memory cards are available for the D1. In addition, the CompactFlash memory cards listed below have been tested and approved for use in the D1 digital camera. Operation is not guaranteed with other CompactFlash memory cards.

- SanDisk SDCFB-4, SDCFB-8, SDCFB-15, SDCFB-30, SDCFB-40, SDCFB-48, SDCFB-64, and SDCFB-96 CompactFlash memory cards

Contact the manufacturer for more information on the above memory cards.

EC-AD1 PC Card Adapter

Using the PC card adapter, CompactFlash memory cards can be read by computers equipped with PCMCIA card slots configured for ATA memory cards.

DK-14 Antifog Finder Eyepiece

This viewfinder eyepiece prevents fogging in humid or cold conditions.

DK-2 Rubber Eye Cup

Prevents eye fatigue by making it easier to see the image in the viewfinder.

Eyepiece Correction Lenses

To accommodate individual differences in vision, five types of viewfinder lenses are available with diopters of -3 , -2 , 0 , $+1$, and $+2$.

DR-4 Right-Angle Viewing Attachment/DK-7 Eyepiece Adapter

The DR-4 attaches at a right angle to the viewfinder eyepiece, allowing you to view the image in the viewfinder from above. The DK-7 is used when attaching the DR-3 Right-Angle Viewing Attachment or the DG-2 Eyepiece Magnifier to the D1.

Filters

Nikon filters can be divided into three types: screw-in, drop-in and rear-interchange. With the exception of the R60, exposure compensation need not be adjusted when a Nikon filter is attached (in the case of the R60, set exposure compensation to $+1$). Filters manufactured by other makers may interfere with autofocus or electronic rangefinding.

The D1 can not be used with Polar polarizing filters. Use the C-PL circular polarizing filter instead.

If you are using a filter to protect the lens, it is recommended that you use an NC or L37C filter.

When shooting with a filter attached, moiré may be observed when shooting a subject against a bright light, or when a strong light source is in the frame. In these conditions, it is recommended that you remove the filter before shooting.

Nikon SB-28DX Speedlight

This Speedlight has a guide number of 36 (manual mode, 35mm zoom-head position, ISO 100 m, 20°C [68°F]) and is powered by four alkaline batteries. Other power sources (available separately) that can be used with the SB-28DX include newer models of the SD-6, -7, SK-6, and the SK-6A and SD-8A. Note, however, that older models of the SD-6, -7, SK-6, and the SD-8 are not compatible with the SB-28DX. The SC-16A power cord supplied with newer models of the SD-6, -7 units is available for separate purchase, and can be used to connect older models to the SB-28DX. The SD-6, -7 and SK-6 are not available in Europe. The SK-6A is available only in Europe.

Accessories for the Remote Terminal

The D1 is equipped with a ten-pin remote terminal for remote-control photography, automatic photography, and connection to other devices. The terminal is provided with a cap, which protects the contacts when the terminal is not in use. The following accessories can be connected:

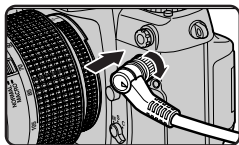

MC-20 Remote Cord (80cm/2.6'): Remote shutter release; can be used to reduce camera shake. It is equipped with time-exposure and timer features, emitting a beep once a second while the shutter is open.

MC-21 Extension Cord (3m/9.8'): Can be connected to the MC-20, MC-22, MC-25, or MC-30.

MC-22 Remote Cord (1m/3.3'): Remote shutter release with blue, yellow, and black terminals for connection to a remote shutter-triggering device, making it possible to control the camera via sound or electronic signals.

MC-25 Adapter Cord (20cm/0.7'): Ten-pin to two-pin adapter cord for connection to the MW-2 Radio Control Set, the MT-2 Intervalometer, the ML-2 Modulite Control Set, and other devices with two-pin terminals.

MC-30 Remote Cord (80cm/2.6'): Remote shutter release; can be used to reduce camera shake. Can be used to lock the shutter-release button during a time exposure.

ML-2 Modulite Remote Control Set: Allows infrared remote control with a range of up to 100m (328'). Remote control over greater distances can be achieved with multiple units. Requires MC-25 Adapter Cord.

ML-3 Modulite Remote Control Set: Allows infrared remote control with a range of up to 8m (26.2').

Software

Two software packages are available for the D1: *Nikon View DX*, which allows you to browse the contents of the camera's memory when the camera is connected to the computer via its IEEE 1394 interface, and *Nikon Capture*, which offers remote control and image enhancement features. Both packages are available in Windows and Macintosh versions; system requirements are given below.

Nikon View DX



	for Windows	for Macintosh
OS	Microsoft Windows 95, Windows 98, Windows NT 4.0 or later	Mac OS 8.6 or later
CPU	Pentium II, Celeron or higher	Power PC G3 or higher
Memory	16MB minimum (over 32MB recommended)	16MB minimum (over 32MB recommended)
Video	VGA (640 × 480 pixels) with 16-bit color or higher	VGA (640 × 480 pixels) with 16-bit color or higher
IEEE1394	Adaptec AHA-8920/8945, HotConnect V1.1 or later	Built-in IEEE 1394 interface or Adaptec AHA-8945
Other	CD-ROM drive 40 MB or more free hard-disk space when <i>Nikon View DX</i> is running (100 MB or more recommended)	CD-ROM drive 40 MB or more free hard-disk space when <i>Nikon View DX</i> is running (100 MB or more recommended)

Nikon Capture

	for Windows	for Macintosh
OS	Microsoft Windows 95, Windows 98, Windows NT 4.0 or later	Mac OS 8.6 or later
CPU	Pentium II, Celeron or higher	Power PC G3 or higher
Memory	64MB minimum (over 128MB recommended)	32MB minimum (over 64MB recommended)
Video	VGA (640 × 480 pixels) with 16-bit color or higher	VGA (640 × 480 pixels) with 16-bit color or higher
IEEE1394	Adaptec AHA-8920/8945, HotConnect V1.1 or later	Built-in IEEE 1394 interface or Adaptec AHA-8945
Other	CD-ROM drive 40 MB or more free hard-disk space when <i>Nikon Capture</i> is running (200 MB or more recommended)	CD-ROM drive 40 MB or more free hard-disk space when <i>Nikon Capture</i> is running (200 MB or more recommended)

Troubleshooting

Should any of the following indicators appear in the viewfinder or control panel displays, check the list below before consulting your retailer or Nikon representative.

Indication		Problem	Solution	See also
Control panel	Viewfinder			
FEE (blinking)	FEE (blinking)	Lens aperture ring is not set to smallest aperture.	Set ring to smallest aperture (largest f-number).	pg. 6
	†	Low battery.	Ready spare, fully charged battery.	pg. 5
	††	Battery exhausted.	Replace battery.	pg. 5
F--	F--	Lens not attached, or attached lens not Nikkor lens with built-in CPU.	Use Nikkor lens (IX Nikkor excepted) with built-in CPU, or set camera exposure mode to A or M and adjust aperture with lens aperture ring.	pg. 6 pg. 109
	 (blinking)	Camera can not focus.	Focus manually.	pg. 20 pg. 40

† Indicators in viewfinder turn off when no button is pressed.

†† Indicators in viewfinder and rear control panel turn off.

Indication		Problem	Solution	See also
Control panel	Viewfinder			
HI	HI	Subject too bright; photo will be overexposed.	Exposure mode: P use ND filter S increase shutter speed; if indication persists, use ND filter A use smaller aperture (higher f-number); if indication persists, use ND filter	pg. 20 pp. 43 –46
Lo	Lo	Subject too dark; photo will be underexposed.	Exposure mode: P use flash S lower shutter speed; if indication persists, use flash A use larger aperture (lower f-number); if indication persists, use flash	pg. 20 pg. 97 pg. 43 pg. 45
bulb (blinking)	bulb (blinking)	Shutter speed set to bulb (long time exposure) in shutter-priority	Switch to manual exposure mode or use another shutter speed.	pg. 43 pg. 47
P or S (blinking)	A (blinking)	Programmed auto or shutter-priority auto selected with no lens in place or with lens other than CPU Nikkor in place.	Attach Nikkor lens with built-in CPU or select manual or aperture-priority auto.	pg. 6 pp. 45 –48
Shutter speed (blinking)	500 (blinking)	Shutter speed faster than lens sync speed (shutter-priority auto or manual exposure modes)	Shutter speed automatically set to $1/500$ sec.	pg. 100
	 (blinking)	If flash-ready lamp blinks for three seconds after flash, photo may be underexposed.	Check photo in LCD monitor. If underexposed, adjust shutter-speed, aperture, or flash range and try again.	pg. 100

Indication		Problem	Solution	See also
Control panel	Viewfinder			
Err	Err	Camera malfunction.	Release shutter. If indication persists or appears frequently, take camera to Nikon-authorized service center for inspection.	
		Red-eye reduction or slow sync with red-eye reduction selected with flash that does not support red-eye reduction.	Choose different sync mode or use flash that supports red-eye reduction.	pg. 98

Error Messages

When there is a problem with the flash-memory card or with the camera's internal programming and circuitry, an error message will appear superimposed on the image in the LCD monitor. Below is a list of error messages that may be displayed by the D1 and the steps that should be taken to deal with them.

LCD Monitor	Control panel	Action
NO CARD PRESENT	(-E-)	The camera can not detect a flash-memory card. Turn the mode dial to OFF and confirm that the flash-memory card has been correctly inserted in the camera as described in "First Steps: Insert the Memory Card."
THIS CARD CAN NOT BE USED	-(ERR)-	The camera can not access the memory card, all available file numbers have been used, or the card is not correctly formatted. Replace the card with a Nikon-authorized memory card.
CARD IS NOT FORMATTED	(For)	The card has not been formatted for use in the D1. Format the card as instructed in "First Steps: Insert the Memory Card," or replace the card with a correctly formatted CompactFlash memory card.
CARD CONTAINS NO IMAGES	()	Card is full. No further photographs can be taken until images have been deleted from the card as described in "Playback."
	()	This error occurs in playback mode when the current folder contains no images. Select a different folder from the FOLDERS menu. You will not be able to play back photos until at least one photo has been recorded on the card, although the camera will function normally in other respects.



LCD Monitor	Control panel	Solution
<p>ALL IMAGES ARE HIDDEN</p>	<p>()</p>	<p>This error appears when you attempt to play back images after all photographs in the current folder have been hidden using HIDE IMAGE. It will not be possible to play back or delete images until you have chosen a different folder or used HIDE IMAGE to allow at least one image to be displayed (see “Playback”).</p>
<p>FILE CONTAINS NO IMAGE DATA</p>		<p>A computer has overwritten a photograph on the flash memory card and the file can no longer be displayed in playback mode. Delete the photograph as described in “Playback” or reformat the card (see “First Steps: Insert the Memory Card”) after backing up all photographs you would like to keep.</p>

Specifications

Type:	Single-lens reflex digital camera with interchangeable lenses
Operating environment	
Temperature:	0 – 40°C (32 – 104°F)
Humidity:	Less than 85% (no condensation)
Image sensor:	23.7 × 15.6 mm, 12-bit RGB CCD with 2.7 million pixels, effective pixel count 2.66 million pixels (2,012 × 1,324 pixels)
Image size:	2,000 × 1,312 pixels
Sensitivity:	200, 400, 800, 1600 (ISO equivalent)
Storage	
Compression:	JPEG baseline-compliant (approximate compression ratios 1:4, 1:8, 1:16); uncompressed files recorded as YCbCr-TIFF (8-bit), RGB-TIFF (8-bit), or RAW data (12-bit)
File system:	Design Rule for Camera File Systems, Digital Print-Order Format (DPOF) compliant
Media:	CompactFlash card (Type I/II)
Capacity:	Approx. 66 images at an image quality of FINE, 132 images at NORMAL, 265 images at BASIC, 18 images at HI/YCbCr-TIFF, 12 images at HI/RGB-TIFF, 23 images at HI/RAW (all figures for 96 MB memory card)
Operating modes:	S (single frame shooting, capture-preview and record-and-review modes available) C (continuous shooting, approx. 4.5 fps, max. 21 consecutive shots) ⌚ (self-timer mode; delay can be specified by user) PLAY (playback mode with playback menu) PC (data transfer mode; camera can be controlled from computer)
White balance:	Auto (TTL control with 1,005-pixel CCD) Six manual modes, adjustable from -3 to +3 in 7 steps Preset
LCD monitor:	2-inch, low temperature polysilicon TFT, 114,000 pixels, adjustable brightness The left and right edges of photographs are not shown when the photographs are displayed in the LCD monitor
Playback function:	Single-frame playback, thumbnail playback (9 images), slideshow, histogram, and highlight point display
Delete function:	Card format, delete all images, delete selected images
Video output:	NTSC or PAL (selectable)
External interface:	IEEE 1394 (400Mbps)

Exposure modes:	P (programmed auto with flexible program) S (shutter-priority auto) A (aperture-priority auto) M (manual)
Image size:	24 × 36 mm
Lens mount:	Nikon F mount (with AF coupling and AF contacts)
Lenses:	Type-D AF Nikkor lenses (excluding IX Nikkor)—all functions supported Other type-D Nikkor lenses —all functions except autofocus supported Other AF Nikkor lenses (excluding F3AF)—all functions except 3D color matrix metering and 3D multi-sensor balanced fill-flash for D1 supported AI-P Nikkor lenses —all functions except 3D color matrix metering, 3D multi-sensor balanced fill-flash for D1, and autofocus supported Other lenses can be used in aperture-priority or manual mode with center-weighted or spot metering; electronic rangefinder can be used with lenses with a maximum aperture of f/5.6 or faster.
Picture angle:	35mm format equivalent to 1.5 times focal length of lens.
Viewfinder	
Type:	Optical fixed eye-level pentaprism with diopter adjustment of -3 to +1 DP, equipped with eyepiece shutter
Eyepoint:	22 mm (at -1.0 DP)
Focusing screen:	Type B BriteView clear matte screen Mark III
Frame coverage:	Approx. 96% of lens
Magnification:	0.8 × with 50 mm lens set to infinity and -1.0 DP
Information:	Focus indicators, shutter speed, aperture, exposure mode, metering, shutter-speed lock, aperture lock, AE lock, electronic analog display, frame counter, ready light, five sets of focus brackets (areas)
Reflex mirror:	Quick-return
Lens aperture:	Instant return with depth-of-field preview
Autofocus:	TTL phase detection by means of Nikon Multi-CAM1300 autofocus module; detection range -1 to 19 EV (ISO 100 at room temperature)
Lens servo:	Single-servo AF (S), Continuous-servo AF (C), manual (M); focus tracking automatically activated according to subject status in single-servo and continuous-servo AF
Focus area:	Focus area can be selected from five focus areas
AF-area mode:	Single-area AF, Dynamic AF (supports closest subject priority)
Focus lock:	Focus can be locked using the AE/AF lock button or, in single-servo AF, by pressing the shutter-release button half way

Metering:	TTL full-aperture exposure metering system with three metering modes
3D color matrix:	3D color matrix metering using 1,005-pixel CCD supported when D-Type Nikkor lens is attached; with other lenses, color matrix metering using 1,005-pixel CCD is supported
Center-weighted:	Greatest weight (75% of total) given to a circle in the center of the frame 8 mm in diameter
Spot:	Exposure determined by 4 mm circle in center of frame (approx. 2% of frame); when a CPU Nikkor lens is attached, any of the five focus areas can be used for spot metering
Exposure range:	At ISO 100, room temperature, and with f/1.4 lens, 0–20 EV (center-weighted and 3D color matrix metering) or 2–20 EV (spot metering)
Metering coupling:	Combined CPU and AI
Exposure compensation:	–5 to +5 EV in increments of $\frac{1}{3}$ EV; exposure compensation indicator appears in viewfinder and top control panel
Auto-exposure lock:	Detected exposure locked when AE/AF lock button is pressed
Auto bracketing:	Two or three exposures with compensation in increments of $\frac{1}{3}$, $\frac{1}{2}$, or 1 EV
Shutter:	Combined electronic (CCD) and mechanical shutter
Speed:	30– $\frac{1}{16,000}$ sec. ($\frac{1}{3}$ increments), long time exposure (bulb)
Speedlight	
Sync contact:	X-contact only; flash synchronization at shutter speeds of $\frac{1}{500}$ sec. or slower.
Flash control:	(1) Automatic balanced fill-flash controlled by five-segment TTL multi-sensor with single-component IC. If SB-28DX Speedlight is combined with a D-Type AF-Nikkor lens, 3D multi-sensor balanced fill-flash for D1 is used. If the SB-28DX is combined with AI-P or AF Nikkor lens other than D-Type, multi-sensor balanced fill-flash for D1 is used. If the SB-28DX is combined with a non-CPU Nikkor lens, balanced TTL flash for the D1 can be used with center-weighted metering. (2) Auto aperture (AA) flash: supported with SB-28DX and CPU Nikkor lenses (3) Non-TTL auto flash: supported with SB-28, SB-27, and SB-22s Speedlights
Flash sync modes:	Front curtain (normal) sync, red-eye reduction, red-eye reduction with slow sync, rear curtain
Ready light:	Lights when flash SB-28DX, SB-28, SB-27, or SB-22s is fully charged; blinks for three seconds after being fired at full output
Accessory shoe:	Standard ISO hot-shoe contact with safety lock
Sync terminal:	Standard JIS terminal with locking screw
Self timer:	Electronically controlled timer, duration 2–20 seconds

- Depth-of-field preview:** Lens aperture can be stopped down by pressing depth-of-field preview button
- Top control panel:** Display includes shutter-speed lock indicator, shutter speed, exposure compensation, date, aperture lock indicator, aperture, operating mode, clock-battery indicator, exposure compensation indicator, auto bracketing indicator, exposure indicator, exposure mode, flexible program indicator, flash sync mode, AF area mode, focus area, battery indicator, frame count, number of exposures remaining, card indicator
- Rear control panel:** Display includes custom-settings indicator, B&W indicator, sensitivity, custom setting, file type, number of exposures remaining, image quality, sensitivity indicator, monitor indicator, white-balance mode, card indicator
- Remote control:** Remote control via 10-pin remote terminal or IEEE 1394 interface (400 Mbps)
- Power source:** EN-4 Ni-MH Battery Pack, 7.2 V DC (can be recharged with optional MH-16 or MH-15 Quick Chargers); EH-4 AC adapter (sold separately), 100–240 V AC
- Power switch:** Includes LCD illuminator switch
- Exposure meters:** Turn off automatically if no operation performed for six seconds; can be re-activated by lightly pressing the shutter-release button or by pressing the AF-ON button.
- Battery indicators:**  (battery fully charged),  (low battery),  (battery exhausted); if no indicators appear, batteries are completely exhausted or improperly installed
- Tripod socket:** 1/4 in. (JIS standard)
- Custom settings:** 32 settings from 0–31 available (see “Custom Settings”)
- Two-button reset:** Settings restored to defaults by pressing CSM and ISO buttons simultaneously (some settings not restored)
- Dimensions:** Approx. 157 (W) × 153 (H) × 86 (D) mm (6.2 × 6.1 × 3.4 in.)
- Weight:** Approx. 1.1 kg (2.5 lbs.) without batteries
- Accessories:** EG-D1 video cable, BF-1A body cap, monitor cover, AN-D1 camera strap
- Options:** EN-4 Ni-MH Battery Pack, MH-16 Quick Charger, EH-4 AC Adapter, CompactFlash memory cards, EC-AD1 PC card adapter, SB-28DX Speedlight, SC-D1 IEEE 1394 cable, DK-14 Antifog Finder Eyepiece, *Nikon View DX* browser software, *Nikon Capture* control software (standard accessories may differ depending on country or region of sale)

Note

The LCD illuminator will gradually get darker over time. This is normal; if desired, the illuminator can be replaced for a fee by a Nikon-authorized technician.

Exposure Program (Programmed Auto)

The following chart shows the exposure program used when the exposure mode is set to programmed auto.

(ISO 200, lens with maximum aperture of f/1.4 and a minimum aperture of f/16 (e.g., AF 50 mm f/1.4D))

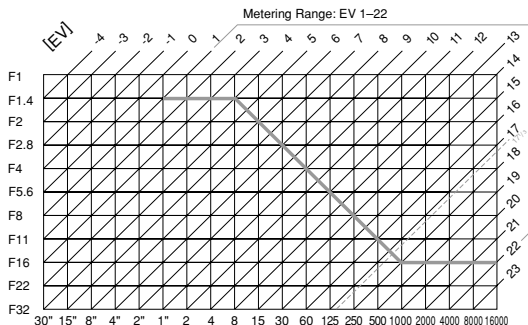

The maximum and minimum values for EV depend on the sensitivity used.

In matrix metering, any EV over $17\frac{1}{3}$ at a sensitivity of ISO 200 equivalent is adjusted to $17\frac{1}{3}$.

Symbols

- 3D color matrix metering. *See* Metering
- 3D multi-sensor balanced fill-flash for the D1. *See* Flash photography

A

- A (Aperture-priority auto exposure mode). *See* Exposure mode
- A (Auto white balance). *See* White balance
- AC adapter 114
- Accessories, optional 114–117
- Accessory shoe 95
- AF area mode 34–35
 - dynamic AF 34
 - single area AF 16, 34
- AF lock. *See* Focus lock
- Anti-vibration mode 68
- Aperture 45–47
 - lock 46, 76
 - maximum 45, 47
 - minimum 6, 45–46
- Aperture-priority auto exposure mode. *See* Exposure mode
- Auto bracketing 53–56, 67, 76
- Auto exposure lock 49–50, 68, 76
- Autofocus 16, 33–35, 37–39
- Autofocus assist illuminator ... 39, 99
- Auto meter switch-off 20, 70
- AUTO OFF 91

B

- BASIC. *See* Image quality
- Battery ix, 4–5, 114
 - battery indicator 5
 - installing 4–5
- Body cap 7
- Bulb. *See* Long time exposure

C

- C (continuous servo autofocus). *See* Autofocus
- C (continuous shooting mode). *See* Continuous shooting mode
- Capture preview mode 56–57, 67
- CARDFORMAT 92
- Card slot 12–13
- Center-weighted fill-flash for the D1. *See* Flash photography
- Center-weighted metering. *See* Metering
- Clock calendar 8–9
- Closest subject priority 34, 68, 69
- Color temperature. *See* White balance
- Continuous servo AF. *See* Focus mode
- Continuous shooting mode 26, 72
- Custom settings 65–76
 - custom sets A, B 67
 - resetting to default values 76

D

- Data transfer. *See* PC mode
- Date and time. *See* Clock calendar
- DCF. *See* Design Rule for Camera File Systems
- DELETE 84
- Deleting photographs 24, 82, 84
- Depth of field 45
- Depth-of-field preview 64
- Design Rule for Camera File Systems 104, 106
- Digital Print Order Format 82
- Distance information 17, 41, 94
- Diopter adjustment. *See* Viewfinder diopter
- DPOF. *See* Digital Print Order Format

E

- EH-4 AC adapter. *See* AC adapter
- Electronic analog exposure
 - display v, vi, 48
- Electronic rangefinder 40, 109
- EN-4 NiMH battery pack. *See* Battery
- Battery
- Exposure compensation .. 51, 69, 76
- Exposure mode 18, 42, 109
 - aperture priority auto 45, 100
 - manual 43, 100
 - programmed auto 18, 127, 100
 - shutter-priority auto 44, 100

F

- FINE. *See* Image quality
- Flash bracketing 53, 67
- Flash photography 93–100
 - flash sync mode 96, 100
 - front-curtain sync 96
 - rear-curtain sync 96
 - red-eye reduction 96
 - red-eye reduction with
 - slow sync 96
 - slow sync 96
- Flash ready light 95, 100
- Flexible program 18, 76
- Focus area vi, 20, 36
- Focus lock 33, 37, 71
- Focus mode 16, 33, 109
 - continuous servo AF 26, 72, 73
 - manual 39, 40, 109
 - single servo AF 16, 33, 68
- Focus tracking 33
- FOLDERS 89
- FRAME INTVL 85

H

- HI. *See* Image quality
- HIDE IMAGE 86
- HIGHLIGHT 90–91
- HISTOGRAM 90

I

- Image quality 14, 28–29
- ISO equivalency. *See* Sensitivity

L

- LANGUAGE 10–11, 91
- LCD illuminator 63, 70
- Lens 109–111
 - cleaning viii
 - compatibility 109–110
 - CPU Nikkor 94, 98, 109
 - D-Type AF Nikkor 94, 107, 109
 - mounting 6–7
 - non-CPU 6, 43–45, 98, 109
 - removing 7
- Long time exposure 47

M

- Manual exposure mode. *See* Exposure mode
- Manual focus. *See* Focus mode
- Matrix metering. *See* Metering
- Memory card 12–13, 114
 - formatting 13, 92
- Metering 17, 41–42, 109
 - 3D color matrix 17, 41, 109
 - and flash modes 94
 - center-weighted 41, 94, 109
 - matrix 17, 41, 109
 - spot 42, 94, 109
- MH-16 quick charger 4, 114
- Mirror viii
 - mirror up 68, 112–113
- Mode dial 14, 26
- Monitor pre-flash 94
- Multi-sensor balanced fill-flash for the D1. *See* Flash photography

N

- NTSC. *See* VIDEO OUTPUT
- NORMAL. *See* Image quality

P

- PAL. *See* VIDEO OUTPUT
- PC mode 26, 73, 103
- Picture angle 111
- Playback 23, 26, 60, 78–80
- Playback menu 82–87
- PLAY BACK OPTIONS 90
- PRE. *See* White balance
- Pre-flash 96
- PRINT SET 84, 87
- Programmed auto exposure mode.
See Exposure mode
- PROTECT 86

R

- RAW data 28, 67
 - Rear-curtain sync. *See* Flash photography
 - Record-and-review 58, 73
 - Red-eye reduction. *See* Flash photography
 - Red-eye reduction with slow sync.
See Flash photography
 - RGB. *See* Image quality
 - RGB-TIFF 29
- ## S
- S (Shutter-priority auto exposure mode). *See* Exposure mode
 - S (Single-frame shooting). *See* Single-frame shooting mode
 - S (Single-servo AF). *See* Focus mode, single-servo AF
 - Self-timer 27, 62, 70
 - Sensitivity 14, 30
 - sensitivity up 74, 99
 - SET UP 88–92
 - Shutter speed
 - lock 44
 - synchronized 98
 - Shutter-priority auto exposure mode. *See* Exposure mode
 - Single-frame shooting mode 14, 26, 68, 69
 - Single-image playback 23, 78–79
 - Single-servo AF. *See* Autofocus
 - SLIDE SHOW 85
 - Slow sync. *See* Flash photography
 - Speedlight 94, 98–100, 116
 - See also* Flash photography
 - Spot metering. *See* metering
 - Standard TTL flash for the D1. *See* Flash photography
 - Sync terminal 95

T

- Thumbnail mode 80
- Time exposure. *See* Long time exposure
- Tone compensation 72
- Two-button reset 76

V

- VIDEO OUTPUT 92
- Viewfinder diopter 63

W

- White balance 15, 31–32

Y

- YCbCr. *See* Image quality
- YCbCr-TIFF 29

NIKON CORPORATION

2-3 MARUNOUCHI 3-CHOME,
CHIYODA-KU,
TOKYO, 100-8331 JAPAN

Printed in Japan
SB5J00030101(11)
6ME49510--