

Nikon

DIGITAL CAMERA

COOLPIX S9300
S9200
Reference Manual

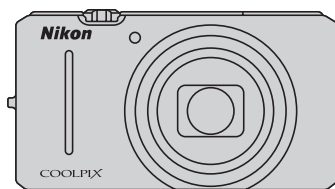
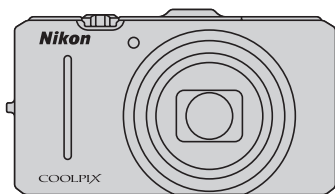

En

Trademark Information

- Microsoft, Windows and Windows Vista are either registered trademarks or trademarks of Microsoft Corporation in the United States and/or other countries.
- Macintosh, Mac OS, and QuickTime are trademarks of Apple Inc., registered in the U.S. and other countries. The iFrame logo and the iFrame symbol are trademarks of Apple Inc.
- Adobe and Acrobat are registered trademarks of Adobe Systems Inc.
- SDXC, SDHC and SD Logos are trademarks of SD-3C, LLC.
- PictBridge is a trademark.
- HDMI, **HDMI** logo and High-Definition Multimedia Interface are trademarks or registered trademarks of HDMI Licensing LLC.
- All other trade names mentioned in this manual or the other documentation provided with your Nikon product are trademarks or registered trademarks of their respective holders.

AVC Patent Portfolio License

This product is licensed under the AVC Patent Portfolio License for the personal and non-commercial use of a consumer to (i) encode video in compliance with the AVC standard ("AVC video") and/or (ii) decode AVC video that was encoded by a consumer engaged in a personal and non-commercial activity and/or was obtained from a video provider licensed to provide AVC video. No license is granted or shall be implied for any other use. Additional information may be obtained from MPEG LA, L.L.C.

See <http://www.mpegla.com>.

Introduction

Parts of the Camera and Basic Operations

The Basics of Shooting and Playback

Shooting Features

Playback Features

Recording and Playing Back Movies

**Using GPS/Electronic Compass
(COOLPIX S9300 only)**

General Camera Setup

Reference Section

Technical Notes and Index

Read This First

Thank you for purchasing the Nikon COOLPIX S9300/S9200 digital camera. Before using the camera, please read the information in "For Your Safety" (vi) and familiarize yourself with the information provided in this manual. After reading, please keep this manual handy and refer to it to enhance your enjoyment of your new camera.

Confirming the Package Contents

In the event that any items are missing, please contact the store where you purchased the camera.

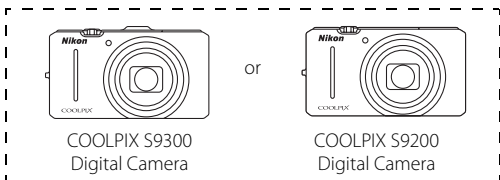

Camera Strap

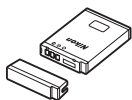

Rechargeable Li-ion
Battery EN-EL12
(with terminal cover)

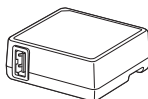

Charging AC Adapter
EH-69P*

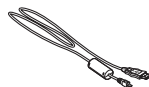

USB Cable UC-E6

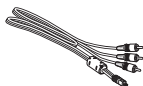

Audio Video Cable EG-CP16



ViewNX 2 Installer CD



Reference Manual CD

- Warranty

* A plug adapter is included if the camera was purchased in a country or region that requires a plug adapter. The shape of the plug adapter varies with the country or region of purchase.

NOTE: A memory card is not included with the camera.

About This Manual





If you want to start using the camera right away, see “The Basics of Shooting and Playback” (📖13).

To learn about the parts of the camera and basic operations, see “Parts of the Camera and Basic Operations” (📖1).

Other Information

- Symbols and Conventions

To make it easier to find the information you need, the following symbols and conventions are used in this manual:

Icon	Description
	This icon indicates cautions and information that should be read before using the camera.
	This icon marks notes, information that should be read before using the camera.
	These icons indicate other pages containing relevant information;  : “Reference Section”,  : “Technical Notes and Index.”

- SD, SDHC and SDXC memory cards are referred to as “memory cards” in this manual.
- The setting at the time of purchase is referred to as the “default setting.”
- The names of menu items displayed in the camera monitor, and the names of buttons or messages displayed on a computer monitor appear in bold.
- In this manual, images are sometimes omitted from monitor and viewfinder display samples so that monitor indicators can be more clearly shown.
- Illustrations and monitor content shown in this manual may differ from the actual product.
- The COOLPIX S9300 is used for the illustrations and monitor contents in this manual. Illustrations for both the COOLPIX S9300 and the COOLPIX S9200 are provided when necessary.

Information and Precautions

Life-Long Learning

As part of Nikon's "Life-Long Learning" commitment to ongoing product support and education, continually updated information is available online at the following sites:

- For users in the U.S.A.: <http://www.nikonusa.com/>
- For users in Europe and Africa: <http://www.europe-nikon.com/support/>
- For users in Asia, Oceania, and the Middle East: <http://www.nikon-asia.com/>

Visit these sites to keep up-to-date with the latest product information, tips, answers to frequently asked questions (FAQs), and general advice on digital imaging and photography. Additional information may be available from the Nikon representative in your area. Visit the site below for contact information:

<http://imaging.nikon.com/>

Use Only Nikon Brand Electronic Accessories

Nikon COOLPIX cameras are designed to the highest standards and include complex electronic circuitry. Only Nikon brand electronic accessories (including battery chargers, batteries, Charging AC Adapter and AC adapters) certified by Nikon specifically for use with this Nikon digital camera are engineered and proven to operate within the operational and safety requirements of this electronic circuitry.

THE USE OF NON-NIKON ELECTRONIC ACCESSORIES COULD DAMAGE THE CAMERA AND MAY VOID YOUR NIKON WARRANTY.

The use of third-party rechargeable Li-ion batteries not bearing the Nikon holographic seal could interfere with normal operation of the camera or result in the batteries overheating, igniting, rupturing, or leaking.

For more information about Nikon brand accessories, contact a local authorized Nikon dealer.

Holographic seal: Identifies this device as an authentic Nikon product.



Before Taking Important Pictures

Before taking pictures on important occasions (such as at weddings or before taking the camera on a trip), take a test shot to ensure that the camera is functioning normally. Nikon will not be held liable for damages or lost profits that may result from product malfunction.

About the User's Manual

- No part of the documentation included with this product may be reproduced, transmitted, transcribed, stored in a retrieval system, or translated into any language in any form, by any means, without Nikon's prior written permission.
- Nikon will not be held liable for any damages resulting from the use of this product.
- Nikon reserves the right to change the specifications of the hardware and software described in the documentation at any time and without prior notice.
- While every effort was made to ensure that the information in the documentation is accurate and complete, we would appreciate it were you to bring any errors or omissions to the attention of the Nikon representative in your area (address provided separately).

Notice Concerning Prohibition of Copying or Reproduction

Note that simply being in possession of material that was digitally copied or reproduced by means of a scanner, digital camera or other device may be punishable by law.

• Items prohibited by law from being copied or reproduced

Do not copy or reproduce paper money, coins, securities, government bonds or local government bonds, even if such copies or reproductions are stamped "Sample." The copying or reproduction of paper money, coins, or securities which are circulated in a foreign country is prohibited. Unless the prior permission of the government was obtained, the copying or reproduction of unused postage stamps or post cards issued by the government is prohibited.

The copying or reproduction of stamps issued by the government and of certified documents stipulated by law is prohibited.

• Cautions on certain copies and reproductions

The government has issued cautions on copies or reproductions of securities issued by private companies (shares, bills, checks, gift certificates, etc.), commuter passes, or coupon tickets, except when a minimum of necessary copies are to be provided for business use by a company. Also, do not copy or reproduce passports issued by the government, licenses issued by public agencies and private groups, ID cards and tickets, such as passes and meal coupons.

• Comply with copyright notices

The copying or reproduction of copyrighted creative works such as books, music, paintings, woodcut prints, maps, drawings, movies, and photographs is governed by national and international copyright laws. Do not use this product for the purpose of making illegal copies or to infringe copyright laws.

Disposing of Data Storage Devices

Please note that deleting images or formatting data storage devices such as memory cards or built-in camera memory does not completely erase the original image data. Deleted files can sometimes be recovered from discarded storage devices using commercially available software, potentially resulting in the malicious use of personal image data. Ensuring the privacy of such data is the user's responsibility.

Before discarding a data storage device or transferring ownership to another person, erase all data using commercial deletion software, or format the device and then completely refill it with images containing no private information (for example, pictures of empty sky). Be sure to also replace any pictures selected for the **Select an image** option in the **Welcome screen** setting (📖100). Care should be taken to avoid injury or damage to property when physically destroying data storage devices.

For the COOLPIX S9300, the log data saved on the memory card is handled in the same way as other data. You can delete unsaved log data from the memory card using **Create log** → **End log** → **Erase log**.

For Your Safety

To prevent damage to your Nikon product or injury to yourself or to others, read the following safety precautions in their entirety before using this equipment. Keep these safety instructions where all those who use the product will read them.



This icon marks warnings, information that should be read before using this Nikon product, to prevent possible injury.

WARNINGS

Turn off in the event of malfunction

Should you notice smoke or an unusual smell coming from the camera or Charging AC Adapter, unplug the Charging AC Adapter and remove the battery immediately, taking care to avoid burns. Continued operation could result in injury. After removing or disconnecting the power source, take the equipment to a Nikon-authorized service representative for inspection.

Do not disassemble

Touching the internal parts of the camera or Charging AC Adapter could result in injury. Repairs should be performed only by qualified technicians. Should the camera or Charging AC Adapter break open as the result of a fall or other accident, take the product to a Nikon-authorized service representative for inspection, after unplugging the product and/or removing the battery.

Do not use the camera or Charging AC Adapter in the presence of flammable gas

Using the camera in the presence of flammable gases such as propane and gasoline, as well as flammable sprays or dust could result in explosion or fire.

Handle the camera strap with care

Never place the strap around the neck of an infant or child.

Keep out of reach of children

Do not keep the products within reach of children. Doing so may cause injury. Particular care should be taken to prevent infants from putting the battery or other small parts into their mouths.

Do not remain in contact with the camera, Charging AC Adapter, or AC adapter for extended periods while the devices are on or in use.

Parts of the devices become hot. Leaving the devices in direct contact with the skin for extended periods may result in low-temperature burns.

 Observe caution when handling the battery

The battery may leak, overheat, or explode if improperly handled. Observe the following precautions when handling the battery for use in this product:

- Before replacing the battery, turn the product off. If you are using the Charging AC Adapter/AC adapter, be sure it is unplugged.
- Use only a Rechargeable Li-ion Battery EN-EL12 (included). Charge the battery by inserting it into the camera and connecting the Charging AC Adapter. EH-69P (included).
- When inserting the battery, do not attempt to insert it upside down or backwards.
- Do not short or disassemble the battery or attempt to remove or break the battery insulation or casing.
- Do not expose the battery to flame or to excessive heat.
- Do not immerse in or expose to water.
- Replace the terminal cover when transporting the battery. Do not transport or store with metal objects such as necklaces or hairpins.
- The battery is prone to leakage when fully discharged. To avoid damage to the product, be sure to remove the battery when no charge remains.

- Discontinue use immediately should you notice any change in the battery, such as discoloration or deformation.
- If liquid from the damaged battery comes in contact with clothing or skin, rinse immediately with plenty of water.
- If leaked battery fluid gets into your eyes, rinse them out immediately with clean running water and get medical treatment.
- Do not attempt to charge batteries that are not rechargeable.

 Observe the following precautions when handling the Charging AC Adapter

- Keep dry. Failure to observe this precaution could result in fire or electric shock.
- Dust on or near the metal parts of the plug should be removed with a dry cloth. Continued use could result in fire.
- Do not handle the plug or go near the Charging AC Adapter during lightning storms. Failure to observe this precaution could result in electric shock.
- Do not damage, modify, forcibly tug or bend the USB cable, place it under heavy objects, or expose it to heat or flames. Should the insulation be damaged and the wires become exposed, take it to a Nikon-authorized service representative for inspection. Failure to observe these precautions could result in fire or electric shock.

- Do not handle the plug or Charging AC Adapter with wet hands. Failure to observe this precaution could result in electric shock.
- Do not use with travel converters or adapters designed to convert from one voltage to another or with DC-to-AC inverters. Failure to observe this precaution could damage the product or cause overheating or fire.

⚠ Use appropriate cables

When connecting cables to the input and output jacks, use only the cables provided or sold by Nikon for the purpose, to maintain compliance with product regulations.

⚠ Handle moving parts with care

Be careful that your fingers or other objects are not pinched by the lens cover or other moving parts.

⚠ CD-ROMs

The CD-ROMs included with this device should not be played back on audio CD equipment. Playing CD-ROMs on an audio CD player could cause hearing loss or damage the equipment.

⚠ Observe caution when using the flash

Using the flash close to your subject's eyes could cause temporary visual impairment. Particular care should be observed if photographing infants, when the flash should be no less than 1 m (3 ft 4 in.) from the subject.

⚠ Do not operate the flash with the flash window touching a person or object

Failure to observe this precaution could result in burns or fire.

⚠ Avoid contact with liquid crystal

Should the monitor break, care should be taken to avoid injury caused by broken glass and to prevent liquid crystal from the monitor touching the skin or entering the eyes or mouth.

⚠ Turn the power off when using inside an airplane or the hospital

Turn the power off while inside the airplane during take off or landing. Also, before boarding an airplane, set the GPS tracking information recording function to OFF (COOLPIX S9300). If using in a hospital, be sure to follow the instructions of the hospital. The electromagnetic waves emitted by this camera may disrupt the electronic systems of the airplane or the instruments of the hospital.

⚠ 3D Images

Do not continuously view 3D images recorded with this device for extended periods, whether on a television, monitor, or other display. In the case of children whose visual systems are still maturing, consult a pediatrician or ophthalmologist prior to use and follow their instructions. Prolonged viewing of 3D images may cause eye strain, nausea, or discomfort. Cease use should any of these symptoms occur and consult a physician if necessary.

Notices

Notices for Customers in the U.S.A.

IMPORTANT SAFETY INSTRUCTIONS -

SAVE THESE INSTRUCTIONS.

DANGER - TO REDUCE THE RISK OF FIRE OR ELECTRIC SHOCK, CAREFULLY FOLLOW THESE INSTRUCTIONS

For connection to a supply not in the U.S.A., use an attachment plug adapter of the proper configuration for the power outlet if needed.

The power supply unit is intended to be correctly orientated in a vertical or floor mount position.

Federal Communications Commission (FCC) Radio Frequency Interference Statement

This equipment has been tested and found to comply with the limits for a Class B digital device, pursuant to Part 15 of the FCC rules. These limits are designed to provide reasonable protection against harmful interference in a residential installation. This equipment generates, uses, and can radiate radio frequency energy and, if not installed and used in accordance with the instructions, may cause harmful interference to radio communications. However, there is no guarantee that interference will not occur in a particular installation. If this equipment does cause harmful interference to radio or television reception, which can be determined by turning the equipment off and on, the user is encouraged to try to correct the interference by one or more of the following measures:

- Reorient or relocate the receiving antenna.
- Increase the separation between the equipment and receiver.
- Connect the equipment into an outlet on a circuit different from that to which the receiver is connected.
- Consult the dealer or an experienced radio/television technician for help.

FC **Nikon**
COOLPIX S9300
COOLPIX S9200

CAUTIONS**Modifications**

The FCC requires the user to be notified that any changes or modifications made to this device that are not expressly approved by Nikon Corporation may void the user's authority to operate the equipment.

Interface Cables

Use the interface cables sold or provided by Nikon for your equipment. Using other interface cables may exceed the limits of Class B Part 15 of the FCC rules.

Notice for Customers in the State of California**WARNING**

Handling the cord on this product will expose you to lead, a chemical known to the State of California to cause birth defects or other reproductive harm.

Wash hands after handling.

Nikon Inc.,
1300 Walt Whitman Road,
Melville, New York 11747-3064
USA
Tel: 631-547-4200

Notice for Customers in Canada**CAUTION**

This Class B digital apparatus complies with Canadian ICES-003.

ATTENTION

Cet appareil numérique de la classe B est conforme à la norme NMB-003 du Canada.

Notices for Customers in Europe**CAUTIONS****RISK OF EXPLOSION IF BATTERY IS REPLACED BY AN INCORRECT TYPE.****DISPOSE OF USED BATTERIES ACCORDING TO THE INSTRUCTIONS.**

This symbol indicates that this product is to be collected separately.

The following apply only to users in European countries:

- This product is designated for separate collection at an appropriate collection point. Do not dispose of as household waste.
- For more information, contact the retailer or the local authorities in charge of waste management.



This symbol on the battery indicates that the battery is to be collected separately.

The following apply only to users in European countries:

- All batteries, whether marked with this symbol or not, are designated for separate collection at an appropriate collection point. Do not dispose of as household waste.
- For more information, contact the retailer or the local authorities in charge of waste management.



<Important> Notes on GPS/electronic compass (COOLPIX S9300 only)

● Location name data of this camera

Before using the GPS function, make sure to read "USER LICENSE AGREEMENT FOR LOCATION NAME DATA (COOLPIX S9300 only)" (📖:7) and agree to the terms.

- The location name information (Point of Interest: POI) for Japan is as of June 2011; the location information for outside Japan is as of September 2011. The location name information will not be updated.
- Use the location name information only as a guide.

● Notes on GPS/electronic compass

- Do not operate the GPS/electronic compass while you are driving a car.
- Use information (such as direction) measured by the camera as a guideline only. This information cannot be used for navigation of an airplane, car, and person or land survey applications.
- When you use the camera for mountain climbing or trekking, be sure to take a map, navigation device, or measuring instrument separately.
- When the camera lens is facing upward, the electronic compass is not displayed.
- An individual may be identified from still pictures or movies that have been recorded with location information.

Observe caution when you transfer still pictures or movies recorded with location information, or GPS log files to a third party or upload them to a network such as the Internet where the public can view them.

Be sure to read "Disposing of Data Storage Devices" (📖v).

● When the Record GPS data of the GPS options menu is On, and a log is recorded using Create log, GPS functions will continue to operate even when the camera is turned off.

- The electromagnetic waves emitted from the camera may affect the measuring instruments of an airplane or medical equipment. When use of the camera is prohibited during airplane takeoffs and landings or inside a hospital, set the **Record GPS data** to **Off** and turn off the camera.

































● Using the camera overseas

















































- Before taking the camera with GPS function overseas for travel, consult your travel agency or embassy of the country you are visiting to confirm whether there is any restriction on use. For example, you cannot record location information logs without permission from the government in China. Set the **Record GPS data** of the **GPS options** menu to **Off**.
- The GPS may not function properly in China and on the borders between China and neighbouring countries (as of September 2011).





















Table of Contents















Introduction	ii
Read This First	ii
Confirming the Package Contents.....	ii
About This Manual.....	iii
Information and Precautions.....	iv
For Your Safety.....	vi
WARNINGS	vi
Notices	ix
<Important> Notes on GPS/electronic compass (COOLPIX S9300 only)	xi
Parts of the Camera and Basic Operations	1
Parts of the Camera.....	2
The Camera Body.....	2
Controls Used in Shooting Mode.....	4
Controls Used in Playback Mode	5
The Monitor.....	6
Basic Operations.....	9
Switching Between Shooting Mode and Playback Mode	9
Using the Rotary Multi Selector.....	10
Using Menus (the MENU Button).....	11
Attaching the Camera Strap	12
The Basics of Shooting and Playback.....	13
Preparation 1 Insert the Battery.....	14
Preparation 2 Charge the Battery.....	16
Preparation 3 Insert a Memory Card	18
Internal Memory and Memory Cards.....	19
Approved Memory Cards.....	19
Step 1 Turn the Camera On	20
Turning the Camera On and Off.....	21
Setting the Display Language, Date, and Time.....	22
Step 2 Select a Shooting Mode.....	24
Available Shooting Modes.....	25
Step 3 Frame a Picture.....	26
Using the Zoom.....	27
Step 4 Focus and Shoot	28
Step 5 Play Back Images	30
Changing How Images Are Displayed.....	31
Step 6 Delete Unwanted Images.....	32

Shooting Features	35
📷 (Auto) Mode.....	36
Changing 📷 (Auto) Mode Settings.....	36
Options Available in the Shooting Menu (📷 (Auto) Mode).....	36
Scene Mode (Shooting Suited to Scenes)	38
Changing Scene Mode Settings.....	39
Characteristics of Each Scene Mode.....	39
Smart Portrait Mode (Shooting Smiling Faces)	50
Changing Smart Portrait Mode Settings.....	51
Options Available in the Smart Portrait Menu.....	51
Using Skin Softening	52
Continuous Shooting Mode (Burst Shooting)	53
Changing Continuous Shooting Mode Settings.....	54
Options Available in the Continuous Shooting Menu.....	55
Special Effects Mode (Applying Effects When Shooting).....	57
Characteristics of Each Special Effect.....	57
Changing Special Effects Mode Settings.....	58
Features That Can Be Set Using the Multi Selector.....	59
Available Functions	59
Using the Flash (Flash Modes)	60
Using the Self-timer	63
Using Macro Mode	64
Adjusting Brightness (Exposure Compensation), Vividness, and Hue (Creative Slider)	65
Adjusting Brightness (Exposure Compensation).....	68
List of the Default Settings.....	69
Changing the Image Size (Image Mode).....	71
Image Mode Settings (Image Size and Quality).....	71
Features That Cannot Be Used Simultaneously	73
Focusing on the Subject.....	74
Using Face Detection.....	75
Focus Lock.....	76
Playback Features	77
Selecting Certain Types of Images for Playback	78
Available Playback Modes.....	78
Switching Between Playback Modes	78
Features Available in Playback Mode (Playback Menu)	80
Connecting the Camera to a TV, Computer, or Printer	82
Using ViewNX 2.....	83
Installing ViewNX 2.....	83

Transferring Images to the Computer	85
Viewing Images	86
Recording and Playing Back Movies.....	87
Recording Movies	88
Changing Movie Recording Settings (Movie Menu)	91
Playing Back Movies.....	92
Using GPS/Electronic Compass (COOLPIX S9300 only)	93
Starting GPS Data Recording	94
Changing the GPS or Electronic Compass Settings (GPS Options Menu)	97
General Camera Setup.....	99
The Setup Menu	100
Reference Section.....	 1
Using Easy Panorama (Shooting and Playing Back)	 2
Taking Pictures with Easy Panorama.....	 2
Viewing Easy Panorama (Scroll)	 4
Using 3D Photography.....	 5
Playing and Deleting Images Captured Using Continuous Shooting Mode (Sequence).....	 7
Playing Images in a Sequence.....	 7
Deleting Images in a Sequence.....	 8
Favorite Pictures Mode	 9
Adding Images to Albums.....	 9
Playing Back Images in Albums.....	 10
Removing Images From Albums	 11
Changing the Favorites Album Icon	 12
Auto Sort Mode	 13
List by Date Mode	 15
Editing Still Images.....	 16
Editing Features	 16
 Quick Retouch: Enhancing Contrast and Saturation.....	 18
 D-Lighting: Enhancing Brightness and Contrast	 18
 Skin Softening: Softening Skin Tones	 19
 Filter Effects: Applying Digital Filter Effects	 20
 Small Picture: Reducing the Size of an Image	 21
 Crop: Creating a Cropped Copy	 22
Connecting the Camera to a TV (Viewing Images on a TV)	 23
Connecting the Camera to a Printer (Direct Print)	 25
Connecting the Camera to a Printer.....	 26

Printing Individual Images		27
Printing Multiple Images		28
Editing Movies		31
Extracting Only the Desired Portions of the Movie		31
The Shooting Menu (for  (Auto) Mode, Continuous Shooting Mode)		33
White Balance (Adjusting Hue)		33
Metering		35
Continuous Shooting		36
ISO Sensitivity		36
AF Area Mode		37
Autofocus Mode		40
The Smart Portrait Menu		41
Image Mode (Image Size and Quality)		41
Skin Softening		41
Smile Timer		41
Blink Proof		42
The Playback Menu		43
 Print Order (Creating a DPOF Print Order)		43
 Slide Show		46
 Protect		47
The Image Selection Screen		48
 Rotate Image		49
 Voice Memo		50
 Copy (Copy Between Internal Memory and Memory Card)		51
 Sequence Display Options		52
 Choose Key Picture		52
The Movie Menu		53
Movie Options		53
Open with HS Footage		54
Recording Movies in Slow Motion and Fast Motion (HS Movie)		55
Autofocus Mode		57
Wind Noise Reduction		57
GPS Options (COOLPIX S9300 only)		58
GPS Settings		58
Points of Interest (POI) (Recording and Displaying Location Name Information)		60
Create Log (Record the Log of Moving Information)		61
View Log		63
Electronic Compass		64
The Setup Menu		66
Welcome Screen		66

Time Zone and Date.....		67
Monitor Settings.....		70
Print Date (Imprinting Date and Time on Pictures).....		72
Vibration Reduction.....		73
Motion Detection.....		74
AF Assist.....		75
Digital Zoom.....		76
Sound Settings.....		77
Auto Off.....		77
Format Memory/Format Card.....		78
Language.....		78
TV Settings.....		79
Charge by Computer.....		80
Blink Warning.....		82
Eye-Fi Upload.....		83
Filmstrip.....		84
Reset All.....		84
Firmware Version.....		88
File and Folder Names.....		89
Optional Accessories.....		91
Error Messages.....		92

Technical Notes and Index.....		1
Caring for the Products.....		2
The Camera.....		2
The Battery.....		3
Charging AC Adapter.....		4
The Memory Cards.....		5
Caring for the Camera.....		6
Cleaning.....		6
Storage.....		6
USER LICENSE AGREEMENT FOR LOCATION NAME DATA (COOLPIX S9300 only)....		7
Troubleshooting.....		11
Specifications.....		19
Supported Standards.....		22
Index.....		23



Parts of the Camera and Basic Operations

This chapter describes the parts of the camera and also explains the main functions of each part and the basic camera operations.

Parts of the Camera	2
The Camera Body	2
Controls Used in Shooting Mode	4
Controls Used in Playback Mode	5
The Monitor	6
Basic Operations	9
Switching Between Shooting Mode and Playback Mode	9
Using the Rotary Multi Selector.....	10
Using Menus (the MENU Button)	11
Attaching the Camera Strap.....	12

➔ If you want to start using the camera right away, see “The Basics of Shooting and Playback” (📖13).

Parts of the Camera

The Camera Body

COOLPIX S9300

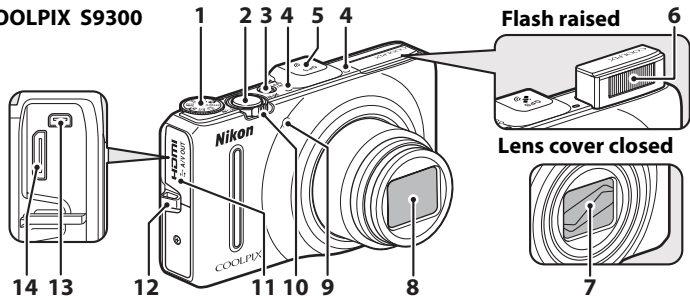

COOLPIX S9200

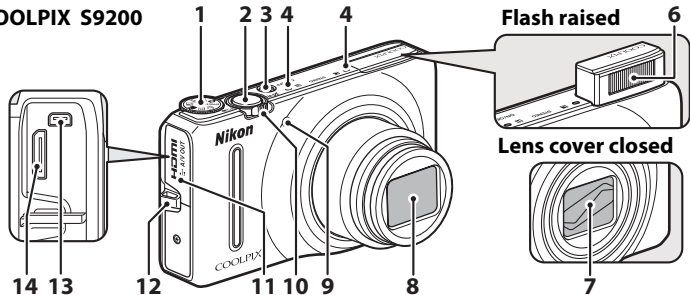





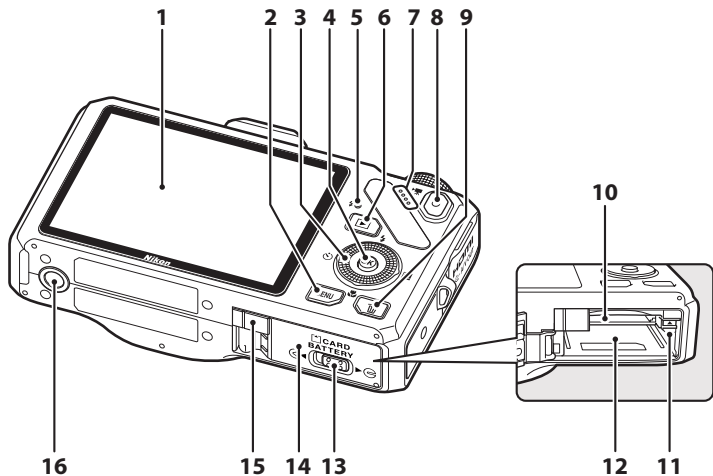



1	Mode dial.....	24
2	Shutter-release button.....	4, 28
3	Power switch/power-on lamp.....	21
4	Microphone (stereo).....	81, 88
5	GPS antenna (COOLPIX S9300 only)...	95
6	Flash.....	60
7	Lens cover	
8	Lens	
9	Self-timer lamp.....	63
9	AF-assist illuminator.....	101

10	Zoom control.....	27
	W : Wide.....	27
	T : Tele.....	27
	: Thumbnail playback.....	31
	: Playback zoom.....	31
	: Help.....	38
11	Connector cover.....	16, 82
12	Eyelet for camera strap.....	12
13	USB/audio/video output connector.....	16, 82
14	HDMI mini connector (Type C).....	82



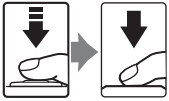













1	Monitor	6, 24	9	(delete) button.....	32, 92
2	MENU (menu) button.....	11	10	Memory card slot.....	18
3	Rotary multi selector (multi selector).....	10	11	Battery latch.....	14, 15
4	(apply selection) button.....	10	12	Battery chamber.....	14
5	Charge lamp.....	17,	13	Cover latch.....	14, 18
	Flash lamp.....	60	14	Battery-chamber/ memory card slot cover	14, 18
6	(playback) button.....	9, 30	15	Power connector cover (for connection with an optional AC Adapter)	91
7	Speaker	81, 92, 101	16	Tripod socket	
8	(movie-record) button	9, 30, 88			

Controls Used in Shooting Mode

Control	Name	Main Function	
	Mode dial	Change the shooting mode.	24
	Zoom control	Rotate toward T (telephoto zoom position) to zoom in, and rotate toward W (wide-angle position) to zoom out.	27
	Rotary multi selector	See "Using the Rotary Multi Selector" for more information.	10
	MENU (menu) button	Display and hide the menu.	11
	Shutter-release button	When pressed halfway (i.e., if you stop pressing when you feel resistance slightly): Set focus and exposure. When pressed all the way: Release the shutter.	28
	Playback button	Play back images.	9, 30
	Delete button	Delete the last image that was saved.	32
	● (movie-record) button	Start and stop movie recording.	88

Controls Used in Playback Mode



Control	Name	Main Function	
	Playback button	<ul style="list-style-type: none"> When the camera is turned off, press and hold this button to turn the camera on in playback mode. Return to shooting mode. 	21 9
	Zoom control	<ul style="list-style-type: none"> Enlarge the image when rotated toward T (); display image thumbnail or the calendar when rotated toward W (). (Thumbnail playback). Adjust the volume for voice memo and movie playback. 	31 81, 92
	Rotary multi selector	See "Using the Rotary Multi Selector" for more information.	10
	Apply selection button	<ul style="list-style-type: none"> Display the histogram and shooting information or return to full-frame playback mode. Display individual images of a sequence in full-frame. Scroll an image recorded with easy panorama. Play back movies. Switch from image thumbnail or zoomed image display to full-frame playback mode. 	30 30,  7 47,  4 92 31
	MENU (menu) button	Display and hide the menu.	11
	Delete button	Delete images.	32
	Shutter-release button	Return to shooting mode.	-
	 movie-record) button		

The Monitor

- The information that is displayed on the monitor during shooting and playback changes depending on the camera's settings and state of use. In the default setting, information is displayed when the camera is turned on and when you operate the camera, and turns off after a few seconds (when **Photo info** in **Monitor settings** (📖100) is set to **Auto info**).

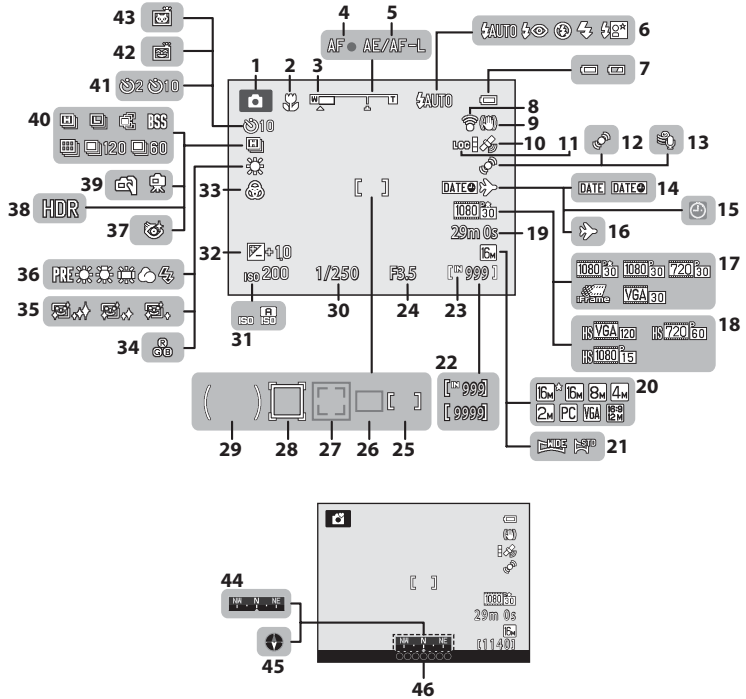
Shooting Mode



1	Shooting mode.....	24, 25
2	Macro mode	64
3	Zoom indicator	27, 64
4	AF indicator.....	28
5	AE/AF-L indicator.....	 25
6	Flash mode	61
7	Battery level indicator	20
8	Eye-Fi communication indicator.....	102,  83
9	Vibration reduction icon	101
10	GPS reception (COOLPIX S9300 only)....	96
11	Log display (COOLPIX S9300 only).....	98
12	Motion detection icon	101
13	Wind noise reduction.....	91
14	Print date.....	100
15	"Date not set" indicator.....	23, 100
16	Travel destination indicator.....	100
17	Movie options (normal speed movies).....	91
18	Movie options (HS movies).....	91
19	Movie length	88, 90
20	Image mode	71
21	Easy panorama	47
22	Number of exposures remaining (still pictures).....	20, 72
23	Internal memory indicator	20
24	Aperture value	28
25	Focus area (for manual, for center)	28, 37
26	Focus area (for auto).....	37
27	Focus area (for face detection, pet detection)	37, 48, 75
28	Focus area (for subject tracking).....	37
29	Center-weighted area	 35
30	Shutter speed.....	28
31	ISO sensitivity	26, 37
32	Exposure compensation value....	67, 68
33	Vividness.....	67
34	Hue.....	67
35	Skin softening	51
36	White balance.....	37
37	Blink proof	51
38	Backlighting (HDR)	41
39	Hand-held/Tripod	40, 43
40	Continuous shooting mode.....	48, 53
41	Self-timer	63
42	Smile timer	50
43	Pet portrait auto release	48
44	Compass display (Direction gauge) (COOLPIX S9300 only).....	98
45	Compass display (Compass) (COOLPIX S9300 only)	98
46	Location name information (POI information) (COOLPIX S9300 only)....	97

Playback Mode

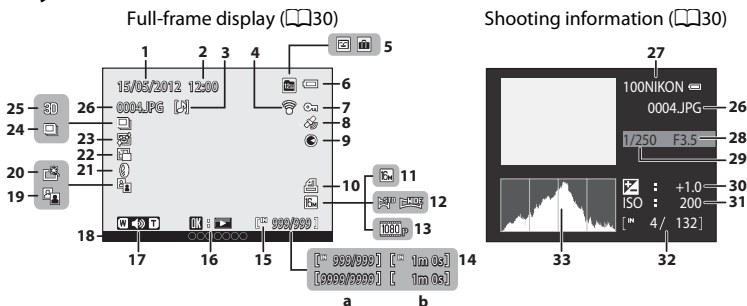

1	Date of recording	22
2	Time of recording	22
3	Voice memo indicator	81
4	Eye-Fi upload indicator	102, 83
	Album icon in favorite pictures mode	78, 9
5	Category icon in auto sort mode	78, 13
	List by date mode	78, 15
6	Battery level indicator	20
7	Protect icon	80
8	Recorded GPS information indicator (COOLPIX S9300 only)	96
9	Compass display (shooting direction) (COOLPIX S9300 only)	98
10	Print order icon	80
11	Image mode	71
12	Easy panorama	47
13	Movie options	88, 91
14	(a) Current image number/total number of images	30
	(b) Movie length	92

15	Internal memory indicator	30
16	Easy panorama playback guide	4
	Sequence playback guide	7
	Movie playback guide	92
17	Volume indicator	81, 92
18	Location name information (POI information) (COOLPIX S9300 only)	96
19	D-Lighting icon	80
20	Quick retouch icon	80
21	Filter effects icon	80
22	Small picture	80, 21
23	Skin softening icon	80
24	Sequence display	81
25	3D picture indicator	49
26	File name	89
27	Folder name	89
28	Aperture value	28
29	Shutter speed	28
30	Exposure compensation value	68
31	ISO sensitivity	26
32	Current image number/total number of images	30
33	Histogram *	

* A histogram is a graph showing the distribution of tones in the image. The horizontal axis corresponds to pixel brightness, with dark tones to the left and bright tones to the right. The vertical axis shows the number of pixels.

Basic Operations

Switching Between Shooting Mode and Playback Mode

The camera has two modes of operation: Shooting mode, which is used for taking pictures, and playback mode, which is used for viewing pictures.

Press the  (playback) button to switch between shooting mode and playback mode.

- While using playback mode, you can also switch to shooting mode by pressing the shutter-release button or the  (movie-record) button.

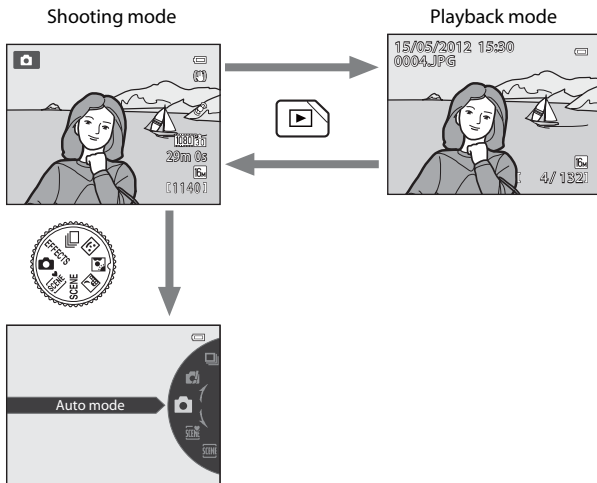

- Rotate the mode dial and align an icon to the mark to select different shooting modes (, 24, 25).

Selecting Images for Playback

Playback mode can be changed according to the type of images you want to view. See "Selecting Certain Types of Images for Playback" (, 78) for more information.

Using the Rotary Multi Selector

Operate by rotating the rotary multi selector, pressing up (▲), down (▼), left (◀) or right (▶) on the rotary multi selector, or pressing the **OK** button.

- The “rotary multi selector” is also referred to as the “multi selector” in this manual.

When Using Shooting Mode

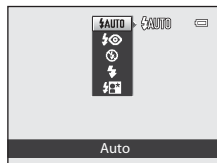
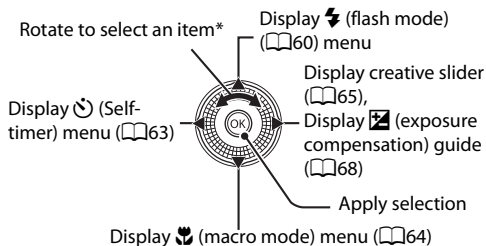

* Pressing up or down will also select an item.

When Using Playback Mode

Select the previous image¹/Move the displayed area when the image is magnified (book 31).



Select the next image¹/Move the displayed area when the image is magnified (book 31).

Display histogram and shooting information (book 30)/ Play back movies (book 92)²

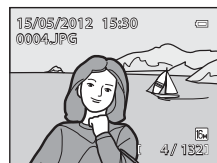

¹ Previous or next images can also be chosen by rotating the rotary multi selector.

² When displaying image thumbnail or when the image is magnified, this button switches the camera to full-frame playback mode.

When Displaying Menus

Select the item above*

Select the item on the left/Return display to the previous screen

Select the item below*



Select the item on the right/Display sub-menu (apply selection)

Apply selection

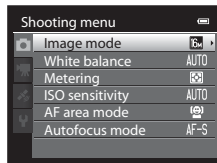

* Items above or below can also be chosen by rotating the rotary multi selector.

Using Menus (the MENU Button)

When the **MENU** button is pressed while the shooting screen or playback screen is displayed, the menu for the current mode is displayed. Once the menu is displayed, various settings can be changed.

Shooting mode

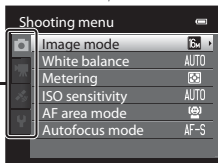
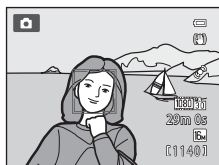

Tabs

Shooting menu

Playback mode

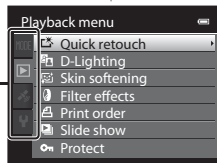
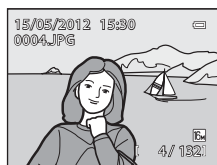

Tabs

Playback menu



tab:

Displays the settings that can be changed for the current shooting mode (📖24). Depending on the current shooting mode, the tab icon that is displayed will be different.



tab:

Displays movie recording settings.



tab (COOLPIX S9300 only):

Displays the GPS options menu (📖97).



tab:

Displays the setup menu, where you can change general settings.

MODE tab:

Selects the playback mode (📖78).



tab:

Displays the settings available for the current playback mode (📖78).



tab (COOLPIX S9300 only):

Displays the GPS options menu (📖97).



tab:

Displays the setup menu, where you can change general settings.

🔑 If a Tab Is Not Displayed

If you press the **MENU** button and the screen that allows you to change the image mode is displayed, press ◀ to display the tabs.

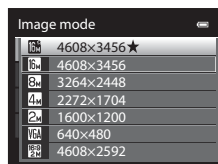

Switching Between Tabs

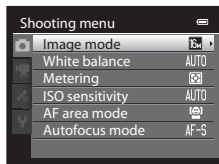

Press the rotary multi selector ◀ to highlight the tab.

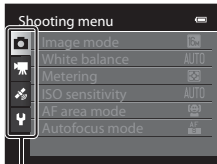

Press the rotary multi selector ▲ or ▼ to select a tab, and press the OK button or ▶.

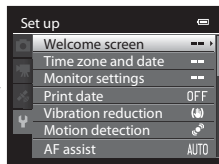

The selected menu is displayed.

Selecting Menu Items

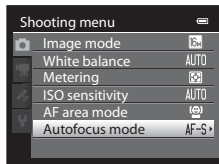

Press the rotary multi selector ▲ or ▼ to select an item, and then press ▶ or the OK button.

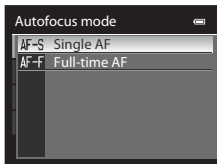

Press ▲ or ▼ to select an item and then press the OK button.



When you finished changing settings, press the MENU (menu) button to exit the menu.

When the Menu Contains Two or More Pages

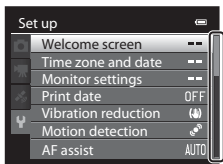

The scroll bar is displayed to indicate the current page.

Attaching the Camera Strap

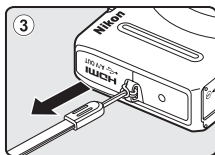
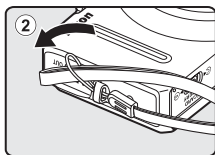
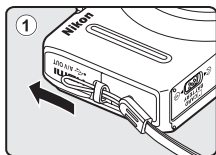

The Basics of Shooting and Playback

Preparation

Preparation 1 Insert the Battery	14
Preparation 2 Charge the Battery	16
Preparation 3 Insert a Memory Card	18



Shooting

Step 1 Turn the Camera On	20
Setting the Display Language, Date, and Time (First Use Only)	22
Step 2 Select a Shooting Mode	24
Step 3 Frame a Picture	26
Step 4 Focus and Shoot	28



Playback

Step 5 Play Back Images	30
Step 6 Delete Unwanted Images	32

Preparation 1 Insert the Battery

- 1** Open the battery-chamber/memory card slot cover.

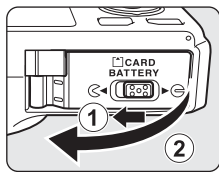

- 2** Insert the included EN-EL12 battery (rechargeable Li-ion battery).

- Use the battery to push the orange battery latch up in the direction indicated by the arrow (1), and fully insert the battery (2).
- When the battery is inserted correctly, the battery latch will lock the battery in place.

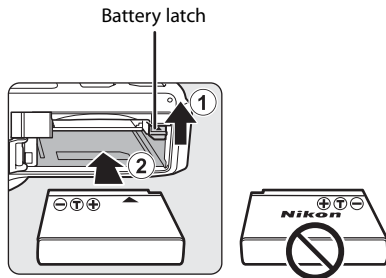

✓ Inserting the Battery Correctly

Inserting the battery upside down or backwards could damage the camera. Be sure to check that the battery is in the correct orientation.

- 3** Close the battery-chamber/memory card slot cover.

- Charge the battery before the first use or when the battery is running low (16).

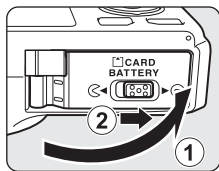

Removing the Battery

Turn the camera off (📖21) and be sure that the power-on lamp and the monitor have turned off before opening the battery-chamber/memory card slot cover. To eject the battery, open the battery-chamber/memory card slot cover and push the orange battery latch in the direction shown (①). Then, remove the battery straight (②).

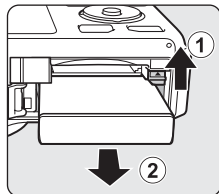

✔ High Temperature Caution

The camera, battery, and memory card may be hot immediately after using the camera. Observe caution when removing the battery or memory card.

✔ Notes on Battery

- Be sure to read and follow the warnings of “For Your Safety” (📖vi) thoroughly before using the battery.
- Be sure to read and follow the warnings for “The Battery” (🔋3) before using the battery.

Preparation 2 Charge the Battery

1 Prepare the included Charging AC Adapter EH-69P.

If a plug adapter* is included with your camera, attach the plug adapter to the plug on the Charging AC Adapter. Push the plug adapter firmly until it is securely held in place. Once the two are connected, attempting to forcibly remove the plug adapter could damage the product.

* The shape of the plug adapter varies according to the country or region in which the camera was purchased. The Charging AC Adapter comes with the plug adapter attached in Argentina and Korea.

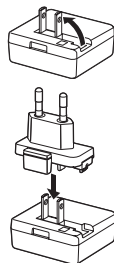

2 Make sure the battery is inserted in the camera, and then connect the camera to the Charging AC Adapter in order of ① to ③.

- Keep the camera turned off.
- When connecting the cable, be sure that the plug is properly oriented. Do not use force when connecting the cable to the camera. When disconnecting the cable, do not pull the plug at an angle.

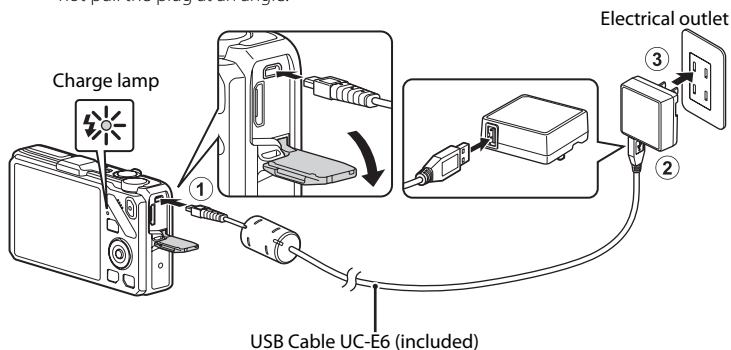

- When charging starts, the charge lamp flashes slowly in green.
- About three hours and 50 minutes is required to charge a fully exhausted battery.
- When the battery has been completely charged, the charge lamp turns off.
- See "Understanding the Charge Lamp" (📖17) for more information.

3 Disconnect the Charging AC Adapter from the electrical outlet and then disconnect the USB cable.

- When the camera is connected to an electrical outlet with the Charging AC Adapter, the camera cannot be turned on.

Understanding the Charge Lamp

Status	Description
Flashes slowly (green)	The battery is charging.
Off	The battery is not charging. When charging is complete, the charge lamp flashing slowly in green stops and is turned off.
Flashes quickly (green)	<ul style="list-style-type: none"> The ambient temperature is not suited to charging. Charge the battery indoors with an ambient temperature of 5°C to 35°C (41°F to 95°F). The USB cable or Charging AC Adapter is not properly connected, or there is a problem with the battery. Disconnect the USB cable or unplug the Charging AC Adapter and correctly connect it again, or change the battery.

Notes on Charging AC Adapter

- Be sure to read and follow the warnings of “For Your Safety” (📖vi) thoroughly before using the Charging AC Adapter.
- Be sure to read thoroughly and follow the warnings for “Charging AC Adapter” (🔌4) before use.

Charging Using Computer or Battery Charger

- You can also charge the COOLPIX S9300/S9200 Rechargeable Li-ion Battery EN-EL12 by connecting the camera to a computer (📖82, 📖102).
- The EN-EL12 can be charged without using the camera by using the Battery Charger MH-65 (available separately; 🛒91).

AC Power Source

- You can take pictures and play back images while using the AC Adapter EH-62F (available separately; 🛒91) to power the camera from an electrical outlet.
- Do not, under any circumstances, use another make or model of AC adapter other than EH-62F. Failure to observe this precaution could result in overheating or damage to the camera.

Preparation 3 Insert a Memory Card

- 1 Confirm that the power-on lamp and the monitor are turned off and open the battery-chamber/memory card slot cover.

- Be sure to turn off the camera before opening the cover.

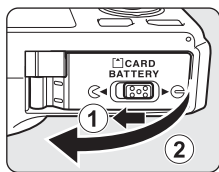

- 2 Insert the memory card.

- Slide the memory card until it clicks into place.

Inserting the Memory Card Correctly

Inserting the memory card upside down or backwards could damage the camera or the memory card. Be sure to confirm that the memory card is in the correct orientation.

Memory card slot

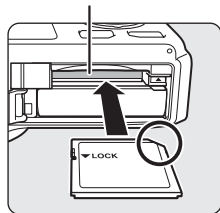

- 3 Close the battery-chamber/memory card slot cover.

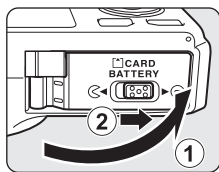

Formatting a Memory Card

- The first time you insert a memory card that has been used in another device into this camera, be sure to format it with this camera.
- **All data stored on a memory card is permanently deleted when the card is formatted.** Be sure to make copies of any data you wish to keep before formatting the memory card.
- To format a memory card, insert the memory card into the camera, press the **MENU** button and select **Format card** from the setup menu (100).

Note on Memory Cards

Refer to the documentation included with the memory card, as well as “The Memory Cards” (5) in “Caring for the Products”.

Removing Memory Cards

Before opening the battery-chamber/memory card slot cover, turn the camera off and confirm that the power-on lamp and the monitor are off.

Press the memory card in lightly with your finger (①) to partially eject it, and then pull it out straight (②).

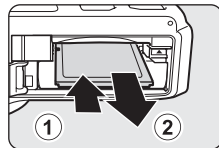

High Temperature Caution

The camera, battery, and memory card may be hot immediately after using the camera. Observe caution when removing the battery or memory card.

Internal Memory and Memory Cards

Camera data, including images and movies, can be saved in either the camera's internal memory (COOLPIX S9300: approx. 26 MB; COOLPIX S9200: approx. 25 MB) or on a memory card. To use the camera's internal memory for shooting or playback, first remove the memory card.

Approved Memory Cards

The following Secure Digital (SD) memory cards have been tested and approved for use in this camera.

- When recording a movie onto a memory card, a memory card with an SD speed class of Class 6 or higher is recommended. If the transfer speed of the card is slow, the movie recording may end unexpectedly.

	SD memory cards	SDHC memory cards ²	SDXC memory cards ³
SanDisk	2 GB ¹	4 GB, 8 GB, 16 GB, 32 GB	64 GB
TOSHIBA	2 GB ¹	4 GB, 8 GB, 16 GB, 32 GB	64 GB
Panasonic	2 GB ¹	4 GB, 8 GB, 12 GB, 16 GB, 32 GB	48 GB, 64 GB
Lexar	-	4 GB, 8 GB, 16 GB, 32 GB	64 GB, 128 GB

¹ Before using a card reader or similar device, check that the device supports 2 GB cards.

² SDHC-compliant. Before using a card reader or similar device, check that the device supports SDHC.

³ SDXC-compliant. Before using a card reader or similar device, check that the device supports SDXC.



- Contact the manufacturer for details on the above cards.

Step 1 Turn the Camera On

1 Press the power switch to turn on the camera.

- **If you are turning the camera on for the first time, see “Setting the Display Language, Date, and Time”** (📖22).
- The lens extends, and the monitor is turned on.

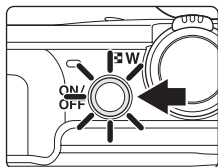

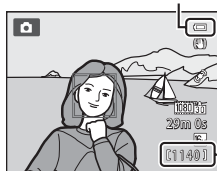

2 Check the battery level and number of exposures remaining.

Battery level indicator



Number of exposures remaining

Battery Level

Display	Description
	Battery level high.
	Battery level low. Prepare to charge or replace the battery.
 Battery exhausted.	Cannot take pictures. Charge or replace the battery.

Number of Exposures Remaining

The number of exposures remaining is displayed.

- When a memory card is not inserted,  is displayed and pictures are recorded to the internal memory (COOLPIX S9300: approx. 26 MB; COOLPIX S9200: approx. 25 MB).
- The number of pictures that can be stored depends on the remaining capacity of the internal memory or memory card and the image mode setting (📖72).
- The number of exposures remaining shown in the illustration differs from the actual value.

Turning the Camera On and Off

- When the camera is turned on, the power-on lamp (green) lights and the monitor is turned on (the power-on lamp turns off when the monitor is turned on).
- To turn off the camera, press the power switch. Both the monitor and the power-on lamp are turned off.
- To turn on the camera in playback mode, press and hold the  (playback) button. At this time, the lens does not extend.

Power Saving Function (Auto Off)

If no operations are performed for a while, the monitor will turn off, the camera will enter standby mode, and the power-on lamp will flash. If no operations are performed for another three minutes, the camera will turn off automatically.

To turn on the monitor again in standby mode, perform either one of the following operations.

- Press the power switch, shutter-release button,  button, or  (movie-record) button.
- Rotate the mode dial.

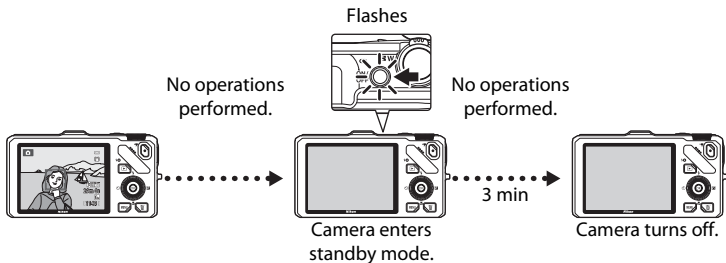

- The time that elapses before the camera enters standby mode can be changed using the **Auto off** setting in the setup menu (101).
- By default, the camera enters standby mode in about one minute when you are using shooting mode or playback mode.
- If you are using the optional AC Adapter EH-62F, the camera enters standby mode after 30 minutes. This setting cannot be changed.

Setting the Display Language, Date, and Time

Dialogs for language selection and camera clock setting are displayed the first time the camera is turned on.

- 1 Press the multi selector ▲ or ▼ to choose the desired language and press the OK button.

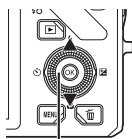

Multi selector

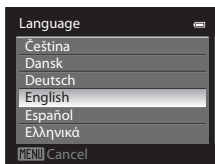

- 2 Press ▲ or ▼ to choose Yes and press the OK button.

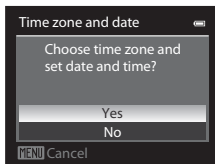

- 3 Press ◀ or ▶ to select your home time zone (Time zone), and press the OK button.

- See “Daylight Saving Time” (📖23) for more information.

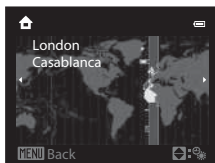
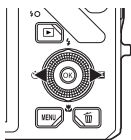

- 4 Press ▲ or ▼ to choose the date display order and press the OK button or ▶.

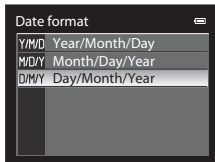

- 5 Press ▲, ▼, ◀ or ▶ to set date and time, and press the OK button.

- Choose an item: Press ▶ or ◀ (selected in the following order: **D** (day) → **M** (month) → **Y** (year) → **hour** → **minute**).
- Set the contents: Press ▲ or ▼. Date and time can also be set by rotating the multi selector.
- Confirm the settings: Select the **minute** field and press the OK button or ▶.

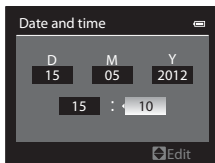

6 Press ▲ or ▼ to choose **Yes** and press the **OK** button.

- After finishing the setting, the lens extends and the shooting screen is displayed.

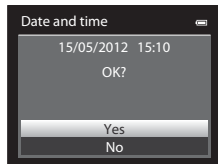

Daylight Saving Time

If daylight saving time is in effect, press the multi selector ▲ to enable the daylight saving time function while setting the region in step 3.

☀ is displayed at the top of the monitor.

Press ▼ to disable the daylight saving time function.

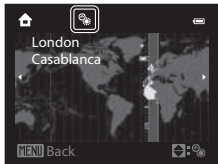

Changing the Language Setting and the Date and Time Setting

- You can change these settings using the **Language** and **Time zone and date** settings in **Y** setup menu (📖100).
- In the **Time zone** setting of **Time zone and date** in **Y** setup menu, when the daylight saving time function is enabled, the camera's clock is set forward by one hour, and when disabled, set back by one hour. When the ➔ travel destination is set, the camera automatically calculates the time difference between the travel destination and the 🏠 home time zone, and saves images using the date and time of the travel destination.
- If you exit without setting the date and time, ⌚ flashes when the shooting screen is displayed. Use the **Time zone and date** setting in the setup menu (📖100) to set the date and time.

The Clock Battery



- The camera's clock is powered by a backup battery that is separate from the camera's main battery.
- The backup battery charges after about ten hours of charging when the main battery is inserted into the camera or when the camera is connected to an optional AC adapter, and can store the set date and time for several days.
- If the camera's backup battery becomes exhausted, the date and time setting screen is displayed when the camera is turned on. Set the date and time again. See step 2 of "Setting the Display Language, Date, and Time" (📖22) for more information.

Imprinting the Shooting Date in Printed Images



- Set the date and time before shooting.
- You can imprint the shooting date in images as they are captured by setting **Print date** in the setup menu (📖100).
- If you want the shooting date to be printed without using the **Print date** setting, print using the ViewNX 2 software (📖83).

Step 2 Select a Shooting Mode

Rotate the mode dial to select the shooting mode.

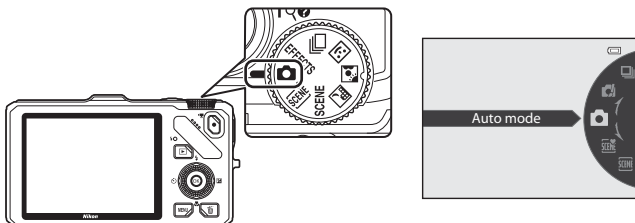
- The following describes how to take pictures in  (auto) mode as an example. Rotate the mode dial to .



- The camera switches to  (auto) mode and the shooting mode icon changes to .

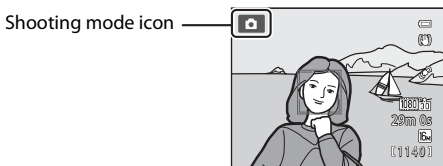

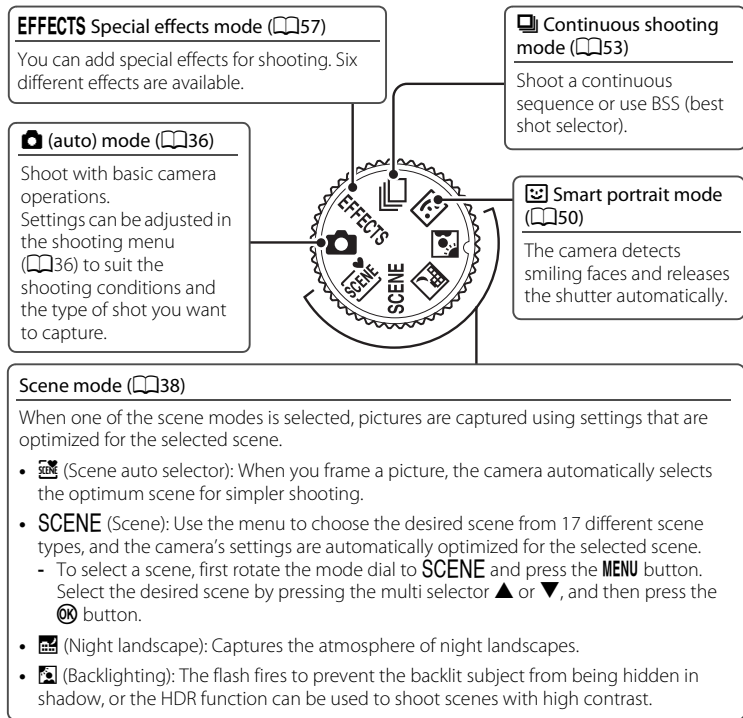

- See “The Monitor” ()6 for more information.

Available Shooting Modes



Features That Are Available in Shooting Mode

- The functions of the multi selector **▲** () , **▼** () , **◀** () or **▶** () can be set. See "Features That Can Be Set Using the Multi Selector" (p.59) for more information.
- Press the **MENU** button to display the menu for the selected shooting mode. See "Shooting Features" (p.35) for more information about the settings available in the menu for the current shooting mode.

Step 3 Frame a Picture

1 Ready the camera.

- Keep fingers, hair and other objects away from the lens, flash, AF assist-illuminator and microphone.

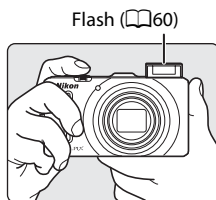

- When using the flash while taking pictures in portrait ("tall") orientation, turn the camera so that the flash is above the lens.

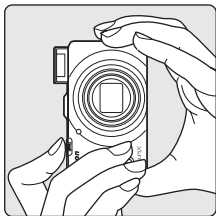

2 Frame the picture.

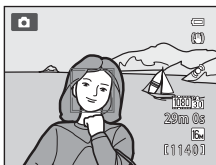

- When the camera detects a human face, that face is framed by a yellow double border (focus area) (default setting).
- When the camera detects more than one face, the face closest to the camera is framed by a double border and the others by single borders.
- When taking pictures of non-human subjects or when no faces are detected, the focus area is not displayed. Position the main subject near the center of the frame.



ISO Sensitivity

ISO (ISO sensitivity, 6) may be displayed on the shooting screen. When **ISO** is displayed, the ISO sensitivity is automatically raised.

Using a Tripod

- In the following situations, use of a tripod is recommended to avoid the effects of camera shake:
 - When shooting in a dark location or with the flash mode (61) set to  (off)
 - When shooting in the telephoto zoom position
- To take a picture with the camera attached to a tripod, set **Vibration reduction** in the setup menu (100) to **Off**.

Using the Zoom

Rotate the zoom control to activate the optical zoom.

- To zoom in so that the subject fills a larger area of the frame, rotate toward **T** (telephoto zoom position).
- To zoom out so that the area visible increases in the frame, rotate toward **W** (wide-angle position).
- When the power is turned on, the zoom is at the maximum wide-angle position.
- Rotating the zoom control all the way in either direction adjusts the zoom quickly, while rotating the control partially adjusts the zoom slowly (except during movie recording).
- A zoom indicator is displayed at the top of the monitor when the zoom control is rotated.

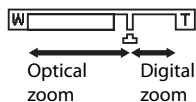
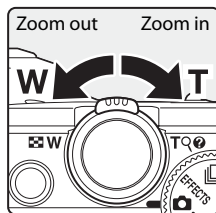

Digital Zoom

When the camera is already at the maximum optical zoom position, rotating the zoom control toward **T** (telephoto zoom position) triggers the digital zoom.

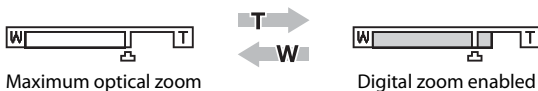

Digital zoom can magnify the subject up to about 4x beyond the maximum magnification of the optical zoom.



- The focus will be at the center of the frame and the focus area will not be displayed when the digital zoom is in effect.

Digital Zoom and Interpolation

Unlike the optical zoom, the digital zoom uses a digital imaging process known as interpolation to magnify images, resulting in slight deterioration of image quality depending on the image mode (📖71) and digital zoom magnification.

 indicates the zoom position where interpolation is applied when shooting still pictures. When the zoom is increased beyond the  position, interpolation is initiated and the zoom indicator also turns yellow.

 moves to the right as the image size becomes smaller, allowing you to confirm the zoom position that can be used to capture still images without image degradation before shooting at the current image mode setting.



When the image size is small

- Digital zoom can be disabled from the **Digital zoom** option in the setup menu (📖100).

Step 4 Focus and Shoot

1 Press the shutter-release button halfway, i.e., press the button slightly until you feel resistance.

- When you press the shutter-release button halfway, the camera sets the focus and exposure (shutter speed and aperture value). Focus and exposure remain locked while the shutter-release button is pressed halfway.

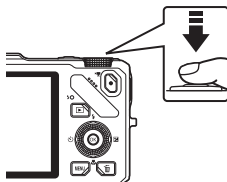

- When a face is detected:
Focuses on the face around which a double border (focus area) is displayed (see "Using Face Detection" (📖75) for more information). When the camera has focused on that face, the double border will turn green.

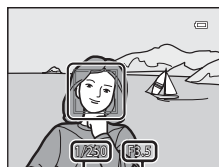

Shutter speed Aperture value

- When a face is not detected:
Selects the focus areas (up to nine) containing the subject closest to the camera. When the subject is in focus, the focus area (active focus area) lights in green (maximum of nine areas).
- When the digital zoom is in effect, the camera focuses on the subject at the center of the screen, and the focus area is not displayed. When the subject is in focus, the focus indicator (📖6) lights in green.
- When the shutter-release button is pressed halfway and the focus area or focus indicator flashes red, the subject is out of focus. Change the composition and press the shutter-release button halfway again.
- If the shutter-release button is pressed halfway when the subject is dimly lit, the AF assist illuminator (📖101) may light.



2 Press the shutter-release button all the way.

- The shutter is released and the picture is recorded.
- If you press the shutter-release button with too much force, the camera may shake, causing images to be blurred. Press the button gently.



✔ Note on Recording Images and Saving Movies

The indicator showing the number of exposures remaining or the indicator showing the maximum movie length flashes while images are being recorded or while a movie is being saved. **Do not open the battery-chamber/memory card slot cover or remove the battery or memory card while an indicator is flashing.** Doing this could result in loss of data, or in damage to the camera or the memory card.

✔ Autofocus

Autofocus may not perform as expected in the following situations. In some rare cases, the subject may not be in focus despite the fact that the active focus area or the focus indicator lights in green:

- Subject is very dark
- Objects of sharply differing brightness are included in the scene (e.g. the sun is behind the subject makes that subject appear very dark)
- No contrast between the subject and surroundings (e.g. a portrait subject, wearing a white shirt, is standing in front of a white wall)
- Several objects are at different distances from the camera (e.g. the subject is inside a cage)
- Subjects with repeating patterns (window blinds, buildings with multiple rows of similarly shaped windows, etc.)
- Subject is moving rapidly

In the situations noted above, try pressing the shutter-release button halfway to refocus several times, or focus on another subject positioned at the same distance from the camera as the actual desired subject, and use focus lock (📖76).

✔ When the Subject Is Close to the Camera

If the camera cannot focus, try shooting with macro mode or the **Close-up** scene mode (📖45).

📌 To Make Sure You Do Not Miss a Shot

If you are concerned that you might miss a shot, press the shutter-release button all the way without first pressing it halfway.

📌 Flash

- If the subject is dimly lit, the flash will pop up automatically when you press the shutter-release button halfway when the flash mode is set to **♻️AUTO** (auto; default setting). The flash will fire when you press the shutter-release button all the way down. See “Using the Flash (Flash Modes)” (📖60) for more information.
- Lower the flash by gently pushing it down. When not taking pictures, lower the flash.

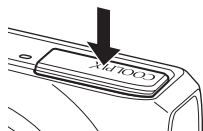
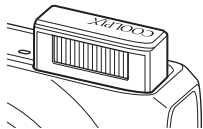

📌 More Information

See “Focusing on the Subject” (📖74) for more information.





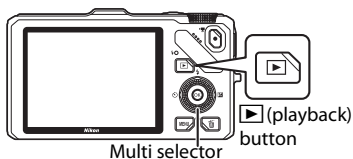

Step 5 Play Back Images

1 Press the (playback) button.

- When you switch from shooting mode to playback mode, the last image saved will be displayed in full-frame playback mode.



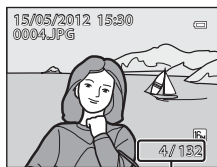

2 Use the multi selector to view previous or next images.

- To view previous images:  or 
- To view next images:  or 
- Images can also be selected by rotating the multi selector.
- To play back images that are saved in the internal memory, remove the memory card.  is displayed in brackets, before "Current image number/total number of images" on the playback screen.
- To return to shooting mode, press the  button again, or press the shutter-release button, or  (movie-record) button.







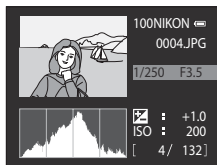

Current image number/
total number of images

Displaying Shooting Information

Press the  button in full-frame playback mode to display the histogram and shooting information (8). Press the  button again to return to full-frame playback mode.



Viewing Pictures

- Pictures taken using face detection (75) or pet detection (48) will be rotated automatically when displayed in full-frame playback mode according to the orientation of the face.
- The orientation of an image can be changed using **Rotate image** in the playback menu (80).
- When pictures taken with the continuous shooting feature are displayed, each series of images is treated as a group, and only the group's "key picture" is displayed (see "Sequence display options" (81) for more information). While the key picture of a sequence is displayed in full-frame playback mode, press the  button to display each image in the sequence individually. To return to key picture only display, press the multi selector .
- Images may be displayed at low resolution immediately after switching to the previous or next image.

Changing How Images Are Displayed

When using playback mode, you can change how images are displayed by rotating the zoom control toward **W** (📐)/**T** (🔍).

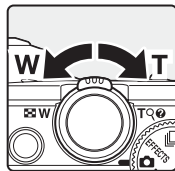

Playback Zoom

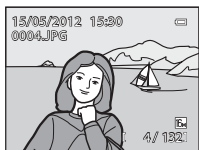

Image is displayed in full-frame playback mode.

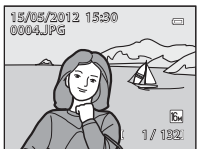

Image is zoomed in.

Display position guide

- To adjust the zoom ratio, rotate the zoom control toward **W** (📐)/**T** (🔍). The zoom increases up to about 10x.
- To view a different area of the image, press the multi selector **▲**, **▼**, **◀**, or **▶**.
- Pictures taken using face detection (📖75) or pet detection (📖48) are enlarged at the center of the face that was detected during shooting. If the camera detected multiple faces when the image was captured, use **▲**, **▼**, **◀**, and **▶** to display a different face. Change the zoom ratio and press **▲**, **▼**, **◀**, or **▶** to zoom in on an area of the image where there are no faces.
- You can crop the image and save the displayed area of the image as a separate file by pressing the **MENU** button (🔑22).
- Press the **OK** button to return to full-frame playback mode.

Thumbnail Playback, Calendar Display



Full-frame playback mode

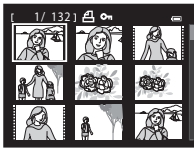



Image thumbnail display
(4, 9, 16 and 72 images per screen)







Calendar display

- You can view several images on one screen, making it easy to find the image you want.
- You can change the number of images displayed by rotating the zoom control toward **W** (📐)/**T** (🔍).
- Rotate the multi selector or press **▲**, **▼**, **◀**, or **▶** to select an image and then press the **OK** button to display that image in full-frame playback mode.
- When 72 images are displayed, rotate the zoom control toward **W** (📐) to switch to calendar display.
- While using calendar display mode, rotate the multi selector or press **▲**, **▼**, **◀**, or **▶** to select a date and then press the **OK** button to display the first image captured on that day.

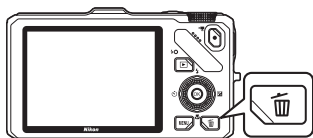
Step 6 Delete Unwanted Images



- 1 Press the  button to delete the image currently displayed on the monitor.



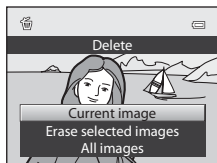

- 2 Press the multi selector  or  to select the desired deletion method and press the  button.

- **Current image:** Only the current image is deleted. If the key picture of a sequence is selected, all images in the sequence are deleted.
- **Erase selected images:** Multiple images can be selected and deleted. See “Operating the Erase Selected Images Screen” (83) for more information.
- **All images:** All images are deleted.
- To exit without deleting, press the **MENU** button.



- 3 Press  or  to select **Yes** and press the  button.

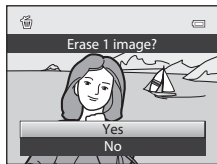

- Deleted images cannot be recovered.
- To cancel, press  or  to select **No** and press the  button.



Notes on Deletion

- Deleted images cannot be recovered. Transfer important images to a computer before deleting them.
- Protected images cannot be deleted (80).

Deleting Images in a Sequence

- When images are taken with continuous shooting, each series of images is treated as a group (pictures in a sequence) and only the group's “key picture” is displayed in the default setting (87).
- When you press the  button during key picture playback, all images in the key picture's sequence can be deleted (88).
- To delete each picture in a sequence, before pressing the  button, press the  button to display each image in the sequence individually.

Deleting the Last Image Captured While in Shooting Mode

When using shooting mode, press the  button to delete the last image that was saved.

Operating the Erase Selected Images Screen

1 Press the multi selector ◀ or ▶ to select an image to be deleted, and then press ▲ to display ✓.

- To cancel the selection, press ▼ to remove ✓.
- Rotate the zoom control (📖27) toward **T** (🔍) to switch back to full-frame playback or **W** (🖼️) to display thumbnails.



2 Add ✓ to all images that you want to delete and then press the **OK** button to apply the selection.

- A confirmation dialog is displayed. Follow the instructions displayed on the monitor.

Selecting Certain Types of Images for Deletion



When using favorite pictures mode, auto sort mode, or list by date mode (📖78), images in the same album or category, or pictures taken on the same date can be deleted.



A series of horizontal dashed lines spanning the width of the page, intended for handwriting practice. There are 15 lines in total, starting from the top right and extending to the bottom left.









(Auto) Mode

Shooting with basic camera operations is available. Set the options in the auto shooting menu ()36) according to the shooting conditions and the kind of images you want to capture.

- The focus area differs depending on the setting of **AF area mode** ()37) that can be selected in the  tab after pressing the **MENU** button.
- When **AF area mode** is set to **Face priority** (default setting), the camera focuses as follows:
 - The camera detects and focuses on faces (see “Using Face Detection” ()75) for more information).
 - If no faces are detected, the camera automatically selects the focus areas (up to nine) containing the subject closest to the camera. When the subject is in focus, the focus area (active focus area) lights in green (maximum of nine areas).





Changing (Auto) Mode Settings

- See “Features That Can Be Set Using the Multi Selector” ()59) for more information on flash mode ()60), self-timer ()63), macro mode ()64), and creative slider () brightness (exposure compensation), ) vividness, ) hue ()65).
- See “Options Available in the Shooting Menu () (Auto) Mode)” (below) for more information on functions that can be set using the **MENU** button.

Options Available in the Shooting Menu ((Auto) Mode)

In  (auto) mode, the following option settings can be changed.

Select  (auto) mode → **MENU** button →  tab ()11)

- The same options can be set in continuous shooting mode ()53). Settings for options other than **Continuous** are also applied to  (auto) mode, and the settings are saved in the camera’s memory even if the camera is turned off.

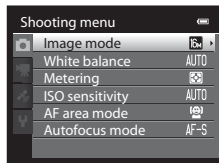

Option	Description	
Image mode	Set the combination of image size and image quality to be recorded (71). The default setting is 4608×3456 . This setting is also applied to other shooting modes.	71
White balance	Adjust colors in the image closer to the colors as they appear to the eye. Although Auto (default setting) can be used under most types of lighting, you can apply the white balance setting suited to the sky conditions or light source to achieve better results if the default setting results are unsatisfactory. <ul style="list-style-type: none"> When the white balance setting is other than Auto or Flash, set the flash mode (60) to (off). 	33
Metering	Select the method that the camera uses to measure the brightness of the subject. The camera adjusts the exposure, which is a combination of shutter speed and aperture value, based on the brightness measurement. The default setting is Matrix .	35
ISO sensitivity	Higher ISO sensitivity allows you to take pictures of darker subjects. Additionally, even with subjects of similar brightness, pictures can be taken at faster shutter speeds, and blurring caused by camera shake and subject movement can be reduced. When ISO sensitivity is set to Auto (default setting), the camera sets the ISO sensitivity automatically. <ul style="list-style-type: none"> With the Auto setting, ISO (26) is displayed on the shooting screen when the ISO sensitivity is automatically increased. 	36
AF area mode	Choose how the focus area is determined from Face priority (default setting), Auto , Manual , Center , or Subject tracking .	37
Autofocus mode	When Single AF (default setting) is selected, the camera focuses only while the shutter-release button is pressed halfway. When Full-time AF is selected, the camera focuses even when the shutter-release button is not pressed halfway. You may hear the sound of the camera focusing.	40



Features That Cannot Be Used Simultaneously

This feature may not be used in combination with certain features (73).

Scene Mode (Shooting Suited to Scenes)

When one of the following scenes is selected using the mode dial or the scene menu, images are captured using settings that are optimized for the selected scene.

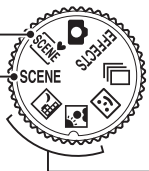

 (Scene auto selector)
([43](#))

When you frame a picture, the camera automatically selects the optimum scene for simpler shooting.



















 Night landscape ([40](#))

 Backlighting ([41](#))

Rotate the mode dial to  or  and take pictures.



SCENE (Scene)

Press the **MENU** button to display the scene menu and choose one of the following shooting scenes.

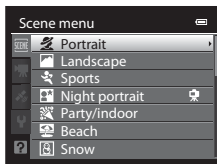
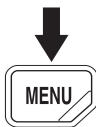
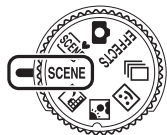
 Portrait (default setting) (42)	 Close-up (45)
 Landscape (42)	 Food (45)
 Sports (42)	 Museum (46)
 Night portrait (43)	 Fireworks show (46)
 Party/indoor (44)	 Black and white copy (46)
 Beach (44)	 Easy panorama (47)
 Snow (44)	 Pet portrait (48)
 Sunset (44)	3D 3D photography (49)
 Dusk/dawn (44)	



View a Description (Help Information) of Each Scene

Select the desired scene from the scene menu and rotate the zoom control ([4](#)) toward **T** () to view a description (help) of that scene. To return to the original screen, rotate the zoom control toward **T** () again.

Changing Scene Mode Settings







- “Features That Can Be Set Using the Multi Selector” (📖59) vary with scene mode. See “List of the Default Settings” (📖69) for more information.
- Functions that can be set using the **MENU** button: The combination of image size and image quality (Image mode) (📖71) (except for **Easy panorama** and **3D photography**).

Characteristics of Each Scene Mode

- Use of a tripod is recommended in scene modes with  indicated. Set **Vibration reduction** in the setup menu (📖100) to **Off** when using a tripod to stabilize the camera.



Scene auto selector

When you frame a picture, the camera automatically selects the optimum scene for simpler shooting.

: Portrait, : Landscape, : Night portrait, : Night landscape, : Close-up, : Backlighting, : Other scenes

- When the camera automatically selects a scene mode, the shooting mode icon changes to that for the scene mode currently enabled.
- The camera automatically selects the focus area for autofocus in accordance with the composition. The camera detects and focuses on faces (see “Using Face Detection” (📖75) for more information).
- Depending upon shooting conditions, the camera may not select the desired scene mode. Should this occur, switch to  (auto) mode (📖24) or select the optimum scene mode for the subject manually.
- The digital zoom is not available.





If Night Landscape or Night Portrait Is Selected When Shooting with Scene Auto Selector

- If the camera switches to  (Night landscape), the flash switches to off (🔒) (off) regardless of the flash mode setting and the camera shoots a single picture at slow shutter speeds.
- If the camera switches to  (Night portrait), the flash mode switches to slow sync with red-eye reduction fill flash and the camera shoots a single picture at slow shutter speeds.

Night landscape

Use this mode to capture the atmosphere of night landscapes. Press the **MENU** button to select **Hand-held** or **Tripod** in **Night landscape**.





- **Hand-held** (default setting): This enables you to shoot with the minimum of camera shake and noise even when holding the camera by hand.
 - The  icon is displayed on the shooting screen.
 - When the  icon in the upper left of the monitor lights in green and the shutter-release button is pressed all the way, pictures are shot continuously, and the camera combines these pictures to save a single picture.
 - Once the shutter-release button is pressed all the way, hold the camera steady without moving it until a still picture is displayed. After taking a picture, do not turn the camera off before the monitor switches to the shooting screen.
 - The angle of view (image area) seen in the saved image will be narrower than that seen on the monitor at the time of shooting.
- **Tripod**: Select this mode when the camera is stabilized, such as with a tripod.
 - The  icon is displayed on the shooting screen.
 - **Vibration reduction** (101) is automatically set to **Off** regardless of the applied option in the setup menu.
 - Press the shutter-release button all the way to shoot a single picture at slow shutter speeds.
- When the shutter-release button is pressed halfway, the focus area or focus indicator (6) always lights in green.
- The digital zoom is not available.

Backlighting

Use when light is coming from behind the subject, throwing features or details into shadow. Press the **MENU** button to set whether or not to save an image with HDR (high dynamic range) composition using the **HDR** setting in **Backlighting**.

- When **HDR** is set to **Off** (default setting): The flash fires to prevent the backlit subject from being hidden in shadow.
 - The camera focuses at the center area of the frame.
 - Press the shutter-release button all the way to shoot a single picture.



- When **HDR** is set to **On**: Use when taking pictures with very bright and dark areas in the same frame.
 - The **HDR** icon is displayed on the shooting screen.
 - The camera focuses at the center area of the frame.
 - When the shutter-release button is pressed all the way, the camera shoots pictures continuously and saves the following two images.
 - Non-HDR composite image
 - HDR composite image (loss of detail is reduced in highlights and shadows)
 - The second image saved is an HDR composite image. If there is only enough memory to save one image, an image processed by D-Lighting () at the time of shooting, in which dark areas of the image are corrected, is the only image saved.
 - Once the shutter-release button is pressed all the way, hold the camera steady without moving it until a still picture is displayed. After taking a picture, do not turn the camera off before the monitor switches to the shooting screen.
 - The angle of view (i.e., the area visible in the frame) seen in the saved image will be narrower than that seen on the monitor at the time of shooting.
 - Use of a tripod is recommended. Set **Vibration reduction** in the setup menu () to **Off** when using a tripod to stabilize the camera.
 - The digital zoom is not available.



Scene Mode (Shooting Suited to Scenes)

SCENE → Portrait

Use this mode for portraits.

- The camera detects and focuses on a face (see “Using Face Detection” (📖75) for more information).
- After the skin softening feature makes facial skin tones softer, the camera records the image (📖52).
- If no faces are detected, the camera focuses on the subject at the center of the frame.
- The digital zoom is not available.



SCENE → Landscape

Use this mode for vivid landscapes and cityscapes.

- When the shutter-release button is pressed halfway, the focus area or focus indicator (📖6) always lights in green.



SCENE → Sports

Use this mode when shooting sporting events. The camera captures a series of still images that allow you to clearly see detailed movements in a moving subject.

- The camera focuses at the center area of the frame.
- To capture a series of images, hold down the shutter-release button all the way. About six pictures are shot at a rate of about two frames per second (fps) (when image mode is set to  **4608x3456**).
- The camera focuses the subject even when the shutter-release button is not pressed halfway. You may hear the sound of the camera focusing.
- Focus, exposure, and hue are fixed at the values determined with the first shot in each series.
- The frame rate with continuous shooting may become slow depending upon the current image mode setting, image size setting, memory card used, or shooting condition.









SCENE →  **Night portrait**

Use this mode for portraits taken at sunset or at night. Flash is used to illuminate the subject while maintaining the mood of the background.

Select **Hand-held** or **Tripod** on the screen that is displayed when  **Night portrait** scene mode is selected.



- **Hand-held:**
 - The  icon is displayed on the shooting screen.
 - When the  icon in the upper left of the monitor lights in green and the shutter-release button is pressed all the way, pictures are shot continuously. The camera combines these pictures to save a single picture.
 - Once the shutter-release button is pressed all the way, hold the camera steady without moving it until a still picture is displayed. After taking a picture, do not turn the camera off before the monitor switches to the shooting screen.
 - If the subject moves while the camera is shooting continuously, the image may be distorted, overlapped or blurred.
 - The angle of view (i.e., the area visible in the frame) seen in the saved image will be narrower than that seen in the monitor at the time of shooting.
- **Tripod** (default setting): Select this mode when the camera is stabilized, such as with a tripod.
 - The  icon is displayed on the shooting screen.
 - **Vibration reduction** ( 101) is automatically set to **Off** regardless of the applied option in the setup menu.
 - Press the shutter-release button all the way to shoot a single picture at slow shutter speeds.
- The camera detects and focuses on a face (see "Using Face Detection" ( 75) for more information).
- After the skin softening feature makes facial skin tones softer, the camera records the image ( 52).
- If no faces are detected, the camera focuses on the subject at the center of the frame.
- The digital zoom is not available.

Scene Mode (Shooting Suited to Scenes)

SCENE → Party/indoor

Suitable for taking pictures in parties. Captures the effects of candlelight and other indoor background lighting.

- The camera focuses at the center area of the frame.
- When shooting in a dark location, hold the camera steadily to avoid the effects of camera shake. To take a picture with the camera attached to a tripod, set **Vibration reduction** in the setup menu (📖100) to **Off**.



SCENE → Beach

Captures the brightness of such subjects as beaches or sunlit expanses of water.

- The camera focuses at the center area of the frame.



SCENE → Snow

Captures the brightness of sunlit snow.

- The camera focuses at the center area of the frame.



SCENE → Sunset



Preserves the deep hues seen in sunsets and sunrises.

- The camera focuses at the center area of the frame.



SCENE → Dusk/dawn









Preserves the colors seen in the weak natural light before sunrise or after sunset.



- When the shutter-release button is pressed halfway, the focus area or focus indicator (📖6) always lights in green.







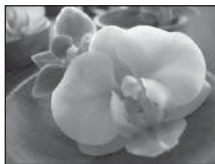



SCENE →  Close-up

Use this mode to photograph flowers, insects, and other small objects at close range.

- **Macro mode** ( 64) is set to ON and the camera automatically zooms to the closest position to the subject where the camera can shoot.
- You can move the focus area that the camera focuses on. Press the  button and then rotate the multi selector or press , , , or  to move the focus area. To adjust the following settings, press the  button to temporarily cancel focus area selection, and then adjust each setting.
 - Flash mode
 - Self-timer
 - Exposure compensation
- The camera focuses on the subject even when the shutter-release button is not pressed halfway. You may hear the sound of the camera focusing.

SCENE →  Food

Use this mode when taking pictures of food.

- **Macro mode** ( 64) is set to ON and the camera automatically zooms to the closest position to the subject where the camera can shoot.
- You can adjust the hue by pressing the multi selector  or . The hue adjustment setting is saved in the camera's memory even after the camera is turned off.
- You can move the focus area that the camera focuses on. Press the  button and then rotate the multi selector or press , , , or  to move the focus area. To adjust the following settings, press the  button to temporarily cancel focus area selection, and then adjust each setting.
 - Hue
 - Self-timer
 - Exposure compensation
- The camera focuses on the subject even when the shutter-release button is not pressed halfway. You may hear the sound of the camera focusing.

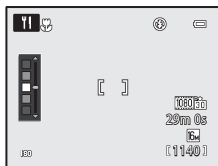

Scene Mode (Shooting Suited to Scenes)

SCENE → Museum

Use indoors where flash photography is prohibited (for example, in museums and art galleries) or in other settings in which you do not want to use the flash.

- The camera focuses at the center area of the frame.
- The camera captures up to ten images while the shutter-release button is pressed all the way, and the sharpest image in the series is automatically selected and saved (BSS (Best Shot Selector) (📖56)).



SCENE → Fireworks show



Slow shutter speeds are used to capture the expanding burst of light from fireworks.

- The camera focuses at infinity.
- When the shutter-release button is pressed halfway, the focus indicator (📖6) always lights in green.
- Only the five optical zoom positions shown on the right can be applied. When the zoom control is rotated, zoom will not stop at any position other than the five indicated (digital zoom is available).

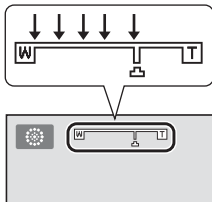

SCENE → Black and white copy

Provides clear images of text or drawings on a white board or in print.

- The camera focuses at the center area of the frame.
- When shooting nearby object, shoot in combination with macro mode.



SCENE →  Easy panorama

Shoots panorama pictures that can be played back on the camera by moving the camera in the direction you want to create a panorama picture.

When the  **Easy panorama** scene mode is selected, the shooting range can be selected from **Normal (180°)** (default setting) or **Wide (360°)**.

- Press the shutter-release button all the way and release it, then slowly move the camera horizontally. Shooting ends automatically when the selected shooting range has been captured.
- When shooting starts, the camera focuses on the subject at the center area of the frame.
- The zoom is fixed at the wide-angle position.
- Display the picture recorded with easy panorama in full-frame playback mode and press the  button. The camera displays the short side of the picture filling the entire screen and scrolls the picture automatically.

See “Using Easy Panorama (Shooting and Playing Back)” (2).



Note on Printing Panorama Pictures

When printing panorama pictures, a full view may not be printed depending on the printer settings. Additionally, printing may not be available depending on the printer.

For more information, see your printer's manual or contact a digital photo lab.



SCENE → 🐾 Pet portrait

Use this mode for shooting pictures of dogs or cats.

- Select **Single** or **Continuous** on the screen that is displayed when 🐾 **Pet portrait** scene mode is selected.
 - **Single**: One picture is captured at a time.
 - **Continuous** (default setting): When the camera focuses on the detected face in **Pet portrait auto release** (default setting) mode, three pictures are shot continuously (frame rate with continuous shooting: approximately 1.9 frames per second when image mode is set to  **4608x3456**). If pet portrait auto release is not used, about six pictures are shot at a rate of about 1.9 frames per second while the shutter-release button is fully held down (when image mode is set to  **4608x3456**).
- The camera detects and focuses on the face of a dog or cat. In the default setting, when the subject is in focus, the shutter is released automatically (Pet portrait auto release).
- Up to five pet faces are detected simultaneously. If more than one pet face is detected, the camera focuses on the largest face.
- If a pet's face is not detected, press the shutter-release button halfway to focus on the subject at the center of the frame.
- Press the multi selector ◀ (🔄) to change the pet portrait auto release settings.
 - **Pet portrait auto release** (default setting): When the camera focuses on the detected face, the shutter is released automatically. When **Pet portrait auto release** is set, the  icon is displayed on the shooting screen.
 - **OFF**: Press the shutter-release button to release the shutter.
- In the following situations, **Pet portrait auto release** is automatically switched to **OFF**.
 - When a continuous shooting series with pet portrait auto release is repeated five times.
 - When remaining capacity of the internal memory or memory card is low
 To continue shooting with pet portrait auto release, press the multi selector ◀ (🔄) to set again.
- The digital zoom is not available.
- Under some shooting conditions such as pet-to-camera distance, speed of moving pets, direction in which the pets are facing, and brightness of the faces, the camera may be unable to detect a dog or cat, or a border is displayed around something other than a dog or cat.









✔ Viewing Pictures Taken Using Pet Detection

- During playback, the camera automatically rotates images according to the orientation of the pet's face detected at the time of shooting (except for pictures taken using **Continuous** (55) mode).
- When zooming in on an image displayed in full-frame playback mode by rotating the zoom control toward **T** (🔍), the image is enlarged at the center of a pet's face detected during shooting (31) (except for pictures taken using **Continuous** (55) mode).

SCENE → 3D 3D photography



Use this mode for taking 3D pictures viewable in three dimensions on a 3D-compatible TV or monitor. The camera takes one picture for each eye to simulate a three-dimensional image. Pictures taken in this mode are saved with  (image size: 1920 × 1080 pixels) as the image mode.

- After taking the first picture by pressing the shutter-release button, move the camera horizontally to the right so that the subject is aligned with the guide on the monitor. The camera takes the second picture automatically.
- The focus area that the camera focuses on can be moved to areas other than at the center of the frame. To move the focus area, press the  button before taking the first picture, and then rotate the multi-selector or press , , , or . To adjust the following settings, press the  button to cancel the status in which the focus area can be selected, and then perform each setting.
 - Macro mode
 - Exposure compensation
- You cannot set the telephoto zoom position beyond 124 mm (equivalent to 35mm [135] format).
- The angle of view (i.e., the area visible in the frame) seen in the saved picture will be narrower than that seen on the monitor at the time of shooting.
- The camera cannot record 3D movies.
- The two captured images are saved as a 3D picture (MPO file) consisting of the left and right eye images. The first image (the left eye image) is also saved as a JPEG file. See "Using 3D Photography" ( 05) for more information.

 Note on 3D Photography

The camera may be unable to take a second picture or save pictures taken, depending on a variety of factors, for example, shooting a moving subject or a scene with low light or low contrast conditions.

 Viewing 3D Photography

- 3D pictures cannot be played back in 3D on the camera monitor. Only the left eye image is displayed during playback.
- To view 3D pictures in 3D, a 3D-compatible TV or monitor is required. 3D pictures can be played back in 3D by connecting the camera to a 3D-compatible TV or monitor using a 3D-compatible HDMI cable ( 82).
- When connecting the camera using an HDMI cable, set the following for the **TV settings** in the setup menu ( 100).
 - **HDMI: Auto** (default setting) or **1080i**
 - **HDMI 3D output: On** (default setting)
- When the camera is connected using an HDMI cable for playback, it may take a while to switch the display between 3D pictures and non-3D pictures. The images played back in 3D cannot be enlarged.
- See the documentation included with your TV or monitor to perform settings of the TV or monitor.

 Note on Viewing 3D Pictures

When viewing 3D pictures on a 3D-compatible TV or monitor for an extended period of time, you may experience discomfort such as eye strain or nausea. Carefully read the documentation included with your TV or monitor to ensure proper use.

Smart Portrait Mode (Shooting Smiling Faces)

If the camera detects smiling faces, the shutter is automatically released without pressing the shutter-release button (Smile timer). The skin softening function (📖52) makes facial skin tones softer.

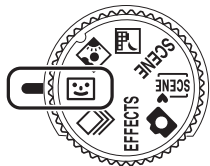

1 Frame the picture and wait for the subject to smile.

- When the camera detects a human face, a yellow double border (focus area) is displayed around that face. When the camera has focused on that face, the double border will light in green for a moment and focus is locked.
- Up to three faces can be detected. When more than one face is detected, the face closest to the center of the frame is framed by a double border and the others by single borders.
- If the camera detects that the face framed by the double border is smiling, the **Smile timer** (📖51) feature is activated and the shutter is automatically released.
- Each time the shutter is released, automatic shooting using face detection and smile detection is repeated.

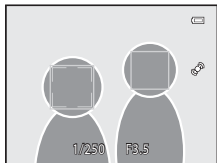

2 Shooting ends.

- To finish automatic shooting of smile detection, perform any of the following operations.
 - Turn off the camera.
 - Set the **Smile timer** to **Off**.
 - Rotate the mode dial to switch to a shooting mode other than 📷 (Smart portrait) mode.

✔ Notes on Smart Portrait Mode

- The digital zoom is not available.
- Under some shooting conditions, faces and smiling faces may not be detected properly.
- See “Notes on Face Detection” (📖75) for more information.

✍ Auto Off in Smile Timer Mode

When using the **Smile timer**, the auto off function (📖101) is activated and the camera turns off when either of the situations indicated below persists and no other operations are performed.

- The camera does not detect any faces.
- The camera detected a face, but cannot detect a smile.

✍ When the Self-timer Lamp Flashes

When the camera detects a face, the self-timer lamp flashes. The lamp quickly flashes immediately after the shutter is released.

Releasing the Shutter Manually

The shutter can also be released by pressing the shutter-release button. If no faces are detected, the camera focuses on the subject at the center of the frame.

Changing Smart Portrait Mode Settings





- See “Features That Can Be Set Using the Multi Selector” (📖59) for more information on flash mode (📖60), self-timer (📖63), and exposure compensation (📖68).
- See “Options Available in the Smart Portrait Menu” (below) for more information on functions that can be set using the **MENU** button.

Options Available in the Smart Portrait Menu

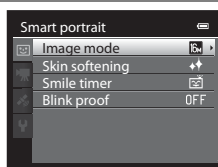
In smart portrait mode, the following option settings can be changed.

Display the shooting screen in smart portrait mode → **MENU** button →  tab



Option	Description	
Image mode	Allow you to select the combination of image size and image quality used when saving images (📖71). The default setting is  4608×3456 . This setting is also applied to other shooting modes.	71
Skin softening	Enable skin softening. The camera makes facial skin tones softer before saving images. The extent of effect applied can be selected. The default setting is Normal .	 41
Smile timer	When set to On (default setting), the camera detects human faces and then automatically releases the shutter whenever a smile is detected. Self-timer cannot be used with this feature.	 41
Blink proof	When On is selected, the camera automatically releases the shutter twice each time a picture is taken. Of the two shots, one in which the subject's eyes are open is saved. The flash cannot be used when On is selected. The default setting is Off .	 42

Features That Cannot Be Used Simultaneously

Some settings cannot be used with other functions (📖73).

Using Skin Softening

In the following shooting modes, the camera detects up to three human faces when the shutter is released, and processes the image to make facial skin tones softer before saving the image.

-  (Scene auto selector) (📖39), **Portrait** (📖42) or **Night portrait** (📖43) in scene mode
- Smart portrait (📖50)

Skin softening can also be applied to saved images (📖80).

Notes on Skin Softening

- It may take more time to save images.
- Under some shooting conditions, the desired skin softening results may not be achieved, or skin softening may be applied to areas of the image where there are no faces. If the desired results are not produced, select another shooting mode or set **Skin softening** to **Off** when using smart portrait mode and shoot again.
- The skin softening level cannot be adjusted when using  (Scene auto selector), **Portrait** or **Night portrait** scene mode.

Continuous Shooting Mode (Burst Shooting)

Use this mode to capture the details of a moving subject by shooting a continuous series of images.

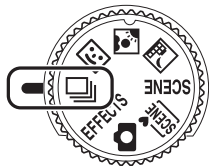

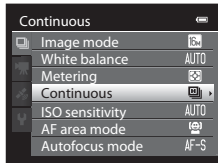

1 Press the MENU button and confirm or change the settings in the continuous menu.

- See "Continuous Menu" (📖55) for more information.
- Press the MENU button after changing the settings and return to the shooting screen.



2 Frame the subject and shoot.

- The focus area differs depending on the setting of **AF area mode** (📖37) that can be selected in the  tab after pressing the MENU button. When **AF area mode** is set to **Face priority** (default setting), the camera detects and focuses on faces, or automatically selects the focus areas (up to nine) containing the subject closest to the camera (📖28). (See "Using Face Detection" (📖75)) for more information.)
- Press the shutter-release button halfway to lock focus and exposure.
- When **Continuous H**, **Continuous L**, **Pre-shooting cache**, or **BSS** is selected in the continuous menu, images are captured while the shutter-release button is held all the way down.
- When **Continuous H: 120 fps**, **Continuous H: 60 fps**, or **Multi-shot 16** is selected in the continuous menu, the number of images determined by the setting are captured when the shutter-release button is pressed all the way. There is no need to hold the shutter-release button down.
- The focus, exposure, and white balance settings are fixed at the values for the first image in each series.
- After taking a picture, the camera returns to the shooting screen. If  is displayed, do not turn the camera off.

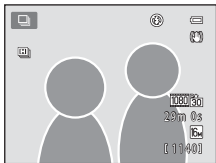

Continuous Shooting Mode (Burst Shooting)

Notes on Continuous Shooting Mode

- It may take some time to save the images after shooting. The amount of time it takes to finish saving the captured images depends on the number of images, image mode, the write speed of the memory card, etc.
- When ISO sensitivity increases, noise may appear in captured images.
- The speed of continuous shooting may decrease depending on the image mode, type of memory card used, and shooting conditions.
- When **Continuous** is set to **Pre-shooting cache**, **Continuous H: 120 fps**, **Continuous H: 60 fps**, or **Multi-shot 16**, banding or variance in brightness or hue may occur in images that were captured under lighting that flickers at high speeds, such as fluorescent, mercury-vapor, or sodium-vapor lighting.

Images Captured in Continuous Shooting Mode

Each time images are captured using **Continuous H**, **Continuous L**, **Pre-shooting cache**, **Continuous H: 120 fps**, or **Continuous H: 60 fps**, the captured images are saved as a "sequence" (📷7).

Changing Continuous Shooting Mode Settings

- Features that can be set using the multi selector (📖59): macro mode (📖64), creative slider (📷 brightness (exposure compensation), 📷 vividness, 📷 hue) (📖65)
- Features that can be set by pressing the **MENU** button: See "Options Available in the Continuous Shooting Menu" (📖55).

Features That Cannot Be Used Simultaneously

Some settings cannot be used with other functions (📖73).

Options Available in the Continuous Shooting Menu

You can select the type of continuous shooting in the continuous shooting menu, in addition to the same options (📖37) that are available when using 📷 (auto) mode, such as image mode and white balance.

Display the shooting screen in continuous shooting mode → MENU button → 📷 tab

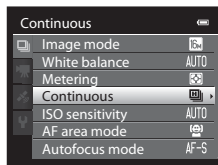

- For options other than for **Continuous**, see "Options Available in the Shooting Menu (📷 (Auto) Mode)" (📖36).
- Settings for options other than **Continuous** are also applied to 📷 (auto) mode, and the settings are saved in the camera's memory even if the camera is turned off.



Continuous Shooting (Options)

Option	Description
📷 Continuous H (default setting)	While the shutter-release button is held all the way down, images are captured continuously at a rate of about 6.9 fps (when image mode is set to 📷 4608x3456). Shooting ends when the shutter-release button is released, or seven images have been captured.
📷 Continuous L	While the shutter-release button is held all the way down, about six images are captured continuously at a rate of about 2 fps (when image mode is set to 📷 4608x3456). Shooting ends when the shutter-release button is released.
📷 Pre-shooting cache	Pre-shooting cache makes it easy to capture perfect moments, by saving images from before the shutter-release button was pressed all the way. Pre-shooting cache shooting begins when the shutter-release button is pressed halfway, and continues when the shutter-release button is pressed all the way (📖56). <ul style="list-style-type: none"> • Frame rate: up to 10.6 fps • Number of frames: up to 5 frames (including up to 2 frames captured in the pre-shooting cache) Shooting ends when the shutter-release button is released or when the maximum number of frames have been shot.
📷 120 Continuous H: 120 fps	Each time the shutter-release button is pressed all the way, 50 frames are captured at a shutter speed of about 1/120 s or faster. The image mode is fixed at 📷 (image size: 640 × 480 pixels).
📷 60 Continuous H: 60 fps	Each time the shutter-release button is pressed all the way, 25 frames are captured at a shutter speed of about 1/60 s or faster. The image mode is fixed at 📷 (image size: 1280 × 960 pixels).

Continuous Shooting Mode (Burst Shooting)

Option	Description
 BSS (Best Shot Selector)	<p>The "best shot selector" is recommended when shooting with the flash off or the camera zoomed in, or in other situations in which inadvertent motion can result in blurred images. The camera captures a series of up to 10 images while the shutter-release button is held all the way down, and the sharpest image in the series is automatically selected and saved.</p> <p>BSS is suited for shooting stationary subjects. BSS may not produce the desired results if the subject moves or the composition changes.</p>
 Multi-shot 16	<p>Each time the shutter-release button is pressed, camera takes 16 shots at a rate of about 30 fps and arranges them in a single image.</p> <ul style="list-style-type: none">• The image mode is fixed at  (image size: 2560 × 1920 pixels).• The digital zoom is not available.

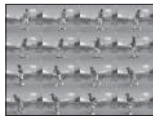

Pre-shooting Cache

When **Pre-shooting cache** is selected, shooting begins when the shutter-release button is pressed halfway for 0.5 seconds or longer, and images captured before the shutter-release button is pressed all the way are saved along with images captured after the shutter-release button is pressed all the way. Up to two images can be saved in the pre-shooting cache.

The current pre-shooting cache setting is indicated by an icon when shooting ( 6). The pre-shooting cache icon lights in green while the shutter-release button is pressed halfway.

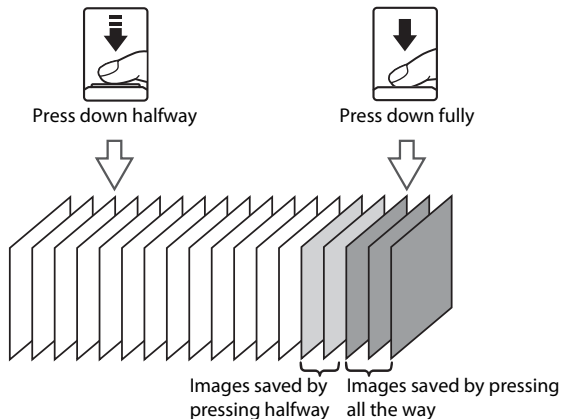

- If the number of exposures remaining is less than five, the pictures taken with the pre-shooting cache are not recorded. Before shooting, check that there are five or more exposures remaining.

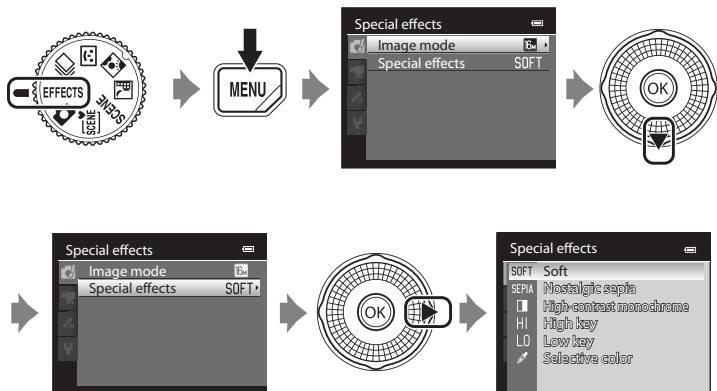

Special Effects Mode (Applying Effects When Shooting)

You can add special effects for shooting. One of six different effects can be selected. To select an effect, press the **MENU** button to display the special effects menu.



- The camera focuses at the center area of the frame.

Characteristics of Each Special Effect

Option	Description
SOFT Soft (default setting)	Add a gentle blur to the entire picture to create a soft ambience.
SEPIA Nostalgic sepia	Add a sepia tone with low contrast to make it look like an old picture.
 High-contrast monochrome	Create a black-and-white photograph with a clear contrast.
HI High key	Add a bright tone over the entire picture.
LO Low key	Add a dark tone over the entire picture.
 Selective color	Create a black and white image in which only the specified color remains.

Special Effects Mode Settings

When **Movie options** () is set to **VGA120 HS 120 fps (640×480)**, **Soft** or **Nostalgic sepia** cannot be selected.

Special Effects Mode (Applying Effects When Shooting)

- When **Selective color** is set, select a color that you want to retain from the slider by pressing ▲ or ▼. To adjust the following settings, press the **OK** button to temporarily cancel color selection, and then adjust each setting.
 - Flash mode (📖60)
 - Self-timer (📖63)
 - Macro mode (📖64)
 - Exposure compensation (📖68)To return to the color selection screen, press the **OK** button again.

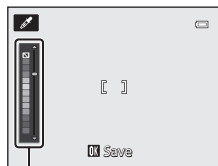

Slider

Changing Special Effects Mode Settings

- See “Features That Can Be Set Using the Multi Selector” (📖59) for more information on flash mode (📖60), self-timer (📖63), macro mode (📖64) and exposure compensation (📖68).
- Functions that can be set using the **MENU** button: the combination of image size and image quality (Image mode) (📖71)

Features That Can Be Set Using the Multi Selector

Press the multi selector **▲** (🔍), **◀** (🕒), **▼** (🌸), or **▶** (📷) while shooting to operate the following functions.

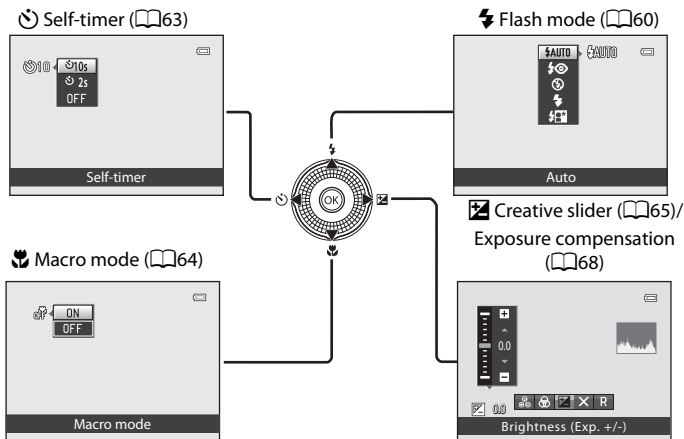

Available Functions

Available functions differ according to the shooting mode as follows.

- See “List of the Default Settings” (📖69) for more information on the default settings in each shooting mode.

Function	📷	SCENE, SCENE, 📷	😊	📄	EFFECTS
⚡ Flash mode (📖60)	✓	1	✓ ²	-	✓
🕒 Self-timer (📖63)	✓		✓ ²	-	✓
🌸 Macro mode (📖64)	✓		-	✓	✓
📷 Creative slider (📷) Brightness (Exposure compensation)/ Vividness / 🌈 Hue (📖65)	✓		-	✓	-
📷 Exposure compensation (📖68)	-		✓	-	✓

¹ The setting varies with scene mode. See “List of the Default Settings” (📖69) for more information.

² The setting varies with the smart portrait setting. See “List of the Default Settings” (📖69) for more information.

Using the Flash (Flash Modes)

You can set a flash mode that suits the shooting conditions.

- 1 Press ▲ (⚡ flash mode) on the multi selector.

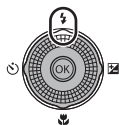

- 2 Use the multi selector to select the desired mode and press the OK button.

- See “Available Flash Modes” (📖61) for more information.
- If the OK button is not pressed within a few seconds, the selection will be canceled.
- When ⚡AUTO (auto) is applied, ⚡AUTO is only displayed for a few seconds, regardless of **Photo info** settings (📖100).

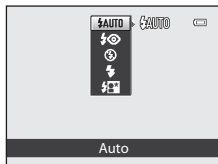

- 3 Frame the subject and take a picture.

- The flash lamp indicates the status of the flash when the shutter-release button is pressed halfway.
 - On: The flash will fire when you press the shutter-release button all the way.
 - Flashing: The flash is charging. The camera cannot take pictures.
 - Off: The flash will not fire when a picture is taken.
- If the battery is low, the monitor will be turned off while the flash is charging.

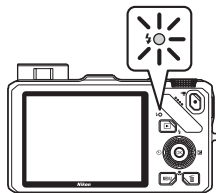

Effective Range of the Flash

The flash has a range of about 0.5 to 5.1 m (1 ft 8 in. to 16 ft) for wide-angle position, and about 1.5 to 3.0 m (5 ft to 9 ft 10 in.) for telephoto zoom position (when **ISO sensitivity** is set to **Auto**).

Raising the Flash

When you press the shutter-release button halfway, the flash will automatically pop up if the conditions required for flash photography are met.

- Auto flash (⚡AUTO auto, ⚡👁 auto with red-eye reduction, or ⚡📷 slow sync): If the lighting is dim, the flash automatically pops up when the shutter-release button is pressed halfway. The camera determines whether or not the flash pops up based on the brightness of the subject and the settings used during shooting.

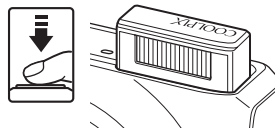

- 📷 off: The flash does not pop up, even when the shutter-release button is pressed halfway. The camera can shoot pictures with the flash lowered.
- ⚡ fill flash: The flash pops up when the shutter-release button is pressed halfway during shooting.

Lowering the Flash

When not using the flash, gently push to lower the flash until it clicks shut.

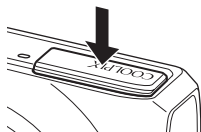

Available Flash Modes

⚡AUTO Auto

Flash fires automatically when lighting is dim.

⚡👁 Auto with red-eye reduction

Best choice for portraits. Reduces red-eye effect caused by flash in portraits (📖62).

📷 Off

Flash does not fire.

- Use of a tripod is recommended to avoid the effects of camera shake when shooting in a dark location.

⚡ Fill flash

The flash fires when a picture is taken, regardless of how bright the subject is. Use to “fill-in” (illuminate) shadows and backlit subjects.

⚡📷 Slow sync

Auto is combined with a slow shutter speed. Suitable for portraits of human subjects shot at night or under dim light. Flash illuminates main subject; slow shutter speeds are used to capture background.

Flash Mode Setting

- The setting varies with shooting mode. See “Available Functions” (📖59) and “List of the Default Settings” (📖69) for more information.
- This feature may not be used in combination with certain features. See “Features That Cannot Be Used Simultaneously” (📖73).
- For 📷 (auto) mode, the changed flash mode setting is saved in the camera’s memory even after the camera is turned off.

Auto with Red-eye Reduction

This camera uses advanced red-eye reduction (“In-Camera Red-Eye Fix”).

If the camera detects red eye when a picture is taken, the affected area is processed to reduce red-eye before the image is recorded.

Note the following when taking pictures:

- The time required to save the picture increases slightly.
- Advanced red-eye reduction may not produce the desired results in some situations.
- In extremely rare instances, areas not subject to red-eye may be affected by advanced red-eye reduction processing. In these cases, choose another mode and try again.

Using the Self-timer

The camera is equipped with a self-timer that releases the shutter ten or two seconds after you press the shutter-release button. The self-timer is useful when you want to be in the picture you are taking, and when you want to avoid the effects of camera shake that occur when you press the shutter-release button.

When using the self-timer, use of a tripod is recommended. Set **Vibration reduction** in the setup menu (📖100) to **Off** when using a tripod to stabilize the camera.

1 Press ◀ (🕒 self-timer) on the multi selector.

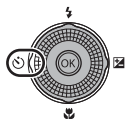

2 Use the multi selector to select 🕒10s or 🕒2s and press the OK button.

- 🕒10s (ten seconds): suitable for group pictures.
- 🕒2s (two seconds): suitable for preventing camera shake.
- When the shooting mode is set to **Pet portrait** in scene mode, 🐾 (Pet portrait auto release) is displayed (📖48). The self-timer 🕒10s and 🕒2s are not available.
- If the OK button is not pressed within a few seconds, the selection will be canceled.

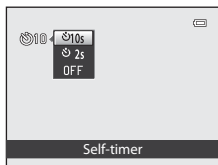

3 Frame the picture and press the shutter-release button halfway.

- Set the focus and exposure.

4 Press the shutter-release button all the way.

- The self-timer starts, and the number of seconds remaining before the shutter is released is displayed. The self-timer lamp flashes while the timer is counting down. About one second before the shutter is released, the lamp stops flashing and remains lit.
- When the shutter is released, the self-timer turns **OFF**.
- To stop the timer before a picture is taken, press the shutter-release button again.

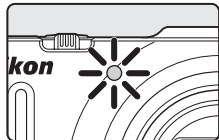

Using Macro Mode



When using macro mode, the camera can focus on objects as close as 4 cm (1.6 in.) from the front of the lens.

This feature is useful when taking close-up pictures of flowers and other small subjects.

- 1 Press  (macro mode) on the multi selector.



- 2 Press the multi selector to select **ON** and press the  button.

- The macro mode icon () is displayed.
- If a setting is not applied by pressing the  button within a few seconds, the selection will be canceled.

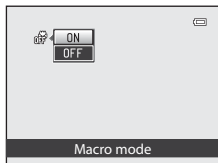

- 3 Rotate the zoom control to the zoom position at which  and the zoom indicator light in green.

- How close you can be to the subject when shooting depends on the zoom position.

When the zoom is set to a position where  and the zoom indicator light in green, the camera can focus on subjects as close as 10 cm (4 in.) from the lens.

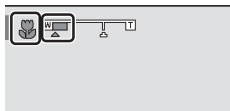

At the maximum wide-angle zoom position (the  zoom position), the camera can focus on subjects as close as 4 cm (1.6 in.) from the lens.



Notes On Using the Flash



The flash may be unable to light entire subject at distances of less than 50 cm (1 ft 8 in.) from the camera.

Autofocus

When using macro mode in  (auto) mode or continuous shooting mode, you can focus without pressing the shutter-release button halfway by setting **Autofocus mode** () in the shooting menu () to **Full-time AF**.

When using other shooting modes, **Full-time AF** is turned on automatically when macro mode is turned on (except when using ) (pet portrait)). You may hear the sound of the camera focusing.

The Macro Mode Setting

- Macro mode cannot be used when using certain shooting modes. See “List of the Default Settings” () for more information.
-  (auto) mode and continuous shooting mode share the same macro mode setting. When using  (auto) mode or continuous shooting mode, the macro mode setting is saved in the camera’s memory even if the camera is turned off.

Adjusting Brightness (Exposure Compensation), Vividness, and Hue (Creative Slider)

When the shooting mode (📖24) is set to 📷 (auto) mode (📖36) or continuous shooting mode (📖53), use the creative slider to adjust brightness (exposure compensation), vividness, and hue for taking pictures.

Operating the Creative Slider

- 1** Press the multi selector ▶ (🔍).

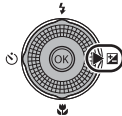

- 2** Press the multi selector ◀ or ▶ to select 🔍, 🌈, or 🎨.

- 🔍: Brightness (Exp. +/-) (exposure compensation)
- 🌈: Vividness (saturation adjustment)
- 🎨: Hue (white balance adjustment)

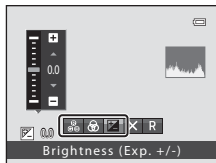





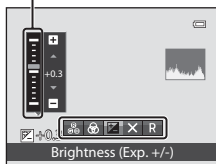

- 3** Adjust the brightness, vividness, or hue.

- Use the multi selector as explained below.
 - ▲▼: The slider moves. The effect can be adjusted while confirming the results on the monitor. The effect can also be adjusted by rotating the multi selector.
 - ◀▶: Switches between Brightness (Exp. +/-) (exposure compensation), vividness, and hue.
- For more information on each item, see the following:
 - 🔍: "Adjusting Brightness (Exposure Compensation)" (📖67)
 - 🌈: "Adjusting Vividness (Saturation Adjustment)" (📖67)
 - 🎨: "Adjusting Hue (White Balance Adjustment)" (📖67)
- To turn off the effects of the creative slider, press ◀ or ▶ to select **R**, and press the **OK** button.

Slider



4 When adjustment is complete, press ◀ or ▶ to select  and press the  button.

- If the  button (except when  is selected) or the shutter-release button is pressed in step 3, the selected amount of effect is applied. When the effect is applied, the camera returns to the shooting screen.
- If brightness is adjusted,  and the compensation value are displayed.
- If vividness is adjusted,  is displayed.
- If hue is adjusted,  is displayed.

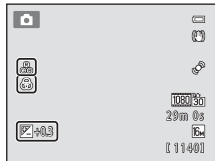
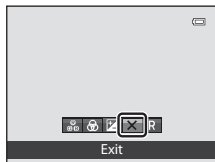

5 Press the shutter-release button to take a picture.

 **Creative Slider Settings**

- This feature may not be used in combination with certain features. See "Features That Cannot Be Used Simultaneously" (p. 73) for more information.
-  (auto) mode and continuous shooting mode share the same settings for Brightness (Exp. +/-) (exposure compensation), Vividness, and Hue; these settings are saved in the camera's memory even when the camera is turned off.

Adjusting Brightness (Exposure Compensation)

Adjust the overall brightness of the image.

- To make the image brighter, apply positive (+) exposure compensation.
- To make the image darker, apply negative (-) exposure compensation.

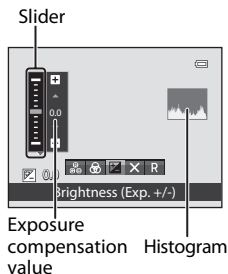

Using the Histogram

A histogram is a graph showing the distribution of tones in the image. Use as a guide when using exposure compensation and shooting without the flash.

- The horizontal axis corresponds to pixel brightness, with dark tones to the left and bright tones to the right. The vertical axis shows the number of pixels.
- Increasing exposure compensation shifts tone distribution to the right, and decreasing it shifts tone distribution to the left.

Adjusting Vividness (Saturation Adjustment)

Adjust the overall vividness of the image.

- The overall image vividness increases as the slider is moved up. The overall image vividness decreases as the slider is moved down.

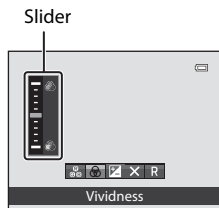

Adjusting Hue (White Balance Adjustment)

Adjust the overall hue of the image.

- The overall image becomes more reddish as the slider is moved up. The overall image becomes more bluish as the slider is moved down.

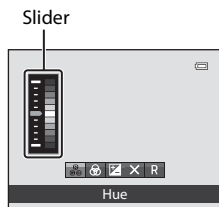

Notes On White Balance Adjustment

When hue is adjusted using the creative slider, **White balance** in the shooting menu (📖37) cannot be set. To set **White balance**, select **R** in the creative slider setting screen to reset the brightness, vividness, and hue.

Adjusting Brightness (Exposure Compensation)

When the shooting mode (📖24) is set to scene mode (📖38), smart portrait mode (📖50) or special effects mode (📖57), you can adjust the brightness (exposure compensation).

- 1 Press **▶** (🔍 exposure compensation) on the multi selector.

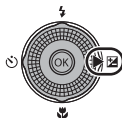

- 2 Press the multi selector to select a compensation value.

- To make the image brighter, apply positive (+) exposure compensation.
- To make the image darker, apply negative (-) exposure compensation.

Exposure compensation guide

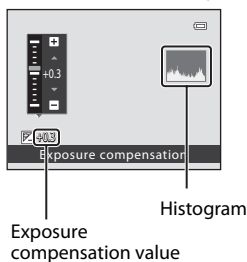

- 3 Press the **OK** button to apply the compensation value.

- If the **OK** button is not pressed within a few seconds, the selection is set and the setting menu disappears.
- When an exposure compensation value other than **0.0** is applied, the value is displayed with the 🔍 icon on the monitor.

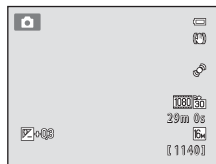

- 4 Press the shutter-release button to take a picture.

- To turn off exposure compensation, return to step 1, change the value to **0.0**.

Exposure Compensation Value

When the shooting mode is the **Fireworks show** scene mode (📖46), the exposure compensation cannot be used.







Histogram

See "Using the Histogram" (📖67) for more information.

List of the Default Settings

The default settings in each shooting mode are described below.

- Similar information about scene mode can be found on the next page.

Shooting mode	Flash mode (60)	Self-timer (63)	Macro mode (64)	Creative slider (65)	Exposure compensation (67 , 68)
 (auto) (36)	 AUTO	OFF	OFF	OFF	0.0
 (smart portrait) (50)	 AUTO ¹	OFF ²	OFF ³	-	0.0
 (continuous) (53)	 ³	OFF ³	OFF	OFF	0.0
EFFECTS (special effects) (57)	 ³	OFF	OFF	-	0.0

¹ Cannot be used when **Blink proof** is set to **On**.









































² Can be set when **Smile timer** is set to **Off**.



³ The setting cannot be changed.

- Settings applied in  (auto) mode and continuous shooting mode are saved in the camera's memory even after the camera is turned off (except for self-timer).



Features That Can Be Set Using the Multi Selector

The default settings in scene mode are described below.

	Flash mode (□□60)	Self-timer (□□63)	Macro mode (□□64)	Exposure compensation (□□68)
 (□□39)	 ¹	OFF	OFF ²	0.0
 (□□40)	 ²	OFF	OFF ²	0.0
 (□□41)	 ³	OFF	OFF ²	0.0
 (□□42)		OFF	OFF ²	0.0
 (□□42)	 ²	OFF	OFF ²	0.0
 (□□42)	 ²	OFF ²	OFF ²	0.0
 (□□43)	 ⁴	OFF	OFF ²	0.0
 (□□44)	 ⁵	OFF	OFF ²	0.0
 (□□44)	 AUTO	OFF	OFF ²	0.0
 (□□44)	 AUTO	OFF	OFF ²	0.0
 (□□44)	 ²	OFF	OFF ²	0.0
 (□□44)	 ²	OFF	OFF ²	0.0
 (□□45)	 ²	OFF	ON ²	0.0
 (□□45)	 ²	OFF	ON ²	0.0
 (□□46)	 ²	OFF	OFF	0.0
 (□□46)	 ²	OFF ²	OFF ²	0.0 ²
 (□□46)	 ²	OFF	OFF	0.0
 (□□47)	 ²	OFF ²	OFF ²	0.0
 (□□48)	 ²	 ⁶	OFF	0.0
 (□□49)	 ²	OFF ²	OFF	0.0

¹  **AUTO** (auto) or  (off) can be selected. When  **AUTO** (auto) is selected, the camera automatically selects the flash mode appropriate for the scene it has selected.

² The setting cannot be changed.

³ Flash is fixed at  (fill flash) when **HDR** is set to **Off**, and is fixed at  (off) when **HDR** is set to **On**.

⁴ The setting cannot be changed. Fill flash fires for red-eye reduction.

⁵ Slow sync with red-eye reduction can be used. Other settings can be selected.

⁶ The self-timer is not available. Pet portrait auto release ([□□48](#)) can be set to on or off.

Features That Cannot Be Used Simultaneously

This feature may not be used in combination with certain features ([□□73](#)).











Changing the Image Size (Image Mode)

Display the shooting screen → MENU button (📖11) → Image mode

You can select the combination of image size and compression ratio that is used when saving images.

Select the image mode best suited to the manner in which images will be used and the capacity of the internal memory or memory card. The higher the image mode setting, the larger the size at which it can be printed, but the number of images that can be saved is reduced.

Image Mode Settings (Image Size and Quality)

Option*	Description
 4608×3456★	Images will be higher quality than  . The compression ratio is approximately 1:4.
 4608×3456 (default setting)	Good balance between file size and image quality; suitable in most situations. The compression ratio is approximately 1:8.
 3264×2448	
 2272×1704	
 1600×1200	Smaller than  ,  and  ; for recording more pictures. The compression ratio is approximately 1:8.
 640×480	Suited to display on a TV with an aspect ratio of 4:3, or distribution by e-mail. The compression ratio is approximately 1:8.
 4608×2592	Images with an aspect ratio of 16:9 can be shot. The compression ratio is approximately 1:8.

* The total number of pixels captured, and the number of pixels captured horizontally and vertically.

Example:  **4608×3456** = approx. 16 megapixels, 4608 × 3456 pixels







The icon for the current setting is displayed on the monitor in shooting and playback modes (📖6, 8).

Notes On Image Mode

- The setting is also applied to other shooting modes.
- This function cannot be used in combination with certain features. See “Features That Cannot Be Used Simultaneously” (📖73) for more information.
- When the scene mode (📖38) is set to **Easy panorama** or **3D photography**, image mode is not available.

Number of Exposures Remaining

The following table lists the approximate number of pictures that can be stored in the internal memory and on a 4 GB memory card. Note that the number of exposures that can be stored differs depending on the composition of the image (due to JPEG compression). In addition, this number may differ depending on the make of memory card, even if the capacity of the memory card is the same.

Image mode	Internal memory		Memory card ¹ (4 GB)	Print size ² (cm/in.)
	COOLPIX S9300: 26 MB	COOLPIX S9200: 25 MB		
 4608×3456★	2	2	590	39 × 29/15 × 11.5
 4608×3456	4	4	1,140	39 × 29/15 × 11.5
 3264×2448	9	8	2,230	28 × 21/11 × 8
 2272×1704	20	18	4,560	19 × 14/7.5 × 5.6
 1600×1200	43	40	8,610	13 × 10/ 5.3 × 4
 640×480	140	132	24,100	5 × 4/2 × 1.5
 4608×2592	5	5	1,470	39 × 22/15 × 8.5

¹ If the number of exposures remaining is 10,000 or more, "9999" is displayed.

² The print size at an output resolution of 300 dpi. Print sizes are calculated by dividing the number of pixels by the printer resolution (dpi) and multiplying by 2.54 cm (1 in.). However, even with the same image size setting, images printed at higher resolutions print smaller than the size indicated, and those printed at lower resolutions print larger than the size indicated.

Features That Cannot Be Used Simultaneously

Some shooting settings cannot be used with other functions.

Restricted function	Setting	Description
Flash mode	Blink proof (📖51)	When Blink proof is set to On , the flash cannot be used.
Self-timer	AF area mode (📖37)	When set to Subject tracking , the self-timer is not available.
	Smile timer (📖50)	When shooting with Smile timer , the self-timer cannot be used.
Macro mode	AF area mode (📖37)	When set to Subject tracking , macro mode cannot be used.
Image mode	Continuous (📖53)	Image mode is fixed at the following depending on the continuous shooting settings. <ul style="list-style-type: none"> • Continuous H: 120 fps: 📷 (image size: 640 × 480 pixels). • Continuous H: 60 fps: 📷 (image size: 1280 × 960 pixels). • Multi-shot 16: 📷 (image size: 2560 × 1920 pixels).
ISO sensitivity	Continuous (📖53)	When shooting with Pre-shooting cache , Continuous H: 120 fps , Continuous H: 60 fps , or Multi-shot 16 , the ISO sensitivity is automatically set according to the lighting conditions.
White balance	Hue (using the creative slider) (📖67)	When hue is adjusted using the creative slider, White balance in the shooting menu cannot be set. To set White balance , select R in the creative slider setting screen to reset the brightness, vividness, and hue.
Print date	Continuous (📖53)	When shooting with Pre-shooting cache , Continuous H: 120 fps , or Continuous H: 60 fps , the shooting date is not imprinted.
Motion detection	AF area mode (📖37)	Motion detection is disabled when shooting with Subject tracking .
	ISO sensitivity (📖37)	Motion detection is disabled when ISO sensitivity is set to other than Auto .
	Continuous (📖53)	Motion detection is not activated when shooting with an option other than BSS .
Digital zoom	AF area mode (📖37)	The digital zoom cannot be used when AF area mode is set to Subject tracking .
	Continuous (📖53)	The digital zoom cannot be used when using Multi-shot 16 .

📌 Notes on Digital Zoom

- The digital zoom cannot be used with certain shooting modes.
- When the digital zoom is in effect, selectable options for AF area mode or metering mode are restricted (📖76).

Focusing on the Subject

The focus area or focus range for adjusting focus varies depending on the shooting mode.

- The subject is too close to the camera. Try shooting with Macro mode (📖64) or **Close-up** scene mode (📖45).
- When shooting in 📷 (auto) mode or continuous shooting mode, you can set the way the focus area is determined using the **AF area mode** (📖37).
- The camera may be unable to focus on the subjects for which autofocus does not perform as expected (📖29). If the camera does not focus, try pressing the shutter-release button halfway several times or try focus lock (📖76).

Using Face Detection

In the following shooting modes, the camera uses face detection to automatically focus on human faces. If the camera detects more than one face, a double border is displayed around the face that the camera will focus on, and single borders are displayed around the other faces.

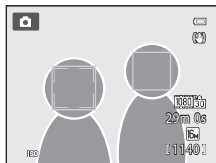

Shooting mode	Number of faces that can be detected	Focus area (double border)
Face priority is selected for AF area mode (📖37) in 📷 (auto) mode or continuous shooting mode	Up to 12	The face closest to the camera
🌅 (Scene auto selector), Portrait , Night portrait scene mode (📖38)		
📷 Smart portrait mode (📖50)	Up to 3	The face closest to the center of the frame

- When using **Face priority**, if you press the shutter-release button halfway while no faces are detected or while framing a shot with no faces in it, the camera automatically selects the focus areas (up to nine) that contain the subject closest to the camera.
- When 🌅 (Scene auto selector), is selected, the focus area changes depending on which scene the camera selects.
- If no faces are detected when the shutter-release button is pressed halfway in **Portrait** or **Night portrait** scene mode, or smart portrait mode, the camera will focus on the subject at the center of the frame.

✔ Notes on Face Detection

- The camera's ability to detect faces depends on a variety of factors, including whether or not the subject is facing the camera. Additionally, the camera may be unable to detect faces in the following situations:
 - When faces are partially hidden by sunglasses or otherwise obstructed
 - When faces take up too much or too little of the frame
- When the frame includes more than one face, the faces detected by the camera and the face on which the camera focuses depend upon a variety of factors, including the direction in which the subject is facing.
- In some rare cases, such as those described in "Autofocus" (📖29), the subject may not be in focus even though the double border turns green. If the camera does not focus, try "Focus Lock" (📖76).

📄 Viewing Pictures Taken Using Face Detection

- During playback, the camera automatically rotates images according to the orientation of the faces that were detected at the time of shooting (except for pictures taken using continuous shooting mode (📖53)).
- When zooming in on an image displayed in full-frame playback mode by rotating the zoom control toward **T** (📄), the image is enlarged at the center of the face that was detected during shooting (📖31) (except for pictures taken using continuous shooting mode (📖53)).

Focus Lock

Use focus lock to focus on off-center subjects when center is selected for AF area mode.

To focus on off-center subjects when **AF area mode** (📖37) is set to **Center** in 📷 (auto) mode or continuous shooting mode, use focus lock as described below.

- 1 Position the subject at the center of the frame.

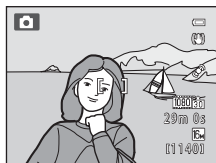

- 2 Press the shutter-release button halfway.

- Subject is in focus and the focus area lights in green.
- Exposure is also locked.

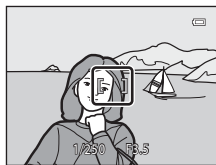

- 3 Continue holding down the shutter-release button halfway and recompose the picture.

- Be sure to maintain the same distance between the camera and the subject.

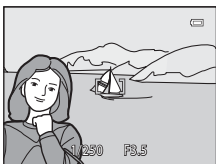

- 4 Press the shutter-release button all the way to take the picture.



Playback Features



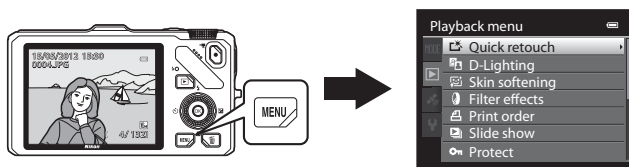







This chapter describes how to select certain types of images for playback as well as some of the features available when playing back images.



Selecting Certain Types of Images for Playback

Playback mode can be changed according to the type of images you want to view.

Available Playback Modes

	Play	 30
All images are played back without selecting types of images. When you switch from shooting mode to playback mode, this mode is selected.		
	Favorite pictures	 9
Play back only the images added to an album. Before switching to this mode, images must be added to the album ( 81,  9).		
	Auto sort	 13
The pictures taken are automatically sorted into categories such as portrait, landscape, and movies. Only images of the same category are played back.		
	List by date	 15
Only images captured on the same date are played back.		

Switching Between Playback Modes



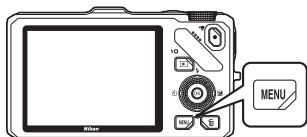

- 1 When viewing images, press the **MENU** button.



- 2 Press the multi selector .

- Tab selection is activated.



- 3 Press  or  to choose the **MODE** tab and then press the  button or .

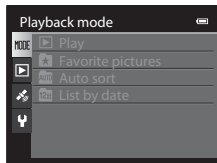

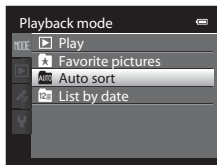

4 Press ▲ or ▼ to select a mode and then press the **OK** button.

- If you select **Play**, the playback screen is displayed.
- If you select other than **Play**, go to step 5.



5 Select an album, category, or shooting date and then press the **OK** button.

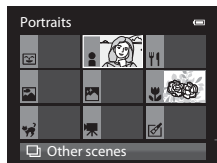

-  See "Favorite Pictures Mode" (9) for more information.
-  See "Auto Sort Mode" (13) for more information.
-  See "List by Date Mode" (15) for more information.
- To select the album, category, or shooting date again, repeat the operation from step 1.





Auto sort mode









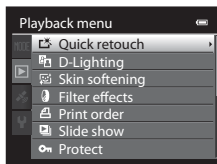









Features Available in Playback Mode (Playback Menu)















You can configure the following functions.

Press the  button (full-frame playback mode or thumbnail playback mode) → MENU button →  (playback menu) tab (📖11) *



* Select the  (Favorite pictures),  (Auto sort) or  (List by date) tab when switching to favorite pictures, auto sort or list by date playback mode.



Option	Description	
 Quick retouch ^{1,2}	Create retouched copies in which contrast and saturation have been enhanced.	 18
 D-Lighting ^{1,2}	Create copies with enhanced brightness and contrast, brightening dark portions of an image.	 18
 Skin softening ^{1,2}	When this feature is enabled, the camera detects faces in pictures taken and creates a copy with softer facial skin tones.	 19
 Filter effects ^{1,2}	Apply a variety of effects using digital filter. The available effects are Soft , Selective color , Cross screen , Fisheye , Miniature effect and Painting .	 20
 Print order ^{3,4}	When using a printer to print images saved on the memory card, the print order function can be used to select which images are printed, and how many copies of each image are printed.	 43
 Slide show	Images saved in the internal memory or on a memory card are played back in an automatic slide show.	 46
 Protect ³	Protect selected images or movies from accidental deletion.	 47
 Rotate image ^{2,4}	Specify the orientation in which saved images are displayed in playback mode.	 49
 Small picture ^{1,2}	Create a small copy of the picture taken. This feature is useful for creating copies for display on Web pages or e-mail attachments.	 21

Option	Description	
 Voice memo ²	Use the camera's microphone to record voice memos and attach them to the picture taken. Playback and deletion of voice memos can also be performed.	 50
 Copy ⁵	Copy images between the internal memory and a memory card. This function can also be used to copy movies.	 51
 Sequence display options	Display a sequence of images shot continuously as individual images, or display only the key picture of a sequence.	 52
 Choose key picture	Change the key picture for the series of pictures that were shot continuously (Pictures in a sequence,  7). <ul style="list-style-type: none"> • When changing this setting, select the desired sequence before displaying the menu. 	 52
 Favorite pictures	Select and add pictures to an album. <ul style="list-style-type: none"> • This option is not displayed in favorite pictures mode. 	 9
 Remove from favorites	Remove a picture from an album. <ul style="list-style-type: none"> • This option is displayed only in favorite pictures mode. 	 11

¹ This function is applied to edit the currently selected image and store the result as a separate file. Note, however, that the following pictures cannot be edited.

- Pictures taken using an aspect ratio of 16:9
 - Pictures taken using **Easy panorama** or **3D photography**
- Note also that there is a restriction on retouching edited images (16, 17).

² This function cannot be used for pictures in a sequence when only the key picture is displayed. To use this function, press the  button to display individual images before displaying the menu

³ When using list by date mode, press the **MENU** button on the list by date screen to apply the same setting to all images captured on the selected date.

⁴ The function cannot be applied to pictures taken in scene mode **3D photography**.

⁵ This function cannot be selected when using favorite pictures mode, auto sort mode, or list by date mode.

See “Editing Still Images” (16) and “The Playback Menu” (43) in the Reference Section for more information about each function.

Connecting the Camera to a TV, Computer, or Printer

You can enhance your enjoyment of images and movies by connecting the camera to a TV, computer, or printer.

- Before connecting the camera to an external device, make sure the remaining battery level is sufficient and turn the camera off. For information about the connection methods and subsequent operations, refer to the documentation included with the device in addition to this document.

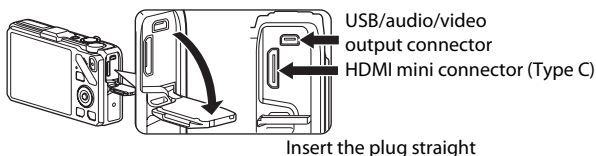

Viewing images on a TV

23

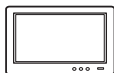

You can view the camera's images and movies on a TV.

Connection method: Connect the video and audio plugs of the included Audio Video Cable EG-CP16 to the TV's input jacks. Alternatively, connect a commercially available HDMI cable (Type C) to the TV's HDMI input jack.

Viewing and organizing images on a computer

83



If you transfer images to a computer, you can perform simple retouching and manage image data in addition to playing back images and movies.

Connection method: Connect the camera to the computer's USB input jack with the included USB Cable UC-E6.

- Before connecting to a computer, install ViewNX 2 on the computer using the included ViewNX 2 Installer CD. See 85 for more information about using the ViewNX 2 Installer CD and transferring images to a computer.
- If any USB devices that draw the power from the computer are connected, disconnect them from the computer before you connect the camera to it. Connecting the camera and other USB-powered devices to the same computer simultaneously may cause a camera malfunction or excessive power supply from the computer, which could damage the camera or memory card.

Printing images without using a computer

26



If you connect the camera to a PictBridge-compatible printer, you can print images without using a computer.

Connection method: Connect the camera directly to the printer's USB input jack with the included USB Cable UC-E6.

Using ViewNX 2

ViewNX 2 is an all-in-one software package which enables you to transfer, view, edit and share images.

Install ViewNX 2 using the ViewNX 2 Installer CD.



Installing ViewNX 2

- **An Internet connection is required.**

Compatible Operating Systems

Windows

- Windows 7 Home Basic/Home Premium/Professional/Enterprise/Ultimate (Service Pack 1)
- Windows Vista Home Basic/Home Premium/Business/Enterprise/Ultimate (Service Pack 2)
- Windows XP Home Edition/Professional (Service Pack 3)

Macintosh

- Mac OS X (version 10.5.8, 10.6.8, 10.7.2)

Refer to the Nikon website for the latest information on operating system compatibility.

-
- 1** Start the computer and insert the ViewNX 2 Installer CD into the CD-ROM drive.

- Mac OS: When the **ViewNX 2** window is displayed, double-click the **Welcome** icon.

2 Select a language in the language selection dialog to open the installation window.

- If the desired language is not available, click **Region Selection** to choose a different region and then choose the desired language (the **Region Selection** button is not available in the European release).
- Click **Next** to display the installation window.

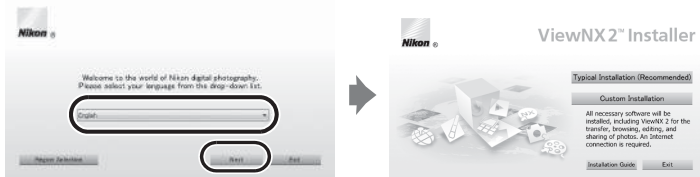

3 Start the installer.

- We recommend clicking **Installation Guide** in the installation window to check the installation help information and system requirements before installing ViewNX 2.
- Click **Typical Installation (Recommended)** in the installation window.

4 Download the software.

- When the **Software Download** screen is displayed, click **I agree. Begin download..**
- Follow the on-screen instructions to install the software.

5 Exit the installer when the installation completion screen is displayed.

- Windows: Click **Yes**.
- Mac OS: Click **OK**.

The following software is installed:

- ViewNX 2 (consisting of the three modules below)
 - Nikon Transfer 2: For transferring images to the computer
 - ViewNX 2: For viewing, editing, and printing transferred images
 - Nikon Movie Editor: For basic editing of transferred movies
- Panorama Maker 6 (for creating a single panorama photo using a series of images shot of a landscape, for example.)
- QuickTime (Windows only)

6 Remove the ViewNX 2 Installer CD from the CD-ROM drive.

Transferring Images to the Computer

1 Choose how images will be copied to the computer.

Choose one of the following methods:

- **Direct USB connection:** Turn the camera off and ensure that the memory card is inserted in the camera. Connect the camera to the computer using the included USB Cable UC-E6. The camera automatically turns on. To transfer images that are saved in the camera's internal memory, remove the memory card from the camera before connecting it to the computer.

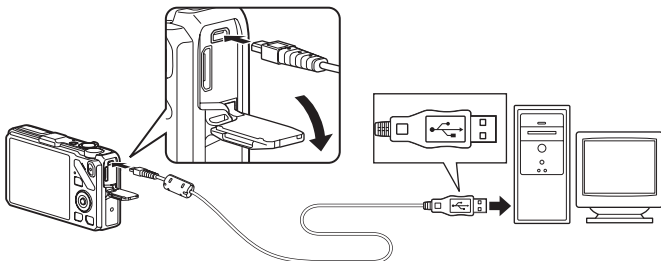

- **SD card slot:** If your computer is equipped with an SD card slot, the memory card can be inserted directly in the slot.
- **SD card reader:** Connect a card reader (available separately from third-party suppliers) to the computer and insert the memory card.

If a message is displayed prompting you to choose a program, select Nikon Transfer 2.

• When using Windows 7

If the dialog shown at right is displayed, follow the steps below to select Nikon Transfer 2.

- 1 Under **Import pictures and videos**, click **Change program**. A program selection dialog will be displayed; select **Import File using Nikon Transfer 2** and click **OK**.
- 2 Double-click **Import File**.



If the memory card contains a large number of images, it may take a while for Nikon Transfer 2 to start. Wait until Nikon Transfer 2 starts.

✓ Connecting the USB Cable

The connection may not be recognized if the camera is connected to the computer via a USB hub.

2 Transfer images to the computer.

- Confirm that the name of the connected camera or removable disk is displayed as the “Source” on the “Options” title bar of Nikon Transfer 2 (①).
- Click **Start Transfer** (②).

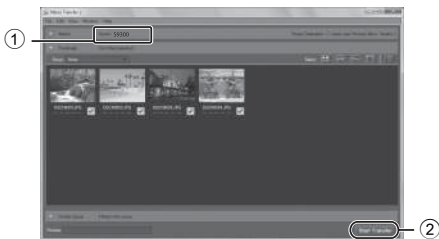

- At default settings, all the images on the memory card will be copied to the computer.

3 Terminate the connection.

- If the camera is connected to the computer, turn the camera off and then disconnect the USB cable.
- If you are using a card reader or card slot, choose the appropriate option in the computer operating system to eject the removable disk corresponding to the memory card and then remove the card from the card reader or card slot.

Viewing Images

Start ViewNX 2.

- Images are displayed in ViewNX 2 when transfer is complete.
- Consult online help for more information on using ViewNX 2.



Starting ViewNX 2 Manually

- **Windows:** Double-click the **ViewNX 2** shortcut on the desktop.
- **Mac OS:** Click the **ViewNX 2** icon in the Dock.

Recording and Playing Back Movies

You can record movies by simply pressing the **●** (🎥 movie-record) button.

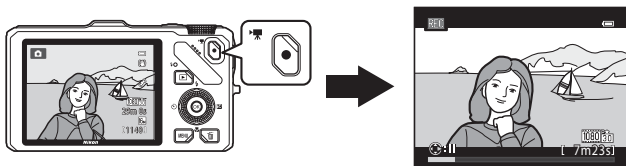

In playback mode, press the **OK** button to play a movie.

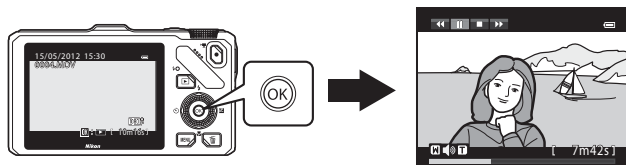

Recording Movies

You can record movies by simply pressing the **●** (📹 movie-record) button. Color tones, white balance, and other settings are the same as they are when taking still images.

1 Turn on the camera and display the shooting screen.

- The movie options icon indicates the type of movie recorded. The default setting is **1080p HD 1080p★ (1920×1080)** (📖90).
- When recording movies, the angle of view (i.e., the area visible in the frame) is narrower than that of still images. When **Photo info** in **Monitor settings** in the setup menu (📖100) is set to **Movie frame+auto info**, you can confirm the area visible in the frame before recording movies.

* The maximum movie length shown in the illustration differs from the actual value.

Movie option

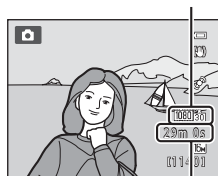

Maximum movie length*

2 Press the **●** (📹 movie-record) button to start movie recording.

- The camera focuses on the subject at the center of the frame. Focus areas are not displayed during recording.
- When recording with an aspect ratio setting of 16:9 in the movie options (e.g., **Movie options** is **1080p HD 1080p★ (1920×1080)**), monitor display changes to an aspect ratio of 16:9 (the movie is recorded in the range shown in the screen on the right).
- The approximate remaining movie length is displayed on the monitor. **11** is displayed while saving to the internal memory.
- When the multi selector **▶** is pressed during movie recording, recording is paused (except when using **iFrame** **iFrame 540 (960×540)** or HS movies). To resume recording, press **▶** again. If recording remains paused for more than five minutes or the **●** (📹 movie-record) button is pressed, recording ends.
- Recording stops automatically when the maximum movie length has been recorded.

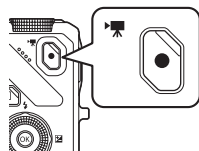

3 Press the **●** (📹 movie-record) button again to end recording.

✔ Note on Recording Images and Saving Movies

The indicator showing the number of exposures remaining or the indicator showing the maximum movie length flashes while images are being recorded or while a movie is being saved. **Do not open the battery-chamber/memory card slot cover or remove the battery or memory card while an indicator is flashing.** Doing this could result in loss of data, or in damage to the camera or the memory card.

✔ Notes on Movie Recording

- When saving a movie onto a memory card, a memory card with an SD speed class of Class 6 or higher is recommended (📖19). If the transfer speed of the card is slow, the movie recording may end unexpectedly.
- Using the digital zoom causes image quality to deteriorate. When recording ends, digital zoom turns off.
- The sound of using the zoom control or zoom, autofocus, vibration reduction or aperture control when the brightness changes may be recorded.
- The following phenomena may be seen on the monitor while recording movies. These phenomena are saved in the recorded movies.
 - Banding may occur in images under fluorescent, mercury-vapor, or sodium-vapor lighting
 - Subjects that move quickly from one side of the frame to the other, such as a moving train or car, may appear skewed
 - The entire movie image may be skewed when the camera is panned
 - Lighting or other bright areas may leave residual images when the camera is moved

✔ Notes on the Camera Temperature





- The camera may become warm when recording movies for an extended period of time or when the camera is used in a hot area.
- When the temperature inside the camera becomes extremely high while recording a movie, recording automatically stops after 30 seconds. The remaining amount of recording time (🕒30 s) is displayed on the monitor. The camera turns off in five seconds after movie recording automatically stops. Leave the camera off until the inside of the camera has cooled and then use it.



✔ Notes on Focusing for Movie Recording

- When **Autofocus mode** (📖91) in the movie menu is set to **AF-S Single AF** (default setting), the focus is locked when the **movie-record** button is pressed to start movie recording.
- Autofocus may not perform as expected (📖29). Should this occur, try the following:
 1. Before recording, set **Autofocus mode** in the movie menu to **AF-S Single AF** (default setting).
 2. Position a different subject at the same distance in the middle of the screen. Press the **movie-record** button to start the movie recording, and change the composition.



Maximum Movie Length

Movie options (📖91)	Internal memory		Memory card (4 GB)*
	COOLPIX S9300: 26 MB	COOLPIX S9200: 25 MB	
 HD 1080p★ (1920×1080)	12 s	11 s	35 min
 HD 1080p (1920×1080)	14 s	14 s	40 min
 HD 720p (1280×720)	27 s	25 s	50 min
 iFrame 540 (960×540)	7 s	7 s	25 min
 VGA (640×480)	59 s	56 s	2 h 30 min



All figures are approximate. The maximum movie length varies with the make of the memory card and the bitrate of the recorded movie.

* The maximum movie length for a single movie is 4 GB or 29 minutes, even when there is sufficient free space on the memory card. The maximum movie recording time for a single movie is displayed on the monitor during recording.

Functions Available in Movie Recording

- The creative slider, white balance (for  (auto mode) and continuous shooting mode) and the exposure compensation settings are also applied with movie recording. The hue settings for special effects mode (📖57) and scene mode (📖38) are also applied with movies. When macro mode is enabled, movies of subjects closer to the camera can be recorded. Confirm settings before starting movie recording.
- The self-timer (📖63) can be used. If the self-timer is set and the  (movie-record) button is pressed, the camera starts movie recording after ten or two seconds.
- The flash does not fire.
- Press the **MENU** button before starting to record the movie to display the  (movie) tab and select movie menu settings (📖91).

Recording HS (High Speed) Movies

When **Movie options** in movie menu is set to  **HS 120 fps (640×480)**,  **HS 60 fps (1280×720)**, or  **HS 15 fps (1920×1080)**, movies that can be played back in slow motion or fast motion can be recorded (📖55).

More Information

See “File and Folder Names” (📖89) for more information.

Changing Movie Recording Settings (Movie Menu)

The following option settings can be changed.

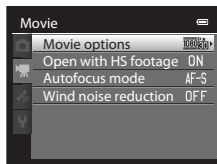

Display the shooting screen → MENU button → tab (11)

Option	Description	
Movie options	Select the type of movie recorded. The camera can record normal speed movies and HS (high speed) movies, which can be played back in slow motion or fast motion. The default setting is HD 1080p★ (1920 × 1080) .	53
Open with HS footage	When HS movie recording is selected in Movie options , select whether or not to record HS movies from the start of recording. The default setting is On . When Off is selected, normal speed movies are recorded from the start of recording. When the button is pressed during recording, recording switches to HS movie recording.	54
Autofocus mode	Select how the camera focuses when recording normal speed movies. Single AF (default setting) where the focus is locked when movie recording begins, or Full-time AF where the camera focuses continuously during movie recording can be selected. When Full-time AF is selected, the sound of the camera focusing may be heard in recorded movies. If you want to prevent the sound of the camera focusing from being recorded, select Single AF .	57
Wind noise reduction	Set whether or not to reduce wind noise during movie recording. During playback, not only wind noise, but other sounds may also become difficult to hear. The default setting is Off . <ul style="list-style-type: none"> When HS movie recording is selected in Movie options, wind noise reduction cannot be used. The setting is fixed at Off. 	57

Playing Back Movies

1 Press the  (playback) button to select playback mode.

- Press the multi selector to select a movie.
- Movies can be recognized by the movie options icon ()90).

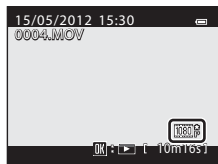



2 Press the  button to play back a movie.

Adjusting the volume









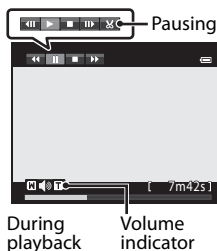



Press the zoom control **T/W** ()2) during playback.

Operations available during movie playback





Playback controls appear at the top of the monitor.

Press the multi selector  or  to select an icon of playback control, then press the  button to perform the following operations.



To	Use	Description
Rewind		Rewind the movie while the  button is pressed down.*
Advance		Advance the movie while the  button is pressed down.*
Pause		The following operations can be performed with the playback controls at the top of the monitor while playback is paused.
		 Rewind the movie by one frame. Hold down the  button to rewind continuously.*
		 Advance the movie by one frame. Hold down the  button to advance continuously.*
		 Extract and save only the required parts of the movie ( 31).
	 Resume playback.	
End		Return to full-frame playback mode.

* The movie can also be advanced or rewound by rotating the multi selector.

To delete a movie, use full-frame playback mode ()30) or thumbnail playback mode ()31) to select a movie and press the  button ()32).

Note on Movie Playback

Movies recorded with cameras other than COOLPIX S9300/S9200 cannot be played back on this camera.



Using GPS/Electronic Compass (COOLPIX S9300 only)

The Global Positioning System (GPS) is a satellite-based navigation system using the electro-magnetic waves of a network of GPS satellites placed into orbit. It allows users to determine their locations anywhere on Earth.

This chapter describes how to record the position information on the image using GPS.

Starting GPS Data Recording

The camera's internal GPS receives signals from the GPS satellites and calculates its current time and position.

Calculation of the position is known as positioning.

The position information (latitude and longitude) can be recorded on the pictures to be shot.

To start recording of the position information, set **GPS options** to **Record GPS data**.

Press the **MENU** button →  (GPS options) tab (📖11) → GPS options

Set the camera's **Time zone and date** (📖100) before using the GPS function.

- 1 Use the multi selector to select **Record GPS data** and press the **OK** button.

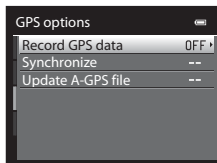

- 2 Select **On** and press the **OK** button.

- Signals are received from the GPS satellite and positioning starts.
- The default setting is **off**.

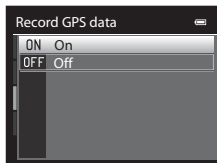





- 3 Press the **MENU** button.

- The camera returns to the shooting screen.
- Operate in an open-air area when starting to receive signals from GPS satellites.

Notes on GPS

- When positioning for the first time, when positioning was unable to be performed for about two hours, or after the battery was changed, it takes a few minutes to obtain the position information.
- If **Record GPS data** is set to **On** while a log is recorded using **Create log** (📄98), GPS functions even when the camera is turned off.
- Positions of the GPS satellites change constantly. You may not be able to determine the position or it may take some time depending on your location and the time. To use the GPS feature, use the camera in an open-air area with few obstacles in the sky. Signal receiving will be smoother if the GPS antenna (📄2) is facing the sky.
- If the camera needs to be turned off inside an airplane or hospital, set the **Record GPS data** to **Off**.
- The following locations which block or reflect signals may result in failed or inaccurate positioning.
 - Inside buildings or in the basement of buildings
 - Between high-rise buildings
 - Under overpasses
 - Inside tunnels
 - Near high-voltage electrical power lines
 - Between clusters of trees
 - Underwater
- Using a mobile phone of 1.5 GHz band near this camera may disrupt positioning.
- When carrying this camera around while positioning, do not place it in a metal bag. Positioning cannot be performed if the camera is covered with metal materials.
- When there is a significant difference in the signals from the GPS satellite, there could be a deviation of up to several hundred meters.
- Be aware of your surroundings when positioning.
- The date and time of the camera's internal clock at the time of shooting is recorded at the date and time of recording indicators displayed on the camera during playback. The time obtained by the position information and recorded on images will not be displayed on the camera.
- Position information will be recorded on the first frame of pictures shot using continuous shooting mode.
- The Geodetic system for this camera's GPS function uses the WGS 84 (World Geodetic System 1984).

GPS Reception Indicator and Point of Interest (POI) Information

- Operate in an open-air area when starting to receive signals from GPS satellites. GPS reception can be checked on the shooting screen.
 - : Signals are being received from four or more satellites and positioning is being performed. Position information is recorded on the image.
 - : Signals are being received from three satellites and positioning is being performed. Position information is recorded on the image.
 - : Signals are being received from the satellite, but positioning is not possible. The position information is not recorded on the image.
 - : Signals cannot be received from the satellite, and positioning is not possible. The position information is not recorded on the image.
- POI information is location name information for the nearest landmarks (facilities) and other details.
 - When **Display POI** in **Points of interest (POI)** of the **GPS options menu** (📖97) is set to **On**, the nearest location name information for the current location is displayed during shooting.
 - When **Embed POI** is set to **On**, location name information can be recorded on the image (the information cannot be recorded on movies).
 - When **Display POI** is set to **On**, location name information for images with recorded location name information is displayed during playback.
- “—” may be displayed for the location name information depending on the setting level in **Level of detail of Points of interest (POI)**. Also, certain landmark names may not be registered, or the landmark name may be different.

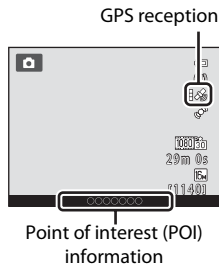

Pictures with Recorded Position Information

- The  icon is displayed during playback for images which have the position information recorded (📖8).
- Position information recorded on a picture can be checked on a map with ViewNX 2 after transferring the image to a computer (📖83).
- The actual place of shooting may differ from the GPS information recorded on the image files due to the accuracy of the position information obtained and a difference in the Geodetic system used.

Changing the GPS or Electronic Compass Settings (GPS Options Menu)



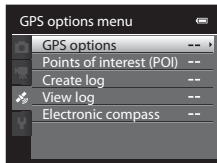



The following option settings can be changed in the GPS options menu.



MENU button → (GPS options) tab 11)

Option	Description	
GPS options	<p>Record GPS data: When set to On, signals are being received from the GPS satellite and positioning starts (94). The default setting is Off.</p> <p>Synchronize: Signals from the GPS satellite are used to set the date and time of the camera's internal clock (only when Record GPS data in GPS options of the GPS options menu is set to On).</p> <p>Update A-GPS file: A memory card is used to update the A-GPS (assist GPS) file. Using the latest A-GPS file can shorten the time needed for tracking the position information.</p>	58
Points of interest (POI)	<p>Make the settings for the POI (points of interest, location name information).</p> <p>Embed POI: When set to On, the location name information is recorded on the pictures to be shot (excluding movies). The default setting is Off.</p> <p>Display POI: When set to On, the location name information is displayed on the shooting screen or playback screen. If Embed POI is set to On and a picture is taken, the location name information for the picture is displayed on the playback screen. The default setting is Off.</p> <p>Level of detail: Set the display level of the location name information. A higher display level shows more detailed regional information, and a lower display level shows regional information for a wider area (such as country names).</p> <p>Edit POI: The level of the location name information recorded on the image can be changed, and the regional information can be deleted.</p>	60

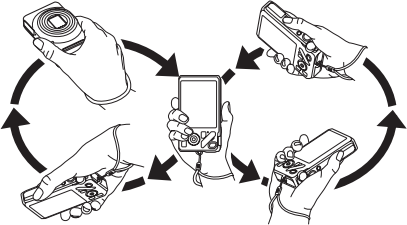
Changing the GPS or Electronic Compass Settings (GPS Options Menu)

Option	Description	
Create log	<ul style="list-style-type: none"> When Start log is selected, the measured tracking information for a certain duration is recorded until a preset time has elapsed (only when Record GPS data in GPS options of the GPS options menu is set to On). To display the log data, select End log and save the log to a memory card. 	 61
View log	<p>You can delete log data that was recorded to a memory card using End log in Create log.</p> <ul style="list-style-type: none"> To delete a log, select it and press . 	 63
Electronic compass	<p>Compass display: When set to On, the direction the camera is pointing is displayed on the shooting screen. When the monitor faces upward, the compass indicator switches to a circle compass with a red arrow that points north. The default setting is Off.</p> <p>Compass correction: Corrects the compass when the compass direction is not displayed correctly. Swing the camera to draw a figure eight in the air while turning your wrist to face the camera forward and backward, side to side, or up and down.</p> 	 64

General Camera Setup

This chapter describes the various settings that can be adjusted in the  setup menu.

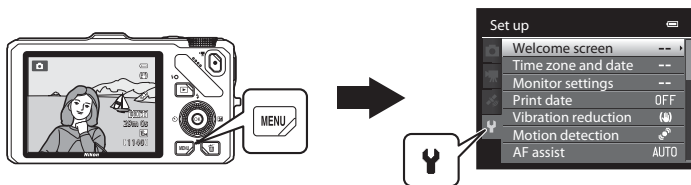

- See “Using Menus (the **MENU** Button)” (📖 11) for more information about using the camera’s menus.
- For further details about each setting, refer to “The Setup Menu” in the Reference Section (🔧 66).







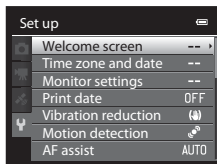





The Setup Menu

Press the **MENU** button → **Y** (setup) tab (📖11)











From the menu screen, select the **Y** tab to display the setup menu, and then you can change the following settings.



Option	Description	📖
Welcome screen	Select the image displayed as the welcome screen when the camera is turned on. Select COOLPIX to display the COOLPIX logo. Select Select an image to use a picture taken with the camera as the welcome screen. The default setting is None .	🔑66
Time zone and date	Set settings related to the camera's date and time. The Time zone setting allows you to specify the time zone where the camera is mainly used and whether or not daylight saving time is in effect. When the ✈️ travel destination is set, the camera automatically calculates the time difference between the travel destination and the 🏠 home time zone, and saves images using the date and time of the travel destination.	🔑67
Monitor settings	In Photo info , select the kind of information that is displayed on the monitor during shooting mode and playback mode. If you select Framing grid+auto info , a framing grid is displayed when shooting to help you frame the picture. Also set the image display after shooting, the screen brightness and whether or not to display histograms on the monitor.	🔑70
Print date	Imprint the shooting date and time on pictures at the time of shooting. The default setting is Off . <ul style="list-style-type: none"> Dates cannot be imprinted in the following situations. <ul style="list-style-type: none"> When the scene mode is set to Night landscape (with Hand-held selected), Night portrait (with Hand-held selected), Easy panorama or 3D photography When the Continuous option (📖55) in continuous shooting mode is set to Pre-shooting cache, Continuous H: 120 fps, or Continuous H: 60 fps During movie recording 	🔑72

Option	Description	
Vibration reduction	<p>Reduce blurring caused by camera shake when shooting. The default setting is On.</p> <ul style="list-style-type: none"> When using a tripod to stabilize the camera, set this feature to Off to prevent this feature from malfunctioning. 	 73
Motion detection	<p>When the camera detects camera shake or subject movement at the time of shooting, it automatically increases ISO sensitivity and shutter speed to reduce blurring. The default setting is Auto.</p> <p>The  indicator lights in green when the camera detects camera shake or subject movement and increases shutter speed.</p> <ul style="list-style-type: none"> When using certain shooting modes or settings, motion is not detected. In this case the  indicator is not displayed. 	 74
AF assist	<p>When set to Auto (default setting), the AF-assist illuminator (29) lights when shooting in dark surroundings to help the camera focus.</p> <ul style="list-style-type: none"> The illuminator has a range of about 3.0 m (9 ft 10 in.) at the maximum wide-angle position and about 2.0 m (6 ft 6 in.) at the maximum telephoto position. Even if Auto is selected, the AF-assist illuminator may not light depending on the position of the focus area or the scene mode that is selected. 	 75
Digital zoom	<p>When set to On (default setting), when the optical zoom is at the maximum telephoto zoom position, rotating the zoom control toward T () triggers the digital zoom (27).</p> <ul style="list-style-type: none"> The digital zoom cannot be used simultaneously in certain settings such as the shooting mode. 	 76
Sound settings	<p>Turn various camera sounds on and off. In the default setting, beep sounds are on.</p> <ul style="list-style-type: none"> The operation sound is disabled in certain settings such as shooting mode. 	 77
Auto off	<p>Set the amount of time that passes before the monitor is turned off to save power. The default setting is 1 min.</p>	 77
Format memory/ Format card	<p>Format the internal memory (only when a memory card is not inserted) or the memory card (when a memory card is inserted).</p> <ul style="list-style-type: none"> All data stored in the internal memory or on the memory card is deleted during formatting and cannot be restored. Be sure to transfer important images to a computer and save them before formatting. 	 78

The Setup Menu

Option	Description	
Language	Change the camera's display language.	 78
TV settings	Adjust settings for connection to television. <ul style="list-style-type: none"> When the camera is connected to a television using an audio/video cable but no picture is displayed on the television, set Video mode to NTSC or PAL according to the type of signal compatible with the television. HDMI settings can be set. 	 79
Charge by computer	When set to Auto (default setting), you can charge the camera's battery by connecting the camera to a computer (provided that the computer is able to supply power). <ul style="list-style-type: none"> When charging by computer, it may take more time to charge the battery than when using the Charging AC Adapter EH-69P. Additionally, when charging by computer and transferring images to the computer, it takes more time to charge the battery. 	 80
Blink warning	When the camera detects that a human subject may have closed their eyes immediately after taking a picture using face detection while shooting with modes other than the continuous shooting mode or smart portrait mode ( 75), the Did someone blink? screen is displayed on the monitor to check the picture taken. The default setting is Off .	 82
Eye-Fi upload	Set whether or not to enable the function for sending images to a computer using a commercially available Eye-Fi card. The default setting is Disable .	 83
Filmstrip	When On is selected, thumbnails of previous and subsequent images are displayed at the bottom of the monitor when you rotate the multi selector quickly while viewing an image in full-frame playback mode ( 30). The default setting is Off .	 84
Reset all	Reset the camera's settings to their default values. <ul style="list-style-type: none"> Some of the settings such as Time zone and date and Language are not reset. 	 84
Firmware version	Display the current camera firmware version.	 88



Reference Section

The Reference Section provides detailed information and hints for using the camera.

Shooting

Using Easy Panorama (Shooting and Playing Back)		2
Using 3D Photography		5

Playback

Playing and Deleting Images Captured Using		
Continuous Shooting Mode (Sequence)		7
Favorite Pictures Mode.....		9
Auto Sort Mode		13
List by Date Mode		15
Editing Still Images		16
Connecting the Camera to a TV (Viewing Images on a TV).....		23
Connecting the Camera to a Printer (Direct Print)		25
Editing Movies		31

Menu

The Shooting Menu		
(for (Auto) Mode, Continuous Shooting Mode).....		33
The Smart Portrait Menu.....		41
The Playback Menu.....		43
The Movie Menu		53
GPS Options (COOLPIX S9300 only)		58
The Setup Menu.....		66

Additional Information

File and Folder Names		89
Optional Accessories		91
Error Messages		92

Using Easy Panorama (Shooting and Playing Back)

Taking Pictures with Easy Panorama

Rotate the mode dial to SCENE → MENU button → Easy panorama

- 1** Select the shooting range from **STD Normal (180°)** or **WIDE Wide (360°)**, and press the **OK** button.

- The image sizes (W × H) when the camera is held in landscape orientation are as follows.
 - STD Normal (180°):**
3200 × 560 when the camera is moved horizontally,
1024 × 3200 when the camera is moved vertically
 - WIDE Wide (360°):**
6400 × 560 when the camera is moved horizontally,
1024 × 6400 when the camera is moved vertically
- For the image sizes when the camera is held in "tall" orientation, the combinations of the moving direction and W × H are the opposites of the above.

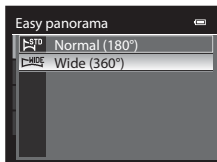

- 2** Frame the first portion of the panorama scene, and press the shutter-release button halfway to adjust the focus.

- The zoom is fixed at the wide-angle position.
- The framing guide is displayed on the monitor.
- The camera focuses on the subject at the center of the frame.
- Exposure compensation (67) can be adjusted.
- If the focus or exposure cannot be set for the main subject, try the focus lock (76).



- 3** Press the shutter-release button all the way, and release it.

- The icons showing the panorama direction are displayed.



4 Move the camera straight and slowly in one of the four directions to start shooting.

- When the camera detects the panorama direction, the shooting starts.
- The guide showing the current shooting point is displayed.
- When the guide showing the shooting point reaches the end, the shooting ends.



Guide

Example of moving the camera

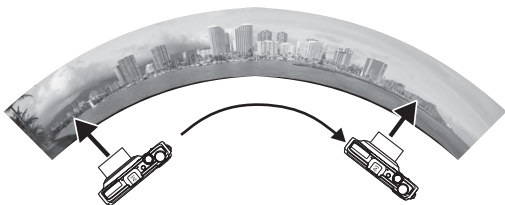



- The user, without shifting position, moves the camera, from end to end of the guide, horizontally or vertically in an arc.
- If about 15 seconds (in **STD Normal (180°)**) or 30 seconds (in **WIDE Wide (360°)**) pass from the start of the shooting, and before the guide showing the shooting point reaches the end, the shooting ends.



✓ Notes on Easy Panorama Shooting

- The image area seen in the saved image will be narrower than that seen on the monitor at the time of shooting.
- When the camera movement speed is too fast, there is a large amount of camera shake or there is little change in subject such as wall or in the dark, the shooting ends in an error.
- Panorama pictures are not saved when the shooting stops before reaching half of the panorama range.
- When the shooting reaches more than half of the panorama range but finishes before the end point, the range that is not shot will be recorded as a gray area.













Viewing Easy Panorama (Scroll)

Switch to playback mode (📖30), display the picture recorded with easy panorama in full-frame playback mode and press the **OK** button. The camera displays the short side of the picture filling the entire screen and scrolls the displayed area automatically.

- Easy panorama images can be recognized by the  or  icon displayed in playback mode.
- The picture is scrolled in the direction of the panorama shooting.
- Rotate the multi selector to advance or rewind.

Playback controls are displayed at the top of the monitor during playback. When you choose a playback control with the multi selector  or  and press the **OK** button, the following operations can be performed.



To	Use	Description	
Rewind		Scroll quickly back while the OK button is pressed.	
Advance		Scroll quickly forward while the OK button is pressed.	
Pause		The following operations can be performed with the playback controls at the top of the monitor while playback is paused.	
		   	Rewind while the OK button is pressed.*
		   	Scroll while the OK button is pressed.*
		Restart the automatic scroll.	
End		Return to full-frame playback mode.	

* Scrolling can also be performed by rotating the multi selector.

Note on Viewing Pictures Recorded with Easy Panorama

Panorama pictures recorded with functions other than easy panorama of the COOLPIX S9300/S9200 may not be scrolled or zoomed on this camera.

Using 3D Photography

The camera takes one picture for each eye to simulate a three-dimensional image on a 3D-compatible TV or monitor.

Rotate the mode dial to **SCENE** → **MENU** button → **3D** 3D photography

1 Frame the subject.

- The focus area that the camera focuses on can be moved to areas other than the center of the frame. To move the focus area, press the **OK** button before taking the first picture, and then rotate the multi selector or press **▲**, **▼**, **◀**, or **▶**. To adjust the following settings, press the **OK** button to temporarily cancel focus area selection, and then adjust each setting.
 - Macro mode
 - Exposure compensation

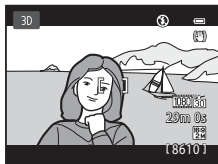

2 Press the shutter-release button to take the first picture.

- The focus, exposure and white balance are locked after the first shot, and **AE/AF-L** is displayed on the monitor.



3 Move the camera horizontally to the right until the translucent guide is aligned with the subject.

- To cancel shooting, press the **OK** button.

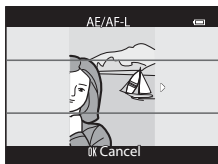

4 Wait for the camera to automatically release the shutter.

- The camera automatically takes the second picture when it detects that the subject is aligned with the guide.
- Shooting is canceled if the subject is not aligned with the guide within 10 seconds.

Taking 3D Pictures

- Moving subjects are not suited to 3D photography. We recommend shooting still subjects.
- Pictures have a less pronounced 3D feel as the distance between the camera and background is increased.
- Pictures may have a less pronounced 3D feel when the subject is dark or when the second picture is not aligned precisely.
- Be careful of camera shake when shooting at the telephoto zoom position.
- You cannot set the telephoto zoom position beyond 124 mm (angle of view equivalent to 35mm [135] format).
- The angle of view (i.e., the area visible in the frame) seen in the saved picture will be narrower than that seen on the monitor at the time of shooting.
- Pictures taken under dim lighting may appear grainy with noise.
- If the camera does not take the second picture and cancels the shooting even when you align the guide with the subject, try shooting with the shutter-release button.

Notes on Viewing 3D Pictures

- 3D pictures cannot be played back in 3D on the camera monitor.
See "Viewing 3D Photography" (📖49) for more information.
- When viewing 3D pictures on a 3D-compatible TV or monitor for an extended period of time, you may experience discomfort such as eye strain or nausea. Carefully read the documentation included with your TV or monitor to ensure proper use.

Playing and Deleting Images Captured Using Continuous Shooting Mode (Sequence)

The images shot in the following continuous shooting mode are saved as a group (called a “sequence”) each time you shoot.

- **Continuous H, Continuous L, Pre-shooting cache, Continuous H: 120 fps** or **Continuous H: 60 fps** in the continuous shooting menu (📖55)
- **Sports** (📖42) or **Continuous** in the **Pet portrait** (📖48) scene mode

Playing Images in a Sequence

In full-frame playback mode or thumbnail playback mode (📖31), the first image of a sequence is used as the “key picture”, i.e., it is displayed to represent the images in the sequence.

Sequence display



While the key picture of a sequence is displayed in full-frame playback mode, press the **OK** button to display each image in the sequence individually. To return to key picture only display, press the multi selector **▲**.



The following operations can be performed when each image in a sequence is displayed individually.

- Select an image: Rotate the multi selector or press **◀** or **▶**.
- Zoom in: Rotate the zoom control toward **T** (📖31).

✔ Sequence Display Options

- Select **Sequence display options** (🔧52) in the playback menu to set all sequences to be displayed using their key pictures or to display them as individual images.
- If an image in the sequence is selected when **Sequence display options** is set to **Individual pictures**, the **📖** icon is displayed on the monitor.
- Pictures captured continuously with cameras other than COOLPIX S9300/S9200 cannot be displayed as a sequence.

✎ Changing Key Picture in Sequence

A sequence's key picture can be changed using **Choose key picture** (🔧52) in the playback menu.

Playback Menu Options Available When Using Sequence



When the **MENU** button is pressed during an image sequence playback, the following menu operations are available.



- | | | | |
|-------------------------------|--|----------------------------------|--|
| • Quick retouch ¹ | →  18 | • D-Lighting ¹ | →  18 |
| • Skin softening ¹ | →  19 | • Filter effects ¹ | →  20 |
| • Print order ² | →  43 | • Slide show | →  46 |
| • Protect ² | →  47 | • Rotate image ¹ | →  49 |
| • Small picture ¹ | →  21 | • Voice memo ¹ | →  50 |
| • Copy ² | →  51 | • Sequence display options | →  52 |
| • Choose key picture | →  52 | • Favorite pictures ² | →  9 |

¹ Press the **MENU** button after displaying individual images. Settings can be applied to individual images.

² When the **MENU** button is pressed during displaying only the key picture, the same settings can be applied to all images in that sequence. Press the **MENU** button after displaying individual images to apply settings to individual images.

Deleting Images in a Sequence

When **Sequence display options** ( 52) is set to **Key picture only** in the playback menu, if the  button is pressed and the deletion method is selected, the following images are deleted.

- When a sequence is displayed by its key picture only:
 - **Current image:** When the sequence is selected, all images in the sequence are deleted.
 - **Erase selected images:** When the key picture is selected in the erase selected images screen ( 33), all images in the sequence are deleted.
 - **All images:** All images including the sequence that is displayed are deleted.
- If the key picture is selected and the  button is pressed to display individual images in the sequence before pressing the  button:

The deletion methods change to the followings.

 - **Erase current picture:** Delete the image that is displayed.
 - **Erase selected images:** Select multiple images in the sequence to delete in the erase selected images screen ( 33).
 - **Erase entire sequence:** All images in the sequence, including the image that is displayed, are deleted.

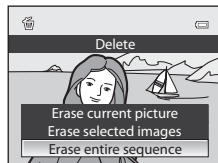

Favorite Pictures Mode

You can add favorite pictures to one of nine albums after shooting in accordance with the category (excluding movies). After images are added, they can be easily played back using favorite pictures mode.





- It is easier to find the images when they are added to separate albums in accordance with events or type of subjects.
- The same image can be added to multiple albums.
- The maximum number of images that can be added to an album is 200.

Adding Images to Albums

Press the  button (Playback mode*) → MENU button →  or  or  tab (80) → 
Favorite pictures

* Images can be added to an album when in the normal playback mode, auto sort mode or list by date mode. Images cannot be added in favorite pictures playback mode.

1 Press the multi selector or , and then choose an image and press to display .

- To add more images to the same album, repeat this step as necessary.
- To cancel the selection, press  to remove .
- Rotate the zoom control (27) toward **T** () to switch to full-frame playback mode, or toward **W** () to display thumbnails.



2 Display for all images to be added to an album and press the button to set the chosen images.

3 Use the multi selector to choose the album to which the images will be added and press the button.



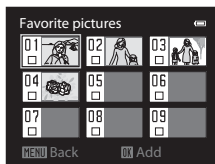

- The selected images are added and the camera switches to the playback menu.
- To add the same image to multiple albums, select 
Favorite pictures and repeat from step 1.



Playing Back Images in Albums

Press the  button (Playback mode) → **MENU** button → **MODE** tab (78) →  Favorite pictures

Use the multi selector to select an album and press the  button to play back only images added to the same album.

- The following operations can be performed on the album list screen.
 -  (delete) button: Delete all images in the currently selected album.
 - **MENU** button: Change album icon (color and design) (12).
- When viewing images in full-frame playback mode or thumbnail playback mode, if you press the **MENU** button to display the menu and then select the  tab (favorite pictures menu), you can then select a feature from the playback menu (80).

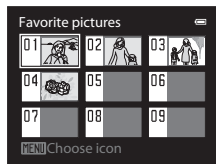

Note on Deletion

When images are added to an album, they are not moved or copied to the album. Only the file names of the images are added to the album. When using favorite pictures mode, images are played back by retrieving the images that correspond to the file names added to the albums.

If an image is deleted while using favorite pictures mode, the image will be removed from the album and it will be permanently deleted from the internal memory or the memory card.

Removing Images From Albums

Select favorite pictures mode → Select an album from which images are removed (👁️10) → **OK** button → **MENU** button → **✖** Remove from favorites

1 Press the multi selector ◀ or ▶, and then choose an image and press ▲ to display ✓.

- To remove more images from the same album, repeat this step as necessary.
- To cancel the selection, press ▼ to remove ✓.
- Rotate the zoom control (📖27) toward **T** (🔍) to switch back to full-frame playback mode, or toward **W** (🖼️) to display thumbnails.





2 Display ✓ for all images to be removed and press the **OK** button to set the chosen images.

3 Choose **Yes** and press the **OK** button.





- To cancel removal, select **No**.

Changing the Favorites Album Icon

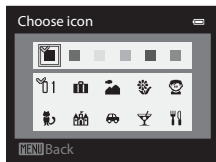
Press the  button (Playback mode) → MENU button → MODE tab (📖78) →  Favorite pictures → Choose the desired album → MENU button

- 1 Press the multi selector  or  to choose an icon color and press the  button.



- 2 Press , ,  or  to choose an icon and press the  button.
 - The icon changes and the monitor display returns to the list of albums screen.

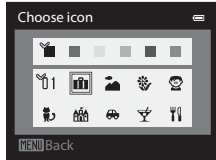

Notes on Album Icons

Set the album icons separately for the internal memory and for the memory card.



- To change the album icons for the internal memory, first remove the memory card from the camera.
- The default setting for the icon is the number icon (black).

Auto Sort Mode

Captured images are automatically sorted into categories, such as portraits, landscape, and movie.







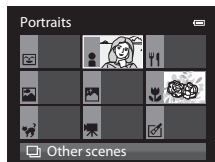









Press the  button (Playback mode) → **MENU** button → **MODE** tab (78) →  Auto sort

Use the multi selector to select a category and then press the  button to play back images in the selected category.

- The following operation can be performed while the category selection screen is displayed.
 -  (delete) button: Delete all images in the selected category.
- When viewing images in full-frame playback mode or thumbnail playback mode, if you press the **MENU** button to display the menu and then select the  tab (auto sort mode menu), you can then select a feature from the playback menu (80).



Auto Sort Mode Categories

Option	Description
 Smile	Images captured in  Smart portrait mode (📖50) with the smile timer setting set to On
 Portraits	Images captured in  (auto) mode (📖36) with the face detection (📖75) Images captured in the following scene modes (📖38): <ul style="list-style-type: none"> •  (Backlighting)* • Portrait*, Night portrait*, or Party/indoor Images captured in  Smart portrait mode (📖50) with the smile timer setting set to Off
 Food	Images captured in Food scene mode (📖38)
 Landscape	Images captured in Landscape* scene mode (📖38)
 Dusk to dawn	Images captured in the following scene modes (📖38): <ul style="list-style-type: none"> •  (Night landscape) * • Sunset, Dusk/dawn, or Fireworks show
 Close-ups	Images captured in  (auto) mode with macro mode (📖64) Images captured in Close-up* scene mode (📖38)
 Pet portrait	Images captured in Pet portrait scene mode (📖38)
 Movie	Movies (📖53)
 Retouched copies	Copies created using the editing function (📖16)
 Other scenes	All other images that cannot be defined by the categories described above

* Images captured in  scene auto selector mode (📖38) are also sorted to the appropriate categories.







Notes on Auto Sort Mode

- Up to 999 images and movie files can be sorted to each category in auto sort mode. If 999 images or movies have already been sorted to a specific category, new images and movies cannot be sorted to that category nor can they be displayed in auto sort mode. You can play back images and movies that could not be sorted to a category by using normal playback mode (📖30) or list by date mode (📖15).
- Images or movies copied from the internal memory or a memory card cannot be displayed in auto sort mode.
- Images or movies saved by a camera other than COOLPIX S9300/S9200 cannot be played back in auto sort mode.

List by Date Mode

Press the  button (Playback mode) → MENU button → MODE tab () →  List by date

Use the multi selector to select a date and then press the  button to play back images captured on the selected date.

- The first picture taken on the selected date is displayed.
- The following operations can be performed while the shooting date list screen is displayed.
 - **MENU** button: If you select the  tab (list by date menu) from the menu screen to display the playback menu ()80), you can select one of the following features and apply that feature to images captured on the selected date.
 - Print order, Slide show, or Protect
 -  (delete) button: Delete all images captured on the selected date.
- When viewing images in full-frame playback mode or thumbnail playback mode, if you press the **MENU** button to display the menu and then select the  tab (list by date menu), you can then select a feature from the playback menu ()80).
- Calendar display mode ()31) cannot be used in list by date mode.



Notes on List by Date Mode

- Up to 29 dates can be selected. If images exist for more than 29 dates, all images saved earlier than most recent 29 dates will be combined under **Others**.
- The 9,000 most recent images can be displayed in list by date mode.
- Pictures taken when the camera's date is not set are treated as images captured on January 1, 2012.

Editing Still Images

Editing Features

Images can be easily edited with this camera using the functions below. Edited images are stored as separate files (📷89).

Editing function	Application
Quick retouch (📷18)	Easily create a copy with enhanced contrast and richer colors.
D-Lighting (📷18)	Create a copy of the current picture with enhanced brightness and contrast, brightening dark portions of the picture.
Skin softening (📷19)	Make the facial skin tones softer.
Filter effects (📷20)	Apply a variety of effects using digital filter effects. The available effects are Soft , Selective color , Cross screen , Fisheye , Miniature effect and Painting .
Small picture (📷21)	Create a small copy of pictures suitable for uses such as e-mail attachments.
Crop (📷22)	Crop a portion of the picture. Use to zoom in on a subject or arrange a composition.

✔ Notes on Image Editing

- The following pictures cannot be edited.
 - Pictures taken using an aspect ratio of 16:9
 - Pictures recorded using **Easy panorama** or **3D photography**
 - Pictures taken with cameras other than the COOLPIX S9300/S9200
- When no faces are detected in the picture, skin softening cannot be applied (📷19).
- If a copy created using the COOLPIX S9300/S9200 is viewed on a different digital camera, it may not be possible to display the picture properly or transfer it to a computer.
- Editing functions are not available when there is not enough free space in the internal memory or on the memory card.
- For a sequence displayed using the key picture only setting (📷7), perform one of the following operations before editing.
 - Press the **OK** button to display individual images, and then select an image in the sequence
 - Set **Sequence display options** (📷52) to **Individual pictures** so that each image is displayed individually, and then select an image

Restrictions on Image Editing

The following restrictions apply when editing pictures that were created by editing.

Editing functions used	Editing functions to add
Quick retouch D-Lighting Filter effects	Skin softening, Small picture or Crop can be used. Quick retouch, D-Lighting and Filter effects cannot be used in combination with each other.
Skin softening	Quick retouch, D-Lighting, Filter effects, Small picture or Crop can be used.
Small picture Crop	No additional editing functions can be used.

- Copies created by editing cannot be edited again using the same editing function.
- To use an editing function together with small picture or crop, use the other editing function first, and use small picture or crop as the last editing function performed on that picture.
- Pictures that were taken using skin softening can be edited using skin softening.

Original Pictures and Edited Copies

- Copies created with editing functions are not deleted if the original pictures are deleted. The original pictures are not deleted if copies created with editing functions are deleted.
- Edited copies are stored with the same shooting date and time as the original.
- Even if the pictures that are marked for **Print order** (🔒43) or **Protect** (🔒47) are used for editing, these settings are not reflected on the edited copies.

Quick Retouch: Enhancing Contrast and Saturation

Select a picture (📖30) → MENU button →  Quick retouch

Press the multi selector ▲ or ▼ to choose the setting level, and press the **OK** button.

- The original version is displayed on the left and the edited version is displayed on the right.
- To cancel, press ◀.
- Quick retouched copies can be recognized by the  icon displayed in playback mode.

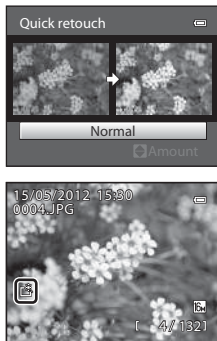

D-Lighting: Enhancing Brightness and Contrast

Select a picture (📖30) → MENU button →  D-Lighting

Press the multi selector ▲ or ▼ to choose **OK**, and press the **OK** button.

- The original version is displayed on the left and the edited version is displayed on the right.
- To cancel, choose **Cancel**, and press the **OK** button.
- D-Lighting copies can be recognized by the  icon displayed in playback mode.



More Information

See "File and Folder Names" (📖89) for more information.

Skin Softening: Softening Skin Tones



Select a picture (📖30) → MENU button →  Skin softening

1 Press the multi selector ▲ or ▼ to choose the setting level, and press the button.

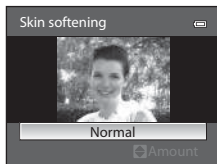
- A confirmation screen is displayed, and the image is displayed zoomed in on the face edited by skin softening.
- To cancel, press ◀.



2 Confirm the results.

- Up to 12 faces, in order of proximity to the center of the frame, can be enhanced.
- When multiple faces are edited using skin softening, use the multi selector ◀ or ▶ to switch the face that is displayed.
- To adjust the extent of skin softening, press the MENU button and return to step 1.
- To create a copy edited with skin softening, press the  button.
- Copies created by editing with skin softening can be recognized by the  icon displayed in playback mode.

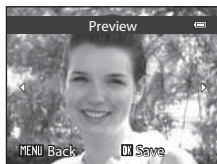

Notes on Skin Softening

- Depending on conditions such as the direction the subject is facing or the brightness of the face, the face may not be detected properly, or the desired effect may not be achieved.
- If no faces are detected in the image, a warning is displayed and the screen returns to the playback menu.

More Information

See "File and Folder Names" (📖89) for more information.

Filter Effects: Applying Digital Filter Effects

Select a picture (📖30) → MENU button → 🎛️ Filter effects

Option	Description
Soft	Gently soften the focus of the image from the center to the edge. In pictures taken with face detection (📖75) or pet detection (📖48) selected, areas around faces will be blurred.
Selective color	Keep only the selected image color and make other colors black-and-white.
Cross screen	Produce star-like rays of light that radiate outward from bright objects such as sunlight reflections and city lights. Suitable for night scenes.
Fisheye	Create images that look like they were shot with a fisheye lens. Suitable for pictures shot in macro mode.
Miniature effect	Create images that look like close-up photos of a diorama. Suitable for pictures shot while looking down from a high location, with the main subject near the center of the frame.
Painting	Create images with the ambience of paintings.

1 Press the multi selector ▲ or ▼ to choose the filter effect type, and press the Ⓞ button.

- When **Cross screen**, **Fisheye**, **Miniature effect** or **Painting** is selected, proceed to step 3.

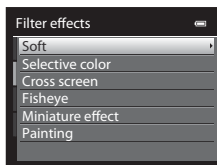

2 Adjust the effect and press the Ⓞ button.

- **Soft:** Press ▲ or ▼ to select the extent of the effect.
- **Selective color:** Press ▲ or ▼ to select the color to keep.

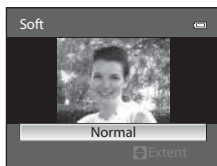

Soft

3 Confirm the result and press the **OK** button.

- A new, edited copy is created.
 - To cancel, press **◀**.
-
- Copies created by editing with filter effects can be recognized by the  icon displayed in playback mode.

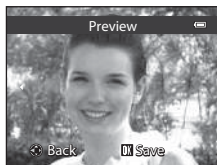

Small Picture: Reducing the Size of an Image

Select a picture (30) → **MENU** button →  Small picture

1 Press the multi selector **▲** or **▼** to choose the desired copy size, and press the **OK** button.

- The available sizes are **640×480**, **320×240** and **160×120**.

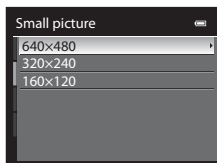

2 Choose **Yes** and press the **OK** button.

- A new, smaller copy is created.
- The compression ratio of the created image is 1:16.
- Copies created by editing with small picture editing function are displayed with a black frame.

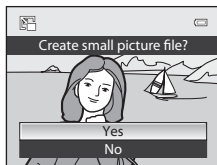

More Information

See "File and Folder Names" (89) for more information.

✂ **Crop: Creating a Cropped Copy**

Create a copy containing only the portion visible on the monitor when **MENU**:✂ is displayed with playback zoom (📖31) enabled. Cropped copies are stored as separate files.

1 Enlarge the picture for cropping (📖31).

2 Refine copy composition.

- Rotate the zoom control toward **T** (📐) or **W** (📐) to adjust the zoom ratio.
- Press the multi selector ▲, ▼, ◀ or ▶ to scroll the picture until only the portion you want to copy is visible on the monitor.



3 Press the **MENU** button.

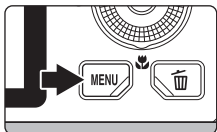

4 Use the multi selector to choose **Yes**, and press the **OK** button.

- A new cropped copy is created.

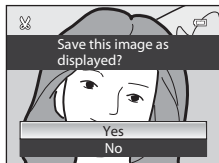

📎 **Image Size**

The narrower the cropping range, the smaller the size (amount of pixels) of the cropped picture copy. When the image size is resized to 320×240 or 160×120 by cropping, a black frame appears around the picture during playback, and the 📖 small picture icon is displayed on the left side of the monitor.

📎 **Cropping the Picture in its Current “Tall” Orientation**

Use the **Rotate image** option (🔄49) to rotate the picture so that it is displayed in landscape orientation. After cropping the picture, rotate the cropped picture back to “tall” orientation. The picture displayed in “tall” orientation can be cropped by zooming in on the picture until the black bars displayed on the both sides of the monitor disappear. The cropped picture is displayed in landscape orientation.

📎 **More Information**

See “File and Folder Names” (📁89) for more information.

Connecting the Camera to a TV (Viewing Images on a TV)

Connect the camera to a television to play back pictures on the television. If your television is equipped with an HDMI connector, you can connect it to the camera with a commercially available HDMI cable to play back pictures.

- 1 Turn off the camera.



- 2 Connect the camera to the TV.

When connecting using the included audio/video cable

- Connect the yellow plug to the video-in jack on the TV, and the red and white plugs to the audio-in jacks.

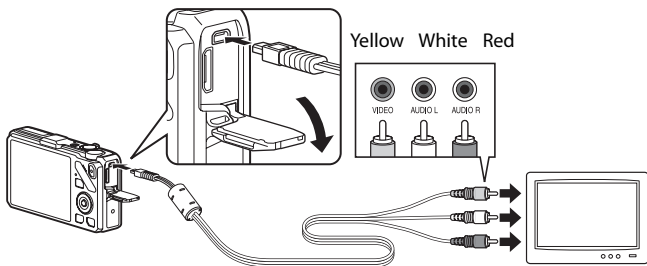

When connecting using a commercially available HDMI cable

- Connect the plug to the HDMI input connector on the TV.

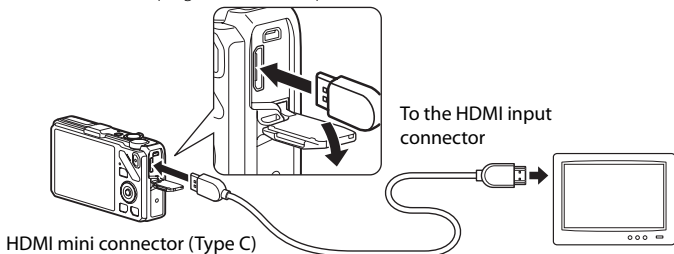

3 Tune the television to the video channel.

- See the instruction manual provided with your TV for details.

4 Hold down the button to turn on the camera.

- The camera enters playback mode, and the recorded pictures are displayed on the TV.
- While the camera is connected to the TV, the monitor remains off.

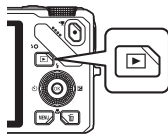

Notes on Connecting an HDMI Cable

An HDMI cable is not included. Use a commercially available HDMI cable to connect the camera to a TV. The output terminal on this camera is a HDMI Mini Connector (Type C). When purchasing an HDMI cable, be sure that the device end of the cable is a HDMI Mini Connector.

Notes on Connecting the Cable

- When connecting the cable, be sure that the plug is oriented correctly. Do not force the plug into the camera. When disconnecting the cable, do not pull the plug at an angle.
- Do not connect cables to the HDMI mini connector and USB/audio video connector simultaneously.

When Nothing Appears on the TV

Make sure that **TV settings** (79) in the setup menu is appropriate for your TV.

Using the TV's Remote Control (HDMI Device Control)

The remote control of a TV that conforms to the HDMI-CEC standard can be used to operate the camera during playback.

Instead of the multi selector or zoom control, the remote control can be used for picture selection, playback/pause of movies, switching between full-frame playback and four thumbnails display, etc.

- Set **HDMI device control** (79) of **TV settings** to **On** (default setting) in the setup menu, and connect the camera to the TV with an HDMI cable.
- Point the remote control at the TV to operate.
- See your TV's instruction manual or other related documentation to check whether your TV conforms to the HDMI-CEC standard.

Connecting the Camera to a Printer (Direct Print)

Users of PictBridge-compatible (🔌22) printers can connect the camera directly to the printer and print pictures without using a computer. The steps for printing are as follows.

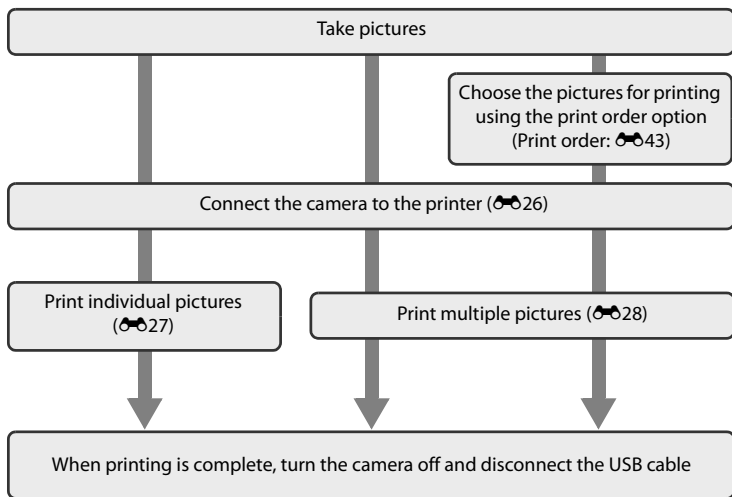

✔ Notes on Power Source

- When connecting the camera to a printer, use a fully charged battery to prevent the camera from turning off unexpectedly.
- If the AC Adapter EH-62F (available separately) (🔌91) is used, COOLPIX S9300/S9200 can be powered from an electrical outlet. Do not, under any circumstances, use an AC Adapter other than the EH-62F. Failure to observe this precaution could result in overheating or damage to the camera.

📎 Printing Pictures

In addition to printing pictures transferred to a computer and printing pictures with a direct camera-to-printer connection, the following options are also available for printing pictures recorded on the memory card:

- Insert a memory card into a DPOF-compatible printer's card slot.
- Take a memory card to a digital photo lab.

For printing using these methods, specify the pictures and the number of prints each using the **Print order** (🔌43) option in the playback menu.

Connecting the Camera to a Printer

- 1 Turn off the camera.

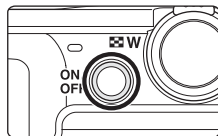

- 2 Turn on the printer.

- Check the printer settings.

- 3 Connect the camera to the printer using the included USB cable.

- Be sure that the plug is oriented correctly. When disconnecting the cable, do not pull the plug at an angle.

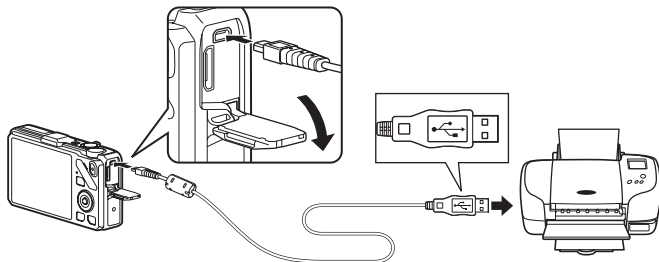

- 4 The camera is automatically turned on.

- When connected correctly, the **PictBridge** startup screen (①) is displayed on the camera monitor. Then the **Print selection** screen (②) is displayed.

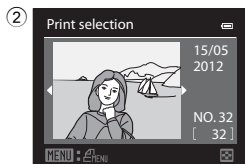

If the PictBridge Startup Screen Is Not Displayed

Turn the camera off and disconnect the USB cable. Set the **Charge by computer** option (80) in the camera's setup menu to **Off** and reconnect the cable.

Printing Individual Images

After connecting the camera to the printer correctly (📷26), print pictures by following the procedure below.

1 Use the multi selector to choose the picture to be printed, and press the **OK** button.

- Rotate the zoom control toward **W** (📷) to display 12 thumbnails, or toward **T** (📷) to switch back to full-frame playback mode.

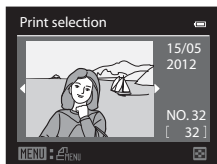

2 Choose **Copies** and press the **OK** button.

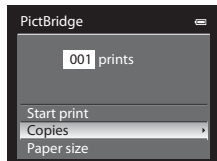

3 Choose the number of copies (up to nine) and press the **OK** button.

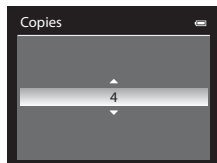

4 Choose **Paper size** and press the **OK** button.

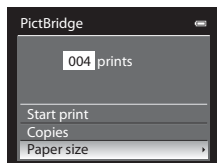

5 Choose the desired paper size and press the **OK** button.

- To specify the paper size using the printer settings, choose **Default** in the paper size menu.

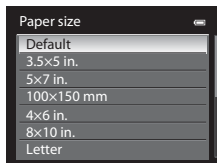

6 Choose **Start print** and press the **OK** button.

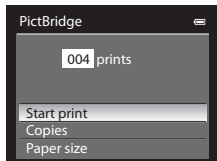

7 Printing starts.

- The monitor display returns to that shown in step 1 when printing is complete.
- To cancel before all copies have been printed, press the **OK** button.

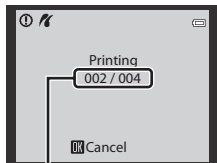

Current print/total number of prints

Printing Multiple Images

After connecting the camera to the printer correctly (26), print pictures by following the procedure below.

1 When the **Print selection** screen is displayed, press the **MENU** button.

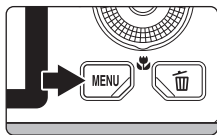

2 Use the multi selector to choose **Paper size**, and press the **OK** button.

- To exit the print menu, press the **MENU** button.

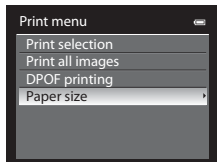

3 Choose the desired paper size and press the **OK** button.

- To specify the paper size using the printer settings, choose **Default** in the paper size menu.

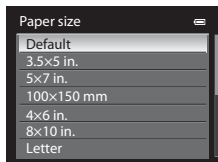

4 Choose **Print selection**, **Print all images** or **DPOF printing** and press the **OK** button.

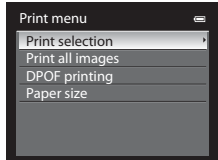

Print selection

Choose the pictures (up to a maximum of 99) and number of copies (up to nine per picture).

- Press the multi selector **◀** or **▶** to choose the pictures, and press **▲** or **▼** to set the number of copies for each.
- Pictures selected for printing can be recognized by the check mark icon and the numeral indicating the number of copies to be printed. A check mark is not displayed with pictures for which no copies have been specified and these pictures are not printed.
- Rotate the zoom control toward **T** (📷) to switch to full-frame playback mode, or **W** (📐) to switch to 12 thumbnail display.
- Press the **OK** button when setting is complete.
- When the menu shown on the right is displayed, choose **Start print** and press the **OK** button to start printing.
- Choose **Cancel** and press the **OK** button to return to the print menu.

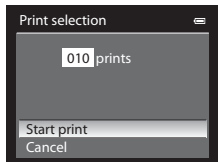

Print all images

All pictures stored in the internal memory or on the memory card are printed one per each.

- When the menu shown on the right is displayed, choose **Start print** and press the **OK** button to start printing.
- Choose **Cancel** and press the **OK** button to return to the print menu.

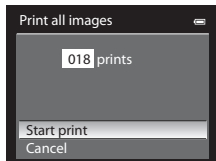

DPOF printing

Pictures for which a print order was created in **Print order** option (43) can be printed.

- When the menu shown on the right is displayed, choose **Start print** and press the **OK** button to start printing.
- Choose **Cancel** and press the **OK** button to return to the print menu.
- To view the current print order, choose **View images** and press the **OK** button. To print pictures, press the **OK** button again.

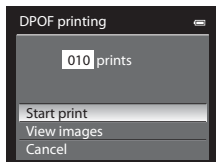

5 Printing starts.

- The monitor display returns to that shown in step 2 when printing is complete.
- To cancel before all copies have been printed, press the **OK** button.

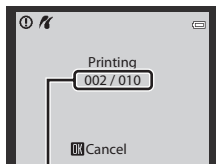

Current print/total number of prints

Paper Size

The camera supports the following paper sizes: **Default** (the default paper size for the current printer), **3.5×5 in.**, **5×7 in.**, **100×150 mm**, **4×6 in.**, **8×10 in.**, **Letter**, **A3**, and **A4**. Only sizes supported by the current printer are displayed.

Editing Movies

Extracting Only the Desired Portions of the Movie

The desired portions of a recorded movie can be saved as a separate file (except for movies recorded with  **iFrame 540 (960x540)**).

1 Play back the movie to be edited and pause at the start point of the portion that is to be extracted (📖92).

2 Use the multi selector ◀ or ▶ to choose ✂ on the playback control, and press the Ⓞ button.

- The movie editing screen is displayed.

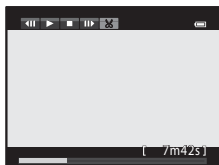

3 Press ▲ or ▼ to choose 📏 (Choose start point) on the editing playback control.

- Rotate the multi selector or press ◀ or ▶ to adjust the start position.
- To cancel, press ▲ or ▼ to choose ↶ (Back) and press the Ⓞ button.

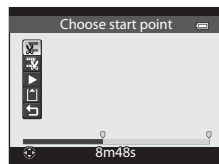

4 Press ▲ or ▼ to choose 📏 (Choose end point).

- Rotate the multi selector or press ◀ or ▶ to move the end point at the right end to the end position of the required section.
- To check the playback of the movie in the specified range before saving it, choose ▶ (Preview) and press the Ⓞ button. During preview playback, the volume can be adjusted with the zoom control **T/W**. Use the multi selector to fast forward or rewind. To stop the preview playback, press the Ⓞ button again.

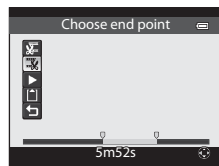

5 After finishing the settings, press ▲ or ▼ to choose 📁 (Save) and press the Ⓞ button.

6 Choose **Yes** and press the Ⓞ button.

- The edited movie is saved.
- To cancel the saving, choose **No**.







Notes on Editing Movies

- Use a fully charged battery to prevent the camera from turning off during editing. When the battery level is , movie editing is not possible.
- Once a movie is created through editing, it cannot be used again for extracting a movie. To extract another range, select and edit the original movie.
- Because the edited movies are extracted in 1-second units, they may vary slightly from the set start point and end point. Sections shorter than two seconds cannot be extracted.
- Editing functions are not available when there is not enough free space in the internal memory or on the memory card.





More Information

See "File and Folder Names" ( 89) for more information.

The Shooting Menu (for (Auto) Mode, Continuous Shooting Mode)







- See “Changing the Image Size (Image Mode)” (71) for more information on **Image mode**.
- Other than **Continuous** (36), items share the same settings with  (auto) mode and continuous shooting mode, and the settings are saved in the camera’s memory even if the camera is turned off.
- **Continuous** can be selected only when using continuous shooting mode. See “Continuous Shooting (Options)” (55) for more information.

White Balance (Adjusting Hue)

Select  (auto) mode or continuous shooting mode (25) → MENU button →  or  tab (11) → White balance



The color of light reflected from an object varies with the color of the light source. The human brain is able to adapt to changes in the color of the light source, with the result that white objects appear white whether seen in the shade, direct sunlight, or under incandescent lighting or fluorescent lighting. Digital cameras can mimic this adjustment of the human eye by processing images according to the color of the light source. This is known as “white balance.”

Although the default setting, **Auto**, can be used under most types of lighting, you can apply the white balance setting suited to a particular light source to achieve more accurate results.

Option	Description
AUTO Auto (default setting)	White balance is automatically adjusted to suit lighting conditions. Best choice in most situations.
PRE Preset manual	Useful when shooting under unusual lighting. See “Using Preset Manual” for more information ( 34).
 Daylight	White balance adjusted for direct sunlight.
 Incandescent	Use under incandescent lighting.
 Fluorescent	Use under fluorescent lighting.
 Cloudy	Use when taking pictures under overcast skies.
 Flash	Use with the flash.

The icon for the current setting is displayed on the monitor during shooting (6). When **Auto** is selected, an icon for the current setting is not displayed.

Notes on White Balance



- This feature may not be used in combination with certain features. See “Features That Cannot Be Used Simultaneously” (73) for more information.
- At white-balance settings other than **Auto** or **Flash**, set the flash mode to  (off) (61).

Using Preset Manual

Use when you want to make pictures taken under unusual lighting conditions (e.g., lamps with reddish-light) look as though they were shot in normal light.

Use the procedure below to measure the white balance value under the lighting used during shooting.

1 Place a white or gray reference object under the lighting that will be used during shooting.

2 Display the shooting menu (36), use the multi selector to set **White balance to PRE Preset manual**, then press the  button.

- The lens extends to the zoom position for measurement.

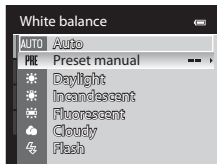

3 Choose **Measure**.

- To apply the most recently measured white balance value, select **Cancel** and press the  button. The most recently measured white balance value will be set without measuring the white balance value again.

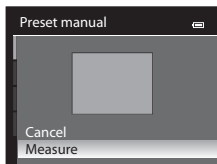

4 Frame a white or gray reference object in the reference object frame.

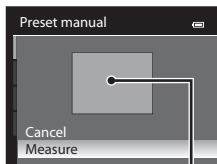

Reference object frame





5 Press the  button to measure the white balance value.

- The shutter is released and the new white balance preset value is set (no picture is recorded).

Note on Preset Manual



The camera cannot measure a white balance value for when the flash fires. When shooting with the flash, set **White balance to Auto or Flash**.

Metering

Select  (auto) mode or continuous shooting mode (25) → MENU button →  or 
tab (11) → Metering

The process of measuring the brightness of the subject to determine the exposure is known as “metering.”

Use this option to choose how the camera meters exposure.

Option	Description
 Matrix (default setting)	The camera uses a wide area of the screen for metering. This metering mode provides the appropriate exposure for a variety of shooting conditions. Recommended for typical shooting.
 Center-weighted	The camera meters the entire frame but assigns greatest weight to the subject at the center of the frame. The classic metering for portraits; it preserves background details while letting lighting conditions at the center of the frame determine exposure. Can be used with focus lock ( 76) to meter off-center subjects.

Notes on Metering

When the digital zoom is in effect, **Metering** automatically switches to **Center-weighted**, or to spot metering (where the center of the frame is metered).

Metering Area



When **Center-weighted** is selected for **Metering**, the metering range guide (6) is displayed (except when digital zoom is used).

Continuous Shooting

Select continuous shooting mode → MENU button →  tab (📖11) → Continuous

You can select the type of continuous shooting. See "Continuous Shooting (Options)" (📖55) for more information.

ISO Sensitivity

Select  (auto) mode or continuous shooting mode (📖25) → MENU button →  or  tab (📖11) → ISO sensitivity



The higher the ISO sensitivity, the less light needed for taking pictures.

The higher the ISO sensitivity, the darker the subject that can be shot. Additionally, even with subjects of similar brightness, pictures can be taken at faster shutter speeds, and blurring caused by camera shake and subject movement can be reduced.

- Setting the ISO sensitivity to a high level is effective when shooting dark subjects, not using the flash, shooting at the telephoto zoom position and similar situations, but the pictures taken may be slightly grainy.

Option	Description
Auto (default setting)	The sensitivity is ISO 125 in bright places; in dark places the camera automatically raises the sensitivity to a maximum of ISO 1600.
Fixed range auto	Choose the range in which the camera automatically adjusts ISO sensitivity from ISO 125-400 (default setting) and ISO 125-800 . The camera does not raise sensitivity beyond the maximum value in the selected range. Set the maximum value for ISO sensitivity to control "grain" that appears in images.
125, 200, 400, 800, 1600, 3200	ISO sensitivity is locked at the specified value.



The icon for the current setting is displayed on the monitor during shooting (📖6).

- When **Auto** is selected, the  icon is not displayed at ISO 125, but is displayed if the ISO sensitivity automatically increases to more than ISO 125 (📖26).
- When **Fixed range auto** is selected, the  icon and the maximum ISO sensitivity value are displayed.



Note on ISO Sensitivity







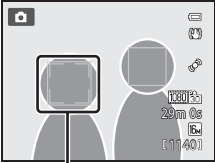

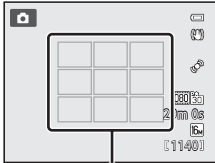

This feature may not be used in combination with certain features. See "Features That Cannot Be Used Simultaneously" (📖73) for more information.

AF Area Mode



Select  (auto) mode or continuous shooting mode (📖25) → MENU button →  or  tab (📖11) → AF area mode

You can set how the focus area is determined for autofocus.





Option	Description
 Face priority (default setting)	<p>The camera automatically detects and focuses on a face (see “Using Face Detection” (📖75) for more information). If the camera detects multiple faces, the camera focuses on the face closest to the camera. When non-human subjects are photographed, or a subject with which no face can be detected is framed, AF area mode is set to Auto. The camera automatically selects the focus areas (up to nine) that contain the subject closest to the camera.</p>  <p style="text-align: center;">Focus area</p>
 Auto	<p>The camera automatically selects the focus areas (up to nine) that contain the subject closest to the camera. Press the shutter-release button halfway to activate the focus area. When the shutter-release button is pressed halfway, the focus area selected by the camera is displayed on the monitor (up to nine areas).</p>  <p style="text-align: center;">Focus areas</p>

Option	Description
<p> Manual</p>	<p>Choose manually the focus position from 99 areas in the screen. This option is suited to situations in which the intended subject is relatively still and not positioned at the center of the frame. Rotate the multi selector or press , ,  or  to move the focus area to where the subject is, and take a picture.</p> <ul style="list-style-type: none"> To adjust the following settings, press the  button to temporarily cancel focus area selection, and then adjust each setting. <ul style="list-style-type: none"> - Flash mode, macro mode, self-timer or creative slider To return to the focus area selection screen, press the  button again.
<p> Center</p>	<p>The camera focuses on the subject at the center of the frame. The focus area is always displayed at the center of the frame.</p>
<p> Subject tracking</p>	<p>Subject tracking begins once you select a subject to be focused on, and the focus area will move and follow the subject. See "Using Subject Tracking" (39).</p>

 **Notes on AF Area Mode**

- When the digital zoom is in effect, the camera focuses on the subject at the center of the frame regardless of the applied **AF area mode** option.
- In some rare cases of shooting subjects for which autofocus does not perform as expected (29), the subject may not be in focus.
- This feature may not be used in combination with certain features. See "Features That Cannot Be Used Simultaneously" (73) for more information.

Using Subject Tracking

Select  (auto) mode (25) or continuous shooting mode → MENU button →  or  tab (11) → AF area mode

Choose this mode to shoot moving subjects. Subject tracking begins once you select a subject to be focused on, and the focus area will move and follow the subject.

1 Rotate the multi selector to select Subject tracking, and press the button.

- Press the MENU button after changing the settings and return to the shooting screen.

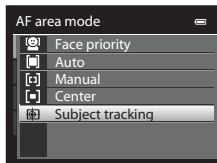

2 Frame the subject at the center of the border, and press the button.

- The subject is registered.
- When the camera is unable to focus on the subject, the border lights in red. Change the composition and try again.
- Once the subject is registered, it is framed by a yellow focus area display, and subject tracking begins.
- Press the  button to cancel the registration of the subject.
- If the camera loses sight of the subject, the focus area display disappears; register the subject again.

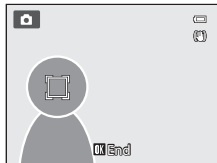



3 Press the shutter-release button all the way to take the picture.

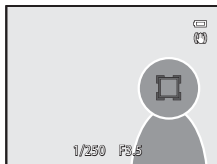



- If the camera focuses on the focus area when the shutter-release button is pressed halfway, the focus area display lights in green and the focus is locked.
- If the shutter-release button is pressed halfway while the focus area is not displayed, the camera focuses the subject at the center of the frame.



Notes on Subject Tracking

- The digital zoom is not available.
- Set the zoom position, flash mode, creative slider, or menu settings before registering a subject. If any of these are changed after a subject is registered, the subject will be canceled.
- During certain conditions, such as when the subject is moving quickly, when there is a large amount of camera shake, or when there are multiple subjects that look alike, the camera may not be able to register or track a subject, or the camera may track a different subject. Additionally, the subject may not be tracked properly depending on factors such as the subject's size and brightness.
- In some rare cases of shooting subjects for which autofocus does not perform as expected (29), the subject may not be in focus despite the fact that the focus area lights in green. If you cannot focus, change the **AF area mode** to **Manual** or **Center**, or try shooting with focus lock (76) by refocusing on another subject at the same distance.
- This feature may not be used in combination with certain features. See "Features That Cannot Be Used Simultaneously" (73) for more information.

Autofocus Mode

Select  (auto) mode or continuous shooting mode (25) → MENU button →  or 
tab (11) → Autofocus mode

Choose how the camera focuses.

Option	Description
AF-S Single AF (default setting)	The camera focuses only when the shutter-release button is pressed halfway.
AF-F Full-time AF	The camera focuses continuously until the shutter-release button is pressed halfway. Use with moving subjects. A sound will be heard while the camera focuses.

Autofocus Mode for Movie Recording

Autofocus mode for movie recording can be set with **Autofocus mode** (57) in the movie menu.

The Smart Portrait Menu

Image Mode (Image Size and Quality)

See "Changing the Image Size (Image Mode)" (📖71) for more information on **Image mode**.

Skin Softening

Display the shooting screen in smart portrait mode (📖50) → MENU button → 📷 tab (📖51) → Skin softening

Enable skin softening.

Option	Description
⬆️⬆️ High	When the shutter is released, the camera detects one or more human faces (up to three), and processes the image to make facial skin tones softer before saving the image. The degree of skin softening applied can be selected.
⬆️ Normal (default setting)	
⬆️ Low	
OFF Off	Disables skin softening.

When skin softening is enabled, the icon for the current setting is displayed on the monitor during shooting (📖6). When **Off** is selected, an icon for the current setting is not displayed. The effects of skin softening are not visible when framing pictures for shooting. Check the degree of skin softening performed in playback mode.

Smile Timer

Display the shooting screen in smart portrait mode (📖50) → MENU button → 📷 tab (📖51) → Smile timer

The camera detects human faces and then automatically releases the shutter whenever a smile is detected.



Option	Description
😊 On (default setting)	Enables smile timer.
OFF Off	Disables smile timer.

When smile timer is enabled, the icon for the current setting is displayed on the monitor during shooting (📖6). When **Off** is selected, an icon for the current setting is not displayed.

Blink Proof

Display the shooting screen in smart portrait mode (📖50) → MENU button → 📷 tab (📖51) → Blink proof

The camera automatically releases the shutter twice each time a picture is taken. Of the two shots, one in which the subject's eyes are open is saved.

Option	Description
 On	Enables blink proof. Flash cannot be used when On is selected. If the camera saved an image in which the subject's eyes may have been closed, the dialog shown on the right is displayed for a few seconds. 
OFF Off (default setting)	Disables blink proof.

When blink proof is enabled, the icon for the current setting is displayed on the monitor during shooting (📖6). When **Off** is selected, an icon for the current setting is not displayed.

The Playback Menu

- For more information about image editing functions; (**Quick retouch**, **D-Lighting**, **Skin softening**, **Filter effects** and **Small picture**), see "Editing Still Images" (🔗16).
- For more information about **Favorite pictures** and **Remove from favorites**, see "Favorite Pictures Mode" (🔗9).

🖨️ Print Order (Creating a DPOF Print Order)

Press the  button (Playback mode) → MENU button (📖11) → 🖨️ Print order

If you choose to use one of the following methods to print pictures that are stored on a memory card, the pictures to print and the number of copies can be set in advance on the memory card.

- Printing with a DPOF-compatible (🔗22) printer that is equipped with a card slot.
- Ordering the prints to a digital photo lab that has a DPOF service.
- Printing by connecting the camera to a PictBridge-compatible (🔗22) printer (🔗26). (When the memory card is removed from the camera, the print order can also be performed for the pictures stored on the internal memory.)

1 Use the multi selector to choose **Select images**, and press the **OK** button.

- When favorite pictures mode, auto sort mode or list by date mode is selected, the menu shown on the right is not displayed. Proceed to step 2.

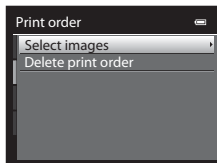

2 Choose the pictures (up to a maximum of 99) and number of copies (up to nine per picture).

- Rotate the multi selector or press **◀** or **▶** to choose the pictures, and press **▲** or **▼** to set the number of copies for each.
- Pictures selected for printing can be recognized by the check mark icon and the numeral indicating the number of copies to be printed. If no copies have been specified, the selection is canceled.
- Rotate the zoom control toward **T** (🔍) to switch to full frame playback mode, or **W** (🖼️) to switch to 12 thumbnail display.
- Press the **OK** button when setting is complete.



3 Choose whether or not to also print shooting date and shooting information.

- Choose **Date** and press the **OK** button to print the shooting date on all pictures in the print order.
- Choose **Info** and press the **OK** button to print shooting information (shutter speed and aperture value) on all pictures in the print order.
- Choose **Done** and press the **OK** button to complete the print order.

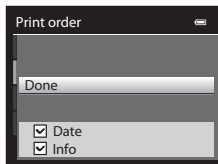

Pictures with the print orders are recognized by the  icon displayed in playback mode.

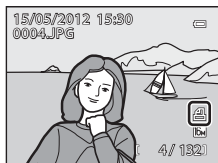

Notes on Printing Shooting Date and Shooting Information

When the **Date** and **Info** options are enabled in the print order menu, shooting date and shooting information can be printed on pictures when a DPOF-compatible () printer which supports printing of shooting date and shooting information is used.

- Shooting information cannot be printed when the camera is connected directly to a printer, via the included USB cable, for DPOF printing (.
- **Date** and **Info** are reset each time the **Print order** menu is displayed.
- The date and time printed on the picture are the same as those set on the camera when the picture was taken. The date and time printed using this option are not affected if the camera's **Time zone and date** setting is changed from the setup menu after the pictures are taken.



✓ Notes on Print Order

When a print order is created in favorite pictures mode, auto sort mode, or list by date mode, the screen shown below is displayed if pictures other than those in the selected album, category, or shooting date have been marked for printing.

- Select **Yes** to add the print order setting to the existing print order.
- Select **No** to remove the existing print order and restrict the print order setting.

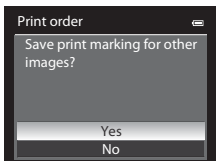

Favorite pictures mode
or auto sort mode

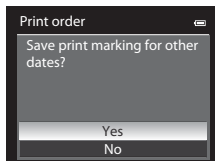

List by date mode

Additionally, if there are more than 99 pictures as a result of adding the current print order setting, the screen shown below will be displayed.

- Select **Yes** to remove the existing print order and restrict the print order setting.
- Select **Cancel** to retain the existing print order and remove the print order setting.

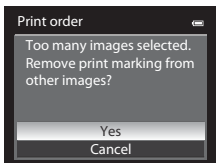

Favorite pictures mode
or auto sort mode

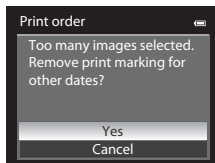

List by date mode



✂ Deleting All Print Orders

In step 1 of the print order procedure (🔍43), choose **Delete print order** and press the **OK** button to delete the print orders for all pictures.

✂ Print date



The shooting date and time can be imprinted on pictures at the time of shooting by using **Print date** (🔍72) in the setup menu. This information can be printed even from printers that do not support printing of the date and time. Only the date and time of print date on the pictures are printed, even if **Print order** is enabled with the date selected in the print order screen.

Slide Show

Press the  button (Playback mode) → MENU button () →  Slide show



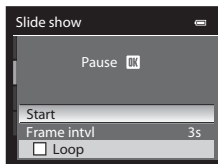

View pictures stored in the internal memory or on a memory card in an automatic slide show.

1 Use the multi selector to choose **Start**, and press the button.

- To change the interval between pictures, choose **Frame intvl**, and press the , and then select the desired interval time before choosing **Start**.
- To repeat the slide show automatically, enable **Loop** and press the  before choosing **Start**. The check mark () is added to the loop option when enabled.





2 The slide show begins.

- Press the multi selector  to display the next picture, or  to display the previous picture. Press and hold  to fast forward, or  to rewind.
- To exit partway or pause, press the  button.





3 Choose End or Restart.



- After the last frame is played back or during playback pause, the screen shown on the right is displayed. Choose  and press the  button to return to step 1. Choose  to play the slide show again.



Notes on Slide Shows

- Only the first frame of movies () included in slide shows is displayed.
- For sequences () whose sequence display options are set to **Key picture only**, only the key picture is displayed.
- Images captured using easy panorama are displayed full-frame when played in a slide show. They do not scroll.
- Slide shows play for a maximum of about 30 minutes, even when **Loop** is selected ()



Protect

Press the  button (Playback mode) → MENU button () →  Protect

Protect selected pictures from accidental deletion.

In the image selection screen, choose a picture and set or cancel protection. See “The Image Selection Screen” ()48) for more information.

Note, however, that formatting the camera’s internal memory or the memory card ()78) permanently erases the protected files.

Protected pictures are recognized by the  icon in playback mode ()8).

The Image Selection Screen

The image selection screen is displayed in the following menus.

Only one image can be selected for some menu items, while for other menu items, multiple images can be selected.

Functions for which only one image can be selected	Functions for which multiple images can be selected
<ul style="list-style-type: none"> • Playback menu: Rotate image (🔍49), Choose key picture (🔍52) • Setup menu: Select an image in Welcome screen (🔍66) 	<ul style="list-style-type: none"> • Playback menu: Select images in Print order (🔍43), Protect (🔍47), Selected images in Copy (🔍51) Favorite pictures Remove from favorites • Erase selected images in Delete (📖32)

Follow the procedure described below to select images.

1 Rotate the multi selector, or press ◀ or ▶ to choose the desired image.

- Rotate the zoom control toward **T** (🔍) to switch to full-frame playback mode, or **W** (📖) to switch to 12 thumbnail display.
- For functions for which only one image is selected, proceed to step 3.



2 Press ▲ or ▼ to set ON or OFF images (or the number of copies).

- When **ON** is selected, a check mark (☑) is displayed with the image. Repeat steps 1 and 2 to select additional images.



3 Press the ⓄK button to apply the image selection.



- With selections such as **Selected images**, the confirmation dialog is displayed. Follow the instructions on the screen.

Rotate Image

Press the  button (Playback mode) → MENU button () →  Rotate image

Change the orientation of pictures played back in the camera's monitor after shooting. Still pictures can be rotated 90° clockwise or counterclockwise.

Pictures that were recorded in the "tall" orientation can be rotated up to 180° in either direction.

Select a picture in the picture selection screen () to display the rotate image screen. Rotate the multi selector, or press  or  to rotate the picture 90°.

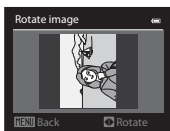

Rotated 90°
counterclockwise

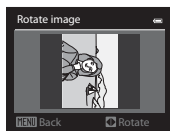
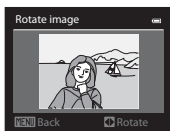













Rotated 90°
clockwise





Press the  button to set the orientation displayed and save the orientation data with the picture.

Notes on Image Rotation

- Images captured with cameras other than COOLPIX S9300/S9200 cannot be rotated.
- Images captured using 3D photography cannot be rotated.
- While only the key picture of a sequence is displayed, images cannot be rotated. Apply the setting after displaying individual images (, , , , , , , , , , , , , ,



Voice Memo

Press the  button (Playback mode) → Select a picture → **MENU** button (11) →  Voice memo

Use the camera's microphone to record voice memos for pictures.

- The recording screen is displayed for a picture without voice memo, while the voice memo playback screen is displayed for a picture with voice memo (a picture marked with  in full-frame playback mode).

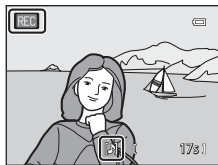

Recording Voice Memos

- Voice memo can be recorded for up to about 20 seconds while the  button is pressed.
- Do not touch the microphone during recording.
- During recording, **REC** and  flash on the monitor.
- When recording ends, the voice memo playback screen is displayed.





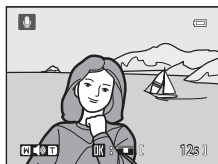

Playing Voice Memos

Pictures for which voice memos have been recorded are indicated by  in full-frame playback mode.

- Press the  button to play back a voice memo. To end playback, press the  button again.
- Rotate the zoom control toward **T** or **W** during playback to adjust playback volume.
- Press the multi selector  before or after playing a voice memo to return to the playback menu. Press the **MENU** button to exit the playback menu.



Deleting Voice Memos

Press the  button on the voice memo playback screen. Press the multi selector  or  to select **Yes** and press the  button to delete only the voice memo.

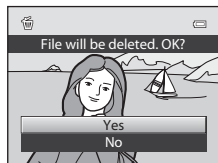

Notes on Voice Memos

- When a picture with a voice memo attached is deleted, both the picture and its voice memo are deleted.
- Voice memos cannot be recorded for a picture that already has a voice memo attached to it. The current voice memo must be deleted before a new voice memo can be recorded.
- Voice memos cannot be attached to pictures taken with cameras other than COOLPIX S9300/S9200.
- Voice memos of the images with the **Protect** setting () cannot be deleted.

More Information

See "File and Folder Names" () for more information.

☰ Copy (Copy Between Internal Memory and Memory Card)

Press the  button (Playback mode) → MENU button (☰11) → ☰ Copy



Copy pictures between the internal memory and a memory card.

1 Use the multi selector to select an option from the copy screen, and press the button.

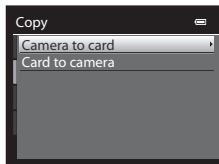
- **Camera to card:** Copy pictures from the internal memory to the memory card.
- **Card to camera:** Copy pictures from the memory card to the internal memory.







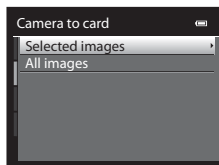

2 Select a copy option and press the button.

- **Selected images:** Copy pictures selected from the image selection screen (48). If a sequence for which only a key picture is displayed is selected (7), all pictures in the displayed sequence are copied.
- **All images:** Copy all pictures. If a picture in a sequence is selected, this option is not displayed.
- **Current sequence:** This option is displayed when a picture in a sequence has been selected before displaying the playback menu. All pictures in the current sequence are copied.



☑ Notes on Copying Pictures

- JPEG-, MOV-, WAV-, and MPO-format files can be copied. Files recorded in any other format cannot be copied.
- **Voice memo** (50) attached to pictures and **Protect** setting (47) are also copied with the pictures.
- Pictures recorded with another make or model of camera or that have been modified on a computer cannot be copied.
- **Print order** settings(43) are not copied with the pictures.
- If **Sequence display options** (52) is set to **Key picture only** and a picture in the sequence is selected and the  button is pressed to display individual pictures (7), only **Card to camera** image copy is available.



Message: “Memory contains no images.”

If there are no pictures stored on the memory card when playback mode is selected, the message, **Memory contains no images.**, is displayed. Press the **MENU** button and select **Copy** from the playback menu to copy the pictures stored in the camera's internal memory to the memory card.

More Information

See “File and Folder Names” (📷89) for more information.

Sequence Display Options

Press the  button (Playback mode) → **MENU** button (📖11) →  Sequence display options

Choose the method used to display a series of pictures shot continuously (sequence, 📷7) when viewing them in full-frame playback mode (📖30) or in thumbnail playback mode (📖31).

Settings are applied to all sequences, and the setting is saved in the camera's memory even if the camera is turned off.

Option	Description
Individual pictures	Each picture in a sequence is displayed.
Key picture only (default setting)	Return a sequence in which pictures are displayed individually to the key picture only display.

Choose Key Picture



Press the  button (Playback mode) → Select the desired sequence → **MENU** button (📖11) →  Choose key picture

When **Sequence display options** is set to **Key picture only**, the key picture displayed in full-frame playback mode (📖30) or thumbnail playback mode (📖31) can be set for each sequence of pictures.

- When changing this setting, before pressing **MENU**, first select the desired sequence using full-frame playback mode or thumbnail playback mode.
- When the key picture selection screen is displayed, select a picture. See “The Image Selection Screen” (📷48) for more information.

The Movie Menu

Movie Options





Display the shooting screen → MENU button →  (Movie) tab (11) → Movie options

You can choose the type of movie to shoot.

The camera can record normal speed movies and HS (high speed) movies ()55), which can be played back in slow motion or fast motion.

The larger the image size and bit rate, the higher the image quality; however, the file size also becomes larger.

Normal Speed Movies

Option	Description
 HD 1080p★ (1920×1080) (default setting)	Movies with an aspect ratio of 16:9 are recorded. <ul style="list-style-type: none">• Movie bitrate: 14.7 Mbps• Frame rate: approx. 30 frames per second
 HD 1080p (1920×1080)	Movies with an aspect ratio of 16:9 are recorded. <ul style="list-style-type: none">• Movie bitrate: 12.3 Mbps• Frame rate: approx. 30 frames per second
 HD 720p (1280×720)	Movies with an aspect ratio of 16:9 are recorded. <ul style="list-style-type: none">• Movie bitrate: 6.1 Mbps• Frame rate: approx. 30 frames per second
 iFrame 540 (960×540)	Movies with an aspect ratio of 16:9 are recorded. It is one of the formats supported by Apple Inc. <ul style="list-style-type: none">• Movie bitrate: 20.8 Mbps• Frame rate: approx. 30 frames per second When using the camera's internal memory for recording, the movie recording may end unexpectedly depending on the composition of the image. Using a memory card (Class 6 or higher) is recommended when recording important movies.
 VGA (640×480)	Movies with an aspect ratio of 4:3 are recorded. <ul style="list-style-type: none">• Movie bitrate: 2.9 Mbps• Frame rate: approx. 30 frames per second

Note on iFrame 540 (960×540)



The movie editing functions cannot be used.

More Information

See "Maximum Movie Length" (90) for more information.

HS Movies

See “Recording Movies in Slow Motion and Fast Motion (HS Movie)” (055) for more information.



Option	Description
 HS 120 fps (640×480)	1/4-speed slow motion movies with an aspect ratio of 4:3 are recorded. <ul style="list-style-type: none"> • Max. movie length*: 10 s (playback time: 40 s) • Movie bitrate: 2.9 Mbps • Frame rate: approx. 120 frames per second
 HS 60 fps (1280×720)	1/2-speed slow motion movies with an aspect ratio of 16:9 are recorded. <ul style="list-style-type: none"> • Max. movie length*: 30 s (playback time: 1 min) • Movie bitrate: 6.1 Mbps • Frame rate: approx. 60 frames per second
 HS 15 fps (1920×1080)	2x speed fast motion movies with an aspect ratio of 16:9 are recorded. <ul style="list-style-type: none"> • Max. movie length*: 2 min (playback time: 1 min) • Movie bitrate: 12.3 Mbps • Frame rate: approx. 15 frames per second

* The maximum recording time refers only to the section shot for slow motion or fast motion playback.

- The movie bitrate is the volume of movie data recorded per second. As a variable bitrate (VBR) system has been adopted, the movie bitrate varies automatically according to the subject so that more data is recorded per second for movies containing frequently moving subjects, thus increasing movie file size.

Notes on HS Movie Recording and Special Effects Mode Setting

 **HS 120 fps (640×480)** for **Movie options** cannot be selected when **Soft** or **Nostalgic sepia** is selected for the special effects shooting mode.

Even if you select  **HS 120 fps (640×480)** for another recording mode while **Soft** or **Nostalgic sepia** is selected for the special effects shooting mode,  **HS 60 fps (1280×720)** is automatically selected for **Movie options** when the mode dial is rotated to **EFFECTS**.

Open with HS Footage

Display the shooting screen → MENU button →  (Movie) tab (11) → Open with HS footage

Select whether or not to record slow motion or fast motion movies from the start of the recording when HS movies are recorded.

Option	Description
On (default setting)	HS movies are recorded when recording begins.
Off	Normal speed movies are recorded when recording begins. Press the  button to switch to HS movie recording at the point where the camera should record for slow motion or fast motion playback.

Recording Movies in Slow Motion and Fast Motion (HS Movie)

Display the shooting screen → MENU button →  (Movie) tab (11) → Movie options





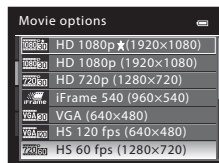

HS (high speed) movies can be recorded. Movies recorded using HS movie can be played back in slow motion at 1/4 or 1/2 of normal playback speed, or played back in fast motion at a speed two times faster than normal speed.

1 Use the multi selector to select HS movie ()54), and press the button.

- Press the MENU button after changing the settings and return to the shooting screen.



2 Press the (movie-record) button to start recording.

- When the **Open with HS footage** ()54) in the movie menu is set to **On**, HS movies are recorded when recording begins.
- When the **Open with HS footage** ()54) in the movie menu is set to **Off**, normal speed movies are recorded when recording begins. Press the  button to switch to HS movie recording at the point where the camera should record for slow motion or fast motion playback.
- If recording time for HS movies ()54) runs out or the  button is pressed, the camera switches to normal speed movie recording. The camera switches between normal speed movie recording and HS movie recording each time the  button is pressed.
- During HS movie recording, the maximum movie length display changes and displays the amount of recording time available for HS movie recording.
- The movie options icon changes between HS movie recording and normal speed movie recording.

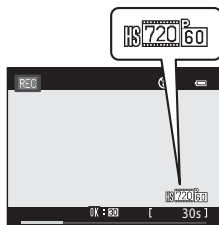

When recording HS movies

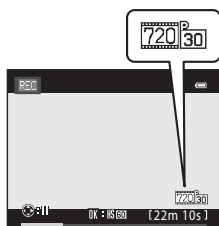

When recording normal speed movies

3 Press the (movie-record) button to end recording.

✓ Notes on HS Movie

- The sound is not recorded.
- Zoom position, focus, exposure and white balance are locked when the  (movie-record) button is pressed to start recording.

HS Movie

Recorded movies are played back at about 30 frames per second.

When **Movie options** () in the movie menu is set to **VGA120 HS 120 fps (640×480)** or **720p60 HS 60 fps (1280×720)**, movies that can be played back in slow motion can be recorded.

When set to **1080p15 HS 15 fps (1920×1080)**, movies that can be played back in fast motion at a speed two times faster than normal speed can be recorded.

Portions recorded at **VGA120 HS 120 fps (640×480)**:

Movies are recorded for up to 10 seconds at high speed, and are played back in slow motion at a speed four times slower than normal speed.

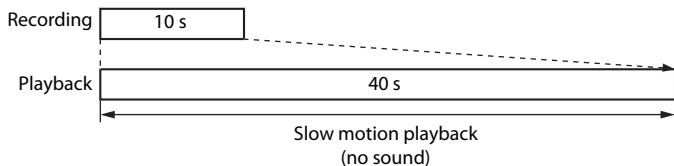

Portions recorded at **1080p15 HS 15 fps (1920×1080)**:

A movie of up to 2 minutes in length is recorded when shooting for the purpose of fast motion playback. Movies are played back two times faster than normal speed.

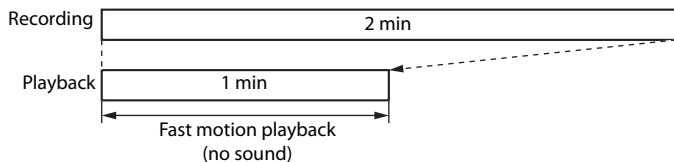

Autofocus Mode

Display the shooting screen → MENU button →  (Movie) tab (📖11)
→ Autofocus mode

Choose how the camera focuses when recording normal speed movies (53).

Option	Description
AF-S Single AF (default setting)	Lock on the focus when the ● ( movie-record) button is pressed to start recording. Select this option when the distance between the camera and the subject remains fairly consistent.
AF-F Full-time AF	The camera focuses continuously during movie recording. Suitable for shooting when the distance between the camera and subject changes. The operation sound of when the camera focuses may be recorded. Setting to Single AF is recommended if the sound is noticeable.

Wind Noise Reduction

Display the shooting screen → MENU button →  (Movie) tab (📖11)
→ Wind noise reduction

Set whether or not to reduce wind noise during normal speed movie recording (53).

Option	Description
 On	The noise of wind blowing on the camera's built-in microphone is minimized during recording. This setting is suitable for recording in strong winds. Other sounds may become difficult to hear in playback mode.
OFF Off (default setting)	Wind noise is not reduced.

- When **On** is selected, an icon for this setting is displayed on the monitor during movie recording (📖6).
- When HS movie recording is selected in **Movie options**, wind noise reduction cannot be used. The setting is fixed at **Off**.

GPS Options (COOLPIX S9300 only)

GPS Settings

Press the **MENU** button →  (GPS options) tab (📖11) → GPS options

Option	Description
Record GPS data	When set to On , signals are being received from the GPS satellite, and positioning starts (📖94). <ul style="list-style-type: none">• The default setting is Off.
Synchronize	Signals from the GPS satellite are used to set the date and time of the camera's internal clock (only when Record GPS data in GPS options of the GPS options menu is set to On). Check the positioning status before starting Synchronize.
Update A-GPS file	A memory card is used to update the A-GPS (assist GPS) file. Using the latest A-GPS file can shorten the time needed for tracking of the position information.

Notes on Synchronize

- Date/time adjustment by **Synchronize** is set according to the time zone set in **Time zone and date** (📖22, 📷67) of the setup menu. Check the time zone before setting **Synchronize**.
- The date/time set using **Synchronize** is not as accurate as radio clocks. Use **Time zone and date** in the setup menu to set the time if it is not accurate in **Synchronize**.

Updating the A-GPS File

Download the latest A-GPS file from the website below, and use it to update the file.

<http://nikonimglib.com/agps/index.html>



- The A-GPS file for COOLPIX S9300 is only available from the website above.

- 1** Download the latest A-GPS file to the computer from the website.
- 2** Use a card reader or other devices to copy the downloaded file to the "NCFL" folder of the memory card.
 - The "NCFL" folder is located directly under the memory card root directory. If the memory card does not have "NCFL" folder, create a new folder.
- 3** Insert the memory card containing the copied file into the camera.
- 4** Turn on the camera.
- 5** Press the **MENU** button to display the GPS options menu, and use the multi selector to select **GPS options**.
- 6** Select **Update A-GPS file**, and update the file.



Notes on Updating A-GPS File

- The A-GPS file is not enabled the first time positioning is performed after you purchase the camera. The file is enabled the second time positioning is performed.
- The validity period of the A-GPS file is seven days. The validity period can be checked on the update screen.
- Once the validity period of the A-GPS file has expired, tracking of the position information will not become faster. Updating of the A-GPS file before using the GPS feature is recommended.

Points of Interest (POI) (Recording and Displaying Location Name Information)

Press the **MENU** button →  (GPS options) tab (11) → Points of interest (POI)

This shows how to set the POI (point of interest, location name information).

Option	Description
Embed POI	When set to On , the location name information is recorded on the pictures to be shot (excluding movies). <ul style="list-style-type: none"> • The default setting is Off.
Display POI	When set to On , the location name information is displayed on the shooting screen or playback screen ( 6,  8). If Embed POI was set to On when a picture was taken, the location name information for the picture is displayed on the playback screen. <ul style="list-style-type: none"> • The default setting is Off.
Level of detail	Set the display level of the location name information. A higher display level shows more detailed regional information. <ul style="list-style-type: none"> • When set to level 1: country names are displayed. • When set to levels 2 to 5: the information displayed varies depending on the country. • When set to level 6: landmark names (facilities) are displayed.
Edit POI	If Update POI is selected during playback mode, the location name information recorded on the image can be changed. Select the image whose location name information you want to edit, before pressing the MENU button. <ul style="list-style-type: none"> • When level 6 is selected, press the multi selector ◀ or ▶ to change the landmark name. • To change the POI information level, press the multi selector ▲ or ▼. If Remove POI is selected, the location name information recorded on the image is deleted.

POI Display

If there is no location name information in the display level that was set, "---" is displayed.

Create Log (Record the Log of Moving Information)

Press the **MENU** button →  (GPS options) tab (11) → Create log

When log recording starts, the measured tracking information for a certain duration is recorded until a preset time has elapsed.

- It is not possible to use the log data by simply recording it. To use the data, select **End log** and save it to a memory card.

- Use the multi selector to select **Start log**, and press the **OK** button.

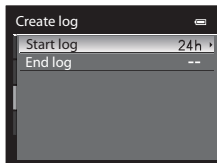

- Select the duration that the log will be recorded, and press the **OK** button.

- Log recording starts.
- The log data is recorded at one minute intervals until the preset time is reached.
- LOG** is displayed on the screen during log recording.

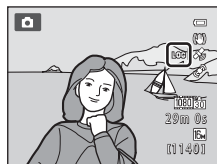
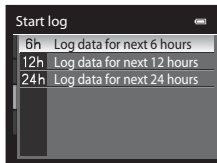

- When log recording is completed, select **End log** in **Create log** in the GPS options menu, and press the **OK** button.

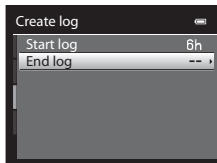

4 Select **Save log**, and press the **OK** button.

- The log data is saved to a memory card.

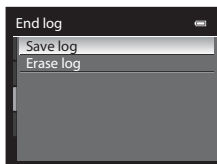
**✓ Notes on Log Recording**

- If the date and time are not set, the log cannot be recorded.
- Use a fully charged battery to prevent the camera from turning off unexpectedly during log recording. When the battery power becomes exhausted, log recording ends.
- Log recording ends due to the operation below, even when there is time remaining for log recording.
 - The USB cable is connected.
 - The battery is removed.
 - **Record GPS data** in **GPS options** is set to **Off** (same as when **Reset all** is performed).
 - The setting of the internal clock (time zone or date and time) is changed.
- Log recording is paused during the operations below.
 - During continuous shooting
 - During movie recording
- If time for log recording still remains even when the camera is turned off, log recording is continuously performed until the preset time has elapsed.
- The log data is temporarily stored in the camera. New logs cannot be recorded if the log data remains in the camera. After recording log data, save it to a memory card.
- A maximum of 36 log data events can be recorded in one day.
- A maximum of 100 log data events can be saved to a single memory card.

✍ To Erase Log Data

- To erase the log data that is temporarily stored in the camera, select **Erase log** in step 4.
- To erase the log data that is stored in the memory card, press the **🗑** button in **View log** (063).

✍ Log Data

Log data is NMEA format-compliant. However, display in all NMEA format-compliant software or on all NMEA format-compliant cameras is not guaranteed.

View Log

Press the **MENU** button →  (GPS options) tab (📖11) → View log

Confirm or delete the log data saved in the memory card using **Create log** (61).

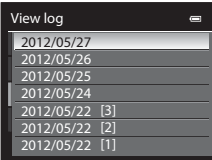

View log	
2012/05/27	
2012/05/26	
2012/05/25	
2012/05/24	
2012/05/22	[3]
2012/05/22	[2]
2012/05/22	[1]

To Erase Log Data

Press the  button and select either function.

- **Selected log:** The log data is erased.
- **All logs:** All log data stored on the memory card is erased.

Electronic Compass

Press the **MENU** button →  (GPS options) tab (11) → Electronic compass

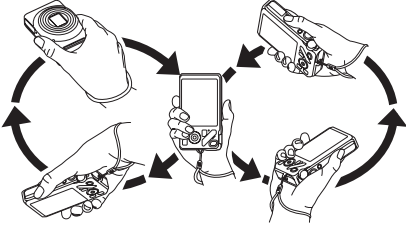
Option	Description
Compass display	<p>When set to On, a compass is displayed on the shooting screen.</p> <ul style="list-style-type: none"> • The default setting is Off. • The direction the camera is pointing is displayed based on measured direction information. • When the monitor faces upward, the compass indicator switches to a circle compass with a red arrow that points north. <ul style="list-style-type: none"> - Display style: north, east, south and west - Display range: 16 cardinal points
Compass correction	<p>Correct the compass when the compass direction is not displayed correctly.</p> <p>When the screen shown on the right is displayed, swing the camera to draw a figure eight in the air while turning your wrist to face the camera forward and backward, side to side, or up and down.</p> <div data-bbox="681 543 926 722" style="border: 1px solid black; padding: 5px; margin: 10px 0;"> <p>Compass correction (11)</p> <p>Move camera in a figure eight</p>  </div> 

✓ Notes on Using the Electronic Compass

- The electronic compass is not displayed when the camera lens is facing upwards.
- Do not use the electronic compass in this camera for mountain climbing and other specialized applications. The displayed information is intended as a general guide only.
- Direction may not be measured correctly near the following objects: magnets, metals, electrical motors, electrical home appliances or electrical power cables.
- Direction may not be measured correctly in the following places: in automobiles, trains, ships, airplanes, inside buildings or in underground malls
- Direction may not be measured correctly if the position information is not recorded.

The Setup Menu

Welcome Screen

Press the **MENU** button → **Y** tab (📖11) → Welcome screen

Choose whether or not to display the welcome screen on the monitor when the camera is turned on.

Option	Description
None (default setting)	Display the shooting or playback screen without displaying the welcome screen.
COOLPIX	Display the welcome screen before displaying the shooting or playback screen.
Select an image	Select a picture taken to display as the welcome screen. Display the image selection screen, choose an image (📷48), and press the OK button to register it. <ul style="list-style-type: none">• Because the selected image is stored in the camera, the image appears in the welcome screen even if the original image is deleted.• The following pictures cannot be registered.<ul style="list-style-type: none">- Pictures taken with an Image mode (📖71) of 4608×2592- Pictures reduced to 320 × 240 or smaller using small picture editing (📷21) or crop (📷22)- Pictures taken with easy panorama- Pictures taken using 3D photography

Time Zone and Date

Press the MENU button → Y tab (📖11) → Time zone and date

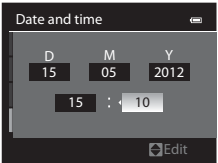
Option	Description
Date and time	<p>Set the camera clock to the current date and time. Use the multi selector to set the date and time.</p> <ul style="list-style-type: none"> Choose an item: Press ► or ◀ (selected in the following order: D (day) → M (month) → Y (year) → hour → minute). Set the contents: Press ▲ or ▼. Date and time can also be set by rotating the multi selector. Finish setting: Choose minute and press the OK button or ►. 
Date format	<p>Choose the order in which the day, month, and year are displayed (Year/Month/Day, Month/Day/Year or Day/Month/Year).</p>
Time zone	<p>🏠 Home time zone can be specified and daylight saving can be enabled or disabled. When ➡ travel destination is registered, the time difference (🕒69) from the 🏠 home time zone is automatically calculated and the local date and time are recorded. Useful when traveling.</p>

Setting the Travel Destination Time Zone

1 Use the multi selector to choose **Time zone**, and press the **OK** button.

- The **Time zone** screen is displayed.

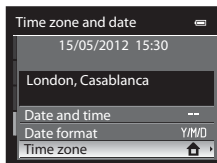

2 Choose **Travel destination** and press the **OK** button.

- The date and time displayed on the monitor change according to the region currently selected.

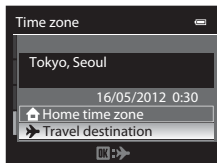

3 Press **▶**.

- The time zone selection screen is displayed.

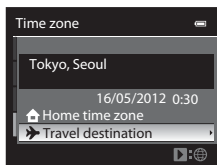

4 Press **◀** or **▶** to choose the travel destination (Time zone).

- The time difference between home and the travel destination is displayed.
- When using the camera in an area where daylight saving time is in effect, turn on the daylight saving setting with **▲**. When set to on, the **⌚** icon is displayed on the top of the monitor and the clock advances by one hour. To turn off, press **▼**.
- Press the **OK** button to register the travel destination time zone.
- While the travel destination time zone is selected, the **▶** icon is displayed on the monitor when the camera is in shooting mode.

Time difference

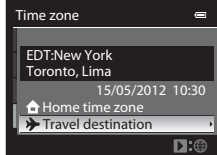
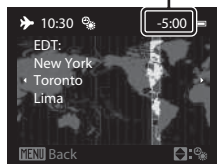

Home Time Zone

- To switch to the home time zone, choose **Home time zone** in step 2 and press the **OK** button.
- To change the home time zone, choose **Home time zone** in step 2 and perform the same procedure as for **Travel destination** to set the home time zone.

 **Time Zones**

The camera supports the time zones listed below.

For time differences not listed below, set the camera clock using **Time zone and date**.

UTC +/-	Location	UTC +/-	Location
-11	Midway, Samoa	+1	Madrid, Paris, Berlin
-10	Hawaii, Tahiti	+2	Athens, Helsinki, Ankara
-9	Alaska, Anchorage	+3	Moscow, Nairobi, Riyadh, Kuwait, Manama
-8	PST (PDT): Los Angeles, Seattle, Vancouver	+4	Abu Dhabi, Dubai
-7	MST (MDT): Denver, Phoenix	+5	Islamabad, Karachi
-6	CST (CDT): Chicago, Houston, Mexico City	+5.5	New Delhi
-5	EST (EDT): New York, Toronto, Lima	+6	Colombo, Dhaka
-4.5	Caracas	+7	Bangkok, Jakarta
-4	Manaus	+8	Beijing, Hong Kong, Singapore
-3	Buenos Aires, Sao Paulo	+9	Tokyo, Seoul
-2	Fernando de Noronha	+10	Sydney, Guam
-1	Azores	+11	New Caledonia
±0	London, Casablanca	+12	Auckland, Fiji

Monitor Settings



Press the MENU button → Y tab (11) → Monitor settings

Option	Description
Photo info	Select information displayed on the monitor during shooting and playback modes.
Image review	On (default setting): Picture is displayed on the monitor immediately after shooting and the monitor display returns to shooting screen. Off : Picture is not displayed immediately after shooting.
Brightness	Choose from five settings to select the monitor brightness. The default setting is 3 .

Photo info

Select whether or not the photo information is displayed on the monitor.

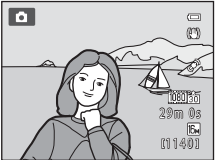
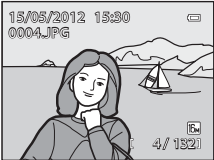
See “The Monitor” (6) for more information on indicators displayed on the monitor.

	Shooting mode	Playback mode
Show info		
Auto info (default setting)	The same information as in Show info is displayed. If no operations are performed after a few seconds, the display will be the same as Hide info . The information is displayed again when an operation is performed.	
Hide info		

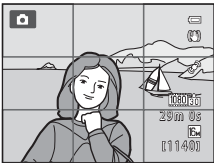
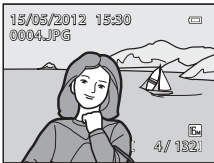
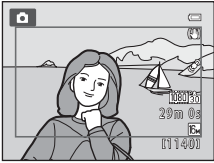
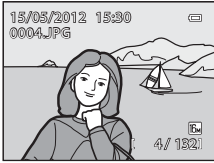
	Shooting mode	Playback mode
Framing grid+auto info	 <p>In addition to information shown with Auto info above, a framing grid is displayed to help frame pictures. It is not displayed while recording movies.</p>	 <p>The same information as in Auto info is displayed.</p>
Movie frame+auto info	 <p>In addition to information shown with Auto info above, the movie frame is displayed before recording movies.</p>	 <p>The same information as in Auto info is displayed.</p>

Print Date (Imprinting Date and Time on Pictures)

Press the **MENU** button → **Y** tab (📖11) → **Print date**

The shooting date and time can be imprinted on pictures at the time of shooting. This information can be printed even from printers that do not support printing of the date and time (🔍44).



Option	Description
DATE Date	The date is imprinted on pictures.
DATE Date and time	The date and time are imprinted on pictures.
OFF Off (default setting)	The date and time are not imprinted on pictures.

The icon for the current setting other than **Off** is displayed on the monitor (📖6).

✓ Notes on Print Date

- Imprinted dates cannot be deleted from the image, nor can dates be imprinted after the picture has been taken.
- Dates cannot be imprinted in the following situations.
 - When the scene mode (📖38) is set to **Night landscape** (with **Hand-held** selected), **Night portrait** (with **Hand-held** selected), **Easy panorama** or **3D photography**
 - When **Continuous** in continuous shooting mode (📖53) is set to **Pre-shooting cache**, **Continuous H: 120 fps** or **Continuous H: 60 fps**
 - During movie recording
- Dates imprinted with **Image mode** (📖71) setting of **VGA 640x480** may be difficult to read. Set the image mode to **2M 1600x1200** or higher.
- The date is recorded using the format selected in the setup menu's **Time zone and date** option (📖22, 🔍67).

📎 Print date and Print order

When printing from DPOF-compatible printers which support printing of shooting date and shooting information, the date and information can be printed on pictures without the date and time being imprinted on them with **Print date**, using options in the **Print order** menu (🔍43).

Vibration Reduction

Press the MENU button → Y tab (📖11) → Vibration reduction

Option	Description
 On (default setting)	Compensate camera shake that commonly occurs when shooting at the telephoto zoom position or slow shutter speed. Camera shake is also compensated when recording movies as well as when shooting still images.
OFF Off	Vibration Reduction is not enabled.

- When using a tripod to stabilize the camera, set vibration reduction to **Off**.
- When **On** is selected, an icon for this setting is displayed on the monitor (📖6).





✓ Notes on Vibration Reduction

- After the power is turned on or the camera enters shooting mode from playback mode, wait until the display stabilizes before shooting.
- Due to the characteristics of the vibration reduction function, images displayed on the monitor immediately after shooting may appear blurry.
- Vibration reduction may be unable to completely eliminate the effects of camera shake in some situations.
- When the 🌃 (Night landscape) or **Night portrait** scene mode is set to **Tripod**, vibration reduction is turned **Off**.

Motion Detection

Press the **MENU** button → **Y** tab (📖11) → Motion detection

Enable motion detection to reduce the effects of camera shake and subject movement when shooting still pictures.

Option	Description
 Auto (default setting)	<p>If the camera detects the movement of the subject or camera shake, the ISO sensitivity is raised and the shutter speed is increased to reduce their effects. However, motion detection does not function in the following situations.</p> <ul style="list-style-type: none"> • When the flash fires • When ISO sensitivity is set to other than Auto • When AF area mode is set to Subject tracking • In the following scene modes: <ul style="list-style-type: none"> -  (Night landscape) -  (Backlighting) - Sports - Night portrait - Dusk/dawn - Museum - Fireworks show - Easy panorama - Pet portrait - 3D photography • In  (continuous) shooting mode
OFF Off	Motion detection is not enabled.

When **Auto** is selected, an icon for this setting is displayed on the monitor (📖6). The motion detection icon lights in green when the camera detects any vibration and increases the shutter speed.

✓ Notes on Motion Detection

- Motion detection may be unable to completely reduce effects of camera shake and subject movement in some situations.
- Motion detection may not function if the subject exhibits significant movement or is too dark.
- The pictures taken may become grainy.

AF Assist

Press the MENU button → Y tab (📖11) → AF assist

Enable or disable the AF-assist illuminator that assists the autofocus when the lighting is dim.

Option	Description
Auto (default setting)	AF-assist illuminator lights automatically if the lighting is dim. The illuminator has a range of about 3.0 m (9 ft 10 in.) at the maximum wide-angle position and about 2.0 m (6 ft 6 in.) at the maximum telephoto position. <ul style="list-style-type: none"> For some focus areas and scene modes such as Museum (📖46), Pet portrait (📖48), AF-assist illuminator does not turn on even if Auto is set.
Off	AF-assist illuminator does not light. The camera may be unable to focus if lighting is dim.



Digital Zoom

Press the **MENU** button → **Y** tab (📖11) → Digital zoom

Enable or disable the digital zoom.

Option	Description
On (default setting)	When the camera is zoomed in to the maximum optical zoom position, rotating and holding the zoom control toward T (📖) triggers the digital zoom (📖27).
Off	The digital zoom is not activated.

✓ Notes on Digital Zoom

- When digital zoom is in effect, the camera focuses at the center of the frame.
- Digital zoom cannot be used with the following shooting modes.
 - When the scene mode is  (Scene auto selector), **Portrait**, **Night portrait**,  (Night landscape),  (Backlighting) with **HDR** set to **On**, **Easy panorama**, **Pet portrait**, or **3D photography**.
 - Smart portrait mode
- This feature may not be used in combination with certain features. See “Features That Cannot Be Used Simultaneously” (📖73) for more information.
- When the digital zoom is in effect, **Metering** automatically switches to **Center-weighted**, or to spot metering (where the center of the frame is metered).

Sound Settings

Press the **MENU** button → **Y** tab (📖11) → **Sound settings**

Adjust the following sound settings.

Option	Description
Button sound	Set the following all sound settings to On (default setting) or Off . <ul style="list-style-type: none"> • Setting beep (beep sounds once when the settings are completed) • Focus beep (beep sounds twice when the camera focuses on the subject) • Error beep (beep sounds three times when an error is detected) • Start-up sounds
Shutter sound	Choose whether to set the shutter sound to On (default setting) or Off .

✔ Notes on Sound Settings

- The button sound and shutter sound are disabled in **Pet portrait** scene mode.
- The shutter sound is disabled in continuous shooting mode.
- The shutter sound is disabled during movie recording.

Auto Off

Press the **MENU** button → **Y** tab (📖11) → **Auto off**

If no operations are performed for a certain period while the camera is on, the monitor is turned off to save power and the camera enters standby mode (📖21). This option sets the amount of time allowed to elapse before the camera enters standby mode.

Choose from **30 s**, **1 min** (default setting), **5 min** and **30 min**.

✎ Auto Off Setting

- In the following situations, the time taken for the camera to enter standby mode is fixed.
 - When menus are displayed: three minutes
 - During slide show playback: maximum of 30 minutes
 - When the AC Adapter EH-62F is connected: 30 minutes
- The camera does not enter standby mode when transferring images using the Eye-Fi card.

Format Memory/Format Card

Press the MENU button →  tab (📖11) → Format memory/Format card

Format the internal memory or a memory card.

Formatting permanently deletes all data in the internal memory or memory card. The deleted data cannot be recovered. Be sure to transfer important pictures to a computer before formatting.

Formatting the Internal Memory

To format the internal memory, remove the memory card from the camera. The **Format memory** option is displayed on the setup menu.

Formatting Memory Cards

When a memory card is inserted in the camera, the memory card can be formatted. The **Format card** option is displayed on the setup menu.

Formatting Internal Memory and Memory Card

- Do not turn off the camera or open the battery-chamber/memory card slot cover during formatting.
- The first time you insert a memory card that has been used in another device into this camera, be sure to format it with this camera.
- When formatting the camera's internal memory or the memory card, album icons (📷12) are reset to their default icons (number icon).

Language

Press the MENU button →  tab (📖11) → Language

Choose one of 29 languages for displaying the camera menus and messages.

Čeština	Czech	Magyar	Hungarian	Tiếng Việt	Vietnamese
Dansk	Danish	Nederlands	Dutch	Türkçe	Turkish
Deutsch	German	Norsk	Norwegian	Українська	Ukrainian
English	(default setting)	Polski	Polish	عربي	Arabic
Español	Spanish	Português (BR)	Brazilian Portuguese	简体中文	Simplified Chinese
Ελληνικά	Greek	Português (PT)	Portuguese	繁體中文	Traditional Chinese
Français	French	Русский	Russian	日本語	Japanese
Indonesia	Indonesian	Română	Romanian	한글	Korean
Italiano	Italian	Suomi	Finnish	ภาษาไทย	Thai
		Svenska	Swedish	हिन्दी	Hindi

TV Settings

Press the **MENU** button → **Y** tab (📖11) → TV settings

Adjust the settings for connecting to a TV.

Option	Description
Video mode	Select the analog video output system from NTSC or PAL in accordance with your TV.
HDMI	Select a picture resolution for HDMI output from Auto (default setting), 480p , 720p , or 1080i . When Auto is set, the output resolution that is best suited to the connected TV is selected automatically from 480p , 720p or 1080i .
HDMI device control	Select whether or not the camera receives signals from a TV when a TV that conforms to the HDMI-CEC standard is connected with an HDMI cable. When set to On (default setting), the television remote control can be used to operate the camera during playback. See "Using the TV's Remote Control (HDMI Device Control)" (🔍24) for more information.
HDMI 3D output	Set the method used to output 3D pictures to HDMI devices. Select On (default setting) to three-dimensionally play back 3D pictures taken with this camera on a TV or monitor that is connected via HDMI.

HDMI and HDMI-CEC

"HDMI" is an abbreviation of High-Definition Multimedia Interface, which is one type of multimedia interface.

"HDMI-CEC" is an abbreviation of HDMI-Consumer Electronics Control, which enables operations to be linked between compatible devices.

Charge by Computer

Press the MENU button → Y tab (📖11) → Charge by computer

Select whether or not the battery inserted into the camera is charged when the camera is connected to a computer via the USB cable (📖82).

Option	Description
Auto (default setting)	When the camera is connected to a computer that is running, the battery inserted into the camera is automatically charged using power supplied by the computer.
Off	The battery inserted into the camera is not charged when the camera is connected to a computer.

✔ Notes on Connecting the Camera to a Printer

- The battery cannot be charged with connection to a printer, even if the printer complies with the PictBridge standard.
- When **Auto** is selected for **Charge by computer**, it may be impossible to print images with direct connection of the camera to some printers. If the PictBridge startup screen is not displayed on the monitor after the camera is connected to a printer and turned on, turn the camera off and disconnect the USB cable. Set **Charge by computer** to **Off** and reconnect the camera to the printer.

✔ Notes on Charging with Connection to a Computer

- The battery cannot be charged, nor can data be transferred, when the camera is connected to a computer before the camera's display language and date and time have been set (📖22). If the camera's clock battery (📖23) has been exhausted, the date and time must be reset before the battery can be charged or images can be transferred with connection to a computer. In this case, use the Charging AC Adapter EH-69P (📖16) to charge the battery and then set the camera's date and time.
- If the camera is turned off, charging will also stop.
- If the computer enters sleep mode while charging, charging will stop and the camera may be turned off.
- When disconnecting the camera from the computer, turn the camera off and then disconnect the USB cable.
- It may take longer to charge the battery with connection to a computer than with charging using the Charging AC Adapter EH-69P. Charging time increases when images are transferred while the battery is charging.
- When the camera is connected to a computer, an application installed on the computer, such as Nikon Transfer 2, may start. If the camera was connected to the computer for the sole purpose of charging the battery, exit the application.
- The camera turns off automatically if there is no communication with the computer for 30 minutes after the battery has finished charging.
- Depending upon computer specifications, settings, and power supply and allocation, it may be impossible to charge the battery using a computer connection while it is inserted into the camera.

The Charge Lamp

The following chart explains charge lamp status when the camera is connected to a computer.

Option	Description
Flashes slowly (green)	Battery charging.
Off	Battery not charging. If the charge lamp changes from slow flashing (green) to off while the power-on lamp is lit, charging is complete.
Flashes quickly (green)	<ul style="list-style-type: none"> • The ambient temperature is not suited to charging. Charge the battery indoors with an ambient temperature of 5°C to 35°C (41°F to 95°F). • The USB cable is not connected correctly, or the battery is faulty. Make sure the USB cable is connected correctly and replace the battery if necessary. • The computer is in sleep mode and is not supplying power. Wake up the computer. • The battery cannot be charged because the computer cannot supply power to the camera, due to the computer's settings or its specifications.

Blink Warning

Press the MENU button → Y tab (11) → Blink warning

Choose whether or not blinking eyes are detected when using face detection (75) in the following shooting modes.

- (Auto) mode (when **Face priority** (37) is selected for **AF area mode**)
- In the following scene modes:
 - **Scene** (Scene auto selector) (39)
 - **Portrait** (42)
 - **Night portrait** (when **Tripod** is selected) (43)

Option	Description
On	The Did someone blink? screen is displayed on the monitor if the camera detects that a human subject may have closed the eyes immediately after taking a picture using face detection. The face of the human subject that may have closed his/her eyes is framed by a yellow border. You can check the picture taken and determine if you need to take the picture again.
Off (default setting)	The camera does not detect blinks.

The Did someone blink? Screen

- To zoom in the face for which blinking was detected, rotate the zoom control toward **T** (Q). To return to full-frame playback mode, rotate the zoom control toward **W** (R).
- When the camera detects that one or more human subjects have closed their eyes, press ◀ or ▶ during playback zoom to display other faces.
- Press the **Trash** button to delete the picture taken.
- Press the **OK** button or the shutter-release button to return to shooting screen.
- If no operations are performed for a few seconds, the screen automatically returns to the shooting screen.



Eye-Fi Upload

Press the MENU button → Y tab (11) → Eye-Fi upload





Option	Description
Enable	Upload images created by the camera to a preselected destination.
Disable (default setting)	Images will not be uploaded.

✓ Notes on Eye-Fi Cards

- Note that images will not be uploaded if signal strength is insufficient even if **Enable** is selected.
- Select **Disable** where wireless devices are prohibited.
- Refer to the instruction manual of your Eye-Fi card for more information. In the event of malfunction, contact the card manufacturer.
- The camera can be used to turn Eye-Fi cards on and off, but may not support other Eye-Fi functions.
- The camera is not compatible with the endless memory function. When it is set on a computer, disable the function. If the endless memory function is enabled, the number of pictures taken may not be displayed correctly.
- Eye-Fi cards are for use only in the country of purchase. Observe all local laws concerning wireless devices.
- Leaving the setting as **Enable** will result in the battery being depleted in a shorter period of time.

✍ Eye-Fi Communication Indicator

The communication status of the Eye-Fi card in the camera can be confirmed on the monitor (6).

- : **Eye-Fi upload** is set to **Disable**.
-  (lights): Eye-Fi upload enabled; waiting to begin upload.
-  (flashes): Eye-Fi upload enabled; uploading data.
- : Eye-Fi upload enabled but no images available for upload.
- : An error occurred. The camera cannot control the Eye-Fi card.

✍ Supported Eye-Fi Cards

As of November 2011, the following Eye-Fi cards can be used. Be sure that Eye-Fi card firmware has been updated to the latest version.

- Eye-Fi Connect X2 SDHC 4GB
- Eye-Fi Mobile X2 SDHC 8GB
- Eye-Fi Pro X2 SDHC 8GB

Filmstrip

Press the **MENU** button → **Y** tab (📖11) → **Filmstrip**

Allows you to select whether or not filmstrips are displayed when you rotate the multi selector quickly in full-frame playback mode (📖30).

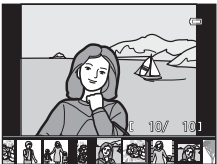
Option	Description
On	<p>Image thumbnails are displayed at the bottom of the monitor when you rotate the multi selector quickly while viewing an image in full-frame playback mode. You can view thumbnails of previous and subsequent images, and select an image. While the filmstrip is displayed, you can hide it by pressing the OK button.</p> 
Off (default setting)	Disables the filmstrip.

✔ Note on Filmstrip Display

- In order to display the filmstrip, at least ten images must be saved in the camera's internal memory or on the memory card.
- For favorite pictures, auto sort, or list by date playback mode, the selected album, category, or shooting date must have at least ten images.

Reset All

Press the **MENU** button → **Y** tab (📖11) → **Reset all**

When **Reset** is selected, the camera settings are restored to the default values.

Basic Shooting Functions

Option	Default value
Flash mode (📖60)	Auto
Self-timer (📖63)	OFF
Macro mode (📖64)	OFF
Creative slider adjustment (📖65)	OFF
Exposure compensation (📖68)	0.0

Shooting Menu/Continuous Shooting Menu

Option	Default value
Image mode (📖71)	📷 4608×3456
White balance (🔧33)	Auto
Metering (🔧35)	Matrix
Continuous (📖55)	Continuous H
ISO sensitivity (🔧36)	Auto
AF area mode (🔧37)	Face priority
Autofocus mode (🔧40)	Single AF

Scene Mode

Option	Default value
Scene menu (📖38)	Portrait
Night portrait (📖43)	Tripod
Hue adjustment in Food mode (📖45)	Center
Easy panorama (📖47)	Normal (180°)
Pet portrait (📖48)	Pet portrait auto release: ON Continuous: Continuous

Night landscape Menu

Option	Default value
Night landscape (📖40)	Hand-held

Backlighting Menu

Option	Default value
HDR (📖41)	Off

Smart Portrait Menu

Option	Default value
Skin softening (🔧41)	Normal
Smile timer (🔧41)	On
Blink proof (🔧42)	Off

Special Effects Menu

Option	Default value
Special effects (📖57)	Soft

Movie Menu

Option	Default value
Movie options (🎥53)	 HD 1080p★ (1920x1080)
Open with HS footage (🎥54)	On
Autofocus mode (🎥57)	Single AF
Wind noise reduction (🎥57)	Off

GPS Options Menu (COOLPIX S9300 only)

Option	Default value
Record GPS data (📍58)	Off
Embed POI (📍60)	Off
Display POI (📍60)	Off
Level of detail (📍60)	Level 6 (detailed)
Log recording duration (📍61)	Log data for next 24 hours
Compass display (📍64)	Off

Setup Menu

Option	Default value
Welcome screen (🔧66)	None
Photo info (🔧70)	Auto info
Image review (🔧70)	On
Brightness (🔧70)	3
Print date (🔧72)	Off
Vibration reduction (🔧73)	On
Motion detection (🔧74)	Auto
AF assist (🔧75)	Auto
Digital zoom (🔧76)	On
Button sound (🔧77)	On
Shutter sound (🔧77)	On
Auto off (🔧77)	1 min
HDMI (🔧79)	Auto
HDMI device control (🔧79)	On

Option	Default value
HDMI 3D output (Fn79)	On
Charge by computer (Fn80)	Auto
Blink warning (Fn82)	Off
Eye-Fi upload (Fn83)	Disable
Filmstrip (Fn84)	Off

Others

Option	Default value
Paper size (Fn27, Fn28)	Default
Frame intvl for Slide show (Fn46)	3 s
Sequence Display Options (Fn52)	Key picture only

- Choosing **Reset all** also clears the current file number (Fn89) in the memory. After resetting, numbering continues from the lowest number available in the internal memory or the memory card. If **Reset all** is performed after all pictures are deleted from the internal memory or memory card (Bk32), the file numbers for the next pictures taken start from **0001**.
- The following settings remain unaffected even if **Reset all** is performed.
 - Shooting menu: Preset manual data for **White balance** (Fn34)
 - Playback menu: Favorite pictures content (Fn9), and Choose key picture (Fn52)
 - Setup menu: **Time zone and date** (Fn67), **Language** (Fn78) and **Video mode** (Fn79) in **TV settings**

Firmware Version

Press the MENU button (📖11) → 🗑️ tab → Firmware version

Displays the current camera firmware version.

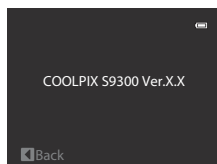

File and Folder Names

Pictures, movies and voice memos are assigned file names as follows.

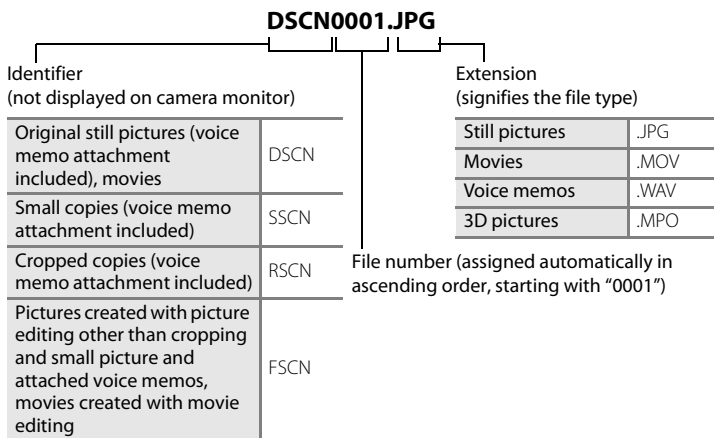

- A folder for storing files is automatically created using the following naming convention: "Folder number + NIKON" (e.g., "100NIKON"). If there are 200 files in a folder, a new folder is created. (For example, the folder name following "100NIKON" becomes "101NIKON.") A new folder is also created when the file numbers in a folder reach 9999. The next file number is set automatically to "0001."
- Voice memo file names have the same identifier and file number as the picture to which the voice memo is attached.
- When image files or voice files are copied to or from the internal memory or memory card (851), the file naming conventions are as follows:
 - Selected images:
Files copied using selected images are copied to the current folder (or to the folder used for subsequent pictures), where they are assigned file numbers in ascending order following the largest file number in memory.
 - All images:
Files copied using all images, along with their folder, are copied together. Folder numbers are assigned in ascending order, following the largest folder number on the destination medium.
File names are not changed.

File and Folder Names

- When the current folder is numbered 999, if there are 200 files in the folder or if a file is numbered 9999, no further pictures can be shot until the internal memory or memory card is formatted (🔑78), or a new memory card is inserted.

Optional Accessories

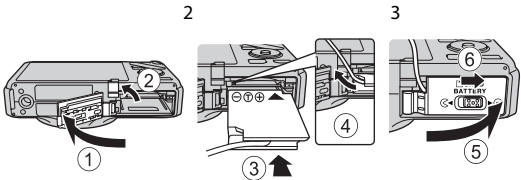
Rechargeable battery	Rechargeable Li-ion Battery EN-EL12 ¹
Charging AC adapter	Charging AC Adapter EH-69P ^{1, 2}
Battery charger	Battery Charger MH-65 (Charging time when the battery is completely used up: Approx. 2 hours 30 minutes)
AC adapter	<p>AC Adapter EH-62F (connect as shown)</p>  <p>Properly align the power connector cord in the power connector groove, and then insert the AC adapter. Before closing the battery-chamber/memory card slot cover, properly align the power connector cord in the battery chamber groove. If part of the cord runs out of the grooves, the cover or cord may be damaged when the cover is closed.</p>
USB cable	USB Cable UC-E6 ¹
Audio/video cable	Audio Video Cable EG-CP16 ¹





¹ Included with the camera at the time of purchase. (See “Confirming the Package Contents” (📖ii) for more information.)







² When using in other countries, use a commercially available plug adapter as necessary. For more information about plug adapters, consult your travel agency.

See our websites or product catalogs for up-to-date information on accessories for the COOLPIX S9300/S9200.









Error Messages







The following table lists the error messages and other warnings displayed on the monitor, as well as the solutions for dealing with them.

Display	Cause/Solution	
 (flashes)	Clock not set. Set date and time.	 67
Battery exhausted.	Battery exhausted. Charge or replace the battery.	14, 16
Battery temperature high	Battery temperature is high. Turn off camera, and allow battery to cool down before resuming use. Five seconds after this message appears, the monitor is turned off, and the power-on lamp and the flash lamp flash quickly. After the lamps flash for three minutes, the camera turns off automatically, but you can also press the power switch to turn it off manually.	21
The camera will turn off to prevent overheating.	Inside of the camera has become hot. The camera turns off automatically. Leave the camera off until the inside of the camera has cooled and then turn it on again.	–
 (flashes red)	Camera cannot focus. <ul style="list-style-type: none"> • Refocus. • Use focus lock. 	28 76
Please wait for the camera to finish recording.	Camera cannot perform other operations until recording is complete. Wait until message clears from display automatically when recording is complete.	–
Memory card is write protected.	Write-protect switch of the memory card is in “lock” position. Slide the write-protect switch to “write” position.	–
Not available if Eye-Fi card is locked.	Write-protect switch of Eye-Fi card is in “lock” position. Slide the write-protect switch to “write” position. Error accessing Eye-Fi card. <ul style="list-style-type: none"> • Use an approved card. • Check that the terminal is clean. • Confirm that memory card is correctly inserted. 	19 18 18
This card cannot be used.	Error accessing memory card. <ul style="list-style-type: none"> • Use an approved card. 	19
This card cannot be read.	<ul style="list-style-type: none"> • Check that the terminal is clean. • Confirm that memory card is correctly inserted. 	18 18







Display	Cause/Solution	
Card is not formatted. Format card? Yes No	Memory card has not been formatted for use in this camera. All data stored on the memory card is deleted when formatted. If there is any data on the card that you want to keep, select No , and backup the data to a computer before formatting the memory card. To format the memory card, select Yes and press the  button.	18
Out of memory.	Memory card is full. <ul style="list-style-type: none"> • Change the image mode. • Delete pictures and movies. • Replace memory card. • Remove memory card and use internal memory. 	71 32, 92 18 19
Image cannot be saved.	Error occurred while recording picture. Format the internal memory or memory card.	18
	Camera has run out of file numbers. Replace the memory card, or format the internal memory/ memory card.	18
	Picture cannot be used for welcome screen.	 66
	There is insufficient space to save a copy. Delete pictures from destination.	32
Album is full. No further pictures can be added.	Two hundred pictures have already been added to the album. <ul style="list-style-type: none"> • Remove pictures from the album • Add the picture to another album 	 9
A blink was detected in the picture just taken.	Someone may have had their eyes closed when the picture was taken. Check the picture in playback mode.	51,  42
Unable to create panorama.	Cannot perform easy panorama shooting. Easy panorama shooting may not be available in the following situations. <ul style="list-style-type: none"> • When shooting has not finished after a certain period of time • When the camera movement speed is too fast • When the camera is not straight relative to the panorama direction 	 2
Unable to create panorama. Pan the camera in one direction only.		
Unable to create panorama. Pan the camera more slowly.		
Shooting failed	Failed to shoot the first image for 3D photography. <ul style="list-style-type: none"> • Try shooting again. • In some shooting conditions, such as when the subject is moving, dark or low in contrast, the picture may not be taken. 	 5

Error Messages

Display	Cause/Solution	
Failed to take second shot	When taking 3D pictures, the second shot could not be successfully taken after the first shot. <ul style="list-style-type: none"> Try shooting again. After taking the first shot, move the camera horizontally and frame the subject so that it is aligned with the guide. In some shooting conditions, such as when the subject moves or the subject is dark or low in contrast, the second shot may not be taken. 	 5 –
Failed to save 3D image	Failed to save the 3D pictures. <ul style="list-style-type: none"> Try shooting again. Delete unnecessary pictures. Depending on the subject or the shooting conditions, such as when the subject moves or the subject is dark or low in contrast, 3D pictures may not be created, resulting in failure to save them. 	 5 32 –
Sound file cannot be saved.	A voice memo cannot be attached to this file. <ul style="list-style-type: none"> Voice memos cannot be attached to movies. Select a picture taken with this camera. 	–  50
Image cannot be modified.	Cannot edit selected picture. <ul style="list-style-type: none"> Confirm the conditions that are required for editing. These options cannot be used with movies. 	 16 –
Cannot record movie.	Time out error while recording movie. Choose memory card with faster write speed.	19
Memory contains no images.	No pictures in the internal memory or memory card. <ul style="list-style-type: none"> To view the pictures stored in the internal memory, remove the memory card. To copy pictures from internal memory to a memory card, press the MENU button and select Copy from the playback menu. 	18  51
File contains no image data.	File not created with COOLPIX S9300/S9200. File cannot be viewed on this camera.	–
This file cannot be played back.	View file using the computer or any other devices which was used to create or edit this file.	–
All images are hidden.	No images available for a slide show.	–
This image cannot be deleted.	Picture is protected. Disable protection.	 47
Travel destination is in the current time zone.	Destination in same time zone as home.	 69
Mode dial is not in the proper position.	Mode dial is between two modes. Rotate the mode dial to select the desired mode.	24
Could not obtain GPS data.	COOLPIX S9300 only The camera clock is not set correctly. Change the location or time and determine the location again.	–

Display	Cause/Solution	
No A-GPS file found on card	COOLPIX S9300 only An A-GPS file that can be updated is not found in the memory card. Check the following items. <ul style="list-style-type: none"> • Whether the memory card is inserted • Whether the A-GPS file is stored in the memory card • Whether the A-GPS file saved in a memory card is more recent than the A-GPS file saved in the camera • Whether the A-GPS file is still valid 	–
Update failed	COOLPIX S9300 only Unable to update A-GPS file. The A-GPS file may be corrupted. Download the file from the website once more.	 59
Cannot save to card	A memory card is not inserted. Insert a memory card.	18
	COOLPIX S9300 only 100 log data events have already been saved or 36 log data events have been saved for one day. Delete log data that is no longer required from a memory card or replace the memory card with a new one.	 62
Unable to correct compass	COOLPIX S9300 only Unable to correct the electronic compass correctly. Swing the camera to draw a figure eight in the air outdoors while turning your wrist to face the camera forward and backward, side to side, or up and down.	 64
Flash is not fully raised.	Flash is being held down by a finger or another object. Do not hold down the flash.	60
Lens error	Lens is not operating properly. Turn camera off and then on again. If error persists, contact retailer or Nikon-authorized service representative.	21
Communications error	Error occurred during communication with printer. Turn off camera and reconnect the USB cable.	 26
System error	Error has occurred in camera's internal circuitry. Turn off camera, remove and reinsert battery, and turn on camera. If the error persists, contact retailer or Nikon-authorized service representative.	21
Printer error: check printer status.	Printer error Check printer. After solving the problem, select Resume and press the  button to resume printing.*	–
Printer error: check paper	Specified size of paper is not loaded. Load the specified size of paper, select Resume and press the  button to resume printing.*	–

Error Messages

Display	Cause/Solution	
Printer error: paper jam	Paper has jammed in the printer. Remove the jammed paper, select Resume and press the  button to resume printing.*	–
Printer error: out of paper	No paper is loaded in the printer. Load the specified size of paper, select Resume and press the  button to resume printing.*	–
Printer error: check ink	Ink error Check ink, select Resume and press the  button to resume printing.*	–
Printer error: out of ink	Ink cartridge is empty. Replace ink cartridge, select Resume and press the  button to resume printing.	–
Printer error: file corrupt	An error caused by the image file has occurred. Select Cancel and press the  button to cancel printing.	–

* See the instruction manual provided with your printer for further guidance and information.



Technical Notes and Index

Caring for the Products	2
The Camera.....	2
The Battery.....	3
Charging AC Adapter	4
The Memory Cards.....	5
Caring for the Camera	6
Cleaning.....	6
Storage.....	6
USER LICENSE AGREEMENT FOR LOCATION NAME	
DATA (COOLPIX S9300 only)	7
Troubleshooting	11
Specifications.....	19
Supported Standards.....	22
Index.....	23

Caring for the Products

The Camera

To ensure continued enjoyment of this Nikon product, observe the following precautions when using or storing the device.

Be sure to read and follow the warnings of “For Your Safety” (📖vi to 📖viii) thoroughly before using the products.

✔ **Keep Dry**

The device will be damaged if immersed in water or subjected to high humidity.

✔ **Do Not Drop**

The product may malfunction if subjected to strong shock or vibration.

✔ **Handle the Lens and All Moving Parts with Care**

Do not apply force to the lens, lens cover, monitor, memory card slot, or battery chamber. These parts are easily damaged. Applying force to the lens cover could result in camera malfunction or damage to the lens. Should the monitor break, care should be taken to avoid injury caused by broken glass and to prevent the liquid crystal from the display touching the skin or entering the eyes or mouth.

✔ **Do Not Point the Lens at Strong Light Sources for Extended Periods**

Avoid pointing the lens at the sun or other strong light sources for extended periods when using or storing the camera. Intense light may cause deterioration of the image sensor, producing a white blur effect in photographs.

✔ **Keep away from Strong Magnetic Fields**

Do not use or store this device in the vicinity of equipment that generates strong electromagnetic radiation or magnetic fields. Strong static charge or the magnetic fields produced by equipment such as radio transmitters could interfere with the monitor, damage data saved on the memory card, or affect the product's internal circuitry.

✔ **Avoid Sudden Changes in Temperature**

Sudden changes in temperature, such as when entering or leaving a heated building on a cold day, can cause condensation to form inside the device. To prevent condensation, place the device in a carrying case or a plastic bag before exposing it to sudden changes in temperature.



✔ **Turn the Product off Before Removing or Disconnecting the Power Source or the Memory Card**

Do not remove the battery while the product is on, or while images are being saved or deleted. Forcibly cutting power in these circumstances could result in loss of data or in damage to product memory or internal circuitry.

Notes on the Monitor

- Monitors and electronic viewfinders are constructed with extremely high precision; at least 99.99% of pixels are effective, with no more than 0.01% being missing or defective. Hence while these displays may contain pixels that are always lit (white, red, blue, or green) or always off (black), this is not a malfunction and has no effect on images recorded with the device.
- Images on the monitor may be difficult to see under bright lighting.
- The monitor is lit by an LED backlight. Should the monitor begin to dim or flicker, contact your Nikon-authorized service representative.

The Battery

- Be sure to read and follow the warnings of “For Your Safety” (vi to viii) thoroughly before using the battery.
- Check the battery level before using the camera and replace or charge the battery if necessary. Do not continue charging once the battery is fully charged as this will result in reduced battery performance. Whenever possible, carry a fully charged spare battery when taking pictures on important occasions.
- Do not use the battery at ambient temperatures below 0°C (32°F) or above 40°C (104°F).
- Charge the battery indoors with an ambient temperature of 5°C to 35°C (41°F to 95°F) before use.
- When the battery temperature is between 45°C and 60°C (113°F and 140°F), the chargeable capacity may decrease.
- The battery is not charged at ambient temperatures below 0°C (32°F) or above 60°C (140°F).
- Note that the battery may become hot during use; wait for the battery to cool before charging. Failure to observe these precautions could damage the battery, impair its performance, or prevent it from charging normally.
- On cold days, the capacity of batteries tends to decrease. Be sure that the battery is fully charged before heading outside to take pictures in cold weather. Keep spare batteries in a warm place and exchange as necessary. Once warmed, a cold battery may recover some of its charge.
- Dirt on the battery terminals can prevent the camera from functioning. Should the battery terminals become dirty, wipe them off with a clean, dry cloth before use.

Caring for the Products

- If the battery will not be used for some time, insert it in the camera and run it flat before removing it for storage. The battery should be stored in a cool location with an ambient temperature of 15°C to 25°C (59°F to 77°F). Do not store the battery in hot or extremely cold locations.
- Always remove the battery from the camera or battery charger when it is not being used. When inserted, minute amounts of current are drawn from the battery even when not in use. This may result in excessive draining of the battery and complete loss of function. Turning the camera on or off while the battery is exhausted can result in reduced battery life. When the battery level is low, be sure to charge the battery before using it.
- Recharge the battery at least once every six months and completely exhaust it before returning it to storage.
- After removing the battery from the camera or battery charger, attach the included terminal cover to the battery and store it in a cool place.
- A marked drop in the time a fully-charged battery retains its charge, when used at room temperature, indicates that the battery needs to be replaced. Purchase a new EN-EL12 battery.
- Replace the battery when it no longer holds a charge. Used batteries are a valuable resource. Please recycle used batteries in accordance with local regulations.

Charging AC Adapter

- Be sure to read and follow the warnings of "For Your Safety" (📖vi to 📖viii) thoroughly before using the Charging AC Adapter.
- The Charging AC Adapter EH-69P is for use only with compatible devices. Do not use with another make or model of device.
- The EH-69P is compatible with AC 100-240 V, 50/60 Hz electrical outlets. When using in other countries, use a plug adapter (commercially available) as necessary. For more information about plug adapters, consult your travel agency.
- Do not, under any circumstances, use another make or model of AC adapter other than Charging AC Adapter EH-69P or USB-AC adapter. Failure to observe this precaution could result in overheating or in damage to the camera.

The Memory Cards

- Use only Secure Digital memory cards. See “Approved Memory Cards” (📖19).
- Be sure to observe the precautions in the memory card documentation when you use the memory card.
- Do not affix labels or stickers to the memory card.
- Do not format the memory card using a computer.
- When a memory card that has been used in another device is used for the first time, be sure to format it with this camera.
When a new memory card is used, it is recommended to format it with this camera first.
- Formatting permanently deletes all data in the memory card. Be sure to transfer important pictures to a computer before formatting.
- If the error message “Card is not formatted. Format card?” is displayed when you insert a memory card into this camera, the memory card must be formatted. If the memory card contains images you wish to keep, select **No** and save those images on your computer before formatting the memory card. To format the card, select **Yes** and press the **OK** button.
- Do not perform the following during formatting, while data is being written to or deleted from the memory card, or during data transfer to a computer. Failure to observe this precaution could result in loss of data or damage to the memory card:
 - Open the battery-chamber/memory card slot cover to remove the battery or memory card.
 - Turn off the camera
 - Disconnect the AC adapter

Caring for the Camera

Cleaning

Lens	Avoid touching glass parts with your fingers. Remove dust or lint with a blower (typically a small device with a rubber bulb attached to one end that is pumped to produce a stream of air out the other end). To remove fingerprints, oily substances, or other stains that cannot be removed with a blower, carefully wipe the lens with a dry soft cloth or eyewear cleaning cloth, using a spiral motion that starts at the center of the lens and working toward the edges. Do not wipe the lens forcibly or with a hard material. Failure to observe this precaution could result in damage or trouble. If this fails, clean the lens using a cloth lightly dampened with commercial lens cleaner.
Monitor	Remove dust or lint with a blower. To remove fingerprints, oily substances or other stains, carefully wipe the monitor with a dry soft cloth or eyewear cleaning cloth. Do not wipe the monitor forcibly or with a hard material. Failure to observe this precaution could result in damage or trouble.
Body	Use a blower to remove dust, dirt, or sand, then wipe gently with a soft, dry cloth. After using the camera at the beach or other sandy or dusty environment, wipe off any sand, dust, or salt with a dry cloth lightly dampened with fresh water and dry thoroughly. Note that foreign matter inside the camera could cause damage not covered by the warranty.

Do not use volatile organic solvents such as alcohol or thinner, chemical detergents, anticorrosive agents, or anti-fogging agents.

Storage

Remove the battery if the camera will not be used for an extended period. Do not store the camera with naphtha or camphor moth balls, or in any of the following locations:

- Next to equipment that produces strong electromagnetic fields, such as televisions or radios
- Exposed to temperatures below -10°C (14°F) or above 50°C (122°F)
- Places that are poorly ventilated or subject to humidity of over 60%

To prevent mold or mildew, take the camera out of storage at least once a month. Turn the camera on and release the shutter a few times before putting the camera away again.

Be sure to read and follow the warnings given in "The Battery" (🔋:3) of "Caring for the Products" to store the battery.

USER LICENSE AGREEMENT FOR LOCATION NAME DATA (COOLPIX S9300 only)

The location name data that is stored in this digital camera ("Data") is provided for your personal, internal use only and not for resale. It is protected by copyright, and is subject to the following terms and conditions which are agreed to by you, on the one hand, and Nikon Corporation ("Nikon") and its licensors (including their licensors and suppliers) on the other hand.

Terms and Conditions

Personal Use Only. You agree to use this Data together with this digital camera and the image data taken by the digital camera for the solely personal, non-commercial purposes for which you were licensed, and not for service bureau, time-sharing or other similar purposes.

Accordingly, but subject to the restrictions set forth in the following paragraphs, you agree not to otherwise reproduce, copy, modify, decompile, disassemble or reverse engineer any portion of this Data, and may not transfer or distribute it in any form, for any purpose, except to the extent permitted by mandatory laws.

Restrictions. Except where you have been specifically licensed to do so by Nikon, and without limiting the preceding paragraph, you may not (a) use this Data with any products, systems, or applications installed or otherwise connected to or in communication with vehicles, capable of vehicle navigation, positioning, dispatch, real time route guidance, fleet management or similar applications; or (b) with or in communication with any positioning devices or any mobile or wireless-connected electronic or computer devices, including without limitation cellular phones, palmtop and handheld computers, pagers, and personal digital assistants or PDAs.

Warning. The Data may contain inaccurate or incomplete information due to the passage of time, changing circumstances, sources used and the nature of collecting comprehensive geographic data, any of which may lead to incorrect results.

No Warranty. This Data is provided to you "as is," and you agree to use it at your own risk. Nikon and its licensors (and their licensors and suppliers) make no guarantees, representations

or warranties of any kind, express or implied, arising by law or otherwise, including but not limited to, content, quality, accuracy, completeness, effectiveness, reliability, fitness for a particular purpose, usefulness, use or results to be obtained from this Data, or that the Data or server will be uninterrupted or errorfree.

Disclaimer of Warranty: NIKON AND ITS LICENSORS (INCLUDING THEIR LICENSORS AND SUPPLIERS) DISCLAIM ANY WARRANTIES, EXPRESS OR IMPLIED, OF QUALITY, PERFORMANCE, MERCHANTABILITY, FITNESS FOR A PARTICULAR PURPOSE OR NONINFRINGEMENT.

Some States, Territories and Countries do not allow certain warranty exclusions, so to that extent the above exclusion may not apply to you.

Disclaimer of Liability: NIKON AND ITS LICENSORS (INCLUDING THEIR LICENSORS AND SUPPLIERS) SHALL NOT BE LIABLE TO YOU: IN RESPECT OF ANY CLAIM, DEMAND OR ACTION, IRRESPECTIVE OF THE NATURE OF THE CAUSE OF THE CLAIM, DEMAND OR ACTION ALLEGING ANY LOSS, INJURY OR DAMAGES, DIRECT OR INDIRECT, WHICH MAY RESULT FROM THE USE OR POSSESSION OF THE INFORMATION; OR FOR ANY LOSS OF PROFIT, REVENUE, CONTRACTS OR SAVINGS, OR ANY OTHER DIRECT, INDIRECT, INCIDENTAL, SPECIAL OR CONSEQUENTIAL DAMAGES ARISING OUT OF YOUR USE OF OR INABILITY TO USE THIS INFORMATION, ANY DEFECT IN THE INFORMATION, OR THE BREACH OF THESE TERMS OR CONDITIONS, WHETHER IN AN ACTION IN CONTRACT OR TORT OR BASED ON A WARRANTY, EVEN IF NIKON OR ITS LICENSORS HAVE BEEN ADVISED OF THE POSSIBILITY OF SUCH DAMAGES. Some States, Territories and Countries do not allow certain liability exclusions or damages limitations, so to that extent the above may not apply to you.

USER LICENSE AGREEMENT FOR LOCATION NAME DATA (COOLPIX S9300 only)

Export Control. You agree not to export from anywhere any part of the Data or any direct product thereof except in compliance with, and with all licenses and approvals required under, applicable export laws, rules and regulations, including but not limited to the laws, rules and regulations administered by the Office of Foreign Assets Control of the U.S. Department of Commerce and the Bureau of Industry and Security of the U.S. Department of Commerce.

To the extent that any such export laws, rules or regulations prohibit Nikon and its licensors from complying with any of its obligations hereunder to deliver or distribute Data, such failure shall be excused and shall not constitute a breach of this Agreement.

Entire Agreement. These terms and conditions constitute the entire agreement between Nikon (and its licensors, including their licensors and suppliers) and you pertaining to the subject matter hereof, and supersedes in their entirety any and all written or oral agreements previously existing between us with respect to such subject matter.

Governing Law. The above terms and conditions shall be governed by the laws of Japan, without giving effect to (i) its conflict of laws provisions, or (ii) the United Nations Convention for Contracts for the International Sale of Goods, which is explicitly excluded; provided that in the event that the laws of Japan is not deemed applicable to this Agreement for any reason in the country where you obtained the Data, this Agreement shall be governed with the laws of the country where you obtained the Data. You agree to submit to the jurisdiction of Japan for any and all disputes, claims and actions arising from or in connection with the Data provided to you hereunder.

Government End Users. If the Data supplied by NAVTEQ is being acquired by or on behalf of the United States government or any other entity seeking or applying rights similar to those customarily claimed by the United States government, the Data is a "commercial item" as that term is defined at 48 C.F.R. ("FAR") 2.101, is licensed in accordance with the End-User Terms under which this Data was provided, and each copy of the Data delivered or otherwise furnished shall be marked and embedded as appropriate with the following "Notice of Use," and shall be treated in accordance with such Notice:

Notice of Use
Contractor (Manufacturer/ Supplier) Name:
NAVTEQ
Contractor (Manufacturer/Supplier)
Address:
425 West Randolph Street, Chicago, Illinois
60606
This Data is a commercial item as defined in
FAR 2.101 and is subject to the End-User
Terms under which this Data was provided.
© 2011 NAVTEQ - All rights reserved.

If the Contracting Officer, federal government agency, or any federal official refuses to use the legend provided herein, the Contracting Officer, federal government agency, or any federal official must notify NAVTEQ prior to seeking additional or alternative rights in the Data.

Notices related to licensed software copyright holders.

- Location name data for Japan



© 2011 ZENRIN CO., LTD.. All rights reserved.
 This service uses POI data of ZENRIN CO., LTD..
 "ZENRIN" is a registered trademark of ZENRIN CO., LTD..

- Location name data except for Japan



© 1993-2011 NAVTEQ. All rights reserved.
 NAVTEQ Maps is a trademark of NAVTEQ.

Austria	© Bundesamt für Eich- und Vermessungswesen
Croatia Cyprus Estonia Latvia Lithuania Moldova Poland Slovenia Ukraine	© EuroGeographics
France	source: © IGN France - BD TOPO ®
Germany	"Die Grundlagendaten wurden mit Genehmigung der zuständigen Behörden entnommen"
Great Britain	Contains Ordnance Survey data © Crown copyright and database right 2010 Contains Royal Mail data © Royal Mail copyright and database right 2010
Greece	Copyright Geomatics Ltd.
Hungary	Copyright © 2003; Top-Map Ltd.
Italy	La Banca Dati Italiana è stata prodotta usando quale riferimento anche cartografia numerica ed al tratto prodotta e fornita dalla Regione Toscana.
Norway	Copyright © 2000; Norwegian Mapping Authority
Portugal	Source: IgeoE - Portugal
Spain	Información geográfica propiedad del CNIG
Sweden	Based upon electronic data © National Land Survey Sweden.

USER LICENSE AGREEMENT FOR LOCATION NAME DATA (COOLPIX S9300 only)



Switzerland	Topografische Grundlage: © Bundesamt für Landestopographie
Canada	This data includes information taken with permission from Canadian authorities, including © Her Majesty, © Queen's Printer for Ontario, © Canada Post, GeoBase ®, © Department of Natural Resources Canada. All rights reserved.
Mexico	Fuente: INEGI (Instituto Nacional de Estadística y Geografía.)
Australia	© Hema Maps Pty. Ltd, 2011. Copyright. Based on data provided under license from PSMA Australia Limited (www.pdma.com.au). Product incorporates data which is © 2011 Telstra Corporation Limited, GM Holden Limited, Intelomatics Australia Pty Ltd, NAVTEQ International LLC, Sentinel Content Pty Limited and Continental Pty Ltd.
Israel	© Survey of Israel data source
Jordan	© Royal Jordanian Geographic Centre
Mozambique	Certain Data for Mozambique provided by Cenacarta © 2011 by Cenacarta
Réunion	source: © IGN 2009 - BD TOPO ®
Ecuador	INSTITUTO GEOGRAFICO MILITAR DEL ECUADOR AUTORIZACION N° IGM-2011-01- PCO-01 DEL 25 DE ENERO DE 2011
Guadeloupe	source: © IGN 2009 - BD TOPO ®
Guatemala	Aprobado por el INSTITUTO GEOGRAFICO NACIONAL - Resolución del IGN N° 186-2011
French Guiana	source: © IGN 2009 - BD TOPO ®
Martinique	source: © IGN 2009 - BD TOPO ®
Mexico	Fuente: INEGI (Instituto Nacional de Estadística y Geografía)

Troubleshooting









If the camera fails to function as expected, check the list of common problems below before consulting your retailer or Nikon-authorized service representative. Refer to the page numbers in the right-most column for more information.

- See “Error Messages” (🔍92) for more information.

Power, Display, Settings Issues

Problem	Cause/Solution	
The battery inserted in the camera cannot be charged.	<ul style="list-style-type: none"> • Confirm all connections. 	16, 18
The battery cannot be charged by connecting the camera to a computer.	<ul style="list-style-type: none"> • Off is selected for Charge by computer in the setup menu. • When charging by connecting the camera to a computer, battery charging stops when the camera is turned off. • When charging by connecting the camera to a computer, battery charging stops when the computer is suspended (sleeping), and the camera may turn off. • Depending upon computer specifications, settings, and status, charging the battery inserted in the camera may not be possible via computer connection. 	102, 📷80 📷80 📷80 –
Camera cannot be turned on.	<ul style="list-style-type: none"> • Battery is exhausted. • The camera cannot be turned on while connected to an electrical outlet via the Charging AC Adapter. 	20 16
Camera turns off without warning.	<ul style="list-style-type: none"> • Battery is exhausted. • If no operations are performed for a while, camera has turned off automatically by auto off to save power. • The camera turns off if the Charging AC Adapter is connected while the camera is on. • The camera turns off if the USB cable connecting it to a computer or printer is disconnected. Reconnect the USB cable. • Inside of the camera has become hot. Leave the camera off until the inside of the camera has cooled. • At low temperatures, the camera and the battery may not function normally. 	20 21 16 82, 85, 📷26 – 🔦3
Monitor is blank.	<ul style="list-style-type: none"> • Camera is off. • Battery is exhausted. • Standby mode for saving power: Press the power switch, shutter-release button,  button or  button, or rotate the mode dial. • When flash lamp flashes, wait until flash has charged. • Camera and computer are connected via USB cable. • Camera and TV are connected via audio/video cable or HDMI cable. 	21 20 21 60 82, 85 82, 📷23











Troubleshooting

Problem	Cause/Solution	
Monitor is hard to see.	<ul style="list-style-type: none"> Adjust monitor brightness. Monitor is dirty. Clean monitor. 	100,  70  6
Date and time of recording are not correct.	<ul style="list-style-type: none"> If the camera clock has not been set ("Date not set" indicator flashes during shooting), still pictures have a time stamp of "00/00/0000 00:00"; and movies are dated "01/01/12 00:00." Set the correct date and time using Time zone and date in the setup menu. The camera clock is not as accurate as a normal clock, such as watches. Check camera clock regularly against more accurate timepieces and reset as required. 	22, 100,  67 100,  67
No information displayed in monitor.	Hide info is selected for Photo info of Monitor settings in the setup menu.	100,  70
Print date not available.	Time zone and date has not been set.	22, 100,  67
Date not appearing on pictures even when Print date is enabled.	<ul style="list-style-type: none"> A shooting mode that does not support print date is selected. Another function that is set now is restricting the print date. The date cannot be imprinted onto a movie. 	100,  72 73 –
Screen for setting time zone and date is displayed when camera is turned on.	Clock battery is exhausted; all settings were restored to their default values.	23
Camera settings reset.		
Monitor is turned off, and the power-on lamp flashes quickly.	Battery temperature is high. Turn off camera, and allow battery to cool down before resuming use. After the lamp flashes for three minutes, the camera turns off automatically, but you can also press the power switch to turn it off manually.	21
Camera temperature rises.	When functions such as movie recording or sending images using an Eye-Fi card are used for a long time, or when the camera is used in a location with a high ambient temperature, the camera temperature may rise. This is not a malfunction.	89

















● Electronically Controlled Cameras







In extremely rare instances, unusual characters may appear on the monitor and the camera may stop functioning. In most cases, this phenomenon is caused by a strong external static charge. Turn the camera off, remove and replace the battery, then turn the camera on again. Note that disconnecting the power source as described above may result in the loss of any data not recorded on the internal memory or memory card at the time the problem occurred. Data already recorded is not affected. In the event of continued malfunction, contact your retailer or Nikon-authorized service representative.

Shooting Issues





Problem	Cause/Solution	
Cannot set to shooting mode.	Disconnect the HDMI cable or USB cable.	82, 85,  , 23,  26
No picture can be taken.	<ul style="list-style-type: none"> When camera is in playback mode, press the  button, shutter-release button or  (movie-record) button. When menus are displayed, press the MENU button. Battery is exhausted. When flash lamp flashes slowly, flash is charging. 	30 11 20 60
Cannot take 3D pictures	In some shooting conditions, such as when the subject moves or the subject is dark or low in contrast, the second shot may not be taken or the 3D picture may not be saved.	–
Camera cannot focus.	<ul style="list-style-type: none"> Subject is too close to the camera. Try shooting with Macro mode,  (Scene auto selector) or Close-up scene mode. The intended subject is one with which autofocus does not perform well. Set AF assist in the setup menu to Auto. Subject not in focus area when shutter-release button is pressed halfway. Turn camera off and then on again. 	39, 45 29 101,  75 28, 37 21
Colored stripes appear on the monitor when shooting.	Colored stripes may appear when shooting subjects with repeating patterns (such as window blinds); this is not a malfunction. The colored stripes will not appear in captured images or recorded movies. However, when using Continuous H: 120 fps or HS 120 fps (640x480) , the colored stripes may be seen in the captured images and recorded movies.	–
Pictures are blurred.	<ul style="list-style-type: none"> Use flash. Use vibration reduction or motion detection. Use BSS (Best Shot Selector). Use a tripod to stabilize the camera (use with the self-timer for better results). Specify a higher ISO sensitivity setting and resume shooting. 	60 101,  , 73,  74 56 63 37,  36
Bright specks appear in pictures shot using flash.	Flash is reflecting off particles in air. Set the flash to  (off).	61

Troubleshooting





Problem	Cause/Solution	
Flash does not fire.	<ul style="list-style-type: none"> Flash is set to  (off). A shooting mode that cannot turn on flash is selected. Another function that is set now is restricting the flash. 	61 59 73
The digital zoom is not available.	<ul style="list-style-type: none"> Off is selected for Digital zoom in the setup menu. When  (Scene auto selector),  (Night landscape),  (Backlighting) with HDR set to On, Portrait, Night portrait, Easy panorama, Pet portrait, or 3D photography is selected in scene mode, the digital zoom cannot be used. When smart portrait mode is selected, the digital zoom cannot be used. Other functions that restrict the use of digital zoom are set. 	101,  76 39, 40, 41, 42, 43, 47, 48, 49 50 73
Image mode is not available.	Another function that is set now is restricting Image mode .	71
No sound when shutter is released.	<ul style="list-style-type: none"> Off is selected for Shutter sound under Sound settings in the setup menu. Sports, Museum or Pet portrait is selected in scene mode. Continuous shooting mode is selected. Other functions that restrict the use of the shutter sound are set. Do not block the speaker. 	101,  77 42, 46, 48  77 3
AF-assist illuminator does not light.	Off is selected for AF assist in the setup menu. Even when Auto is set, AF-assist illuminator may not light depending on the focus area position or scene mode.	101,  75
Pictures appear smeared.	Lens is dirty. Clean lens.	 6
Colors are unnatural.	White balance or hue does not match light source.	37, 45, 65,  33
Ring-shaped or rainbow-colored bands are seen on the screen or the shot image.	When the subject is backlit or when shooting with an extremely bright light source in the display, such as in sunlight, ring-shaped or rainbow-colored bands may appear on the image. Change the position of the light source or remove it from the display, and try shooting again.	–
Randomly spaced bright pixels (“noise”) appear in image.	As the subject is dark, shutter speed is too slow or ISO sensitivity is too high. <ul style="list-style-type: none"> Use flash. Specify a lower ISO sensitivity setting. 	60 37,  36
Pictures are too dark	<ul style="list-style-type: none"> Flash is set to  (off). Flash window is blocked. Subject is beyond flash range. Adjust exposure compensation. Raise the ISO sensitivity. Subject is backlit. Select scene mode  (Backlighting), or set the flash mode to  (fill flash). 	61 26 60 68 37,  36 41, 60
Pictures are too bright	Adjust exposure compensation.	68



Problem	Cause/Solution	
Areas not affected by red-eye are also corrected.	When  (auto with red-eye reduction) or “fill flash with red-eye reduction” of the Night portrait scene mode is applied during shooting, In-Camera Red-Eye Fix may, in very rare cases, be applied to areas not affected by red-eye. Set a flash mode other than  (auto with red-eye reduction), select a scene mode other than Night portrait , and resume shooting.	43, 60
Skin softening results are not as expected.	<ul style="list-style-type: none"> • Skin softening may not produce the desired results depending on shooting conditions. • For pictures with four or more faces, try using Skin softening in the playback menu. 	52 80,  19
Saving images takes time.	It may take more time to save images in the following situations. <ul style="list-style-type: none"> • When the noise reduction function is automatically activated when shooting in a dark location. • When flash is set to  (auto with red-eye reduction) • When taking pictures in the following scene modes. <ul style="list-style-type: none"> - Hand-held in  (Night landscape) - HDR set to other than Off in  (Backlighting) - Hand-held in Night portrait - Easy panorama • When using continuous shooting 	– 61 40 41 43 47 55

Playback Issues





Problem	Cause/Solution	
File cannot be played back.	<ul style="list-style-type: none"> • File was overwritten or renamed by computer or another make or model of camera. • Movies recorded with cameras other than COOLPIX S9300/S9200 cannot be played back. 	– 92
Cannot play a sequence.	<ul style="list-style-type: none"> • Pictures shot continuously with cameras other than COOLPIX S9300/S9200 cannot be played as a sequence. • Check the Sequence display options setting. 	– 81,  52
Cannot zoom in on picture.	<ul style="list-style-type: none"> • Playback zoom cannot be used with movies, small pictures, or cropped copies of size 320 × 240 pixels or smaller. • Playback zoom may not be available for pictures taken with cameras other than COOLPIX S9300/S9200. • 3D pictures cannot be enlarged when the camera is connected via HDMI and they are played back in 3D. 	– –  5
Cannot record or play back voice memo.	<ul style="list-style-type: none"> • Voice memos cannot be attached to movies. • Voice memos cannot be attached to pictures taken with cameras other than COOLPIX S9300/S9200, and voice memos recorded by other cameras cannot be played back. 	– 81
Pictures and movies cannot be edited.	<ul style="list-style-type: none"> • Confirm the conditions that are required for editing pictures or movies. • Pictures and movies taken with cameras other than COOLPIX S9300/S9200 cannot be edited. 	80,  16,  31 –

Troubleshooting

Problem	Cause/Solution	
<p>Pictures not displayed on television.</p>	<ul style="list-style-type: none"> • Video mode or HDMI is not correctly set in the TV settings setup menu. • Cables are connected to both the HDMI mini connector and USB/audio video connector. • Memory card contains no pictures. Replace memory card. Remove memory card to play back pictures from internal memory. 	<p>102, 79 82 18</p>
<p>Album icons are reset to their default icons, or images added to albums cannot be displayed in favorite pictures mode.</p>	<p>Data saved in the internal memory or on the memory card may not be played back if overwritten by a computer.</p>	<p>–</p>
<p>The saved images are not displayed in auto sort mode.</p>	<ul style="list-style-type: none"> • The desired image was sorted to a category other than the category currently displayed. • Images saved by cameras other than COOLPIX S9300/S9200 and images copied using the Copy option cannot be displayed in auto sort mode. • Images saved in the internal memory or on the memory card may not be played back correctly if overwritten by a computer. • Up to 999 images and movies in total can be added to each category. If the desired category already contains 999 images or movies in total, new images or movies cannot be added. 	<p>–</p>
<p>Nikon Transfer 2 does not start when camera is connected to a computer.</p>	<ul style="list-style-type: none"> • Camera is off. • Battery is exhausted. • USB cable is not correctly connected. • Camera is not recognized by the computer. • Confirm that the operating system used is compatible with the camera. • Computer is not set to launch Nikon Transfer 2 automatically. For more information on Nikon Transfer 2, refer to help information contained in ViewNX 2. 	<p>21 20 82 – 83 –</p>
<p>The PictBridge startup screen is not displayed when the camera is connected to a printer.</p>	<p>With some PictBridge-compatible printers, the PictBridge startup screen may not be displayed and it may be impossible to print images when Auto is selected for the Charge by computer option in the setup menu. Set the Charge by computer option to Off and reconnect the camera to the printer.</p>	<p>102, 80</p>
<p>Pictures to be printed are not displayed.</p>	<ul style="list-style-type: none"> • Memory card contains no pictures. Replace memory card. • Remove memory card to print pictures from internal memory. • Pictures taken by 3D photography cannot be printed. 	<p>18 19 5</p>

Problem	Cause/Solution	
<p>Cannot select paper size with camera.</p>	<p>Paper size cannot be selected from the camera in the following situations, even for PictBridge compatible printers. Use the printer to select paper size.</p> <ul style="list-style-type: none"> • The paper size selected using the camera is not compatible with the printer. • A printer that automatically sets the paper size is being used. 	<p>  27,  28 – </p>

GPS (COOLPIX S9300 only)

Problem	Cause/Solution	
Unable to identify the location or it takes time to identify the location.	<ul style="list-style-type: none"> • The camera may not be able to identify the location in some shooting environments. To use the GPS feature, use the camera as much as possible in an open-air area. • When positioning for the first time, when positioning was unable to be performed for about two hours, or after the battery was changed, it takes a few minutes to obtain the positioning information. 	95 95
Unable to record position information on shot images.	When  or  is displayed on the shooting screen, the position information is not recorded. Before shooting pictures, make sure that the camera is receiving a GPS signal at sufficient strength.	96
Difference between the actual shooting location and recorded position information.	The acquired position information may deviate in some shooting environments. When there is a significant difference in the signals from the GPS satellite, there could be a deviation of up to several hundred meters.	95
An incorrect location name is recorded or the correct location name is not displayed.	The desired landmark name is not registered or an incorrect landmark name is displayed.	-
Unable to update the A-GPS file.	<ul style="list-style-type: none"> • Check the following items. <ul style="list-style-type: none"> - Whether the memory card is inserted - Whether the A-GPS file is stored in the memory card - Whether the A-GPS file saved in a memory card is more recent than the A-GPS file saved in the camera - Whether the A-GPS file is still valid • The A-GPS file may be corrupted. Download the file from the website once more. 	-  59
Unable to save log data.	<ul style="list-style-type: none"> • Be sure that a memory card is inserted in the camera. • Up to 36 log data events can be recorded in a day. • Up to 100 log data events can be stored on a single memory card. Delete log data that is no longer required from a memory card or replace the memory card with a new one. 	- -  63

Specifications

Nikon COOLPIX S9300/S9200 Digital Camera

Type	Compact digital camera
Effective pixels	16.0 million
Image sensor	1/2.3-in. type CMOS; approx. 16.79 million total pixels
Lens	18x optical zoom, NIKKOR lens
Focal length	4.5-81.0mm (angle of view equivalent to that of 25-450 mm lens in 35mm [135] format)
f/-number	f/3.5-5.9
Construction	11 elements in 10 groups (2 ED lens elements)
Digital zoom	Up to 4x (angle of view equivalent to that of an approx. 1800 mm lens in 35mm [135] format)
Vibration reduction	Lens shift
Autofocus (AF)	Contrast-detect AF
Focus range (from lens)	<ul style="list-style-type: none">• [W]: Approx. 50 cm (1 ft 8 in.) to ∞, [T]: Approx. 1.5 m (5 ft) to ∞• Macro mode: Approx. 4 cm (1.6 in.) (at a wide-angle zoom position) to ∞
Focus-area selection	Face priority, auto (9-area automatic selection), center, manual with 99 focus areas, subject tracking
Monitor	7.5-cm (3-in.), approx. 921k-dot, wide viewing angle TFT LCD monitor with anti-reflection coating and 5-level brightness adjustment
Frame coverage (shooting mode)	Approx. 98% horizontal and 98% vertical (compared to actual picture)
Frame coverage (playback mode)	Approx. 100% horizontal and 100% vertical (compared to actual picture)
Storage	
Media	Internal memory (COOLPIX S9300: approx. 26 MB) (COOLPIX S9200: approx. 25 MB) SD/SDHC/SDXC memory card
File system	DCF, Exif 2.3, DPOF, MPF compliant
File formats	Still pictures: JPEG 3D pictures: MPO Sound files (voice memo): WAV Movies: MOV (Video: H.264/MPEG-4 AVC, Audio: AAC stereo)
Image size (pixels)	<ul style="list-style-type: none">• 16 M (High) 4608×3456★• 16 M 4608×3456• 8 M 3264×2448• 4 M 2272×1704• 2 M 1600×1200• VGA 640×480• 16:9 12M 4608×2592

Specifications

ISO sensitivity (Standard output sensitivity)	<ul style="list-style-type: none">• ISO 125, 200, 400, 800, 1600, 3200• Auto (auto gain from ISO 125 to 1600)• Fixed range auto (ISO 125 to 400, 125 to 800)
Exposure	
Metering	256-segment matrix, center-weighted, spot (when digital zoom is 2x or higher)
Exposure control	Programmed auto, motion detection, exposure compensation (-2.0 to +2.0 EV in steps of 1/3 EV)
Shutter	Mechanical and CMOS electronic shutter
Speed	<ul style="list-style-type: none">• 1/2000 - 1 s• 1/4000 - 1/120 s (Continuous H: 120 fps)• 1/4000 - 1/60 s (Continuous H: 60 fps)• 4 s (Fireworks show scene mode)
Aperture	Electronically-controlled ND filter (-2 AV) selection mode
Range	2 (f/3.5, f/7 [W])
Self-timer	Duration of 2 or 10 seconds can be selected
Built-in flash	
Range (approx.) (ISO sensitivity: Auto)	[W]: 0.5 to 5.1 m (1 ft 8 in. to 16 ft) [T]: 1.5 to 3 m (5 ft to 9 ft 10 in.)
Flash control	TTL auto flash with monitor preflashes
Interface	Hi-Speed USB
Data transfer protocol	MTP, PTP
Video output	Can be selected from NTSC and PAL
HDMI output	Can be selected from Auto, 480p, 720p, and 1080i
I/O terminal	Audio/video (AV) output; digital I/O (USB); HDMI Mini Connector (Type C) (HDMI output)
Electronic compass (COOLPIX S9300 only)	16 cardinal points (position correction using 3-axis acceleration sensor, automatic correction for the deviated angle, and automatic offset adjustment)
GPS (COOLPIX S9300 only)	Receiver frequency 1575.42 MHz (C/A code), geodetic system WGS 84
Supported languages	Arabic, Brazilian Portuguese, Chinese (Simplified and Traditional), Czech, Danish, Dutch, English, Finnish, French, German, Greek, Hindi, Hungarian, Indonesian, Italian, Japanese, Korean, Norwegian, Polish, Portuguese, Romanian, Russian, Spanish, Swedish, Thai, Turkish, Ukrainian, Vietnamese
Power sources	<ul style="list-style-type: none">• One Rechargeable Li-ion Battery EN-EL12 (included)• AC Adapter EH-62F (available separately)
Charging time	Approx. 3 hours 50 minutes (when using Charging AC Adapter EH-69P and when no charge remains)
Battery life (EN-EL12)	Still pictures ¹ : Approx. 200 shots Movies ² : Approx. 50 min. (HD 1080p ★ (1920×1080))
Tripod socket	1/4 (ISO 1222)

Dimensions (W × H × D)	COOLPIX S9300
	108.7 × 62.3 × 30.6 mm (4.3 × 2.5 × 1.3 in.) (excluding projections)
	COOLPIX S9200
Weight	108.7 × 59.8 × 30.6 mm (4.3 × 2.4 × 1.3 in.) (excluding projections)
	COOLPIX S9300
	Approx. 215 g (7.6 oz.) (including battery and SD memory card)
Operating environment	COOLPIX S9200
	Approx. 209 g (7.4 oz.) (including battery and SD memory card)
	Temperature
Humidity	0°C to 40°C (32°F to 104°F)
	85% and below (no condensation)

- Unless otherwise stated, all figures are for a camera with a fully-charged Rechargeable Li-ion Battery EN-EL12 operated at an ambient temperature of 25°C (77°F).
- ¹ Based on Camera and Imaging Products Association (CIPA) standards for measuring the life of camera batteries. Measured at 23 (±2) °C (73 (±4) °F); zoom adjusted with each shot, flash fired with every other shot, Image mode set to  **4608×3456**. Battery life may vary depending on shooting interval and length of time menus and images are displayed.
- ² When recording a single movie, the maximum file size is 4 GB or the maximum recording time is 29 minutes, even when there is enough free space on the memory card.

Rechargeable Li-ion Battery EN-EL12

Type	Rechargeable lithium-ion battery
Rated capacity	DC 3.7 V, 1050 mAh
Operating temperature	0°C to 40°C (32°F to 104°F)
Dimensions (W × H × D)	Approx. 32 × 43.8 × 7.9 mm (1.3 × 1.7 × 0.3 in.)
Weight	Approx. 22.5 g (0.8 oz) (excluding terminal cover)

Charging AC Adapter EH-69P

Rated input	AC 100-240 V, 50/60 Hz, 0.068-0.042 A
Rated output	DC 5.0 V, 550 mA
Operating temperature	0°C to 40°C (32°F to 104°F)
Dimensions (W × H × D)	Approx. 55 × 22 × 54 mm (2.2 × 0.9 × 2.2 in.) (excluding plug adapter) For Argentina: Approx. 55 × 59 × 63 mm (2.2 × 2.4 × 2.5 in.) For Korea: Approx. 55 × 59 × 66.5 mm (2.2 × 2.4 × 2.7 in.)
Weight	Approx. 55 g (2.0 oz) (excluding plug adapter) For Argentina and Korea: Approx. 80 g (2.9 oz)

Specifications

- Nikon will not be held liable for any errors this manual may contain.
- The appearance of this product and its specifications are subject to change without notice.

Supported Standards

- **DCF:** Design Rule for Camera File System is a standard widely used in the digital camera industry to ensure compatibility among different makes of camera.
- **DPOF:** Digital Print Order Format is an industry-wide standard that allows pictures to be printed at a digital photo lab or with a household printer from print orders stored on the memory card.
- **Exif version 2.3:** This camera supports Exif (Exchangeable Image File Format for Digital Still Cameras) version 2.3, a standard that allows information stored with photographs to be used for optimal color reproduction when images are output from Exif-compliant printers.
See the instruction manual of the printer for further details.
- **PictBridge:** A standard developed cooperatively by the digital camera and printer industries, allowing photographs to be output directly to a printer without connecting the camera to a computer.

Symbols

- AE/AF-L 895
- OK Apply selection button 5, 10
- Auto mode 24, 36, 833
- Auto sort mode 78, 813
- Backlighting 41
- Continuous shooting mode 53, 55
- Delete button 4, 5, 32, 850
- Exposure compensation 68
- Favorite pictures mode 78, 89
- Flash mode 60
- List by date mode 78, 815
- Macro mode 64
- MENU Menu button 4, 5, 11
- movie-record) button 88
- Night landscape 40
- Playback button 4, 5, 30
- Playback zoom 31
- Scene auto selector 39
- SCENE** Scene mode 38
- Self-timer 63
- Smart portrait mode 50
- EFFECTS** Special effects mode 57
- T** Tele 27
- Thumbnail playback 5, 31
- W** Wide 27
 - .JPG 889
 - .MOV 889
 - .MPO 889
 - .WAV 889

Numerics

- 3D photography 3D 49, 895
- A**
 - AC adapter 17, 21, 891
 - AF area mode 37, 837
 - AF assist 101, 875
 - Album 89, 812
 - Aperture value 28
 - Applying digital filter effects 820
 - Audio/video cable 82, 823, 891

- Audio/video-in jack 823
- Auto 61
- Auto Mode 24, 36, 833
- Auto off 101, 877
- Auto sort mode 78, 813
- Auto with red-eye reduction 61, 62
- Autofocus 29, 64, 89
- Autofocus mode 37, 840
- AV cable 82, 823, 891

B

- Backlighting 41
- Battery 14, 16, 891
- Battery chamber 3
- Battery charger 17, 891
- Battery latch 14
- Battery level 20
- Battery-chamber/memory card slot cover 14, 18
- Beach 44
- Best shot selector 46, 56
- Black and white copy 46
- Blink proof 51, 842
- Blink warning 102, 882
- Brightness 65, 870
- BSS 56
- Button sound 101, 877

C

- Calendar display 31
- Camera strap 12
- Charge by computer 102
- Charge lamp 16, 17
- Charger 16, 17, 891
- Charging AC Adapter 16, 891
- Choose key picture 81, 852
- Close-up 45
- Compression ratio 71
- Computer 82, 85
- Continuous 53, 55, 836
- Continuous shooting menu 55
- Continuous shooting mode 53, 833

Index

Contrast 18

Copy 81, 51

Create log 61

Creative slider 65

Crop 31, 22

D

Date and time 22, 67

Date display order 22, 67

Date format 67

Date imprint 23, 100, 72

Daylight saving time 23, 68

Delete 32, 8, 50

Digital filter 20

Digital zoom 27, 101, 76

Direct print 25

D-Lighting 80, 18

DPOF printing 30

DSCN 89

Dusk/dawn 44

E

Easy panorama 47, 2

Editing movies 31

Editing pictures 16

Electronic compass 64

Exposure compensation 65, 68

Extension 89

Eye-Fi upload 102, 83

F

Face priority 75, 37

Fast motion 55

Favorite pictures 81, 9

Favorite pictures mode 78, 9

File and folder names 89

File name 89

File number 89

Fill flash 61

Filmstrip 102, 84

Filter effects 80, 17, 20

Fireworks show 46

Firmware version 102, 88

Fixed auto range 36

Flash 60

Flash lamp 60

Flash mode 60

Focus 28, 37, 40

Focus area 37

Focus lock 76

Folder name 89

Food 45

Format 18, 101, 78

Format the internal memory 101, 78

Formatting a memory card 18, 101, 78

Framing grid 71

FSCN 89

Full-frame playback 30

Full-time AF 91, 57

G

GPS settings 58

H

HDMI 49, 79

HDMI 3D output 79

HDMI device control 79

HDMI mini connector 82, 23

Help 38

Histogram 30, 67

HS footage 91

HS movie 54, 55

Hue 65

I

Identifier 89

Image copy 51

Image mode 37, 71, 72

Image selection screen 48

Images 16

Internal memory 19, 20, 30

ISO sensitivity 26, 37, 36

L

Landscape 42

Language 102, 78

Lens 2, 6, 19

Lens cover 2

Li-ion rechargeable battery 14, 16, 91

List by date mode 78, 15

Lithium-ion type battery 14

M

Macro 64

Maximum movie length 88, 90

Memory capacity 20

Memory card 18, 19, 72

Memory card slot 18

Metering 37, 35

Microphone 2, 81, 50

Mode dial 2, 38

Monitor 6, 8, 6

Monitor brightness 100, 70

Monitor settings 100, 70

Motion detection 101, 74

Movie frame 71

Movie options 91, 53

Movie playback 92

Movie recording 88

Multi selector 10, 59

Multi-shot 16 56

Museum 46

N

Night landscape 40

Night portrait 43

Number of exposures remaining 20, 72

O

Off 61

Open with HS footage 91, 54

Optical zoom 27

Optional accessories 91

P

Paper size 27, 28

Party/indoor 44

Pet portrait 48

Pet portrait auto release 48

Photo info 100, 70

PictBridge 25, 22

Playback 30, 78, 92, 43, 50

Playback button 4, 5

Playback menu 80, 43

Playback mode 30

Playback modes 78

Playback zoom 31

Points of interest 60

Portrait 42

Power switch/Power-on lamp 20, 21

Preset manual 34

Pre-shooting cache 55

Print 25, 27, 28

Print date 23, 100, 72

Print order 80, 43, 44

Print order option 44

Printer 82, 25

Printing 27, 28

Protect 80, 47

Q

Quick retouch 80, 18

R

Rechargeable Li-ion battery 14, 91

Recording slow motion movies 55

Remove from favorites 81, 11

Reset all 102, 84

Rotary multi selector 10, 59

Rotate image 80, 49

RSCN 89

S

Scene auto selector 39

Scene mode 38, 39

Screen brightness 100

Scroll 4

Selecting pictures 48

Self-timer 63

Self timer lamp 63

Sequence 7

Sequence display options 81, 52

Setup menu 100, 66



















Shooting date 44

Shooting information 10, 30, 44







Shooting menu 36

Shooting mode 24

Index

Shutter sound 77
Shutter speed 28
Shutter-release button 4, 5, 28
Single AF 40, 57
Skin softening 51, 52, 80, 19,
41
Slide show 80, 46
Slow motion 55
Slow sync 61
Small picture 80, 21
Smart portrait menu 51, 41
Smart portrait mode 51
Smile timer 51, 41
Snow  44
Sound settings 101, 77
Special effects mode 25, 57, 54
Sports  42
SSCN 89
Subject tracking 38, 39
Sunset  44





I

Telephoto zoom 27
Thumbnail playback 31
Time difference 68, 69
Time zone 22, 67, 69
Time zone and date 22, 100, 67
Tripod socket 3
TV 82
TV settings 102, 79



U

USB cable 16, 82, 26, 91
USB/audio/video output connector 16,
82, 23, 26

V

Vibration reduction 101, 73
Video mode 79
View log 63
View/show histograms 100
ViewNX 2 83
Vividness 65
Voice memo 81, 50
Volume 92

W

Welcome screen 100, 66
White balance 37, 33
Wide 27
Wind noise reduction 91, 57

Z

Zoom 27
Zoom control 4, 5, 27, 31



A series of horizontal dashed lines spanning the width of the page, intended for handwriting practice.

Nikon

No reproduction in any form of this manual, in whole or in part (except for brief quotation in critical articles or reviews), may be made without written authorization from NIKON CORPORATION.



NIKON CORPORATION

© 2012 Nikon Corporation

FX2C02(11)
6MM20011-02