

Nikon

DIGITAL CAMERA
COOLPIX S800c

Reference Manual



En



Ensuring Longer Battery Life

Stand by Mode

- This power saving mode greatly reduces battery power consumption and allows you to quickly turn back on the camera. Press the power switch to enter stand by mode. Press the power switch again to immediately exit stand by mode and resume shooting or playback.



- After a certain amount of time elapses in stand by mode (the default setting is **1 hour**), the camera turns off (📖75; **Shut-down timer**). **All unsaved data is lost when the camera turns off after the set amount of time. Save the data you want to keep before the camera enters stand by mode.**

Power Off

Press and hold the power switch to turn off the camera (force-quit). Almost no battery power is consumed. When you turn on the camera, you are limited to taking only a few pictures and cannot change the settings until Android™ OS starts up completely. Save the data you want to keep before you turn off the camera, just as you would in stand by mode.

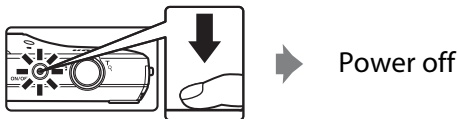

Reducing Battery Power Consumption While Using the Camera

Turn off the functions that are not in use to reduce battery power consumption. We recommend placing the **Power control** widget on the Android™ platform home screen and turning off these functions as often as possible. See “Using Widgets” (📖88) for more information.

See “Power Supply Status and Power Saving Function” (📖19) for more information about the power saving function.

Introduction

Parts of the Camera and Basic Operations

Basic Steps for Shooting and Playback

Shooting Features

Playback Features

Recording and Playing Back Movies

General Camera Setup

Sharing Images

Using Android™ Platform

Reference Section

Technical Notes and Index

Introduction

Read This First

Thank you for purchasing the Nikon COOLPIX S800c digital camera. Before using the camera, please read the information in "For Your Safety" (📖vi–viii) and familiarize yourself with the information provided in this manual. After reading, please keep this manual handy and refer to it to enhance your enjoyment of your new camera.

Confirming the Package Contents

In the event that any items are missing, please contact the store where you purchased the camera.



COOLPIX S800c
Digital Camera



Camera Strap

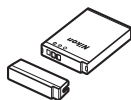

Rechargeable Li-ion Battery
EN-EL12
(with Terminal Cover)

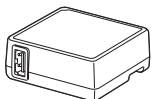

Charging AC Adapter
EH-69P*

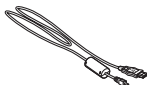

USB Cable UC-E6

- Warranty

* A plug adapter is included if the camera was purchased in a country or region that requires a plug adapter. The shape of the plug adapter varies with the country or region of purchase (📖14).

NOTE: A memory card is not included with the camera.







About This Manual

If you want to start using the camera right away, see “Basic Steps for Shooting and Playback” (📖12).

To learn about the parts of the camera and basic operations, see “Parts of the Camera and Basic Operations” (📖1).

Other Information

- Symbols and conventions

Symbol	Description
	This icon indicates cautions and information that should be read before using the camera.
	This icon indicates notes and information that should be read before using the camera.
 /  / 	These icons indicate other pages containing relevant information;  : “Reference Section”,  : “Technical Notes and Index.”

- SD and SDHC memory cards are referred to as “memory cards” in this manual.
- The setting at the time of purchase is referred to as the “default setting.”
- The names of menu items displayed in the camera monitor, and the names of buttons or messages displayed on a computer monitor appear in bold.
- In this manual, images are sometimes omitted from monitor display samples so that monitor indicators can be more clearly shown.
- Illustrations and monitor content shown in this manual may differ from the actual product.

Information and Precautions

Life-Long Learning

As part of Nikon's "Life-Long Learning" commitment to ongoing product support and education, continually updated information is available online at the following sites:

- For users in the U.S.A.: <http://www.nikonusa.com/>
- For users in Europe and Africa: <http://www.europe-nikon.com/support/>
- For users in Asia, Oceania, and the Middle East: <http://www.nikon-asia.com/>

Visit these sites to keep up-to-date with the latest product information, tips, answers to frequently asked questions (FAQs), and general advice on digital imaging and photography. Additional information may be available from the Nikon representative in your area. Visit the site below for contact information.

<http://imaging.nikon.com/>

Use Only Nikon Brand Electronic Accessories

Nikon COOLPIX cameras are designed to the highest standards and include complex electronic circuitry. Only Nikon brand electronic accessories (including battery chargers, batteries, Charging AC Adapters, and AC adapters) certified by Nikon specifically for use with this Nikon digital camera are engineered and proven to operate within the operational and safety requirements of this electronic circuitry.

THE USE OF NON-NIKON ELECTRONIC ACCESSORIES COULD DAMAGE THE CAMERA AND MAY VOID YOUR NIKON WARRANTY.

The use of third-party rechargeable Li-ion batteries not bearing the Nikon holographic seal could interfere with normal operation of the camera or result in the batteries overheating, igniting, rupturing, or leaking.

For more information about Nikon brand accessories, contact a local authorized Nikon dealer.



Holographic seal:

Identifies this device as an authentic Nikon product.

Before Taking Important Pictures

Before taking pictures on important occasions (such as at weddings or before taking the camera on a trip), take a test shot to ensure that the camera is functioning normally. Nikon will not be held liable for damages or lost profits that may result from product malfunction.

About the Manuals

- No part of the documentation included with this product may be reproduced, transmitted, transcribed, stored in a retrieval system, or translated into any language in any form, by any means, without Nikon's prior written permission.
- Nikon reserves the right to change the specifications of the hardware and software described in the documentation at any time and without prior notice.
- Nikon will not be held liable for any damages resulting from the use of this product.
- While every effort was made to ensure that the information in the documentation is accurate and complete, we would appreciate it were you to bring any errors or omissions to the attention of the Nikon representative in your area (address provided separately).

Notice Concerning Prohibition of Copying or Reproduction

Note that simply being in possession of material that was digitally copied or reproduced by means of a scanner, digital camera or other device may be punishable by law.

- **Items prohibited by law from being copied or reproduced**

Do not copy or reproduce paper money, coins, securities, government bonds or local government bonds, even if such copies or reproductions are stamped "Sample." The copying or reproduction of paper money, coins, or securities which are circulated in a foreign country is prohibited. Unless the prior permission of the government was obtained, the copying or reproduction of unused postage stamps or post cards issued by the government is prohibited. The copying or reproduction of stamps issued by the government and of certified documents stipulated by law is prohibited.

- **Cautions on certain copies and reproductions**

The government has issued cautions on copies or reproductions of securities issued by private companies (shares, bills, checks, gift certificates, etc.), commuter passes, or coupon tickets, except when a minimum of necessary copies are to be provided for business use by a company. Also, do not copy or reproduce passports issued by the government, licenses issued by public agencies and private groups, ID cards and tickets, such as passes and meal coupons.

- **Comply with copyright notices**

The copying or reproduction of copyrighted creative works such as books, music, paintings, woodcut prints, maps, drawings, movies, and photographs (including those downloaded from the Internet, and those originally installed on or captured by the camera) is governed by national and international copyright laws. Do not use this product for the purpose of making illegal copies or to infringe copyright laws.

Disposing of Data Storage Devices

Please note that deleting images or formatting data storage devices such as memory cards or built-in camera memory does not completely erase the original image data. Deleted files can sometimes be recovered from discarded storage devices using commercially available software, potentially resulting in the malicious use of personal image data. Ensuring the privacy of such data is the user's responsibility.

Before discarding a data storage device or transferring ownership to another person, erase all data using commercial deletion software, or format the device and then completely refill it with images containing no private information such as images of empty sky taken with **Use GPS satellites in Location & security** in the Android™ platform setting menu (📍91) set to off. Care should be taken to avoid injury or damage to property when physically destroying data storage devices.

For Your Safety

To prevent damage to your Nikon product or injury to yourself or to others, read the following safety precautions in their entirety before using this equipment. Keep these safety instructions where all those who use the product will read them. The consequences that could result from failure to observe the precautions listed in this section are indicated by the following symbol:



This icon marks warnings, information that should be read before using this Nikon product, to prevent possible injury.

WARNINGS

Turn off in the event of malfunction

Should you notice smoke or an unusual smell coming from the camera or Charging AC Adapter, unplug the Charging AC Adapter and remove the battery immediately, taking care to avoid burns. Continued operation could result in injury. After removing or disconnecting the power source, take the equipment to a Nikon-authorized service representative for inspection.

Do not disassemble

Touching the internal parts of the camera or Charging AC Adapter could result in injury. Repairs should be performed only by qualified technicians. Should the camera or Charging AC Adapter break open as the result of a fall or other accident, take the product to a Nikon-authorized service representative for inspection, after unplugging the product and/or removing the battery.

Do not use the camera or Charging AC Adapter in the presence of flammable gas

Do not use electronic equipment in the presence of flammable gas, as this could result in explosion or fire.

Handle the camera strap with care

Never place the strap around the neck of an infant or child.

Keep out of reach of children

Particular care should be taken to prevent infants from putting the battery or other small parts into their mouths.

Do not remain in contact with the camera, battery charger, or AC adapter for extended periods while the devices are on or in use.

Parts of the devices become hot. Leaving the devices in direct contact with the skin for extended periods may result in low-temperature burns.

Observe caution when handling the battery

The battery may leak, overheat or explode if improperly handled. Observe the following precautions when handling the battery for use in this product:

- Before replacing the battery, turn the product off. If you are using the Charging AC Adapter/AC adapter, be sure it is unplugged.
- Use only a Rechargeable Li-ion Battery EN-EL12 (included). Charge the battery by using a camera that supports battery charging. To perform this operation, use Charging AC Adapter EH-69P (included). The Battery Charger MH-65 (available separately) is also available to charge the battery without using a camera.
- When inserting the battery, do not attempt to insert it upside down or backwards.
- Do not short or disassemble the battery or attempt to remove or break the battery insulation or casing.
- Do not expose the battery to flame or excessive heat.
- Do not immerse in or expose to water.
- Replace the terminal cover before transporting the battery. Do not transport or store with metal objects such as necklaces or hairpins.

- The battery is prone to leakage when fully discharged. To avoid damage to the product, be sure to remove the battery when no charge remains.
- Discontinue use immediately should you notice any change in the battery, such as discoloration or deformation.
- If liquid from the damaged battery comes in contact with clothing or skin, rinse immediately with plenty of water.

Observe the following precautions when handling the Charging AC Adapter

- Keep dry. Failure to observe this precaution could result in fire or electric shock.
- Dust on or near the metal parts of the plug should be removed with a dry cloth. Continued use could result in fire.
- Do not handle the plug or go near the Charging AC Adapter during lightning storms. Failure to observe this precaution could result in electric shock.
- Do not damage, modify, forcibly tug or bend the USB cable, place it under heavy objects, or expose it to heat or flames. Should the insulation be damaged and the wires become exposed, take it to a Nikon-authorized service representative for inspection. Failure to observe these precautions could result in fire or electric shock.

For Your Safety

- Do not handle the plug or Charging AC Adapter with wet hands. Failure to observe this precaution could result in electric shock.
- Do not use with travel converters or adapters designed to convert from one voltage to another or with DC-to-AC inverters. Failure to observe this precaution could damage the product or cause overheating or fire.

Use appropriate cables

When connecting cables to the input and output jacks, use only the cables provided or sold by Nikon for the purpose, to maintain compliance with product regulations.

Handle moving parts with care

Be careful that your fingers or other objects are not pinched by the lens cover or other moving parts.

Observe caution when using the flash

Using the flash close to your subject's eyes could cause temporary visual impairment. Particular care should be observed if photographing infants, when the flash should be no less than 1 meter (3 ft 4 in.) from the subject.

Do not operate the flash with the flash window touching a person or object

Failure to observe this precaution could result in burns or fire.

Do not apply pressure to the monitor

Should the monitor break, care should be taken to avoid injury caused by broken glass.

Turn the power off when using inside an airplane or the hospital

Turn the power off while inside the airplane during take off or landing. Follow the instructions of the hospital when using while in a hospital. The electromagnetic waves given out by this camera may disrupt the electronic systems of the airplane or the instruments of the hospital.

Notices

Notices for Customers in the U.S.A.

IMPORTANT SAFETY INSTRUCTIONS— SAVE THESE INSTRUCTIONS.

DANGER - TO REDUCE THE RISK OF FIRE OR ELECTRIC SHOCK, CAREFULLY FOLLOW THESE INSTRUCTIONS

For connection to a supply not in the U.S.A., use an attachment plug adapter of the proper configuration for the power outlet if needed.

The power supply unit is intended to be correctly orientated in a vertical or floor mount position.

Federal Communications Commission (FCC) Radio Frequency Interference Statement

This equipment has been tested and found to comply with the limits for a Class B digital device, pursuant to part 15 of the FCC Rules. These limits are designed to provide reasonable protection against harmful interference in a residential installation. This equipment generates, uses and can radiate radio frequency energy and, if not installed and used in accordance with the instructions, may cause harmful interference to radio communications. However, there is no guarantee that interference will not occur in a particular installation. If this equipment does cause harmful interference to radio or television reception, which can be determined by turning the equipment off and on, the user is encouraged to try to correct the interference by one or more of the following measures:

- Reorient or relocate the receiving antenna.

- Increase the separation between the equipment and receiver.
- Connect the equipment into an outlet on a circuit different from that to which the receiver is connected.
- Consult the dealer or an experienced radio/ TV technician for help.



Nikon
COOLPIX S800c

CAUTIONS

Modifications

The FCC requires the user to be notified that any changes or modifications made to this device that are not expressly approved by Nikon Corporation may void the user's authority to operate the equipment.

Interface Cables

Use the interface cables sold or provided by Nikon for your equipment. Using other interface cables may exceed the limits of Class B Part 15 of the FCC rules.

Notice for customers in the State of California

WARNING

Handling the cord on this product will expose you to lead, a chemical known to the State of California to cause birth defects or other reproductive harm.

Wash hands after handling.

Nikon Inc.,
1300 Walt Whitman Road
Melville, New York 11747-3064
USA

Tel: 631-547-4200

Notice for Customers in Canada

CAUTION

This Class B digital apparatus complies with Canadian ICES-003.

ATTENTION

Cet appareil numérique de la classe B est conforme à la norme NMB-003 du Canada.

Notices for Customers in Europe

CAUTIONS

RISK OF EXPLOSION IF BATTERY IS REPLACED BY AN INCORRECT TYPE.

DISPOSE OF USED BATTERIES ACCORDING TO THE INSTRUCTIONS.

This symbol indicates that this product is to be collected separately.



The following apply only to users in European countries:

- This product is designated for separate collection at an appropriate collection point. Do not dispose of as household waste.
- For more information, contact the retailer or the local authorities in charge of waste management.

This symbol on the battery indicates that the battery is to be collected separately.



The following apply only to users in European countries:

- All batteries, whether marked with this symbol or not, are designated for separate collection at an

appropriate collection point. Do not dispose of as household waste.

- For more information, contact the retailer or the local authorities in charge of waste management.

Wi-Fi (Wireless LAN Network)/Bluetooth Function

This product is controlled by the United States Export Administration Regulations, and you are required to obtain permission from the United States government if you export or re-export this product to any country to which the United States embargoes goods. The following countries were subject to embargo: Cuba, Iran, North Korea, Sudan, and Syria. Since the target countries are subject to change, please contact the United States Department of Commerce for the latest information.

Restrictions on Wireless Devices

The wireless transceiver included in this product conforms to wireless regulations in the country of sale and is not for use in other countries (products purchased in the EU or EFTA can be used anywhere within the EU and EFTA). Nikon does not accept liability for use in other countries. Users who are unsure as to the original country of sale should consult with their local Nikon service center or Nikon-authorized service representative. This restriction applies to wireless operation only and not to any other use of the product.

Notice for Customers in the U.S.A. and Canada

Federal Communications Commission (FCC) and Industry of Canada (IC)

Declaration of Conformity

This device complies with Part 15 of FCC Rules and Industry Canada licence-exempt RSS standard(s). Operation is subject to the following two conditions: (1) this device may not cause interference, and (2) this device must accept any interference, including interference that may cause undesired operation of this device.

FCC/IC RF Exposure Statement

This transmitter must not be co-located or operated in conjunction with any other antenna or transmitter.

The available scientific evidence does not show that any health problems are associated with using low power wireless devices. There is no proof, however, that these low power wireless devices are absolutely safe. Low power wireless devices emit low levels of radio frequency energy (RF) in the microwave range while being used. Whereas high levels of RF can produce health effects (by heating tissue), exposure of low-level RF that does not produce heating effects causes no known adverse health effects. Many studies of low-level RF exposures have not found any biological effects. Some studies have suggested that some biological effects might occur, but such findings have not been confirmed by additional research.

Wi-Fi (Wireless LAN Network)/Bluetooth Function

COOLPIX S800c, which is equipped with a WYAAAVDXA-1 (FCC ID: RYYWYAAAVD / IC: 4389B-WYAAAVD) Wireless LAN Module, has been tested and found to comply with FCC/IC radiation exposure limits set forth for an uncontrolled environment and meets the FCC radio frequency (RF) Exposure Guidelines in Supplement C to OET65 and RSS-102 of the IC radio frequency (RF) Exposure rules. Please refer to the SAR test report that was uploaded to FCC website.

Declaration of Conformity

Hereby, Nikon Corporation, declares that this Wireless LAN Module (WYAAAVDXA-1) is in compliance with the essential requirements and other relevant provisions of Directive 1999/5/EC. The declaration of conformity may be consulted at http://imaging.nikon.com/support/pdf/DoC_S800c.pdf.

Notice for Customers in Singapore

This device complies with radio-frequency regulations.

<p>Complies with IDA Standards DA103423</p>
--

Notice for customers in the Hashemite Kingdom of Jordan

This device complies with radio-frequency regulations.

The grant number is shown as below.

TRC/SS/2012/171

Notice for customers in the Sultanate of Oman

This device complies with radio-frequency regulations.

OMAN - TRA
R/0807/12
D080093

Notice for customers in the United Arab Emirates

This device complies with radio-frequency regulations.

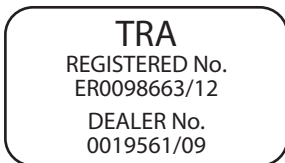
**Precautions when Using Radio Transmissions**

- Always keep in mind that radio transmission or reception of data is subject to interception by third parties. Note that Nikon is not responsible for data or information leaks that may occur during data transfer.
- The Wi-Fi (wireless LAN) and Bluetooth functions share the same frequency band; therefore, using both functions simultaneously may cause radio wave interference, resulting in decreased communication speed or network disconnection. If you experience a problem with the connection, stop using either the Wi-Fi (wireless LAN) or Bluetooth function.
- The operating frequency band of this equipment is used by industrial, scientific, consumer and medical equipment including microwave ovens, premises radio stations for identifying mobile units used in the manufacturing lines of plants (radio stations requiring no license), and amateur radio stations (hereinafter referred to as "another station"). 1. Before using this equipment, confirm that another station is not being operated nearby. 2. In the event of this equipment causing harmful radio wave interference with another station, promptly change the operating frequency or stop radio wave emission by turning off the power, etc. 3. If you have further questions, contact a Nikon service center or Nikon authorized service representative.

Precautions when Using the Wireless LAN Features

- When using the LAN function of this product, the product will search for wireless networks automatically. At this time, the product may display wireless networks (SSIDs) for which you are not an authorized user. Use of such a wireless network may be regarded as unauthorized access. Never connect to an SSID that you are not authorized to use.

Precautions when Using the Bluetooth Feature

- The Bluetooth function of this product shares the 2.4 GHz frequency band with various other devices; therefore, interference from other devices may decrease this product's Bluetooth communication speed or distance, or cause the Bluetooth connection to fail.
- Bluetooth communication speed and distance may vary depending on the type of Bluetooth device and on the physical distance or presence of obstacles between the devices.

Personal Information Management and Disclaimer

- User information registered and configured on the product, including wireless LAN connection settings and other personal information, is susceptible to alteration and loss resulting from operational error, static electricity, accident, malfunction, repair or other handling. Always keep separate copies of important information. Nikon is not responsible for any direct or indirect damages or lost profits resulting from alteration or loss of content that is not attributable to Nikon.
- Before discarding this product or transferring it to another owner, it is recommended that you apply the reset option from **Factory data reset** in **Privacy** and **Erase SD card** in **Storage** in the Android™ platform (📖91) setting menu, to delete all user information registered and configured with the product, including wireless LAN connection settings and other personal information.
- Nikon is not responsible for any communication charges stemming from unauthorized access to a public wireless LAN by third parties, or any other damages resulting from theft of the product.
- Nikon is not responsible for any damages stemming from unauthorized use of email addresses stored in the camera resulting from theft of the product.

Notes About GPS

Electromagnetic Waves Emitted from the Camera

- The electromagnetic waves emitted from the camera may affect the measuring instruments of an airplane or medical equipment. When use of the camera is prohibited during airplane takeoffs and landings or inside a hospital, set **Use GPS satellites** in **Location & security** in the Android™ platform setting menu (📖91) to off and turn off the camera.

Using the Camera Overseas

- Before taking the camera with GPS function overseas for travel, consult your travel agency or embassy of the country you are visiting to confirm whether there is any restriction on use.

Table of Contents

Introduction	ii
Read This First	ii
Confirming the Package Contents	ii
About This Manual	iii
Information and Precautions	iv
For Your Safety	vi
WARNINGS	vi
Notices	ix
Wi-Fi (Wireless LAN Network)/Bluetooth Function	xi
Notes About GPS	xiv
<hr/>	
Parts of the Camera and Basic Operations	1
Parts of the Camera	1
The Camera Body	1
Using the Camera Buttons	3
Attaching the Camera Strap	3
Operating the Touch Panel	4
Tapping	4
Touching and Holding	4
Dragging	4
Spreading/Pinching	5
Flicking	5
Indicators and Operations of the Monitor/Touch Panel	6
Shooting Mode (Information Indicators)	6
Shooting Mode (Operation Controls)	7
Playback Mode (Information Display)	8
Playback Mode (Operation Controls)	9
Switching Between Shooting Mode and Playback Mode	10
Switching the Horizontal/Vertical Screen Rotation	11
<hr/>	
Basic Steps for Shooting and Playback	12
Preparation 1 Insert the Battery	12
Preparation 2 Charge the Battery	14
Preparation 3 Insert a Memory Card	16
Internal Memory and Memory Cards	17















Table of Contents

Step 1 Turn the Camera On	18
Power Supply Status and Power Saving Function.....	19
Step 2 Select a Shooting Mode.....	20
Available Shooting Modes.....	21
Step 3 Frame a Picture	22
Using the Zoom.....	23
Step 4 Focus and Shoot	24
Step 5 Play Back Images	26
Step 6 Delete Unwanted Images.....	28
<hr/>	
Shooting Features	30
📷 (Easy Auto) Mode.....	30
📷 (Auto) Mode	31
Scene Mode (Shooting Suited to Scenes)	32
Viewing a Description (Help Information) of Each Scene	32
Selecting a Scene Mode (Features)	34
Special Effects Mode (Applying Effects When Shooting)	40
Smart Portrait Mode (Shooting Smiling Faces).....	41
Basic Shooting Settings	43
Functions Available for Each Shooting Mode	43
Using the Flash (Flash Modes)	44
Using the Self-timer	46
Using Macro Mode	48
Adjusting Brightness (Exposure Compensation)	49
Default Settings	50
Functions That Can Be Set with the MENU (Menu) Button (Shooting Menu)	52
Shooting Menu Options.....	53
Skin Softening.....	54
Functions That Cannot Be Used Simultaneously	55
Focusing on Subjects.....	57
Focus Area.....	57
Face Detection	58
Shooting Subjects Not Suitable for Autofocus	60

Playback Features.....	61
Playback Zoom	61
Thumbnail Playback.....	62
Functions That Can be Set with the MENU Button (Playback Menu)	63
Playback Menu Options.....	63
Connecting the Camera to a TV and Computer	64
Using ViewNX 2	65
Installing ViewNX 2	65
Transferring Images to the Computer	66
Viewing Images.....	68
Recording and Playing Back Movies.....	69
Recording Movies	69
Functions That Can be Set with the MENU Button (Movie menu)	72
Movie Menu Options.....	72
Movie Playback.....	73
General Camera Setup.....	74
The Setup Menu	74
Sharing Images.....	77
Uploading Images to Online Services	77
Using Android™ Platform	79
When Turning On the Camera for the First Time	79
Setting Up a Wi-Fi (Wireless LAN) Network.....	80
Setting Up a Google Account.....	82
Setting the Date and Time.....	84

Entering Text	86
How to Enter Text, Number and Symbol.....	86
Switching Between the Text Keyboard and the Number and Symbol Keyboard	86
Other Keyboard Operations.....	87
Editing Text.....	87
Basic Operations for Android™ Platform	88
Displaying the Home Screen.....	88
Displaying the Applications Screen	89
Switching the Screen	89
Status Bar and Notification Panel	90
Using Android™ Platform Setting Menu	91
Using the Option Menu.....	92
Using the Applications	93
Searching for Information	93
Using the Internet	93
Using Google Play Store (Getting Applications)	94
<hr/>	
Reference Section	81
Using Easy Panorama (Shooting and Playback)	82
Shooting with Easy Panorama.....	82
Viewing Images Captured with Easy Panorama (Scroll Playback).....	84
Editing Images (Still Images)	85
Editing Functions.....	85
🔧 Quick Retouch: Enhancing Contrast and Saturation.....	87
📷 D-Lighting: Enhancing Brightness and Contrast	88
🌀 Filter Effects: Digital Filters	89
👤 Skin Softening: Softening Skin Tones	11
🖼️ Small Picture: Making Smaller Images	12
✂️ Crop: Creating a Cropped Copy	13
Connecting the Camera to a TV (Playback on a TV)	15
Playing Audio via Bluetooth Device	17
Transferring Images to Your Smart Device	20
Installing the Connect to S800c Application on Your Smart Device.....	20
Simple Setup (Automatically Connecting the Camera to the Smart Device).....	21
Transferring Images from Camera to Smart Device.....	23
Changing the Connect to S800c Application Settings.....	25
The Shooting Menu (for 📷 (Auto) Mode)	26
📷 Image Mode (Image Size and Quality).....	26
📷/📷/📷 Touch Shooting	28
ISO ISO Sensitivity.....	35
📷 Continuous.....	36
WB White Balance (Adjusting Hue).....	38

The Smart Portrait Menu	40
Skin Softening	40
Blink Proof	41
Smile Timer	41
The Playback Menu	42
Slide Show	42
Protect	44
Print Order (Creating a DPOF Print Order)	46
Rotate Image	49
Copy (Copy Between Internal Memory and Memory Card)	50
The Movie Menu	52
Movie Options	52
Touch Shooting	53
AF Autofocus Mode	54
Wind Noise Reduction	54
The Setup Menu	55
Welcome Screen	55
Monitor Settings	56
Print Date (Imprinting Date and Time)	57
Vibration Reduction	58
AF Assist	59
Digital Zoom	59
Shutter Sound	60
Shut-down Timer	60
HDMI	61
Blink Warning	61
GPS Options	63
Reset All	67
Firmware Version	69
Basic Settings for the Android™ Platform	70
Wireless & Networks	70
Brightness	71
Audible Selection	71
Display Off	71
Use GPS Satellites	72
Reboot	72
Erase SD Card (Format)	73
Select Language	74
File and Folder Names	75
Optional Accessories	76
Error Messages	77

Technical Notes and Index		1
Maximizing Camera Life and Performance		2
The Camera		2
The Battery		3
Charging AC Adapter		4
Memory Cards		4
Cleaning and Storage		6
Cleaning		6
Storage.....		6
Troubleshooting		7
Specifications		14
Supported Standards		19
Approved Memory Cards		19
Index		22

Parts of the Camera and Basic Operations

Parts of the Camera

The Camera Body

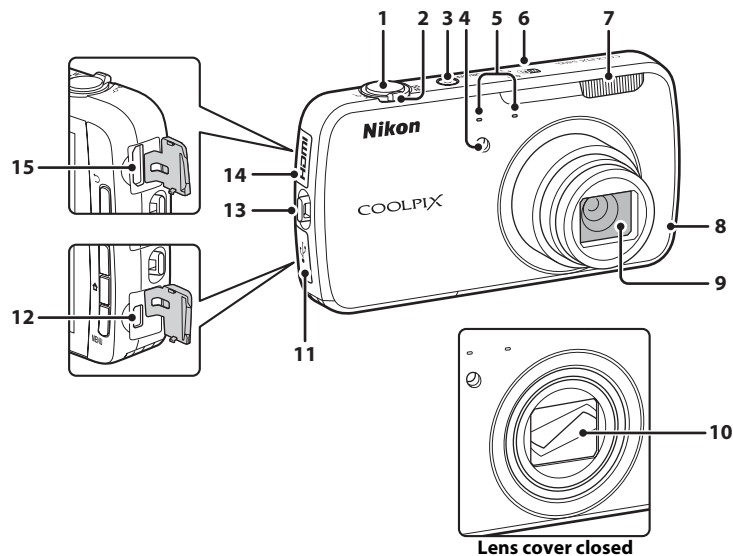

1	Shutter-release button.....	24	7	Flash.....	44
2	Zoom control.....	23	8	Wi-Fi (wireless LAN)/ Bluetooth antenna	
	W : wide-angle	23	9	Lens	
	T : telephoto	23	10	Lens cover	
	: thumbnail playback.....	62	11	USB connector cover	14, 64, 66
	: playback zoom.....	61	12	USB connector	14, 64, 66
3	Power switch/power-on lamp.....	18	13	Eyelet for camera strap	3
4	Self-timer lamp	46	14	HDMI connector cover.....	64, 15
5	AF-assist illuminator.....	75, 59	15	HDMI mini connector (Type C)	64, 15
6	Microphone (stereo).....	69			
	GPS antenna.....	64			

Parts of the Camera

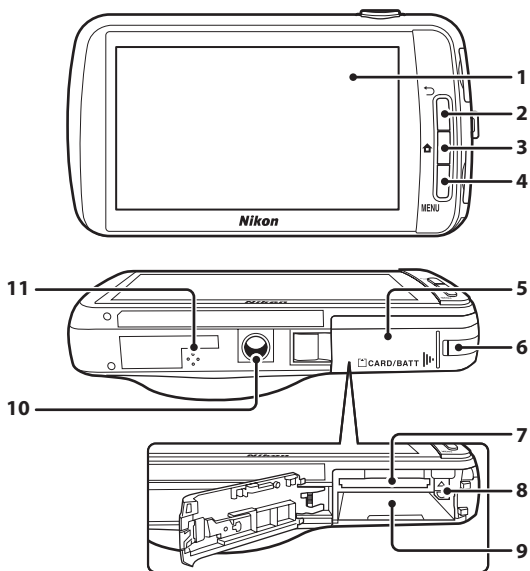

1	OLED monitor (monitor)*/ touch panel.....6	7	Memory card slot..... 16
2	↶ (back) button.....3	8	Battery latch..... 12, 13
3	🏠 (home) button 3, 88	9	Battery-chamber 12
4	MENU (menu) button..... 3, 52, 63, 92	10	Tripod socket
5	Battery chamber/ memory card slot cover 12, 16	11	Speaker 73
6	Power connector cover (for connection with optional AC Adapter)  76		

* Referred to simply as the “monitor” in this manual.

Using the Camera Buttons

Use the method described below.

↶ (back) button

- Press the ↶ (back) button to return to the previous screen.
- A message is displayed when you press the ↶ (back) button on the shooting screen. To return to the shooting screen, press the shutter-release button halfway. To exit shooting mode, press the ↶ (back) button again. When you exit shooting mode, the Android™ platform home screen is displayed (📖88).

🏠 (home) button

- The home screen (📖88) is displayed when you press the 🏠 (home) button. To quit shooting, press the 🏠 (home) button.
- To display the screen showing the most recently used applications, press and hold the 🏠 (home) button for a few seconds on the home screen (📖88).
- To turn on the camera and display the home screen (📖88), press and hold the 🏠 (home) button for a few seconds while the camera is off.

MENU (menu) button

- Press the MENU button to display menus. The shooting menu or playback menu is displayed when using the camera, and the option menu is displayed when using Android™ platform. Tap a menu option to select it.

Attaching the Camera Strap

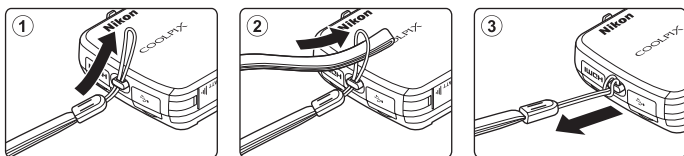

Operating the Touch Panel

The monitor on the COOLPIX S800c is a touch panel display operated by finger. Use the method described below.

Tapping

Tap the touch panel.

Use this operation to:

- Select icons
- Select images in thumbnail playback mode (📖62)
- Perform touch shutter, touch AF/AE, or subject tracking operations (📖53)

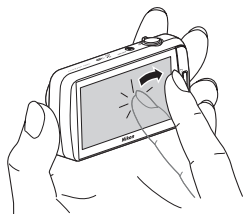

Touching and Holding

Place your finger on an item or icon, and hold it there for several seconds.

Use this operation to:

- Edit text (📖87)

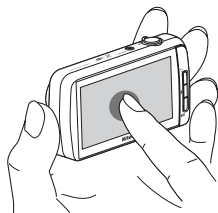

Dragging

Drag your finger across the touch panel and remove it from the touch panel.

Use this operation to:

- Scroll through images in full-frame playback mode (📖26)
- Move the visible portion of an image enlarged with playback zoom (📖61)
- Move sliders such as when adjusting exposure compensation (📖49)

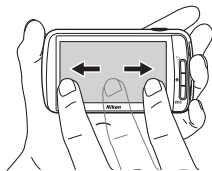

Spreading/Pinching

Spread two fingers apart/pinch two fingers together.

Use this operation to:

- Zoom in/out on an image (📖61) in playback mode
- Switch to thumbnail playback mode from full-frame playback mode (📖62)

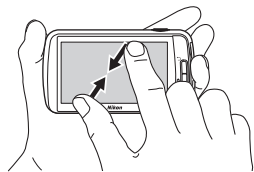
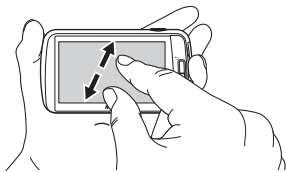

Flicking

Place your finger on the touch panel and quickly move it up, down, right, or left and release it to scroll.

Use this operation to:

- Switch the screen (📖89)

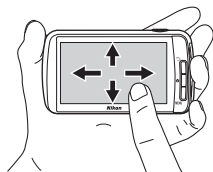

✔ Notes About the Touch Panel

- This camera utilizes a static touch panel. Therefore, it may not respond when touched with fingernails or gloved fingers.
- Do not press on the touch panel with pointed objects.
- Do not apply unnecessary pressure to the touch panel.
- The touch panel may not respond to touch if a commercially available protecting film is applied.

✔ Notes About Touch Panel Operations

- The camera may not respond if your finger is left in one place too long.
- The camera may not respond if the followings are made.
 - Bounce your finger off the display
 - Drag your finger over too short a distance
 - Stroke the display too lightly
 - Move your finger too quickly
 - Fail to move both fingers simultaneously when spreading or pinching
- The camera may not respond if something else is touching the touch panel when your finger touches it.

Indicators and Operations of the Monitor/Touch Panel

Shooting Mode (Information Indicators)

- The information displayed in the monitor varies depending on the camera settings or status.

By default, the information is displayed when the camera is turned on and when the camera is being operated, and some of the information is hidden after a few seconds (when **Photo info** is set to **Auto info** in **Monitor settings** (74)).

Tap **DISP** to display the information again.

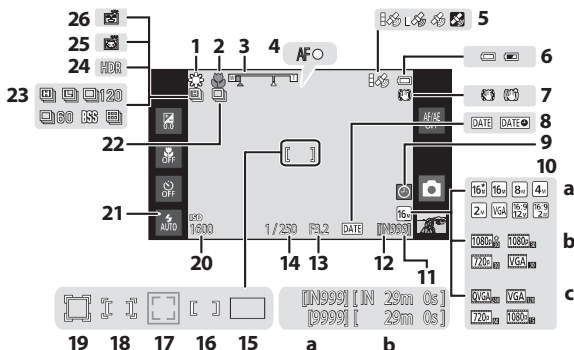

1	White balance	53,	38
2	Macro mode		48
3	Zoom indicator	23, 48	
4	Focus indicator		24
5	GPS reception status	76,	65
6	Battery level indicator		18
7	Vibration reduction icon	75,	58
8	Print date indicator	74, 85,	57
9	"Date not set" indicator	79,	77
10	a Image mode	53,	26
	b Movie options (normal speed movies)	72,	52
	c Movie options (HS movies)	72,	53
11	a Number of exposures remaining (still images)	18,	27
	b Movie length	69, 71	
12	Internal memory indicator	18, 69	
13	Aperture	24, 57	

14	Shutter speed	24, 57	
15	Focus area (auto)		57
16	Focus area (center)		
17	Focus area (face or pet detection)	39, 57, 58	
18	Focus area (touch AF/AE)	53, 60,	33
19	Focus area (subject tracking)	53,	31
20	ISO sensitivity	53,	35
21	Flash indicator		44
22	Continuous shooting (when using pet portrait scene mode)		39
23	Continuous shooting (when using auto shooting mode)	53,	36
24	Backlighting (HDR)		37
25	Pet portrait auto release		39
26	Smile timer	54,	41

Shooting Mode (Operation Controls)

Tap the following icons to change the camera mode or settings.

- Press the **MENU** button to display the menu options and shooting settings can be changed (📖2).
- The available controls and the setting status displayed vary depending on the shooting mode and the current camera settings.

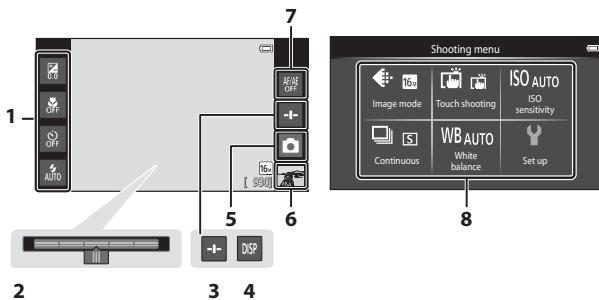

1 Basic shooting settings¹44, 46, 48, 49

2 Scene effect adjustment slider 33

3 Slider display (scene effect adjustment)
..... 33

4 Information redisplay.....6

5 Shooting mode²

.....10, 20, 30, 31, 32, 40, 41, 69

6 Playback mode (switch to playback mode)³ 10, 26

7 Touch AF/AE cancellation
.....53, 60, 📷33

8 Menu options¹52

¹ Each icon also indicates the current setting.

² Icons displayed vary depending on current shooting mode.

³ 📷 is displayed when no images or movies have been recorded.

Playback Mode (Information Display)

- The information displayed in the monitor varies depending on the image played back and the current camera status.

By default, the information is displayed when the camera is turned on and when the camera is being operated, and is hidden after a few seconds (when **Photo info** is set to **Auto info** in **Monitor settings** (📖74)). Tap the monitor to display the information again.

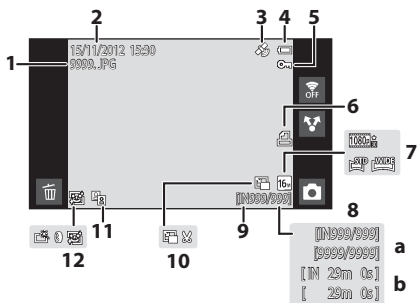

1 File number and type 📷75

2 Date/time of recording..... 84

3 Recorded GPS data indicator 📷65

4 Battery level indicator..... 18

5 Protect icon.....63, 📷44

6 Print order icon.....63, 📷46

7 Image mode*53, 📷26

7 Movie options*.....72, 📷52

Easy panorama icon 38, 📷4

8 **a** Current frame number/
total number of frames 26

b Movie length 73

9 Internal memory indicator..... 26, 69

10 📷 Small picture icon..... 63, 📷12

10 📷 Crop icon 61, 📷13

11 📷 D-Lighting icon..... 63, 📷8

12 📷 Quick retouch icon63, 📷7

12 📷 Filter effects icon..... 63, 📷9

12 📷 Skin softening icon 63, 📷11

* Icons displayed vary depending on the setting used for shooting.

Playback Mode (Operation Controls)

Tap the following icons to change the camera mode or settings.

- Press the **MENU** button to display the menu options (☰) and editing will be available.
- The available controls and the setting status displayed vary depending on the displayed image and the current camera settings.

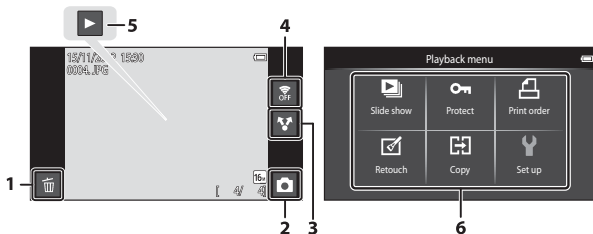

1	🗑️ (delete)..... 28	4	📶 (Wi-Fi settings)..... 77
2	Shooting mode (switch to shooting mode)*..... 10, 26	5	Movie playback..... 73 Easy panorama playback..... 38, 📷 4
3	📶 (share)..... 77	6	Menu options 63

* Icons displayed vary depending on the shooting mode.

Switching Between Shooting Mode and Playback Mode

The camera has 2 modes of operation: shooting mode, which is used for taking images, and playback mode, which is used for viewing images.

To switch to playback mode, tap the playback mode icon.

To switch to shooting mode, tap the shooting mode icon.

- While using playback mode, you can also switch to shooting mode by pressing the shutter-release button.

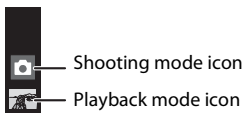

Shooting mode

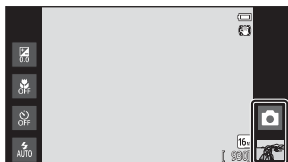

Playback mode

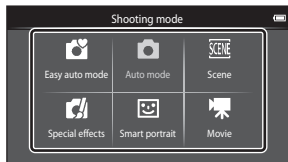
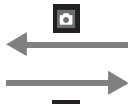
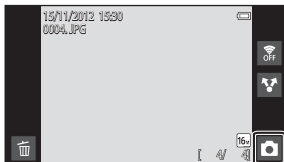

Shooting mode menu

- If you tap the shooting mode icon in shooting mode, the shooting mode menu is displayed, from which you can select one of the available shooting modes.
- Tap an icon to select a shooting mode.

Switching the Horizontal/Vertical Screen Rotation

Rotate the camera itself to automatically switch the screen orientation, as shown below (except when shooting mode and movie playback).

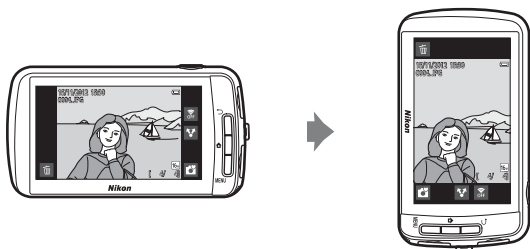

Basic Steps for Shooting and Playback

Preparation 1 Insert the Battery

- 1 Open the battery-chamber/memory card slot cover.

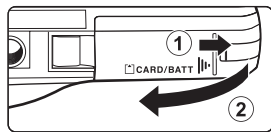

- 2 Insert the included EN-EL12 battery (rechargeable Li-ion battery).

- Use the edge of the battery to push the orange battery latch in the direction indicated by the arrow (1), and fully insert the battery (2).
- When the battery is inserted correctly, the battery latch will lock the battery in place.

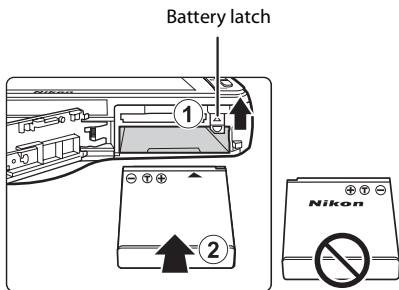

✓ Inserting the Battery Correctly

Inserting the battery upside down or backwards could damage the camera. Be sure to check that the battery is in the correct orientation.

- 3 Close the battery-chamber/memory card slot cover.

- Charge the battery before first use or when it is running low. See page 14 for more information.

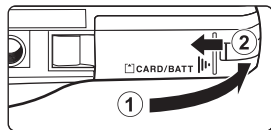

Removing the Battery

Turn the camera off and be sure that the power-on lamp and monitor have turned off before opening the battery-chamber/memory card slot cover.

Slide the orange battery latch in the direction indicated by the arrow (①), to partially eject the battery. Pull the battery straight out of the camera (②); do not pull it at an angle.

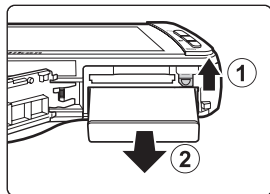

High Temperature Caution

The camera, battery, or memory card may be hot immediately after using the camera. Observe caution when removing the battery or memory card.

Note About the Battery

Be sure to read and follow the warnings for the battery on page vii and in the section, "The Battery" (Ⓒ:3), before use.

Preparation 2 Charge the Battery

1 Prepare the included Charging AC Adapter EH-69P.

If a plug adapter* is included with your camera, attach the plug adapter to the plug on the Charging AC Adapter. Push the plug adapter firmly until it is securely held in place. Once the two are connected, attempting to forcibly remove the plug adapter could damage the product.

* The shape of the plug adapter varies depending on the country or region in which the camera was purchased.

The Charging AC Adapter comes with the plug adapter attached in Argentina and Korea.

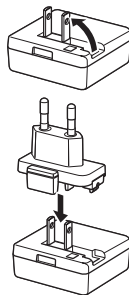

2 Make sure the battery is installed in the camera, and then connect the camera to the Charging AC Adapter in the order indicated by the numbers in the illustration below.

- Keep the camera turned off.
- Be sure that plugs are properly oriented. Do not attempt to insert plugs at an angle, and do not use force when connecting or disconnecting the plugs.

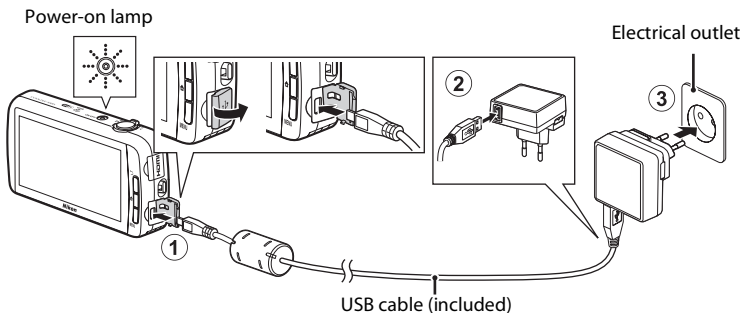

- The power-on lamp slowly flashes orange to indicate that the battery is charging.
- About 4 hours are required to charge a fully exhausted battery.
- When the battery is fully charged, the power-on lamp stops flashing and turns off.
- See "Understanding the Power-on Lamp" (📖15) for more information.

3 Disconnect the Charging AC Adapter from the electrical outlet, and then disconnect the USB cable.

- When the camera is connected to an electrical outlet with the Charging AC Adapter, the camera cannot be turned on.

Understanding the Power-on Lamp

Status	Description
Flashes slowly	The battery is charging.
Off	The battery is not charging. When charging is complete, the power-on lamp stops flashing and turns off.
Flashes quickly	<ul style="list-style-type: none"> The ambient temperature is not suited to charging. Charge the battery indoors with an ambient temperature of 5°C to 35°C (41°F to 95°F). The USB cable or Charging AC Adapter is not properly connected, or there is a problem with the battery. Disconnect the USB cable or unplug the Charging AC Adapter and correctly connect it again, or change the battery.

Note About Charging AC Adapter

Be sure to read and follow the warnings for the Charging AC Adapter on page vii and in the section, “Charging AC Adapter” (2-4), before use.

Charging Using Battery Charger

The Battery Charger MH-65 (available separately; 76) can be used to charge Rechargeable Li-ion Battery EN-EL12 without the camera.

AC Power Source

- If the AC Adapter EH-62F (available separately; 76) is used, COOLPIX S800c can be powered from an electrical outlet and operated for shooting or playback.
- Do not, under any circumstances, use another make or model of AC adapter other than the EH-62F. Failure to observe this precaution could result in overheating or in damage to the camera.

Preparation 3 Insert a Memory Card

- 1 Be sure that the power-on lamp and monitor are off before opening the battery-chamber/memory card slot cover.

- Be sure to turn off the camera before opening the cover.

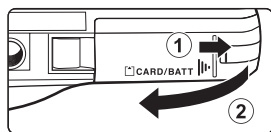

- 2 Insert the memory card.

- Slide the memory card in the correct orientation until it clicks into place.

✓ Inserting the Memory Card Correctly

Inserting the memory card upside down or backwards could damage the camera or memory card. Be sure that the memory card is in the correct orientation.

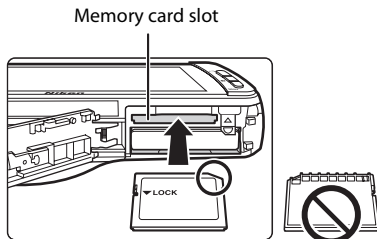

- 3 Close the battery-chamber/memory card slot cover.

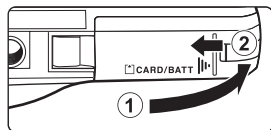

✓ Formatting a Memory Card

- The first time you insert a memory card that has been used in another device into this camera, be sure to format it with this camera.
- **All data stored on a memory card is permanently deleted when the card is formatted.** Be sure to transfer important images to a computer and save them before formatting.
- To format a memory card, insert the memory card into the camera, go to the Android™ platform setting menu (📖91), and select **Storage** followed by **Erase SD card**.

✓ Note About Memory Cards

- SDXC memory cards are not supported. For more information about the types of memory cards that are supported, see “Approved Memory Cards” (🔧19) in “Specifications”.
- Refer to the documentation included with the memory card, as well as “Memory Cards” (🔧4) in “Maximizing Camera Life and Performance”.

Removing the Memory Card

Turn the camera off and be sure that the power-on lamp and monitor have turned off before opening the battery-chamber/memory card slot cover.

Gently push the memory card into the camera (①) to partially eject the card, and then remove the card. Pull the memory card straight out of the camera (②); do not pull it at an angle.

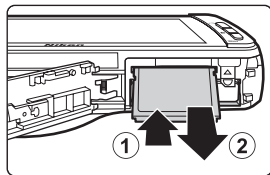

✓ High Temperature Caution

The camera, battery, or memory card may be hot immediately after using the camera. Observe caution when removing the battery or memory card.

Internal Memory and Memory Cards

Camera data, including still images and movies, can be saved in either the camera's internal memory (approximately 1.7 GB) or on a memory card. To use the camera's internal memory for shooting or playback, first remove the memory card.

Step 1 Turn the Camera On

- 1** Press the power switch to turn on the camera.

If you are turning the camera on for the first time after purchase, see “When Turning On the Camera for the First Time” (📖79) for more information.

- For the second and subsequent times, the shooting screen is displayed when you press and hold the power switch to turn on the camera. You can start taking images immediately, but you are limited to taking only a few pictures and cannot change the settings until the playback mode icon is displayed.

See “Power Supply Status and Power Saving Function” (📖19) for more information.

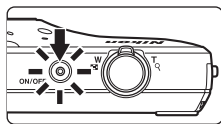

Playback mode icon

- 2** Check the battery level indicator and the number of exposures remaining.

Battery level indicator



Number of exposures remaining

Battery Level Indicator

Indicator	Description
	The battery level is high.
	The battery level is low. Prepare to charge or replace the battery.
 Battery exhausted.	Cannot take images. Charge or replace the battery.

Number of Exposures Remaining

The number of images that can be taken is displayed.

- If a memory card is not inserted, **IN** is displayed to indicate that images will be saved in the camera's internal memory (approximately 1.7 GB).
- The number of exposures remaining varies depending on whether you are using the camera's internal memory or a memory card, and also varies depending on the image quality and image size (image mode) setting (📖53).
- The number of exposures remaining shown in the illustrations may differ from the actual display.

Power Supply Status and Power Saving Function

The COOLPIX S800c's power supply status options are listed below. To ensure longer battery life, it is recommended to use the display off and stand by power saving functions in order to minimize battery power consumption when the COOLPIX S800c is not being used.



Status	Description
On	Press the power switch when you want to use the camera. You are limited to taking only a few pictures and cannot change the settings until Android™ OS starts up completely. When the camera switches to the normal shooting mode, the playback mode icon is displayed. Press the  (home) button when you want to use the Android™ OS.
Display off	The monitor turns off if no operations are performed for 1 minute (default setting) ¹ , and battery power consumption is reduced. The camera enters stand by mode if no further operations are performed for 1 minute (fixed setting).
Stand by ³	The camera enters stand by mode if you press the power switch while the camera is turned on, or if no operations are performed in display off mode for 1 minute. Each function enters stand by mode, and battery power consumption is greatly reduced. The camera turns off after 1 hour (default setting) ² elapses.
Off ³	The camera turns off if you press and hold the power switch, or if the camera remains in stand by mode for 1 hour (default setting). The power-on lamp flashes while the camera is in the process of turning off. Wait for the power-on lamp to turn off.

¹ You can set the amount of time via the **Display off** option in **Display** in the Android™ platform setting menu (📖91).



² You can set the amount of time via the **Shut-down timer** option in the setup menu (📖74).

³ Unsaved data is lost when the camera turns off. Save the data you want to keep before the camera enters stand by mode, or before you press and hold the power switch to turn off the camera.

To Turn the Camera Back On

Status	Description
Display off	To turn the monitor back on, press the power switch, shutter-release button,  (back) button,  (home) button or MENU button.
Stand by	Press the power switch.
Off	Press and hold the power switch to turn the camera off. Press and hold the  (home) button to turn on the camera and display the home screen (📖88).

Turning Off Functions to Save Power

Battery power consumption is increased when the Wi-Fi (wireless LAN) function, Bluetooth function and GPS function (when in shooting mode) are turned on. To reduce battery power consumption, it is recommended that you turn these functions off (📖81, , , ) when you are not using them.



Step 2 Select a Shooting Mode

1 Tap the shooting mode icon.





- The shooting mode menu, which allows you to select the desired shooting mode, is displayed.

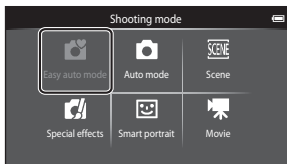

2 Tap the desired shooting mode icon.

-  (easy auto) mode is used in this example. Tap  **Easy auto mode**.



- The camera enters  (easy auto) mode. The shooting mode icon changes to , , , or  depending on the current subject and framing.
- See page 6 for information about the icons in the monitor.
- The shooting mode setting is saved even after the camera is turned off.





Available Shooting Modes

Easy auto mode 30

By simply framing an image, the camera automatically selects the optimum shooting mode.

Auto mode 31

 (auto) mode is useful for general photography, and it allows you to adjust a variety of settings in the shooting menu (53) to suit the shooting conditions and the type of shot you want to capture.

Scene 32

When a shooting scene is selected, the camera settings are optimized to take images for that type of scene.

- To select a scene mode, tap the icon of the desired scene mode in the shooting mode menu.

Special effects 40

Effects can be applied to images during shooting. 5 different effects are available.

- To select an effect, first display the shooting mode menu and then tap the icon of the desired effect.



Smart portrait 41

The camera detects human faces and automatically releases the shutter when they smile (smile timer). The skin softening option can make skin tones of human faces appear smoother.

Movie 69

Shoot movies with sound recorded via the built-in microphone.

Features Available in Each Shooting Mode

- You can change the settings for the flash mode, self-timer, macro mode, and exposure compensation. See “Basic Shooting Settings” (43) for more information.
- When using shooting mode, press the **MENU** button (2) to display the menu for the selected mode. See “Functions That Can Be Set with the **MENU** (Menu) Button (Shooting Menu)” (52) for information about the menu options available for the current shooting mode.

Recording Position Information for Images

To record position information for images, set **Record GPS data** to **On** in **GPS options** in the setup menu (74).

Step 3 Frame a Picture

1 Hold the camera steadily in both hands.

- Keep fingers and other objects away from the lens, flash, AF-assist illuminator, and microphone.
- When taking images in portrait ("tall") orientation, turn the camera so that the built-in flash is above the lens.

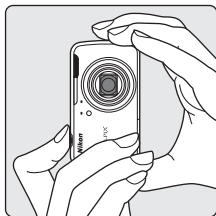
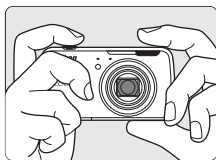

2 Frame the picture.

- When the camera automatically selects the optimum scene mode, the shooting mode icon changes (📖30).
- When the camera detects a face, that face will be framed by a yellow double border (focus area). See "Face Detection" (📖58) for more information.
- When taking images of subjects other than people, or when framing a subject with which no face is detected, a focus area is not displayed. Frame the picture so that the intended subject is at or near the center of the frame.





Shooting mode icon

✓ Notes About 📷 (Easy Auto) Mode

- The desired scene mode may not be selected in certain condition. In this case, select another shooting mode.
- When digital zoom is in effect, 📷 is selected as the shooting scene.

Using a Tripod

- We recommend using a tripod to stabilize the camera when shooting in the following situations:
 - When shooting in dim lighting or when the flash mode () is set to  (Off).
 - When using the telephoto setting.
- Set **Vibration reduction** in the setup menu () to **Off** when using a tripod to stabilize the camera during shooting.

Using the Zoom

Use the zoom control to activate optical zoom.

- To zoom in closer to the subject, rotate the zoom control to **T** (telephoto).
- To zoom out and view a larger area, rotate the zoom control to **W** (wide-angle).

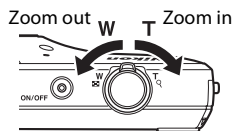

When you turn the camera on, the zoom moves to the maximum wide-angle position.

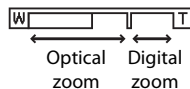

- A zoom indicator is displayed at the top of the monitor when the zoom control is rotated.
- Digital zoom, which allows you to magnify the subject up to approximately 4x beyond the maximum magnification of the optical zoom, can be activated by rotating and holding the zoom control to **T** when the camera is zoomed in to the maximum optical zoom position.



Digital Zoom and Interpolation

While using digital zoom, the image quality decreases due to interpolation when the zoom is increased beyond the  position. Since the position of  moves to the right as the size of an image decreases, selecting a smaller image size in the image mode setting () allows you to zoom in further without decreasing the image quality due to interpolation.



Step 4 Focus and Shoot

1 Press the shutter-release button halfway (i.e., press the button slightly until you feel resistance).

- When you press the shutter-release button halfway, the camera sets the focus and exposure (shutter speed and aperture value). Focus and exposure remain locked while the shutter-release button is pressed halfway.
- Once focus is acquired, the focus area glows green. See “Focus Area” (📖57) for more information.
- When digital zoom is used, the focus area is not displayed and the camera focuses at the center of the frame. Once focus is acquired, the focus indicator (📖6) glows green.
- If the focus area or the focus indicator flashes red when the shutter-release button is pressed halfway, the camera is unable to focus. Modify the composition and press the shutter-release button halfway again.

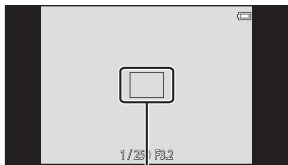
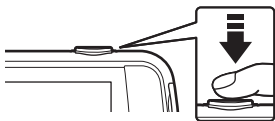

2 Press the shutter-release button all the way (i.e., press the button the rest of the way down).

- The shutter is released and the image will be recorded to the memory card or internal memory.
- If you press the shutter-release button with too much force, the camera may shake, causing images to be blurred. Press the button gently.



Note About Recording Images

The indicator showing the number of exposures remaining flashes while images are being recorded. **Do not open the battery-chamber/memory card slot cover or remove the battery or memory card** while the indicator is flashing. Doing so could result in loss of data or damage to the camera or the memory card.

Subjects Not Suitable for Autofocus

Autofocus may not perform as expected in the following situations. In some rare cases, the subject may not be in focus despite the fact that the focus area or the focus indicator glows green.



- Subject is very dark
- Objects of sharply differing brightness are included in the scene (e.g. the sun behind the subject makes that subject appear very dark)
- No contrast between the subject and surroundings (e.g. a portrait subject wearing a white shirt is standing in front of a white wall)
- Several objects are at different distances from the camera (e.g. the subject is inside a cage)
- Regular geometric patterns (e.g. window blind or windows on a skyscraper)
- Subject is moving rapidly

In the situations noted above, try pressing the shutter-release button halfway to refocus several times, or try focusing on another subject that is at the same distance from the camera as the intended subject (60).

Touch Shooting

The active focus area can be changed when using touch shooting. At the default setting, the shutter can be released by simply tapping a subject in the monitor (53) without pressing the shutter-release button.



AF-assist Illuminator and Flash

If the subject is poorly lit, the AF-assist illuminator (75) may light when the shutter-release button is pressed halfway, or the flash (44) may fire when the shutter-release button is pressed all the way down.

To Make Sure You Do Not Miss a Shot

If you are concerned that you might miss a shot, press the shutter-release button all the way without first pressing it halfway.

Motion Detection

In  (easy auto) mode or  (auto) mode, when the camera detects subject movement or camera shake, ISO sensitivity and shutter speed are increased to reduce blurring. In this case, the shutter speed indicator turns green.

Step 5 Play Back Images

1 Tap the playback mode icon.

- The camera enters playback mode, and the last image taken is displayed in full-frame playback mode.

Shooting

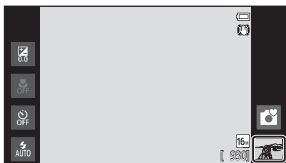

Playback

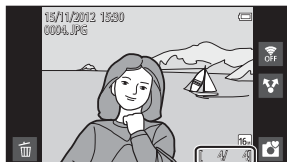

Current image number/total number of images

- To play back images that are saved in the internal memory, remove the memory card. **IN** is displayed in place of the "current image number/total number of images" indicator.

2 Drag the current image to display the previous or next image.

- To display the previous image, drag the image to the right.
- To display the next image, drag the image to the left.
- Tap the shooting mode icon (📷) displayed at the bottom right of the monitor or press the shutter-release button to return to shooting mode.



Viewing Images

- The previous or next image may appear briefly at low resolution immediately after it is dragged into view.
- When using playback mode, images are automatically rotated for display according to the orientation of the camera when they are taken. The orientation of images can be changed using **Rotate image** (📖63).
- Images taken in vertical orientation may appear blurry when enlarged in horizontal orientation.

More Information

- See "Playback Zoom" (📖61) for more information.
- See "Thumbnail Playback" (📖62) for more information.
- See "Functions That Can be Set with the **MENU** Button (Playback Menu)" (📖63) for more information.
- See "Sharing Images" (📖77) for more information.

Step 6 Delete Unwanted Images

- 1 Play back an image to delete and tap .



- 2 Tap the desired delete option.

- **Current image:** Delete the currently displayed full-frame image.
- **Erase selected images:** Select multiple images and delete them. See "Operating the Erase Selected Images Screen" (📖29) for more information.
- **All images:** Delete all images.
- If step 1 is performed in thumbnail playback mode (📖62), select either **Erase selected images** or **All images**.

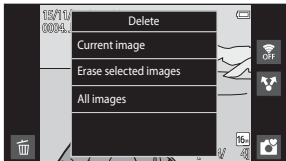

- 3 Tap **Yes** in the delete confirmation dialog.

- Deleted images cannot be recovered.
- To exit without deleting the image, tap **No** or press the ⏪ (back) button.

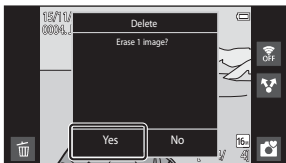



✓ Notes About Deleting Images

- Once deleted, images cannot be recovered. Transfer important images to a computer or other media before deleting them.
- Protected images (📖63) cannot be deleted.
- If you press the 🏠 (home) button while the camera is deleting images, the deletion process stops and the Android™ platform home screen is displayed. Do not perform any operations until the message disappears.

Operating the Erase Selected Images Screen

1 Tap an image to display .

- To deselect the image, tap the image again and  will be removed.
- Drag the screen up or down to scroll through the images.
- Rotate the zoom control to **T** () or **W** () to change the number of images displayed.



2 Add to all images to delete and tap to apply the selection.





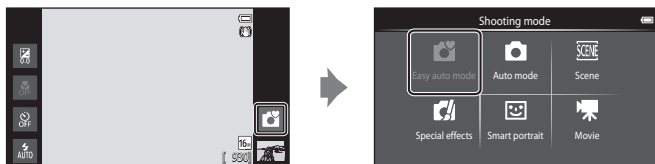

- The confirmation screen is displayed. Follow the on-screen instructions to complete the operation.

Shooting Features

(Easy Auto) Mode

When you frame a picture, the camera automatically selects the optimum scene from the list below, allowing you to easily take images using a shooting mode that suits the scene.



- : Portrait
 - : Landscape
 - : Night portrait
 - : Night landscape
- : Close-up
 - : Backlighting
 - : Other shooting scenes

- When digital zoom is in effect,  is selected as the shooting scene.
- Active focus areas change depending on the selected scene. If a human face is detected, the camera focuses on it. See “Face Detection” (📖58) for more information. When the camera detects any faces, the shutter can be released by tapping a detected face framed by a border.
- The active focus area can be changed when using touch shooting. At the default setting, the shutter can be released simply by tapping a subject in the monitor (touch shutter) (📖53) without pressing the shutter-release button.

Changing the (Easy Auto) Mode Settings

- You can change the settings for the flash mode, self-timer, and exposure compensation. See “Basic Shooting Settings” (📖43) for more information.
- Press the **MENU** button (📖2) to display the available menu options in  (easy auto) mode. See “Shooting Menu Options” (📖53) for more information.

(Auto) Mode

 (auto) mode is useful for general photography, and it allows you to adjust a variety of settings in the shooting menu ([book 53](#)) to suit the shooting conditions and the type of shot you want to capture.

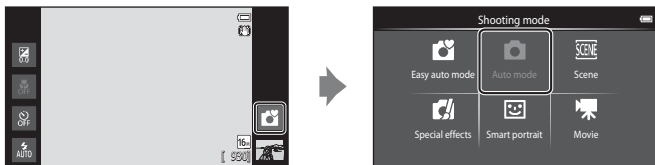

- If the camera detects a human face, the camera automatically focuses on it. When no face is detected, the camera automatically selects one (or more) of the 9 focus areas containing the subject closest to the camera. See “Focusing on Subjects” ([book 57](#)) for more information.
- The active focus area can be changed when using touch shooting. At the default setting, the shutter can be released simply by tapping a subject in the monitor (touch shutter) ([book 53](#)) without pressing the shutter-release button. The **Subject tracking** option, which moves the active focus area to track the registered subject, can be enabled ([book 53](#)).

Adjusting the (Auto) Mode Settings

- You can change the settings for the flash mode, self-timer, macro mode, and exposure compensation. See “Basic Shooting Settings” ([book 43](#)) for more information.
- Press the **MENU** button ([book 2](#)) to display the available menu options in  (auto) mode. See “Shooting Menu Options” ([book 53](#)) for more information.

Scene Mode (Shooting Suited to Scenes)

You can take images with the optimal camera settings for the subject type by selecting the shooting scene from the list below.

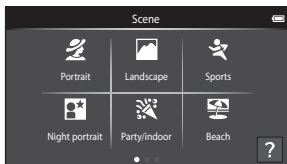
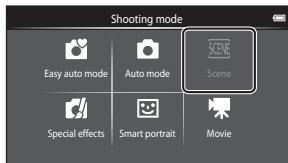

To select a scene, tap the desired scene icon on the screen shown at the left.

Portrait (34)	Landscape (34)	Sports (34)	Night portrait (35)
Party/indoor (35)	Beach (35)	Snow (35)	Sunset (35)
Dusk/dawn (35)	Night landscape (36)	Close-up (36)	Food (36)
Fireworks show (37)	Black and white copy (37)	Backlighting (37)	Easy panorama (38)
Pet portrait (39)			

Viewing a Description (Help Information) of Each Scene

When is tapped on the scene selection screen, the help selection screen is displayed. Tap a scene icon to display a description of the features of that mode. To return to the previous screen, tap **OK** or press the (back) button.

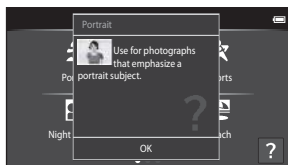

Changing the Scene Mode Settings

- You can change the settings for the flash mode, self-timer, macro mode, and exposure compensation for some scenes. See “Basic Shooting Settings” (📖43) and “Default Settings” (📖50) for more information.
- Press the **MENU** button (📖2) to display the available menu options in scene mode. See “Shooting Menu Options” (📖53) for more information.











Adjusting Scene Effect

The scene effect adjustment slider is displayed by tapping  in the scene modes listed below.

- Tap or drag the scene effect adjustment slider to adjust the degree of effect to be applied to images taken in the selected scene mode.
- After you finish making the adjustment, tap  to hide the scene effect adjustment slider.



Scene effect adjustment slider

 Food	  More blue More red
 Landscape,  Close-up	  Less vivid More vivid
 Sunset,  Dusk/dawn	  More blue More red

The changes made to the scene effects are stored in the camera's memory even after the camera is turned off.

Selecting a Scene Mode (Features)

Portrait

- The camera detects a human face and focuses on it (📖58).
- The camera smoothes skin tones by applying the skin softening function (📖54).
- If no faces are detected, the camera focuses on the subject at the center of the frame.
- Digital zoom is not available.
- The camera continuously adjusts focus even when the shutter-release button is not pressed halfway. As a result, you may hear the sound of the lens focus motor.



Landscape

- When the shutter-release button is pressed halfway, the focus areas or focus indicator (📖6) always glows green.
- Use the scene effect adjustment slider (📖33) to adjust image saturation.

Sports

- The camera focuses on the subject at the center of the frame. The focus area can be changed with the touch shutter or touch AF/AE option (📖53).
- When the shutter-release button is held down, up to 3 images are taken at a rate of about 8 frames per second (fps) when image mode is set to  **4608x3456**.
- The camera continuously adjusts focus even when the shutter-release button is not pressed halfway. As a result, you may hear the sound of the lens focus motor.
- During continuous shooting, focus, exposure, and white balance are fixed at the values determined with the first image in each series.
- The frame rate with continuous shooting may vary depending on the current image mode setting, the memory card used, or shooting conditions.
- Continuous shooting is disabled and only one image can be taken at a time when the shutter is released using the touch shutter function (📖53).

Use of a tripod is recommended in the scene modes indicated with , due to the slow shutter speeds. Set **Vibration reduction** in the setup menu (📖74) to **Off** when using a tripod to stabilize the camera during shooting.

 Night portrait 

- The flash always fires.
- The camera detects a human face and focuses on it. See page 58 for more information.
- The camera smooths skin tones by applying the skin softening function (📖54).
- If no faces are detected, the camera focuses on the subject at the center of the frame.
- Digital zoom is not available.

 Party/indoor

- The camera focuses on the subject at the center of the frame. The focus area can be changed with the touch shutter or touch AF/AE option (📖53).
- Hold the camera steadily. If you use a tripod to stabilize the camera, Set **Vibration reduction** to **Off** in the setup menu (📖74).

 Beach



- The camera focuses on the subject at the center of the frame. The focus area can be changed with the touch shutter or touch AF/AE option (📖53).

 Snow

- The camera focuses on the subject at the center of the frame. The focus area can be changed with the touch shutter or touch AF/AE option (📖53).

 Sunset 

- The camera focuses on the subject at the center of the frame.
- Use the scene effect adjustment slider (📖33) to adjust image color.

 Dusk/dawn 

- When the shutter-release button is pressed halfway, the focus areas or focus indicator (📖6) always glows green.
- Use the scene effect adjustment slider (📖33) to adjust image color.

Night landscape



- When the shutter-release button is pressed halfway, the focus areas or focus indicator (📖6) always glows green.

Close-up

- Macro mode (📖48) is enabled and the zoom automatically moves to the possible closest shooting position.
- The camera focuses on the subject at the center of the frame. The focus area can be changed with the touch shutter or touch AF/AE option (📖53).
- Use the scene effect adjustment slider (📖33) to adjust image saturation.
- The camera continuously adjusts focus even when the shutter-release button is not pressed halfway. As a result, you may hear the sound of the lens focus motor.

Food

- Macro mode (📖48) is enabled and the zoom automatically moves to the possible closest shooting position.
- The camera focuses on the subject at the center of the frame. The focus area can be changed with the touch shutter or touch AF/AE option (📖53).
- Use the scene effect adjustment slider to adjust the influence lighting has on the color of the subject (📖33).
- The camera continuously adjusts focus even when the shutter-release button is not pressed halfway. As a result, you may hear the sound of the lens focus motor.



Use of a tripod is recommended in the scene modes indicated with , due to the slow shutter speeds. Set **Vibration reduction** in the setup menu (📖74) to **Off** when using a tripod to stabilize the camera during shooting.

Fireworks show





- The shutter speed is fixed to 4 seconds.
- Camera focuses at infinity.
- When the shutter-release button is pressed halfway, the focus indicator () always glows green.







Black and white copy

- The camera focuses on the subject at the center of the frame. The focus area can be changed with the touch shutter or touch AF/AE option ()
- Use with macro mode () when shooting a subject at close distance.

Backlighting

- The camera focuses on the subject at the center of the frame. The focus area can be changed with the touch shutter or touch AF/AE option ()
- Press the **MENU** button () and tap **HDR HDR** to enable or disable the HDR (high dynamic range) function.
- **OFF off** (default setting): The flash fires to prevent the subject from being hidden in shadow.
 - When the shutter-release button is pressed all the way down, one image is taken.
- **ON On**: HDR processing is applied (useful when taking images with very bright and dark areas in the same frame).
 - Digital zoom is not available.
 - When the shutter-release button is pressed all the way down, the camera takes images continuously at high speed, and saves the following 2 images.
 - A non-HDR composite image
 - An HDR composite image in which the loss of details in highlights or shadows is minimized
 - The second image saved is an HDR composite image. If there is only enough memory to save one image, an image processed by D-Lighting () at the time of shooting, in which dark areas of the image are corrected, is the only image saved.
 - Once the shutter-release button is pressed all the way, hold the camera and do not move it until a still image is displayed on the shooting screen. After taking an image, do not turn the camera off before the monitor switches to the shooting screen.
 - The angle of view (i.e., the area visible in the frame) seen in the saved image will be narrower than that seen in the monitor at the time of shooting.

Easy panorama







- Allows you to take a panorama image simply by moving the camera.
- Press the **MENU** button () and tap  **Easy panorama** to select the shooting range from  **Normal (180°)** (default setting) or  **Wide (360°)**.
- Press the shutter-release button all the way down, remove your finger from the button, and then slowly pan the camera across the scene. Shooting automatically ends when the camera captures the specified shooting range.
- The camera focuses on the subject at the center of the frame when shooting starts.
- The zoom position is fixed at wide-angle.
- If you tap  when a panorama taken using easy panorama is displayed in full-frame playback mode, the image scrolls automatically.
See "Using Easy Panorama (Shooting and Playback)" () for more information.

Note About Printing Panoramas



When printing panorama images, the entire image may not be printed depending on the printer's settings. Additionally, printing may not be possible depending on the printer.

See the documentation included with the printer or consult a digital photo lab for details.

Pet portrait

- When you point the camera at a dog or cat, the camera detects the pet's face and focuses on it. By default, the shutter is automatically released when focus is acquired (pet portrait auto release).
- Press the **MENU** button () and select  **Continuous** and then select  **Single** or  **Continuous** on the screen that is displayed.
 -  **Single**: The camera takes one image at a time.
 -  **Continuous** (default setting): When focus is acquired on the detected face, the camera automatically releases the shutter 3 times. Continuous shooting speed rate: about 1.3 frames per second. When you manually release the shutter, up to 17 images can be continuously taken while the shutter-release button is held down. Continuous shooting speed rate: about 1.4 frames per second (when **Image mode** is set to  **4608x3456**).

Notes About Pet Portrait Auto Release

- To change the setting, press the **MENU** button and select  **Pet portrait auto release**.
 - **ON** (default setting): The shutter is automatically released when focus is acquired on the detected face.
 - **OFF**: The shutter is not automatically released when a pet's face is detected. Use the shutter-release button or touch shutter to release the shutter ( 53).
- **Pet portrait auto release** turns off automatically when:
 - 5 bursts have been taken.
 - Internal memory or the memory card is full.
 To continue taking images with the **Pet portrait auto release** function, press the **MENU** button and set  **Pet portrait auto release** to **On** again.

AF Areas

- When the camera detects a face, a double border (focus area) is displayed around the face, and the double border glows green when focus is acquired.
- When the camera detects multiple faces (up to five faces), the face displayed largest in the monitor is framed by a double border and the others by single borders.
- If the shutter-release button is pressed when no pet faces are detected, the camera focuses on the subject at the center of the frame.

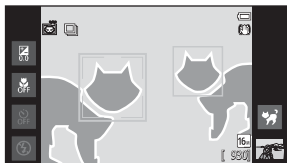



Notes About Pet Portrait Scene Mode

- Digital zoom cannot be used.
- Depending on the distance of the pet from the camera, the speed of the pet's movement, the direction the pet is facing, the ambient brightness of the pet's face, etc., the camera may not be able to detect the pet's face, or other subjects may be framed by a border.

Viewing Images Taken Using Pet Detection

In full-frame playback mode, if you enlarge an image by rotating the zoom control to **T** () the image is enlarged so that the detected face is displayed at the center of the monitor.

If the camera detected multiple faces when the image was taken, you can tap  or  to display a different face. Once you change the zoom ratio, you will be able to zoom in on an area of the image where there are no faces.

Special Effects Mode (Applying Effects When Shooting)

Effects can be applied to images during shooting.
The 5 effects listed below are available.

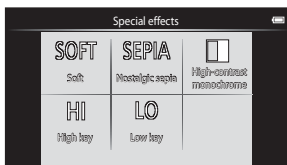
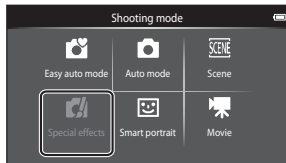
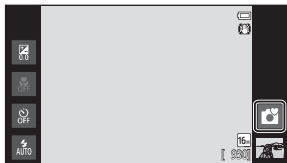

Select an effect by tapping the icon of the desired effect on the screen shown on the left.

Category	Description
SOFT Soft (default setting)	Softens the image by adding a slight blur to the entire image.
SEPIA Nostalgic sepia	Adds a sepia tone and reduces the contrast to simulate the qualities of an old photograph.
 High-contrast monochrome	Changes the image to black and white and gives it sharp contrast.
HI High key	Gives the entire image a bright tone.
LO Low key	Gives the entire image a dark tone.

Changing Special Effects Mode Settings

- You can change the settings for the flash mode, self-timer, macro mode, and exposure compensation. See “Basic Shooting Settings” (📖43) for more information.
- Press the **MENU** button (📖2) to display the available menu options in special effects mode. See “Shooting Menu Options” (📖53) for more information.

Smart Portrait Mode (Shooting Smiling Faces)

At the default setting, the camera detects faces and automatically releases the shutter when it detects a smile (smile timer). You can also use the skin softening option to smooth the skin tones in human faces. See “Skin Softening” (📖54) for more information.

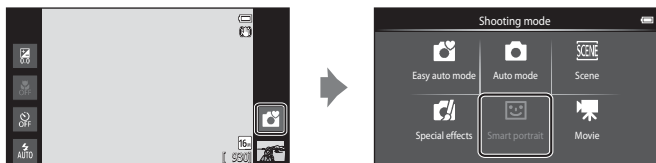

Point the camera at a human subject and wait for the subject to smile.

- When the camera detects a human face, the camera focuses on it (see “Face Detection” (📖58) for more information).
- If the camera detects that the face framed by the double border is smiling, **Smile timer** (📖54) is activated and the shutter is automatically released.
- Each time the shutter is released, the camera again initiates face detection and smile detection operations for continuous automatic shooting.
- To end automatic shooting, set **Smile timer** to **Off** or tap the shooting mode icon and switch to another shooting mode.



Notes About Smart Portrait Mode

- Digital zoom is not available.
- Under some shooting conditions, the camera may be unable to detect faces or smiles.
- See “Notes About the Face Detection Function” (📖59) for more information.

Power Saving Function When Using Smile Timer

When **Smile timer** is set to **On**, the camera enters display off mode (📖19) when either of the situations indicated below persists and no other operations are performed.

- The camera does not detect any faces.

Self-timer Lamp

The self-timer lamp flashes slowly when the smile timer is enabled and the camera detects a face, and it flashes quickly immediately after the shutter is released.

Releasing the Shutter Manually

- Images can also be taken by pressing the shutter-release button. The camera focuses on the subject at the center of the frame when faces are not detected.
- Touch shutter can be enabled when **Smile timer** is set to **Off** (📖54).

Changing the Smart Portrait Mode Settings

- You can change the settings for the flash mode, self-timer, and exposure compensation. See “Basic Shooting Settings” (📖43) for more information.
- Press the **MENU** button (📖2) to display the menu options available in smart portrait mode are displayed. See “Shooting Menu Options” (📖53) for more information.

Basic Shooting Settings

When in shooting mode, you can set the following functions by tapping the icons at the left of the monitor:

- 1 Flash mode
 - 2 Self-timer
 - 3 Macro mode
 - 4 Exposure compensation
- When the icons are hidden, tap **DISP**.

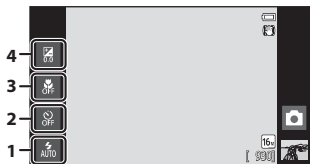

Functions Available for Each Shooting Mode

The features that are available vary with the shooting mode, as shown below.

- See “Default Settings” (📖50) for more information on the default settings in each shooting mode.

	Flash mode (📖44)	Self-timer (📖46)	Macro mode (📖48)	Exposure compensation (📖49)
📷 (easy auto) (📖30)	✓	✓	_1	✓
📷 (auto) (📖31)	✓	✓	✓	✓
SCENE (scene) (📖32)	2			
📷 (special effects) (📖40)	✓	✓	✓	✓
📷 (smart portrait) (📖41)	✓ ³	✓ ³	-	✓
🎬 (movie) (📖69)	-	-	✓	-

¹ Macro mode is enabled when 📷 is selected.

² Varies depending on the scene mode. See “Default Settings” (📖50) for more information.

³ Varies depending on the smart portrait mode settings. See “Default Settings” (📖50) for more information.

🔪 Functions That Cannot Be Used Simultaneously

Some of these settings may not be available with certain functions (📖55).

Using the Flash (Flash Modes)

You can set the flash mode to match the shooting conditions.

1 Tap the flash mode icon.

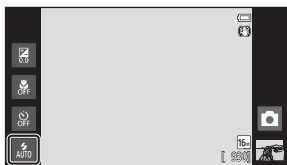

2 Tap the desired flash mode icon.

- See “Available Flash Modes” (📖45) for more information.

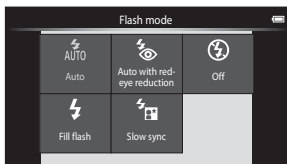

3 Frame the subject and take an image.

- The flash indicator shows flash status when the shutter-release button is pressed halfway.
 - On: Flash will fire when the shutter-release button is pressed all the way down.
 - Flashing: Flash charging. Wait a few seconds and try again.
 - Off: Flash will not fire. The flash mode icon is not displayed.
- If the battery is low, the monitor turns off, and remains off, while the flash charges.

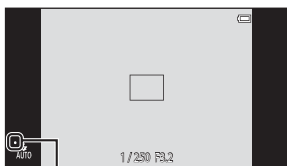







Flash indicator

Effective Range of the Flash

When ISO sensitivity is set to **Auto**, the flash has a range of 0.5-5.6 m (1 ft 8 in.-18 ft) at the maximum wide-angle zoom position and a range of 1.0-3.1 m (3 ft 4 in.-10 ft) at the maximum telephoto zoom position.

Available Flash Modes

 AUTO	Auto	Flash fires automatically when lighting is poor.
	Auto with red-eye reduction	Suited to images of people. This option reduces the “red-eye” phenomenon that caused by the use of flash.
	Off	Flash does not fire even when lighting is poor. We recommend using a tripod to stabilize the camera when shooting in dark surroundings.
	Fill flash	Flash fires whenever an image is taken. Use to “fill-in” (illuminate) shadows and back-lit subjects.
	Slow sync	 AUTO (auto) is combined with slow shutter speed. Suited to evening and night portraits that include background scenery. Flash illuminates main subject; slow shutter speeds are used to capture background at night or under dim lighting.

Flash Mode Setting

- The flash mode setting varies depending on the shooting mode. See “Functions Available for Each Shooting Mode” (📖43) for more information. See “Default Settings” (📖50) for more information.
- Some of these settings may not be available with certain functions. See “Functions That Cannot Be Used Simultaneously” (📖55) for more information.
- The flash mode setting applied in  (auto) mode (📖31) is saved in the camera’s memory even after the camera is turned off.

Red-eye Reduction

This camera uses advanced red-eye reduction (“In-Camera Red-Eye Fix”). To reduce red-eye, a series of low-intensity pre-flashes fire before the main flash. In addition, if the camera detects red-eye when an image is taken, the affected area is processed to reduce red-eye before the image is saved. Note the following when shooting:

- Due to the pre-flashes, there is a longer than usual interval between the time the shutter-release button is pressed and the time the shutter is released.
- More time than usual is required to record images.
- Red-eye reduction may not produce the desired results in some situations.
- In extremely rare instances, areas not subject to red-eye may be affected by red-eye reduction processing; in these cases, choose another flash mode and try again.

Using the Self-timer

The camera is equipped with a 10-second and 2-second timer for self-portraits. This feature is useful for reducing the effects of camera shake that occurs when pressing the shutter-release button. When using the self-timer, use of a tripod is recommended. Set **Vibration reduction to Off** from the setup menu (📖74) when using a tripod to stabilize the camera.

1 Tap the self-timer icon.

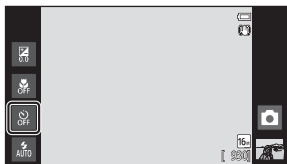

2 Tap **10s** or **2s**.

- **10s 10 s**: Use on important occasions, such as weddings.
- **2s 2 s**: Use to prevent camera shake.
- The selected self-timer mode is displayed.



3 Frame the picture and press the shutter-release button halfway.

- Focus and exposure are locked.

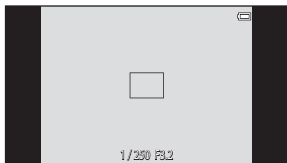

4 Press the shutter-release button the rest of the way down.

- The self-timer starts, and the number of seconds remaining before the shutter is released is displayed in the monitor. The self-timer lamp flashes while the timer is counting down. About 1 second before the shutter is released, the lamp stops flashing and glows steadily.
- When the shutter is released, the self-timer turns off.
- To stop the timer before an image is taken, press the shutter-release button again.

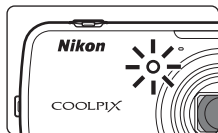
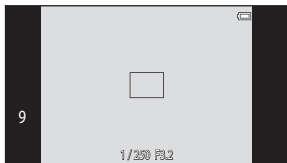

Using Macro Mode

When using macro mode, the camera can focus on objects as close as approximately 10 cm (4 in.) from the front of the lens.

This feature is useful when taking close-up images of flowers and other small subjects.

- 1 Tap the macro mode icon.

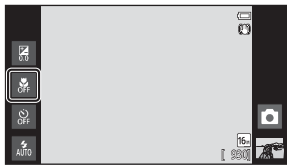

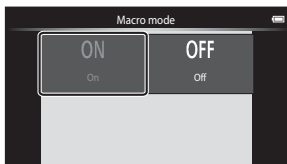

- 2 Tap ON.



- 3 Use the zoom control to set the zoom ratio to a position where  and the zoom indicator glow green.



- How close you can be to the subject when shooting depends on the zoom ratio. When the zoom ratio is set to a position where  and the zoom indicator glow green, the camera can focus at subjects as close as approximately 30 cm (1 ft) from the lens. When the zoom is at the maximum wide-angle position (at the position where  is displayed), the camera can focus on subjects as close as approximately 10 cm (4 in.) from the lens.

Note About Using the Flash

The flash may be unable to light the entire subject at distances of less than 50 cm (1 ft 8 in.).

Macro Mode Setting

- Macro mode cannot be used depending on the shooting mode. See "Default Settings" (📖50) for more information.
- The macro mode setting applied in  (auto) mode (📖31) is saved in the camera's memory even after the camera is turned off.

Adjusting Brightness (Exposure Compensation)

Exposure compensation is used to alter exposure from the value suggested by the camera to make images brighter or darker.

- 1 Tap the exposure compensation icon.

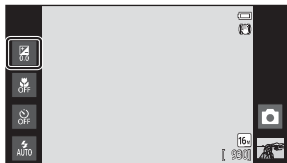

- 2 Tap or drag the slider to change the exposure compensation value.

- To make the image brighter, apply positive (+) exposure compensation.
- To make the image darker, apply negative (-) exposure compensation.

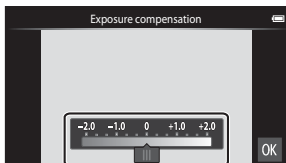



- 3 Press the shutter-release button to take an image.

- To exit the setting screen without taking an image, tap **OK**.
- To cancel the exposure compensation, return to step 1, restore the value to **0**, and tap **OK**.















Exposure Compensation Value



The exposure compensation value applied in  (auto) mode (31) is stored in the camera's memory even after the camera is turned off.

Default Settings

The default settings for each function in each shooting mode are described below.

- See the next page for information about the default settings in the scene modes.

	Flash mode ( 44)	Self-timer ( 46)	Macro mode ( 48)	Exposure compensation ( 49)
 (easy auto)	 ¹ AUTO	Off	Off ²	0.0
 (auto)	 AUTO	Off	Off	0.0
 (special effects)	 AUTO	Off	Off	0.0
 (smart portrait)	 ³ AUTO	Off ⁴	Off ⁵	0.0
 (movie)	–	Off ⁵	Off	–

¹  **(Auto)** (default setting) or  **(Off)** can be selected. When  **(Auto)** is selected, the camera automatically selects the flash mode appropriate for the scene it has selected.

² The setting cannot be changed. The camera enters macro mode when  is selected.

























































³ The function cannot be used when **Blink proof** is set to **On**.

⁴ The function can be used when **Smile timer** is set to **Off**.

⁵ The setting cannot be changed.

- The setting applied in  (auto) mode is saved in the camera's memory even after the camera is turned off (except the self-timer setting).



The default settings for each function in scene mode are described below.

	Flash mode ( 44)	Self-timer ( 46)	Macro mode ( 48)	Exposure compensation ( 49)
 ( 34)		Off	Off ¹	0.0
 ( 34)	 ¹	Off	Off ¹	0.0
 ( 34)	 ¹	Off ¹	Off ¹	0.0
 ( 35)	 ²	Off	Off ¹	0.0
 ( 35)	 ³	Off	Off ¹	0.0
 ( 35)	 AUTO	Off	Off ¹	0.0
 ( 35)	 AUTO	Off	Off ¹	0.0
 ( 35)	 ¹	Off	Off ¹	0.0
 ( 35)	 ¹	Off	Off ¹	0.0
 ( 36)	 ¹	Off	Off ¹	0.0
 ( 36)	 ¹	Off	On ¹	0.0
 ( 36)	 ¹	Off	On ¹	0.0
 ( 37)	 ¹	Off ¹	Off ¹	0.0 ¹
 ( 37)	 ¹	Off	Off	0.0
 ( 37)	 ¹ /  ⁴	Off	Off ¹	0.0
 ( 38)	 ¹	Off ¹	Off ¹	0.0
 ( 39)	 ¹	Off ⁵	Off	0.0

¹ Cannot be changed.

² Cannot be changed. The flash mode setting is fixed at fill flash with slow sync with red-eye reduction.

³ The setting may change to slow sync with red-eye reduction.

⁴ Flash is fixed at  (Fill flash) when **HDR** is set to **Off**, and is fixed at  (Off) when **HDR** is set to **On**.

⁵ Self-timer is disabled. **Pet portrait auto release** (39) can be enabled or disabled.

Functions That Can Be Set with the MENU (Menu) Button (Shooting Menu)

When shooting images in shooting mode, you can set the menu options listed below by pressing the **MENU** button.

- To return to the shooting screen, press the **MENU** button.

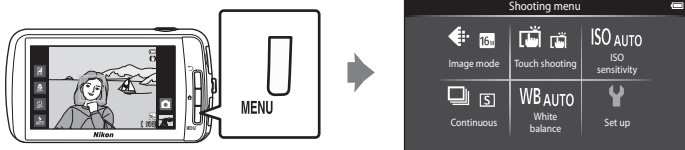

The settings that can be changed vary depending on the shooting mode, as indicated below.

	Easy auto mode	Auto mode	Scene ²	Special effects	Smart portrait
Image mode ¹	✓	✓	✓	✓	✓
Touch shooting	✓	✓	✓ ⁴	✓	✓ ³
ISO sensitivity	–	✓	–	–	–
Continuous	–	✓	–	–	–
White balance	–	✓	–	–	–
Skin softening	–	–	–	–	✓
Blink proof	–	–	–	–	✓
Smile timer	–	–	–	–	✓

¹ If you change the image mode setting, the new setting is applied to all shooting modes.











² Additional options can be set for some scene mode settings. See “Selecting a Scene Mode (Features)” (📖34) for more information.

³ This function can be used when **Smile timer** is set to **Off**.







⁴ The setting cannot be changed depending on the scene mode.

Shooting Menu Options

In shooting menu, the options listed below can be changed.

Option	Description	
 Image mode	Allows you to select the combination of image size and image quality used when saving images. The default setting is  4608x3456 . This setting is applied to all shooting modes.	 26
 Touch shooting	Select between Touch shutter (default setting), which allows you to release the shutter by tapping the monitor, and Touch AF/AE , which allows you to set the focus area by tapping the monitor. Subject tracking can be set in  (auto) mode.	 28
ISO ISO sensitivity	Higher ISO sensitivity allows you to take images of darker subjects. Additionally, even with subjects of similar brightness, images can be taken at faster shutter speeds, and blurring caused by camera shake and subject movement can be reduced. When ISO sensitivity is set to Auto (default setting), the camera sets the ISO sensitivity automatically.	 35
 Continuous	Allows you to take a series of images. <ul style="list-style-type: none"> When Continuous H, Continuous L, or BSS is selected, images are captured while the shutter-release button is held all the way down. When Continuous H: 120 fps, Continuous H: 60 fps or Multi-shot 16 is selected, the number of images determined by the setting is captured when the shutter-release button is pressed once all the way down. There is no need to hold the shutter-release button down. The default setting is Single (i.e., only one image is taken at a time). 	 36
WB White balance	Allows you to adjust the colors in the image so that they appear as they do to the eye. Although Auto (default setting) can be used under most types of lighting, white balance can be adjusted to suit the sky conditions or light source and achieve more natural color tones in the image. <ul style="list-style-type: none"> Set the flash mode ( 44) to  (Off) when white balance is set to any setting other than Auto and Flash. 	 38
 Skin softening	Enable or disable skin softening. The camera softens skin tones by applying the skin softening function before saving images. You can select the amount of effect applied. The default setting is Normal .	 40

Functions That Can Be Set with the MENU (Menu) Button (Shooting Menu)

Option	Description	
 Blink proof	When On is selected, the camera automatically releases the shutter twice each time an image is taken. Of the 2 shots, one in which the subject's eyes are open is saved. When On is selected, the flash is disabled. The default setting is Off .	  41
 Smile timer	When On (default setting) is selected, the camera detects human faces and then automatically releases the shutter whenever a smile is detected. Self-timer cannot be used with this option.	  41

Skin Softening

The camera detects up to three human faces when the shutter is released, and processes the image to soften facial skin tones before saving the image. The skin softening function is active in the following shooting modes:

- When shooting in **Portrait** (📖34) or **Night portrait** (📖35) scene mode, or when the camera selects one of these scene modes while in  (easy auto) mode.
- When shooting in smart portrait mode (📖41).

Skin softening can also be applied to saved images (📖63).

Notes About Skin Softening

- More time than usual may be required to save an image.
- In some shooting conditions, facial skin tones may not be smoothed or parts other than face may be modified. If the desired results are not produced, switch to another shooting mode or set **Skin softening** to **Off** if using smart portrait mode, and shoot again.
- The skin softening level cannot be adjusted when **Portrait** or **Night portrait** is selected in the scene mode.

Functions That Cannot Be Used Simultaneously

Some of these settings may not be available with certain functions (📖55).

Functions That Cannot Be Used Simultaneously

Some shooting settings cannot be used with other functions.

Restricted function	Setting	Description
Flash mode (📖44)	Continuous (📖53)	When a setting other than Single is selected, flash is disabled.
	Blink proof (📖54)	When Blink proof is set to On , flash is disabled.
Self-timer (📖46)	Subject tracking (📖53)	When Touch shooting is set to Subject tracking , Self-timer is disabled.
Image mode (📖53)	Continuous (📖53)	Image mode is locked for each continuous shooting setting, as follows: <ul style="list-style-type: none"> • Continuous H: 120 fps: 📷 (image size: 640 × 480 pixels) • Continuous H: 60 fps: 📷 (image size: 1280 × 960 pixels) • Multi-shot 16: 📷 (image size: 2560 × 1920 pixels)
Macro mode (📖48)	Subject tracking (📖53)	When Touch shooting is set to Subject tracking , Macro mode is disabled.
ISO sensitivity (📖53)	Continuous (📖53)	When Continuous H: 120 fps , Continuous H: 60 fps , or Multi-shot 16 is selected, the ISO sensitivity setting is automatically specified according to the brightness.
		When Continuous L is selected, 3200 cannot be selected. If Continuous L is selected when the ISO sensitivity setting is 3200 , the ISO sensitivity setting changes to 1600 .
Continuous (📖53)	Touch shutter (📖53)	When a setting other than Multi-shot 16 is selected, one image is taken each time the monitor is tapped when using the touch shutter function.
Blink warning (📖75)	Continuous (📖53)	When a setting other than Single is selected, Blink warning is disabled.
Print date (📖74)	Continuous (📖53)	When a setting other than Single or Multi-shot 16 is selected, Print date is disabled.
	Blink proof (📖54)	When On is selected, Print date is disabled.

Functions That Cannot Be Used Simultaneously

Restricted function	Setting	Description
Digital zoom (📖75)	Continuous (📖53)	When Multi-shot 16 is selected, digital zoom is not available.
	Subject tracking (📖53)	When the touch shooting is set to Subject tracking , digital zoom is disabled.
Shutter sound (📖75)	Continuous (📖53)	When a setting other than Single is selected, the shutter sound is disabled.

✔ Notes About Digital Zoom

- Digital zoom is not available with some shooting modes.
- The camera focuses on the subject at the center of the frame when digital zoom is in effect.

Focusing on Subjects

The focus area varies depending on the shooting mode.

- When shooting a subject that is not suitable for autofocus (📖25), try pressing the shutter-release button halfway several times, or try the techniques described in “Shooting Subjects Not Suitable for Autofocus” (📖60).

Focus Area

In 📷 (easy auto) mode or 📷 (auto) mode, the camera performs the focus operations described below when the shutter-release button is pressed halfway.

- When a face is detected, it is framed by the double border indicating the active focus area. When the subject is in focus, the double border turns green.



Shutter speed Aperture value

- When no face is detected, the camera automatically selects one (or more) of the 9 focus areas containing the subject closest to the camera. When the subject is in focus, the focus areas that are in focus glow green (up to nine areas). If a shooting mode icon other than 📷 or 📷 is displayed in 📷 (easy auto) mode, the camera focuses on the subject at the center of the frame (📖6).
- Tap the monitor to select the focus area. See “📷/📷/AF-L/AE-L Touch shooting” (📖53) for more information.

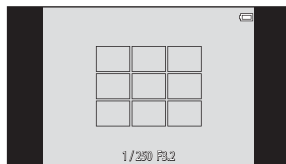

Face Detection

When the camera is pointed at a human face in the shooting modes listed below, the camera automatically detects the face and focuses on it.

When the camera detects more than one face, the double border (focus area) is displayed around the face that is focused on, and single borders around the others.



- Tap a face framed by a single border to change the focus area to that face (except when smile timer is set to **On** in smart portrait mode).

Shooting mode	Number of faces that can be detected	Focus area (double border)
(easy auto) mode (📖30)	Up to 12	The face closest to the camera
(auto) mode (📖31)		
Portrait and Night portrait scene modes (📖32)		
Smart portrait mode (📖41)	Up to 3	The face closest to the center of the frame

- In (easy auto) mode, the camera changes focus areas depending on the scene that it automatically selects (📖57).
- In (auto) mode, if no faces are detected when the shutter-release button is pressed halfway, the camera automatically selects one (or more) of the nine focus areas containing the subject closest to the camera.
- In **Portrait** and **Night portrait** scene modes or smart portrait mode, if no faces are detected when the shutter-release button is pressed halfway, the camera focuses on the subject at the center of the frame.
- In subject tracking mode (📖53), subject tracking begins when a detected face framed by a border is tapped.

Notes About the Face Detection Function

- The camera may be unable to detect faces in the following situations:
 - When faces are partially hidden by sunglasses or other obstructions
 - When faces take up too much or too little of the frame
- When the frame includes more than one face, the faces detected by the camera and the face on which the camera focuses depend on a variety of factors, including the direction in which the faces are looking.
- When shooting a subject that is not suitable for autofocus (📖25), the camera may not be able to focus properly on the subject despite the fact that the double border glows green. Should this occur, refocus on another subject positioned at the same distance from the camera as the actual portrait subject (📖60).

Viewing Images That Were Taken Using Face Detection

When playing back images that include a face detected during shooting, the images are automatically rotated depending on the orientation of the face detected (except images captured in a series).

Shooting Subjects Not Suitable for Autofocus

When shooting a subject that is not suitable for autofocus (📖25), try pressing the shutter-release button halfway to refocus several times, or try the following techniques.

- 1 Switch to 📷 (auto) mode (📖31) and select **Touch AF/AE** (📖53) for the touch shooting setting.

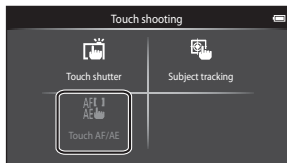

- 2 Tap another subject that is as far from the camera as the desired subject.

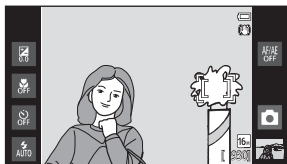

- 3 Press the shutter-release button halfway.

- The camera focuses on the subject and the focus area glows green.
- Exposure is locked for the subject on which focus is acquired when the shutter-release button is pressed halfway.

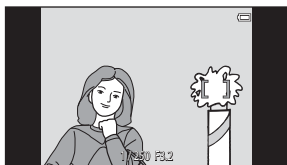

- 4 Continue holding down the shutter-release button halfway and recompose the image.

- Be sure to maintain the same distance between the camera and the subject while the shutter-release button is pressed halfway.

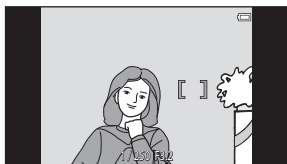

- 5 Press the shutter-release button the rest of the way down to take the image.



Playback Features

Playback Zoom

Spread two fingers apart on the playback screen to enlarge the current image.

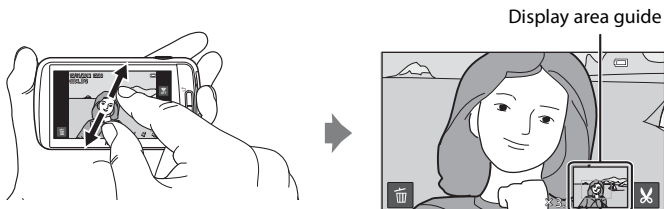

- You can also zoom in on images by rotating the zoom control to **T** (📷) or double-tapping an image. This feature is useful for checking the focus of an image. Images can be enlarged up to 10x.
- The zoom ratio changes as your fingers move (spreading apart or pinching together). You can also change the zoom ratio by rotating the zoom control to **T** (📷) or **W** (📐).
- To view a different area of the image, drag the image.
- When rotating the zoom control to **T** (📷) to enlarge an image taken using face detection (📖59) or pet detection (📖39), the face detected at the time of shooting is displayed at the center of the monitor (except images captured in a series). If the camera detected multiple faces when the image was captured, the face that the camera focused on is enlarged at the center of the monitor. Tap 📷 or 📷 to display a different face.
- You can crop the image and save the displayed area of the image as a separate file by tapping ✂.
- To delete images, tap 🗑.
- Rotate the zoom control to **W** (📐), or double-tap an image to return to full-frame playback mode.

Thumbnail Playback

Pinch two fingers together on the playback screen to display images as thumbnails.

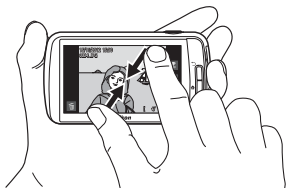

6, 12, and 20 images per screen

- You can also display thumbnails by rotating the zoom control to **W** (🎯).
- You can view several images on the same screen, making it easier to find a particular image.
- The number of thumbnails displayed changes as your fingers move (spreading apart or pinching together). You can also change the number of thumbnails by rotating the zoom control to **T** (🔍) or **W** (🎯).
- Drag the screen up or down to scroll through the images.
- Tap an image to display it in full-frame playback mode.

Functions That Can be Set with the MENU Button (Playback Menu)

When viewing images in full-frame playback mode or thumbnail playback mode, you can set the menu options by pressing the **MENU** button.

- To return to the playback screen, press the **MENU** button.

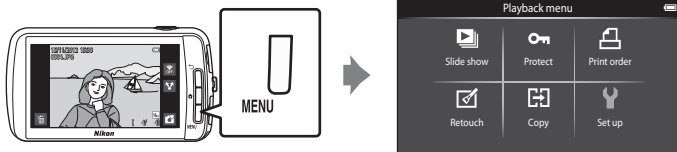

Playback Menu Options

In playback menu, the options listed below can be changed.

Option	Description	
Slide show	Play back images stored in the internal memory or on a memory card one by one in an automated slide show.	42
Protect	Protect selected images from accidental deletion.	44
Print order ¹	When using a printer to print images saved on the memory card, you can use the Print order function to select which images are printed, and how many copies of each image are printed.	46
Retouch ^{1, 2, 3}	Edit images. Available editing functions are Quick retouch , D-Lighting , Filter effects , Skin softening , and Small picture . Retouched copies are stored as separate files.	5
	Use Rotate image to set the orientation of images when they are played back on the camera.	49
Copy	Copy files between a memory card and the internal memory.	50

¹ The function cannot be used for movies.

² When using thumbnail playback mode, this function cannot be applied. Display the image in full-frame playback mode.

³ Copies created with editing functions cannot be edited again with the same function used to create them. However, some editing functions such as small picture and crop may be additionally performed.

Connecting the Camera to a TV and Computer

You can enhance your enjoyment of images and movies by connecting the camera to a TV and computer.

- Before connecting the camera to an external device, make sure the remaining battery level is sufficient. Before connecting the camera to a TV, make sure to turn the camera off. When connecting the camera to a computer, first turn on the camera, then connect the camera to the computer using the included USB cable, and then turn on the USB storage option on the camera screen. When disconnecting the camera from the computer, first eject the removable disk from the computer, then turn off the USB storage option on the camera screen, and then disconnect the included USB cable while the camera is turned on. For information about the connection methods and subsequent operations, refer to the documentation included with the device in addition to this document.

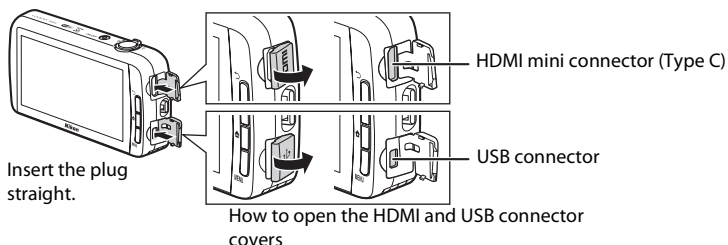

Viewing images on a TV

📺 15



You can view the camera's images and movies on a TV.
Connection method: Connect a commercially available HDMI cable (Type C) to the TV's HDMI input jack.

Viewing and organizing images on a computer

📖 65



If you transfer images to a computer, you can perform simple retouching and manage image data in addition to playing back images and movies.

Connection method: Connect the camera to the computer's USB input jack with the included USB cable.

- Before connecting to a computer, download the ViewNX 2 installer and install ViewNX 2 on the computer. For information about downloading the ViewNX 2 installer and transferring images to a computer, see "Transferring Images to the Computer" (📖66).
- If any USB devices that draw the power from the computer are connected, disconnect them from the computer before you connect the camera to it. Connecting the camera and other USB-powered devices to the same computer simultaneously may cause a camera malfunction or excessive power supply from the computer, which could damage the camera or memory card.

Using ViewNX 2

ViewNX 2 is a software package which enables you to transfer, view, edit and share images.

Your Imaging Toolbox

ViewNX 2™



Installing ViewNX 2

- An Internet connection is required.

Compatible Operating Systems

Windows

- Windows 7 Home Basic/Home Premium/Professional/Enterprise/Ultimate (Service Pack 1)
- Windows Vista Home Basic/Home Premium/Business/Enterprise/Ultimate (Service Pack 2)
- Windows XP Home Edition/Professional (Service Pack 3)

Macintosh

- Mac OS X (version 10.6.8, 10.7.4)

Refer to the Nikon website for the latest information on operating system compatibility.

- 1** Start the computer and download the ViewNX 2 installer from the URL below.

<http://nikonimglib.com/nvnx/>

- 2** Double-click the installer file.

3 Follow the on-screen instructions to install the software.

The following software is installed:

- ViewNX 2 (consisting of the 3 modules below)
 - Nikon Transfer 2: For transferring images to the computer
 - ViewNX 2: For viewing, editing, and printing transferred images
 - Nikon Movie Editor: For basic editing of transferred movies

4 Exit the install.

- Windows: Click **Yes**.
- Mac OS: Click **OK**.

Transferring Images to the Computer

1 Choose how images will be copied to the computer.

Choose one of the following methods:

- **Direct USB connection:** Turn the camera on with the memory card inserted, connect it to the computer using the included USB cable, and turn on the USB storage option on the camera screen.

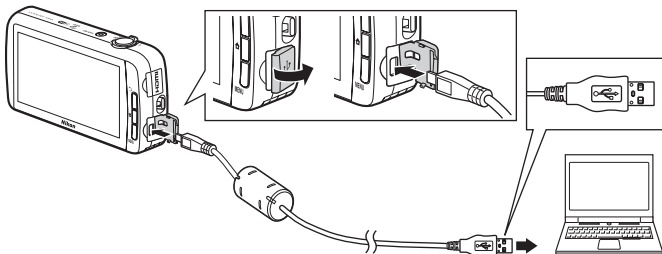

- **SD card slot:** If your computer is equipped with an SD card slot, the card can be inserted directly in the slot.
- **SD card reader:** Connect a card reader (available separately from third-party suppliers) to the computer and insert the memory card.

If a message is displayed prompting you to choose a program, select Nikon Transfer 2.

If the memory card contains a large number of images, it may take a while for Nikon Transfer 2 to start. Wait until Nikon Transfer 2 starts.

✔ Connecting the USB Cable

The connection may not be recognized if the camera is connected to the computer via a USB hub.

2 Transfer images to the computer.

- Confirm that the recording medium (memory card or internal memory) of the connected camera or removable disk is displayed as the "Source" on the "Options" title bar of Nikon Transfer 2 (①).
 - When the camera and computer are connected, select the recording medium (memory card or internal memory) that contains the images you want to transfer.
- Click **Start Transfer** (②).
 - To transfer images saved on both recording media (memory card and internal memory), uncheck **Disconnect automatically after transfer** in **Preferences** and then click **Start Transfer**.



- At default settings, all the images on the memory card will be copied to the computer.
 - When the transfer of images from one recording medium is completed while **Disconnect automatically after transfer** is unchecked, Nikon Transfer 2 quits automatically and ViewNX 2 starts. If you want to continue transferring images from another recording medium, click **Transfer** on the ViewNX 2 toolbar, start Nikon Transfer 2, and then import the images to the computer.

3 Terminate the connection.

- If the camera is connected to the computer, first eject the removable disk from the computer, then turn off the USB storage option on the camera screen, and then disconnect the included USB cable. If you are using a card reader or card slot, choose the appropriate option in the computer operating system to eject the removable disk corresponding to the memory card and then remove the card from the card reader or card slot.

Viewing Images

Start ViewNX 2.

- Images are displayed in ViewNX 2 when transfer is complete.
- Consult online help for more information on using ViewNX 2.



Starting ViewNX 2 Manually

- **Windows:** Double-click the **ViewNX 2** shortcut on the desktop.
- **Mac OS:** Click the **ViewNX 2** icon in the Dock.

Recording and Playing Back Movies

Recording Movies

You can record movies with sound.

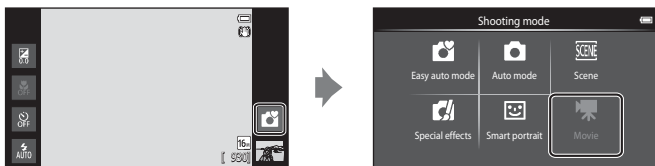

1 Press the shutter-release button all the way down to start recording.

- The camera focuses on the subject at the center of the frame. Focus areas are not displayed during recording.
- Recording stops automatically when the maximum movie length that can be recorded is reached.

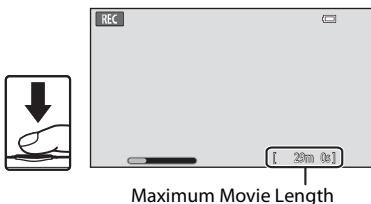

Maximum Movie Length

The approximate maximum movie length is displayed during recording.

- If a memory card is not inserted, **IN** is displayed to indicate that the movie will be saved in the camera's internal memory (approximately 1.7 GB).
- The maximum movie length shown in the illustrations differs from the actual display.

2 Press the shutter-release button all the way down to end recording.

- Movie recording can also be started or stopped by tapping the monitor. See "Touch shooting" (72) for more information.

Note About Saving Movies

The indicator showing the maximum movie length flashes while a movie is being saved. **Do not open the battery-chamber/memory card slot cover or remove the battery or memory card** while the indicator is flashing. Doing so could result in loss of data or damage the camera or memory card.

Recording Movies

- Memory cards with an SD Speed Class rating of 6 or faster are recommended when recording movies (19). Movie recording may stop unexpectedly when memory cards with a lower Speed Class ratings are used.
- The camera focuses when the shutter-release button is pressed halfway, and the focus remains locked while the shutter-release button is pressed halfway.
- Digital zoom degrades image quality. When recording movies, the digital zoom can magnify the image up to 4x the maximum optical zoom ratio.
- In some cases, movie recordings may capture the sounds of the camera itself, such as those made by the shutter-release button, the zoom control, the movement of the lens during autofocus, vibration reduction, or aperture control when the brightness changes.
- The following phenomena may be seen in the monitor while recording movies. These phenomena are saved in the recorded movies.
 - Banding may occur in images under fluorescent, mercury-vapor, or sodium-vapor lighting.
 - Subjects that move quickly from one side of the frame to the other, such as a moving train or car, may appear skewed.
 - The entire movie image may be skewed when the camera is panned.
 - Lighting or other bright areas may leave residual images when the camera is moved.
- When recording or playing back movies, colored stripes (interference patterns or moiré) may appear on subjects that have a regular, repeating grid, such as pattern of weave in clothing or windows in a building, depending on the shooting distance or zoom ratio. This phenomenon occurs when the subject's pattern interferes with the camera sensor grid, and it does not indicate a malfunction.

Notes About Camera Temperature



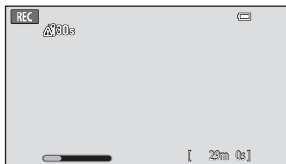

- The camera temperature may increase significantly when used for an extended period of time for movie recording, etc., or when used in places with high ambient temperature.
- If the camera becomes extremely hot while recording a movie, the camera automatically terminates recording after 30 seconds. The camera monitor displays the number of seconds remaining until automatic termination is activated. 5 seconds after movie recording is terminated, the camera turns off. Wait until the internal temperature decreases before using it again.



Notes About Autofocus for Movie Recording

- When **AF-S Single AF** (default setting) is selected for **Autofocus mode** in the movie menu, focus is locked when recording starts.
- When shooting a subject that is not suitable for autofocus (25), the camera may not be able to focus properly on the subject. Follow the procedure below if you are trying to shoot this type of subject for movies.
 1. Set **Autofocus mode** in the movie menu to **AF-S Single AF** (default setting) before starting movie recording.
 2. Frame a different subject (positioned at the same distance from the camera as the intended subject) in the center of the frame, press the shutter-release button halfway, modify the composition, and press the shutter-release button all the way down.

Maximum Movie Length

Movie options (📖72)	Memory card (4 GB)*
 HD 1080p ★ (1920×1080) (default setting)	35 min
 HD 1080p (1920×1080)	40 min
 HD 720p (1280×720)	50 min
 VGA (640×480)	2 h 35 min

All figures are approximate. The maximum movie length may vary depending on make of memory card.

Check the shooting screen for the maximum movie length when recording to the internal memory (approx. 1.7 GB).

* Each movie is limited to a file size of 4 GB and a movie length of 29 minutes, even when there is sufficient free space on the memory card for longer recording. The maximum movie length that can be recorded for a single movie is displayed during recording.

Changing Movie Recording Settings

- You can change the macro mode setting. See “Basic Shooting Settings” (📖43) for more information.
- Press the **MENU** button (📖2) to display the menu options available for movie recording. See “Movie Menu Options” (📖72) for more information.

Functions That Can be Set with the MENU Button (Movie menu)

When recording movies in movie mode, you can set the menu options listed below by pressing the **MENU** button.

- To return to the movie recording screen, press the **MENU** button.

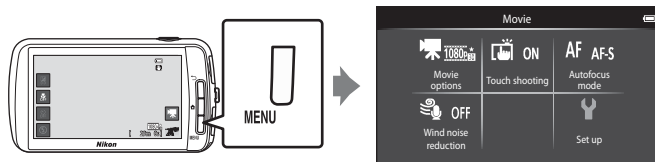



Movie Menu Options

The options listed below can be changed when recording movies.

Option	Description	
Movie options	Select the movie type. <ul style="list-style-type: none"> Select either normal speed movies or HS (high speed) movies, which enable slow motion or fast motion playback. 	52
Touch shooting	Select ON (default setting) or OFF to activate or deactivate the touch shooting.	53
AF Autofocus mode	Select between AF-S Single AF (default setting), which locks focus when movie recording starts, and AF-F Full-time AF , which continue focusing during movie recording. When Full-time AF is selected, the sound of the camera focusing may be heard in the recorded movie. If you are concerned about the sound, use of Single AF is recommended. <ul style="list-style-type: none"> When an HS movie option is selected in Movie options, the setting is fixed to Single AF. 	54
Wind noise reduction	Select whether wind noise is reduced when recording movies. <ul style="list-style-type: none"> When an HS movie option is selected in Movie options, the setting is fixed to Off. 	54

Movie Playback

Select the desired movie in playback mode (📖26) and tap .

- Movies can be recognized by the movie options icon displayed on them.
- The movie is played back.
- To adjust the volume before playback, press the **MENU** button and tap .













Movie option

Operations During Movie Playback

Tap the monitor during playback to display the control panel at the bottom of the screen. The operations listed below are available by tapping the icons in the panel.



Operation	Icon	Description
Adjust volume		Tap  to adjust the volume.
Rewind		Touch and hold  to rewind the movie.
Advance		Touch and hold  to advance the movie.
Pause		Pause playback. The following operation can be performed while playback is paused.
		 Tap  to resume playback.
End		End playback and return to full-frame playback mode.

Note About Movie Playback

Movies recorded by a camera other than the COOLPIX S800c cannot be played back.

Adjusting the Volume

To adjust the volume, rotate the zoom control to **T** or **W** (📖1) during playback.

Deleting Movie Files

See “Step 6 Delete Unwanted Images” (📖28) for more information.

General Camera Setup





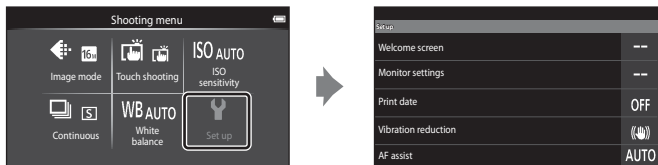





The Setup Menu

In the setup menu, the following options can be changed.









- Drag the screen up or down to scroll through the options.

Option	Description	
Welcome screen	Allows you to select the image displayed as the welcome screen when the camera is turned on. Select COOLPIX to display the COOLPIX logo.	55
Monitor settings	Set the information display setting, the image review setting.	56
Print date	Allows you to imprint the shooting date and time on images at the time of shooting. <ul style="list-style-type: none">• The shooting date and time cannot be imprinted on images in the following situations:<ul style="list-style-type: none">- When using Sports, Backlighting (when HDR is set to On), Easy panorama, or Pet portrait (when Continuous is selected) scene mode.- When On is selected for Blink proof (54) in smart portrait mode.- When a setting other than Single or Multi-shot 16 is selected for the continuous setting (53).- When shooting movies.	57

Option	Description	
Vibration reduction	<p>Allows you to reduce blurring caused by camera shake when shooting.</p> <ul style="list-style-type: none"> When using a tripod to stabilize the camera during shooting, set this feature to Off. The current vibration reduction setting can be confirmed in the camera monitor when shooting. When Off is selected, no icon is displayed. 	 58
AF assist	<p>When set to Auto, the AF-assist illuminator (1) lights when shooting in dark surroundings to help the camera focus.</p> <ul style="list-style-type: none"> The illuminator has a range of about 2.0 m (6 ft 6 in.). Even if Auto is selected, the AF-assist illuminator may not light depending on the position of the focus area or the scene mode that is selected. 	 59
Digital zoom	<p>When set to On, rotating the zoom control to T () at the maximum optical zoom position (23) triggers the digital zoom feature.</p>	 59
Shutter sound	<p>Select whether or not the shutter sound plays when the shutter is released.</p>	 60
Shut-down timer	<p>Allows you to set the amount of time that passes before the camera exits stand by mode and turns off to save power.</p> <ul style="list-style-type: none"> All unsaved data is lost when the camera turns off after the set amount of time. It is recommended that you save the data you want to keep before the camera enters stand by mode. 	 60
HDMI	<p>Adjust settings for connection to TV.</p> <ul style="list-style-type: none"> HDMI settings can be set. 	 61



The Setup Menu

Option	Description	
Blink warning	Immediately after taking an image using face detection ( 58) (except when using smart portrait mode), if the camera detects a subject with closed eyes, the camera displays the Did someone blink? message, allowing you to check the images.	 61
GPS options	<p>Record GPS data: When set to On, signals are being received from the GPS satellite, and positioning starts (when shooting). The default setting is Off.</p> <p>Synchronize: Signals from the GPS satellite are used to set the date and time of the camera's internal clock (only when Record GPS data in GPS options of the setup menu is set to On).</p> <p>Update A-GPS file: The memory card is used to update the A-GPS (assist GPS) file. Using the latest A-GPS file can shorten the time needed to determine the location.</p> <ul style="list-style-type: none"> When using Record GPS data, Synchronize and Update A-GPS file, set GPS options to on in Location & security in the Android™ platform setting menu. 	 63
Reset all	<p>Allows you to reset the camera's settings to their default values.</p> <ul style="list-style-type: none"> Some of the basic settings are not reset. 	 67
Firmware version	View the current camera firmware version.	 69



Sharing Images

Uploading Images to Online Services

You can upload images and movies by tapping  (share) on the playback screen and selecting the desired online service.

- An Internet connection is required in order to upload images to the desired online service. Set up your Wi-Fi (wireless LAN) network (80).
- To use a particular online service, you must install the application for that service (82).
- For more information on how to use a particular online service, refer to the support for that service.

1 Change how images are displayed on the playback screen before uploading images, as follows:

- To upload images one by one, display each image or movie you want to upload in full-frame playback mode (26).
- To upload multiple images, display images as thumbnails (62).

2 Tap (Wi-Fi settings) to turn on the Wi-Fi (wireless LAN) function in full-frame playback mode or thumbnail playback mode.



3 Tap (share).

- If you are performing this operation in full-frame playback mode, go to step 6.

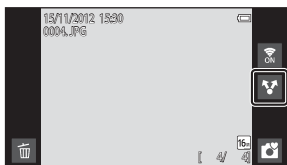

4 Tap the images or movies you want to upload.

- A check mark is displayed on images and movies when they are selected. To cancel the selection, tap the image or movie again.



5 Tap **OK**.

6 In the displayed list, tap the icon of the online service you want to use for sharing.

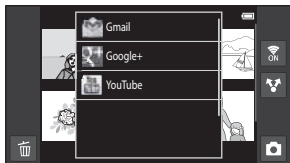

7 Upload images and movies using the application for the online service you selected.

- For more information on using a particular online service, refer to the support for that service.

✔ Note About Camera Functions for Social Networking Service (SNS) Applications

When you use the camera functions for social networking service (SNS) applications, select the COOLPIX S800c shooting application when it is displayed in the list of available camera applications. If you select an application other than the COOLPIX S800c shooting application, some of the COOLPIX S800c functions may not be available when shooting.

📎 my Pictown Application

The my Pictown application, which provides access to Nikon's my Pictown online photo sharing and storage service, can be downloaded from the Google Play Store. For more information about downloading, see "Using Google Play Store (Getting Applications)" (p.94).

Using Android™ Platform

When Turning On the Camera for the First Time

If you are turning the camera on for the first time after purchase, the Android™ platform logo screen is automatically displayed. Follow the instructions on the screen to set each option. You can also skip ahead without configuring the settings.

1 Tap the Android™ platform logo.

- To change the language, tap the button at the bottom of the screen and choose the desired language.

2 Set up the Wi-Fi (wireless LAN) network.

- Enter the details of the Wi-Fi (wireless LAN) network used to access the Internet.
- To set up a Wi-Fi (wireless LAN) connection, you must have access to a Wi-Fi (wireless LAN) network.

3 Set up a Google account.

- Using a Google account allows you to install various applications from the Google Play Store and take advantage of other Google services on your camera.
- To set up a Google account, you must have a Wi-Fi (wireless LAN) connection with Internet access, and you must configure the settings described in step 2 above.
- To skip ahead without configuring the settings, drag the screen up and tap the button displayed at the bottom.

4 Set the preferences for Google's location service.

- This setting allows applications to use the position information.



5 Set the date and time.

- Set the clock to the current date and time.
- If you exit without setting the date and time,  will flash when the shooting screen is displayed.

Entering Text

See "Entering Text" (86) for more information.

Changing the Settings

- See "Setting Up a Wi-Fi (Wireless LAN) Network" (80) for more information.
- See "Setting Up a Google Account" (82) for more information.
- See "Setting the Date and Time" (84) for more information.

Setting Up a Wi-Fi (Wireless LAN) Network

Display the Android™ platform home screen → Press the **MENU** button → Tap Settings → Tap Wireless & networks → Wi-Fi settings

The COOLPIX S800c can access the Internet via Wi-Fi (wireless LAN) network. Follow the procedure below to connect to a Wi-Fi network.

1 Tap the **Wi-Fi** check box.

- The Wi-Fi (wireless LAN) function turns on, and the camera searches for available Wi-Fi (wireless LAN) networks.
- It may take a few seconds for the Wi-Fi (wireless LAN) function to turn on.
- The names of available Wi-Fi (wireless LAN) networks are displayed under **Wi-Fi networks**.

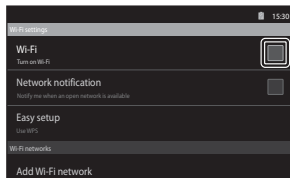

2 Tap the name of the Wi-Fi (wireless LAN) network to connect to, and tap **Connect**.

- When the connection is established, the connection status is displayed under the name of the Wi-Fi (wireless LAN) network.
- The icon displayed next to the name of each Wi-Fi (wireless LAN) network indicates whether the network is open or secure.
- If the network is secure, you will be prompted to enter a password or other security information.
- If you try to connect to the same Wi-Fi (wireless LAN) network again later, the camera will remember the security information, allowing you to connect without entering the details again.

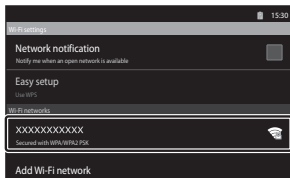

Disconnecting from a Wi-Fi (Wireless LAN) Network

To end the Wi-Fi (Wireless LAN) connection, tap the selected Wi-Fi network in step 2 in “Setting Up a Wi-Fi (Wireless LAN) Network” (📖80) and tap **Forget**.

✔ Notes About Wi-Fi (Wireless LAN) Networks

- For more information on configuring a private Wi-Fi (wireless LAN) network, contact your Wi-Fi service provider.
- The camera may not be able to connect to some Wi-Fi (wireless LAN) networks. For details about a particular network, contact the Wi-Fi service provider or a dealer.
- Wi-Fi (wireless LAN) networks use a wireless signal to transmit information, making them convenient to use with devices within range of the signal. However, without the proper security settings, unauthorized third parties may be able to access the network and cause harm. Security settings are recommended, though it is solely the responsibility of the user to determine whether or not to use them.

✔ Note About Using Internet

You can use the Internet to access a variety of information, but there is a risk of infecting the camera with a virus.

To help prevent virus infection, we recommend that you periodically scan for viruses (using tools such as online virus scanners) and install anti-virus software.

🔪 Reducing Battery Power Consumption

Battery power consumption is increased when the Wi-Fi (wireless LAN) function is turned on, because the camera continues to perform wireless communications. To turn off the Wi-Fi function, tap the check box again in step 1 in “Setting Up a Wi-Fi (Wireless LAN) Network” (📖80).

Setting Up a Google Account

Display the Android™ platform home screen → Press the **MENU** button → Tap Settings → Accounts & sync settings

Setting a Google account allows you to install various applications from the Google Play Store and take advantage of other Google services on your camera. Google accounts are free of charge, and the email address can be used as a user name. You can register multiple accounts to the COOLPIX S800c.

- An Internet connection is required in order to set up a Google account. Set up your Wi-Fi (wireless LAN) network (📖80).

1 Tap **Add account.**

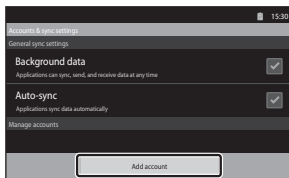

2 Tap **Google.**



3 Tap **Next.**

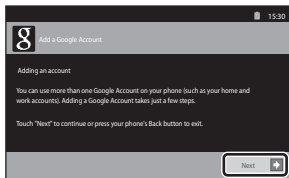

4 Tap **Create**.

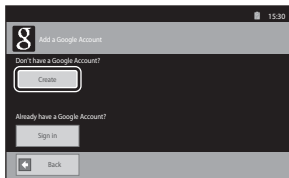

5 Follow the on-screen instructions to set up.

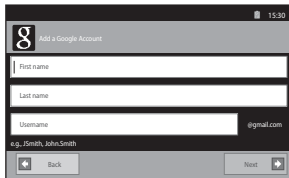

Logging in to a Google Account

To log in to your Google account, tap **Sign in** in step 4 in “Setting Up a Google Account” (📖82).

Setting the Date and Time

Display the Android™ platform home screen → Press the **MENU** button → Tap Settings → Date & time

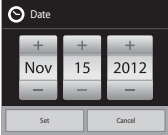
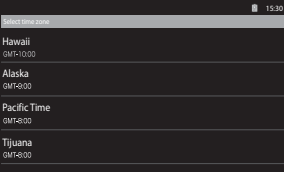
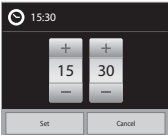
Option	Description
Set date	Set camera clock to current date (month, day and year). <ul style="list-style-type: none"> • To edit the highlighted item: Tap + or –. • To apply the setting: Tap Set. 
Select time zone	Specify the time zone. <ul style="list-style-type: none"> • Tap your current time zone. 
Set time	Set camera clock to current time. The setting procedure is the same as that for Set date . 

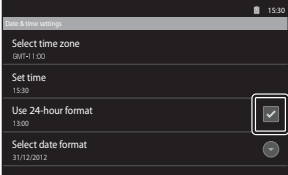
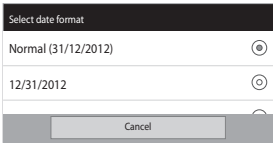
Option	Description
Use 24-hour format	Select the 24-hour display or 12-hour display. <ul style="list-style-type: none"> To select the 24-hour display, add a check mark by tapping. 
Select date format	Select the order in which the day, month, and year are displayed, from month/day/year, day/month/year, and year/month/day. <ul style="list-style-type: none"> Tap the desired date format. 

Selecting Time Zone

If you change the time zone after setting the time, the time that you set also changes.

Clock Battery

The camera's clock is powered by a backup battery that is separate from the camera's main battery. The backup battery charges when the main battery is inserted into the camera or when the camera is connected to an optional AC adapter, and can provide several days of backup power after about 10 hours of charging.

Imprinting the Shooting Date on Printed Images

- Set the date and time before shooting.
- You can permanently imprint the shooting date on images as they are taken by setting **Print date** in the setup menu (📖74).
- You can use the ViewNX 2 software (📖65) to print the shooting date on images that were taken without using the **Print date** option.

Entering Text

Enter text using the on-screen keyboard. The keyboard is displayed whenever you tap a text input area such as the search box.

How to Enter Text, Number and Symbol

- Tap a text input area to display the keyboard.
- Tap the keys on the keyboard to enter text, numbers and symbols.

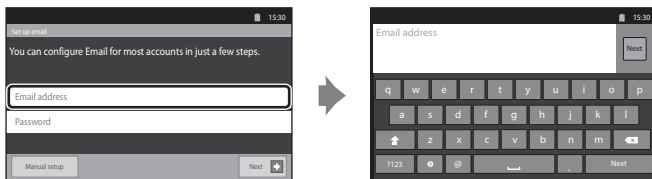

Example of English Keyboard

Switching Between the Text Keyboard and the Number and Symbol Keyboard

- Tap **?123** or **ABC** at the bottom left of the keyboard to switch between the text keyboard and the number and symbol keyboard.
- To change the input language on the **Android keyboard**, press the **MENU** button on the home screen and tap **Settings > Language & keyboard > Android keyboard > Input languages**.



Entering Text







- You can drag the cursor to select text and cut, copy, or paste it ([link 87](#)).
- Press the  (back) button to hide the on-screen keyboard.

Using a Keyboard for a Specific Language

Keyboards for a variety of languages can be downloaded from the Market.

Other Keyboard Operations

Tap the keys listed below to perform the operations other than entering text.

Key	Description
	Switches the keyboard characters from alphabet to numbers and symbols.
	Switches the keyboard characters from numbers and symbols to alphabet.
	Inserts a space.
	Switches between upper case, lower case, and symbols.
	Deletes characters to the left of the cursor.
	Displays additional symbols on the keyboard.

* Displayed key varies depending on the current operating condition.

Editing Text

If you touch and hold the text box after text has been entered, the currently available editing options are displayed. The availability of some options may depend on whether other editing actions have already been performed. The editing options are listed below.

Option	Description
Select word	Drag the slider to select text.
Select all	Select all of the entered text.
Input method	Select one of several keyboards.
Cut	Cut the text selected with Select word or Select all .
Copy	Copy the text selected with Select word or Select all .
Paste	Paste text that has been edited with Cut or Copy into the location you specify.

Basic Operations for Android™ Platform

Displaying the Home Screen

- Press the  (home) button on any screen to display the home screen.
- The displayed information may vary depending on the Android™ platform or other conditions.



1	Status bar.....	90	3	Screen indicator	89
2	Dock bar.....	89	4	Shortcuts (Applications).....	92

Activating the Camera's Shooting Screen or Playback Screen from the Home Screen

To activate the camera's shooting screen, tap  (shooting) application.

To activate the camera's playback screen, tap  (playback) application.

Using Widgets



It is convenient to place frequently used widgets on the home screen. For example, if you place the **Power control** widget on the home screen, you can easily adjust the monitor brightness, turn on or off the Wi-Fi (wireless LAN) or GPS functions, etc.

- Placing widgets: Touch and hold the home screen, select **Widgets**, and select the desired widget in **Choose Widgets**.
- Deleting widgets: Touch and hold a widget, and drag it to the trash can on the right side of the screen.



Power control widget

Displaying the Applications Screen

- The icons of installed applications are displayed on the applications screen.
- On the home screen, tap  in the dock bar to display the applications screen.
- The displayed information may vary depending on the Android™ platform settings or other conditions.
- Press the  (back) button or tap  to return to the home screen.

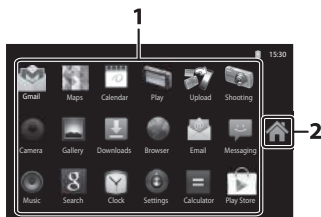



1 Application 93

2  icon

Opening Applications and Putting Them in Stand by Mode

Tap an application's icon to open the application.

Press the  (back) button or  (home) button to put an application in stand by mode. Battery power is consumed when applications are in stand by mode. To fully quit applications, go to **Manage Applications** in **Applications** in the setting menu (91), and shut down the applications that are running.

Switching the Screen

The home screen and applications screen consist of multiple panes. To display a different pane on the home screen, flick the screen to the left or right. To display a different pane on the applications screen, flick it up or down.

You can check the screen indicator (88) to determine which pane of the screen is currently being displayed on the home screen.

Status Bar and Notification Panel

Status Bar

The status bar is the area at the top of the screen in which notification icons are displayed.

Icons indicating the status of newly received email and active operations such as downloading or installing are shown on the left, and icons indicating the status of COOLPIX S800c features such as the Wi-Fi (wireless LAN) connection, Bluetooth function and battery level are shown on the right.

Drag the status bar down from the top of the screen to open the notification panel.

Notification Panel

You can check the details of notifications on the notification panel. You can also open applications directly by tapping notifications on the notification panel.

Status bar











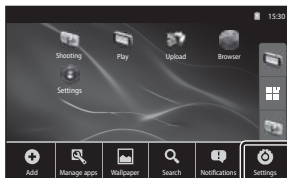

Notification panel



Using Android™ Platform Setting Menu

On the home screen or applications screen, press the **MENU** button and tap **Settings** to set the options listed below.



Option	Description	
Wireless & networks	Configure the wireless communication settings such as the Wi-Fi (wireless LAN) settings, and Bluetooth settings.	80,  17,  70
Sound	Configure the sound settings such as Audible selection.	 71
Display	Configure screen display settings such as monitor brightness and display off mode.	 71
Location & security	Set Use GPS satellites to on in GPS options, and configure the security settings.	 72
Applications	Set how applications are installed and opened, and manage applications that are already installed on the camera.	89
Accounts & sync	Configure basic settings for managing online service accounts and synchronizing user data.	82
Privacy	Configure data backup settings, reset your personal data or reboot the camera.	 72,  73
Storage	Check the amount of space available on the memory card, in COOLPIX S800c's internal memory and format the memory card, etc.	 73
Language & keyboard	Select the display language and set the text input settings.	 74
Voice input & output	Configure the voice recognition and text-to-speech settings.	–
Accessibility	Configure the settings for user accessibility services.	–
Date & time	Configure the date and time settings, and set the date/time display format.	84
About camera	Check the battery level and other basic information about the camera, view the software version, and update the system software.	–

Using the Option Menu

On the home screen or applications screen, press the **MENU** button to set the options listed below.

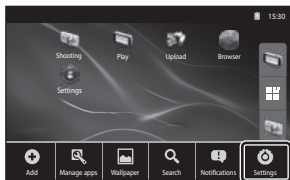

Option	Description	
Add	You can add shortcuts and widgets to the home screen and create new folders to manage shortcuts, etc. You can also change the wallpaper on the home screen.	-
Manage apps	You can check the information of installed applications, delete applications, etc.	-
Wallpaper	You can select an image to use as home screen wallpaper.	-
Search	Open the Google™ search screen.	93
Notifications	Open the notification panel.	90
Settings	Display the Android™ platform setting menu.	91

Notes About Locking the Screen

- If you have set an unlock procedure in **Set up screen lock** in **Location & security**, use the procedure to unlock the screen.
- Make a note of your unlock procedure so that you do not forget it.
- If you forget your unlock procedure, you will not be able to unlock the screen. If this happens, contact a Nikon-authorized service representative.

Using the Applications

An Internet connection is required in order to use online service. Set up your Wi-Fi (wireless LAN) network (📖80).

Searching for Information

You can search for files saved in the COOLPIX S800c or information on the Internet. On the home screen, press the **MENU** button and tap **Search** to display the search screen.

- Enter the search keyword and tap **Go** or tap any of suggested search terms to display the search results. For more information about entering text, see “Entering Text” (📖86).
- To start a new search, press the ↶ (back) button.



Using the Internet

You can also use the Internet browser to search for information, just as you would on a personal computer.

- Tap  (browser) on the home screen to open the browser.
- Tap the address (URL) bar at the top of the browser window.
- Enter a URL or search keyword, and tap **Go** or tap one of the suggested search terms to display the corresponding web page. For more information about entering text, see “Entering Text” (📖86).
- To start a new search, press the ↶ (back) button.

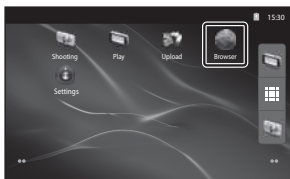

Using Google Play Store (Getting Applications)



This service may not be available depending on the country or region.

- 1 Tap the  icon on the applications screen.
 - When you access Google Play Store for the first time, the terms of service are displayed.
- 2 Search for applications by category or keyword, and then tap the one you want to download.
- 3 Check the description, reviews, and other information about the application, and follow the on-screen instructions to download it.

Notes About Installing Applications

- You are responsible for confirming the safety of applications before installing them. Some applications may contain viruses or other unwanted software that can damage or destroy the data on your device. To help prevent virus infection, we recommend that you periodically scan for viruses (using tools such as online virus scanners) and install anti-virus software.
- Please note that in the event you install an application that causes problems, Nikon assumes no responsibility for any loss or damage to you or any third party arising from the application you installed.
- There is no guarantee that the COOLPIX S800c will work with all applications.

Notes About Shooting Applications

- Some of the COOLPIX S800c camera functions may not be available when you use a shooting application other than the COOLPIX S800c shooting application. To fully enable all COOLPIX S800c functions, press the  (home) button, tap the **Shooting** icon on the home screen, and use the COOLPIX S800c shooting application (89).
- To shoot movies, use the COOLPIX S800c shooting application in movie mode (69).

Note About Pre-installed Applications

A variety of applications are pre-installed in the COOLPIX S800c at the time of purchase.

For more information on the various Google applications installed in the camera, visit the following URL:

<http://www.google.com/support/mobile/?hl=en>

Please note that this site is managed by Google Inc., and is subject to change without notice.



Reference Section

The Reference Section provides detailed information and hints for using the camera.

Shooting

Using Easy Panorama (Shooting and Playback) 2

Playback

Editing Images (Still Images) 5

Connecting the Camera to a TV (Playback on a TV) 15

Playing Audio via Bluetooth Device 17

Transferring Images to Your Smart Device 20

Menu

The Shooting Menu (for (Auto) Mode) 26

The Smart Portrait Menu 40

The Playback Menu 42

The Movie Menu 52

The Setup Menu 55

Android™ Platform

Basic Settings for the Android™ Platform 70

Additional Information



File and Folder Names 75

Optional Accessories 76



Error Messages 77

Using Easy Panorama (Shooting and Playback)



Shooting with Easy Panorama

Enter shooting mode →  (shooting mode) icon* →  Scene →
 Easy panorama

* Displayed icon varies depending on the shooting mode.

You can select from  **Normal (180°)** (default setting) and  **Wide (360°)**.
See “Changing the Shooting Range” ()3) for more information.

1 Frame the first edge of the panorama scene, and then press the shutter-release button halfway to focus.

- The zoom position is fixed at the maximum wide-angle position.
- A grid is displayed in the monitor.
- The camera focuses on the subject at the center of the frame.
- Exposure compensation (49) can be set.
- If focus and exposure cannot be set on the main subject, try focusing on another subject positioned at the same distance from the camera as the intended subject (60).

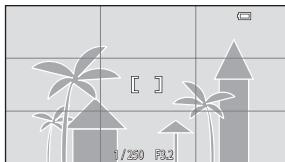

2 Press the shutter-release button all the way down, and then remove your finger from the shutter-release button.

-  is displayed to indicate the direction of the camera movement.



3 Move the camera slowly and straight in one of the four directions, and begin shooting.

- When the camera detects which direction it is moving in, shooting begins.
- A guide indicating the current shooting position is displayed.
- When the shooting position guide reaches the edge, shooting ends.



Guide

Example of Camera Movement

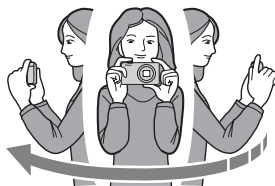

- The operator, without shifting position, moves the camera horizontally or vertically in an arc so that the guide travels from one edge to the other.
- Shooting stops if the guide does not reach the edge within about 15 seconds (when **STD Normal (180°)** is selected) or within about 30 seconds (when **WIDE Wide (360°)** is selected) after shooting starts.

✓ Notes About Easy Panorama Shooting

- The range of the image seen in the saved image will be narrower than that seen in the monitor at the time of shooting.
- If the camera is moved too quickly or shaken too much, or if the subject is too uniform (e.g. walls or darkness), an error may occur.
- If shooting stops before the camera reaches the halfway point in the panorama range, a panorama image is not saved.
- If more than half of the panorama range is captured but shooting ends before reaching the edge of the range, the range not captured is recorded and displayed in gray.

✍ Changing the Shooting Range

- In easy panorama scene mode, press the **MENU** button, tap , and tap **STD Normal (180°)** or **WIDE Wide (360°)**.
- When the camera is held in the horizontal position during shooting, the image size (width × height) is as follows:
 - **Normal (180°)**: 3200 × 560 when moved horizontally, 1024 × 3200 when moved vertically
 - **Wide (360°)**: 6400 × 560 when moved horizontally, 1024 × 6400 when moved vertically
- When the camera is held in the vertical position during shooting, the direction and the width and height are switched.

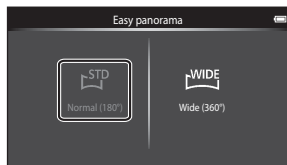

Viewing Images Captured with Easy Panorama (Scroll Playback)

If you switch to playback mode (📖26) and display an image taken using easy panorama in full-frame playback, ▶ is displayed.

Tap ▶ to display the short edge of the image using the entire monitor and automatically move (scroll) the displayed area.

- To scroll through the displayed image, drag your finger across the monitor (📖4).

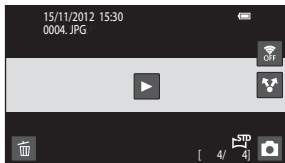

The operations listed below can be performed using the camera's touch panel.

Operation	Description	
Pause	Tap the monitor to pause scrolling.	
	Manual scrolling	While paused, drag your finger across the monitor (📖4) to scroll through the displayed image.
	Resume automatic scrolling	While paused, tap the monitor to resume automatic scrolling.
End	Press the ↶ (back) button.	

✔ Note About Easy Panorama Scroll Playback

The COOLPIX S800c may not be able to scroll the playback of, or zoom in on, easy panorama images taken with another make or model of digital camera.

Editing Images (Still Images)

Editing Functions

Use the COOLPIX S800c to edit images in-camera and store them as separate files (📷75). The editing functions described below are available.

Editing function	Description
Quick retouch (📷7)	Easily create retouched copies in which contrast and saturation have been enhanced.
D-Lighting (📷8)	Create a copy of the current image with enhanced brightness and contrast, brightening dark portions of the image.
Filter effects (📷9)	Apply a variety of effects using digital filters. The available effects are Color options , Soft , Selective color , Cross screen , Fisheye , and Miniature effect .
Skin softening (📷11)	Make facial skin tones softer.
Small picture (📷12)	Create a small copy of images suitable for use as email attachments.
Crop (📷13)	Crop a portion of the image. Use this function to zoom in on the subject or change the composition.

For information about **Rotate image** function, see page 📷49.

✓ Notes About Image Editing

- The editing functions of COOLPIX S800c cannot be used for images taken with another make or model of digital camera.
- Images taken using **Easy panorama** (📷38) cannot be edited. However, they can be rotated (📷49).
- If no face is detected in an image, a copy cannot be created using the skin softening function (📷11).
- Edited copies created with COOLPIX S800c may not be displayed properly on another make or model of digital camera. It also may not be possible to transfer them to a computer using another make or model of digital camera.
- Editing functions are not available when there is not enough free space in the internal memory or on the memory card.



Restrictions on Image Editing

When an edited copy is further modified with another editing function, check the following restrictions.



Editing function used	Editing function to use
Quick retouch D-Lighting Filter effects	The small picture, skin softening, or crop function can be used.
Skin softening	An editing function other than skin softening can be used.
Small picture	No other editing functions can be used.
Crop	No other editing functions can be used.

- Copies created with editing functions cannot be further edited with the same function used to create them.
- When combining the small picture or crop function and another editing function, use the small picture and crop functions after the other editing functions have been applied.
- Retouch effects can be applied to images taken with the skin softening function (54).

Original and Edited Images

- Copies created with editing functions are not deleted if the original images are deleted. The original images are not deleted if copies created with editing functions are deleted.
- Edited copies are stored with the same recording date and time as the original.
- The protect settings (44) and print order (46) of the original image are not applied to edited copies.

Quick Retouch: Enhancing Contrast and Saturation

Tap the playback mode icon (playback mode) → Select an image →
Press the MENU button → Tap  Retouch →  Quick retouch

- 1 Choose the degree of enhancement and tap .

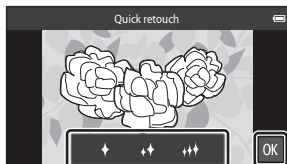

- 2 Tap Yes.

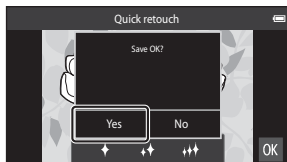

- A new, retouched copy is created.
- Copies created using the quick retouch function can be recognized by the  icon displayed in playback mode.



More Information

See "File and Folder Names" ( 75) for more information.

D-Lighting: Enhancing Brightness and Contrast

Tap the playback mode icon (playback mode) → Select an image → Press the MENU button → Tap  Retouch →  D-Lighting

1 Tap .

- The original version is shown on the left and the edited version is shown on the right.

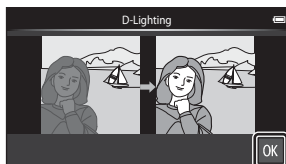

2 Tap Yes.

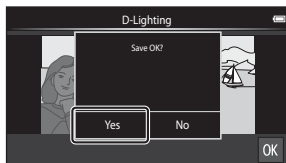

- A new, edited copy is created.
- Copies created using the D-Lighting function can be recognized by the  icon displayed in playback mode.











More Information

See "File and Folder Names" ( 75) for more information.

Filter Effects: Digital Filters

Tap the playback mode icon (playback mode) → Select an image →
Press the MENU button → Tap  Retouch →  Filter effects

Type	Description
 Color options	Modify color tones using color effects. The available color options are  (vivid color),  (black-and-white),  (sepia), and  (cyanotype).
SOFT Soft	Give the image a soft look by blurring the area surrounding the point that is tapped.
 Selective color	Keep one specified color in the image, and change the other colors to black and white.
 Cross screen	Produce star-like rays of light that radiate outward from bright objects such as sunlight reflections or city lights. This effect is suitable for night scenes.
 Fisheye	Make an image look as if it were taken with a fisheye lens. This effect is well-suited for images taken in macro mode.
 Miniature effect	Make an image look like a miniature scene taken in macro mode. This effect is well-suited for images taken from a high vantage point with the main subject at the center of the image.

1 Tap the icon of the desired effect.

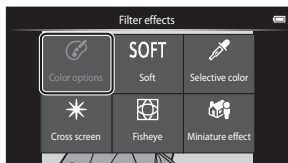

2 Adjust the effect.

- **Color options:** Select the color and tap **OK**.



- **Soft:** Tap the area where you want to apply the effect, select the effect level, and tap **OK**.
- **Selective color:** Tap the color slider to select the color to keep, and tap **OK**.
- **Cross screen, Fisheye, Miniature effect:** Check the results of the effect and tap **OK**.
- Press the  (back) button to return to step 1 without making any changes.

3 Tap Yes.



- A new, edited copy is created.
- Copies created using the filter effects function can be recognized by the  icon displayed in playback mode.



More Information

See "File and Folder Names" ( 75) for more information.

Skin Softening: Softening Skin Tones





Tap the playback mode icon (playback mode) → Select an image →
Press the MENU button → Tap  Retouch →  Skin softening

1 Tap the degree of enhancement.

- The confirmation screen is displayed, and the face with skin softening applied is enlarged at the center of the monitor.



2 Check the enhancement performance.

- Skin tones are softened in up to 12 faces, beginning with those closest to the center of the frame.
- Tap  to switch between the image before processing and the image after processing.
- If more than one face was softened, tap  or  to display a different face.
- Tap  to display the confirmation dialog for saving the new copy.

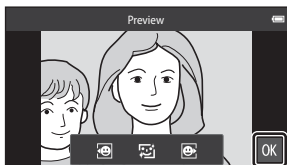

3 Tap Yes.

- An edited copy with the skin softening function is created.
- Copies created using the skin softening function can be recognized by the  icon displayed in playback mode.



Notes About Skin Softening

- The skin softening function cannot be performed when no face is detected in the image.
- Depending on the direction in which faces are looking, or the brightness of faces, the camera may be unable to accurately recognize faces, or the skin softening function may not perform as expected.





More Information

See "File and Folder Names" (75) for more information.



Small Picture: Making Smaller Images

Tap the playback mode icon (playback mode) → Select an image → Press the MENU button → Tap  Retouch →  Small picture

Create a small copy of the current image.

- The size of the small copy for images taken at an image mode setting of  **4608×2592** or  **1920×1080** is 640 × 360. For images taken at other sizes, the options of  **1600×1200**,  **640×480**, and  **320×240** are available.

1 Tap the desired small copy size icon and tap .

- Small picture size cannot be selected for images taken at an image mode setting of  **4608×2592** or  **1920×1080**. Tap .

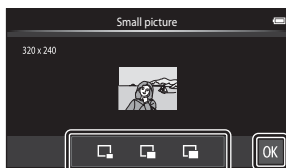

2 Tap **Yes**.

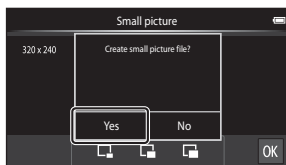

- A new, smaller copy is created (compression ratio of approximately 1:16).
- When the copy is played back, it is displayed smaller than the screen.



More Information



See “File and Folder Names” ( 75) for more information.

✂ Crop: Creating a Cropped Copy

Create a copy containing only the portion visible in the monitor when  is displayed with playback zoom (61) enabled. Cropped copies are stored as separate files.



1 Enlarge the image for cropping (.

2 Refine copy composition.

- Rotate the zoom control to **T** () or **W** () to adjust the zoom ratio.
- Drag the image so that only the portion to be cropped is visible in the monitor.



3 Tap .

- When  is not displayed, adjust the zoom ratio so that  is displayed.
- Portrait-oriented (“tall”) images cannot be cropped if the zoom ratio is too low.



4 Tap **Yes**.

- A cropped copy is created.
- Copies created using the crop function can be recognized by the  icon displayed in playback mode.



Editing Images (Still Images)

Image Size

- The aspect ratio of cropped copies is 16:9. As the area to be saved is reduced, the image size (pixels) of the cropped copy is also reduced.
- If an image is cropped smaller than 640 × 360, it cannot be saved as a cropped copy.

Keeping an Image's "Tall" Orientation When Cropping

Use the **Rotate image** option (49) to rotate the image so that it is displayed in landscape orientation. After cropping the image, rotate the cropped image back to "tall" orientation. The image displayed in "tall" orientation can be cropped by zooming in on the image until the black bars displayed on the both sides of the monitor disappear. The cropped image is displayed in landscape orientation.

More Information

See "File and Folder Names" (75) for more information.

Connecting the Camera to a TV (Playback on a TV)

Connect the camera to a TV to play back images or movies on the TV. If your TV is equipped with an HDMI port, an HDMI cable (commercially available) can be used to connect the camera to the TV.

1 Turn off the camera.

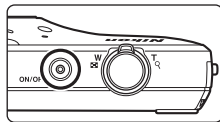

2 Connect the camera to the TV.

- Be sure that plugs are properly oriented. Do not attempt to insert plugs at an angle, and do not use force when connecting or disconnecting the plugs.
- Connect the plug to the HDMI jack on the TV.

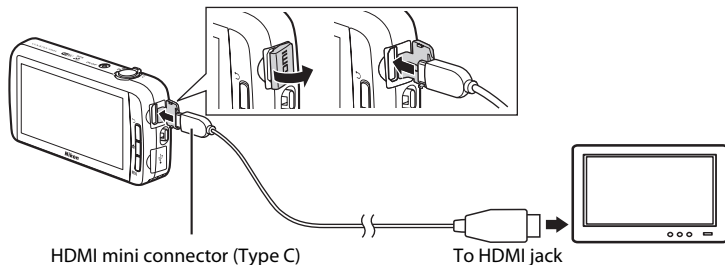

3 Tune the TV to the video channel.

- See the documentation included with your TV for details.

4 Turn on the camera.

- Images are displayed on the TV.
- See "Operations with TV Connection" (🔑 16) for more information.

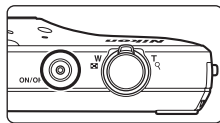

Operations with TV Connection

While images are displayed full-frame on the TV, the previous or next image can be viewed by dragging your finger across the camera monitor.

Thumbnail playback (📖62) and playback zoom (📖61) are possible just as with playback mode on the camera.

When the first frame of a movie is displayed, the movie can be played back by holding your finger on the camera monitor and removing it after about 1 second.

- If you tap the monitor while playing back a movie, only the control panel is displayed in the monitor. Tap the icons on the control panel to operate the camera (📖73).

✔ Notes About Connecting the HDMI Cable

- HDMI cable is not provided. Use a commercially available HDMI cable to connect the camera to a high-definition TV. The output terminal on this camera is an HDMI mini connector (type C). When purchasing an HDMI cable, be sure that the device end of the cable has an HDMI mini connector.
- An **Image mode** (🔧26) setting of **4K 2272×1704** or higher and a **Movie options** (🔧52) setting of **720p HD 720p (1280×720)** or higher are recommended for shooting images or movies that will be played back on a TV via HDMI connection.

✔ Connecting the Cable

Do not connect the HDMI cable and USB cable to the camera simultaneously.

✔ If the Images Are Not Displayed on the TV

Make sure that the **HDMI** (🔧61) setting in the setup menu conforms to the standard used by your TV.

Playing Audio via Bluetooth Device

When enjoying movies recorded with sound, you can use the COOLPIX S800c with Bluetooth-compatible audio devices such as headphones. The first time you use a Bluetooth device with your camera, you must “pair” it with the camera before connecting.

- The COOLPIX S800c supports the A2DP (Advanced Audio Distribution Profile) Bluetooth profiles.
- The COOLPIX S800c’s Bluetooth functions may not be compatible with some Bluetooth devices.
- Some Bluetooth devices may not be able to connect to the camera properly.
- For more information on using Bluetooth, refer to the documentation included with your Bluetooth device.



1 Enable the Bluetooth device.

- The Bluetooth device can be detected by the camera.

2 Display the home screen on the camera, press the MENU button, and tap **Settings**.

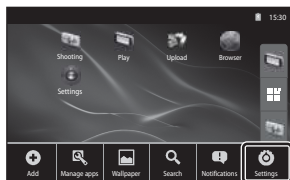

3 Tap **Wireless & networks**, and tap **Bluetooth settings**.

4 Tap the **Bluetooth** check box.

- The camera's Bluetooth function turns on.

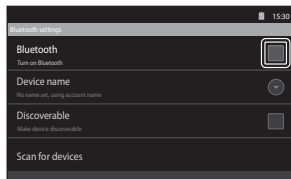

5 Tap **Scan for devices**.

- The camera searches for Bluetooth devices.
- When the camera finishes searching, a list of all nearby available Bluetooth devices is displayed.

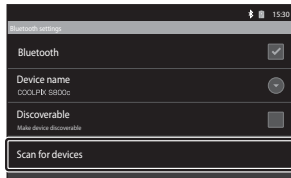

6 Tap the device in the list you want to pair.

- The camera starts pairing with the selected Bluetooth device.
- When pairing is complete, connection status is displayed under the name of the paired Bluetooth device.
- Some Bluetooth devices will automatically connect with the camera once pairing is complete.

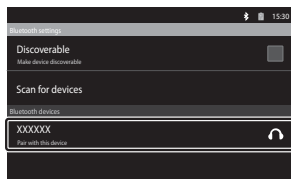

7 Touch and hold the name of the Bluetooth device you want to connect, and tap **Connect**.

- The camera connects to the Bluetooth device.
- The playback screen is displayed once the connection is established.

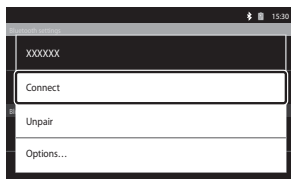

8 Play a movie (📖73).

- You can listen to the audio via the Bluetooth device.



Unpairing from a Bluetooth Device

Touch and hold the name of the Bluetooth device in the list in step 6 in “Playing Audio via Bluetooth Device” (🔗17) and tap **Unpair**.

✔ Pairing with a Bluetooth Device

When pairing the camera with some Bluetooth devices, a passkey input screen is displayed, prompting you to enter a passkey (pass code, PIN code, PIN number, or password). Check the passkey for the device, and enter it.

🔗 Reducing Battery Power Consumption

Battery power consumption is increased when the Bluetooth function is turned on, because the camera continues to perform wireless communications. Turn off the Bluetooth function by tapping the check box again on the screen shown in step 4 in “Playing Audio via Bluetooth Device” (🔗17).

Transferring Images to Your Smart Device

You can use the **Upload to smart device** application on the COOLPIX S800c to transfer images and movies from the camera to your Wi-Fi (wireless LAN) compatible smart device. To use this function, you must install the Connect to S800c application on your smart device. This function transfers images and movies from the camera to the smart device via a Wi-Fi (wireless LAN) connection, using the camera as an access point and the smart device as a client.

- For more information about operating your smart device, refer to the documentation included with the smart device.

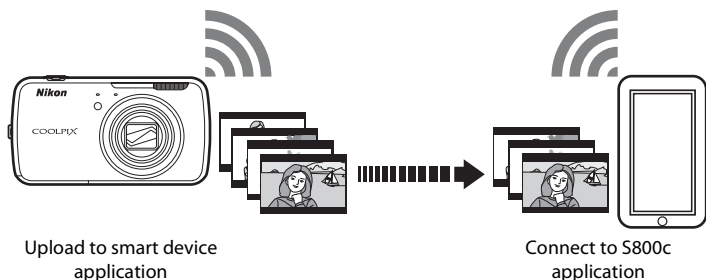

Installing the Connect to S800c Application on Your Smart Device

You must install the Connect to S800c application on your smart device before you can transfer images and movies from the camera.

- 1 Download the Connect to S800c application from the Market.
 - Find the application at the Market by searching for Connect to S800c.
- 2 Install the Connect to S800c application.

Market

"Market" is a generic term for application distribution services such as Google Play Store, which provides applications for devices running Google's Android™ platform operating system, or the App Store, which provides applications for devices running Apple's iOS operating system.

Simple Setup (Automatically Connecting the Camera to the Smart Device)

Turn on the Wi-Fi (wireless LAN) function when using the simple setup function to automatically connect the camera to your smart device. For more information about connecting to a Wi-Fi (wireless LAN) network, see “Setting Up a Wi-Fi (Wireless LAN) Network” (80).

Once a smart device has been configured with simple setup, you do not have to configure the settings again the next time you connect the smart device, see “Notes About Simple Setup” (23).

1 Open the **Upload to smart device** application on the camera screen.

- Open the Connect to S800c application on the smart device screen.
- For more information about opening applications, see “Opening Applications and Putting Them in Stand by Mode” (89).

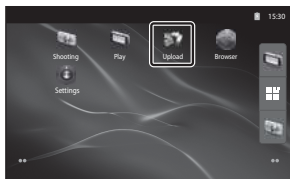

2 Tap **Simple setup** on the camera screen.

- After that, tap **Simple setup** on the smart device screen.



3 Tap **START** on the camera screen.

- After that, tap **START** on the smart device screen.



4 Position the camera near the smart device while the **Searching...** screen is displayed.

5 Wait for the camera to detect the smart device.

- If the “Activate Wi-Fi and select the camera SSID.” message is displayed when you are using an iOS smart device, follow the procedure below to configure the settings.
 - Make sure the smart device’s Wi-Fi (wireless LAN) function is on. If the Wi-Fi (wireless LAN) function is off, turn it on.
 - In the network list displayed on the smart device when the smart device’s Wi-Fi (wireless LAN) function is turned on, select the network SSID that is displayed on the camera screen.

After the settings are complete, display the Connect to S800c application screen again.

- When the camera detects the smart device, the authentication screen is displayed.

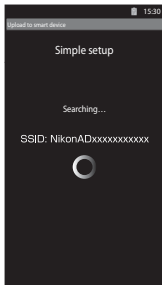

6 Confirm that the numbers on the camera screen match those on the smart device screen.

- If the numbers match, proceed to the next step.



7 Tap **OK** on both screens.

- The simple setup complete screen is displayed. Tap **OK** to complete the settings.
- When using an iOS smart device, the Install Profile screen is displayed. The profile starts installing automatically. Wait until the installation is complete.
 - If JavaScript is disabled, the settings cannot be completed. Enable JavaScript in the default browser application.
 - If the profile installation is canceled before completion, perform the simple setup procedure again.
 - If the settings are not completed properly, uninstall the profile and install it again.

✓ Notes About Simple Setup

- The simple setup function is not able to connect the COOLPIX S800c to multiple smart devices. The simple setup function can connect the camera to only one smart device.
- When you use the simple setup function to configure a new connection to a smart device other than the one that was previously configured, the previous connection settings are overwritten with the new ones. To use the previous connection settings, perform the simple setup procedure again.
- To reconfigure the previous connection settings when using an iOS4.x smart device, uninstall the previously installed camera profile before performing the simple setup procedure again.

Transferring Images from Camera to Smart Device

- 1 Tap **Start service** on the camera screen.



- 2 Tap **Connect to camera** on the smart device screen.

- The smart device initiates a connection with the camera using the settings you previously made, and the **Searching...** screen is displayed.
- If the "Activate Wi-Fi and select the camera SSID." message is displayed when you are using an iOS smart device, follow the procedure below to configure the settings.
 - Make sure the smart device's Wi-Fi (wireless LAN) function is on. If the Wi-Fi (wireless LAN) function is off, turn it on.
 - In the network list displayed on the smart device when the smart device's Wi-Fi (wireless LAN) function is turned on, select the network SSID that is displayed on the camera screen.





After the settings are complete, display the Connect to S800c application screen again.

3 Position the camera near the smart device while the **Searching...** screen is displayed.

- When the connection is established, the screen for selecting images for transfer is displayed on the smart device. The screen shows a list of images and movies saved in the camera.

4 On the smart device screen, select the images and movies you want to transfer.

- Select images one by one: When you tap an image or movie to select it for transfer, a check mark is displayed. Tap the image again to cancel the selection and remove the check mark.
- Select all: Tap ALL to select all images and movies on the display screen.
- Deselect all: Tap ALL to cancel the selection of all images and movies on the display screen.
- Change the folder: Tap  to display the folder selection screen. Tap  again to select the internal memory or memory card. When you specify a folder containing images you want to transfer, you can select the images in that folder.



5 Tap  on the smart device screen.

- The selected images are transferred from the camera to the smart device.
- When transferring is complete, the transfer completion screen is displayed.



6 Confirm the results on the smart device screen and tap **OK**.

- The screen returns to the one shown in step 4.

Changing the Connect to S800c Application Settings

Tap the menu icon at the upper right of the screen in step 4 of the procedure, the selection screen option menu is displayed, from which you can change the settings.



(Limit size)

You can set the maximum image size for transfer. When transferred images exceed the maximum file size set with the camera, they are reduced to the size when transferred. The available settings are shown below. To set a maximum image size for transfer, tap , select the desired setting, and tap **OK**.



Option	Description
None (default setting)	Transfer images at their original size.
1600×1200 (4:3) 1920×1080 (16:9)	The maximum image size for transfer is set to 1600 × 1200 (4:3)/1920 × 1080 (16:9).
640 × 480 (4:3) 640 × 360 (16:9)	The maximum image size for transfer is set to 640 × 480 (4:3)/640 × 360 (16:9).

(End connection)













To terminate the Wi-Fi (wireless LAN) connection between the camera and smart device, tap  and tap **Yes** on the confirmation screen.

The Shooting Menu (for (Auto) Mode)

Image Mode (Image Size and Quality)

Enter the  (auto) mode shooting screen → Press the MENU button →  Image mode

You can use the **Image mode** setting in the shooting menu to select the combination of image size and compression rate that is used when saving images. Choose the image mode best suited to the manner in which images will be used and the capacity of the internal memory or memory card. The higher the image mode setting, the larger the size at which it can be printed or displayed without appearing noticeably “grainy,” but limiting the number of images that can be recorded.

Image mode*	Description
 4608×3456★	Images are higher quality than  . The compression ratio is approximately 1:4.
 4608×3456 (default setting)	Best choice in most situations. The compression ratio is approximately 1:8.
 3264×2448	
 2272×1704	
 1600×1200	Smaller size than  ,  , or  allows more images to be stored. The compression ratio is approximately 1:8.
 640×480	Suited to full-screen display on a TV with an aspect ratio of 4:3, or distribution by email or the web. The compression ratio is approximately 1:8.
 4608×2592	Images with an aspect ratio of 16:9 are recorded.
 1920×1080	The compression ratio is approximately 1:8.

* The total number of pixels recorded, and the number of pixels recorded horizontally and vertically.



Example:  **4608×3456** = Approx. 16 megapixels, 4608 × 3456 pixels









Image Mode

- Changes made to this setting apply to all shooting modes (except movie recording).
- This setting may not be available with some functions. See “Functions That Cannot Be Used Simultaneously” (55) for more information.
- Image mode cannot be selected in **Easy panorama** scene mode (32).

 **Number of Exposures Remaining**

The following table lists the approximate number of images that can be stored on a 4 GB memory card. Note that the number of images that can be stored will vary depending on the composition of the image (due to JPEG compression). In addition, this number may vary depending on the make of memory card, even when the memory cards have the same specified capacity.

Check the shooting screen for the number of images that can be saved when recording to the internal memory (approx. 1.7 GB).

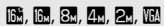



Image mode	Memory card ¹ (4 GB)	Print size (cm/in.) ²
 4608×3456★	470	Approx. 39 × 29/15 × 11.5
 4608×3456	930	Approx. 39 × 29/15 × 11.5
 3264×2448	1820	Approx. 28 × 21/11 × 8
 2272×1704	3610	Approx. 19 × 14/7.5 × 5.6
 1600×1200	6750	Approx. 13 × 10/5.3 × 4
 640×480	23900	Approx. 5 × 4/2 × 1.5
 4608×2592	1230	Approx. 39 × 22/15 × 8.5
 1920×1080	6320	Approx. 16 × 9/6.3 × 3.5

¹ If the number of exposures remaining is 10,000 or more, the number of exposures remaining display shows “9999”.



² Print size at an output resolution of 300 dpi. Print sizes are calculated by dividing the number of pixels by printer resolution (dpi) and multiplying by 2.54 cm (1 in.). However, at the same image size, images printed at higher resolutions will print smaller than the size indicated, and those printed at lower resolutions will print larger than the size indicated.



 **Image Mode Setting and Monitor Display**







Monitor display in shooting and playback modes varies as indicated below depending on the image mode setting.



Touch Shooting

Enter the  (auto) mode shooting screen → Press the **MENU** button → Tap  Touch shooting



- **Touch shutter** and **Touch AF/AE** can be used in  (auto) mode and other shooting modes, and the operations vary depending on the current shooting mode (30, 34).

Option	Description	
 Touch shutter (default setting)	Images can be taken by simply tapping the monitor.	 29
 Subject tracking	Use this option to take images of moving subjects. Tap the subject on which the camera will focus. The focus area will automatically move to track the subject.	 31
 Touch AF/AE	Tap the monitor to set the focus area. Press the shutter-release button to take the image with the focus and exposure achieved with the focus area.	 33

Tapping the Monitor to Release the Shutter (Touch Shutter)







Enter the  (auto) mode shooting screen → Press the **MENU** button → Tap /Touch shooting →  Touch shutter

Tap the desired subject to take an image.

- Do not use force when tapping the monitor as this may cause slight movement of the camera, resulting in blurred images.
- When digital zoom is in effect, the camera focuses on the subject at the center of the frame.
- The shutter-release button can also be used when the touch shutter option is selected.
- If  is displayed when the monitor is tapped, the shutter cannot be released. Tap an area inside the  or a border displayed when the camera detects a face.



Notes About Touch Shutter













- When a setting other than **Single** or **Multi-shot 16** is selected for the **Continuous** setting ()36), or in **Sports** scene mode ()32), use the shutter-release button to take images. Only one image can be taken at a time using the touch shutter function.
- Prevent shooting with accidental tapping of the monitor by changing the touch shooting setting to **Touch AF/AE** ()33) (except in some scene modes). At this setting, the shutter is not released when the monitor is tapped.
- When shooting a subject that is not suitable for autofocus, the camera may not be able to focus properly on the subject ()25).
- When a subject displayed in the monitor is tapped with the self-timer ()46) enabled, the camera locks focus and releases the shutter after 10 or 2 seconds.
- This setting may not be available with some functions. See “Functions That Cannot Be Used Simultaneously” ()55) for more information.

Touch Shooting Setting





The touch shooting setting applied in  (auto) mode is stored in the camera's memory even after the camera is turned off.

Shooting Modes That Support Touch Shutter

The touch shutter can be used in  (auto) mode and other shooting modes. Touch shutter operation varies depending on the current shooting mode, as described below.



Shooting mode	Touch shutter operation
 (easy auto) mode ( 30) and smart portrait mode (when Smile timer is set to Off ;  41)	<ul style="list-style-type: none"> When a face is detected by the camera, it is framed by a border. Tap a detected face to set the focus and exposure on that face. When no face is detected, focus is set for the area tapped.
 (auto) mode ( 31), Sports, Party/indoor, Beach, Snow, Close-up, Food, Black and white copy, Backlighting and Special effects ( 40) scene modes ( 32)	<p>Focus and exposure are set for the area tapped.</p>
Portrait and Night portrait scene modes ( 32)	<p>Only a border displayed by the face detection function can be selected. When the camera detects more than one face, tap a face framed by a single border to set focus and exposure for that face.</p>
Landscape, Sunset, Dusk/dawn, Night landscape, Fireworks show, and Easy panorama scene modes ( 32)	<p>Focus and exposure are set for the same focus area used when images are taken by pressing the shutter-release button. See "Selecting a Scene Mode (Features)" (34) for more information.</p>
Smart portrait mode (when Smile timer is set to On ;  41)	<p>Touch shutter cannot be enabled.</p>
Pet portrait scene mode ( 32)	<p>When Pet portrait auto release is set to On: Touch shutter cannot be enabled.</p> <p>When set to Off: Only borders displayed by the pet face detection function can be selected. When the camera detects more than one pet's face, tap a face framed by a single border to move the focus area to that face.</p>

Focusing on a Moving Subject (Subject Tracking)

Enter the  (auto) mode shooting screen → Press the **MENU** button → Tap // Touch shooting →  Subject tracking

 (subject tracking) is enabled only in  (auto) mode.

1 Register a subject.

- Tap the desired tracking subject in the monitor.
 - The subject is registered.
 - When the camera detects faces, tap a face framed by a border to register it as the subject and begin tracking. If the camera has detected more than one face, the borders around the faces that are not registered disappear.
 - When a subject other than a face is registered, a yellow focus area is displayed on the subject and the camera begins tracking the subject.
 - When the border framing the subject glows red, the camera is unable to focus. Change the composition and try again.
- If the tapped area does not contain a subject that can be registered,  is displayed in the monitor. Tap a subject inside the .
- Tap another subject to change a subject to follow.
- To cancel the registration of the subject, tap  displayed on the right side of the monitor.
- If the camera cannot track the registered subject anymore, the focus area will disappear and the registration will be canceled. Register the subject again.

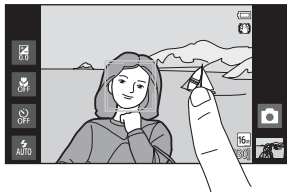





2 Press the shutter-release button to take an image.

- The camera focuses on the focus area when the shutter-release button is pressed halfway. The focus area glows green and focus is locked.
- When the camera is unable to focus, the focus area flashes. Press the shutter-release button halfway again to focus.
- If the shutter-release button is pressed halfway while the focus area is not displayed, the camera focuses on the subject at the center of the frame.
- Press the shutter-release button all the way down to release the shutter.





Notes About Subject Tracking Mode

- Digital zoom is not available.
- The sound of the lens focus motor can be heard when the subject tracking function is working.
- Adjust zoom and apply shooting settings (31) before selecting the subject. If zoom or any other setting is adjusted after the subject has been registered, subject registration will be canceled.
- It may be impossible to register the desired subject, or the camera may be unable to track the registered subject or may begin tracking a different subject, if the subject is moving rapidly, if there is a significant amount of camera shake, or if the camera detects a similar subject. The camera's ability to accurately track the registered subject also depends on the size and brightness of the subject.
- In some rare cases, subjects not suitable for autofocus (25) may be out of focus despite the fact that the focus area glows green. In this situation, focus on another subject which is at the same distance from the camera as the intended subject while the shutter-release button is pressed halfway (60).
- This setting may not be available with some functions. See "Functions That Cannot Be Used Simultaneously" (55) for more information.





Touch Shooting Setting

Subject registration with subject tracking will be canceled when the camera is turned off.

Tapping the Monitor to Focus (Touch AF/AE)

Enter the  (auto) mode shooting screen → Press the **MENU** button → Tap  Touch shooting →  Touch AF/AE

1 Tap the subject on which the camera focuses.

-  or a double border is displayed at the area tapped.
- When digital zoom is in effect, the focus area cannot be selected.
- To cancel the focus area selection, tap  displayed on the right side of the monitor.
- If a position at which focus cannot be acquired is tapped,  is displayed in the monitor. Tap another position inside .

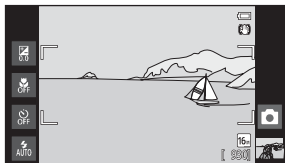
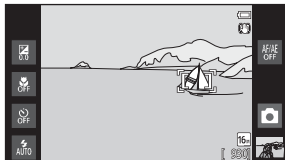

2 Press the shutter-release button to take an image.

- Press the shutter-release button halfway to acquire focus and exposure, and press it all the way down to release the shutter.



Note About Touch AF/AE



When shooting a subject that is not suitable for autofocus, the subject may not be in focus ( 25).

Touch Shooting Setting

The touch shooting setting applied in  (auto) mode is stored in the camera's memory even after the camera is turned off.

Shooting Modes That Enable Touch AF/AE Function

The touch AF/AE can be used in  (auto) mode and other shooting modes. Touch AF/AE operation varies depending on the current shooting mode, as described below.

Shooting mode	Touch AF/AE operation
 (easy auto) (📖30) and smart portrait mode (when Smile timer is set to Off ; 📖41)	<ul style="list-style-type: none"> When the camera detects a face, only a face framed by a border can be selected. When the camera detects more than one face, tap a face framed by a single border to set focus and exposure for that face. The single border changes to a double border. When no face is detected, focus is set for the area tapped.
 (auto) mode (📖31), Sports, Party/indoor, Beach, Snow, Close-up, Food, Black and white copy, Backlighting and Special effects (📖40) scene modes (📖32)	Focus and exposure are set for the area tapped.
Portrait and Night portrait scene modes (📖32)	Only a border displayed by the face detection function can be selected. When the camera detects more than one face, tap a face framed by a single border to move the focus area to that face.
Landscape, Sunset, Dusk/dawn, Night landscape, Fireworks show, and Easy panorama scene modes (📖32), smart portrait mode (when Smile timer is set to On ; 📖41)	Touch AF/AE cannot be enabled.
Pet portrait scene mode* (📖32)	When Pet portrait auto release is set to On : Touch AF/AE is disabled. When set to Off : Only borders displayed by the pet face detection function can be selected. When the camera detects more than one pet face, tap a face framed by a single border to set the focus and exposure on that face.



* Set **Pet portrait auto release** to **Off** to enable touch shutter (default setting) or touch AF/AE.

ISO ISO Sensitivity

Enter the  (auto) mode shooting screen → Press the **MENU** button → **ISO** ISO sensitivity

Raising the ISO sensitivity reduces the amount of light needed to make an exposure, allowing images to be taken in low light conditions. A higher sensitivity also allows for faster shutter speeds, reducing blur caused by subject movement or camera shake.



- High ISO sensitivity settings are useful when taking images in dim lighting, when shooting without a flash, or when using the telephoto setting, but they may also produce “noise” (randomly spaced, brightly colored pixels) in the dark areas of images.

Option	Description
 Auto (default setting)	Sensitivity is ISO 125 when there is sufficient lighting; the camera compensates by raising sensitivity to a maximum of ISO 1600 when lighting is poor.
 Fixed range auto	Limit the camera’s automatically adjusted ISO sensitivity range to between ISO 125 and ISO 400. By limiting the ISO sensitivity to a maximum of 400, this option moderates the amount of “grain” that appears in images.
125, 200, 400, 800, 1600, 3200	Sensitivity is locked at the specified value.









Notes About ISO Sensitivity



- This setting may not be available with some functions. See “Functions That Cannot Be Used Simultaneously” (□□55) for more information.
- When the ISO sensitivity setting is set to any option other than **Auto**, motion detection (□□25) is disabled.

Continuous

Enter the  (auto) mode shooting screen → Press the **MENU** button →  Continuous

Enable continuous shooting or **BSS** (best shot selector).

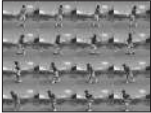
Option	Description
 Single (default setting)	One image is taken each time the shutter-release button is pressed.
 Continuous H	While the shutter-release button is held down, images are taken at a rate of about 8 frames per second (fps) when Image mode is set to  4608x3456 . Shooting ends when you remove your finger from the shutter-release button or after 3 images are taken.
 Continuous L	While the shutter-release button is held down, up to 18 images are taken at a rate of about 1.4 frames per second (fps) when Image mode is set to  4608x3456 . Shooting ends when you remove your finger from the shutter-release button.
 120 Continuous H: 120 fps	Each time the shutter-release button is pressed all the way, 50 frames are captured at a speed of about 120 frames per second (fps) or faster. Image mode is fixed at  (image size: 640 × 480 pixels).
 60 Continuous H: 60 fps	Each time the shutter-release button is pressed all the way, 25 frames are captured at a speed of about 60 frames per second (fps) or faster. Image mode is fixed at  (image size: 1280 × 960 pixels).
BSS BSS (Best Shot Selector)	The “best shot selector” is recommended when shooting with the flash off or the camera zoomed in, or in other situations in which inadvertent motion can result in blurred images. When BSS is on, the camera takes up to 10 images while the shutter-release button is held down. The sharpest image in the series is automatically selected and saved.

Option	Description
 Multi-shot 16	<p>Each time the shutter-release button is pressed all the way, camera takes 16 images at about 30 frames per second (fps) and arranges them in a single image.</p>  <ul style="list-style-type: none"> • Images are recorded at an image mode setting of  (image size: 2560 × 1920 pixels). This setting cannot be changed. • Digital zoom is not available.

Notes About Continuous Shooting

- When a setting other than **Single** is selected, the flash is disabled. Focus, exposure, and white balance are fixed at the values determined with the first image in each series.
- It may take some time to save the images after shooting. The amount of time it takes to finish saving the images depends on the number of images, image mode, the write speed of the memory card, etc.
- When ISO sensitivity increases, noise may appear in images taken.
- The frame rate with continuous shooting may vary depending on the current image mode setting, the memory card used, or shooting conditions.
- When **Continuous H: 120 fps**, **Continuous H: 60 fps** or **Multi-shot 16** is selected, banding or variance in brightness or hue may occur in images that were taken under lighting that flickers at high speeds, such as fluorescent, mercury-vapor, or sodium-vapor lighting.
- This setting may not be available with some functions. See “Functions That Cannot Be Used Simultaneously” (55) for more information.

Note About BSS

BSS is effective when taking images of still subjects. BSS may not produce the desired results if the subject moves or the composition changes while the shutter-release button is held down.







More Information

See “Subjects Not Suitable for Autofocus” (25) for more information.



WB White Balance (Adjusting Hue)

Enter the  (auto) mode shooting screen → Press the MENU button → WB White balance

The color of light reflected from an object varies with the color of the light source. The human brain is able to adapt to changes in the color of the light source, with the result that white objects appear white whether seen in the shade, direct sunlight, or under incandescent lighting. Digital cameras can mimic this adjustment by processing images according to the color of the light source. This is known as “white balance.” For natural coloration, choose a white balance setting that matches the light source before shooting. Although the default setting, **Auto** can be used under most types of lighting, the white balance setting suited to a particular light source can be specified manually to achieve more accurate results.

Option	Description
AUTO Auto (default setting)	White balance is automatically adjusted to suit lighting conditions. Best choice in most situations.
PRE Preset manual	Useful when shooting under unusual lighting. See “Preset Manual” ( 39) for more information.
 Daylight	Use under direct sunlight.
 Incandes.	Use under incandescent lighting.
 Fluorescent	Use under fluorescent lighting.
 Cloudy	Use when taking images under overcast skies.
 Flash	Use with the flash.

Note About White Balance Setting

Turn the flash off  (Off) (44) at white balance settings other than **Auto** or **Flash**.

Preset Manual

The preset manual option is effective with mixed lighting or to compensate for light sources with a strong color cast when the desired effect has not been achieved with white balance settings like **Auto** and **Incandes**. (for example, to make images taken under a lamp with a red shade look as though they had been taken under white light). Follow the procedure below to measure the white balance value according to the light source when shooting.

1 Place a white or gray reference object under the lighting that will be used during shooting.

2 Press the **MENU** button and tap **WB**.



3 Tap **PRE**.

- The camera zooms in to the position for measuring white balance.
- To end the setting screen without measuring, tap **OK** or press the  (back) button.



4 Frame the reference object in the measuring window.

- To apply the most recently measured value for preset manual, tap **Cancel**.

Measuring window

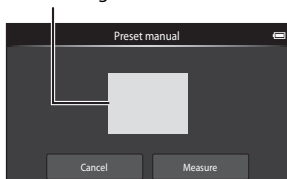

5 Tap **Measure** to measure a new white balance value.



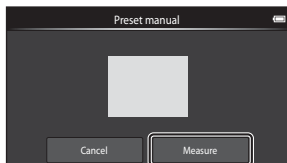



- The shutter is released and the new white balance value is set. No image is recorded.



Note About Preset Manual

A value for flash lighting cannot be measured with **Preset manual**. When shooting using the flash, set **White balance** to **Auto** or **Flash**.



The Smart Portrait Menu

- See “ **Image mode**” (0026) in “The Shooting Menu (for  (Auto) Mode)” for information about  **Image mode** (Image Size and Quality).
- See “/Touch Shooting” (0028) in “The Shooting Menu (for  (Auto) Mode)” for information about  **Touch shooting**.

Skin Softening

Enter the smart portrait mode screen → Press the **MENU** button →  Skin softening

Enable or disable skin softening.

Option	Description
 High	When the shutter is released, the camera detects one or more human faces (up to three), and processes the image to soften facial skin tones before saving the image. You can select the amount of effect that is applied.
 Normal (default setting)	
 Low	
OFF Off	Turns skin softening off.

The effects of skin softening are not visible when framing images for shooting. Check the degree of skin softening results in playback mode.

Blink Proof

Enter the smart portrait mode screen → Press the **MENU** button →  Blink proof

The camera automatically releases the shutter twice each time an image is taken. Of the 2 shots, one in which the subject's eyes are open is saved.

Option	Description
ON On	When On is selected, the flash is disabled. If the camera saved an image in which the subject's eyes may have been closed, the dialog shown at right is displayed for a few seconds. 
OFF Off (default setting)	Turns the blink proof off.

Smile Timer

Enter the smart portrait mode screen → Press the **MENU** button →  Smile timer

The camera detects human faces and automatically releases the shutter whenever a smile is detected.

Option	Description
ON On (default setting)	Enables the smile timer.
OFF Off	Turns the smile timer off.

The Playback Menu



- See “Editing Images (Still Images)” (005) for information about  **Retouch**.

Slide Show

Tap the playback mode icon (playback mode) → Press the **MENU** button →  Slide show

Play back images stored in the internal memory or on a memory card one by one in an automated “slide show.”

1 Tap **Start**.

- To change the interval between images, tap  (frame interval) and select the desired interval before tapping **Start**.
- To repeat the slide show automatically, tap  (loop) before tapping **Start**.

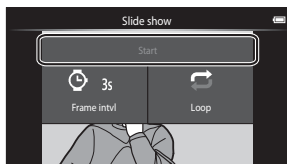

2 The slide show begins.

- Tap the monitor to display the operation panel at the bottom of the screen.

Tap the icons in the operation panel to perform the corresponding operations. The operations listed below are available.





To	Tap	Description
Rewind		Touch and hold to rewind the slide show.
Advance		Touch and hold to advance the slide show.
Pause		Pause playback. <ul style="list-style-type: none"> • To resume playback, tap • Tap to rewind, and tap to advance.
End		End the slide show and return to step 1.

Notes About Slide Show

- When a movie is played back in a slide show, only its first frame is displayed.
- Images taken using easy panorama (2) are not played back in slide shows.
- The maximum playback time is up to 30 minutes even if **Loop** is enabled (71).

Protect

Protect selected images from accidental deletion. Note that formatting the camera's internal memory or the memory card will permanently delete protected files (73). Protected images are recognized by the  icon in playback mode (8).

Protecting 1 Image

Tap the playback mode icon (playback mode) → Select an image →
Press the MENU button →  Protect

Tap **ON On.**

- The selected image is protected.
- To continue protecting another image, drag the current image.

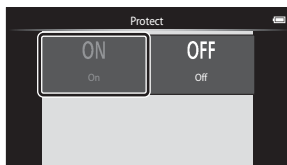

Protecting Multiple Images

Multiple images can be protected at a time.

Tap the playback mode icon (playback mode) → Display thumbnails (📖62) →
Press the MENU button →  Protect

1 Tap the desired images to be protected.

- When an image is selected, a check mark is displayed. To cancel the selection, tap the image again.
- Rotate the zoom control to **T** (🔍) or **W** (📐) to change the number of images displayed.



2 Tap **OK**.

- The selected images are protected.



Removing Protection from Images

- To remove protection from an image, display a protected image in full-frame playback mode, tap **Off** in “Protecting 1 Image” (🔒44).
- To remove protection from multiple images at a time, uncheck protected images in step 1 of “Protecting Multiple Images”.

Print Order (Creating a DPOF Print Order)

When printing images stored on the memory card using any of the following methods, the **Print order** option in the playback menu is used to create digital “print orders” for printing on DPOF-compatible devices.

- Inserting the memory card into a DPOF-compatible (🔦19) printer’s card slot.
- Taking the memory card to a digital photo lab.
- Images selected for printing are recognized by 📄 (📖8) displayed during playback.

Creating a Print Order for 1 Image

Tap the playback mode icon (playback mode) → Select an image →
Press the MENU button → 📄 Print order

1 Tap the desired number of copies (up to nine copies) and tap **OK**.

- To make a print order for another image, drag the current image before tapping **OK**.

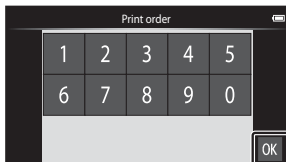

- If the total number of the images in a print order, including images just added, exceeds 99, the screen shown at right will be displayed.
 - Tap **Yes** to remove images previously added from the print order and restrict the print order to images just marked.
 - Tap **Cancel** to remove the images just added from the print order and restrict the print order to images previously marked.

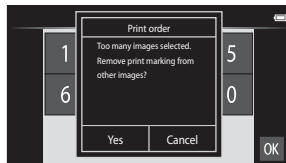



2 Choose whether or not to print shooting date and photo information.

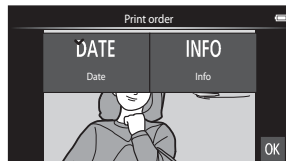

- Tap **Date** to display a check mark and imprint the shooting date on the image.
- Tap **Info** to display a check mark and imprint the photo information (shutter speed and aperture value) on the image.
- Tap **OK** to complete the print order.



Creating a Print Order for Multiple Images

Tap the playback mode icon (playback mode) → Display thumbnails (📖62) → Press the MENU button →  Print order

- 1** Tap the desired images to print (up to 99) and tap  or  at the right of the monitor to specify the number of copies (up to nine copies) for each.

- Images selected for printing can be recognized by the check mark (✓) and the numeral indicating the number of copies to be printed. Revert the number of copies to [0] to cancel the image selection.
- Rotate the zoom control to **T** (📐) or **W** (📏) to change the number of images displayed.
- Tap  to cancel the print order for all images.
- Tap  when setting is complete.



- 2** Choose whether or not to print shooting date and photo information.

- Tap **Date** to display a check mark and imprint the shooting date on all images in the print order.
- Tap **Info** to display a check mark and imprint the photo information (shutter speed and aperture value) on all images in the print order.
- Tap  to complete the print order.

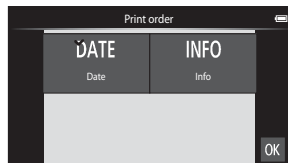

Canceling Print Order

- To remove a print marking from an image, display an image selected for printing in full-frame playback mode, follow the procedure in “Creating a Print Order for 1 Image” (🔗46), and tap **0** in step 1.
- To remove print markings from multiple images at a time, remove the print markings of the desired images in step 1 of “Creating a Print Order for Multiple Images” (🔗47). Tap  to remove print markings from all images.

✓ Notes About Printing with Shooting Date and Photo Information

When the **Date** and **Info** settings are enabled in the print order option, shooting date and photo information are printed on images when a DPOF-compatible printer (🔗19) which supports printing of shooting date and photo information is used.



- Note that **Date** and **Info** settings are reset when the print order option is displayed.
- The date printed is that saved when the image was taken. Changing **Set date**, **Select time zone**, or **Set time** in the **Date & time** option from the Android™ platform setting menu (🔗91) after an image is taken has no effect on the date printed on the image.



Print Date

When date and time of recording are imprinted on images using the **Print date** option (🔗57) in the setup menu, images are recorded with shooting date and time imprinted on the image when they are taken. Images with the date imprinted on them can be printed from printers that do not support printing of the date on images. Only the date and time imprinted on images using the **Print date** option will be printed, even if the date print option is enabled in the **Print order** menu.

Rotate Image

Tap the playback mode icon (playback mode) → Press the MENU button → Tap  Retouch →  Rotate image

Specify the orientation in which to display recorded images during playback. Still images can be rotated 90 degrees clockwise or 90 degrees counterclockwise. Images that were recorded in portrait (“tall”) orientation can be rotated up to 180 degrees in either direction.

- Tap  or  to rotate the image 90 degrees.

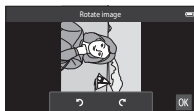

Rotate 90 degrees
clockwise

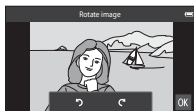

Rotate 90 degrees
counterclockwise

- Tap **OK** to finalize display orientation and save the orientation information with the image.

Copy (Copy Between Internal Memory and Memory Card)

Tap the playback mode icon (playback mode) → Press the MENU button →  Copy

Copy images between the internal memory and a memory card.

1 Tap the copy destination.

- **Camera to card:** Copy images from internal memory to memory card.
- **Card to camera:** Copy images from memory card to internal memory.

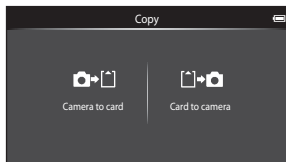

2 Tap a copy option.

- **Selected images:** Copy selected images. Proceed to step 3.
- **All images:** Copy all images. When a confirmation dialog is displayed, tap **Yes**. Images are copied. To cancel copying, tap **No**.

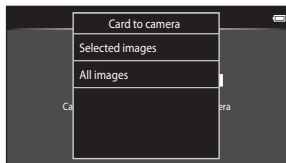

3 Tap the images to be copied.

- When an image is selected, a check mark is displayed. Tap the image again to cancel the selection and remove the check mark.
- Rotate the zoom control to **T** (Q) or **W** (Z) to change the number of images displayed.





4 Tap **OK**.

- When the confirmation dialog is displayed, tap **Yes**. Images are copied. To cancel copying, tap **No**.



Notes About Copying Images

- JPEG- and MOV-format files can be copied. Files recorded in any other format cannot be copied.
- Operation is not guaranteed with images taken with another make of camera or that have been modified on a computer.
- When images selected for **Print order** (46) are copied, print order marking is not copied with images (copies will not be included in the print order). However, **Protect** (44) setting is copied with images.
- If you press the  (home) button while the camera is copying images, the copying process stops and the Android™ platform home screen is displayed. Do not perform any operations until the message disappears.

“Memory contains no images.” Message



If there are no images stored on the memory card when playback mode is applied, the **Memory contains no images.** message is displayed. Press the **MENU** button, tap  to display the copy option screen, and copy the images saved in the camera’s internal memory to the memory card.

More Information



See “File and Folder Names” (75) for more information.

The Movie Menu





Movie Options

Set the shooting mode to  (movie) → Press the MENU button →  Movie options

Select the desired movie option to record. Larger image sizes and faster movie bitrates mean greater image quality and larger movie file sizes.





- The movie bitrate is the volume of movie data recorded per second. Variable bitrate (VBR) encoding is used to automatically adjust the bitrate depending on the subject being recorded. When recording movies with large amounts of motion, the file size increases.
- See page 71 for information on maximum movie length.
- When recording normal speed movies, select one of the normal speed movie options (52), and when recording HS movies, select one of the HS movie options (.

Normal Speed Movie Options

Option	Movie bitrate	Description
 HD 1080p★(1920×1080) (default setting)	Approx. 14 Mbps	Movies with an aspect ratio of 16:9 are recorded. This option is suited to playback on a widescreen TV.
 HD 1080p (1920×1080)	Approx. 12 Mbps	Movies with an aspect ratio of 16:9 are recorded. This option is suited to playback on a widescreen TV.
 HD 720p (1280×720)	Approx. 9 Mbps	Movies with an aspect ratio of 16:9 are recorded.
 VGA (640×480)	Approx. 3 Mbps	Movies with an aspect ratio of 4:3 are recorded.

- The frame rate is approximately 30 frames per second in any options.

HS Movie Options

Option	Movie bitrate	Description
 HS 240 fps (320×240)	Approx. 640 kbps	1/8-speed slow motion movies with a 4:3 aspect ratio are recorded. <ul style="list-style-type: none"> Max. recording time: 10 seconds (playback time: 80 seconds)
 HS 120 fps (640×480)	Approx. 3 Mbps	1/4-speed slow motion movies with a 4:3 aspect ratio are recorded. <ul style="list-style-type: none"> Max. recording time: 15 seconds (playback time: 1 minute)
 HS 60 fps (1280×720)	Approx. 9 Mbps	1/2-speed slow motion movies with a 16:9 aspect ratio are recorded. <ul style="list-style-type: none"> Max. recording time: 30 seconds (playback time: 1 minute)
 HS 15 fps (1920×1080)	Approx. 14 Mbps	2x speed fast motion movies with a 16:9 aspect ratio are recorded. <ul style="list-style-type: none"> Max. recording time: 2 minutes (playback time: 1 minute)



More Information

See "File and Folder Names" (p.75) for more information.



Touch Shooting

Set the shooting mode to  (movie) → Press the MENU button →  Touch shooting

Select **On** (default setting) or **Off** to set whether or not movie recording starts or ends whenever you tap the monitor while in movie mode.

AF Autofocus Mode



Set the shooting mode to  (movie) → Press the MENU button → AF Autofocus mode

Select the autofocus method used when recording movies.

Option	Description
AF-S Single AF (default setting)	Focus is locked when movie recording starts. Select this option when the distance between the camera and the subject will remain fairly consistent.
AF-F Full-time AF	Camera focuses continuously. Select this option when the distance between the camera and subject will change significantly during recording. The sound of the camera focusing may be heard in the recorded movie. Use of Single AF is recommended to prevent the sound of the camera focusing from interfering with recording.

- When an HS movie option is selected in **Movie options**, the setting is fixed to **Single AF**.

Wind Noise Reduction

Set the shooting mode to  (movie) → Press the MENU button →  Wind noise reduction

Select whether to reduce wind noise when recording movies.

Option	Description
ON On	Reduces the sound heard when wind passes over the microphone. Use when recording movies in locations with strong winds. Other sounds may become difficult to hear during playback.
OFF Off (default setting)	Wind noise reduction is not enabled.

- When an HS movie option is selected in **Movie options**, the setting is fixed to **Off**.

The Setup Menu

Welcome Screen

Display the shooting or playback screen → Press the **MENU** button → Tap **Y** Set up → Welcome screen

Choose whether or not a welcome screen is displayed when the camera is turned on.

Option	Description
None (default setting)	The camera enters shooting or playback mode without displaying the welcome screen.
COOLPIX	The camera displays a welcome screen before entering shooting or playback mode.

Monitor Settings

Display the shooting or playback screen → Press the **MENU** button → Tap **Y** Set up → Monitor settings

Set the options below.

Option	Description
Photo info	<p>Select whether or not the photo information in the monitor is automatically hidden during shooting and playback. See "Indicators and Operations of the Monitor/Touch Panel" (📖6) for more information.</p> <ul style="list-style-type: none"> • Show info: Photo information is always displayed. • Auto info (default setting): During playback, photo information is hidden if no operations are performed for a few seconds. The information is displayed again when the next operation is performed. During shooting, some of the operation icons and shooting information are hidden if no operations are performed for a few seconds. They are displayed again when DISP is tapped. • Framing grid+auto info: A framing grid is displayed as a reference for framing an image. The grid is not displayed when recording movies.
Image review	<ul style="list-style-type: none"> • On (default setting): Image is automatically displayed in the monitor immediately after it is taken and the monitor display returns to shooting mode. • Off: Image is not displayed after it is taken.

Print Date (Imprinting Date and Time)

Display the shooting or playback screen → Press the **MENU** button → Tap **Y** Set up → Print date

The shooting date and time can be imprinted on the images when shooting, allowing the information to be printed even from printers that do not support date printing (📷48).



Option	Description
DATE Date	Date is imprinted on images.
DATE 📅 Date and time	Date and time are imprinted on images.
Off (default setting)	Date and time are not imprinted on images.

At settings other than **Off**, the icon for the current setting is displayed in the monitor (📖6).

✔ Notes About Print Date

- Imprinted dates form a permanent part of image data and cannot be deleted.
- The date cannot be imprinted in the following situations:
 - When using **Sports**, **Backlighting** (when **HDR** is set to **On**), **Easy panorama**, or **Pet portrait** (when **Continuous** is selected) scene mode.
 - When **On** is selected for **Blink proof** (📷54) in smart portrait mode.
 - When a setting other than **Single** or **Multi-shot 16** is selected for the continuous setting (📷36).
 - When shooting movies.
- Dates imprinted at an **Image mode** setting (📷26) of **16M 640×480** may be difficult to read. Choose an **Image mode** setting of **24M 1600×1200** or larger when using the **Print date** option.
- The date is recorded using the format selected in the Android™ platform setting menu's **Date & time** option (📖84).

📎 Print Date and Print Order

When using a DPOF-compatible printer that supports the printing of shooting date and photo information, it is possible to use the **Print order** option (📷46) to print such information even on images that were not taken using the **Print date** option.



Vibration Reduction

Display the shooting or playback screen → Press the **MENU** button → Tap  **Set up** → **Vibration reduction**

Select the vibration reduction option for shooting.

Vibration reduction reduces blur, caused by slight hand movement known as camera shake, which commonly occurs when shooting with telephoto zoom or at slow shutter speeds. The effects of camera shake are reduced when recording movies, in addition to when taking still images.

Set **Vibration reduction** to **Off** when using a tripod to stabilize the camera during shooting.

Option	Description
 On (hybrid)	The effects of camera shake are reduced optically using a lens-shift method. Additional image processing with electronic vibration reduction is applied to further reduce the effects of camera shake with recording of still images taken under the following conditions: <ul style="list-style-type: none"> • When flash is disabled. • When a shutter speed slower than 1/60 seconds is used. • When Self-timer is disabled. • When Single is selected for the Continuous setting. • When ISO sensitivity is set to 200 or less.
 On (default setting)	The vibration reduction using the lens-shift method only is enabled.
Off	Vibration reduction is not enabled.

The current vibration reduction setting can be confirmed in the camera monitor during shooting (📖6). When **Off** is selected, no icon is displayed.

Notes About Vibration Reduction

- Vibration reduction may take a few seconds to activate after the power is turned on, or the camera enters shooting mode from playback mode. Wait until the image of the monitor stabilizes before shooting.
- Due to characteristics of the vibration reduction function, images displayed in the camera's monitor immediately after shooting may be displayed blurry.
- Vibration reduction may be unable to completely eliminate the effects of camera shake in some situations.
- Image processing with electronic vibration reduction may not perform as expected with very slight or extreme camera shake, even when **On (hybrid)** is selected.
- Image processing with electronic vibration reduction is not enabled at fast or extremely slow shutter speeds, even when **On (hybrid)** is selected.
- When **On (hybrid)** is selected and electronic vibration reduction is activated, the shutter is automatically released twice when an image is taken to allow for image processing. Therefore, the time required to record images increases. **Shutter sound** (🔊60) can be heard only when the shutter is released the first time and a single image will be recorded.

AF Assist

Display the shooting or playback screen → Press the **MENU** button → Tap **Y** Set up → AF assist

Enable or disable the AF-assist illuminator, which assists autofocus operation when the subject is dimly lit.

Option	Description
Auto (default setting)	AF-assist illuminator will be used to assist the focus operation when the subject is poorly lit. The illuminator has a range of about 2.0 m (6 ft 6 in.). Note that for some scene modes or focus areas, AF-assist illuminator may not light.
Off	Disable this function. The camera may be unable to focus under poor lighting.

Digital Zoom

Display the shooting or playback screen → Press the **MENU** button → Tap **Y** Set up → Digital zoom

Enable or disable digital zoom.

Option	Description
On (default setting)	When the camera is zoomed in to the maximum optical zoom position, rotating the zoom control to T (R) triggers digital zoom (📖23).
Off	Digital zoom will not be activated.

👍 Notes About Digital Zoom

- The camera focuses on the subject at the center of the frame when digital zoom is in effect.
- Digital zoom cannot be used in the following situations:
 - When **Portrait**, **Night portrait**, **Backlighting** (when **HDR** is set to **On**), **Easy panorama**, or **Pet portrait** scene mode is selected
 - When smart portrait mode is selected
 - When **Subject tracking** is selected for the touch shooting setting
 - When **Multi-shot 16** is selected (👁️37)

Shutter Sound

Display the shooting or playback screen → Press the **MENU** button → Tap  Set up → Shutter sound

Choose shutter sound from **On** (default setting) or **Off**.

No sound is played with shutter release when some features such as continuous shooting or BSS (best shot selector) are enabled, or when recording movies, even if **On** is selected.

Note About Shutter Sound

In **Pet portrait** scene mode, the shutter sound is disabled.

Shut-down Timer

Display the shooting or playback screen → Press the **MENU** button → Tap  Set up → Shut-down timer

In this menu, set the amount of time that elapses in stand by mode before the camera turns off. The settings are **1 hour** (default setting), **3 hours**, **5 hours**, **8 hours**, **12 hours**, and **Off**.

All unsaved data is lost when the camera turns off after the set amount of time. It is recommended that you save the data you want to keep before the camera enters stand by mode.

When the Monitor Turns Off to Save Power

- The power-on lamp flashes while the camera is in stand by mode.
- If no operations are performed for 1 hour (default setting) while in stand by mode, the camera turns off.
- While the power-on lamp is flashing, press the power switch to turn the monitor back on.

More Information

See "Power Supply Status and Power Saving Function" (📖19) for more information.

HDMI

Display the shooting or playback screen → Press the **MENU** button → Tap  Set up → HDMI

Adjust settings for connection to a TV.

Choose an image resolution for HDMI output from **Auto** (default setting), **480p**, **720p**, or **1080i**. When **Auto** is selected, the option best suited to the high-definition TV to which the camera is connected is automatically selected from **480p**, **720p**, or **1080i**.



HDMI

"HDMI" is the abbreviation for High-Definition Multimedia Interface and is one type of multimedia interface.

Blink Warning

Display the shooting or playback screen → Press the **MENU** button → Tap  Set up → Blink warning

Specify whether or not the camera detects human subjects that blink when shooting with face detection () in the following modes:

-  (easy auto) mode (30) or  (auto) mode (31).
- **Portrait** (34) or **Night portrait** (35) is selected for the scene mode.

Option	Description
On	When the camera detects that one or more human subjects may have blinked in an image taken using face detection, the blink warning screen is displayed in the monitor. The face of the human subject that may have blinked when the shutter was released is framed by a yellow border. Should this occur, check the image and determine whether or not another image should be taken. See "Operating the Blink Warning Screen" ( 62) for more information.
Off (default setting)	Blink warning is not enabled.



Note About Blink Warning





The blink warning does not function when a setting other than **Single** is used for the continuous setting.

Operating the Blink Warning Screen

When the blink warning screen shown at right is displayed in the monitor, the operations described below are available.

If no operations are performed within a few seconds, the camera automatically returns to shooting mode.



Operation	Icon	Description
Enlarge the detected face that blinked	T (Q)	Rotate the zoom control to T (Q). If the camera detects more than one human subject blinked, tap  or  to switch the display to another face.
Switch to full-frame playback	W (checkered flag)	Rotate the zoom control to W (checkered flag).
Delete images		Tap  .
Switch to shooting mode	OK	Tap OK . The shutter-release button can also be pressed to return to shooting mode.

GPS Options

Display the shooting or playback screen → Press the **MENU** button → Tap **Y** Set up → GPS options

When using **Record GPS data**, **Synchronize** and **Update A-GPS file**, set **GPS options** to on in **Location & security** in the Android™ platform setting menu.

Option	Description
Record GPS data	When set to On , positioning starts and location data is recorded for images (when shooting). <ul style="list-style-type: none"> • The default setting is Off.
Synchronize	Signals from the GPS satellite are used to set the date and time of the camera's internal clock (only when Record GPS data in GPS options in the setup menu is set to On). Check the positioning status before starting Synchronize .
Update A-GPS file	The memory card is used to update the A-GPS (assist GPS) file. Using the latest A-GPS file can shorten the time needed to determine the position information.





Notes About GPS

- When positioning for the first time, when positioning was unable to be performed for about 2 hours, or after the battery was changed, it takes a few minutes to obtain the position information. After switching to the shooting application from another application such as the playback application, it takes a few seconds to obtain the position information.
- Positions of the GPS satellites change constantly. You may not be able to determine the position or it may take some time depending on your location and the time. To use the GPS feature, use the camera in an open-air area with few obstacles in the sky. Signal receiving will be smoother if the GPS antenna (📖1) is facing the sky.
- If the camera needs to be turned off inside an airplane or hospital, set **Use GPS satellites** in **Location & security** in the Android™ platform setting menu (📖91) to off.
- The following locations which block or reflect signals may result in failed or inaccurate positioning.
 - Inside buildings or underground
 - Between high-rise buildings
 - Under overpasses
 - Inside tunnels
 - Near high-voltage electrical power lines
 - Between clusters of trees
 - Underwater
- Using a mobile phone of 1.5 GHz band near this camera may disrupt positioning.
- When carrying this camera around while positioning, do not place it in a metal bag. Positioning cannot be performed if the camera is covered with metal materials.
- When there is a significant difference in the signals from the GPS satellite, there could be a deviation of up to several hundred meters.
- Be aware of your surroundings when positioning.
- The shooting date and time that is displayed when playing back images is determined by the camera's internal clock at the time of shooting. The camera does not display the time at which position information was obtained for an image.
- Position information will be recorded on the first frame of images shot using continuous shooting mode.
- The Geodetic system for this camera's GPS function uses the WGS 84 (World Geodetic System 1984).

Notes About Synchronize

- The **Synchronize** function adjusts the date and time based on the time zone set in **Date & time** in the Android™ platform setting menu (📖91). Check the time zone before using **Synchronize**.
- The date and time set by the **Synchronize** function is not as accurate as that of radio clocks. If the time set by **Synchronize** is not accurate, set the time in **Date & time** in the Android™ platform setting menu (📖91).



GPS Reception Indicator

- GPS reception status can be checked on the shooting screen.
 - : Signals are being received from 4 or more satellites and positioning is being performed. Position information is recorded on the image.
 - : Signals are being received from 3 satellites and positioning is being performed. Position information is recorded on the image.
 - : Signals are being received from the satellite, but positioning is not possible. The position information is not recorded on the image.
 - : Signals cannot be received from the satellite, and positioning is not possible. The position information is not recorded on the image.

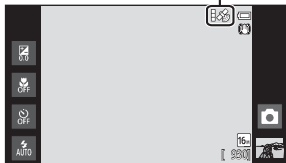
GPS reception status



Images with Recorded Position Information

- The  icon is displayed during playback for images which have the position information recorded (8).
- Position information recorded on an image can be checked on a map with ViewNX 2 after transferring the image to a computer (65).
- The actual place of shooting may differ from the GPS information recorded on the image files due to the accuracy of the position information obtained and a difference in the Geodetic system used.

Updating the A-GPS File

Download the latest A-GPS file from the website below, and use it to update the camera's A-GPS file.

<http://nikonimglib.com/agps3/>

- The A-GPS file for COOLPIX S800c is only available from the website above.

- 1** Download the latest A-GPS file to the computer from the website.
- 2** Use a card reader or other devices to copy the downloaded file to the "NCFL" folder of the memory card.
- 3** Insert the memory card containing the copied file into the camera.
- 4** Turn on the camera.
- 5** Press the **MENU** button to display the setup menu, then tap **GPS options**.
- 6** Select **Update A-GPS file**, and update the file.

Notes About Updating A-GPS File





- The A-GPS file is not enabled the first time positioning is performed after you purchase the camera. The file is enabled the second time positioning is performed.
- The validity period of the A-GPS file is 14 days. The validity period can be checked on the update screen.
- Once the validity period of the A-GPS file has expired, it takes more time to determine the position information. Updating of the A-GPS file before using the GPS feature is recommended.

Reset All









Display the shooting or playback screen → Press the **MENU** button → Tap  Set up → Reset all

When **Reset** is selected, the camera's settings are restored to their default values.







Basic Shooting Functions

Option	Default value
Flash mode ( 44)	Auto
Self-timer ( 46)	Off
Macro mode ( 48)	Off
Exposure compensation ( 49)	0

Shooting Menu

Option	Default value
Image mode ( 26)	 4608x3456
Touch shooting ( 29,  31,  33)	Touch shutter
ISO sensitivity ( 35)	Auto
Continuous ( 36)	Single
White balance ( 38)	Auto

Scene Mode

Option	Default value
Scene mode setting in the shooting mode menu ( 34)	Portrait
Scene effect adjustment slider ( 33)	Center
HDR (when Backlighting is selected) ( 37)	Off
Easy panorama ( 38)	Normal (180°)
Continuous (when Pet portrait is selected) ( 39)	Continuous
Pet portrait auto release (when Pet portrait is selected) ( 39)	On

Special Effects Mode

Option	Default value
Special effects mode setting in the shooting mode menu (📖40)	Soft

Smart Portrait Mode

Option	Default value
Skin softening (📖53)	Normal
Blink proof (📖54)	Off
Smile timer (📖54)	On

Movie Menu

Option	Default value
Movie options (🎞52)	1080p HD 1080p★(1920x1080)
Autofocus mode (🎞54)	Single AF
Wind noise reduction (🎞54)	Off

Setup Menu

Option	Default value
Welcome screen (🔧55)	None
Photo info (🔧56)	Auto info
Image review (🔧56)	On
Print date (🔧57)	Off
Vibration reduction (🔧58)	On
AF assist (🔧59)	Auto
Digital zoom (🔧59)	On
Shutter sound (🔧60)	On
Shut-down timer (🔧60)	1 hour
HDMI (🔧61)	Auto
Blink warning (🔧61)	Off
Record GPS data (🔧63)	Off

Others

Option	Default value
Frame interval for slide show (0042)	3 s

- Selecting **Reset all** also clears the current file number (0075) from memory. Numbering will continue from the lowest number available. To reset file numbering to "0001", delete all images stored in the internal memory or on the memory card (028) before selecting **Reset all**.
- The following settings will remain unaffected when menus are reset with **Reset all**.

Shooting menu: Preset manual data (039) acquired for **White balance:**

Setup menu: **Synchronize** under **GPS options** (063)

The Android™ platform setting menu will remain unaffected when menus are reset.

Firmware Version

Display the shooting or playback screen → Press the **MENU** button → Tap **Y** Set up → Firmware version

View the current camera firmware version.



Basic Settings for the Android™ Platform

Wireless & Networks

Display the Android™ platform home screen → Press the MENU button → Tap Settings → Wireless & networks

Adjust settings for wireless functions such as Wi-Fi (wireless LAN) settings and Bluetooth settings.

Option	Description
Airplane mode	Disable all wireless connections. The default setting is off.
Wi-Fi	Set Wi-Fi (wireless LAN) function to on or off (default setting).
Wi-Fi settings	Wi-Fi: Turn on the Wi-Fi (wireless LAN) function. The default setting is off. Network notification: Set to receive notification when an available open network is detected nearby. The default setting is on. Easy setup: Select Push-button WPS or PIN-entry WPS for the type of automatic connection settings used with Wi-Fi (wireless LAN) devices. Add Wi-Fi network: Add settings for another Wi-Fi (wireless LAN) connection.
Bluetooth	Set Bluetooth function to on or off (default setting).
Bluetooth settings	Bluetooth: Turn on the Bluetooth function. The default setting is off. Device name: Change the name displayed for your camera on other Bluetooth devices. Discoverable: Allow the camera to be detected by other Bluetooth devices. The default setting is off. Scan for devices: Search for available Bluetooth devices.

Brightness

Display the Android™ platform home screen → Press the **MENU** button → Tap Settings → Display → Brightness

Use the slider to adjust monitor brightness.

Audible Selection

Display the Android™ platform home screen → Press the **MENU** button → Tap Settings → Sound → Audible selection

Select whether or not to make a beep when an item such as a menu option is selected.

Display Off

Display the Android™ platform home screen → Press the **MENU** button → Tap Settings → Display → Display off

If no operations are performed for a specified period of time while the camera is turned on, the monitor turns off and the camera enters display off mode (📖19) to save power (except when playing back movies).

In this menu, set the amount of time that elapses before the camera enters display off mode. The settings are **15 seconds**, **30 seconds**, **1 minute** (default setting), **2 minutes**, **10 minutes**, and **30 minutes**.

When the Monitor Turns Off to Save Power

- The power-on lamp lights while the camera is in display off mode.
- If no operations are performed for 1 minute while in display off mode, the camera enters stand by mode.
- While the power-on lamp is lighting, press the power switch, the shutter-release button, ↶ (back) button, 🏠 (home) button, or **MENU** button to turn the monitor back on.

Display Off

Regardless of the option selected, the monitor will remain on for a fixed amount of time in the situations described below.

- When a setting screen is displayed: The time that is set for display off applies.
- During slide show playback: up to 30 minutes

More Information

See "Power Supply Status and Power Saving Function" (📖19) for more information.

Use GPS Satellites

Display the Android™ platform home screen → Press the **MENU** button → Tap **Settings** → **Location & security** → **Use GPS satellites**

When set to on, signals are received from GPS satellites.

- The default setting is off.
- When using **Record GPS data**, **Synchronize**, or **Update A-GPS file**, set the this function to on.

Reduce Battery Power Consumption

Battery power consumption is increased when the GPS function is turned on, because the camera continues to perform positioning. To reduce battery power consumption, set **Use GPS satellites** to off when you are not using the GPS function.

Reboot

Display the Android™ platform home screen → Press the **MENU** button → Tap **Settings** → **Privacy** → **Reboot**

Reboot the camera.

Erase SD Card (Format)

Display the Android™ platform home screen → Press the **MENU** button → Tap Settings → Storage → Erase SD card (Format)

Use this option to format a memory card.

Formatting the memory cards permanently deletes all data. **Deleted data cannot be recovered.** Be sure to transfer important images to a computer before formatting.

Erase SD Card

A memory card can be formatted when it is inserted in the camera.

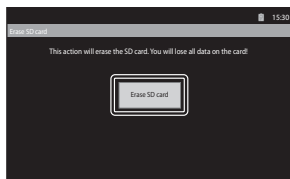

✓ Notes About Formatting Internal Memory and Memory Cards

- Do not turn the camera off or open the battery-chamber/memory card slot cover during formatting.
- The first time you insert a memory card that has been used in another device into this camera, be sure to format it with this camera.
- The memory card cannot be formatted in the following situations:
 - When the memory card is not inserted in the camera
 - When the memory card is locked
 - When the memory card is not recognized by the camera

📎 Formatting Internal Memory

- To format the internal memory, press the **MENU** button, tap **Settings > Privacy > Factory data reset** on the Android™ platform home screen. When **Erase SD card** is selected, the internal memory and memory card are formatted at the same time.

Select Language

Display the Android™ platform home screen → Press the **MENU** button → Tap Settings → Language & keyboard → Select language

Choose one of the languages listed below for display of camera menus and messages.

Čeština	Czech
Dansk	Danish
Deutsch	German
English	(default setting)
Español	Spanish
Ελληνικά	Greek
Français	French
Indonesia	Indonesian
Italiano	Italian
Magyar	Hungarian
Nederlands	Dutch
Norsk	Norwegian
Polski	Polish
Português (BR)	Brazilian Portuguese
Português (PT)	Portuguese

Русский	Russian
Română	Romanian
Suomi	Finnish
Svenska	Swedish
Tiếng Việt	Vietnamese
Türkçe	Turkish
Українська	Ukrainian
عربي	Arabic
简体中文	Simplified Chinese
繁體中文	Traditional Chinese
हिन्दी	Hindi
日本語	Japanese
한글	Korean
ภาษาไทย	Thai

File and Folder Names

Images or movies are assigned file names as follows.

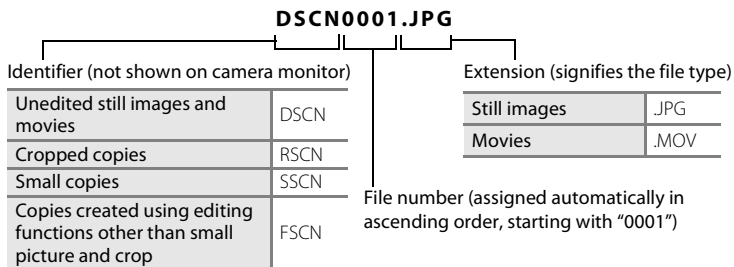

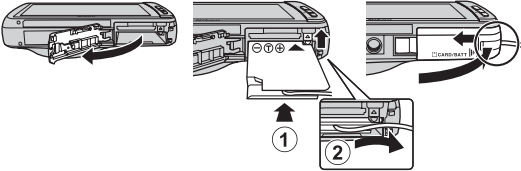

- Files are stored in folders named with a folder number followed by an identifier: "NIKON" (e.g. "100NIKON"). When the number of files within a folder reaches 9999, a new folder will be created. File numbers will be assigned automatically starting with "0001."
- Files copied using **Copy>Selected images** are copied to the current folder, where they are assigned new file numbers in ascending order starting from the largest file number in memory. **Copy>All images** copy all folders from the source medium; file names do not change but new folder numbers are assigned in ascending order, starting from the largest folder number on the destination medium (📷50).
- A single folder can hold up to 200 files; if the current folder already contains 200 files, a new folder, named by adding one to the current folder name, will be created the next time a file is stored. If the current folder is numbered 999 and contains 200 files, or a file is numbered 9999, no further files can be stored until the internal memory or memory card is formatted (📷73), or a new memory card is inserted.

Optional Accessories









Battery charger	Battery Charger MH-65 (Charging time when no charge remains: Approx. 2 h 30 min)
AC adapter	<p data-bbox="324 204 684 225">AC Adapter EH-62F (connect as shown)</p> <p data-bbox="337 235 348 256">1</p> <p data-bbox="544 235 555 256">2</p> <p data-bbox="772 235 783 256">3</p>  <p data-bbox="324 529 923 648">Be sure that the power connector cord has been properly aligned in power connector and battery-chamber grooves before closing the battery-chamber/memory card slot cover. If part of the cord runs out of the grooves, the cover or cord may be damaged when the cover is closed.</p>







Error Messages

The following table lists the error messages and other warnings displayed in the monitor, as well as the solutions for dealing with them.





Display	Cause/Solution	
 (flashes)	Clock not set. Set date and time.	84
Battery exhausted.	Battery exhausted. Charge or replace battery.	12, 14
Battery temperature high.	Battery temperature is high. Turn off camera, and allow battery to cool down before resuming use. When this message is displayed, the power-on lamp starts flashing quickly and the monitor turns off after 5 seconds.	19
The camera will turn off to prevent overheating.	Inside of the camera or the memory card has become hot. Turn off camera, and allow battery to cool down before resuming use.	19
Camera temperature high. Wi-Fi disabled.	Inside of the camera has become hot, and the Wi-Fi (wireless LAN) function has stopped. Press OK and allow inside of camera to cool down before resuming use.	–
Camera temperature high. Wireless disabled.	Inside of the camera has become hot, and the connection between camera and smart device has been terminated. Press OK and allow inside of camera to cool down before resuming use.	–
 ● (● flashes red)	Camera cannot focus. <ul style="list-style-type: none">• Refocus.• Focus on another subject positioned at the same distance from the camera as the intended subject.	24, 25 60
Please wait for the camera to finish recording.	Camera cannot perform other operations until recording is complete. Wait until message clears from display automatically when recording is complete. Do not open the battery-chamber/memory card slot cover during recording.	–

Error Messages

Display	Cause/Solution	
Please wait.	Camera cannot perform other operations until processing is complete. Wait until message clears from display automatically when processing is complete. Do not open the battery-chamber/memory card slot cover during processing.	–
Memory card is write protected.	Write-protect switch is in “lock” position. Slide write-protect switch to “write” position.	–
This card cannot be used.	Error accessing memory card. • Use approved card.	 19
This card cannot be read.	• Check that terminals are clean. • Check that memory card is correctly inserted.	16 16
Out of memory.	Memory card is full. • Choose smaller image size. • Delete images. • Insert new memory card. • Remove memory card and use internal memory.	53,  26 28 16 17
Image cannot be saved.	Error occurred while recording image. Format internal memory or memory card.	 73
	Camera has run out of file numbers. • Insert new memory card. • Format internal memory or memory card.	16  73
	Insufficient space to save a copy. Delete images from destination.	28
A blink was detected in the picture just taken.	One or more portrait subjects may have blinked when the image was taken. Check the image in playback mode.	54,  41
Image cannot be modified.	Cannot edit selected image. Select images that support editing functions.	 5
Cannot record movie.	Time out error while recording movie on the memory card. Choose memory card with faster write speed.	70,  19

Display	Cause/Solution	
Memory contains no images.	No images in the internal memory or memory card. <ul style="list-style-type: none"> Remove the memory card from the camera to play back images stored in the camera's internal memory. To copy images from internal memory to memory card, press the MENU button and tap . The copy option screen will be displayed and images in the internal memory can be copied to memory card. 	17  50
Disconnect HDMI cable.	Camera and TV are connected via HDMI cable. Disconnect HDMI cable.	64,  15
Turn off USB storage	Turn on the USB storage option on the camera's USB connection screen, and the camera recognizes a connection to an external device. <ul style="list-style-type: none"> Turn off the USB storage option on the camera's USB connection screen, and disconnect the camera from the external device. 	64, 66
File contains no image data.	File not created with COOLPIX S800c. Use the computer or other device with which the file was created or edited for playback.	–
All images are hidden.	No images available for a slide show.	–
This image cannot be deleted.	Image is protected. Disable protection.	 45
Unable to create panorama. Unable to create panorama. Pan the camera in one direction only. Unable to create panorama. Pan the camera more slowly.	Could not shoot using easy panorama. Shooting with easy panorama may not be possible in the following situations: <ul style="list-style-type: none"> When shooting does not end after a certain amount of time. When the camera is moved too fast. When the camera is not moved properly in the panorama direction. 	 2

Error Messages

Display	Cause/Solution	
Could not obtain GPS data.	The camera clock is not set correctly. Change the location or time and determine the location again.	–
A-GPS file not found.	An A-GPS file that can be updated is not found in the memory card. Check the following items. <ul style="list-style-type: none"> • Whether the memory card is inserted • Whether the A-GPS file is stored in the memory card • Whether the A-GPS file saved in a memory card is more recent than the A-GPS file saved in the camera • Whether the A-GPS file is still valid. 	–
Update failed	Unable to update A-GPS file. The A-GPS file may be corrupted. Download the file from the website once more.	 66
Press again to exit.	This message is displayed when you press the  (back) button in the shooting screen. <ul style="list-style-type: none"> • To return to the shooting screen, press the shutter-release button halfway. • To exit shooting mode, press the  (back) button again. When you exit shooting mode, the home screen is displayed. 	3
System error	Error has occurred in camera's internal circuitry. Turn camera off, remove and reinsert battery, and turn camera on. If error persists, contact retailer or Nikon-authorized service representative.	12, 18



Technical Notes and Index

Maximizing Camera Life and Performance	2
The Camera	2
The Battery	3
Charging AC Adapter	4
Memory Cards	4
Cleaning and Storage	6
Cleaning	6
Storage	6
Troubleshooting	7
Specifications	14
Supported Standards	19
Approved Memory Cards	19
Index	22

Maximizing Camera Life and Performance

To ensure continued enjoyment of this Nikon product, observe the precautions described below in addition to the warnings in “For Your Safety” (📖vi–viii) when using or storing the device.

The Camera

✔ Keep Dry

The device will be damaged if immersed in water or subjected to high humidity.

✔ Do Not Drop

The product may malfunction if subjected to strong shock or vibration.

✔ Handle the Lens and All Moving Parts with Care

Do not apply force to the lens, lens cover, monitor, memory card slot or battery-chamber. These parts are easily damaged. Applying force to the lens cover could result in camera malfunction or damage to the lens. Should the monitor break, care should be taken to avoid injury caused by broken glass.

✔ Do Not Point the Lens at Strong Light Sources for Extended Periods

Avoid pointing the lens at the sun or other strong light sources for extended periods when using or storing the camera. Intense light may cause deterioration of the image sensor, producing a white blur effect in photographs.

✔ Keep Away from Strong Magnetic Fields

Do not use or store this device in the vicinity of equipment that generates strong electromagnetic radiation or magnetic fields. Strong static charge or the magnetic fields produced by equipment such as radio transmitters could interfere with the monitor, damage data saved on the memory card, or affect the product's internal circuitry.

✔ Avoid Sudden Changes in Temperature

Sudden changes in temperature, such as when entering or leaving a heated building on a cold day, can cause condensation to form inside the device. To prevent condensation, place the device in a carrying case or a plastic bag before exposing it to sudden changes in temperature.

✔ Turn the Product Off Before Removing or Disconnecting the Power Source or Memory Card

Do not remove the battery while the product is on, or while images are being saved or deleted. Forcibly cutting power in these circumstances could result in loss of data or in damage to product memory or internal circuitry.



Notes About the Monitor

- Monitors and electronic viewfinders are constructed with extremely high precision; at least 99.99% of pixels are effective, with no more than 0.01% being missing or defective. Hence while these displays may contain pixels that are always lit (white, red, blue, or green) or always off (black), this is not a malfunction and has no effect on images recorded with the device.
- Due to the general characteristics of OLED monitors, prolonged or repeated display of the same screen or image may result in screen burn. Screen burn can be recognized by decreased brightness in portions of the monitor or mottled display. In some cases, screen burn may become permanent. However, images are in no way affected by screen burn.
To prevent screen burn, do not set monitor brightness higher than necessary and do not display the same screen or image for an extended period of time.
- Images in the monitor may be difficult to see under bright lighting.
- The monitor is lit by an LED backlight. Should the monitor begin to dim or flicker, contact your Nikon-authorized service representative.

The Battery

Be sure to read and follow the warnings in "For Your Safety" (📖vi–viii) before use.

- Check the battery level before using the camera, and replace or charge the battery if necessary. Do not continue charging once the battery is fully charged as this will result in reduced battery performance. Whenever possible, carry a fully charged spare battery when taking images on important occasions.
- Do not use the battery at ambient temperatures below 0°C (32°F) or above 40°C (104°F).
- Charge the battery indoors with an ambient temperature of 5°C to 35°C (41°F to 95°F) before use.
- When charging the battery inserted into the COOLPIX S800c using the Charging AC Adapter or a computer, the charge capacity may decrease at ambient temperatures 45°C to 60°C (113°F to 140°F).
- The battery is not charged at battery temperatures below 0°C (32°F) or above 60°C (140°F).
- Note that the battery may become hot during use; wait for the battery to cool before charging. Failure to observe these precautions could damage the battery, impair its performance, or prevent it from charging normally.
- On cold days, the capacity of batteries tends to decrease. If an exhausted battery is used at a low temperature, the camera may not turn on. Be sure that the battery is fully charged before heading outside to take images in cold weather. Keep spare batteries in a warm place and exchange as necessary. Once warmed, a cold battery may recover some of its charge.
- Dirt on the battery terminals can prevent the camera from functioning. Should the battery terminals become dirty, wipe them off with a clean, dry cloth before use.

Maximizing Camera Life and Performance

- If the battery will not be used for some time, insert it in the camera and completely exhaust it before removing it for storage. The battery should be stored in a cool location with an ambient temperature of 15°C to 25°C (59°F to 77°F). Do not store the battery in hot or extremely cold locations.
- Always remove the battery from the camera or optional battery charger when it is not being used. When inserted, minute amounts of current are drawn from the battery even when not in use. This may result in excessive draining of the battery and complete loss of function. Turning the camera on or off while the battery is exhausted can result in reduced battery life.
- Recharge the battery at least once every 6 months and completely exhaust it before returning it to storage.
- After removing the battery from the camera or optional battery charger, replace the included terminal cover and store it in a cool place.
- A marked drop in the time a fully-charged battery retains its charge, when used at room temperature, indicates that the battery needs to be replaced. Purchase a new EN-EL12 battery.
- Replace the battery when it no longer holds a charge. Used batteries are a valuable resource. Please recycle used batteries in accordance with local regulations.

Charging AC Adapter

Be sure to read and follow the warnings in “For Your Safety” (📖vi–viii) before use.

- The Charging AC Adapter EH-69P is for use only with compatible devices. Do not use with another make or model of device.
- The EH-69P is compatible with AC 100 V–240 V, 50/60 Hz electrical outlets. When using in other countries, use a plug adapter (available commercially) as necessary. For more information about plug adapters, consult your travel agency.
- Do not, under any circumstances, use another make or model of AC adapter other than Charging AC Adapter EH-69P or USB-AC adapter. Failure to observe this precaution could result in overheating or in damage to the camera.

Memory Cards

- Use only Secure Digital memory cards. See “Approved Memory Cards” (🔍19) for more information about memory cards.
- Be sure to follow the precautions described in the documentation included with the memory card.
- Do not put labels or stickers on memory cards.

- The first time you insert a memory card that has been used in another device into this camera, be sure to format it with this camera. We recommend formatting new memory cards with this camera before using them with this camera.
- Note that **formatting permanently deletes all images and other data on the memory card**. Be sure to make copies of any images you wish to keep before formatting the memory card.
- Do not perform the following during formatting, while data is being written to or deleted from the memory card, or during data transfer to a computer. Failure to observe this precaution could result in the loss of data or in damage to the camera or memory card:
 - Open the battery-chamber/memory card slot cover to remove/insert the battery or memory card.
 - Turn off the camera.
 - Disconnect the AC adapter.
- Do not format the memory card using a computer.

Cleaning and Storage

Cleaning

Do not use alcohol, thinner, or other volatile chemicals.

Lens	Avoid touching glass parts with your fingers. Remove dust or lint with a blower (typically a small device with a rubber bulb attached to one end that is pumped to produce a stream of air out the other end). To remove fingerprints or other stains that cannot be removed with a blower, wipe the lens with a soft cloth, using a spiral motion that starts at the center of the lens and working toward the edges. If this fails, clean the lens using a cloth lightly dampened with commercial lens cleaner.
Monitor	Remove dust or lint with a blower. To remove fingerprints and other stains, clean the monitor with a soft, dry cloth, being careful not to apply pressure. Wiping with too much force or with a hard cloth may damage the monitor or cause it to malfunction.
Body	Use a blower to remove dust, dirt or sand, then wipe gently with a soft, dry cloth. After using the camera at the beach or other sandy or dusty environment, wipe off any sand, dust, or salt with a dry cloth lightly dampened with fresh water and dry thoroughly. Note that foreign matter inside the camera could cause damage not covered by the warranty.

Storage

Turn the camera off when not in use. Be sure that the power-on lamp is off before putting the camera away. Remove the battery if the camera will not be used for an extended period. Do not store the camera with naphtha or camphor moth balls, or in any of the following locations:

- Next to equipment that produces strong electromagnetic fields, such as televisions or radios
- Exposed to temperatures below -10°C (14°F) or above 50°C (122°F)
- Places that are poorly ventilated or subject to humidity of over 60%





To prevent mold or mildew, take the camera out of storage at least once a month. Turn the camera on and release the shutter a few times before putting the camera away again.

For storing the battery, follow the precautions in "The Battery" (🔋:3) in "Maximizing Camera Life and Performance".







Troubleshooting

If the camera fails to function as expected, check the list of common problems below before consulting your retailer or Nikon-authorized service representative.











Power Supply, Display, and Settings

Problem	Cause/Solution	
The camera is on but does not respond.	<ul style="list-style-type: none">• Wait for recording to end.• If the problem persists, turn the camera off.<ul style="list-style-type: none">- If the camera does not turn off, remove and reinsert the battery or batteries or, if you are using an AC adapter, disconnect and reconnect the AC adapter.- Note that although any data currently being recorded will be lost, data that have already been recorded will not be affected by removing or disconnecting the power source.	-
Battery inserted in the camera cannot be charged.	Confirm all connections.	14
Camera cannot be turned on.	<ul style="list-style-type: none">• Battery is exhausted.• The camera cannot be turned on while connected to an electrical outlet via the Charging AC Adapter.	18 14
Camera turns off without warning.	<ul style="list-style-type: none">• Battery is exhausted.• The camera and battery may not work properly at low temperatures.• The internal temperature of the camera or the memory card is high. Allow the camera and memory card to cool and turn on the camera again.	18  3 19,  77
Monitor is blank.	<ul style="list-style-type: none">• Camera is off.• Camera entered display off mode or stand by mode to save power. Press the power switch.	18 19,  71
Camera becomes hot.	The camera may become hot when shooting movies for an extended period of time or when the camera is used in a hot area; this is not a malfunction.	-













Troubleshooting



Problem	Cause/Solution	
Monitor is hard to read/has darkened.	<ul style="list-style-type: none"> Adjust monitor brightness. When the internal temperature of the camera is high, the monitor darkens to reduce heat generation. When the internal temperature cools, the monitor brightens again. Monitor is dirty. Clean monitor. 	74,  56 –  6
Date and time of recording are not correct.	<ul style="list-style-type: none"> If camera clock has not been set, the “Date not set” indicator flashes during shooting and movie recording. Images and movies recorded before the clock is set are dated “00/00/0000 00:00” or “01/01/2012 00:00” respectively. Set the correct time and date from the Date & time option in the Android™ platform setting menu. The camera clock is not as accurate as ordinary watches or clocks. Periodically compare the time of the camera clock with that of a more accurate timepiece and reset as required. 	84 85
No indicators displayed in monitor.	Auto info is selected for Photo info in Monitor settings in the setup menu.	74,  56
Print date not available.	<ul style="list-style-type: none"> Date & time setting has not been made in the Android™ platform setting menu. Another function that restricts the Print date option is enabled. 	84 55
Date not imprinted on images even when Print date is enabled.	<ul style="list-style-type: none"> Another function that restricts the Print date option is enabled. Selected shooting mode does not support Print date. The date cannot be imprinted on movies. 	55  57 –
Camera settings reset.	Clock battery is exhausted; all settings were restored to their default values.	85
Monitor turns off, and the power-on lamp flashes green quickly.	Battery temperature is high. Turn off camera and allow battery to cool down before resuming use.	19
Wi-Fi (wireless LAN) function turns off and will not turn on.	<ul style="list-style-type: none"> In some rare cases, the Wi-Fi (wireless LAN) function turns off suddenly and will not turn on. Press the MENU button, tap Settings > Privacy > Reboot on the Android™ platform home screen, and reboot the camera then turn on the Wi-Fi (wireless LAN) settings. 	91,  72

Shooting

Problem	Cause/Solution	
No image taken.	<ul style="list-style-type: none"> When camera is in playback mode, or setting items or setup menu are displayed, press the shutter-release button. Battery is exhausted. When flash indicator flashes, flash is charging. 	26
		18
		44
Cannot switch to shooting mode.	Disconnect HDMI cable or USB cable.	64, 66,  15
Camera cannot focus.	<ul style="list-style-type: none"> Subject is too close. Try shooting using macro mode, easy auto mode, or Close-up scene mode. The intended subject is not suitable for autofocus. Set AF assist in the setup menu to Auto. Turn camera off and then on again. 	30, 36, 48
		25
		75,  59 18
Images are blurred.	<ul style="list-style-type: none"> Use flash. Increase ISO sensitivity value. Enable vibration reduction. Use BSS (Best Shot Selector). Use a tripod to stabilize the camera when shooting (using the self-timer at the same time is more effective). 	44
		53,  35
		75,  58
		53,  36
		46
Bright specks appear in images taken with flash.	Flash is reflecting off particles in air. Set the flash mode setting to  (Off).	44
Flash does not fire.	<ul style="list-style-type: none"> The flash mode setting is set to  (Off). Scene mode with which the flash does not fire is selected. On is selected for Blink proof in smart portrait mode. Movie is selected for shooting mode. Another function that restricts flash is enabled. 	44
		50
		54
		69
		55
Digital zoom cannot be used.	<ul style="list-style-type: none"> Digital zoom is set to Off in the setup menu. Digital zoom is not available in the following situations: <ul style="list-style-type: none"> When Portrait, Night portrait, Backlighting (when HDR is set to On), Easy panorama, or Pet portrait scene mode is selected When touch shooting is set to Subject tracking When shooting in smart portrait mode When Multi-shot 16 is selected for the Continuous setting 	75,  59
		34, 35, 37, 38, 39
		53,  31
		41
		53,  36
Image mode not available.	Another function that restricts the Image mode option is enabled.	55

Troubleshooting











Problem	Cause/Solution	
No sound when the shutter is released.	<ul style="list-style-type: none"> Off is selected for Shutter sound in the setup menu. No sound is heard with some shooting modes and settings, even when On is selected. The speaker is blocked. Do not cover the speaker. 	75,  60 2, 22
AF-assist illuminator does not light.	Off is selected for the AF assist option in the setup menu. AF-assist illuminator may not light depending on the position of the focus area or the current scene mode, even when Auto is selected.	75,  59
Images appear smeared.	Lens is dirty. Clean lens.	 6
Colors are unnatural.	White balance does not match light source.	53,  38
Randomly spaced bright pixels ("noise") appear in image.	Shutter speed is too slow or ISO sensitivity is high as the subject is dark. Noise can be reduced by: <ul style="list-style-type: none"> Using flash Specifying a lower ISO sensitivity setting 	44 53,  35
Images are too dark (underexposed).	<ul style="list-style-type: none"> The flash mode setting is set to  (Off). Flash window is blocked. Subject is beyond flash range. Adjust exposure compensation. Increase the ISO sensitivity. Subject is backlit. Select Backlighting scene mode or set the flash mode setting to  (Fill flash). 	44 22 44 49 53,  35 37, 44
Images are too bright (overexposed).	Adjust exposure compensation.	49
Unexpected results when flash set to  (Auto with red-eye reduction).	When taking images with  (Auto with red-eye reduction) or fill flash with slow sync and red-eye reduction in Night portrait scene mode, the In-Camera Red-Eye Fix processing may be applied to areas not affected by red-eye. Use any scene mode other than Night portrait , and change the flash mode to any setting other than  (Auto with red-eye reduction) and try taking an image again.	35, 45
Skin tones are not softened.	<ul style="list-style-type: none"> Under some shooting conditions, facial skin tones may not be softened. Select Skin softening in the retouch menu for images containing four or more faces. 	54 63,  11

Problem	Cause/Solution	
Saving images takes time.	It may take more time to save images in the following situations: <ul style="list-style-type: none"> • When the noise reduction function is in operation. • When flash mode is set to  (Auto with red-eye reduction). • When shooting in Backlighting scene mode (when HDR is set to On). • When the skin softening function is applied while shooting. 	– 45 37 34, 35, 53
A ring-shaped belt or rainbow-colored stripe appears in the monitor or images.	When shooting with backlighting or when a very strong light source (such as sunlight) is in the frame, a ring-shaped belt or rainbow-colored stripe (ghosting) may occur. Change the position of the light source, or frame the picture so that the light source does not enter the frame and try again.	–
Cannot use some shooting functions.	<ul style="list-style-type: none"> • You are limited to taking only a few pictures and cannot change the settings until Android™ OS starts up completely. <ul style="list-style-type: none"> - When the camera switches to the normal shooting mode, the playback mode icon is displayed. • Some of the COOLPIX S800c camera functions cannot be used when you use a shooting application other than the COOLPIX S800c shooting application. <ul style="list-style-type: none"> - To fully enable all COOLPIX S800c functions, press the  (home) button, tap the Shooting icon on the home screen, and use the COOLPIX S800c shooting application. - When recording movies, use the COOLPIX S800c shooting application. 	18 94

Playback

Problem	Cause/Solution	
File cannot be played back.	<ul style="list-style-type: none"> • File or folder was overwritten or renamed by computer or other make of camera. • The COOLPIX S800c is not able to play back movies recorded with another make or model of digital camera. 	– 73
Cannot zoom in on image.	<ul style="list-style-type: none"> • Images taken with cameras other than COOLPIX S800c may not be enlarged. • Playback zoom cannot be used with movies, small pictures. 	– –

Troubleshooting

Problem	Cause/Solution	
Cannot edit images.	<ul style="list-style-type: none"> • Movies cannot be edited. • Select images that support editing functions. • Images taken with another make or model of camera cannot be edited. • Images edited with this camera may not be displayed correctly on other cameras and cannot be transferred to computers from other cameras. 	73  5  5  5
Images not displayed on television.	<ul style="list-style-type: none"> • Select the correct HDMI option. • Both HDMI cable and USB cable are connected to the camera. • Memory card contains no images. Replace memory card. Remove memory card to play back images recorded in the internal memory. 	75,  61 64, 66,  15 16
Nikon Transfer 2 does not start when camera is connected to a computer.	<ul style="list-style-type: none"> • Camera is off. • Battery is exhausted. • USB cable is not correctly connected. • Confirm the compatible operating systems. • Camera is not recognized by the computer. • Refer to help information contained in ViewNX 2. 	19 14, 18 66 65 66 68
Edge of printed image is cropped.	<ul style="list-style-type: none"> • When printing images taken at an Image mode setting of  4608×2592 or  1920×1080, the edges of images may be cropped, preventing printing of complete images. Refer to the documentation included with the printer or consult the digital photo lab for further details to make sure that the printer supports printing at an aspect ratio of 16:9. • Take images at the Image mode setting other than  4608×2592 or  1920×1080. 	– 53
Cannot print panoramas.	When printing panoramas, the entire image may not be able to be printed depending on the printer's settings. Additionally, printing may not be possible depending on the printer. See the documentation included with the printer or consult a digital photo lab for details.	–

Others

Problem	Cause/Solution	
Cannot unlock the screen.	<ul style="list-style-type: none"><li data-bbox="381 172 767 239">• You are not using the correct unlock procedure. Make sure to use the correct procedure.<li data-bbox="381 246 809 338">• If you forget your unlock procedure, you will not be able to unlock the screen. If this happens, contact a Nikon-authorized service representative.	91

Specifications

Nikon COOLPIX S800c Digital Camera

Type	Compact digital camera
Number of effective pixels	16.0 million
Image sensor	1/2.3-in. type CMOS; total pixels: approx. 16.79 million
Lens	10× optical zoom, NIKKOR lens
Focal length	4.5–45.0 mm (angle of view equivalent to that of 25–250 mm lens in 35 mm [135] format)
f/-number	f/3.2–5.8
Construction	8 elements in 8 groups (1 ED lens element)
Digital zoom magnification	Up to 4× (angle of view equivalent to that of approx. 1000 mm lens in 35 mm [135] format)
Vibration reduction	Combination of lens shift and electronic VR (still images) Lens shift (movies)
Motion blur reduction	Motion detection (still pictures)
Autofocus (AF)	Contrast-detect AF
Focus range	<ul style="list-style-type: none">• [W]: Approx. 50 cm (1 ft 8 in.)–∞• [T]: Approx. 1.0 m (3 ft 4 in.)–∞• Macro mode: Approx. 10 cm (4 in.)–∞ (at a wide-angle zoom position beyond ) (All distances measured from center of front surface of lens)
Focus-area selection	Face priority, auto (9-area automatic selection), center, manual (focus area can be selected using the touch panel), subject tracking
Monitor	8.7 cm (3.5-in.), widescreen, OLED monitor (touch panel) with anti-reflection coating, approx. 819k-dot, 5-level brightness adjustment
Frame coverage (shooting mode)	Approx. 98% horizontal and 98% vertical (compared to actual image)
Frame coverage (playback mode)	Approx. 100% horizontal and 100% vertical (compared to actual image)
Storage	
Media	<ul style="list-style-type: none">• Internal memory<ul style="list-style-type: none">Spaces available for saving images: approx. 1.7 GBSpaces available for saving applications: approx. 680 MB (varying depending on the country or region)• SD/SDHC memory card
File system	DCF, Exif 2.3, DPOF compliant
File formats	Still pictures: JPEG Movies: MOV (video: H.264/MPEG-4 AVC, audio: AAC stereo)

Image size (pixels)	<ul style="list-style-type: none"> • 16M (high image quality) [4608 × 3456★] • 16M [4608 × 3456] • 8M [3264 × 2448] • 4M [2272 × 1704] • 2M [1600 × 1200] • VGA [640 × 480] • 16:9 (12M) [4608 × 2592] • 16:9 (2M) [1920 × 1080]
ISO sensitivity (Standard output sensitivity)	<ul style="list-style-type: none"> • ISO 125–1600 • ISO 3200 (available in auto mode)
Exposure	
Metering mode	256-segment matrix, center-weighted (digital zoom less than 2x), spot (digital zoom 2x or more)
Exposure control	Programmed auto exposure and exposure compensation (–2.0– +2.0 EV in steps of $\frac{1}{3}$ EV)
Shutter	Mechanical and CMOS electronic shutter
Speed	<ul style="list-style-type: none"> • 1/2000–1 s • 1/4000 s (maximum speed during high-speed continuous shooting) • 4 s (Fireworks show scene mode)
Aperture	Electronically-controlled ND filter (–2 AV) selection
Range	2 steps (f/3.2 and f/6.4 [W])
Self-timer	Can be selected from 10 and 2 second durations
Built-in flash	
Range (approx.) (ISO sensitivity: Auto)	[W]: 0.5–5.6 m (1 ft 8 in.–18 ft) [T]: 1.0–3.1 m (3 ft 4 in.–10 ft)
Flash control	TTL auto flash with monitor preflashes
Interface	Hi-Speed USB equivalent
Data Transfer Protocol	Mass storage
HDMI output	Can be selected from Auto , 480p , 720p , and 1080i
I/O terminal	Digital I/O (USB) HDMI mini connector (Type C) (HDMI output)
GPS	Receiver frequency 1575.42 MHz (C/A code), geodetic system WGS 84

Specifications

Power sources	One Rechargeable Li-ion Battery EN-EL12 (included) AC Adapter EH-62F (available separately)
Charging time	Approx. 4 hours (with Charging AC Adapter EH-69P when battery is fully discharged)
Battery life¹	
Still pictures	Approx. 140 shots when using EN-EL12
Movies (actual battery life for recording)²	Approx. 40 min when using EN-EL12
Tripod socket	1/4 (ISO 1222)
Dimensions (W × H × D)	Approx. 111.4 × 60.0 × 27.2 mm (4.4 × 2.4 × 1.1 in.) (excluding projections)
Weight	Approx. 184 g (6.5 oz) (including battery and SD memory card)
Operating environment	
Temperature	0°C–40°C (32°F–104°F)
Humidity	85% or less (no condensation)
Wi-Fi (Wireless LAN)	
Standards	IEEE 802.11b/g/n (standard wireless LAN protocol), WPS 2.0 (certified compliant with Wi-Fi Alliance standards), ARIB STD-T66 (standard for low power data communications systems)
Communications protocols	IEEE 802.11b: DBPSK, DQPSK, CCK IEEE 802.11g: OFDM IEEE 802.11n: OFDM
Range (line of sight)	Approx. 60 m (65 yd) (varies with location)
Operating frequency	2412-2462 MHz (1-11 channels)
Data rates (actual measured values)	IEEE 802.11b: 5 Mbps IEEE 802.11g: 20 Mbps IEEE 802.11n: 25 Mbps
Security	WPA/WPA2/WEP
Access protocols	Infrastructure

Bluetooth	
Standards	Bluetooth® (ver.2.1+EDR)
Profile	A2DP
System	
Processor	Cortex-A9
Memory	Internal storage: 4 GB RAM: 512 MB
Operating system	Android 2.3.3

- Unless otherwise stated, all figures assume a fully-charged battery and an ambient temperature of $23 \pm 3^{\circ}\text{C}$ ($73.4 \pm 5.4^{\circ}\text{F}$) as specified by the Camera and Imaging Products Association (CIPA).

¹ Figures based on the Camera and Imaging Products Association (CIPA) standards for measuring the endurance of camera batteries. Performance for still pictures measured under the following test conditions:  **4608x3456**, selected for **Image mode**, zoom adjusted with each shot, and flash fired with every other shot. Movie recording time assumes that **HD 1080p★ (1920x1080)** is selected for **Movie options**. Figures may vary with use, the interval between shots, and the length of time menus and images are displayed.

² Individual movie files cannot exceed 4 GB in size or 29 minutes in length. Recording may end before this limit is reached if camera temperature becomes elevated.

Rechargeable Li-ion Battery EN-EL12

Type	Rechargeable lithium-ion battery
Rated capacity	DC 3.7 V, 1050 mAh
Operating temperature	0°C–40°C (32°F–104°F)
Dimensions (W × H × D)	Approx. 32 × 43.8 × 7.9 mm (1.3 × 1.7 × 0.3 in.)
Weight	Approx. 22.5 g (0.8 oz) (excluding terminal cover)

Charging AC Adapter EH-69P

Rated input	AC 100 V–240 V, 50/60 Hz, 0.068–0.042 A
Rated output	DC 5.0 V, 550 mA
Operating temperature	0°C–40°C (32°F–104°F)
Dimensions (W × H × D)	Approx. 55 × 22 × 54 mm (2.2 × 0.9 × 2.2 in.) (excluding plug adapter) For Argentina: Approx. 55 × 59 × 63 mm (2.2 × 2.4 × 2.5 in.) For Korea: Approx. 55 × 59 × 66.5 mm (2.2 × 2.4 × 2.7 in.)
Weight	Approx. 55 g (2.0 oz) (excluding plug adapter) For Argentina, and Korea: Approx. 80 g (2.9 oz)

Specifications

Nikon will not be held liable for any errors this manual may contain. The appearance of this product and its specifications are subject to change without notice.

Supported Standards

- **DCF:** Design Rule for Camera File System is a standard widely used in the digital camera industry to ensure compatibility among different makes of camera.
- **DPOF:** Digital Print Order Format is an industry-wide standard that allows images to be printed from print orders stored on memory cards.
- **Exif version 2.3:** This camera supports Exchangeable Image File Format for Digital Still Cameras (Exif) version 2.3 for digital still cameras, a standard that allows information stored with photographs to be used for optimal color reproduction when images are output from Exif-compliant printers.

Approved Memory Cards

The following Secure Digital (SD) memory cards have been tested and approved for use in this camera.

- Memory cards with an SD Speed Class rating of 6 or faster are recommended for recording movies. Movie recording may stop unexpectedly when memory cards with a lower Speed Class rating are used.

	SD memory card	SDHC memory card ²
SanDisk	2 GB ¹	4 GB, 8 GB, 16 GB, 32 GB
TOSHIBA	2 GB ¹	4 GB, 8 GB, 16 GB, 32 GB
Panasonic	2 GB ¹	4 GB, 8 GB, 16 GB, 32 GB
Lexar	–	4 GB, 8 GB, 16 GB, 32 GB

¹ If the memory card will be used with a card reader or similar device, be sure that the device supports 2 GB or more.

² SDHC compliant. If the memory card will be used with a card reader or similar device, make sure that the device supports SDHC.



Contact the manufacturer for details on the above cards. We cannot guarantee camera performance when using memory cards made by other manufacturers.

AVC Patent Portfolio License

This product is licensed under the AVC Patent Portfolio License for the personal and non-commercial use of a consumer to (i) encode video in compliance with the AVC standard ("AVC video") and/or (ii) decode AVC video that was encoded by a consumer engaged in a personal and non-commercial activity and/or was obtained from a video provider licensed to provide AVC video. No license is granted or shall be implied for any other use. Additional information may be obtained from MPEG LA, L.L.C.

See <http://www.mpegla.com>.

MPEG-4 Visual Patent Portfolio License

This product is licensed under the MPEG-4 Visual Patent Portfolio License for the personal and non-commercial use of a consumer for (i) encoding video in compliance with the MPEG-4 visual standard ("MPEG-4 video") and/or (ii) decoding MPEG-4 video that was encoded by a consumer engaged in a personal and non-commercial activity and/or was obtained from a video provider licensed by MPEG LA to provide MPEG-4 video. No license is granted or shall be implied for any other use. Additional information including that relating to promotional, internal and commercial uses and licensing may be obtained from MPEG LA, L.L.C.

See <http://www.mpegla.com>.

About Open Source Software

This product includes certain open source or other software originating from third parties that is subject to the GNU General Public License (GPL), GNU Library/Lesser General Public License (LGPL) and different and/or additional copyright licenses, disclaimers and notices. The exact terms of GPL, LGPL and some other licenses, disclaimers and notices are available on the menu "About device" in the product.

Nikon offers to provide source code of software licensed under the GPL or LGPL or some other open source licenses allowing source code distribution to you on a CD-ROM for a charge covering the cost of performing such distribution, such as the cost of media, shipping and handling, upon written request to Imaging Company, Nikon corporation, Shin-Yurakucho Bldg., 12-1, Yurakucho 1-chome, Chiyoda-ku, Tokyo 100-8331, Japan.

This offer is valid for a period of three (3) years from the date of the distribution of this product by Nikon.

Trademark Information

- Microsoft, Windows and Windows Vista are either trademarks or registered trademarks of Microsoft Corporation in the United States and/or other countries.
- Macintosh, Mac OS, and QuickTime are trademarks or registered trademarks of Apple Inc., in the U.S. and other countries.
- Adobe and Acrobat are trademarks or registered trademarks of Adobe Systems Inc.
- SD logo and SDHC logo are trademarks of SD-3C, LLC.
- HDMI, **HDMI** logo, and High-Definition Multimedia Interface are trademarks or registered trademarks of HDMI Licensing LLC.
- Bluetooth and the Bluetooth logo are trademarks or registered trademarks of Bluetooth SIG, Inc., and are used under license.
- Wi-Fi and the Wi-Fi logo are trademarks or registered trademarks of the Wi-Fi Alliance.
- Google, the Google logo, Android platform, the Android logo, Google Play, the Google Play logo, Gmail, Google Calendar, Google Checkout, Google Maps, Google Talk, Google Latitude, Picasa and YouTube are trademarks or registered trademarks of Google, Inc.
- All other trade names mentioned in this manual or the other documentation included with your Nikon product are the trademarks or registered trademarks of their respective holders.

Index

Symbols

T (Telephoto) 23

W (Wide-angle) 23

 Special effects mode 40

 Easy auto mode 20, 30

 Auto mode 31

 Scene mode 32

 Smart portrait mode 41

 Movie 69

 Playback mode 26

 Setup menu 74

 Thumbnail playback 1, 62

 Playback zoom 1, 61

 Help 32

 Back button 2

 Home button 2, 88

MENU Menu button 2, 52, 63, 92

Numerics

24-hour display 85

A

AC adapter 15, 76

AF-assist illuminator 25, 75, 59

Airplane mode 70

Android 79

Aperture 24, 57

Application 89, 20

Applications screen 89

Auto flash 45

Auto mode 31

Autofocus 25, 72, 54

Autofocus mode 72, 54

B

Backlighting  37

Battery ii, 12, 14, 85

Battery charger 15, 76

Battery latch 2

Battery level 18

Battery-chamber 2

Battery-chamber/memory card slot cover
12, 16



Beach  35

Best Shot Selector 53, 36

Black and white copy  37

Blink proof 54, 41

Blink warning 76, 61

Bluetooth settings 91, 17, 70

Brightness 91, 71

BSS 53, 36

C

Charging AC Adapter ii, 14, 76

Close-up  36

Cloudy 38

Compression ratio 26

Computer 66

Connect to S800c 20

Connector cover 1

Continuous 53, 36

Continuous H 53, 36

Continuous H:120 fps 53, 36

Continuous H:60 fps 53, 36

Continuous L 53, 36

Copy 63, 50

Crop 61, 13

D

Date and time 84

Date counter 58

Date format 84

Daylight 38

Delete 28

































Delete data on memory card 91, 73

Digital filter 9





































Digital zoom 75, 59

Display off 91, 71

D-Lighting 63, 8

- Drag 4
- Dusk/dawn  35
- E**
- Easy panorama  38, 
- Easy panorama playback 38, 
- Edit text 87
- EH-69P ii, 14
- EN-EL12 ii, 12, 14
- Enter text 86
- Exposure compensation 49
- Extension 75
- Eyelet for camera strap 1
- E**
- Face detection 22, 57, 58
- File names 75
- Fill flash 45
- Filter effects 63, 9
- Fireworks show  37
- Firmware version 76, 69
- Fixed range auto 35
- Flash 44
- Flash mode 44, 45
- Flash off 45
- Flick 5
- Fluorescent 38
- Focus 24
 - area 6, 24, 58
 - Focus lock 60
 - indicator 24
- Folder name 75
- Food  36
- Format 16, 73
- Framing grid 56
- Full-frame playback 26
- Full-time AF 72, 54
- Function that cannot be used Simultaneously 55
- G**
- Google account 82
- Google Play Store 82
- GPS options 91, 63
- H**
- HDMI 64, 75
- HDMI cable 64, 15
- HDMI mini connector 1, 64, 15
- HDR 37
- Help 32
- High key **HI** 40
- High-contrast monochrome  40
- Home screen 88
- HS movie 72, 53
- I**
- Identifier 75
- Image mode 53, 26
- Image review 74, 56
- Image size 53, 26
- Imprinting date and time 57
- Incandescent 38
- Internal memory 17
- Internal memory indicator 6, 8, 18, 69
- Internet 93
- ISO sensitivity 53, 35
- J**
- JPG 75
- K**
- Keyboard 87
- L**
- Landscape  34
- Language 74
- Lens 1, 14
- Lens cover 1
- Low key **LO** 40
- M**
- Macro mode 48

Index

- Maximum movie length 71
- Memory capacity  27
- Memory card 16,  19
- Memory card slot 2, 16
- Microphone (stereo) 1
- Monitor 2, 6,  6
- Monitor settings 74,  56
- MOV  75
- Movie menu 72,  52
- Movie options 72,  52
- Movie playback 73
- Multi-shot 16 53,  37
- N**
- Night landscape  36
- Night portrait  35
- Nikon Transfer 2 66
- Nostalgic sepia **SEPIA** 40
- Notification panel 90
- Number of exposures remaining  27
- O**
- Option menu 92
- Optional accessories  76
- P**
- Party/indoor  35
- Pet portrait auto release 39
- Pet portrait  39
- Photo info  56
- Playback 26, 61, 73
- Playback menu 63,  42
- Playback mode 10, 26
- Playback zoom 61
- Portrait  34
- Power 18
- Power switch 1, 18, 19
- Power-on lamp 1, 15, 18
- Press halfway 24
- Print 64,  46
- Print date 74,  57
- Print order 63,  46
- Printer 64
- Protect 63,  44
- Q**
- Quick retouch 63,  7
- R**
- Rechargeable Li-ion battery ii, 12, 14
- Record GPS data 76,  63
- Record orientation  71
- Recording movies 69
- Recording slow motion movies 72
- Red-eye reduction 45
- Reset all 76,  67
- Retouch 63,  5
- Rotate image 63,  49
- S**
- Scene mode 32, 34
- Scroll playback  4
- Select time zone 84, 85
- Self-timer 46
- Self-timer lamp 1, 42, 47
- Set date 84
- Set time 84
- Setup menu 74,  55
- Share images 77
- Shooting 20, 22, 24
- Shooting menu 53,  28
- Shooting mode 10, 21
- Shutdown timer 75,  60
- Shutter sound 75,  60
- Shutter speed 24, 57
- Shutter-release button 1, 24
- Single 53,  36
- Single AF 72,  54
- Skin softening 53,  40
- Slide show 63,  42
- Slow Sync 45
- Small picture 63,  12

Smart portrait menu 52, 40

Smile timer 54, 41

Snow  35

Soft **SOFT** 40

Speaker 2

Sports  34

Stand by mode 60

Strap 3

Subject tracking 53, 31

Sunset  35

Switch the screen 89

I

Tap 4



Telephoto zoom 23



Thumbnail playback 62

Time difference 85

Touch AF/AE 53, 33

Touch and hold 4

Touch shooting 53, 72, 29, 31,

33, 53

Touch shutter 53, 29

Tripod socket 2

TV 15

TV settings 75, 61

U

Update the A-GPS File 76, 63,

66

Upload images 20, 23

Upload to smart device 21

USB cable ii, 14, 64, 66

USB connector 1, 14, 64, 66

Use GPS satellite 76

V

Vibration reduction 75, 58

ViewNX 2 64, 65

Volume 73

W

Welcome screen 74, 55

White balance 53, 38

Wide-angle zoom 23

Wi-Fi Settings 80, 70

Wi-Fi/ Bluetooth antenna 1

Wind Noise Reduction 72, 54

Wireless and network 91, 70

Z

Zoom control 1, 23



A series of horizontal dashed lines spanning the width of the page, intended for handwriting practice. There are 15 lines in total, starting from the top right and extending to the bottom left.

No reproduction in any form of this manual, in whole or in part (except for brief quotation in critical articles or reviews), may be made without written authorization from NIKON CORPORATION.