

Nikon

DIGITAL CAMERA

COOLPIX S6900

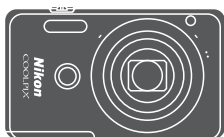

Reference Manual

Introduction	➔ i
Table of Contents	➔ xiv
Parts of the Camera	➔ 1
Preparing for Shooting	➔ 10
Basic Shooting and Playback Operations	➔ 15
Shooting Features	➔ 24
Playback Features	➔ 58
Recording and Playing Back Movies	➔ 80
Using Menus	➔ 87
Using the Wi-Fi (Wireless LAN) Function	➔ 141
Connecting the Camera to a TV, Printer, or Computer	➔ 145
Technical Notes	➔ 154

Introduction



Read This First

To get the most from this Nikon product, be sure to read “For Your Safety” (📖vi–viii) and “Wi-Fi (Wireless LAN Network)” (📖xi), and all other instructions thoroughly and keep them where they will be read by all who use the camera.

- If you want to start using the camera right away, see “Preparing for Shooting” (📖10) and “Basic Shooting and Playback Operations” (📖15).

Other Information

- Symbols and Conventions

Symbol	Description
	This icon marks cautions and information that should be read before using the camera.
	This icon marks notes and information that should be read before using the camera.
	This icon marks other pages containing relevant information.

- SD, SDHC, and SDXC memory cards are referred to as “memory cards” in this manual.
- The setting at the time of purchase is referred to as the “default setting.”
- The names of menu items displayed in the camera monitor, and the names of buttons or messages displayed on a computer monitor appear in bold.
- In this manual, images are sometimes omitted from monitor display samples so that monitor indicators can be more clearly shown.

How to Attach the Camera Strap

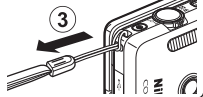
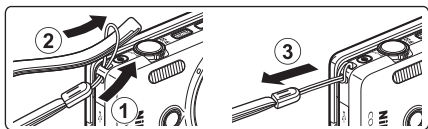

Information and Precautions

Life-Long Learning

As part of Nikon's "Life-Long Learning" commitment to ongoing product support and education, continually updated information is available online at the following websites:

- For users in the U.S.A.: <http://www.nikonusa.com/>
- For users in Europe and Africa: <http://www.europe-nikon.com/support/>
- For users in Asia, Oceania, and the Middle East: <http://www.nikon-asia.com/>

Visit these websites to keep up-to-date with the latest product information, tips, answers to frequently asked questions (FAQs), and general advice on digital imaging and photography. Additional information may be available from the Nikon representative in your area. Visit the website below for contact information.

<http://imaging.nikon.com/>

Use Only Nikon Brand Electronic Accessories

Nikon COOLPIX cameras are designed to the highest standards and include complex electronic circuitry. Only Nikon brand electronic accessories (including battery chargers, batteries, Charging AC Adapters, AC adapters and, USB cables) certified by Nikon specifically for use with this Nikon digital camera are engineered and proven to operate within the operational and safety requirements of this electronic circuitry. THE USE OF NON-NIKON ELECTRONIC ACCESSORIES COULD DAMAGE THE CAMERA AND MAY VOID YOUR NIKON WARRANTY.

The use of third-party rechargeable Li-ion batteries not bearing the Nikon holographic seal could interfere with normal operation of the camera or result in the batteries overheating, igniting, rupturing, or leaking.

Holographic seal: Identifies this device as an authentic Nikon product.



For more information about Nikon brand accessories, contact a local authorized Nikon dealer.

Before Taking Important Pictures

Before taking pictures on important occasions (such as at weddings or before taking the camera on a trip), take a test shot to ensure that the camera is functioning normally. Nikon will not be held liable for damages or lost profits that may result from product malfunction.

About the Manuals

- No part of the manuals included with this product may be reproduced, transmitted, transcribed, stored in a retrieval system, or translated into any language in any form, by any means, without Nikon's prior written permission.
- Illustrations and monitor content shown in this manual may differ from the actual product.
- Nikon reserves the right to change the specifications of the hardware and software described in these manuals at any time and without prior notice.
- Nikon will not be held liable for any damages resulting from the use of this product.
- While every effort was made to ensure that the information in these manuals is accurate and complete, we would appreciate it were you to bring any errors or omissions to the attention of the Nikon representative in your area (address provided separately).

Notice Concerning Prohibition of Copying or Reproduction

Note that simply being in possession of material that was digitally copied or reproduced by means of a scanner, digital camera or other device may be punishable by law.

• **Items prohibited by law from being copied or reproduced**

Do not copy or reproduce paper money, coins, securities, government bonds or local government bonds, even if such copies or reproductions are stamped "Sample." The copying or reproduction of paper money, coins, or securities which are circulated in a foreign country is prohibited. Unless the prior permission of the government was obtained, the copying or reproduction of unused postage stamps or post cards issued by the government is prohibited.

The copying or reproduction of stamps issued by the government and of certified documents stipulated by law is prohibited.

• **Cautions on certain copies and reproductions**

The government has issued cautions on copies or reproductions of securities issued by private companies (shares, bills, checks, gift certificates, etc.), commuter passes, or coupon tickets, except when a minimum of necessary copies are to be provided for business use by a company. Also, do not copy or reproduce passports issued by the government, licenses issued by public agencies and private groups, ID cards and tickets, such as passes and meal coupons.

• **Comply with copyright notices**

The copying or reproduction of copyrighted creative works such as books, music, paintings, woodcut prints, maps, drawings, movies, and photographs is governed by national and international copyright laws. Do not use this product for the purpose of making illegal copies or to infringe copyright laws.

Disposing of Data Storage Devices

Please note that deleting images or formatting data storage devices such as memory cards or built-in camera memory does not completely erase the original image data. Deleted files can sometimes be recovered from discarded storage devices using commercially available software, potentially resulting in the malicious use of personal image data. Ensuring the privacy of such data is the user's responsibility.

Before discarding a data storage device or transferring ownership to another person, erase all data using commercial deletion software, or format the device and then completely refill it with images containing no private information (for example, images of empty sky). Be sure to also replace any images selected for the **Select an image** option in the **Welcome screen** setting in the setup menu (📖87). Care should be taken to avoid injury or damage to property when physically destroying data storage devices.

To delete the Wi-Fi settings, select **Restore default settings** in the Wi-Fi options menu (📖87).

For Your Safety

To prevent damage to your Nikon product or injury to yourself or to others, read the following safety precautions in their entirety before using this equipment. Keep these safety instructions where all those who use the product will read them.

The consequences that could result from failure to observe the precautions listed in this section are indicated by the following symbol:



This icon marks warnings, information that should be read before using this Nikon product, to prevent possible injury.

WARNINGS

Turn off in the event of malfunction

Should you notice smoke or an unusual smell coming from the camera or Charging AC Adapter, unplug the Charging AC Adapter and remove the battery immediately, taking care to avoid burns. Continued operation could result in injury. After removing or disconnecting the power source, take the equipment to a Nikon-authorized service representative for inspection.

Do not disassemble

Touching the internal parts of the camera or Charging AC Adapter could result in injury. Repairs should be performed only by qualified technicians. Should the camera or Charging AC Adapter break open as the result of a fall or other accident, take the product to a Nikon-authorized service representative for inspection, after unplugging the product and/or removing the battery.

Do not use the camera or Charging AC Adapter in the presence of flammable gas

Do not use electronic equipment in the presence of flammable gas, as this could result in explosion or fire.

Handle the camera strap with care

Never place the strap around the neck of an infant or child.

Keep out of reach of children

Particular care should be taken to prevent infants from putting the battery or other small parts into their mouths.

⚠ Do not remain in contact with the camera, Charging AC Adapter, or AC adapter for extended periods while the devices are on or in use

Parts of the devices become hot. Leaving the devices in direct contact with the skin for extended periods may result in low-temperature burns.

⚠ Do not leave the product where it will be exposed to extremely high temperatures, such as in an enclosed automobile or in direct sunlight

Failure to observe this precaution could cause damage or fire.

⚠ Observe caution when handling the battery

The battery may leak, overheat, or explode if improperly handled. Observe the following precautions when handling the battery for use in this product:

- Before replacing the battery, turn the product off. If you are using the Charging AC Adapter/AC adapter, be sure it is unplugged.
- Use only a Rechargeable Li-ion Battery EN-EL19 (included). Charge the battery by using a camera that supports battery charging. To perform this operation, use the Charging AC Adapter EH-71P/EH-71PCH (included) and USB Cable UC-E21 (included). The Battery Charger MH-66 (available separately) is also available to charge the battery without using a camera.
- When inserting the battery, do not attempt to insert it upside down or backwards.
- Do not short or disassemble the battery or attempt to remove or break the battery insulation or casing.
- Do not expose the battery to flame or to excessive heat.
- Do not immerse in or expose to water.
- Put the battery in a plastic bag, etc. in order to insulate it before transporting. Do not transport or store with metal objects such as necklaces or hairpins.
- The battery is prone to leakage when fully discharged. To avoid damage to the product, be sure to remove the battery when no charge remains.
- Discontinue use immediately should you notice any change in the battery, such as discoloration or deformation.
- If liquid from the damaged battery comes in contact with clothing or skin, rinse immediately with plenty of water.

⚠ Observe the following precautions when handling the Charging AC Adapter

- Keep dry. Failure to observe this precaution could result in fire or electric shock.
- Dust on or near the metal parts of the plug should be removed with a dry cloth. Continued use could result in fire.
- Do not handle the plug or go near the Charging AC Adapter during lightning storms. Failure to observe this precaution could result in electric shock.

- Do not damage, modify, forcibly tug or bend the USB cable, place it under heavy objects, or expose it to heat or flames. Should the insulation be damaged and the wires become exposed, take it to a Nikon-authorized service representative for inspection. Failure to observe these precautions could result in fire or electric shock.
- Do not handle the plug or Charging AC Adapter with wet hands. Failure to observe this precaution could result in electric shock.
- Do not use with travel converters or adapters designed to convert from one voltage to another or with DC-to-AC inverters. Failure to observe this precaution could damage the product or cause overheating or fire.

 **Use the appropriate power supply (battery, Charging AC adapter, AC adapter, USB cable)**

Using a power supply other than those provided or sold by Nikon could result in damage or malfunction.

 **Use appropriate cables**

When connecting cables to the input and output jacks, use only the cables provided or sold by Nikon for the purpose, to maintain compliance with product regulations.

 **Handle moving parts with care**

Be careful that your fingers or other objects are not pinched by the lens cover or other moving parts.

 **Using the flash close to your subject's eyes could cause temporary visual impairment**

The flash should be no less than 1 meter (3 ft 4 in.) from the subject. Particular care should be observed when photographing infants.

 **Do not operate the flash with the flash window touching a person or object**

Failure to observe this precaution could result in burns or fire.

 **Avoid contact with liquid crystal**

Should the monitor break, care should be taken to avoid injury caused by broken glass and to prevent liquid crystal from the monitor touching the skin or entering the eyes or mouth.

 **Turn the power off when using inside an aircraft or the hospital**

Turn the power off while inside the aircraft during take off or landing. Do not use wireless network functions while in the air. Follow the instructions of the hospital when using while in a hospital. The electromagnetic waves emitted by this camera may disrupt the electronic systems of the aircraft or the instruments of the hospital. If you are using an Eye-Fi card, remove it from the camera before boarding an aircraft or entering a hospital.

Notices

Notices for Customers in the U.S.A.

IMPORTANT SAFETY INSTRUCTIONS - SAVE THESE INSTRUCTIONS.

DANGER - TO REDUCE THE RISK OF FIRE OR ELECTRIC SHOCK, CAREFULLY FOLLOW THESE INSTRUCTIONS

For connection to a supply not in the U.S.A., use an attachment plug adapter of the proper configuration for the power outlet if needed.

The power supply unit is intended to be correctly orientated in a vertical or floor mount position.

Federal Communications Commission (FCC) Radio Frequency Interference Statement

This equipment has been tested and found to comply with the limits for a Class B digital device, pursuant to Part 15 of the FCC rules. These limits are designed to provide reasonable protection against harmful

interference in a residential installation. This equipment generates, uses, and can radiate radio frequency energy and, if not installed and used in accordance with the instructions, may cause harmful interference to radio communications. However, there is no guarantee that interference will not occur in a particular installation. If this equipment does cause harmful interference to radio or television reception, which can be determined by turning the equipment off and on, the user is encouraged to try to correct the interference by one or more of the following measures:

- Reorient or relocate the receiving antenna.
- Increase the separation between the equipment and receiver.
- Connect the equipment into an outlet on a circuit different from that to which the receiver is connected.
- Consult the dealer or an experienced radio/television technician for help.

CAUTIONS

Modifications

The FCC requires the user to be notified that any changes or modifications made to this device that are not expressly approved by Nikon Corporation may void the user's authority to operate the equipment.

Interface Cables

Use the interface cables sold or provided by Nikon for your equipment. Using other interface cables may exceed the limits of Class B Part 15 of the FCC rules.



Notice for Customers in the State of California

WARNING

Handling the cord on this product will expose you to lead, a chemical known to the State of California to cause birth defects or other reproductive harm.

Wash hands after handling.

Nikon Inc.,

1300 Walt Whitman Road, Melville, New York 11747-3064, U.S.A.

Tel: 631-547-4200

Notice for Customers in Canada

CAN ICES-3 B / NMB-3 B

Notices for Customers in Europe

CAUTIONS

RISK OF EXPLOSION IF BATTERY IS REPLACED BY AN INCORRECT TYPE.

DISPOSE OF USED BATTERIES ACCORDING TO THE INSTRUCTIONS.

This symbol indicates that electrical and electronic equipment is to be collected separately.

The following apply only to users in European countries:

- This product is designated for separate collection at an appropriate collection point. Do not dispose of as household waste.
- Separate collection and recycling helps conserve natural resources and prevent negative consequences for human health and the environment that might result from incorrect disposal.
- For more information, contact the retailer or the local authorities in charge of waste management.



This symbol on the battery indicates that the battery is to be collected separately.

The following apply only to users in European countries:

- All batteries, whether marked with this symbol or not, are designated for separate collection at an appropriate collection point. Do not dispose of as household waste.
- For more information, contact the retailer or the local authorities in charge of waste management.



Wi-Fi (Wireless LAN Network)

This product is controlled by the United States Export Administration Regulations, and you are required to obtain permission from the United States government if you export or re-export this product to any country to which the United States embargoes goods. The following countries were subject to embargo: Cuba, Iran, North Korea, Sudan, and Syria. Since the target countries are subject to change, please contact the United States Department of Commerce for the latest information.

Restrictions on Wireless Devices

The wireless transceiver included in this product conforms to wireless regulations in the country of sale and is not for use in other countries (products purchased in the EU or EFTA can be used anywhere within the EU and EFTA). Nikon does not accept liability for use in other countries. Users who are unsure as to the original country of sale should consult with their local Nikon service center or Nikon-authorized service representative. This restriction applies to wireless operation only and not to any other use of the product.

Notice for Customers in the U.S.A. and Canada

Federal Communications Commission (FCC) and Industry of Canada (IC)

Declaration of Conformity

This device complies with Part 15 of FCC Rules and Industry Canada licence-exempt RSS standard(s). Operation is subject to the following two conditions: (1) this device may not cause interference, and (2) this device must accept any interference, including interference that may cause undesired operation of this device.

FCC/IC RF Exposure Statement

This transmitter must not be co-located or operated in conjunction with any other antenna or transmitter.

The available scientific evidence does not show that any health problems are associated with using low power wireless devices. There is no proof, however, that these low power wireless devices are absolutely safe. Low power wireless devices emit low levels of radio frequency energy (RF) in the microwave range while being used. Whereas high levels of RF can produce health effects (by heating tissue), exposure of low-level RF that does not produce heating effects causes no known adverse health effects. Many studies of low-level RF exposures have not found any biological effects. Some studies have suggested that some biological effects might occur, but such findings have not been confirmed by additional research.

COOLPIX S6900, which is equipped with a WSDB-686GN (FCC ID:2AAD3AA1G0J0 / IC ID:4634A-2150EC) Wireless LAN Module, has been tested and found to comply with FCC/IC radiation exposure limits set forth for an uncontrolled environment and meets the FCC radio frequency (RF) Exposure Guidelines in Supplement C to OET65 and RSS-102 of the IC radio frequency (RF) Exposure rules. Please refer to the SAR test report that was uploaded to FCC website.

Declaration of Conformity (Europe)

Hereby, Nikon Corporation, declares that COOLPIX S6900 is in compliance with the essential requirements and other relevant provisions of Directive 1999/5/EC. The declaration of conformity may be consulted at http://imaging.nikon.com/support/pdf/DoC_S6900.pdf.

Notice for Customers in Singapore

This device complies with radio-frequency regulations.

**Complies with
IDA Standards
DA104328**

Notice for Customers in Jamaica

This product contains a Type Approved Module by Jamaica: "SMA – WSDB-686GN"

Precautions when Using Radio Transmissions



Always keep in mind that radio transmission or reception of data is subject to interception by third parties. Note that Nikon is not responsible for data or information leaks that may occur during data transfer.

Personal Information Management and Disclaimer

- User information registered and configured on the product, including wireless LAN connection settings and other personal information, is susceptible to alteration and loss resulting from operational error, static electricity, accident, malfunction, repair or other handling. Always keep separate copies of important information. Nikon is not responsible for any direct or indirect damages or lost profits resulting from alteration or loss of content that is not attributable to Nikon.
- Before discarding this product or transferring it to another owner, perform **Reset all** in the setup menu (📖87) to delete all user information registered and configured with the product, including wireless LAN connection settings and other personal information.

Table of Contents

Introduction	i
Read This First	i
Other Information.....	i
How to Attach the Camera Strap.....	ii
Information and Precautions.....	iii
For Your Safety	vi
WARNINGS.....	vi
Notices.....	ix
Wi-Fi (Wireless LAN Network).....	xi
<hr/>	
Parts of the Camera	1
The Camera Body.....	1
Opening and Adjusting the Angle of the Monitor	2
Using the Camera Stand.....	3
Operating the Touch Panel	4
The Monitor	6
Shooting Mode	6
Playback Mode	8
<hr/>	
Preparing for Shooting.....	10
Insert the Battery and Memory Card	10
Removing the Battery or Memory Card.....	10
Memory Cards and Internal Memory.....	10
Charge the Battery	11
Turn the Camera On and Set the Display Language, Date, and Time	13
<hr/>	
Basic Shooting and Playback Operations.....	15
Shooting with Scene Auto Selector Mode.....	15
Using the Zoom.....	17
The Shutter-release Button.....	17
Using the Front Shutter-release Button.....	18
Touch Shooting	18
Play Back Images.....	19
Delete Images	20
Changing the Shooting Mode	22
Using the Flash, Self-timer, Etc.....	23
Recording Movies.....	23

Shooting Features.....	24
 (Scene Auto Selector) Mode.....	24
Scene Mode (Shooting Suited to Scenes).....	25
Tips and Notes.....	27
Shooting with Easy Panorama.....	31
Playback with Easy Panorama.....	33
Special Effects Mode (Applying Effects When Shooting).....	34
Smart Portrait Mode (Capturing Images of Smiling Faces).....	36
Glamour Mode (Enhancing Human Faces When Shooting).....	37
Using Self-Collage.....	38
 (Auto) Mode.....	39
Using Quick Effects.....	40
Using the Self-timer with the Gesture Control Function.....	41
Flash Mode.....	43
Self-timer.....	45
Macro Mode (Taking Close-up Pictures).....	46
Exposure Compensation (Adjusting Brightness).....	47
Default Settings (Flash, Self-timer, Etc.).....	48
Focusing.....	50
Using Face Detection.....	50
Using Skin Softening.....	51
Using Target Finding AF.....	52
Subjects Not Suitable for Autofocus.....	53
Focus Lock.....	54
Functions That Cannot Be Used Simultaneously When Shooting.....	55
Playback Features.....	58
Playback Zoom.....	58
Thumbnail Playback/Calendar Display.....	59
Favorite Pictures Mode.....	60
Adding Images to Albums.....	60
Playing Back Images in Albums.....	61
Removing Images from Albums.....	62
Changing the Album Icon.....	63
Auto Sort Mode.....	64
List by Date Mode.....	65
Viewing and Deleting Images Captured Continuously (Sequence).....	66
Viewing Images in a Sequence.....	66
Deleting Images in a Sequence.....	67
Editing Images (Still Images).....	68
Before Editing Images.....	68

Quick Effects: Changing Hue or Mood	68
Quick Retouch: Enhancing Contrast and Saturation	69
D-Lighting: Enhancing Brightness and Contrast.....	70
Red-eye Correction: Correcting Red-eye When Shooting with the Flash	70
Glamour Retouch: Enhancing Human Faces.....	71
Paint: (Writing and Drawing on Images)	73
Stretch: Stretching Images	75
Perspective Control: Adjusting the Sense of Perspective.....	76
Selective Softening: Blurring the Background	77
Small Picture: Reducing the Size of an Image	78
Crop: Creating a Cropped Copy	79
<hr/>	
Recording and Playing Back Movies.....	80
Capturing Still Images While Recording Movies	83
Operations During Movie Playback	84
Editing Movies	85
Extracting and Saving the Desired Portion of a Recorded Movie.....	85
Saving One Frame of a Movie as a Still Image	86
<hr/>	
Using Menus.....	87
The Shooting Menu (for  (Auto) Mode)	89
Image Mode (Image Size and Quality).....	89
Touch Shooting	91
White Balance (Adjusting Hue)	94
Continuous Shooting	96
ISO Sensitivity	99
Color Options	100
AF Area Mode.....	101
Autofocus Mode	104
Quick Effects	104
The Smart Portrait Menu	105
Skin Softening	105
Smile Timer	106
Blink Proof.....	107
The Glamour Mode Menu.....	108
Self-Collage	108
The Playback Menu	109
Mark for Wi-Fi Upload	109
Slide Show	110
Protect.....	111
Rotate Image	111
Voice Memo	112

Copy (Copy Between the Memory Card and Internal Memory).....	113
Sequence Display Options	114
Choose Key Picture	114
The Image Selection Screen.....	115
The Movie Menu	116
Movie Options.....	116
Open with HS Footage.....	120
Autofocus Mode	120
Movie VR.....	121
Wind Noise Reduction	122
Frame Rate	122
The Wi-Fi Options Menu.....	123
Operating the Text Input Keyboard	124
The Setup Menu	125
Welcome Screen.....	125
Time Zone and Date	126
Monitor Settings.....	128
Date Stamp.....	130
Photo VR.....	131
Motion Detection.....	132
AF Assist.....	133
Digital Zoom	133
Sound Settings	134
Auto Off	134
Format Card/Format Memory.....	135
Language	136
HDMI	136
Charge by Computer.....	137
Blink Warning.....	138
Eye-Fi Upload.....	139
Reset All.....	140
Firmware Version	140
Using the Wi-Fi (Wireless LAN) Function	141
Installing the Software on the Smart Device	141
Connecting the Smart Device to the Camera.....	142
Preselecting Images in the Camera That You Want to Transfer to a Smart Device	144
Connecting the Camera to a TV, Printer, or Computer	145
Connecting the Camera to a TV (Playback on a TV)	147
Connecting the Camera to a Printer (Direct Print).....	148

Connecting the Camera to a Printer	148
Printing Images One at a Time	149
Printing Multiple Images	150
Using ViewNX 2 (Transferring Images to a Computer)	152
Installing ViewNX 2	152
Transferring Images to a Computer	152

Technical Notes.....	154
Caring for the Product	155
The Camera.....	155
The Battery	156
The Charging AC Adapter.....	157
Memory Cards.....	158
Cleaning and Storage.....	159
Cleaning.....	159
Storage	159
Error Messages.....	160
Troubleshooting	164
File Names	171
Optional Accessories	172
Specifications	173
Approved Memory Cards.....	177
Index.....	179

Parts of the Camera

The Camera Body

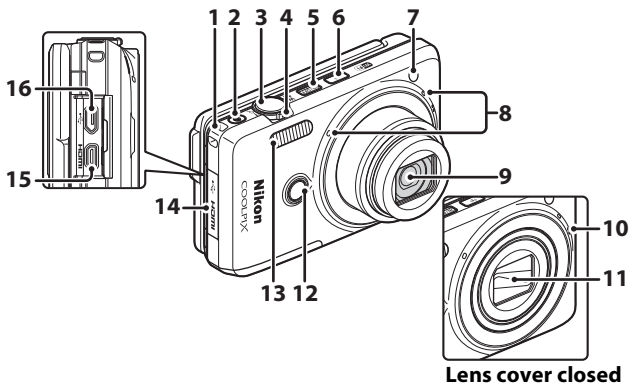

1	Eyelet for camera strap..... ii	8	Microphone (stereo)..... 112
2	● (movie-record) button..... 23	9	Lens
3	Shutter-release button..... 16	10	Speaker
	Zoom control..... 17	11	Lens cover
	W : Wide-angle..... 17	12	Front shutter-release button
4	T : Telephoto..... 17	 18
	: Thumbnail playback..... 59	13	Flash..... 43
	Q : Playback zoom..... 58	14	Connector cover..... 145
5	Power switch/power-on lamp... 13	15	HDMI micro connector (Type D)
6	Wi-Fi button..... 142, 144	 145
7	Self-timer lamp..... 45	16	Micro-USB connector..... 145
	AF-assist illuminator		

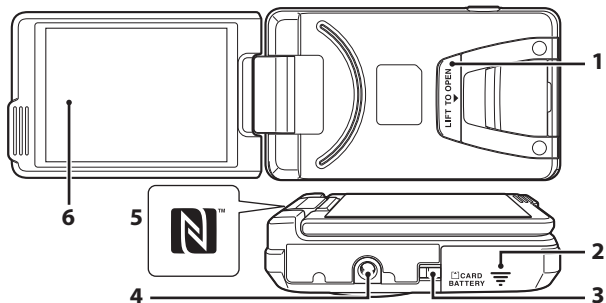

- | | | | |
|--|----|------------------------------------|----------|
| 1 Camera stand..... | 3 | 4 Tripod socket | 175 |
| 2 Battery-chamber/
memory card slot cover | 10 | 5 N-Mark (NFC antenna)..... | 142, 144 |
| 3 Power connector cover (for
connection with optional AC
adapter) | | 6 Monitor..... | 6 |

Opening and Adjusting the Angle of the Monitor

The direction and angle of the monitor on this camera can be adjusted. For normal shooting, fold the monitor against the back of the camera, facing rearward (③).

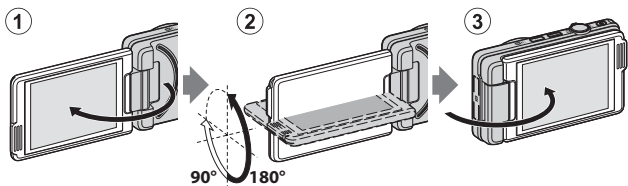

To protect the monitor from scratches and dirt while you are carrying or not using the camera, close the monitor so that it is facing inward against the back of the camera.

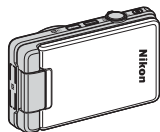

✓ Notes About the Monitor

When moving the monitor, do not apply excessive force and make sure to turn it slowly within the adjustable range.

Using the Camera Stand

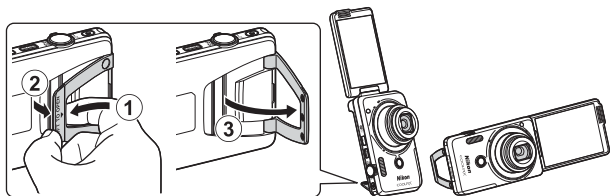

Insert the battery into the camera (📖10) and open the monitor 180 degrees. Insert your finger under the camera stand (**LIFT TO OPEN**) (①), and grasp it with your fingers to pull it outward (②). You can use the camera stand in either the fully open position (87 degrees) or the partially open position where it stops into place (67 degrees) (③).



✓ Notes About the Camera Stand

- If the camera stand angle is set to an angle other than those specified above, the camera may become unstable and fall over. Adjust the angle so that the camera is stable, and **make sure to place the camera on a level and stable surface before using it.**
- **Make sure to fold in the camera stand before returning the monitor** to the closed position against the back of the camera.
- Do not forcibly open the camera stand (more than 87 degrees). Doing so could result in damage to the camera.

📎 Tip for Using the Camera Stand

Use the camera stand with the gesture control function (📖41) or **Self-Collage** for glamour mode (📖38) makes it easy to take self-portrait pictures.

Operating the Touch Panel

The monitor on this camera is a touch panel display operated by finger. Perform the actions described below to operate the touch panel.

Tapping

Tap the touch panel.

Use this operation to:

- Select icons
- Select images in thumbnail playback mode
- Perform touch shooting operations

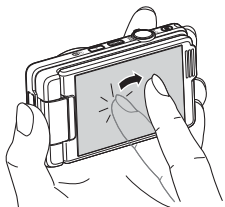

Dragging

Drag your finger across the touch panel and remove it from the touch panel.

Use this operation to:

- Scroll through images in full-frame playback mode
- Move the visible portion of an image enlarged with playback zoom
- Move sliders such as when adjusting exposure compensation

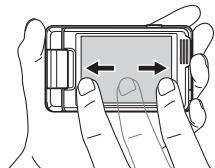

Spreading/Pinching

Spread two fingers apart/pinch two fingers together.

Use this operation to:

- Zoom in/out on an image in playback mode
- Switch to thumbnail playback mode from full-frame playback mode

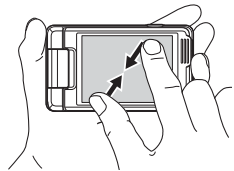
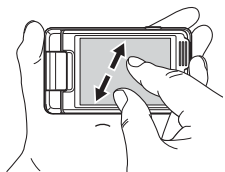

Notes About the Touch Panel

- The touch panel of this camera relies on static electricity. It may not respond when touched with fingernails or gloved fingers.
- Do not press on the touch panel with pointed objects.
- Do not apply unnecessary pressure to the touch panel.
- The touch panel may not respond to touch if a commercially available protective film is applied.

Notes About Touch Panel Operations

- The camera may not operate properly if you keep your finger in one place for too long.
- When you drag, spread, or pinch your fingers, the camera may not operate properly if you perform the following actions:
 - Bounce your finger off the touch panel
 - Drag your finger over a too short distance
 - Stroke the touch panel too lightly
 - Move your finger too quickly
 - Fail to move both fingers simultaneously when spreading or pinching
- The touch panel may not operate properly if something else is touching the touch panel when your finger touches it.

The Monitor

The information that is displayed in the monitor during shooting and playback changes depending on the camera's settings and state of use.

By default, information is displayed when the camera is turned on and when you operate the camera, and turns off after a few seconds (when **Photo info** is set to **Auto info** in **Monitor settings** (📖128)).

Shooting Mode

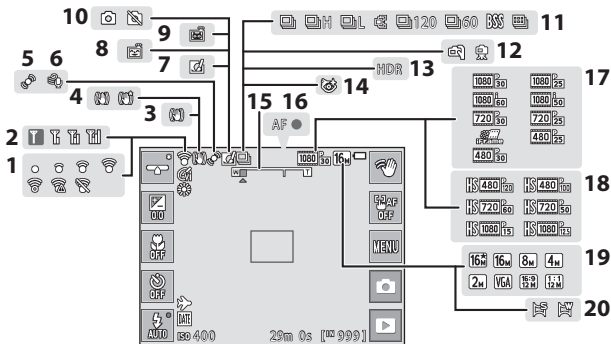

1	Eye-Fi communication indicator 139	11	Continuous shooting mode..... 96
2	Wi-Fi communication indicator 123, 142	12	Hand-held/tripod..... 27, 28
3	Photo VR icon 131	13	Backlighting (HDR) 29
4	Movie VR icon 121	14	Blink proof icon 107
5	Motion detection icon 132	15	Zoom indicator 17, 46
6	Wind noise reduction 122	16	Focus indicator 16
7	Quick effects icon 40, 104	17	Movie options (normal speed movies) 116
8	Smile timer 106	18	Movie options (HS movies) 117
9	Pet portrait auto release..... 30	19	Image mode 89
10	Still image capture (during movie recording)..... 83	20	Easy panorama..... 31

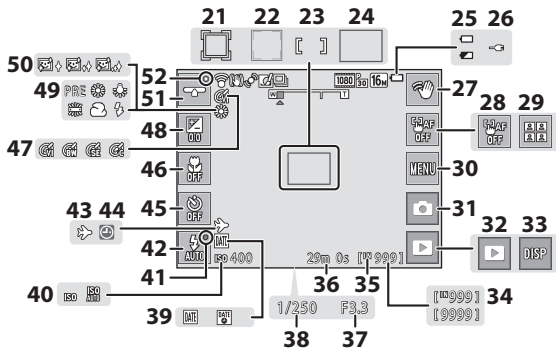

21	Focus area (subject tracking) 102, 103	35	Internal memory indicator..... 14
22	Focus area (face detection, pet detection).....30, 36, 50, 101	36	Remaining movie recording time 23
23	Focus area (center)..... 54	37	Aperture value 17
24	Focus area (target finding AF) 52, 102	38	Shutter speed..... 17
25	Battery level indicator 14	39	Date stamp..... 130
26	Charging AC Adapter connection indicator	40	ISO sensitivity..... 99
27	Gesture control..... 41	41	Flash indicator 43
28	Touch AF cancellation..... 93	42	Flash mode..... 43
29	Self-collage..... 38	43	Travel destination icon 126
30	Menu screen icon 87, 89, 105, 108, 116, 123, 125	44	"Date not set" indicator 165
31	Shooting mode 15, 22, 24, 25, 34, 36, 37, 39	45	Self-timer indicator..... 45
32	Playback mode (switches to playback mode)..... 19	46	Macro mode..... 46
33	Information redisplay..... 23, 128	47	Color options 100
34	Number of exposures remaining (still images)..... 14	48	Exposure compensation value 47
		49	White balance mode..... 94
		50	Skin softening..... 105
		51	Slider display 26, 35, 37
		52	"Settings changed" indicator

Playback Mode

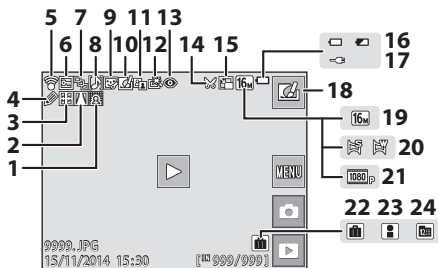

1	Selective softening icon.....	77	13	Red-eye correction icon.....	70
2	Perspective control icon.....	76	14	Crop icon.....	58, 79
3	Stretch icon.....	75	15	Small picture icon.....	78
4	Paint icon.....	73	16	Battery level indicator.....	14
5	Eye-Fi communication indicator	139	17	Charging AC Adapter connection indicator	
6	Protect icon.....	111	18	Quick effects	
7	Sequence display (when Individual pictures is selected)	114	19	Image mode.....	89
8	Voice memo indicator.....	112	20	Easy panorama.....	33
9	Glamour retouch icon.....	71	21	Movie options.....	116
10	Quick effects icon.....	68	22	Album icon in favorite pictures mode.....	60
11	D-Lighting icon.....	70	23	Category icon in auto sort mode	64
12	Quick retouch icon.....	69	24	List by date icon.....	65

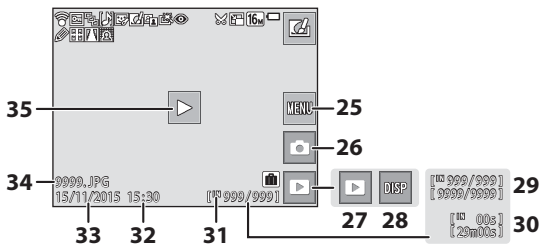

- | | | | |
|-----------|--|-----------|---|
| 25 | Menu screen icon
.....87, 109, 123, 125 | 31 | Internal memory indicator |
| 26 | Shooting mode (switches to shooting mode) 19 | 32 | Time of recording |
| 27 | Playback mode 60, 64, 65 | 33 | Date of recording |
| 28 | Information redisplay 128 | 34 | File number and type 171 |
| 29 | Current image number/
total number of images | 35 | Easy panorama playback
Sequence playback
Movie playback |
| 30 | Movie length or elapsed playback time | | |

Rotating the Monitor Display

The monitor display rotates automatically as shown below, depending on how the camera is oriented.

- The monitor display does not rotate during movie recording or movie playback.
- The monitor display does not rotate when a menu screen is displayed (fixed in horizontal orientation).

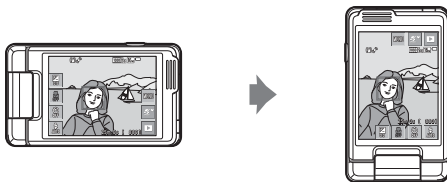

Preparing for Shooting

Insert the Battery and Memory Card

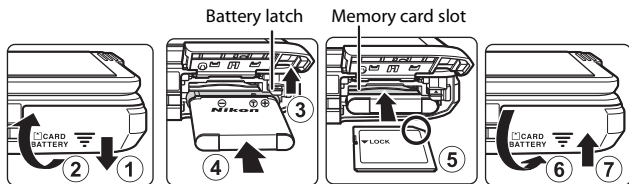

- With the battery's positive and negative terminals oriented correctly, move the orange battery latch (3), and fully insert the battery (4).
- Slide the memory card in until it clicks into place (5).
- Be careful not to insert the battery or memory card upside-down or backward, as this could cause a malfunction.

Formatting a Memory Card

The first time you insert a memory card that has been used in another device into this camera, make sure to format it with this camera. Insert the memory card into the camera, tap , and select **Format card** in the setup menu (87).

Removing the Battery or Memory Card

Turn the camera off and make sure that the power-on lamp and monitor have turned off, and then open the battery-chamber/memory card slot cover.

- Move the battery latch to eject the battery.
- Gently push the memory card into the camera to partially eject the memory card.
- Be careful when handling the camera, battery, and memory card immediately after using the camera, as they may become hot.

Memory Cards and Internal Memory

Camera data, including images and movies, can be saved either on a memory card or in the camera's internal memory. To use the camera's internal memory, remove the memory card.

Notes About the USB Cable

- Do not use a USB cable other than the UC-E21. Using a USB cable other than the UC-E21 could result in overheating, fire or electric shock.
- Make sure that the plugs are properly oriented. Do not insert or remove the plugs at an angle when connecting or disconnecting them.

Notes About Charging the Battery

- The camera can be operated while the battery is charging, but the charging time increases.
- If the battery level is extremely low, you may not be able to operate the camera while the battery is charging.
- Do not, under any circumstances, use another make or model of AC adapter other than Charging AC Adapter EH-71P/EH-71PCH, and do not use a commercially available USB-AC adapter or a battery charger for a mobile phone. Failure to observe this precaution could result in overheating or in damage to the camera.

Charging Using a Computer or Battery Charger

- You can also charge the battery by connecting the camera to a computer.
- You can use the Battery Charger MH-66 (available separately) to charge the battery without using the camera.

Turn the Camera On and Set the Display Language, Date, and Time

When the camera is turned on for the first time, the language-selection screen and the date and time setting screen for the camera clock are displayed.

1 Press the power switch to turn on the camera.

- The monitor turns on.
- To turn the camera off, press the power switch again.

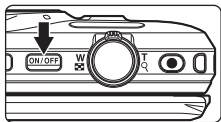

2 Tap the desired language.



3 Tap Yes.

4 Tap ◀▶ to select your home time zone, and then tap OK.

- Tap ⚙ to display ⚙ above the map and enable daylight saving time. Tap ⚙ to disable it.



5 Tap to select the date format.

6 Set the date and time, and tap **OK**.

- Tap a field that you want to change, and then tap **▲▼** to set the date and time.

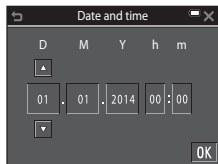

7 When the confirmation dialog is displayed, tap **Yes**.



- When settings are finished, the lens extends.
- The shooting screen is displayed, and you can take pictures in scene auto selector mode.
- Battery level indicator
 - ☐: The battery level is high.
 - ▣: The battery level is low.
- Number of exposures remaining
 [] is displayed when no memory card is inserted in the camera, and images are saved in the internal memory.

Battery level indicator



Number of exposures remaining

Changing the Language or the Date and Time Setting

- You can change these settings using the **Language** and **Time zone and date** settings in the **Y** setup menu (📖87).
- In the **Y** setup menu, you can enable daylight saving time and move the clock forward one hour by selecting  for **Time zone and date** followed by **Time zone** and tapping , or you can disable daylight saving time and move the clock back one hour by tapping  again.

The Clock Battery

- The camera's clock is powered by a built-in backup battery. The backup battery charges when the main battery is inserted into the camera or when the camera is connected to an optional AC adapter, and it can run the clock for several days after about 10 hours of charging.
- If the camera's backup battery becomes exhausted, the date and time setting screen is displayed when the camera is turned on. Set the date and time again (📖13).

Basic Shooting and Playback Operations

Shooting with Scene Auto Selector Mode

1 Hold the camera steady.

- Keep fingers and other objects away from the lens, flash, AF assist-illuminator, microphone, and speaker.
- When taking pictures in portrait ("tall") orientation, turn the camera so that the flash is above the lens.

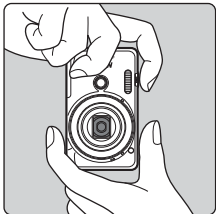
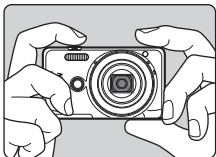

2 Frame the picture.

- Move the zoom control to change the zoom lens position.
- When the camera recognizes the shooting scene, the shooting mode icon changes accordingly.

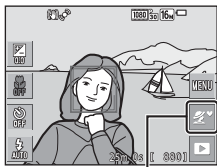
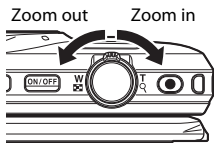

Shooting mode icon

3 Press the shutter-release button halfway.

- When the subject is in focus, the focus area or focus indicator is displayed in green.
- When you are using digital zoom, the camera focuses in the center of the frame and the focus area is not displayed.
- If the focus area or focus indicator flashes, the camera is unable to focus. Modify the composition and try pressing the shutter-release button halfway again.

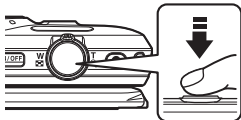

4 Without lifting your finger, press the shutter-release button the rest of the way down.



✓ Notes About Saving Images or Movies

The indicator showing the number of exposures remaining or the indicator showing the remaining recording time flashes while images or movies are being saved. **Do not open the battery-chamber/memory card slot cover or remove the battery or memory card** while an indicator is flashing. Doing this could result in loss of data, or in damage to the camera or the memory card.

📎 The Auto Off Function

- When no operations are performed for about one minute, the monitor turns off, the camera enters standby mode, and then the power-on lamp flashes. The camera turns off after remaining in standby mode for about three minutes.
- To turn the monitor back on while the camera is in standby mode, perform an operation such as pressing the power switch or shutter-release button.

📎 When Using a Tripod

- We recommend using a tripod to stabilize the camera in the following situations:
 - When shooting in dim lighting with the flash mode (📖23) set to ⚡ (off)
 - When the zoom is at a telephoto position
- When using a tripod to stabilize the camera during shooting, set **Photo VR** to **Off** in the setup menu (📖87) to prevent potential errors caused by this function.

Using the Zoom

When you move the zoom control, the zoom lens position changes.

- To zoom in: Move toward **T**
- To zoom out: Move toward **W**

When you turn the camera on, the zoom moves to the maximum wide-angle position.

- A zoom indicator is displayed on the shooting screen when the zoom control is moved.
- Digital zoom, which allows you to further magnify the subject up to approximately 4x the maximum optical zoom ratio, can be activated by moving and holding the zoom control toward **T** when the camera is zoomed in to the maximum optical zoom position.

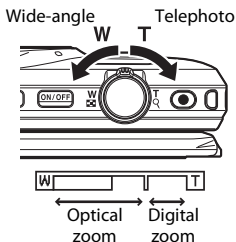



Digital Zoom

The zoom indicator changes to blue when the digital zoom is activated, and it changes to yellow when the zoom magnification is increased further.

- Zoom indicator is blue: Image quality is not noticeably reduced by using the Dynamic Fine Zoom.
- Zoom indicator is yellow: There may be cases in which image quality is noticeably reduced.
- The indicator remains blue across a wider area when the image size is smaller.
- The zoom indicator does not change to blue and the Dynamic Fine Zoom cannot be used with the following settings:
 - **Sports** or **Museum** scene mode
 - Continuous settings (📖96) other than **Single**

The Shutter-release Button

<p>Press halfway</p> 	<p>To set focus and exposure (shutter speed and aperture value), press the shutter-release button lightly until you feel a slight resistance. Focus and exposure remain locked while the shutter-release button is pressed halfway.</p>
<p>Press all the way</p> 	<p>Press the shutter-release button all the way to release the shutter and take a picture. Do not use force when pressing the shutter-release button, as this may result in camera shake and blurred images. Press the button gently.</p>

Using the Front Shutter-release Button

You can also take pictures by pressing the front shutter-release button. This button makes it easier to take self-portrait pictures.

- The front shutter-release button cannot be pressed halfway.
- The camera sets the focus and exposure.



Touch Shooting

The active focus area can be changed when using touch shooting. By default, the shutter can be released by simply tapping a subject in the monitor (91) without pressing the shutter-release button.

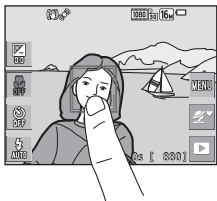

Play Back Images

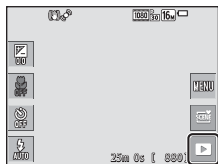

- 1 Tap the playback mode icon to enter playback mode.

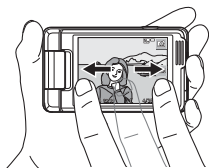

- 2 Drag the current image to display the previous or next image.

- To return to shooting mode, tap the shooting mode icon in the monitor or press the shutter-release button.



- When  is displayed in full-frame playback mode, you can tap  to apply an effect to the image.

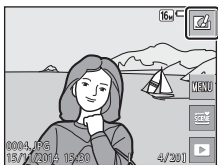

- Spread two fingers apart in full-frame playback mode to zoom in on an image.

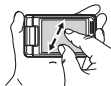

- In full-frame playback mode, pinch two fingers together to switch to thumbnail playback mode and display multiple images on the screen.



Delete Images

- 1 Tap **MENU**, and then tap **Delete** to delete the image currently displayed in the monitor.

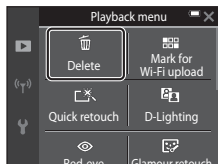

- 2 Tap the desired deletion method.

- To exit without deleting, tap **X**.

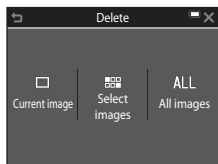

- 3 Tap **Yes**.

- Deleted images cannot be recovered.

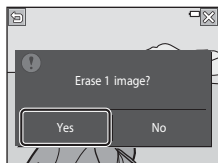

✓ Deleting Images Captured Continuously (Sequence)

- Images captured continuously are saved as a sequence, and only the first image of the sequence (the key picture) is displayed in playback mode (default setting).
- If you tap **MENU** and delete a key picture while it is displayed for a sequence of images, all images in the sequence are deleted.
- To delete individual images in a sequence, tap **▶** to display them one at a time, and tap **MENU** to delete the displayed image.

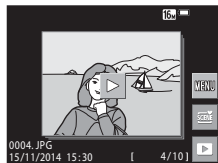

Operating the Erase Selected Images Screen

1 Select an image that you want to delete by tapping it to display ✓.

- To undo the selection, tap the image again to remove ✓.
- Drag the screen up or down to scroll through the images.
- Move the zoom control (📖1) toward **T** (🔍) to switch to full-frame playback or **W** (🖼️) to switch to thumbnail playback.



2 Add ✓ to all images that you want to delete, and then tap **OK** to confirm the selection.

- A confirmation dialog is displayed. Follow the on-screen instructions to complete operations.

Changing the Shooting Mode

The shooting modes described below are available.

- **SCENE Scene auto selector**
The camera automatically recognizes the shooting scene when you frame a picture, making it easier to take pictures using settings that suit the scene.
- **SCENE Scene mode**
Camera settings are optimized according to the scene that you select.
- **Special effects**
Effects can be applied to images during shooting.
- **Smart portrait**
When the camera detects a smiling face, the shutter is released automatically without you pressing the shutter-release button (smile timer). You can also use the skin softening option to smooth the skin tones of human faces.
- **Glamour mode**
Effects that enhance human faces can be applied to images during shooting. In addition, each series of four or nine images captured at intervals with the self-collage function is saved as a one-frame image.
- **Auto mode**
Used for general shooting. Settings can be changed to suit the shooting conditions and the type of shot that you want to capture.

- 1 Tap the shooting mode icon on the shooting screen.

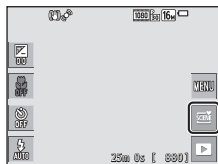

- 2 Tap an icon to select a shooting mode.

- When scene mode or special effects mode is selected, select a scene mode or effect type on the next screen.



Using the Flash, Self-timer, Etc.

You can tap the icons on the shooting screen to set the functions described below. Tap **DISP** when the icons are not displayed.

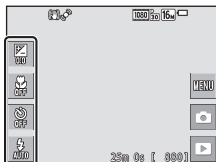

- **Exposure compensation**
You can adjust overall image brightness.
- **Macro mode**
Use macro mode when you take close-up pictures.
- **Self-timer**
The camera releases the shutter 10 seconds or 2 seconds after you press the shutter-release button.
- **Flash mode**
You can select a flash mode to match the shooting conditions.

The functions that can be set vary depending on the shooting mode.

Recording Movies

Display the shooting screen and press the **●** (movie-record) button to start recording a movie. Press the **●** button again to end recording.

- To play back a movie, select a movie in full-frame playback mode, and tap **▶**.

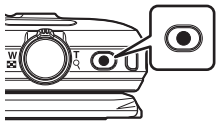











Shooting Features

(Scene Auto Selector) Mode

The camera automatically recognizes the shooting scene when you frame a picture, making it easier to take pictures using settings that suit the scene.



Enter shooting mode → tap the shooting mode icon →  (scene auto selector) mode

When the camera automatically recognizes the shooting scene, the shooting mode icon displayed on the shooting screen changes accordingly.





	Portrait (for taking close-up portraits of one or two people)
	Portrait (for taking portraits of large numbers of people, or images in which the background takes up a large portion of the frame)
	Landscape
	Night portrait (for taking close-up portraits of one or two people)
	Night portrait (for taking portraits of large numbers of people, or images in which the background takes up a large portion of the frame)
	Night landscape
	Close-up
	Backlighting (for taking pictures of subjects other than people)
	Backlighting (for taking portrait pictures)
	Other scenes

- The active focus area can be changed when using touch shooting ()91). When a human or pet face is detected, tap only the border displayed by face detection. Touch shooting may not be available with some scene mode settings selected by the camera.

Notes About (Scene Auto Selector) Mode

- Depending on shooting conditions, the camera may not select the desired scene mode. In this case, select another shooting mode ()22).
- When the digital zoom is in effect, the shooting mode icon changes to .

Functions Available in (Scene Auto Selector) Mode

- Flash mode ()43)
- Self-timer ()45)
- Exposure compensation ()47)
- Image mode ()89)

Scene Mode (Shooting Suited to Scenes)

When a scene is selected, camera settings are automatically optimized for the selected scene.

Enter shooting mode → tap the shooting mode icon → **SCENE** Scene mode → select a scene

Portrait ³ (default setting)	Close-up ³ (📖28)
Landscape ^{1, 2}	Food ³ (📖28)
Sports ^{2, 3} (📖27)	Museum ^{2, 3} (📖28)
Night portrait ³ (📖27)	Fireworks show ^{1, 4} (📖29)
Party/indoor ^{2, 3} (📖27)	Black and white copy ^{2, 3} (📖29)
Beach ^{2, 3}	Draw (📖29)
Snow ^{2, 3}	Backlighting ^{2, 3} (📖29)
Sunset ^{2, 4}	Easy panorama (📖31)
Dusk/dawn ^{1, 2, 4}	Pet portrait ³ (📖30)
Night landscape ^{1, 2} (📖28)	

¹ The camera focuses at infinity.

² The camera focuses on the area in the center of the frame.

³ The active focus area can be changed when using touch shooting (📖91). Tap only the border displayed by face detection in **Portrait**, **Night portrait**, or **Pet portrait** scene mode.

⁴ Use of a tripod is recommended, because the shutter speed is slow. Set **Photo VR** (📖131) to **Off** in the setup menu when using a tripod to stabilize the camera during shooting.

Displaying a Description of Each Scene Mode (Help Display)

When is tapped on the scene selection screen, the **Help selection** screen is displayed. Tap a scene icon to display a description of that scene. To return to the previous screen, tap .

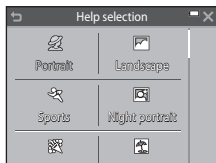

Adjusting the Scene Effects



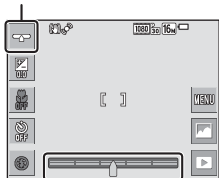

The scene effect adjustment slider is displayed by tapping  in the scene modes listed below.

- Tap or drag the scene effect adjustment slider to adjust the amount of effect to apply to images.
- When you finish making adjustments, tap  to hide the scene effect adjustment slider.

Slider display

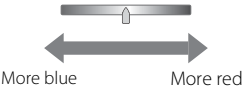

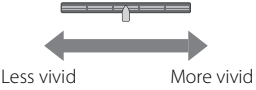
Scene effect adjustment slider

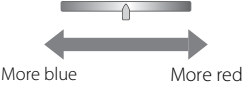
 Food	
 Landscape,  Close-up	
 Sunset,  Dusk/dawn	





The changes made to the scene effects remain saved in the camera's memory even after the camera is turned off.

Tips and Notes

Sports

- While the shutter-release button is held all the way down, the camera shoots up to about 7 images continuously at a rate of about 2 fps (when image mode is set to **16M**).
- The frame rate for continuous shooting may vary depending on the current image mode setting, the memory card used, or shooting conditions.
- Focus, exposure, and hue are fixed at the values determined with the first image in each series.
- When shooting with the touch shutter function ()92), images are captured one frame at a time.





Night portrait

- Tap  on the shooting screen and select **Hand-held** or **Tripod** in **Night portrait**.
-  **Hand-held** (default setting):
 - While the  icon on the shooting screen is displayed in green, press the shutter-release button all the way to capture a series of images which are combined into a single image and saved.
 - Once the shutter-release button is pressed all the way, hold the camera still until a still image is displayed. After taking a picture, do not turn the camera off before the monitor switches to the shooting screen.
 - If the subject moves while the camera is shooting continuously, the image may be distorted, overlapped, or blurred.
-  **Tripod**:
 - One image is captured at a slow shutter speed when the shutter-release button is pressed all the way.
 - Vibration reduction is disabled even when **Photo VR** ()131) in the setup menu is set to **On**.

Party/indoor

- To avoid the effects of camera shake, hold the camera steady. Set **Photo VR** ()131) to **Off** in the setup menu when using a tripod to stabilize the camera during shooting.

Night landscape

- Tap  on the shooting screen and select **Hand-held** or **Tripod** in **Night landscape**.
-  **Hand-held** (default setting):
 - While the  icon on the shooting screen is displayed in green, press the shutter-release button all the way to capture a series of images which are combined into a single image and saved.
 - Once the shutter-release button is pressed all the way, hold the camera still until a still image is displayed. After taking a picture, do not turn the camera off before the monitor switches to the shooting screen.
 - The angle of view (i.e., the area visible in the frame) seen in the saved image is narrower than that seen in the monitor at the time of shooting.
-  **Tripod**:
 - One image is captured at a slow shutter speed when the shutter-release button is pressed all the way.
 - Vibration reduction is disabled even when **Photo VR** ( 131) in the setup menu is set to **On**.

Close-up

- Macro mode ( 46) is enabled and the camera automatically zooms to the closest position at which it can focus.

Food

- Macro mode ( 46) is enabled and the camera automatically zooms to the closest position at which it can focus.

Museum

- The camera captures a series of up to 10 images while the shutter-release button is held all the way down, and the sharpest image in the series is automatically selected and saved (BSS (Best Shot Selector)).
- The flash does not fire.
- When shooting with the touch shutter function ( 92), the BSS function is disabled.



Fireworks show

- The shutter speed is fixed at four seconds.
- The zoom is restricted to four fixed positions.



Black and white copy

- Use together with macro mode (46) when shooting subjects that are close to the camera.

Backlighting



- Tap  on the shooting screen and select **On** or **Off** in **HDR** to enable or disable the high dynamic range (HDR) function based on the type of image you want to capture.
- **OFF off** (default setting): The flash fires to prevent the subject from being hidden in shadow.
 - When the shutter-release button is pressed all the way down, one image is captured.
- **ON On**: Use when taking pictures with very bright and dark areas in the same frame.
 - When the shutter-release button is pressed all the way, the camera shoots images continuously at high speed, and saves the following two images:
 - A non-HDR composite image
 - An HDR composite image in which the loss of details in highlights or shadows is minimized
 - If there is only enough memory to save one image, an image processed by D-Lighting (70) at the time of shooting, in which dark areas of the image are corrected, is the only image saved.
 - Once the shutter-release button is pressed all the way, hold the camera still until a still image is displayed. After taking a picture, do not turn the camera off before the monitor switches to the shooting screen.
 - The angle of view (i.e., the area visible in the frame) seen in the saved image is narrower than that seen in the monitor at the time of shooting.

Draw

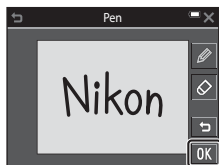

- Use  or  to write or draw on images, and tap  to save the images.
- Images are saved at a size of 640 × 480.



Pet portrait

- When you point the camera at a dog or cat, the camera detects the pet's face and focuses on it. By default, the camera detects a dog or cat face and automatically releases the shutter (pet portrait auto release).
- Tap  on the shooting screen and select **Single** or **Continuous** in **Continuous**.
 -  **Single**: The camera captures one image when a dog or cat face is detected.
 -  **Continuous**: The camera captures three images continuously when a dog or cat face is detected.

Pet Portrait Auto Release

- Tap  on the shooting screen and select **On** or **Off** in **Pet portrait auto release**.
 -  **On**: The camera detects a dog or cat face and automatically releases the shutter.
 - **OFF Off**: The camera does not release the shutter automatically, even if a dog or cat face is detected. Press the shutter-release button. The camera also detects human faces when **Off** is selected.
- **Pet portrait auto release** is set to **Off** after five bursts have been taken.
- Shooting is also possible by pressing the shutter-release button, regardless of the **Pet portrait auto release** setting.
When **Continuous** is selected, you can take pictures continuously while holding down the shutter-release button all the way.

Focus Area

- When the camera detects a face, the face is displayed inside a yellow border. When the camera acquires focus on a face displayed inside a double border (focus area), the double border changes to green. If no faces are detected, the camera focuses on the subject in the center of the frame.
- Under some shooting conditions, the pet face may not be detected and other subjects may be displayed inside a border.

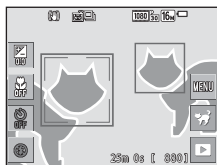

Shooting with Easy Panorama

Enter shooting mode → tap the shooting mode icon → **SCENE** Scene mode
→ Easy panorama



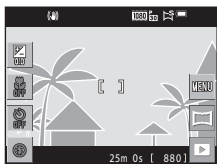

Select a shooting range of either **Normal (180°)** (default setting) or **Wide (360°)**. See “Changing the Shooting Range” (32) for more information.

1 Frame the first edge of the panorama scene, and then press the shutter-release button halfway to focus.

- The zoom position is fixed at wide-angle position.
- The camera focuses in the center of the frame.



2 Press the shutter-release button all the way, and then remove your finger from the shutter-release button.

-     are displayed to indicate the direction of camera movement.



3 Move the camera in one of the four directions until the guide indicator reaches the end.

- When the camera detects which direction it is moving in, shooting begins.
- Shooting ends when the camera captures the specified shooting range.
- Focus and exposure are locked until shooting ends.

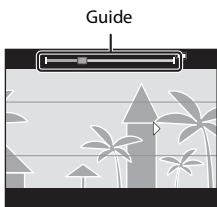

Example of camera movement



- Using your body as the axis of rotation, move the camera slowly in an arc, in the direction of the marking (△▽◀▶).
- Shooting stops if the guide does not reach the edge within about 15 seconds (when **Normal (180°)** is selected) or within about 30 seconds (when **Wide (360°)** is selected) after shooting starts.

✓ Notes About Easy Panorama Shooting

- The range of the image seen in the saved image is narrower than that seen in the monitor at the time of shooting.
- If the camera is moved too quickly or shaken too much, or if the subject is too uniform (e.g. walls or darkness), an error may occur.
- If shooting is stopped before the camera reaches the half-way point in the panorama range, a panorama image is not saved.
- If more than half of the panorama range is captured but shooting ends before reaching the edge of the range, the range not captured is recorded and displayed in gray.

📎 Changing the Shooting Range

- Tap **MENU** on the shooting screen and select **Normal (180°)** or **Wide (360°)** in **Easy panorama**.
- Images are saved at the sizes (horizontal × vertical) described below when the camera is oriented horizontally.
 - **Normal (180°)**: 4800 × 920 when moving horizontally and 1536 × 4800 when moving vertically
 - **Wide (360°)**: 9600 × 920 when moving horizontally and 1536 × 9600 when moving vertically

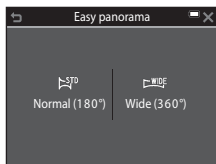

Playback with Easy Panorama

Switch to playback mode (📖19), display an image captured using easy panorama in full-frame playback mode, and then tap  to scroll the image in the direction that was used when shooting.

- You can also drag your finger across the monitor to scroll the image.

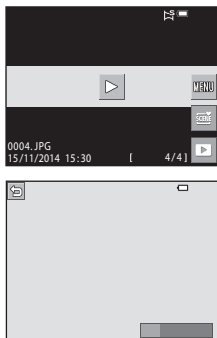

Tap the monitor to perform operations described below.

Function	Operation	
Pause	Tap the monitor to pause scrolling.	
	Scroll manually	While paused, drag your finger across the monitor to scroll the displayed image.
	Resume automatic scrolling	While paused, tap the monitor to resume automatic scrolling.
End	Tap  .	

✓ Notes About Easy Panorama Images



- The images cannot be edited on this camera.
- This camera may not be able to scroll the playback of, or zoom in on, easy panorama images captured with another make or model of digital camera.







✓ Notes About Printing Panorama Images

The entire image may not be able to be printed depending on the printer's settings. Additionally, printing may not be possible depending on the printer.

Special Effects Mode (Applying Effects When Shooting)

Effects can be applied to images during shooting.

Enter shooting mode → tap the shooting mode icon →  Special effects mode → select an effect → tap 

Type	Description
SOFT Soft* (default setting)	Softens the image by adding a slight blur to the entire image.
SEPIA Nostalgic sepia*	Adds a sepia tone and reduces the contrast to simulate the qualities of an old photograph.
 High-contrast monochrome*	Changes the image to black and white and gives it sharp contrast.
HIGH High key	Gives the entire image a bright tone.
LOW Low key	Gives the entire image a dark tone.
 Selective color	Creates a black and white image in which only the specified color remains.
POP Pop	Increases the color saturation of the entire image to create a bright look.
VIVID Super vivid	Increases the color saturation of the entire image and sharpens the contrast.
 Toy camera effect 1*	Gives the entire image a yellowish hue and darkens the image periphery.
 Toy camera effect 2*	Decreases the color saturation of the entire image and darkens the image periphery.
 Cross process	Gives the image a mysterious appearance based on a specific color.
 Mirror*	Creates a bilaterally symmetric image whose right half is an inverted mirror image of the left half.

* Certain **Movie options** ( 116) are not available.

- The camera focuses on the area in the center of the frame.
- The active focus area can be changed when using touch shooting (91).
- When **Selective color** or **Cross process** is selected, tap or drag the slider to select the desired color.

To display or hide the slider, tap .

Slider display

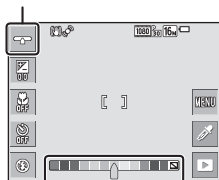

Slider

Smart Portrait Mode (Capturing Images of Smiling Faces)

When the camera detects a smiling face, you can take a picture automatically without pressing the shutter-release button (smile timer (📖106)). You can use the skin softening option to smooth the skin tones of human faces.

Enter shooting mode → tap the shooting mode icon → 😊 Smart portrait mode

1 Frame the picture.

- Point the camera at a human face.

2 Without pressing the shutter-release button, wait for the subject to smile.

- If the camera detects that the face framed by the double border is smiling, the shutter is automatically released.
- Whenever the camera detects a smiling face, it automatically releases the shutter.

3 End automatic shooting.

- Perform one of the operations listed below to end shooting.
 - Set **Smile timer** to **Off**.
 - Tap the shooting mode icon and select a different shooting mode.

✓ Notes About Smart Portrait Mode

Under some shooting conditions, the camera may be unable to detect faces or smiles (📖50). The shutter-release button can also be used for shooting.

📌 When the Self-timer Lamp Flashes

When using smile timer, the self-timer lamp flashes when the camera detects a face and flashes quickly immediately after the shutter is released.

Functions Available in Smart Portrait Mode

- Flash mode (📖43)
- Self-timer (📖45)
- Exposure compensation (📖47)
- Smart portrait menu (📖105)

Glamour Mode (Enhancing Human Faces When Shooting)





Effects that enhance human faces can be applied to images during shooting.

Enter shooting mode → tap the shooting mode icon →  Glamour mode

1 Tap .



2 Apply an effect.

- Tap an icon to select an effect.
- Tap or drag the slider to adjust the amount of effect.
- You can simultaneously apply multiple effects.
 **Skin softening**,  **Powder**,  **Soft**,
 **Vividness**
- Tap **OK** after checking the settings for all effects.

Effect







Slider

3 Frame the picture and press the shutter-release button.

Notes About Glamour mode

- The images displayed in the monitor during shooting may differ in appearance from the saved images.
- When **Soft** is set, certain **Movie options** ( 116) are not available.

Functions Available in Glamour Mode





- Flash mode ( 43)
- Self-timer ( 45)
- Exposure compensation ( 47)
- Glamour mode menu ( 108)

Using Self-Collage

The camera can capture a series of four or nine images at intervals and save them as a one-frame image (a collage image).



Enter shooting mode → tap the shooting mode icon →  Glamour mode

1 Tap .

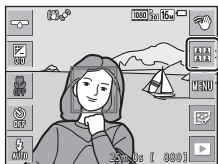
- A confirmation dialog is displayed.
- If you tap  and select **Self-Collage** before tapping , you can make settings for **Number of shots**, **Interval**, and **Shutter sound** (108).
- If you want to apply a glamour mode effect, set the effect before using the self-collage function (37).



2 Take the first picture.

- When you tap  on the confirmation dialog, a countdown starts (about five seconds) and the shutter is automatically released.
- The number of shots is indicated by  in the monitor. It is displayed in green during shooting and it changes to white after shooting.

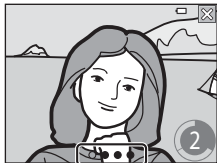

3 Take the second and remaining pictures.



- The shutter is automatically released at the specified intervals.
- A countdown starts about three seconds before shooting.
- Shooting ends when the specified number of shots is reached.
- Each captured image is saved as an individual image separate from the collage image. The individual images are saved as a sequence, and a one-frame collage image similar to the one shown on the right is used as the key picture (66).







(Auto) Mode

Used for general shooting. Settings can be adjusted to suit the shooting conditions and the type of shot you want to capture.

Enter shooting mode → tap the shooting mode icon →  (auto) mode

- You can change how the camera selects the area of the frame to focus on by changing the **AF area mode** setting (101).
The default setting is **Target finding AF** (52).
- The active focus area can be changed when using touch shooting (91).

Functions Available in (Auto) Mode

- Flash mode (43)
- Self-timer (45)
- Macro mode (46)
- Exposure compensation (47)
- Shooting menu (89)

Using Quick Effects

When in  (auto) mode, you can apply effects to images immediately after releasing the shutter.





- The edited image is saved as a separate file with a different name.

1 Tap when the image is displayed after it is taken in (auto) mode.

- When no operations are performed for about five seconds, the monitor display returns to the shooting screen.
- To not display the screen shown on the right, set **Quick effects** ( 104) to **Off** in the shooting menu.



2 Tap the desired effect, and tap .

- Move the zoom control ( 1) toward **T** () to switch to full-frame playback or **W** () to switch to thumbnail playback.
- See “Quick Effects: Changing Hue or Mood” ( 68) for more information about the effect types.
- If you tap  in full-frame playback, proceed to step 4.

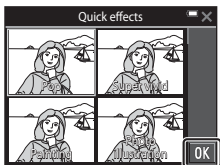

3 Check the effect preview, and tap .

- To exit without saving the edited image, tap .

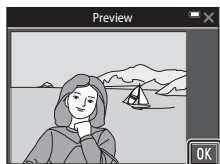

4 Tap **Yes**.

Notes About Quick Effects

The quick effects function is disabled when Wi-Fi is connected.

Using the Self-timer with the Gesture Control Function

The camera can detect your moving hand and automatically capture images. This function is useful when taking self-portrait pictures or shooting from a short distance.

1 Open the monitor and face it forward in the same direction as the camera lens (📖2).



- is displayed in the monitor. is not displayed when using a shooting mode that cannot be used with the gesture control function.
- When you take pictures from a short distance, use the camera stand (📖3) and place the camera on a stable surface.

2 Tap .

- When you tap **OK** on the confirmation dialog, (palm detection) is displayed in the monitor.



3 Hold up your hand and align it with in the center of the frame.

- When the camera detects your palm, changes to , and (to take a still image) and (to record a movie) are displayed in the monitor.

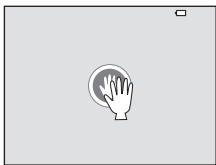

4 Move your hand to align with or .

- The shutter is released after a countdown (about three seconds).
- Press the (movie-record) button on the camera body to end the recording. See "Extracting and Saving the Desired Portion of a Recorded Movie" (📖85) for information on how to remove unwanted parts of movies.
- When shooting ends, the screen shown in step 3 is displayed again.

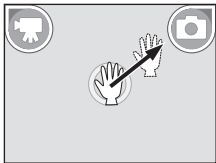

Notes About the Gesture Control Function

- The camera may not detect your palm or hand movement in some shooting conditions.
- When moving your hand, keep your palm vertical and facing the camera, and maintain the same hand shape.
- The gesture control function cannot be used in the following shooting modes:
 - Scene modes (except **Portrait**, **Night portrait**, **Party/indoor**, and **Backlighting** scene modes)
 - Special effects mode
- The functions listed below are restricted when the gesture control function is in use.

Restricted function	Description
Self-timer (📖45), Color options (📖100), AF area mode (📖101), Quick effects (📖104), Smile timer (📖106), AF assist (📖133), Digital zoom (📖133)	These functions cannot be used.
Vividness (📖37)	The setting is fixed at the standard value (default setting) if the Vividness setting for an amount of the effect is set to the minimum before you start using the gesture control function.
White balance (📖94)	The setting is fixed at Auto if Incandes. or Fluorescent is set before you start using the gesture control function.
Continuous (📖96)	The setting is fixed at Single if Continuous H , Continuous L , Pre-shooting cache , or BSS is set before you start using the gesture control function.
Monitor settings (📖128)	Photo info is fixed at Show info .
Auto off (📖134)	The setting is fixed at 5 min if 30 s or 1 min is set before you start using the gesture control function.

- When the monitor is returned to the open rearward-facing position against the back of the camera, the restricted functions are reset to their original settings (if you did not change the settings while using the gesture control function).

Flash Mode

You can select a flash mode to match the shooting conditions.

1 Tap the flash mode icon.

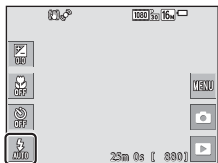

2 Tap an icon to select a flash mode.

- To return to the shooting screen without changing the setting, tap **X**.

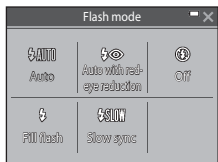

The Flash Indicator

The status of the flash can be confirmed by pressing the shutter-release button halfway.

- On: The flash fires when you press the shutter-release button all the way down.
- Flashing: The flash is charging. The camera cannot shoot images.
- Off: The flash does not fire when a picture is taken.

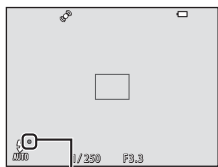

Flash indicator

Available Flash Modes

AUTO Auto

The flash fires when necessary, such as in dim lighting.

Auto with red-eye reduction

Reduce “red-eye” in portraits caused by the flash.

Off

The flash does not fire.

- We recommend using a tripod to stabilize the camera when shooting in dark surroundings.

Fill flash

The flash fires whenever a picture is taken. Use to “fill-in” (illuminate) shadows and backlit subjects.

SLOW Slow sync

Suited to evening and night portraits that include background scenery. The flash fires when necessary to illuminate the main subject; slow shutter speeds are used to capture background at night or under dim lighting.

The Flash Mode Setting

- The setting may not be available with some shooting modes (📖48).
- The setting applied in  (auto) mode is saved in the camera’s memory even after the camera is turned off.

Red-eye Reduction

If the camera detects red eye while saving an image, the affected area is processed to reduce red-eye before the image is saved.

Note the following when shooting:

- More time than usual is required to save images.
- Red-eye reduction may not produce the desired results in some situations.
- In rare cases, red-eye reduction may be applied unnecessarily to other areas of the image. In these cases, select another flash mode and take the picture again.

Self-timer

The camera is equipped with a self-timer that releases the shutter 10 seconds or 2 seconds after you press the shutter-release button.

Set **Photo VR** (📖 131) to **Off** in the setup menu when using a tripod to stabilize the camera during shooting.

1 Tap the self-timer icon.

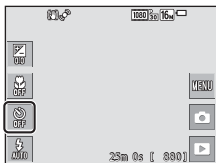

2 Tap 10 s or 2 s.

- **10 s** (10 seconds): Use on important occasions, such as weddings.
- **2 s** (2 seconds): Use to prevent camera shake.
- To return to the shooting screen without changing the setting, tap **X**.

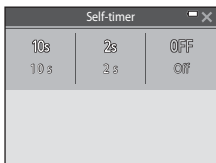

3 Frame the picture and press the shutter-release button halfway.

- Focus and exposure are set.

4 Press the shutter-release button the rest of the way down.

- Countdown starts. The self-timer lamp flashes and then glows steadily about one second before the shutter is released.
- When the shutter is released, the self-timer is set to **Off**.
- To stop the countdown, press the shutter-release button again.

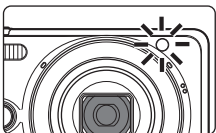
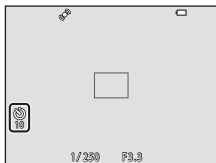

Macro Mode (Taking Close-up Pictures)

Use macro mode when taking close-up pictures.

- 1 Tap the macro mode icon.

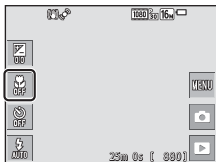

- 2 Tap **On**.

- To return to the shooting screen without changing the setting, tap **X**.

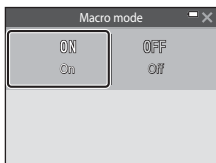

- 3 Move the zoom control to set the zoom ratio to a position where  and the zoom indicator are displayed in green.





- When the zoom ratio is set to a position where the zoom indicator is displayed in green, the camera can focus on subjects as close as approximately 10 cm (4 in.) from the lens.
When the zoom is at the position where  is displayed, the camera can focus on subjects as close as approximately 2 cm (0.8 in.) from the lens.

Notes About Using the Flash

The flash may be unable to light the entire subject at distances of less than 50 cm (1 ft 8 in.).

The Macro Mode Setting

- The setting may not be available with some shooting modes (48).
- If the setting is applied in  (auto) mode, it will remain saved in the camera's memory even after the camera is turned off.

Exposure Compensation (Adjusting Brightness)

You can adjust overall image brightness.

- 1 Tap the exposure compensation icon.



- 2 Tap or drag the slider to change a compensation value, and tap **OK**.

- To brighten the image, set a positive (+) value.
- To darken the image, set a negative (-) value.
- The compensation value is applied, even without tapping **OK**.

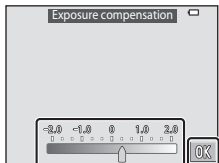















Exposure Compensation Value





- The setting may not be available with some shooting modes (📖48).
- If the setting is applied in  (auto) mode, it will remain saved in the camera's memory even after the camera is turned off.

Default Settings (Flash, Self-timer, Etc.)

Default settings for each shooting mode are listed below.





	Flash (43)	Self-timer (45)	Macro (46)	Exposure compensation (47)
(scene auto selector)	AUTO ¹	Off	Off ²	0.0
Scene				
(portrait)		Off	Off ³	0.0
(landscape)	³	Off	Off ³	0.0
(sports)	³	Off ³	Off ³	0.0
(night portrait)	⁴	Off	Off ³	0.0
(party/indoor)	⁵	Off	Off ³	0.0
(beach)	AUTO	Off	Off ³	0.0
(snow)	AUTO	Off	Off ³	0.0
(sunset)	³	Off	Off ³	0.0
(dusk/dawn)	³	Off	Off ³	0.0
(night landscape)	³	Off	Off ³	0.0
(close-up)		Off	On ³	0.0
(food)	³	Off	On ³	0.0
(museum)	³	Off	Off	0.0
(fireworks show)	³	Off ³	Off ³	0.0 ³
(black and white copy)		Off	Off	0.0
(draw)	–	–	–	–
(backlighting)	⁶	Off	Off ³	0.0
(easy panorama)	³	Off ³	Off ³	0.0

	Flash ( 43)	Self-timer ( 45)	Macro ( 46)	Exposure compensation ( 47)
 (pet portrait)	 ³	Off ³	Off	0.0
 (special effects)		Off	Off	0.0
 (smart portrait)	 AUTO ⁷	Off ⁸	Off ³	0.0
 (glamour mode)	 AUTO	Off	Off ³	0.0
 (auto)	 AUTO	Off	Off	0.0

- ¹ The camera automatically selects the flash mode appropriate for the scene it has selected.  (off) can be selected manually.
- ² Cannot be changed. The camera enters macro mode when  is selected.
- ³ Cannot be changed.
- ⁴ Cannot be changed. The flash mode setting is fixed at fill flash with red-eye reduction.
- ⁵ Slow sync with red-eye reduction flash mode may be used.
- ⁶ Flash is fixed at  (fill flash) when **HDR** is set to **Off**, and is fixed at  (off) when **HDR** is set to **On**.
- ⁷ Cannot be used when **Blink proof** is set to **On** or when **Smile timer** is set to **On (continuous)** or **On (BSS)**.
- ⁸ Can be set when **Smile timer** is set to **Off**.

Using Skin Softening

When the shutter is released while using one of the shooting modes listed below, the camera detects human faces and processes the image to soften facial skin tones (up to three faces).

- Smart portrait mode (📖36)
 - The amount of **Skin softening** effect can be adjusted.
- Glamour mode (📖37)
 - The amount of **Skin softening** effect can be adjusted.
-  **Portrait**,  **Night portrait**, or  **Backlighting** in  (scene auto selector) mode (📖24)
- **Portrait** or **Night portrait** scene mode (📖25)

Editing functions such as **Skin softening** can be applied to saved images by using **Glamour retouch** (📖71) even after shooting.

✔ Notes About Skin Softening

- It may take more time than usual to save images after shooting.
- Under some shooting conditions, the desired skin softening results may not be achieved, and skin softening may be applied to areas of the image where there are no faces.

Using Target Finding AF

When **AF area mode** (📖101) in 📷 (auto) mode is set to **Target finding AF**, the camera focuses in the manner described below when you press the shutter-release button halfway.

- The camera detects the main subject and focuses on it. When the subject is in focus, the focus area is displayed in green. If a human face is detected, the camera automatically sets focus priority on it.

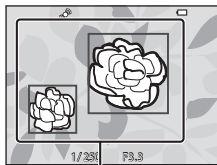

Focus areas

- If no main subject is detected, the camera automatically selects one or more of the nine focus areas containing the subject closest to the camera. When the subject is in focus, the focus areas that are in focus are displayed in green.

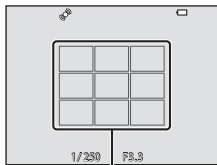

Focus areas

✔ Notes About Target Finding AF

- Depending on shooting conditions, the subject that the camera determines to be the main subject may vary.
- The main subject may not be detected when using certain **White balance** settings.
- The camera may not detect the main subject appropriately in the following situations:
 - When the subject is very dark or bright
 - When the main subject lacks clearly defined colors
 - When the shot is framed so that the main subject is at the edge of the monitor
 - When the main subject is composed of a repeating pattern

Subjects Not Suitable for Autofocus

The camera may not focus as expected in the following situations. In rare cases, the subject may not be in focus despite the fact that the focus area or the focus indicator is displayed in green:

- Subject is very dark
- Objects of sharply differing brightness are included in the scene (e.g. the sun behind the subject makes that subject appear very dark)
- No contrast between the subject and surroundings (e.g. a portrait subject wearing a white shirt is standing in front of a white wall)
- Several objects are at different distances from the camera (e.g. the subject is inside a cage)
- Subjects with repeating patterns (window blinds, buildings with multiple rows of similarly shaped windows, etc.)
- Subject is moving rapidly

In the situations noted above, try pressing the shutter-release button halfway to refocus several times, or focus on another subject positioned at the same distance from the camera as the actual desired subject, and use focus lock (📖54).

Focus Lock

Focus lock shooting is recommended when the camera does not activate the focus area that contains the desired subject.

1 Set **AF area mode** to **Center** in  (auto) mode (101).

2 Position the subject in the center of the frame and press the shutter-release button halfway.

- The camera focuses on the subject and the focus area is displayed in green.
- Exposure is also locked.

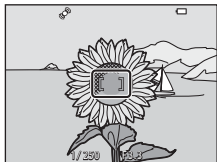

3 Without lifting your finger, recompose the picture.

- Make sure to maintain the same distance between the camera and the subject.

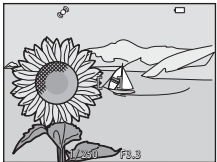

4 Press the shutter-release button the rest of the way down to take the picture.



Functions That Cannot Be Used Simultaneously When Shooting

Some functions cannot be used with other menu options.

Restricted function	Option	Description
Flash mode	Continuous (📖96)	When a setting other than Single is selected, the flash cannot be used.
	Blink proof (📖107)	When Blink proof is set to On , the flash cannot be used.
	Smile timer (📖106)	When On (continuous) or On (BSS) is selected, the flash cannot be used.
Self-timer	Smile timer (📖106)	When Smile timer is selected, the self-timer cannot be used.
	AF area mode (📖101)	When Subject tracking is selected, the self-timer cannot be used.
Macro mode	AF area mode (📖101)	When Subject tracking is selected, macro mode cannot be used.
Image mode	Continuous (📖96)	<p>Image mode is set as follows depending on the continuous shooting setting:</p> <ul style="list-style-type: none"> • Continuous H: 120 fps: VGA (image size: 640 × 480 pixels) • Continuous H: 60 fps: 1.M (image size: 1280 × 960 pixels) • Multi-shot 16: 5.M (image size: 2560 × 1920 pixels)
Touch shooting	Smile timer (📖106)	When shooting with Smile timer , Touch shooting cannot be used.
	Pet portrait auto release (📖30)	When shooting with Pet portrait auto release , Touch shooting cannot be used.
	AF area mode (📖101)	When Subject tracking is selected, Touch shooting cannot be used.

Restricted function	Option	Description
White balance	Color options (📖100)	When Black-and-white , Sepia , or Cyanotype is selected, the White balance setting is fixed at Auto .
Continuous	Self-timer (📖45)	If the self-timer is used when Pre-shooting cache is selected, the setting is fixed at Single .
	Touch shutter (📖92)	When using the touch shutter function, images are captured one frame at a time except with Multi-shot 16 .
ISO sensitivity	Continuous (📖96)	When Pre-shooting cache , Continuous H: 120 fps , or Continuous H: 60 fps is selected, ISO sensitivity is fixed at Auto .
AF area mode	White balance (📖94)	When a setting other than Auto is selected for White balance in Target finding AF mode, the camera does not detect the main subject.
Quick effects	Continuous (📖96)	The quick effects function cannot be used when shooting images with continuous shooting.
Smile timer	Blink proof (📖107)	When Blink proof is set to On , Smile timer is fixed at On (single) for On (continuous) or On (BSS) .
Blink proof	Smile timer (📖106)	When Smile timer is set to On (continuous) or On (BSS) , Blink proof is fixed at Off .
Monitor settings	Quick effects (📖104)	When Quick effects is set to On while shooting still images, the captured image is displayed after shooting, regardless of the Image review setting.
Date stamp	Continuous (📖96)	When Pre-shooting cache , Continuous H: 120 fps , or Continuous H: 60 fps is selected, date and time cannot be stamped on images.

Restricted function	Option	Description
Motion detection	Continuous (📖96)	When a setting other than Single is selected, Motion detection is disabled.
	ISO sensitivity (📖99)	When the ISO sensitivity is set to any setting other than Auto , Motion detection is disabled.
	AF area mode (📖101)	When Subject tracking is selected, Motion detection is disabled.
	Smile timer (📖106)	When On (continuous) or On (BSS) is selected, Motion detection is disabled.
Blink warning	Continuous (📖96)	When a setting other than Single is selected, Blink warning is disabled.
Digital zoom	AF area mode (📖101)	When Subject tracking is selected, digital zoom cannot be used.
Shutter sound	Continuous (📖96)	When a setting other than Single is selected, the shutter sound is disabled.

✓ Notes About Digital Zoom

- Depending on the shooting mode or the current settings, digital zoom may not be available (📖133).
- When digital zoom is in effect, the camera focuses in the center of the frame.

Playback Features

Playback Zoom

Spread two fingers apart in full-frame playback mode (📖19) to zoom in on the image.

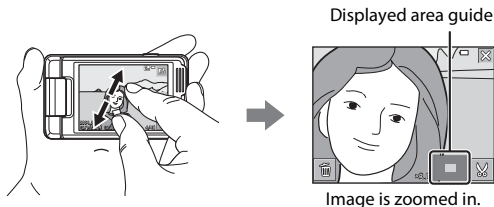

- You can also zoom in on images by moving the zoom control toward **T** (📐) or double-tapping an image.
- The magnification rate changes as your fingers move (spread apart or pinch together). You can also change the magnification rate by moving the zoom control (**T** (📐)/**W** (📐)).
- To view a different area of the image, drag the image.
- If you move the zoom control to zoom in on an image that was captured using face detection or pet detection, the camera zooms in on the face detected at the time of shooting (except images captured in a series). If the camera detected multiple faces when the image was captured, tap 📐 or 📐 to display a different face.
- To delete images, tap 🗑️.
- When a zoomed image is displayed, tap ✕ or double-tap the image to return to full-frame playback mode.

Cropping Images

When a zoomed image is displayed, you can tap ✂️ to crop the image to include only the visible portion and save it as a separate file (📖79).

Thumbnail Playback/Calendar Display

Pinch two fingers together in full-frame playback mode (📖19) to display images as thumbnails.



- You can also display thumbnail playback mode by moving the zoom control toward **W** (📐).
- The number of thumbnails displayed changes as your fingers move (spread apart or pinch together). You can also change the number of thumbnails by moving the zoom control (**T** (📐)/**W** (📐)).
- Drag the screen up or down to scroll through the images.
- While using thumbnail playback mode, tap an image to display it in full-frame playback mode.
- While using calendar display mode, tap a date to display the images captured on that day.

✓ Notes About Calendar Display

Images captured when the camera's date is not set are treated as images captured on January 1, 2014.

Favorite Pictures Mode

By adding images (except movies) to albums as favorite pictures, you can play back only the added images.





- Images can be sorted into 9 albums. Up to 200 images can be added to each album.
- The original images are not copied or moved.
- The same image can be added to multiple albums.

Adding Images to Albums

Tap the playback mode icon (playback mode*) → tap **MENU** → **★ Favorite pictures**

* Images cannot be added in favorite pictures playback mode.

1 Select an image that you want to add to an album by tapping it to display .

- You can select multiple images. To remove , tap the image again.
- Move the zoom control (1) toward **T** () to switch to full-frame playback or **W** () to switch to thumbnail playback.

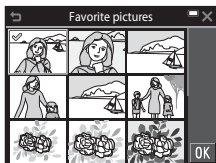

2 Tap **OK** after configuring the settings.

3 Tap the desired album.

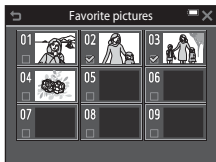



4 Tap **Yes**.

- The selected images are added.

Playing Back Images in Albums

Enter playback mode → tap the playback mode icon →  Favorite pictures

Tap an album that you want to display to play back the images in the selected album.

- Functions in the playback menu ( 109) can be used for the images in the selected album (except **Copy** and **Favorite pictures**).
- You can change the album icon by tapping  ( 63).

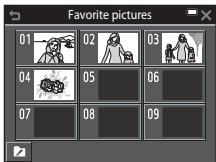





Notes About Deletion

If an image is deleted while using favorite pictures mode, the original image is deleted. When removing images from albums, see “Removing Images from Albums” ( 62).

Removing Images from Albums

Enter  Favorite pictures mode → tap the album containing the image you want to remove → tap  →  Remove from favorites

1 Tap an image that you want to remove from albums to deselect .

- You can select multiple images. To display , tap the image again.
- Move the zoom control () toward **T** () to switch to full-frame playback or **W** () to switch to thumbnail playback.

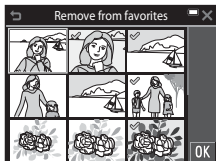

2 Tap  after configuring the settings.

3 Tap **Yes**.

- To cancel removal, tap **No**.

Changing the Album Icon

Enter playback mode → tap the playback mode icon →  Favorite pictures

1 Tap .

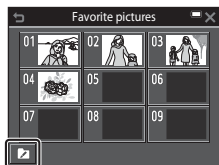

2 Select an icon and icon color.

- Tap to select an icon.
- Tap or drag the slider to select icon color.
- Tap **OK**.

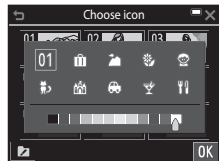

3 Tap an album that you want to change.

- The icon changes.

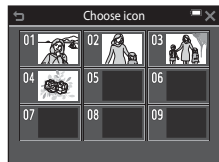

Auto Sort Mode

Images are automatically sorted into categories, such as portraits, landscapes, and movies, based on the camera settings at the time of shooting.

Enter playback mode → tap the playback mode icon →  Auto sort

Tap a category that you want to display to play back the images in the selected category.

- Functions in the playback menu (📖109) can be used for the images in the selected category (except **Copy** and **Remove from favorites**).

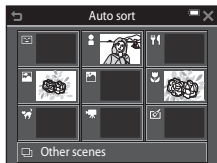

✓ Notes About Auto Sort Mode

- Up to 999 images and movie files can be sorted into each category in auto sort mode.
- Images or movies saved by cameras other than this camera cannot be played back in auto sort mode.





List by Date Mode

Enter playback mode → tap the playback mode icon →  List by date

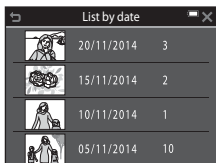
Tap a date that you want to display to play back the images captured on the selected date.

- Functions in the playback menu ( 109) can be used for the images in the selected shooting date (except **Copy** and **Remove from favorites**).



List by date		
	20/11/2014	3
	15/11/2014	2
	10/11/2014	1
	05/11/2014	10

Notes About List by Date Mode

- Up to the most recent 29 dates can be selected. If images exist for more than 29 dates, all images saved earlier than the most recent 29 dates will be combined under **Others**.
- The 9,000 most recent images can be displayed.
- Images captured when the camera's date is not set are treated as images captured on January 1, 2014.

Viewing and Deleting Images Captured Continuously (Sequence)



Viewing Images in a Sequence

Images captured continuously or with the self-collage function are saved as a sequence.

The first image of a sequence is used as the key picture to represent the sequence when displayed in full-frame playback mode or thumbnail playback mode (default setting). For the self-collage function, a collage image is used as the key picture.

To display each image in the sequence individually, tap .

After tapping , the operations listed below are available.



- To display the previous or next image, drag the image to the left or right.
- To display images that are not included in the sequence, tap  to return to the key picture display.
- To display images in a sequence as thumbnails, or to play them back in a slide show, set **Sequence display options** to **Individual pictures** in the playback menu (114).



Sequence Display Options

Images captured continuously with cameras other than this camera cannot be displayed as a sequence.

Playback Menu Options Available When Using Sequence

- When images in a sequence are displayed in full-frame playback mode, tap  to select functions in playback menu (109).
- If you tap  when a key picture is displayed, the following settings can be applied to all images in the sequence:
 - Favorite pictures, Mark for Wi-Fi upload, Protect, Copy

Deleting Images in a Sequence

When you tap  to display the menu screen and select **Delete** for images in a sequence, the images that are deleted vary depending on how the sequences are displayed.

- When the key picture is displayed:
 - **Current image:** All images in the displayed sequence are deleted.
 - **Select images:** When a key picture is selected on the erase selected images screen (21), all images in that sequence are deleted.
 - **All images:** All images on the memory card or in the internal memory are deleted.
- When images in a sequence are displayed in full-frame playback mode:
 - **Current image:** The image currently displayed is deleted.
 - **Select images:** Images that are selected in the sequence are deleted.
 - **Entire sequence:** All images in the displayed sequence are deleted.

Editing Images (Still Images)

Before Editing Images

You can easily edit images on this camera. Edited copies are saved as separate files.

Edited copies are saved with the same shooting date and time as the original.

Restrictions on Image Editing

- An image can be edited up to 10 times. A still image that was extracted from a movie can be edited up to 9 times.
- You may not be able to edit images of a certain size or with certain editing functions.

Quick Effects: Changing Hue or Mood

Quick effects type	Description
Pop/Super vivid	Mainly enhances the color saturation and applies effects.
Painting/High key/Toy camera effect 1/Toy camera effect 2/Low key/Cross process (red)/Cross process (yellow)/Cross process (green)/Cross process (blue)	Mainly adjusts hue and creates a different look for the image.
Photo illustration/Soft/Soft portrait/Portrait (color + B&W)/Fisheye/Cross screen/Miniature effect	Processes images with a variety of effects.
High-contrast monochrome/Sepia/Cyanotype/Selective color	Turns multicolor images into single color images. Selective color transforms all colors, except a specified color, to black and white.

- 1 Display the image to which you want to apply an effect in full-frame playback mode, and tap .



- 2** Tap to select the desired effect, and tap **OK**.
- Move the zoom control (📖1) toward **T** (🔍) to switch to full-frame playback or **W** (🗉) to switch to thumbnail playback.
 - If you tap **OK** in full-frame playback, proceed to step 4.

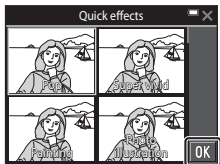

- 3** Check the effect preview, and tap **OK**.
- To exit without saving the edited image, tap **X**.

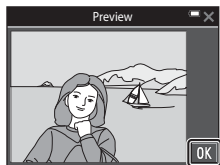

- 4** Tap **Yes**.
- An edited copy is created.

Quick Retouch: Enhancing Contrast and Saturation

Enter playback mode → select an image → tap **MENU** → **Quick retouch**

- 1** Tap to select the amount of effect, and tap **OK**.

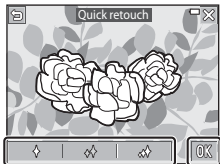

- 2** Tap **Yes**.
- An edited copy is created.

D-Lighting: Enhancing Brightness and Contrast

Enter playback mode → select an image → tap **MENU** →  D-Lighting

1 Tap **OK**.

- The edited version is displayed on the right.

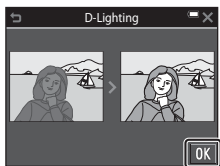

2 Tap **Yes**.

- An edited copy is created.

Red-eye Correction: Correcting Red-eye When Shooting with the Flash

Enter playback mode → select an image → tap **MENU** →  Red-eye correction

1 Tap **OK**.

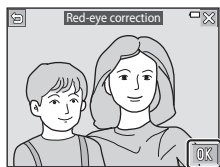

2 Tap **Yes**.



- An edited copy is created.

Notes About Red-eye Correction

- Red-eye correction can only be applied to images when red-eye is detected.
- Red-eye correction can be applied to pets (dogs or cats) even if their eyes are not red.
- Red-eye correction may not produce the desired results in some images.
- In rare cases, red-eye correction may be applied unnecessarily to other areas of the image.

Glamour Retouch: Enhancing Human Faces

Enter playback mode → select an image → tap **MENU** →  Glamour retouch

- 1 Tap  or  to select the face that you want to retouch, and then tap **OK**.

- Borders are displayed around the skin, eyes and mouth.
- When only one face is detected, proceed to step 2.

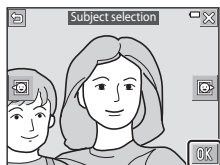

- 2 Tap the part that you want to retouch.

- An editing screen is displayed for the selected part of the face.
- To return to the screen for selecting a person, tap .

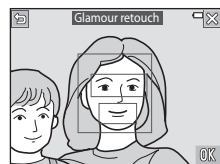

- 3 Apply an effect.

- Tap an icon to select an effect.
- Tap or drag the slider to adjust the amount of effect.
- You can simultaneously apply multiple effects.

Skin:  **Small face**,  **Skin softening**,  **Powder**,  **Glare reduction**,  **Redden cheeks**

Eyes:  **Hide eye bags**,  **Big eyes**,  **Whiten eyes**,  **Eye shadow**,  **Mascara**

Mouth:  **Whiten teeth**,  **Lipstick**

To edit a different part, tap **OK** and select a part again on the screen in step 2.

- Tap **OK** after checking all effects.

Effect

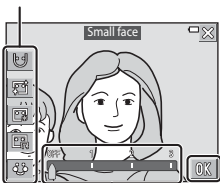

Slider

4 Tap **OK**.

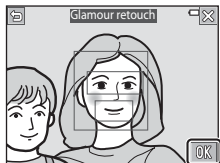

5 Preview the result, and tap **OK**.

- To change the settings, tap ↶ to return to step 2.
- To exit without saving the edited image, tap ✕.

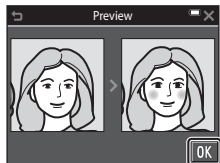

6 Tap **Yes**.

- An edited copy is created.

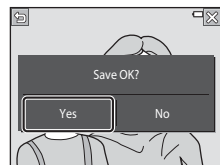







✓ **Notes About Glamour Retouch**

- Only one face at a time can be edited using the glamour retouch function.
- Depending on the direction in which faces are looking, or the brightness of faces, the camera may be unable to accurately detect faces, or the glamour retouch function may not perform as expected.
- If no faces are detected, a warning is displayed and the screen returns to the playback menu.
- The glamour retouch function is available only for images captured at an ISO sensitivity of 1600 or lower, and the image size of 640 × 480 or larger.

Paint: (Writing and Drawing on Images)

Enter playback mode → select an image → tap **MENU** →  Paint

1 Use the , , , and tools to paint images.

- See [74](#) for details on how to use the paint tools.
- You can zoom in on images by moving the zoom control toward **T** (). Tap    to scroll to the portion of the image that you want to display. Move the zoom control toward **W** () to return to the original screen size.
- You can undo the previous operation by tapping  (up to five times).

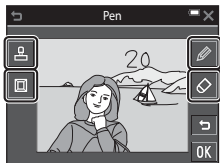

2 Tap **OK**.

- To exit without saving the edited image, tap **X**.

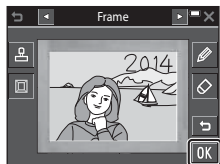



3 Tap **Yes**.

- An edited copy is created.
- Images are saved at the sizes described below.
 - Images captured with **4M 2272x1704** or more: 2272 × 1704
 - Images captured with **2M 1600x1200** or less: 640 × 480
 - Images captured with **16:9 12M 4608x2592**: 1920 × 1080
 - Images captured with **15:1 12M 3456x3456**: 1080 × 1080

Using the Paint Tools

Write and Draw on Images

You can write and draw on images by tapping . To close the palette, tap  or the image.

- Tap or drag the slider (①) to select pen color.
- Tap the slider (②) to select pen thickness.

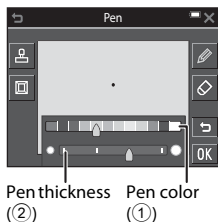

Pen thickness (②) Pen color (①)

Erase Paint Tool Additions

You can tap  to delete anything added to the images using the paint tools.

To close the palette, tap  or the image.

- Tap the slider to select an eraser size.

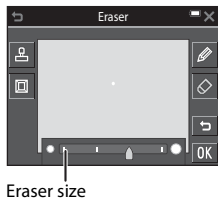

Eraser size

Add Decorations

You can add a decoration by tapping .

To close the palette, tap  or the image.

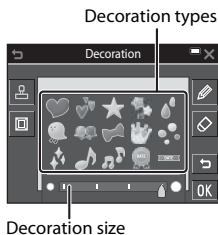

- You can select from 15 types of decorations.
- Tap the slider to select a decoration size.



Decoration types
Decoration size

Add a Frame

You can add a frame to the image by tapping .

- Tap   to display each of the nine different frames.

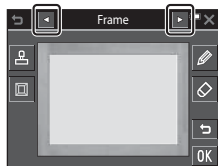

✓ Notes About the Shooting Date Decoration

- The date format is the same as the one specified for **Date format** in **Time zone and date** (📖126) in the setup menu.
- The shooting date decoration uses the date that is set in the camera at the time of shooting. The date for the shooting date decoration cannot be changed.
- The date may be difficult to read if the image size is small.

Stretch: Stretching Images

Enter playback mode → select an image → tap **MENU** →  Stretch

- 1** Tap or drag the slider to adjust the stretch effect.

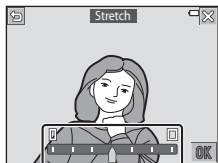

- 2** Tap **OK**.

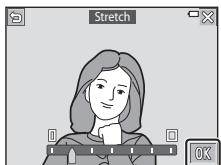

- 3** Tap **Yes**.
 - An edited copy is created.

Perspective Control: Adjusting the Sense of Perspective

Enter playback mode → select an image → tap **MENU** →  Perspective control

- 1 Tap or drag the slider to adjust the perspective.

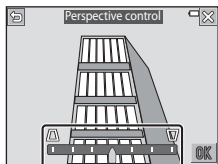

- 2 Tap **OK**.

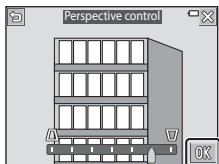

- 3 Tap **Yes**.

- An edited copy is created.

Selective Softening: Blurring the Background







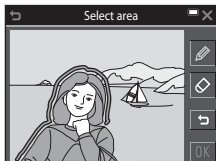

Enter playback mode → select an image → tap **MENU** →  Selective softening

1 Use  to draw a border line around the area that you do not want to blur.

- When the border line is connected at the start and end points, the area is recognized as a selection area. The inside of the selection area is displayed in color, and the outside is blurred.
- A selection area cannot be specified if the line is not properly connected or if the specified area is too narrow. Draw the border line again.





2 Adjust the selection area.

- Tap  to make an additional selection area.
- Tap  to erase a selection area.
- Tap  to undo the previous action (up to five times).
- You can zoom in on images by moving the zoom control toward **T** (). Tap     to scroll to the portion of the image that you want to display. Move the zoom control toward **W** () to return to the original screen size.
- When you finish making adjustments, tap **OK**.



3 Tap or drag the slider to select the amount of effect, and tap **OK**.

- Tap  to undo the selection area.
- To exit without saving the edited image, tap .

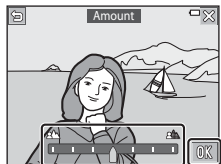

4 Tap **Yes**.

- An edited copy is created.

Small Picture: Reducing the Size of an Image

Enter playback mode → select an image → tap **MENU** →  Small picture

1 Tap to select the desired copy size, and tap **OK**.

- Images captured at an image mode setting of **HS 4608×2592** are saved at a size of 640 × 360, and images captured at an image mode setting of **FSM 3456×3456** are saved at 480 × 480. Tap **OK** to proceed to step 2.

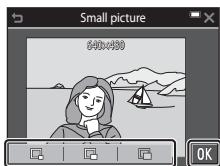

2 Tap **Yes**.

- An edited copy is created (compression ratio of approximately 1:8).

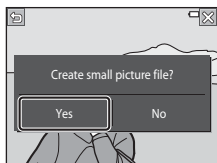

Crop: Creating a Cropped Copy

1 Enlarge the image that you want to crop (📖58).

2 Adjust the image so that only the portion that you want to keep is displayed, and then tap ✂️.

- Move the zoom control or spread/pinch your fingers to adjust the magnification rate. Set a magnification rate at which ✂️ is displayed.
- Drag the image to scroll to the portion of the image that you want to display.



3 Confirm the area that you want to keep, and tap OK.



4 Tap Yes.

- An edited copy is created.



Image Size

- The aspect ratio (horizontal and vertical ratio) of a cropped image is the same as that of the original image.
- When the original image was captured in “tall” orientation, the cropped image is also created in “tall” orientation.

Recording and Playing Back Movies

1 Display the shooting screen.

- Check the remaining amount of movie recording time.

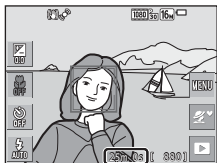

Remaining movie recording time

2 Press the ● (movie-record) button to start movie recording.

- The camera focuses in the center of the frame.
- Tap **II** to pause recording, and tap **REC** to resume recording (except when **iFrame 720/30p**, **iFrame 720/25p** or an HS movie option is selected in **Movie options**). Recording automatically ends if it remains paused for about five minutes.
- You can capture a still image by pressing the shutter-release button while recording a movie (83).

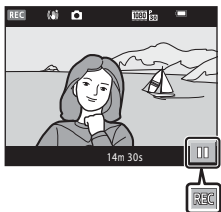
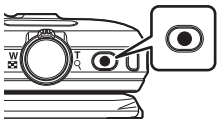

3 Press the ● (movie-record) button again to end recording.

4 Select a movie in full-frame playback mode, and tap ▶ to play it back.

- An image with a movie options icon is a movie.

Movie options

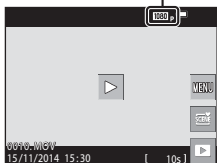

Area Captured in Movies

- The area that is captured in a movie varies depending on the **Movie options** settings in the movie menu.
- If **Photo info** in **Monitor settings** (📖128) in the setup menu is set to **Movie frame+auto info**, you can confirm the area that will be captured in a movie before you start recording.

Maximum Movie Recording Time

Individual movie files cannot exceed 4 GB in size or 29 minutes in length, even when there is sufficient free space on the memory card for longer recording.

- The remaining recording time for a single movie is displayed on the shooting screen.
- The actual remaining recording time may vary depending on the movie content, subject movement, or type of memory card.
- Memory cards with an SD Speed Class rating of 6 or faster are recommended when recording movies (📖177). Movie recording may stop unexpectedly when memory cards with a lower Speed Class rating are used.

Notes About Camera Temperature

- The camera may become hot when shooting movies for an extended period of time or when the camera is used in a hot area.
- If the inside of the camera becomes extremely hot when recording movies, the camera will automatically stop recording.

The amount of time remaining until the camera stops recording (🕒10s) is displayed.

After the camera stops recording, it turns itself off.

Leave the camera off until the inside of the camera has cooled.

Notes About Movie Recording

✓ Notes About Saving Images or Movies

The indicator showing the number of exposures remaining or the indicator showing the remaining recording time flashes while images or movies are being saved. **Do not open the battery-chamber/memory card slot cover or remove the battery or memory card** while an indicator is flashing. Doing this could result in loss of data, or in damage to the camera or the memory card.

✓ Notes About Recorded Movies

- There may be some degradation in image quality when digital zoom is used.
- The sounds of zoom control operation, zoom, autofocus lens drive movement, movie vibration reduction, and aperture operation when brightness changes may be recorded.
- The following phenomena may be seen in the monitor while recording movies. These phenomena are saved in the recorded movies.
 - Banding may occur in images under fluorescent, mercury-vapor, or sodium-vapor lighting.
 - Subjects that move quickly from one side of the frame to the other, such as a moving train or car, may appear skewed.
 - The entire movie image may be skewed when the camera is panned.
 - Lighting or other bright areas may leave residual images when the camera is moved.
- Depending on the distance to the subject or the amount of zoom applied, colored stripes may appear on subjects with repeating patterns (fabrics, lattice windows, etc.) during movie recording and playback. This occurs when the pattern in the subject and the layout of the image sensor interfere with each other; it is not a malfunction.

✓ Notes About Vibration Reduction During Movie Recording

- When **Movie VR** (📖121) in the movie menu is set to **On (hybrid)**, the angle of view (i.e., the area visible in the frame) becomes narrower during movie recording.
- When using a tripod to stabilize the camera during shooting, set **Movie VR** to **Off** to prevent potential errors caused by this function.



✓ Notes About Autofocus for Movie Recording

Autofocus may not perform as expected (📖53). Should this occur, try the following:

1. Set **Autofocus mode** in the movie menu to **Single AF** (default setting) before starting movie recording.
2. Frame another subject (positioned at the same distance from the camera as the intended subject) in the center of the frame, press the ● (movie-record) button to start recording, and modify the composition.



Capturing Still Images While Recording Movies

If the shutter-release button is pressed all the way while recording a movie, one frame is saved as a still image. Movie recording continues while the still image is being saved.

- While  is displayed in the monitor, still images can be captured. While  is displayed, still images cannot be captured.
- The size of the captured image varies depending on the **Movie options** setting (116).



Notes About Capturing Still Images During Movie Recording

- Still images cannot be captured during a movie recording in the following situations:
 - When the remaining movie recording time is less than 30 seconds
 - When **Movie options** is set to  **1080/60i**,  **1080/50i** or HS movie
- The frames of a movie that were recorded when a still image was being captured may not play back smoothly.
- The sound of pressing the shutter-release button may be recorded in the movie.
- If the camera moves when the shutter-release button is pressed, the image may be blurred.

Operations During Movie Playback

Playback controls are displayed in the monitor.

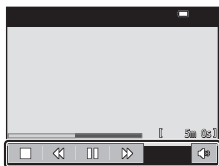

When playing back



When paused

You can tap the icons for operations described below.

Function	Icon	Description
Volume		Adjusts the volume. You can also move the zoom control (1) to adjust the volume.
Rewind		Touch and hold to rewind the movie.
Advance		Touch and hold to advance the movie.
Pause		Pause playback. The operations listed below can be performed while paused.
		Rewind the movie one frame. Touch and hold for continuous rewinding.
		Advance the movie one frame. Touch and hold for continuous advancing.
		Resume playback.
		Extract the desired portion of a movie and save it as a separate file.
Extract one frame from a recorded movie and save it as a still image.		
End		Return to full-frame playback mode.

Editing Movies

Extracting and Saving the Desired Portion of a Recorded Movie



The desired portion of a recorded movie can be saved as a separate file.

- 1 Play back a movie and pause at the start point of the portion that you want to extract (📖84).

- 2 Tap  in the playback controls.







- 3 Tap  (choose start point) in the editing controls.

- Tap   to move the start point.
- To cancel editing, tap .



- 4 Tap  (choose end point).

- Tap   to move the end point.
- To preview the specified portion, tap . Playback controls are displayed while previewing. Tap  to stop previewing.



- 5 Tap .

- Follow the instructions on the screen to save the movie.



Notes About Movie Editing

- Movies recorded using **iFrame 720/30p** or **iFrame 720/25p** (116) cannot be edited.
- Use a sufficiently charged battery to prevent the camera from turning off during editing. When the battery level indicator is , movie editing is not possible.
- A movie that was created by editing cannot be trimmed again.
- The actual trimmed portion of a movie may differ slightly from the portion selected using the start and end points.
- Movies cannot be trimmed so that they are less than two seconds long.

Saving One Frame of a Movie as a Still Image

One frame of a recorded movie can be extracted and saved as a still image.

- Pause movie playback to display the screen that you want to extract (84).
- Tap  in the playback controls.
- Tap **Yes** on the confirmation dialog to save the image.
- The image size of a saved image varies depending on the original movie type (image size).

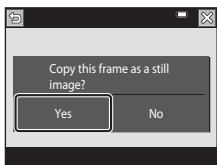









Notes About Saving Still Images

Still images cannot be saved from movies recorded at **1080i/60i** **1080/60i** or **1080i/50i** **1080/50i** (116).

Using Menus

You can set the menus listed below by tapping the  (menu) icon.

-  **Shooting menu**
Available by tapping  when the shooting screen is displayed.
Allows you to change image size and quality, continuous shooting settings, etc.
-  **Playback menu**
Available by tapping  when viewing images in full-frame playback mode or thumbnail playback mode.
Allows you to edit images, play slide shows, etc.
-  **Movie menu**
Available by tapping  when the shooting screen is displayed.
Allows you to change movie recording settings.
-  **Wi-Fi options menu**
Allows you to configure Wi-Fi settings for connecting the camera and a smart device.
-  **Setup menu**
Allows you to adjust basic camera functions such as date and time, display language, etc.

1 Tap the (menu) icon.

- The menu is displayed.

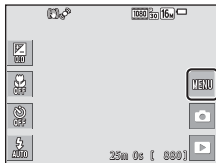

2 Tap a menu icon.

- The menu options become selectable.

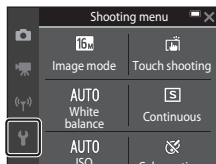

3 Tap a menu option.

- Certain menu options cannot be set depending on the current shooting mode or the state of the camera.

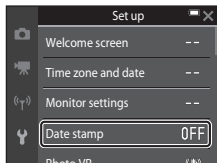

4 Tap a setting.

- The setting you selected is applied.
- When you are finished using the menu, tap **X**.
- When a menu is displayed, you can switch to shooting mode by pressing the shutter-release button.

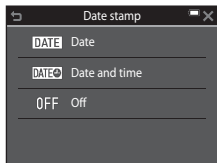

The Shooting Menu (for (Auto) Mode)









Image Mode (Image Size and Quality)

Enter shooting mode* → tap  → Image mode

* This setting can also be changed in shooting modes other than auto. The changed setting is also applied to other shooting modes.

Select the combination of image size and compression ratio to be used when saving images.

The higher the image mode setting, the larger the size at which it can be printed, and the lower the compression ratio, the higher the quality of the images, but the number of images that can be saved is reduced.

Option*	Compression ratio	Aspect ratio (horizontal to vertical)
 4608×3456★	Approx. 1:4	4:3
 4608×3456 (default setting)	Approx. 1:8	4:3
 3264×2448	Approx. 1:8	4:3
 2272×1704	Approx. 1:8	4:3
 1600×1200	Approx. 1:8	4:3
 640×480	Approx. 1:8	4:3
 4608×2592	Approx. 1:8	16:9
 3456×3456	Approx. 1:8	1:1

* The numerical values indicate the number of pixels that are captured.
Example:  **4608×3456** = approx. 16 megapixels, 4608 × 3456 pixels

Notes About Printing Images at 1:1 Aspect Ratio

Change the printer setting to "Border" when printing images at a 1:1 aspect ratio. Some printers may not be able to print images at a 1:1 aspect ratio.

Notes About Image Mode



This function may not be available to use in combination with other functions (55).

Number of Images That Can Be Saved

- The approximate number of images that can be saved can be checked in the monitor when shooting (14).
- Note that due to JPEG compression, the number of images that can be saved may vary greatly depending on the image content, even when using memory cards with the same capacity and the same image mode setting. In addition, the number of images that can be saved may vary depending on the make of the memory card.
- If the number of exposures remaining is 10,000 or more, the number of exposures remaining display shows "9999".

Touch Shooting

The options described below are available.



Option	Description	
 Touch shutter (default setting)	Images can be captured by simply tapping the monitor.	92
 Touch AF	Tap the monitor to set the focus area. Press the shutter-release button to take a picture with the focus and exposure set for the focus area.	93

- The setting is fixed at **Touch shutter** when in glamour mode.

Focus Area That Can Be Set with Touch Shutter or Touch AF



- The focus area that can be set by tapping the monitor when using **Touch shutter** or **Touch AF** varies depending on the shooting mode.
- The focus area cannot be changed with certain scene modes.
- Tap only the border displayed when a human or pet face is detected. When multiple faces are detected, tap a face displayed inside a single border to change the focus area.

Tapping the Monitor to Release the Shutter (Touch Shutter)

Enter shooting mode* → tap  → Touch shooting →  Touch shutter → tap 



* This setting can also be changed in shooting modes other than auto. The changed setting is also applied to other shooting modes.

Tap the desired subject to take a picture.

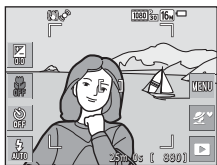
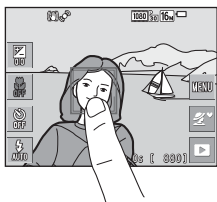

- Do not use force when tapping the monitor as this may cause slight movement of the camera, resulting in blurred images.
- When digital zoom is in effect, the camera focuses on the subject in the center of the frame.
- The shutter-release button can also be used when the touch shutter option is selected.
- If  is displayed when the monitor is tapped, the shutter cannot be released. Tap an area within .



Notes About Touch Shutter



- The focus area that can be set varies depending on the shooting mode (91).
- When a subject displayed in the monitor is tapped after the self-timer (45) is set, the camera locks focus and releases the shutter after 10 or 2 seconds.
- This function may not be available to use in combination with other functions (55).

AF Tapping the Monitor to Focus (Touch AF)

Enter shooting mode* → tap  → Touch shooting →  AF Touch AF → tap 

* This setting can also be changed in shooting modes other than auto. The changed setting is also applied to other shooting modes.

1 Tap the subject on which to focus.

- The focus area is displayed around the area that is tapped.
- When digital zoom is in effect, the focus area cannot be selected.
- To cancel the focus area selection, tap  in the monitor.
- When an area on which focus cannot be acquired is tapped,  is displayed in the monitor. Tap an area within .

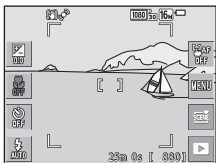
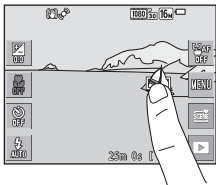

2 Press the shutter-release button to take a picture.



- Press the shutter-release button halfway to lock the focus and exposure, and press it all the way down to release the shutter.







Notes About Touch AF

The focus area that can be set varies depending on the shooting mode ( 91).

White Balance (Adjusting Hue)

Enter shooting mode → tap the shooting mode icon →  (auto) mode
→ tap  → White balance

Adjust white balance to suit the light source or weather conditions in order to make the colors in images match what you see with your eyes.

Option	Description
AUTO Auto (default setting)	White balance is automatically adjusted.
PRE Preset manual	Use when the desired result is not achieved with Auto , Incandes. , etc. (📖95).
 Daylight	Use under direct sunlight.
 Incandes.	Use under incandescent lighting.
 Fluorescent	Use under fluorescent lighting.
 Cloudy	Use under overcast skies.
 Flash	Use with the flash.

Notes About White Balance

- Set the flash to  (off) when white balance is set to any setting other than **Auto** and **Flash** (📖43).
- This function may not be available to use in combination with other functions (📖55).

Using Preset Manual

Use the procedure below to measure the white balance value under the lighting used during shooting.

1 Place a white or gray reference object under the lighting that will be used during shooting.

2 Tap to select **Preset manual** in the **White balance** and tap **OK**.

- The camera zooms in to the position for measuring white balance.

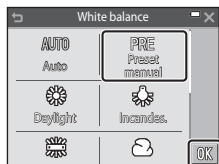

3 Frame the white or gray reference object in the measuring window.

- To apply the last measured value, tap **Cancel**.

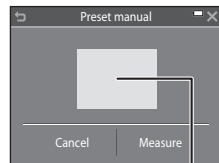

Measuring window

4 Tap **Measure** to start measuring.

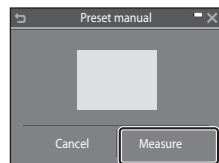

- The shutter is released and measurement is complete (no image is saved).















✓ Notes About Preset Manual

A value for flash lighting cannot be measured with **Preset manual**. When shooting using the flash, set **White balance** to **Auto** or **Flash**.

Continuous Shooting

Enter shooting mode → tap the shooting mode icon →  (auto) mode
→ tap  → Continuous

Option	Description
 Single (default setting)	One image is captured each time the shutter-release button is pressed.
 Continuous H	While the shutter-release button is held all the way down, images are captured continuously. <ul style="list-style-type: none">• The frame rate for continuous shooting is about 9 fps and the maximum number of continuous shots is about 7 (when image mode is set to  4608×3456).
 Continuous L	While the shutter-release button is held all the way down, images are captured continuously. <ul style="list-style-type: none">• The frame rate for continuous shooting is about 2 fps and the maximum number of continuous shots is about 7 (when image mode is set to  4608×3456).
 Pre-shooting cache	When the shutter-release button is pressed halfway, pre-shooting cache shooting begins. When the shutter-release button is pressed the rest of the way down, the camera saves the current image as well as the images captured immediately before the button is pressed ( 98). This function helps you to avoid missing the shot. <ul style="list-style-type: none">• The frame rate for continuous shooting is about 12 fps and the maximum number of continuous shots is 5, including a maximum of 2 frames captured in the pre-shooting cache (when image mode is set to  4608×3456).
 120 Continuous H: 120 fps	Each time the shutter-release button is pressed all the way, images are captured at a high speed rate. <ul style="list-style-type: none">• The frame rate for continuous shooting is about 120 fps and the maximum number of continuous shots is 50.• Image mode is fixed at  (image size: 640 × 480 pixels).
 60 Continuous H: 60 fps	Each time the shutter-release button is pressed all the way, images are captured at a high speed rate. <ul style="list-style-type: none">• The frame rate for continuous shooting is about 60 fps and the maximum number of continuous shots is 25.• Image mode is fixed at  (image size: 1280 × 960 pixels).

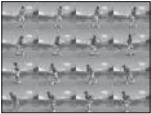
Option	Description
BSS BSS (Best Shot Selector)	While the shutter-release button is held all the way down, the camera captures a series of up to 10 images and automatically saves the sharpest image. Use when shooting a stationary subject in a place where flash photography is prohibited and camera shake is likely to occur.
 Multi-shot 16	Each time the shutter-release button is pressed all the way down, the camera captures a series of 16 images and saves it as a single image.  <ul style="list-style-type: none"> • The frame rate for continuous shooting is about 30 fps. • Image mode is fixed at 5M (image size: 2560 × 1920 pixels).

Notes About Continuous Shooting

- Focus, exposure, and white balance are fixed at the values determined with the first image in each series.
- It may take some time to save the images after shooting.
- When ISO sensitivity increases, noise may appear in captured images.
- The frame rate for continuous shooting may vary depending on the current image mode setting, the memory card used, or shooting condition.
- When using **Pre-shooting cache**, **Continuous H: 120 fps**, **Continuous H: 60 fps**, or **Multi-shot 16**, banding or variance in brightness or hue may occur in images that were captured under lighting that flickers at high speeds, such as fluorescent, mercury-vapor, or sodium-vapor lighting.
- This function may not be available to use in combination with other functions (📖55).

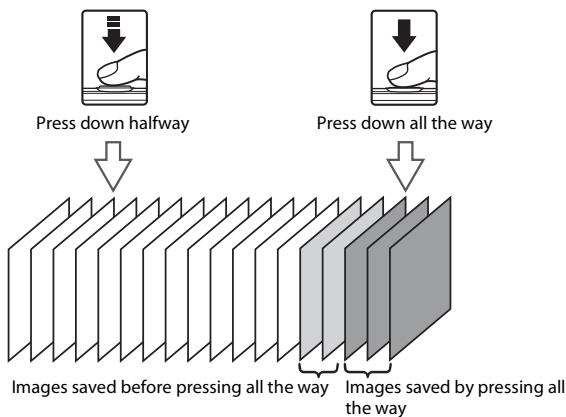

Pre-shooting Cache

When the shutter-release button is pressed halfway or all the way down, images are saved as described below.



- The pre-shooting cache icon () on the shooting screen changes to green while the shutter-release button is pressed halfway.

ISO Sensitivity

Enter shooting mode → tap the shooting mode icon →  (auto) mode
→ tap  → ISO sensitivity

A higher ISO sensitivity allows darker subjects to be captured. Additionally, even with subjects of similar brightness, pictures can be taken at faster shutter speeds, and blurring caused by camera shake and subject movement can be reduced.

- When a higher ISO sensitivity is set, images may contain noise.

Option	Description
AUTO Auto (default setting)	Sensitivity is automatically selected from the range of ISO 125 to 1600.
Fixed range auto	Select the range in which the camera automatically adjusts ISO sensitivity, from ISO 125-400 or ISO 125-800 .
125, 200, 400, 800, 1600, 3200, 6400	Sensitivity is locked at the specified value.



Notes About ISO Sensitivity

This function may not be available to use in combination with other functions (☞55).





ISO Sensitivity Display on the Shooting Screen

- When **Auto** is selected, **ISO** is displayed when the ISO sensitivity increases.
- When **Fixed range auto** is selected, the maximum value for ISO sensitivity is displayed.

Color Options

Enter shooting mode → tap the shooting mode icon →  (auto) mode
→ tap  → Color options



Select the color tone to use when taking pictures.

Option	Description
 Standard color (default setting)	Use for images exhibiting natural color.
 Vivid color	Use to achieve a vivid, "photoprint" effect.
 Black-and-white	Save images in black-and-white.
 Sepia	Save images in sepia tones.
 Cyanotype	Save images in cyan-blue monochrome.



Notes About Color Options



This function may not be available to use in combination with other functions (55).

AF Area Mode

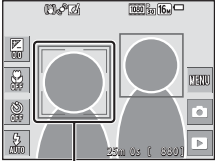
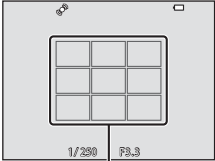
Enter shooting mode → tap the shooting mode icon →  (auto) mode
→ tap  → AF area mode

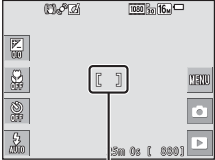
Set how the camera selects the focus area for autofocus.

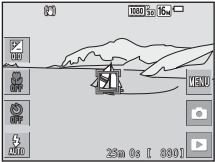
Option	Description
 Face priority	<p>When the camera detects a human face, it focuses on that face. See “Using Face Detection” (📖50) for more information.</p>  <p>Focus area</p> <p>When framing a composition with no human subjects or detected faces, the camera automatically selects one or more of the nine focus areas containing the subject closest to the camera when the shutter-release button is pressed halfway.</p>  <p>Focus areas</p>
 Center	<p>The camera focuses on the subject in the center of the frame.</p>  <p>Focus area</p>

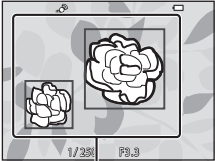
Option	Description
 Subject tracking	<p>Use this function to take pictures of moving subjects. Register the subject on which the camera focuses. The focus area automatically moves to track the subject. See “Using Subject Tracking” (103) for more information.</p> 
 Target finding AF (default setting)	<p>When the camera detects the main subject, it focuses on that subject. See “Using Target Finding AF” (52) for more information.</p>  <p style="text-align: center;">Focus areas</p>

Notes About AF Area Mode

- When digital zoom is in effect, the camera focuses in the center of the frame regardless of the **AF area mode** setting.
- This function may not be available to use in combination with other functions (55).

Using Subject Tracking

Enter shooting mode → tap the shooting mode icon → (auto) mode
→ tap → AF area mode → Subject tracking → tap

1 Register a subject.

- Tap the subject that you want to track.
- When the subject is registered, a yellow border (focus area) is displayed around it and the camera begins tracking the subject.
- If the subject cannot be registered, the border is displayed in red. Change the composition and try registering the subject again.
- If the tapped area does not contain a subject that can be registered, is displayed in the monitor. Tap an area within .
- Tap another subject to change the target.
- To cancel subject registration, tap in the monitor.
- If the camera can no longer track the registered subject, the focus area disappears. Register the subject again.

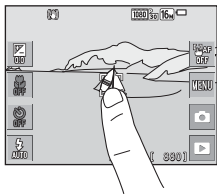

2 Press the shutter-release button fully to take the picture.

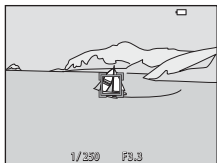

- If the shutter-release button is pressed while the focus area is not displayed, the camera focuses on the subject in the center of the frame.



Notes About Subject Tracking

- If you perform operations such as zooming while the camera is tracking the subject, the registration is canceled.
- Subject tracking may not be possible in certain shooting conditions.

Autofocus Mode

Enter shooting mode → tap the shooting mode icon →  (auto) mode
→ tap  → Autofocus mode



Set how the camera focuses when shooting still images.





Option	Description
AF-S Single AF (default setting)	The camera focuses only when the shutter-release button is pressed halfway.
AF-F Full-time AF	The camera continues focusing even when the shutter-release button is not pressed halfway. The sound of lens drive movement is heard while the camera focuses.

Autofocus Mode for Movie Recording

Autofocus mode for movie recording can be set with **Autofocus mode** ( 120) in the movie menu.

Quick Effects

Enter shooting mode → tap the shooting mode icon →  (auto) mode
→ tap  → Quick effects

Option	Description
 On (default setting)	In  (auto) mode, tap  immediately after releasing the shutter to display the effect selection screen and use the quick effects function ( 40).
OFF Off	Disables the quick effects function (during shooting).

Notes About Quick Effects

This function may not be available to use in combination with other functions ( 55).

The Smart Portrait Menu

- See “Image Mode (Image Size and Quality)” (📖89) for information about **Image mode**.
- See “Touch Shooting” (📖91) for information about **Touch shooting**.



Skin Softening

Enter shooting mode → tap the shooting mode icon → 📷 Smart portrait mode → tap **MENU** → Skin softening



Option	Description
📷 ↕ High	When the shutter is released, the camera detects one or more human faces (up to three), and processes the image to soften facial skin tones before saving the image. You can select the amount of effect that is applied.
📷 ↕ Normal (default setting)	
📷 ↕ Low	
OFF Off	Turns skin softening off.

The skin softening results are not visible on the shooting screen. Play back the images to check the results after shooting.

Smile Timer

Enter shooting mode → tap the shooting mode icon →  Smart portrait mode → tap  → Smile timer



The camera detects human faces and then automatically releases the shutter whenever a smile is detected.

Option	Description
 On (single)	Whenever a smile is detected, the camera captures one image.
 On (continuous)	Whenever a smile is detected, the camera captures up to 5 images continuously and saves them all. The flash cannot be used.
 On (BSS) (default setting)	Whenever a smile is detected, the camera captures up to 5 images continuously and saves the image that best captured the smile. The flash cannot be used.
OFF Off	Turns the smile timer off.

Notes About Smile Timer

This function may not be available to use in combination with other functions (55).

Blink Proof

Enter shooting mode → tap the shooting mode icon →  Smart portrait mode → tap  → Blink proof

Option	Description
ON On	<p>The camera automatically releases the shutter twice with every shot and saves one image in which the subject's eyes are open.</p> <ul style="list-style-type: none">• If the camera saved an image in which the subject's eyes may have been closed, the dialog shown on the right is displayed for a few seconds.• The flash cannot be used.
OFF Off (default setting)	Turns the blink proof off.



Notes About Blink Proof

This function may not be available to use in combination with other functions (55).

The Glamour Mode Menu

- See “Image Mode (Image Size and Quality)” (📖89) for information about **Image mode**.
- See “Touch Shooting” (📖91) for information about **Touch shooting**.

Self-Collage



Enter shooting mode → tap the shooting mode icon → 📷 Glamour mode → tap **MENU** → Self-Collage

Option	Description
Number of shots	Set the number of shots that the camera automatically captures (number of captured images for an aggregated image). <ul style="list-style-type: none">• 4 (default setting) or 9 can be selected.
Interval	Set the interval time between each shot. <ul style="list-style-type: none">• Short, Medium (default setting), or Long can be selected.
Shutter sound	Set whether to activate the shutter sound when shooting with the self-collage function. <ul style="list-style-type: none">• Standard, SLR, Magic (default setting), or Off can be selected.• The same setting that is specified for Shutter sound in Sound settings in the setup menu is not applied to this setting.

The Playback Menu

- See “Delete Images” (📖20) for information about  **Delete**.
- See “Editing Images (Still Images)” (📖68) for information about image editing functions.
- See “Favorite Pictures Mode” (📖60) for information about **Favorite pictures** and **Remove from favorites**.

Mark for Wi-Fi Upload

Enter playback mode → select an image → tap  →  Mark for Wi-Fi upload

Select images in the camera that you want to transfer to a smart device in advance before transferring them.

On the image selection screen (📖115), select or deselect images for the **Mark for Wi-Fi upload** function.

Note that when you select **Reset all** (📖140) in the setup menu or **Restore default settings** (📖123) in the Wi-Fi options menu, the **Mark for Wi-Fi upload** settings that you made are canceled.

Slide Show

Enter playback mode → select an image → tap **MENU** →  Slide show



Play back images one by one in an automated “slide show.” When movie files are played back in the slide show, only the first frame of each movie is displayed.

1 Tap **Start**.

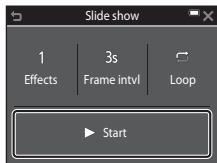
- The slide show begins.
- To select effects to apply to the slide show, tap **Effects** before tapping **Start**.
- To change the interval between images, tap **Frame intvl** and specify the desired interval time before tapping **Start**.
- To repeat the slide show automatically, tap **Loop** before tapping **Start**.
- The maximum playback time is up to about 30 minutes even if **Loop** is enabled.







2 End or restart the slide show.

- The screen shown on the right is displayed after the slide show ends or is paused. To exit the show, tap . To resume the slide show, tap .



Operations During Playback

You can tap icons in the playback controls for the operations described below.

Function	Icon	Description
Rewind		Touch and hold to rewind the slide show.
Advance		Touch and hold to advance the slide show.
Pause		Tap to pause the slide show. <ul style="list-style-type: none">• To resume playback, tap .
End		Tap to end the slide show.

Protect

Enter playback mode → select an image → tap **MENU** →  Protect

The camera protects selected images from accidental deletion. Select images to protect or cancel protection from the image selection screen (📖115).

Note that formatting the memory card or the camera's internal memory permanently deletes all data including protected files (📖135).

Rotate Image

Enter playback mode → select an image → tap **MENU** →  Rotate image

Specify the orientation in which saved images are displayed during playback. Still images can be rotated 90 degrees clockwise or 90 degrees counterclockwise.

Select an image from the image selection screen (📖115). When the Rotate image screen is displayed, tap  or  to rotate the image 90 degrees.



Rotate 90 degrees
counterclockwise

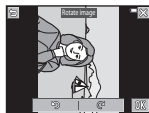

Rotate 90 degrees
clockwise





Tap **OK** to finalize display orientation, and save orientation information with the image.

Voice Memo

Enter playback mode → select an image → tap **MENU** → **Voice memo**

Voice memos can be recorded and attached to images.

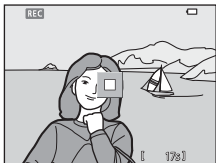

Recording Voice Memos

- Tap  to record up to about 20 seconds.
- Tap  during recording, recording stops.
- Do not touch the microphone.
- During recording, **REC** flashes in the monitor.
- The voice memo playback screen is displayed after recording ends. Tap  to play back the voice memo.
- Delete the current voice memo before recording a new voice memo.
-  is displayed for images with a voice memo when in full-frame playback mode.



Playing Voice Memos

Select an image with  displayed before tapping **MENU**.

- Tap  to play the voice memo. Tap  to stop playback.
- Tap  during playback to adjust playback volume.



Deleting Voice Memos



Tap  while the voice memo playback screen is displayed.

When the confirmation dialog is displayed, tap **Yes**.

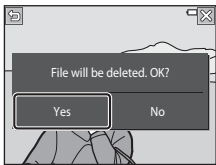
- To delete a voice memo for a protected image, the **Protect** setting must first be disabled.



Copy (Copy Between the Memory Card and Internal Memory)

Enter playback mode → select an image → tap  →  Copy

Images can be copied between a memory card and the internal memory.

- When a memory card that contains no images is inserted and the camera is switched to playback mode, **Memory contains no images.** is displayed. In that case, tap  to select **Copy**.

- 1 Tap a destination option to which images are copied.

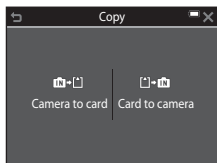

- 2 Tap a copy option.

- When you choose **Selected images**, use the image selection screen to specify images (115).

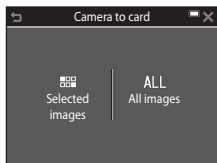

Notes About Copying Images



- Only files in formats that this camera can record can be copied.
- Operation is not guaranteed with images captured with another make of camera or that have been modified on a computer.
- Copied images or movies cannot be displayed in auto sort mode (64).
- If you copy images that have been added to albums, they are not added to albums on the memory card or in the internal memory that is selected as the destination.





Copying Images in a Sequence

- If you select a key picture of a sequence in **Selected images**, all images in the sequence are copied.
- If you tap  while images in a sequence are displayed, only the **Card to camera** copy option is available. All images in the sequence are copied if you select **Current sequence**.

Sequence Display Options



Enter playback mode → select an image → tap  →  Sequence display options

Select the method used to display images in the sequence (66).

Option	Description
 Individual pictures	Displays each image in a sequence individually.  is displayed on the playback screen.
 Key picture only (default setting)	Displays only the key picture for images in a sequence.

Settings are applied to all sequences, and the setting is saved in the camera's memory even if the camera is turned off.

Choose Key Picture

Enter playback mode → select an image → tap  →  Choose key picture

Specify a different image in the sequence as the key picture.



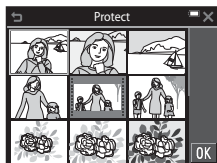

- When the key picture selection screen is displayed, select an image (115).

The Image Selection Screen

When an image selection screen such as the one shown on the right is displayed while operating the camera, follow the procedures described below to select the images.



1 Tap to select an image and add .

- Move the zoom control ( 1) toward **T** () to switch to full-frame playback or **W** () to switch to thumbnail playback.
- To undo the selection, tap the image again to remove .
- Tap to add  in the same manner when you want to select multiple images.
- Only one image can be selected for **Rotate image**, **Choose key picture**, and **Welcome screen**.



2 Tap **OK** to apply image selection.

- When a confirmation dialog is displayed, follow the on-screen instructions to operate.



The Movie Menu











Movie Options

Enter shooting mode → tap  →  menu icon → Movie options

Select the desired movie option to record. Select normal speed movie options to record at normal speed, or HS movie options (📖117) to record in slow or fast motion. The movie options that can be selected vary depending on the **Frame rate** setting (📖122).

- Memory cards with an SD Speed Class rating of 6 or faster are recommended for recording movies (📖177).

Normal Speed Movie Options

Option (Image size/Frame rate ¹ , File format)	Image size	Aspect ratio (horizontal to vertical)
 1080/30p ²  1080/25p ² (default setting)	1920 × 1080	16:9
 1080/60i ²  1080/50i ²	1920 × 1080	16:9
 720/30p ²  720/25p ²	1280 × 720	16:9
 iFrame 720/30p ^{2,3}  iFrame 720/25p ^{2,3}	1280 × 720	16:9
 480/30p  480/25p	640 × 480	4:3

¹ Interlaced format uses Fields per second.



² The setting is not available when using certain effects in special effects mode or glamour mode.

³ iFrame is a format supported by Apple Inc. iFrame files cannot be edited on this camera. When recording movies to the internal memory, recording may stop before the maximum recording time is reached.

HS Movie Options

Recorded movies are played back in fast or slow motion.

See “Recording Movies in Slow Motion and Fast Motion (HS Movie)” (📖119).

Option	Image size Aspect ratio (horizontal to vertical)	Description
 HS 480/4 ¹	640 × 480 4:3	1/4-speed slow motion movies <ul style="list-style-type: none"> • Max. recording time²: 10 seconds (playback time: 40 seconds)
 HS 720/2 ¹	1280 × 720 16:9	1/2-speed slow motion movies <ul style="list-style-type: none"> • Max. recording time²: 30 seconds (playback time: 1 minute)
 HS 1080/ 0.5 ¹	1920 × 1080 16:9	2× speed fast motion movies <ul style="list-style-type: none"> • Max. recording time²: 2 minutes (playback time: 1 minute)

¹ The setting is not available when using certain effects in special effects mode or glamour mode.

² While recording movies, the camera can be switched between normal speed movie recording and slow motion or fast motion movie recording. The maximum recording time shown here refers only to the portion of the movie that is recorded in slow motion or fast motion.

Notes About HS Movie

- Sound is not recorded.
- Zoom position and focus are locked when movie recording starts.

Playing Back in Slow Motion and Fast Motion

When recording at normal speed:



When recording at $\frac{480}{FPS}$ HS 480/4 \times ($\frac{480}{FPS}$ HS 480/4 \times):

Movies are recorded at 4 \times normal speed.

They are played back in slow motion at 4 \times slower speed.

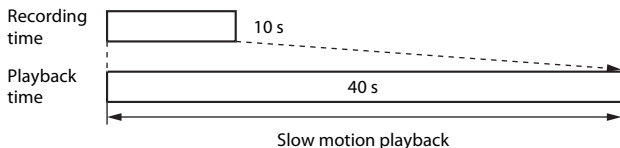



When recording at $\frac{1080}{FPS}$ HS 1080/0.5 \times ($\frac{1080}{FPS}$ HS 1080/0.5 \times):

Movies are recorded at 1/2 normal speed.

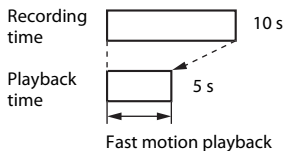
They are played back in fast motion at 2 \times faster speed.



Recording Movies in Slow Motion and Fast Motion (HS Movie)

Enter shooting mode → tap  →  menu icon → Movie options

Movies recorded using HS movie can be played back in slow motion at 1/4 or 1/2 of the normal playback speed, or in fast motion at twice the normal playback speed.

1 Tap an HS movie option (117).

- After applying the option, tap  to return to the shooting screen.

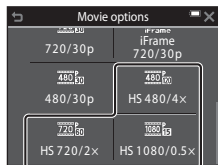

2 Press the (movie-record) button to start recording.

- The camera starts recording an HS movie when the **Open with HS footage** option in the movie menu is set to **On**, or a normal speed movie when it is set to **Off**.
- The camera switches between normal speed movie recording and HS movie recording each time the switch HS/HD icon is tapped.
- The movie options icon changes when switching between HS movie recording and normal speed movie recording.
- When the maximum recording time for HS movies (117) is reached, the camera automatically switches to normal speed movie recording.

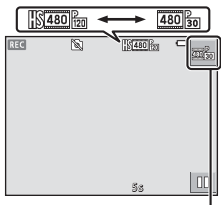

Switch HS/HD icon

3 Press the (movie-record) button to end recording.

Open with HS Footage

Enter shooting mode → tap  →  menu icon → Open with HS footage

Set whether to start recording HS movies or at normal speed when recording movies.

Option	Description
ON On (default setting)	Record HS movies when movie recording begins.
OFF Off	Record normal speed movies when movie recording begins.

Autofocus Mode

Enter shooting mode → tap  →  menu icon → Autofocus mode

Set how the camera focuses in movie mode.



Option	Description
AF-S Single AF (default setting)	Focus is locked when movie recording starts. Select this option when the distance between the camera and subject will remain fairly consistent during movie recording.
AF-F Full-time AF	The camera focuses continuously during movie recording. Select this option when the distance between the camera and subject will change significantly during recording. The sound of the camera focusing may be heard in the recorded movie. Use of Single AF is recommended to prevent the sound of the camera focusing from interfering with recording.

- When an HS movie option is selected in **Movie options**, the setting is fixed at **Single AF**.

Movie VR



Enter shooting mode → tap  →  menu icon → Movie VR

Select the vibration reduction setting used when recording movies.
Select **Off** when using a tripod to stabilize the camera during shooting.

Option	Description
 * On (hybrid) (default setting)	Performs optical compensation for camera shake using lens shift VR and simultaneously performs electronic VR using image processing. The angle of view (i.e., the area visible in the frame) becomes narrower.
 On	Performs compensation for camera shake using lens shift VR.
OFF Off	Compensation is not performed.

- When an HS movie option is selected in **Movie options**, the setting is fixed at **Off**.

Notes About Movie VR

- The effects of camera shake may not be completely eliminated in some situations.
- In special effects mode, only lens shift VR is used to compensate for camera shake when **Movie options** is set to  **1080/60i** or  **1080/50i**, even if **Movie VR** is set to **On (hybrid)**.

Wind Noise Reduction

Enter shooting mode → tap  →  menu icon → Wind noise reduction

Option	Description
 On	Reduces the sound that is produced when wind passes over the microphone during movie recording. Other sounds may become difficult to hear during playback.
OFF Off (default setting)	Wind noise reduction is disabled.

- When an HS movie option is selected in **Movie options**, the setting is fixed at **Off**.

Frame Rate

Enter shooting mode → tap  →  menu icon → Frame rate





Select the frame rate (fields per second for the interlaced format) used when recording movies. When the frame rate setting is switched, options that can be set in **Movie options** ( 116) change.

Option	Description
30fps 30 fps (30p/60i)	Suited for playback on a TV using the NTSC standard.
25fps 25 fps (25p/50i)	Suited for playback on a TV using the PAL standard.





The Wi-Fi Options Menu

Tap  →  menu icon

Configure the Wi-Fi (wireless LAN) settings to connect the camera and a smart device.

Option	Description
 Connect to smart device	Select when wirelessly connecting the camera and a smart device. See “Using the Wi-Fi (Wireless LAN) Function” (📖141) for more information.
 Upload from camera	Select when wirelessly connecting the camera and a smart device. See “Using the Wi-Fi (Wireless LAN) Function” (📖141) for more information. <ul style="list-style-type: none"> The images to transfer can be selected on the image selection screen before establishing a Wi-Fi connection (📖115). The SSID and password of the camera are displayed on the screen after images are selected.
 OFF Disable Wi-Fi	Select to terminate the wireless connection between the camera and a smart device. See “Using the Wi-Fi (Wireless LAN) Function” (📖141) for more information.
 Options	<p>SSID: Change the SSID. The SSID configured here is displayed on the smart device. Set a 1- to 24-character alphanumeric SSID.</p> <p>Auth./encryp.: Select whether or not to encrypt the communications between the camera and the connected smart device. Communications are not encrypted when Open (default setting) is selected.</p> <p>Password: Set the password. Set an 8- to 16-character alphanumeric password.</p> <p>Channel: Select the channel used for wireless connections.</p>
INFO Current settings	Display the current settings.
RESET Restore default settings	Restore the Wi-Fi settings to their default values. The wireless connection is terminated if this option is performed while Wi-Fi is connected.

Operating the Text Input Keyboard

- Tap the keyboard to enter alphanumeric characters.
- To move the cursor in the text field, tap  .
- To delete one character, tap .
- To switch to numbers or upper/lower case, tap the text input mode keys.
- To apply the setting, tap .



The Setup Menu

Welcome Screen

Tap  →  menu icon → Welcome screen

Configure the welcome screen that is displayed when you turn on the camera.

Option	Description
None (default setting)	Does not display the welcome screen.
COOLPIX	Displays a welcome screen with the COOLPIX logo.
Select an image	Displays an image selected for the welcome screen. <ul style="list-style-type: none">• The image selection screen is displayed. Select an image ( 115) and tap OK.• Because a copy of the selected image is saved in the camera, it will be displayed when the camera is turned on, even if the original image is deleted.• An image cannot be selected if its aspect ratio is different from that of the screen, or if the image size is extremely small after the small picture or crop function is applied.

Time Zone and Date

Tap **MENU** → **☰** menu icon → Time zone and date

Set the camera clock.

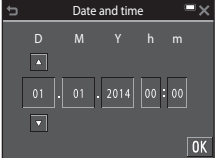
Option	Description
Date and time	<ul style="list-style-type: none">• Select a field: Tap a field that you want to change.• Edit the date and time: Tap ▲▼.• Apply the setting: Tap OK. 
Date format	Select Year/Month/Day , Month/Day/Year , or Day/Month/Year .
Time zone	Set time zone and daylight saving time. <ul style="list-style-type: none">• When Travel destination (✈️) is set after having set the home time zone (🏠), the time difference between the travel destination and the home time zone is automatically calculated, and the date and time are saved for the selected region.

Setting the Time Zone

1 Tap Time zone.

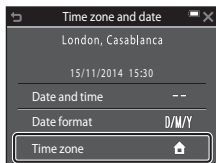

2 Tap **Home time zone** or **Travel destination.**

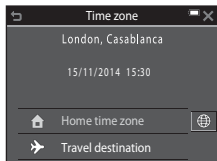

- The date and time displayed in the monitor changes depending on whether the home time zone or travel destination is selected.

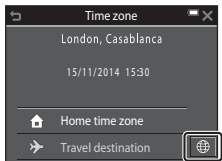

3 Tap .



4 Tap to select the time zone.

- Tap  to enable daylight saving time function, and  is displayed. Tap  to disable the daylight saving time function.
- Tap **OK** to apply the time zone.
- If the correct time is not displayed for the home or travel destination time zone setting, set the appropriate time in **Date and time**.

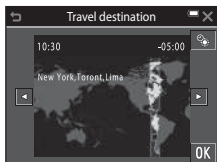

Monitor Settings

Tap **MENU** →  menu icon → Monitor settings

Option	Description
Photo info	Set whether or not to display information in the monitor.
Image review	Set whether or not to display the captured image immediately after shooting. <ul style="list-style-type: none"> • Default setting: On
Brightness	Adjust the brightness. <ul style="list-style-type: none"> • Default setting: 3

Photo Info

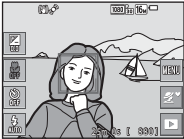
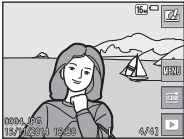
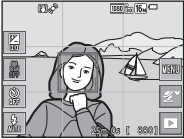
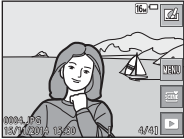
	Shooting mode	Playback mode
Show info		
Auto info (default setting)	Some of the operational icons and information are hidden if no operations are performed for a few seconds. Tap DISP to display the information again.	
Framing grid+auto info	 <p>In addition to the information shown in Auto info, a framing grid is displayed to help frame pictures. The framing grid is not displayed while recording movies.</p>	 <p>Same as Auto info.</p>

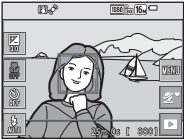
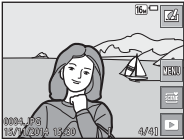
	Shooting mode	Playback mode
Movie frame+auto info	 <p>In addition to the information shown in Auto info, a frame is displayed before movie recording begins that represents the area that will be captured when recording movies.</p> <p>The movie frame is not displayed while recording movies.</p>	 <p>Same as Auto info.</p>

Notes About Monitor Settings



When **Quick effects** (📖104) is set to **On** while shooting still images, the captured image is displayed after shooting, regardless of the **Image review** setting.

Date Stamp

Tap  →  menu icon → Date stamp

The shooting date and time can be stamped on images when shooting. The information can be printed even when using a printer that does not support the date imprinting function.



Option	Description
 DATE Date	Date is stamped on images.
 DATE Date and time	Date and time are stamped on images.
 OFF Off (default setting)	Date and time are not stamped on images.

Notes About Date Stamp

- Stamped dates form a permanent part of image data and cannot be deleted. The date and time cannot be stamped on images after they have been captured.
- The date and time cannot be stamped in the following situations:
 - When using **Night portrait** (when **Hand-held** is selected), **Night landscape** (when **Hand-held** is selected), or **Easy panorama** scene mode
 - When the continuous shooting setting ( 96) is set to **Pre-shooting cache**, **Continuous H: 120 fps**, or **Continuous H: 60 fps**
 - When shooting movies
 - When saving still images during moving recording
- The stamped date and time may be difficult to read when using a small image size.

Printing a Shooting Date on Images Without a Date Stamp





You can transfer images to a computer and use the ViewNX 2 software ( 152) to imprint the shooting date on the images when they are printed.

Photo VR

Tap  →  menu icon → Photo VR

Select the vibration reduction setting used when shooting still images. Select **Off** when using a tripod to stabilize the camera during shooting.

Option	Description
 On (default setting)	Compensation for camera shake is performed using lens shift VR.
OFF Off	Compensation is not performed.





Notes About Photo VR

- After turning on the camera or after switching from playback mode to shooting mode, wait for the shooting mode screen to be displayed completely before taking pictures.
- Images in the camera monitor may be displayed blurry immediately after shooting.
- The effects of camera shake may not be completely eliminated in some situations.

Motion Detection

Tap  →  → Motion detection

Enable motion detection to reduce the effects of subject movement and camera shake when shooting still images.

Option	Description
 Auto (default setting)	Motion detection is enabled with some shooting modes or settings, when  is displayed on the shooting screen. When the camera detects subject movement or camera shake,  changes to green, and the ISO sensitivity and shutter speed are automatically increased to reduce blurring. <ul style="list-style-type: none">• Set ISO sensitivity (99) to Auto in  (auto) mode.
OFF Off	Motion detection is disabled.

Notes About Motion Detection



- Motion detection may be unable to eliminate the effects of subject movement and camera shake in some situations.
- Motion detection may be disabled if the subject exhibits significant movement or is too dark.
- The images captured using motion detection may contain noise.

AF Assist

Tap  →  menu icon → AF assist

Option	Description
AUTO Auto (default setting)	The AF-assist illuminator automatically lights up when you press the shutter-release button under dim lighting. The illuminator has a range of about 2.0 m (6 ft 6 in.) at the maximum wide-angle position and about 2.0 m (6 ft 6 in.) at the maximum telephoto position. <ul style="list-style-type: none">Note that for some scene modes or focus areas, the AF-assist illuminator may not light.
OFF Off	The AF-assist illuminator does not light.

Digital Zoom

Tap  →  menu icon → Digital zoom

Option	Description
ON On (default setting)	Digital zoom is enabled.
OFF Off	Digital zoom is disabled.

Notes About Digital Zoom



- Digital zoom cannot be used in the following shooting modes:
 - Portrait, Night portrait, Night landscape, Backlighting** (when **HDR** is set), **Easy panorama**, or **Pet portrait** scene mode
 - Smart portrait mode
 - Glamour mode
- Digital zoom cannot be used in other shooting modes when using certain settings ( 57).

Sound Settings

Tap  →  menu icon → Sound settings

Option	Description
Button sound	When On (default setting) is selected, the camera produces one beep when operations are performed, two beeps when focus is acquired on the subject, and three beeps when an error occurs. The welcome screen sound is also produced. <ul style="list-style-type: none">• Sounds are disabled when using Pet portrait scene mode.
Shutter sound	When On (default setting) is selected, the shutter sound is produced when the shutter is released. <ul style="list-style-type: none">• The shutter sound is not produced when using continuous shooting mode, when recording movies, or when using Pet portrait scene mode.

Auto Off

Tap  →  menu icon → Auto off

Set the amount of time that elapses before the camera enters standby mode (16).

You can select **30 s**, **1 min** (default setting), **5 min**, or **30 min**.

Setting the Auto Off Function

The time that passes before the camera enters standby mode is fixed in the following situations:

- When a menu is displayed: 3 minutes (when auto off is set to **30 s** or **1 min**)
- When shooting using **Pet portrait auto release**: 5 minutes (when auto off is set to **30 s** or **1 min**)
- When shooting using **Smile timer**: 5 minutes (when auto off is set to **30 s** or **1 min**)
- When the AC Adapter EH-62G is connected: 30 minutes
- When a USB cable or HDMI cable is connected: 30 minutes

Format Card/Format Memory

Tap  →  menu icon → Format card/Format memory

Use this option to format a memory card or the internal memory.

Formatting the memory cards or internal memory permanently deletes all data. Data that has been deleted cannot be recovered. Make sure to save important images to a computer before formatting.

Formatting a Memory Card

- Insert a memory card into the camera.
- Tap **Format card** in the setup menu.



Formatting the Internal Memory

- Remove the memory card from the camera.
- Tap **Format memory** in the setup menu.

To start formatting, tap **Yes** on the screen that is displayed, and tap **OK** on the confirmation dialog.

- Do not turn the camera off or open the battery-chamber/memory card slot cover during formatting.
- This setting cannot be selected while Wi-Fi is connected.

Language

Tap  →  menu icon → Language

Select a language for display of camera menus and messages.

HDMI

Tap  →  menu icon → HDMI

Adjust settings for connection to a TV.



Select a resolution for HDMI output. When **Auto** (default setting) is selected, the option best suited to the TV to which the camera is connected is automatically selected from **480p**, **720p**, or **1080i**.



HDMI

HDMI (High-Definition Multimedia Interface) is a multimedia interface.

Charge by Computer

Tap  →  → Charge by computer

Option	Description
AUTO Auto (default setting)	When the camera is connected to a computer that is running ( 145), the battery inserted into the camera is automatically charged using power supplied by the computer.
OFF Off	The battery inserted into the camera is not charged when the camera is connected to a computer.

Notes About Charging with a Computer

- When connected to a computer, the camera turns on and starts charging. If the camera is turned off, charging stops.
- About 2 hours and 50 minutes are required to charge a fully exhausted battery. Charging time increases when images are transferred while the battery is charging.
- The camera turns off automatically if there is no communication with the computer for 30 minutes after the battery has finished charging.

When the Power-on Lamp Quickly Flashes Orange

Charging cannot be performed, possibly due to one of the reasons described below.

- The ambient temperature is not suited to charging. Charge the battery indoors with an ambient temperature of 5°C to 35°C (41°F to 95°F).
- The USB cable is not connected correctly, or the battery is faulty. Make sure the USB cable is connected correctly or replace the battery if necessary.
- The computer is in sleep mode and is not supplying power. Wake up the computer.
- The battery cannot be charged because the computer cannot supply power to the camera due to the computer's settings or its specifications.

Blink Warning

Tap **MENU** → **Y** menu icon → Blink warning

Select whether or not the camera detects human subjects that have blinked using face detection (📖50) when shooting in the following modes:

- **SCENE** (scene auto selector) mode (📖24)
- **Portrait** or **Night portrait** scene mode (📖25)
- **📷** (auto) mode (when **Face priority** (📖101) is selected for AF area mode option)

Option	Description
ON On	When one or more human subjects may have blinked in an image captured using face detection, the Did someone blink? screen is displayed in the monitor. Check the image and determine whether or not another image should be captured.
OFF Off (default setting)	Blink warning is disabled.

The Blink Warning Screen

Faces detected by the blink warning are displayed inside a border.

The operations described below are available.

- To enlarge the face: Move the zoom control toward **T** (📷). If more than one face is detected, tap **👤** or **👤** to select the desired face.
- To switch to full-frame playback: Move the zoom control toward **W** (📷).
- To delete the displayed image: Tap **🗑️**.

If you tap **OK**, or if no operations are performed for a few seconds, the camera returns to shooting mode.

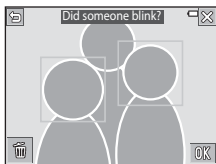



✓ Notes About Blink Warning

- This function may not be available to use in combination with other functions (📖55).
- The blink warning may not function properly in some shooting conditions.

Eye-Fi Upload

Tap  →  menu icon → Eye-Fi upload

Set whether or not to enable the function for sending images to a computer using a commercially available Eye-Fi card.

Option	Description
 Enable (default setting)	Upload images created by the camera to a preselected destination.
 Disable	Images are not uploaded.





- This setting cannot be selected while Wi-Fi is connected.

Notes About Eye-Fi Cards



- Note that images will not be uploaded if signal strength is insufficient even if **Enable** is selected.
- Remove your Eye-Fi card from the camera in areas where the use of radio waves is prohibited. Eye-Fi cards may emit wireless signals when **Disable** is selected.
- Refer to the instruction manual of your Eye-Fi card for more information. In the event of malfunction, or if you have any inquiries, contact the card manufacturer.
- The camera can be used to turn Eye-Fi cards on and off, but may not support other Eye-Fi functions.
- The camera is not compatible with the Endless Memory function. When it is set on a computer, disable the function. If the Endless Memory function is enabled, the number of images captured may not be displayed correctly.
- Eye-Fi cards are for use only in the country of purchase. Observe all local laws concerning wireless devices.
- Leaving the setting as **Enable** will result in the battery being depleted in a shorter period of time.

Eye-Fi Communication Indicator

The communication status of the Eye-Fi card in the camera can be confirmed in the monitor (6).

- : **Eye-Fi upload** is set to **Disable**.
-  (lights): Eye-Fi upload enabled; waiting to begin upload.
-  (flashes): Eye-Fi upload enabled; uploading data.
- : Eye-Fi upload enabled; no images available for upload.
- : An error occurred. The camera cannot control the Eye-Fi card.

Reset All

Tap  →  menu icon → Reset all

When **Reset** is selected, the camera's settings are restored to their default values.

- Some settings, such as **Time zone and date** or **Language**, are not reset.
- This setting cannot be selected while Wi-Fi is connected.



Resetting File Numbering

To reset file numbering to "0001", delete all images saved on the memory card or in the internal memory () before selecting **Reset all**.

Firmware Version

Tap  →  menu icon → Firmware version

View the current camera firmware version.

- This setting cannot be selected while Wi-Fi is connected.

Using the Wi-Fi (Wireless LAN) Function

You can perform the following functions if you install the dedicated software “Wireless Mobile Utility” on your smart device that runs on Android OS or iOS, and connect it to the camera.

Take Photos

You can capture still images using the two methods described below.

- Release the shutter on the camera and save the captured images to a smart device.
- Use a smart device to remotely release the camera shutter and save images to the smart device.

View Photos

Images that are saved in the camera’s memory card can be transferred and viewed on your smart device. You can also preselect the images in the camera that you want to transfer to your smart device.

Notes

Security settings such as the password are not configured at the time of purchase. It is the user’s responsibility to configure the appropriate security settings in **Options** in the Wi-Fi options menu (📖87) if necessary.

Installing the Software on the Smart Device

- 1** Use your smart device to connect to the Google Play Store, App Store or other online apps marketplace and search for “Wireless Mobile Utility.”
 - Check the user’s manual provided with your smart device for further details.
- 2** Check the description and other information and install the software.

User’s Manual for Wireless Mobile Utility

Download the user’s manual from the website below.

- Android OS: <http://nikonimglib.com/ManDL/WMAU/>
- iOS: <http://nikonimglib.com/ManDL/WMAU-ios/>

To establish a connection with the camera, press the  (Wi-Fi) button on the camera, turn on the Wi-Fi function of the smart device, and then start the “Wireless Mobile Utility” on the smart device while “Negotiating... Please wait.” is displayed on the camera.

Connecting the Smart Device to the Camera

1 Press the Wi-Fi button on the camera.

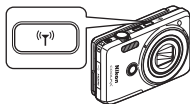

- The screen shown on the right is displayed.
- If no connection confirmation is received from the smart device within three minutes, **No access.** is displayed and the camera returns to the Wi-Fi options screen.
- You can also tap **Connect to smart device** in the Wi-Fi options menu to display the screen shown on the right.

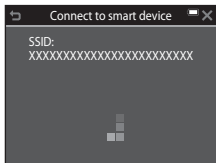

2 Set the Wi-Fi setting on the smart device to On.

- Check the user's manual provided with your smart device for further details.
- After the network names (SSIDs) that can be used for the smart device are displayed, select the SSID displayed on the camera.
- When **Auth./encryp.** in the Wi-Fi options menu is set to **WPA2-PSK-AES**, the message for entering a password is displayed. Enter the password that is displayed on the camera.

3 While "Negotiating... Please wait." is displayed on the camera, start the "Wireless Mobile Utility" installed on the smart device.

- The screen for selecting "Take photos" or "View photos" is displayed.
- When the message "Cannot connect to camera." is displayed, return to step 1 and retry the procedure.
- "Installing the Software on the Smart Device" (📖141).

 **Touching an NFC-compatible Smart Device to the Camera for a Wi-Fi Connection**

When you use an Android OS smart device that is compatible with near field communication (NFC) functions, you can establish a Wi-Fi connection and start the "Wireless Mobile Utility" by touching the NFC antenna of the smart device to the  (N-Mark) on the camera.

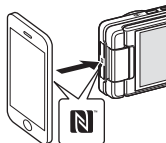



To Terminate the Wi-Fi Connection

Perform one of the operations described below.

- Turn off the camera.
- Select **Disable Wi-Fi** in the Wi-Fi options menu on the camera (except when the camera is operated by remote control).
- Set the Wi-Fi setting on the smart device to Off.

Notes About Wi-Fi Connection

- Wi-Fi connection operations are disabled in the following situations:
 - When no memory card is inserted in the camera
 - When an Eye-Fi card (📖139) is inserted in the camera
 - When the camera is connected to a TV, computer, or printer.
 - When the battery level indicator in the monitor indicates . In addition, if the battery level indicator changes to  while Wi-Fi is connected, the connection is terminated.
 - While recording movies
 - While recording voice memos
 - While the camera is processing data such as saving images or recording movies
 - When the camera is connected to a smart device
- Select **Disable Wi-Fi** in areas where the use of radio waves is prohibited.
- When Wi-Fi is connected, **Auto off** is disabled.
- When Wi-Fi is connected, the battery drains faster than normal.

Security Settings

If no security settings (encryption and password) are configured for the camera's Wi-Fi function, unauthorized third parties may access the network and cause harm. We strongly recommend performing the required security settings before using the Wi-Fi function.

Use **Options** in the Wi-Fi options menu (📖123) to perform the security settings.

Preselecting Images in the Camera That You Want to Transfer to a Smart Device

You can preselect images in the camera that you want to transfer to a smart device. Movies cannot be preselected for transfer.

1 Select images to transfer.

You can preselect the images to transfer to a smart device in the following menus:

- **Mark for Wi-Fi upload** in the playback menu (📖109)
- **Upload from camera** in the Wi-Fi options menu (📖123)

When using **Upload from camera**, the SSID and password of the camera are displayed after images are selected.

2 Connect the camera and smart device (📖142).

After the camera and smart device are connected and the “Wireless Mobile Utility” starts, tap “View Photos” on the displayed confirmation screen to transfer the specified images to the smart device.

Preselecting Images to Transfer During Playback

While the camera is in playback mode, press the Wi-Fi button or use the NFC function to establish a Wi-Fi connection, and preselect the displayed images that you want to transfer.

- You can preselect one image at a time in full-frame playback mode.
- You can preselect 4, 9, or 16 images at a time in thumbnail playback mode.

This operation is not available when you use **Connect to smart device** in the Wi-Fi options menu to establish the Wi-Fi connection.

Connecting the Camera to a TV, Printer, or Computer

You can enhance your enjoyment of images and movies by connecting the camera to a TV, printer, or computer.

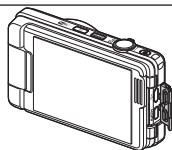
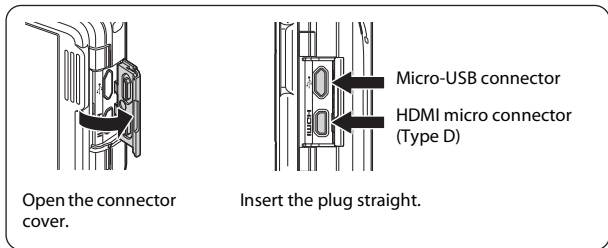

- Before connecting the camera to an external device, make sure the remaining battery level is sufficient and turn the camera off. Before disconnecting, make sure to turn the camera off.
- If the AC Adapter EH-62G (available separately) is used, this camera can be powered from an electrical outlet. Do not use any other make or model of AC adapter as it may cause the camera to heat up or malfunction.
- For information about the connection methods and subsequent operations, refer to the documentation included with the device in addition to this document.



Images and movies captured with the camera can be viewed on a TV.

Connection method: Connect a commercially available HDMI cable to the TV's HDMI input jack.



If you connect the camera to a PictBridge-compatible printer, you can print images without using a computer.

Connection method: Connect the camera directly to the printer's USB port with the USB cable.



You can transfer images to a computer to perform simple retouching and manage image data.

Connection method: Connect the camera to the computer's USB port with the USB cable.

- Before connecting to a computer, install ViewNX 2 on the computer ( 152).
- If any USB devices that draw the power from the computer are connected, disconnect them from the computer before you connect the camera to it. Connecting the camera and other USB-powered devices to the same computer simultaneously may cause a camera malfunction or excessive power supply from the computer, which could damage the camera or memory card.

Connecting the Camera to a TV (Playback on a TV)

1 Turn off the camera and connect it to the TV.

- Make sure that the plugs are properly oriented. Do not insert or remove the plugs at an angle when connecting or disconnecting them.

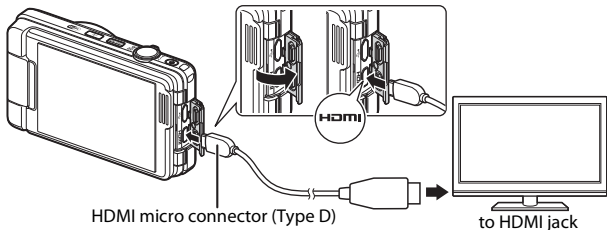

2 Set the TV's input to external video input.

- See the documentation provided with your TV for details.

3 Turn on the camera.

- Images are displayed on the TV.
- The camera monitor does not turn on.

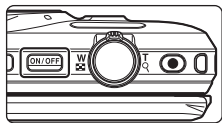

✓ If Images Are Not Displayed on the TV

Make sure that **HDMI** (📖136) in the setup menu conforms to the standard used by your TV.

Connecting the Camera to a Printer (Direct Print)

Users of PictBridge-compatible printers can connect the camera directly to the printer and print images without using a computer.

Connecting the Camera to a Printer

- 1 Turn on the printer.
- 2 Turn off the camera and connect it to the printer using the USB cable.
 - Make sure that the plugs are properly oriented. Do not insert or remove the plugs at an angle when connecting or disconnecting them.

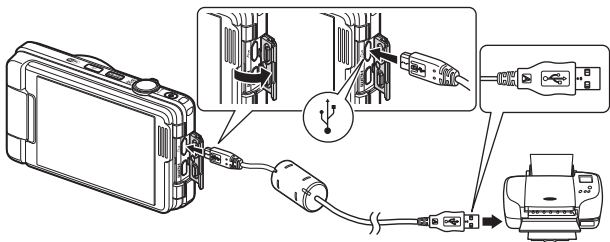

- 3 The camera is automatically turned on.
 - The **PictBridge** startup screen (①) is displayed in the camera monitor, followed by the **Print selection** screen (②).

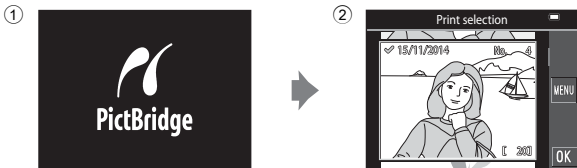

✓ If the PictBridge Startup Screen Is Not Displayed

When **Auto** is selected for **Charge by computer** (📖137), it may be impossible to print images with direct connection of the camera to some printers. If the PictBridge startup screen is not displayed after the camera is turned on, turn the camera off and disconnect the USB cable. Set **Charge by computer** to **Off** and reconnect the camera to the printer.

Printing Images One at a Time

1 Tap to select the desired image, and tap **OK**.

- Move the zoom control toward **W** (📐) to switch to thumbnail playback or **T** (🔍) to switch to full-frame playback.

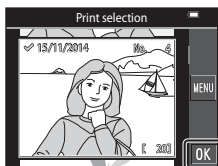

2 Tap **Copies**.

- Tap the desired number of copies (up to nine).

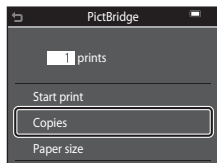

3 Tap **Paper size**.

- Tap the desired paper size.
- To print with the paper size setting configured on the printer, select **Default**.
- The paper size options available on the camera vary depending on the printer that you use.

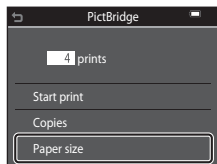

4 Tap **Start print**.

- Printing starts.

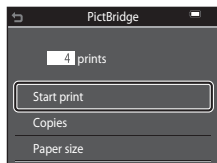

Printing Multiple Images

- 1 When the **Print selection** screen is displayed, tap **MENU**.

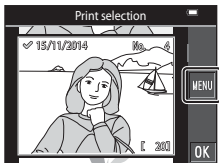

- 2 Tap **Paper size**.

- Tap the desired paper size.
- To print with the paper size setting configured on the printer, select **Default**.
- The paper size options available on the camera vary depending on the printer that you use.
- To exit the print menu, tap .





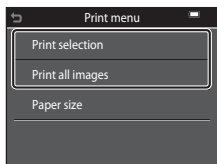



- 3 Tap **Print selection** or **Print all images**.



Print selection

Select images (up to 99) and the number of copies (up to 9) of each.

- Tap to select images, and tap   to specify the number of copies to be printed.
- Images selected for printing are indicated by  and the number of copies to be printed. To cancel the print selection, set the number of copies to 0.
- Move the zoom control toward **T** () to switch to full-frame playback or **W** () to switch to thumbnail playback.
- Tap  to cancel all image selections.
- Tap  when setting is complete. When the screen for confirming the number of print copies is displayed, tap **Start print** to start printing.

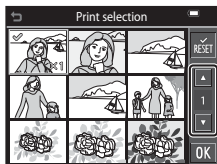

Print all images

One copy each of all images saved in the internal memory, or on the memory card, is printed.

- When the screen for confirming the number of print copies is displayed, tap **Start print** to start printing.

Using ViewNX 2 (Transferring Images to a Computer)

Installing ViewNX 2

ViewNX 2 is free software that enables you to transfer images and movies to your computer so that you can view, edit, or share them. To install ViewNX 2, download the ViewNX 2 installer from the website below and follow the on-screen installation instructions.

<http://nikonimglib.com/nvnx/>

For system requirements and other information, see the Nikon website for your region.

Transferring Images to a Computer

1 Prepare a memory card that contains images.

You can use any of the methods below to transfer images from the memory card to a computer.

- **SD memory card slot/card reader:** Insert the memory card into the card slot of your computer or the card reader (commercially available) that is connected to the computer.
- **Direct USB connection:** Turn the camera off and ensure that the memory card is inserted in the camera. Connect the camera to the computer using the USB cable.

The camera automatically turns on.

To transfer images that are saved in the camera's internal memory, remove the memory card from the camera before connecting it to the computer.

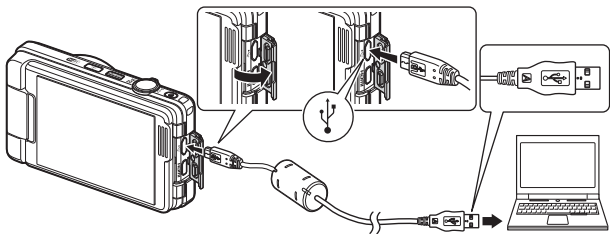

If a message is displayed prompting you to choose a program, select Nikon Transfer 2.

- **When using Windows 7**

If the dialog shown at right is displayed, follow the steps below to select Nikon Transfer 2.

- 1 Under **Import pictures and videos**, click **Change program**. A program selection dialog will be displayed; select **Import File using Nikon Transfer 2** and click **OK**.
- 2 Double-click **Import File**.



If the memory card contains a large number of images, it may take a while for Nikon Transfer 2 to start. Wait until Nikon Transfer 2 starts.

✓ **Notes About Connecting the USB Cable**

Operation is not guaranteed if the camera is connected to the computer via a USB hub.

2 After Nikon Transfer 2 starts, click **Start Transfer**.

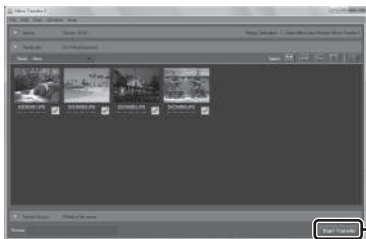

- Image transfer begins. When image transfer is complete, ViewNX 2 starts and the transferred images are displayed.
- Consult online help for more information on using ViewNX 2.

3 Terminate the connection.

- If you are using a card reader or card slot, choose the appropriate option in the computer operating system to eject the removable disk corresponding to the memory card and then remove the memory card from the card reader or card slot.
- If the camera is connected to the computer, turn the camera off and disconnect the USB cable.

Technical Notes

Caring for the Product	155
The Camera.....	155
The Battery.....	156
The Charging AC Adapter	157
Memory Cards.....	158
Cleaning and Storage	159
Cleaning.....	159
Storage	159
Error Messages	160
Troubleshooting	164
File Names.....	171
Optional Accessories.....	172
Specifications	173
Approved Memory Cards	177
Index.....	179

Caring for the Product

Observe the precautions described below in addition to the warnings in “For Your Safety” (☞vi–viii) when using or storing the device.

The Camera

Do Not Apply Strong Impact to the Camera

The product may malfunction if subjected to strong shock or vibration. In addition, do not touch or apply force to the lens or lens cover.

Keep Dry

The device will be damaged if immersed in water or subjected to high humidity.

Avoid Sudden Changes in Temperature

Sudden changes in temperature, such as when entering or leaving a heated building on a cold day, can cause condensation to form inside the device. To prevent condensation, place the device in a carrying case or a plastic bag before exposing it to sudden changes in temperature.

Keep Away from Strong Magnetic Fields

Do not use or store this device in the vicinity of equipment that generates strong electromagnetic radiation or magnetic fields. Doing so could result in loss of data or camera malfunction.

Do Not Point the Lens at Strong Light Sources for Extended Periods

Avoid pointing the lens at the sun or other strong light sources for extended periods when using or storing the camera. Intense light may cause the image sensor to deteriorate or produce a white blur effect in photographs.

Turn the Product Off Before Removing or Disconnecting the Power Source or Memory Card

Do not remove the battery while the product is on, or while images are being saved or deleted. Forcibly cutting power in these circumstances could result in loss of data or in damage to product memory or internal circuitry.

Notes About the Monitor

- Monitors and electronic viewfinders are constructed with extremely high precision; at least 99.99% of pixels are effective, with no more than 0.01% being missing or defective. Hence while these displays may contain pixels that are always lit (white, red, blue, or green) or always off (black), this is not a malfunction and has no effect on images recorded with the device.
- Images in the monitor may be difficult to see under bright lighting.
- Do not apply pressure to the monitor, as this could cause damage or malfunction. Should the monitor break, care should be taken to avoid injury caused by broken glass and to prevent the liquid crystal from the display touching the skin or entering the eyes or mouth.

The Battery

Precautions for Use

- Note that the battery may become hot after use.
- Do not use the battery at ambient temperatures below 0°C (32°F) or above 40°C (104°F) as this could cause damage or malfunction.
- If you notice any abnormalities such as excessive heat, smoke, or an unusual smell coming from the battery, immediately discontinue use and consult your retailer or Nikon-authorized service representative.
- After removing the battery from the camera or optional battery charger, put the battery in a plastic bag, etc. in order to insulate it.

Charging the Battery

Check the battery level before using the camera and replace or charge the battery if necessary.

- Charge the battery indoors with an ambient temperature of 5°C to 35°C (41°F to 95°F) before use.
- A high battery temperature may prevent the battery from charging properly or completely, and may reduce battery performance. Note that the battery may become hot after use; wait for the battery to cool before charging. When charging the battery inserted into this camera using the Charging AC Adapter or a computer, the battery is not charged at battery temperatures below 0°C (32°F) or above 45°C (113°F).
- Do not continue charging once the battery is fully charged as this will result in reduced battery performance.
- The battery temperature may increase during charging. However, this is not a malfunction.

Carrying Spare Batteries

Whenever possible, carry fully charged spare batteries when taking pictures on important occasions.

Using the Battery When Cold

On cold days, the capacity of batteries tends to decrease. If an exhausted battery is used at a low temperature, the camera may not turn on. Keep spare batteries in a warm place and exchange as necessary. Once warmed, a cold battery may recover some of its charge.

Battery Terminals

Dirt on the battery terminals may prevent the camera from functioning. Should the battery terminals become dirty, wipe them off with a clean, dry cloth before use.

Charging an Exhausted Battery

Turning the camera on or off while an exhausted battery is inserted in the camera may result in reduced battery life. Charge the exhausted battery before use.

Storing the Battery

- Always remove the battery from the camera or optional battery charger when it is not being used. Minute amounts of current are drawn from the battery while it is in the camera, even when not in use. This may result in excessive battery drain and complete loss of function.
- Recharge the battery at least once every six months and completely exhaust it before returning it to storage.
- Put the battery in a plastic bag, etc. in order to insulate it and store it in a cool place. The battery should be stored in a dry location with an ambient temperature of 15°C to 25°C (59°F to 77°F). Do not store the battery in hot or extremely cold locations.

Battery Life

A marked drop in the time a fully charged battery retains its charge, when used at room temperature, indicates that the battery needs to be replaced. Purchase a new battery.

Recycling Used Batteries

Replace the battery when it no longer holds a charge. Used batteries are a valuable resource. Please recycle used batteries in accordance with local regulations.

The Charging AC Adapter

- The Charging AC Adapter EH-71P/EH-71PCH is for use only with compatible devices. Do not use with another make or model of device.
- Do not use any USB cable other than the UC-E21. Using a USB cable other than the UC-E21 could result in overheating, fire or electric shock.
- Do not, under any circumstances, use another make or model of AC adapter other than Charging AC Adapter EH-71P/EH-71PCH, and do not use a commercially available USB-AC adapter or a battery charger for a mobile phone. Failure to observe this precaution could result in overheating or in damage to the camera.
- The EH-71P/EH-71PCH is compatible with AC 100–240 V, 50/60 Hz electrical outlets. When using in other countries, use a plug adapter (commercially available) as necessary. For more information about plug adapters, consult your travel agency.

Memory Cards

Precautions for Use

- Use only Secure Digital memory cards. See “Approved Memory Cards” (📖177) for recommended memory cards.
- Be sure to follow the precautions described in the documentation included with the memory card.
- Do not put labels or stickers on memory cards.

Formatting

- Do not format the memory card using a computer.
- The first time you insert a memory card that has been used in another device into this camera, be sure to format it with this camera. We recommend formatting new memory cards with this camera before using them with this camera.
- **Note that formatting a memory card permanently deletes all images and other data on the memory card.** Be sure to make copies of any images you wish to keep before formatting the memory card.
- If the message **Card is not formatted. Format card?** is displayed when the camera is turned on, the memory card must be formatted. If there is data that you do not want to delete, tap **No**. Copy the necessary data to a computer, etc. If you want to format the memory card, tap **Yes**. The confirmation dialog will be displayed. Follow the on-screen instructions to complete the operation.
- Do not perform the following during formatting, while data is being written to or deleted from the memory card, or during data transfer to a computer. Failure to observe this precaution could result in the loss of data or in damage to the camera or memory card:
 - Open the battery-chamber/memory card slot cover to remove/insert the battery or memory card.
 - Turn off the camera.
 - Disconnect the AC adapter.

Cleaning and Storage

Cleaning

Do not use alcohol, thinner, or other volatile chemicals.

Lens	Avoid touching glass parts with your fingers. Remove dust or lint with a blower (typically a small device with a rubber bulb attached to one end that is pumped to produce a stream of air out the other end). To remove fingerprints or other stains that cannot be removed with a blower, wipe the lens with a soft cloth, using a spiral motion that starts at the center of the lens and working toward the edges. If this fails, clean the lens using a cloth lightly dampened with commercial lens cleaner.
Monitor	Remove dust or lint with a blower. To remove fingerprints and other stains, clean the monitor with a soft, dry cloth, being careful not to apply pressure.
Body	Use a blower to remove dust, dirt, or sand, then wipe gently with a soft, dry cloth. After using the camera at the beach or other sandy or dusty environment, wipe off any sand, dust, or salt with a dry cloth lightly dampened with fresh water and dry thoroughly. Note that foreign matter inside the camera could cause damage not covered by the warranty.

Storage

Remove the battery if the camera will not be used for an extended period. To prevent mold or mildew, take the camera out of storage at least once a month. Turn the camera on and release the shutter a few times before putting the camera away again. Do not store the camera in any of the following locations:



- Places that are poorly ventilated or subject to humidity of over 60%
- Exposed to temperatures above 50°C (122°F) or below -10°C (14°F)
- Next to equipment that produces strong electromagnetic fields, such as televisions or radios

For storing the battery, follow the precautions in “The Battery” (📖156) in “Caring for the Product” (📖155).

Error Messages

Refer to the table below if an error message is displayed.

Display	Cause/Solution	
Battery temperature is elevated. The camera will turn off.	The camera turns off automatically. Wait until the camera or battery temperature has cooled before resuming use.	–
The camera will turn off to prevent overheating.		
Memory card is write protected.	The write-protect switch is in the “lock” position. Slide the write-protect switch to the “write” position.	–
This card cannot be used.	An error occurred while accessing the memory card. <ul style="list-style-type: none"> • Use an approved memory card. • Check that the terminals are clean. • Confirm that the memory card is correctly inserted. 	10, 177
This card cannot be read.		
Card is not formatted. Format card?	The memory card has not been formatted for use in the camera. Formatting deletes all data saved on the memory card. If you need to keep copies of any images, make sure to tap No and save the copies to a computer or other medium before formatting the memory card. Tap Yes and follow the on-screen instructions to format the memory card.	158
Not available if Eye-Fi card is locked.	The write-protect switch of the Eye-Fi card is in the “lock” position.	–
	An error occurred while accessing the Eye-Fi card. <ul style="list-style-type: none"> • Check that the terminals are clean. • Confirm that the Eye-Fi card is correctly inserted. 	–
Out of memory.	Delete images or insert a new memory card.	10, 20

Display	Cause/Solution	
Image cannot be saved.	An error occurred while saving the image. Insert a new memory card or format the memory card or internal memory.	135
	The camera has run out of file numbers. Insert a new memory card or format the memory card or internal memory.	135
	The image cannot be used for the welcome screen.	125
	There is insufficient space to save the copy. Delete images from the destination.	20
Album is full. No further pictures can be added.	200 images have already been added to the album. <ul style="list-style-type: none"> Remove some images from the album. Add to other albums. 	62 60
Sound file cannot be saved.	A voice memo cannot be attached to this image. <ul style="list-style-type: none"> Voice memos cannot be attached to movies. Select an image captured with this camera. 	-
Image cannot be modified.	Check that the images can be edited.	68, 169
Cannot record movie.	A time-out error occurred while saving the movie on the memory card. Select a memory card with a faster write speed.	82, 177
Memory contains no images.	There are no images in the internal memory or on the memory card. <ul style="list-style-type: none"> Remove the memory card to play back images in the internal memory. To copy the images saved in the camera's internal memory to the memory card, tap  to select Copy in the playback menu. 	10 113
	No images have been added to the selected album.	60, 61
	No images are contained in the category selected in auto sort mode.	64

Display	Cause/Solution	
File contains no image data.	The file was not created or edited with this camera.	–
This file cannot be played back.	The file cannot be viewed on this camera. View the file using a computer or the device used to create or edit this file.	
All images are hidden.	There are no images available for a slide show, etc.	110
This image cannot be deleted.	The image is protected. Disable protection.	111
No access.	The camera could not receive the signal from the smart device. Establish the wireless connection again. <ul style="list-style-type: none"> • Press the Wi-Fi button. • Touch an NFC-compatible smart device to the camera. • Tap Connect to smart device in the Wi-Fi options menu. 	123, 142
Could not connect.	The camera failed to establish the connection while receiving the signals from the smart device. Set a different channel in Channel under Options in the Wi-Fi options menu, and establish the wireless connection again.	123, 142
Wi-Fi connection terminated.	A cable was connected to the camera while the camera and smart device were wirelessly connected, the battery level became low, or the connection was aborted due to poor connectivity. Disconnect the cable and establish the wireless connection again.	123, 142

Display	Cause/Solution	
Lens error	A lens error occurred. Turn the camera off and then on again. If the error persists, contact your retailer or Nikon-authorized service representative.	164
Communications error	An error occurred while communicating with the printer. Turn the camera off and reconnect the USB cable.	148
System error	An error occurred in the camera's internal circuitry. Turn the camera off, remove and reinsert the battery, and turn the camera on. If the error persists, contact your retailer or Nikon-authorized service representative.	164
Printer error: check printer status.	After solving the problem, tap Resume to resume printing.*	–
Printer error: check paper.	Load the specified size of paper, and tap Resume to resume printing.*	–
Printer error: paper jam.	Remove the jammed paper, and tap Resume to resume printing.*	–
Printer error: out of paper.	Load the specified size of paper, and tap Resume to resume printing.*	–
Printer error: check ink.	There is a problem with the printer's ink. Check the ink, and tap Resume to resume printing.*	–
Printer error: out of ink.	Replace the ink cartridge, and tap Resume to resume printing.*	–
Printer error: file corrupt.	There is a problem with the image file to be printed. Tap Cancel to cancel printing.	–



* See the documentation provided with your printer for further guidance and information.

Troubleshooting

If the camera fails to function as expected, check the list of common problems below before consulting your retailer or Nikon-authorized service representative.



Power, Display, Settings Issues





Problem	Cause/Solution	
The camera is on but does not respond.	Wait for recording to end. If the problem persists, turn the camera off. If the camera does not turn off, remove and reinsert the battery or batteries or, if you are using an AC adapter, disconnect and reconnect the AC adapter. Note that although any data currently being recorded will be lost, data that have already been recorded will not be affected by removing or disconnecting the power source.	–
The camera cannot be turned on.	The battery is exhausted.	10, 11, 157
The camera turns off without warning.	<ul style="list-style-type: none">• The camera automatically turns off to save power (auto off function).• The camera and battery may not work properly at low temperatures.• The inside of the camera has become hot. Leave the camera off until the inside of the camera has cooled, and then try turning it on again.	16 156 –
The monitor is blank.	<ul style="list-style-type: none">• The camera is off.• The camera automatically turns off to save power (auto off function).• The camera is connected to a TV or computer.• The camera and smart device are connected using a Wi-Fi connection and the camera is being operated by remote control.	13 16 – –
The camera becomes hot.	The camera may become hot when used for an extended period of time to shoot movies or send images using an Eye-Fi card, or when used in a hot environment; this is not a malfunction.	–





Problem	Cause/Solution	
The battery inserted in the camera cannot be charged.	<ul style="list-style-type: none"> • Confirm all connections. • When connected to a computer, the camera may not charge for any of the reasons described below. <ul style="list-style-type: none"> - Off is selected for Charge by computer in the setup menu. - Battery charging stops if the camera is turned off. - Battery charging is not possible if the camera's display language and date and time have not been set, or the date and time were reset after the camera's clock battery was exhausted. Use the Charging AC Adapter to charge the battery. - Battery charging may stop when the computer enters sleep mode. - Depending on the computer specifications, settings, and status, battery charging may not be possible. 	11 87, 137 – 13, 14 – –
The monitor is hard to read.	<ul style="list-style-type: none"> • Adjust the monitor brightness. • The monitor is dirty. Clean the monitor. 	128 159
 flashes on the screen. Date and time of recording are not correct.	<ul style="list-style-type: none"> • If the camera clock has not been set,  flashes on the shooting screen, and images and movies saved before the clock is set are dated "00/00/0000 00:00" and "01/01/2014 00:00" respectively. Set the correct time and date for Time zone and date in the setup menu. • The camera clock is not as accurate as ordinary watches or clocks. Periodically compare the time of the camera clock with that of a more accurate timepiece, and reset as required. 	7, 126
No indicators displayed in monitor.	Auto info is selected for Photo info in Monitor settings in the setup menu.	128
Date stamp not available.	Time zone and date has not been set in the setup menu.	126
Date not stamped on images even when Date stamp is enabled.	<ul style="list-style-type: none"> • The current shooting mode does not support Date stamp. • The date cannot be stamped on movies. 	130

Problem	Cause/Solution	
Screen for setting time zone and date is displayed when the camera is turned on.	The clock battery is exhausted; all settings were restored to their default values.	13, 14
The camera settings reset.		
The camera makes sound.	When Autofocus mode is set to Full-time AF or while in some shooting modes, the camera may produce an audible focusing sound.	22, 104, 120

Shooting Issues

Problem	Cause/Solution	
Cannot switch to shooting mode.	Disconnect the HDMI cable or USB cable.	145
Cannot take pictures or record movies.	<ul style="list-style-type: none"> When the camera is in playback mode or a menu is displayed, press the shutter-release button or  (movie-record) button. 	1, 19, 87
	<ul style="list-style-type: none"> The flash is charging while the flash indicator is flashing. The battery is exhausted. 	43 10, 11, 157
The camera cannot focus.	<ul style="list-style-type: none"> The subject is too close. Try shooting using scene auto selector mode, Close-up scene mode, or macro mode. The subject is hard to focus on. Set AF assist in the setup menu to Auto. Turn the camera off and then on again. 	22, 23, 24, 28, 46 53 133 –
Images are blurred.	<ul style="list-style-type: none"> Use the flash. Increase the ISO sensitivity value. Enable Photo VR and/or Motion detection when shooting still images. Enable Movie VR when recording movies. Use BSS (Best Shot Selector). Use a tripod to stabilize the camera (using the self-timer at the same time is more effective). 	43 99 121, 131, 132 28, 96 45
Bright specks appear in images captured with flash.	The flash is reflecting off particles in the air. Set the flash mode setting to  (off).	43

Problem	Cause/Solution	
Flash does not fire.	<ul style="list-style-type: none"> • The flash mode is set to  (off). • A scene mode that restricts the flash is selected. • A function that restricts the flash is enabled. 	43 48 55
Digital zoom cannot be used.	<ul style="list-style-type: none"> • Digital zoom is set to Off in the setup menu. • Digital zoom cannot be used with certain shooting modes or when using certain settings in other functions. 	133 57, 133
Image mode not available.	A function that restricts Image mode is enabled.	55
No sound when the shutter is released.	Off is selected for Shutter sound in Sound settings in the setup menu. No sound is produced with some shooting modes and settings, even when On is selected.	134
AF-assist illuminator does not light.	Off is selected for AF assist in the setup menu. AF-assist illuminator may not light depending on the position of the focus area or the current scene mode, even when Auto is selected.	133
Images appear smeared.	The lens is dirty. Clean the lens.	159
Colors are unnatural.	White balance or hue is not adjusted properly.	28, 94
Randomly spaced bright pixels ("noise") appear in image.	<p>The subject is dark and the shutter speed is too slow, or ISO sensitivity is too high. Noise can be reduced by:</p> <ul style="list-style-type: none"> • Using the flash • Specifying a lower ISO sensitivity setting 	43 99
Images are too dark (underexposed).	<ul style="list-style-type: none"> • The flash mode is set to  (off). • The flash window is blocked. • The subject is beyond the range of the flash. • Adjust exposure compensation. • Increase ISO sensitivity. • The subject is backlit. Select Backlighting scene mode or set the flash mode setting to . 	43 15 174 47 99 29, 43

Problem	Cause/Solution	
Images are too bright (overexposed).	Adjust exposure compensation.	47
Unexpected results when flash set to  (auto with red-eye reduction).	Use any scene mode other than Night portrait , and change the flash mode to any setting other than  (auto with red-eye reduction) and try taking the picture again.	43, 48
Skin tones are not softened.	<ul style="list-style-type: none"> In some shooting conditions, facial skin tones may not be softened. For images containing four or more faces, try using the Skin softening effect in Glamour retouch in the playback menu. 	51 71
Saving images takes time.	<p>It may take more time to save images in the following situations:</p> <ul style="list-style-type: none"> When the noise reduction function is in operation, such as when shooting in a dark environment When the flash mode is set to  (auto with red-eye reduction) When shooting in Night landscape, Night portrait, or Backlighting (when HDR is set to On) scene mode When the skin softening function is applied while shooting When using continuous shooting mode 	– 44 27, 28, 29 51, 105 96
A ring-shaped belt or rainbow-colored stripe appears in the monitor or images.	When shooting with backlighting or when a very strong light source (such as sunlight) is in the frame, a ring-shaped belt or rainbow-colored stripe (ghosting) may occur. Change the position of the light source, or frame the picture so that the light source does not enter the frame, and try again.	–

Playback Issues

Problem	Cause/Solution	
File cannot be played back.	<ul style="list-style-type: none"> This camera may not be able to play back images saved with another make or model of digital camera. This camera cannot play back movies recorded with another make or model of digital camera. This camera may not be able to play back data edited on a computer. 	–

Problem	Cause/Solution	
Cannot zoom in on image.	<ul style="list-style-type: none"> • Playback zoom cannot be used with movies. • This camera may not be able to zoom in on images captured with another make or model of digital camera. 	–
Cannot record voice memos.	<ul style="list-style-type: none"> • Voice memos cannot be attached to movies. • Delete the voice memo for an image before recording a new one. • Voice memos cannot be attached to images captured with other cameras. Voice memos attached to images using another camera cannot be played back. 	– 112 –
Cannot edit images.	<ul style="list-style-type: none"> • Some images cannot be edited. Images that have already been edited may not be edited again. • There is not enough free space on the memory card or in the internal memory. • This camera is unable to edit images captured with other cameras. • Editing functions used for images are not available for movies. 	33, 68 – – –
Cannot rotate image.	This camera cannot rotate images captured with another make or model of digital camera.	–
Images are not displayed on TV.	<ul style="list-style-type: none"> • HDMI is not correctly set in the setup menu. • A computer or printer is connected to the camera. • The memory card contains no images. • Remove the memory card to play back images in the internal memory. 	87, 136 – – 10
Nikon Transfer 2 does not start when the camera is connected to a computer.	<ul style="list-style-type: none"> • The camera is off. • The battery is exhausted. • The USB cable is not correctly connected. • The camera is not recognized by the computer. • The computer is not set to start Nikon Transfer 2 automatically. For more information about Nikon Transfer 2, refer to help information contained in ViewNX 2. 	– 137, 145 145, 152 – –

Problem	Cause/Solution	
The PictBridge startup screen is not displayed when the camera is connected to a printer.	With some PictBridge-compatible printers, the PictBridge startup screen may not be displayed and it may be impossible to print images when Auto is selected for Charge by computer in the setup menu. Set Charge by computer to Off and reconnect the camera to the printer.	87, 137
Images to be printed are not displayed.	<ul style="list-style-type: none"> • The memory card contains no images. • Remove the memory card to print images in the internal memory. 	– 10
Cannot select paper size with the camera.	<p>The camera cannot be used to select the paper size in the following situations, even when printing from a PictBridge-compatible printer. Use the printer to select the paper size.</p> <ul style="list-style-type: none"> • The printer does not support the paper sizes specified by the camera. • The printer automatically selects the paper size. 	–

File Names

Images, movies, or voice memos are assigned file names as follows.

File name: DSCN0001.JPG

(1) (2) (3)

(1) Identifier	Not shown on the screen of the camera. <ul style="list-style-type: none">• DSCN: Original still images, movies, still images extracted from movies• SSCN: Small picture copies• RSCN: Cropped copies• FSCN: Images created by an image editing function other than crop and small picture, movies created by the movie editing function
(2) File number	Assigned in ascending order, starting with "0001" and ending with "9999."
(3) Extension	Indicates file format. <ul style="list-style-type: none">• .JPG: Still images• .MOV: Movies• .WAV: Voice memos (Identifier and file number are the same as the image to which the voice memo is attached.)

Optional Accessories

Battery charger

Battery Charger MH-66

It takes about 1 hour and 50 minutes to charge a fully exhausted battery.

AC adapter

AC Adapter EH-62G

(connect as shown)

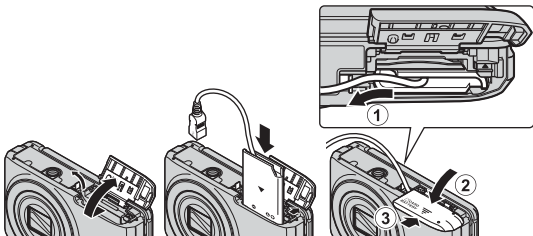

Make sure that the power connector cable is fully inserted in the power connector slot before inserting the AC adapter into the battery chamber. In addition, make sure that the power connector cable is fully inserted in the battery chamber slot before closing the battery-chamber/memory card slot cover. If part of the cable protrudes from the slots, the cover or cable may be damaged when the cover is closed.

Availability may vary with country or region.
See our website or brochures for the latest information.

Specifications

Nikon COOLPIX S6900 Digital Camera

Type	Compact digital camera
Number of effective pixels	16.0 million (Image processing may reduce the number of effective pixels.)
Image sensor	$\frac{1}{2.3}$ -in. type CMOS; approx. 16.76 million total pixels
Lens	NIKKOR lens with 12x optical zoom
Focal length	4.5–54.0 mm (angle of view equivalent to that of 25–300 mm lens in 35mm [135] format)
f/-number	f/3.3–6.3
Construction	9 elements in 7 groups (1 ED lens element)
Digital zoom magnification	Up to 4x (angle of view equivalent to that of approx. 1200 mm lens in 35mm [135] format)
Vibration reduction	Lens shift (still images) Lens shift and electronic VR (movies)
Motion blur reduction	Motion detection (still images)
Autofocus (AF)	Contrast-detect AF
Focus range	<ul style="list-style-type: none">• [W]: Approx. 50 cm (1 ft 8 in.)–∞, [T]: Approx. 1.5 m (5 ft)–∞• Macro mode: Approx. 2 cm (0.8 in.)–∞ (wide-angle position) (All distances measured from center of front surface of lens)
Focus-area selection	Face priority, center, manual (focus area can be selected using the touch panel), subject tracking, target finding AF
Monitor	7.5 cm (3-in.), approx. 460k-dot, TFT LCD with anti-reflection coating and 5-level brightness adjustment
Frame coverage (shooting mode)	Approx. 98% horizontal and vertical (compared to actual picture)
Frame coverage (playback mode)	Approx. 99% horizontal and vertical (compared to actual picture)

Storage		
Media	Internal memory (approx. 30 MB), SD/SDHC/SDXC memory card	
File system	DCF and Exif 2.3 compliant	
File formats	Still images: JPEG Sound files (Voice Memo): WAV Movies: MOV (Video: H.264/MPEG-4 AVC, Audio: LPCM stereo)	
Image size (pixels)	<ul style="list-style-type: none"> • 16M (High) [4608 × 3456★] • 16M [4608 × 3456] • 8M [3264 × 2448] • 4M [2272 × 1704] • 2M [1600 × 1200] • VGA [640 × 480] • 16:9 [4608 × 2592] • 1:1 [3456 × 3456] 	
ISO sensitivity (Standard output sensitivity)	<ul style="list-style-type: none"> • ISO 125–1600 • ISO 3200, 6400 (available when using Auto mode) 	
Exposure		
Metering mode	Matrix, center-weighted (digital zoom less than 2×), spot (digital zoom 2× or more)	
Exposure control	Programmed auto exposure and exposure compensation (–2.0 – +2.0 EV in steps of $\frac{1}{3}$ EV)	
Shutter		
Speed	<ul style="list-style-type: none"> • $\frac{1}{2000}$–1 s • $\frac{1}{4000}$ s (maximum speed during high-speed continuous shooting) • 4 s (Fireworks show scene mode) 	
Aperture		
Range	Electronically-controlled ND filter (–2 AV) selection 2 steps (f/3.3 and f/6.6 [W])	
Self-timer		Can be selected from 10 s and 2 s
Flash		
Range (approx.) (ISO sensitivity: Auto)	[W]: 0.5–2.8 m (1 ft 8 in.–9 ft 2 in.) [T]: 1.5 m (4 ft 11 in.)	
Flash control		TTL auto flash with monitor preflashes

Interface	
USB connector	Micro-USB connector (do not use any USB cable other than the UC-E21), Hi-Speed USB <ul style="list-style-type: none"> • Supports Direct Print (PictBridge)
HDMI output connector	HDMI micro connector (Type D)
Wi-Fi (Wireless LAN)	
Standards	IEEE 802.11b/g/n (standard wireless LAN protocol)
Communications protocols	IEEE 802.11b: DBPSK/DQPSK/CCK IEEE 802.11g: OFDM IEEE 802.11n: OFDM
Range (line of sight)	Approx. 10 m (10 yd)
Operating frequency	2412–2462 MHz (1–11 channels)
Data rates (actual measured values)	IEEE 802.11b: 5 Mbps IEEE 802.11g: 20 Mbps IEEE 802.11n: 20 Mbps
Security	WPA2
Access protocols	Infrastructure
Supported languages	Arabic, Bengali, Bulgarian, Chinese (Simplified and Traditional), Czech, Danish, Dutch, English, Finnish, French, German, Greek, Hindi, Hungarian, Indonesian, Italian, Japanese, Korean, Marathi, Norwegian, Persian, Polish, Portuguese (European and Brazilian), Romanian, Russian, Serbian, Spanish, Swedish, Tamil, Telugu, Thai, Turkish, Ukrainian, Vietnamese
Power sources	One Rechargeable Li-ion Battery EN-EL19 (included) AC Adapter EH-62G (available separately)
Charging time	Approx. 2 h (when using Charging AC Adapter EH-71P/EH-71PCH and when no charge remains)
Battery life¹	
Still images	Approx. 190 shots when using EN-EL19
Movies (actual battery life for recording) ²	Approx. 40 min when using EN-EL19
Tripod socket	1/4 (ISO 1222)
Dimensions (W × H × D)	Approx. 99.4 × 58.0 × 27.9 mm (4.0 × 2.3 × 1.1 in.) (excluding projections)
Weight	Approx. 181 g (6.4 oz) (including battery and memory card)

Operating environment

Temperature	0°C–40°C (32°F–104°F)
Humidity	85% or less (no condensation)

- Unless otherwise stated, all figures assume a fully-charged battery and an ambient temperature of 23 ±3°C (73.4 ±5.4°F) as specified by the Camera and Imaging Products Association (CIPA).
- ¹ Battery life may vary depending on conditions of use, such as the interval between shots or the length of time that menus and images are displayed.
 - ² Individual movie files cannot exceed 4 GB in size or 29 minutes in length. Recording may end before this limit is reached if camera temperature becomes elevated.

Rechargeable Li-ion Battery EN-EL19

Type	Rechargeable lithium-ion battery
Rated capacity	DC 3.7 V, 700 mAh
Operating temperature	0°C–40°C (32°F–104°F)
Dimensions (W × H × D)	Approx. 31.5 × 39.5 × 6 mm (1.3 × 1.6 × 0.3 in.)
Weight	Approx. 14.5 g (0.5 oz)

Charging AC Adapter EH-71P/EH-71PCH

Rated input	AC 100–240 V, 50/60 Hz, MAX 0.2 A
Rated output	DC 5.0 V, 1.0 A
Operating temperature	0°C–40°C (32°F–104°F)
Dimensions (W × H × D)	Approx. 55 × 22 × 54 mm (2.2 × 0.9 × 2.2 in.) (excluding plug adapter) For Argentina: Approx. 55 × 63 × 59 mm (2.2 × 2.5 × 2.4 in.) For Korea: Approx. 55 × 67 × 59 mm (2.2 × 2.7 × 2.4 in.)
Weight	Approx. 48 g (1.7 oz) (excluding plug adapter) For Argentina: Approx. 73 g (2.6 oz) For Korea: Approx. 70 g (2.5 oz)

- Nikon will not be held liable for any errors this manual may contain.
- The appearance of this product and its specifications are subject to change without notice.

Approved Memory Cards

The following Secure Digital (SD) memory cards have been tested and approved for use in this camera.

- Memory cards with an SD Speed Class rating of 6 or faster are recommended for recording movies. When using a memory card with a lower Speed Class rating, movie recording may stop unexpectedly.

	SD memory card	SDHC memory card	SDXC memory card
SanDisk	2 GB	4 GB, 8 GB, 16 GB, 32 GB	64 GB, 128 GB
TOSHIBA	–	4 GB, 8 GB, 16 GB, 32 GB	64 GB
Panasonic	2 GB	4 GB, 8 GB, 16 GB, 32 GB	64 GB
Lexar	–	4 GB, 8 GB, 16 GB, 32 GB	64 GB, 128 GB

- Contact the manufacturer for details on the above cards. We cannot guarantee camera performance when using memory cards made by other manufacturers.
- If you use a card reader, make sure that it is compatible with your memory card.

Trademark Information

- Microsoft, Windows and Windows Vista are either registered trademarks or trademarks of Microsoft Corporation in the United States and/or other countries.
- Mac, OS X, the iFrame logo and the iFrame symbol are trademarks or registered trademarks of Apple Inc., in the U.S. and other countries.
- Adobe, the Adobe logo, and Reader are either trademarks or registered trademarks of Adobe Systems Incorporated in the United States and/or other countries.
- SDXC, SDHC, and SD Logos are trademarks of SD-3C, LLC.



- PictBridge is a trademark.

- HDMI, HDMI logo and High-Definition Multimedia Interface are trademarks or registered trademarks of HDMI Licensing LLC.

HDMI

- Wi-Fi and the Wi-Fi logo are trademarks or registered trademarks of the Wi-Fi Alliance.
- Android and Google Play are trademarks or registered trademarks of Google, Inc.
- The N-Mark is a trademark or registered trademark of NFC Forum, Inc. in the United States and in other countries.
- All other trade names mentioned in this manual or the other documentation provided with your Nikon product are the trademarks or registered trademarks of their respective holders.

AVC Patent Portfolio License

This product is licensed under the AVC Patent Portfolio License for the personal and non-commercial use of a consumer to (i) encode video in compliance with the AVC standard (“AVC video”) and/or (ii) decode AVC video that was encoded by a consumer engaged in a personal and non-commercial activity and/or was obtained from a video provider licensed to provide AVC video. No license is granted or shall be implied for any other use. Additional information may be obtained from MPEG LA, L.L.C. See <http://www.mpegla.com>.

FreeType License (FreeType2)

















- Portions of this software are copyright © 2012 The FreeType Project (<http://www.freetype.org>). All rights reserved.

MIT License (HarfBuzz)

- Portions of this software are copyright © 2014 The HarfBuzz Project (<http://www.freedesktop.org/wiki/Software/HarfBuzz>). All rights reserved.

Index

Symbols



-  Scene auto selector mode 15, 24
-  Scene mode 25
-  Special effects mode 34
-  Smart portrait mode 36
-  Glamour mode 37
-  Auto mode 39
-  Playback mode 19
-  Favorite pictures mode 60
-  Auto sort mode 64
-  List by date mode 65
-  Wi-Fi options menu 87, 123
-  N-Mark 2, 142
-  Setup menu 87, 125
- T** (Telephoto) 17
- W** (Wide-angle) 17
-  Playback zoom 58
-  Thumbnail playback 59
-  (movie-record) button 1, 23
-  Menu icon 87, 89, 105, 108, 109, 116, 123, 125

A

- AC adapter 145, 172
- Adding favorites pictures 60
- AF area mode 101
- AF assist 1, 133
- Album 63
- Aperture value 17
- Auto flash 44
- Auto mode 22, 39
- Auto off 16, 134
- Auto rotate screen 9
- Auto sort mode 64
- Auto with red-eye reduction 44
- Autofocus 82, 104, 120







- Autofocus mode 104, 120









B







- Backlighting  25, 29
- Battery 10, 11, 14
- Battery chamber 172
- Battery charger 12, 172
- Battery latch 10
- Battery level indicator 14
- Battery-chamber/memory card slot cover 2
- Beach  25
- Best Shot Selector 28, 97
- Black and white copy  25, 29
- Black-and-white 100
- Blink proof 107
- Blink warning 138
- Brightness 128
- BSS 28, 97
- Built-in microphone (stereo) 1
- Button sound 134

C

- Calendar Display 59
- Camera stand 2, 3
- Capturing still images while recording movies 83
- Charge by computer 137
- Charging AC Adapter 176
- Choose key picture 66, 114
- Close-up  25, 28
- Cloudy 94
- Color options 100
- Compression ratio 89
- Computer 146, 152
- Connecting to smart devices 123, 142

Connector cover.....	1	Fixed range auto.....	99
Continuous.....	96	Flash.....	1, 43
Copying images.....	113	Flash indicator.....	43
Crop.....	79	Flash mode.....	43, 44
Cross process 	34	Flash off.....	44
Current settings.....	123	Fluorescent.....	94
Cyanotype.....	100	Focus.....	101
D		Focus area.....	50
Date and time.....	13, 126	Focus indicator.....	6, 16
Date format.....	13, 126	Focus lock.....	54
Date stamp.....	130	Food 	25, 28
Daylight.....	94	Format internal memory.....	135
Daylight saving time.....	126	Format memory cards.....	10, 135
Delete.....	20, 67, 112	Formatting.....	10, 135
Digital zoom.....	17, 133	Frame rate.....	122
Direct print.....	148	Front shutter-release button...	1, 18
D-Lighting.....	70	Full-frame playback.....	19
Dragging.....	4	Full-time AF.....	104, 120
Draw 	25, 29	Functions that cannot be used simultaneously.....	55
Dusk/dawn 	25	G	
E		Glamour mode.....	37
Easy panorama 	25, 31	Glamour mode menu.....	87, 108
Easy panorama playback.....	33	Glamour retouch.....	71
Editing images.....	68	H	
EH-71P/EH-71PCH.....	176	HDMI.....	136
EN-EL19.....	176	HDMI cable.....	146, 147
Exposure compensation.....	47	HDMI micro connector.....	1, 145
Eye-Fi upload.....	139	HDR.....	29
Eyelet for camera strap.....	1	Help.....	25
E		High key HIGH	34
Face detection.....	50	High-contrast monochrome 	34
Face priority.....	101	High-speed continuous.....	96
Favorite pictures mode.....	60	HS movie.....	117, 119
File names.....	171	I	
Fill flash.....	44	Image mode.....	89
Fireworks show 	25, 29		
Firmware version.....	140		

- Image review 128
- Image size 89
- Imprinting date and time 130
- Incandescent 94
- Internal memory 10
- Internal memory indicator 7, 9
- Interval 108
- ISO sensitivity 99
- L**
- Landscape  25
- Language 136
- Lens 1, 173
- Lens cover 1
- List by date mode 65
- Low key **LOW** 34
- M**
- Macro mode 46
- Mark for Wi-Fi upload 109
- Memory card 158, 177
- Memory card slot 10
- Micro-USB connector 1, 145
- Mirror  34
- Monitor 2, 6, 159
- Monitor settings 128
- Motion detection 132
- Movie editing 85, 86
- Movie menu 87, 116
- Movie options 116
- Movie recording 23, 80
- Movie VR 121
- Multi-shot 16 97
- Museum  25, 28
- N**
- NFC 2, 142, 144
- Night landscape  25, 28
- Night portrait  25, 27
- Nikon Transfer 2 153
- Nostalgic sepia **SEPIA** 34
- Number of exposures remaining 14, 90
- Number of shots 108
- O**
- Open with HS footage 119, 120
- Optical zoom 17
- Optional accessories 172
- Options 123
- P**
- Paint 73
- Paper size 149, 150
- Party/indoor  25, 27
- Perspective control 76
- Pet portrait auto release 30
- Pet portrait  25, 30
- Photo info 128
- Photo VR 131
- PictBridge 146, 148
- Playback 19, 66, 84, 112
- Playback menu 87, 109
- Playback mode 19
- Playback zoom 58
- Pop **POP** 34
- Portrait  25
- Power connector cover 2
- Power switch 1
- Power-on lamp 1
- Preset manual 95
- Pre-shooting cache 96, 98
- Pressing halfway 17
- Print 146, 149, 150
- Printer 146, 148
- Protect 111
- Q**
- Quick effects 40, 68, 104
- Quick retouch 69

R	
Rechargeable Li-ion battery	176
Recording slow motion movies	117, 119
Red-eye correction.....	70
Remaining movie recording time	80, 81
Removing favorite pictures	62
Reset all	140
Restore default settings	123
Rotate image	111
S	
Scene auto selector mode....	15, 24
Scene effects.....	26
Scene mode	25
SD memory card.....	158, 177
Selective color 	34
Selective Softening	77
Self-collage.....	38, 108
Self-timer	45
Self-timer lamp	1, 45
Sepia.....	100
Sequence display options	66, 114
Setup menu.....	87, 125
Shooting	15, 22
Shooting menu	87, 89
Shooting mode	22
Shutter sound.....	108, 134
Shutter speed.....	17
Shutter-release button	1
Single.....	96
Single AF.....	104, 120
Skin softening.....	37, 51, 71, 105
Slide show	110
Slow sync	44
Small picture	78
Smart portrait menu.....	87, 105
Smart portrait mode.....	36
Smile timer	106
Snow 	25
Soft SOFT	34
Sound settings	134
Speaker	1
Special effects mode	34
Sports 	25, 27
Standard color.....	100
Strap.....	ii
Stretch.....	75
Subject tracking	93, 102, 103
Sunset 	25
Super vivid VIVID	34
T	
Tapping	4
Target finding AF.....	52, 102
Telephoto.....	17
Televisions.....	146, 147
Thumbnail display	59
Time difference	126
Time zone.....	14, 126
Time zone and date.....	13, 126
Touch AF.....	93
Touch shooting	18, 91
Touch shutter	92
Toy camera effect 1 	34
Toy camera effect 2 	34
Tripod socket.....	2, 175
U	
Upload from camera	123
USB cable.....	146, 148, 152
V	
ViewNX 2.....	152
Vivid color.....	100
Voice memo	112
Volume.....	84, 112

W

Welcome screen	125
White balance	94
Wide-angle.....	17
Wi-Fi button	1, 142, 144
Wi-Fi disconnection.....	123, 143
Wi-Fi options menu	87, 123
Wind noise reduction	122
Wireless LAN.....	141
Wireless Mobile Utility.....	141

Z

Zoom control	1, 17
Zooming in/out	17

No reproduction in any form of this manual, in whole or in part (except for brief quotation in critical articles or reviews), may be made without written authorization from NIKON CORPORATION.