

Nikon

DIGITAL CAMERA

COOLPIX S6300

Reference Manual



En

Trademark Information

- Microsoft, Windows and Windows Vista are either registered trademarks or trademarks of Microsoft Corporation in the United States and/or other countries.
- Macintosh, Mac OS, and QuickTime are trademarks of Apple Inc., registered in the U.S. and other countries. The iFrame logo and the iFrame symbol are trademarks of Apple Inc.
- Adobe and Acrobat are registered trademarks of Adobe Systems Inc.
- SDXC, SDHC and SD Logos are trademarks of SD-3C, LLC.
- PictBridge is a trademark.
- HDMI, **HDMI** logo and High-Definition Multimedia Interface are trademarks or registered trademarks of HDMI Licensing LLC.
- All other trade names mentioned in this manual or the other documentation provided with your Nikon product are trademarks or registered trademarks of their respective holders.

AVC Patent Portfolio License

This product is licensed under the AVC Patent Portfolio License for the personal and non-commercial use of a consumer to (i) encode video in compliance with the AVC standard ("AVC video") and/or (ii) decode AVC video that was encoded by a consumer engaged in a personal and non-commercial activity and/or was obtained from a video provider licensed to provide AVC video. No license is granted or shall be implied for any other use. Additional information may be obtained from MPEG LA, L.L.C.

See <http://www.mpegla.com>.

Introduction

Parts of the Camera and Basic Operations

The Basics of Shooting and Playback

Shooting Features

Playback Features

Recording and Playing Back Movies

General Camera Setup

Reference Section

Technical Notes and Index

Read This First

Thank you for purchasing the Nikon COOLPIX S6300 digital camera. Before using the camera, please read the information in "For Your Safety" (18) and familiarize yourself with the information provided in this manual. After reading, please keep this manual handy and refer to it to enhance your enjoyment of your new camera.

Confirming the Package Contents

In the event that any items are missing, please contact the store where you purchased the camera.



COOLPIX S6300
Digital Camera



Camera Strap



Rechargeable Li-ion Battery
EN-EL12
(with terminal cover)

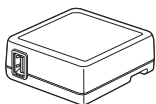

Charging AC Adapter
EH-69P*

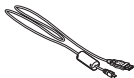

USB Cable UC-E6

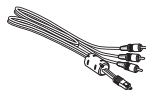

Audio Video Cable EG-CP16



ViewNX 2 Installer CD



Reference Manual CD

- Warranty

* A plug adapter is included if the camera was purchased in a country or region that requires a plug adapter. The shape of the plug adapter varies with the country or region of purchase (18).

NOTE: A memory card is not included with the camera.

About This Manual





If you want to start using the camera right away, see “The Basics of Shooting and Playback” (📖15).

To learn about the parts of the camera and basic operations, see “Parts of the Camera and Basic Operations” (📖1).

Other Information

- Symbols and Conventions

To make it easier to find the information you need, the following symbols and conventions are used in this manual:

Symbol	Description
	This icon indicates cautions and information that should be read before using the camera.
	This icon indicates notes and information that should be read before using the camera.
	These icons indicate other pages containing relevant information;  : “Reference Section”,  : “Technical Notes and Index.”

- SD and SDHC/SDXC memory cards are referred to as “memory cards” in this manual.
- The setting at the time of purchase is referred to as the “default setting.”
- The names of menu items displayed in the camera monitor, and the names of buttons or messages displayed on a computer monitor appear in bold.
- In this manual, images are sometimes omitted from monitor display samples so that monitor indicators can be more clearly shown.
- Illustrations and monitor content shown in this manual may differ from the actual product.

Information and Precautions

Life-Long Learning

As part of Nikon's "Life-Long Learning" commitment to ongoing product support and education, continually updated information is available online at the following sites:

- For users in the U.S.A.: <http://www.nikonusa.com/>
- For users in Europe and Africa: <http://www.europe-nikon.com/support/>
- For users in Asia, Oceania, and the Middle East: <http://www.nikon-asia.com/>

Visit these sites to keep up-to-date with the latest product information, tips, answers to frequently asked questions (FAQs), and general advice on digital imaging and photography. Additional information may be available from the Nikon representative in your area. Visit the site below for contact information:

<http://imaging.nikon.com/>

Use Only Nikon Brand Electronic Accessories

Nikon COOLPIX cameras are designed to the highest standards and include complex electronic circuitry. Only Nikon brand electronic accessories (including battery chargers, batteries, Charging AC adapters, and AC adapters) certified by Nikon specifically for use with this Nikon digital camera are engineered and proven to operate within the operational and safety requirements of this electronic circuitry.

THE USE OF NON-NIKON ELECTRONIC ACCESSORIES COULD DAMAGE THE CAMERA AND MAY VOID YOUR NIKON WARRANTY.

The use of third-party rechargeable Li-ion batteries not bearing the Nikon holographic seal could interfere with normal operation of the camera or result in the batteries overheating, igniting, rupturing, or leaking.

For more information about Nikon brand accessories, contact a local authorized Nikon dealer.

Holographic seal: Identifies this device as an authentic Nikon product.



Before Taking Important Pictures

Before taking pictures on important occasions (such as at weddings or before taking the camera on a trip), take a test shot to ensure that the camera is functioning normally. Nikon will not be held liable for damages or lost profits that may result from product malfunction.

About the Manuals

- No part of the manuals included with this product may be reproduced, transmitted, transcribed, stored in a retrieval system, or translated into any language in any form, by any means, without Nikon's prior written permission.
- Nikon reserves the right to change the specifications of the hardware and software described in these manuals at any time and without prior notice.
- Nikon will not be held liable for any damages resulting from the use of this product.

- While every effort was made to ensure that the information in these manuals is accurate and complete, we would appreciate it were you to bring any errors or omissions to the attention of the Nikon representative in your area (address provided separately).

Notice Concerning Prohibition of Copying or Reproduction

Note that simply being in possession of material that was digitally copied or reproduced by means of a scanner, digital camera or other device may be punishable by law.

• Items prohibited by law from being copied or reproduced

Do not copy or reproduce paper money, coins, securities, government bonds or local government bonds, even if such copies or reproductions are stamped "Sample." The copying or reproduction of paper money, coins, or securities which are circulated in a foreign country is prohibited. Unless the prior permission of the government was obtained, the copying or reproduction of unused postage stamps or post cards issued by the government is prohibited.

The copying or reproduction of stamps issued by the government and of certified documents stipulated by law is prohibited.

• Cautions on certain copies and reproductions

The government has issued cautions on copies or reproductions of securities issued by private companies (shares, bills, checks, gift certificates, etc.), commuter passes, or coupon tickets, except when a minimum of necessary copies are to be provided for business use by a company. Also, do not copy or reproduce passports issued by the government, licenses issued by public agencies and private groups, ID cards and tickets, such as passes and meal coupons.

• Comply with copyright notices

The copying or reproduction of copyrighted creative works such as books, music, paintings, woodcut prints, maps, drawings, movies, and photographs is governed by national and international copyright laws. Do not use this product for the purpose of making illegal copies or to infringe copyright laws.

Disposing of Data Storage Devices

Please note that deleting images or formatting data storage devices such as memory cards or built-in camera memory does not completely erase the original image data. Deleted files can sometimes be recovered from discarded storage devices using commercially available software, potentially resulting in the malicious use of personal image data. Ensuring the privacy of such data is the user's responsibility.

Before discarding a data storage device or transferring ownership to another person, erase all data using commercial deletion software, or format the device and then completely refill it with images containing no private information (for example, pictures of empty sky). Be sure to also replace any pictures selected for the **Select an image** option in the **Welcome screen** setting (📖94). Care should be taken to avoid injury or damage to property when physically destroying data storage devices.

For Your Safety

To prevent damage to your Nikon product or injury to yourself or to others, read the following safety precautions in their entirety before using this equipment. Keep these safety instructions where all those who use the product will read them. The consequences that could result from failure to observe the precautions listed in this section are indicated by the following symbol:



This icon marks warnings, information that should be read before using this Nikon product, to prevent possible injury.

WARNINGS

Turn off in the event of malfunction

Should you notice smoke or an unusual smell coming from the camera or Charging AC Adapter, unplug the Charging AC Adapter and remove the battery immediately, taking care to avoid burns. Continued operation could result in injury. After removing or disconnecting the power source, take the equipment to a Nikon-authorized service representative for inspection.

Do not disassemble

Touching the internal parts of the camera or Charging AC Adapter could result in injury. Repairs should be performed only by qualified technicians. Should the camera or Charging AC Adapter break open as the result of a fall or other accident, take the product to a Nikon-authorized service representative for inspection, after unplugging the product and/or removing the battery.

Do not use the camera or Charging AC Adapter in the presence of flammable gas

Do not use electronic equipment in the presence of flammable gas, as this could result in explosion or fire.

Handle the camera strap with care

Never place the strap around the neck of an infant or child.

Keep out of reach of children

Particular care should be taken to prevent infants from putting the battery or other small parts into their mouths.

Do not remain in contact with the camera, battery charger, or AC adapter for extended periods while the devices are on or in use

Parts of the devices become hot. Leaving the devices in direct contact with the skin for extended periods may result in low-temperature burns.

Observe caution when handling the battery

The battery may leak, overheat, or explode if improperly handled. Observe the following precautions when handling the battery for use in this product:

- Before replacing the battery, turn the product off. If you are using the Charging AC Adapter/AC adapter, be sure it is unplugged.
 - Use only a Rechargeable Li-ion Battery EN-EL12 (included). Charge the battery by using a camera that supports battery charging or by using a Battery Charger MH-65 (available separately). To charge the battery with the camera, use either Charging AC Adapter EH-69P (included) or the **Charge by computer** function.
 - When inserting the battery, do not attempt to insert it upside down or backwards.
 - Do not short or disassemble the battery or attempt to remove or break the battery insulation or casing.
 - Do not expose the battery to flame or to excessive heat.
 - Do not immerse in or expose to water.
 - Replace the terminal cover before transporting it. Do not transport or store with metal objects such as necklaces or hairpins.
 - The battery is prone to leakage when fully discharged. To avoid damage to the product, be sure to remove the battery when no charge remains.
 - Discontinue use immediately should you notice any change in the battery, such as discoloration or deformation.
- If liquid from the damaged battery comes in contact with clothing or skin, rinse immediately with plenty of water.

Observe the following precautions when handling the Charging AC Adapter

- Keep dry. Failure to observe this precaution could result in fire or electric shock.
- Dust on or near the metal parts of the plug should be removed with a dry cloth. Continued use could result in fire.
- Do not handle the plug or go near the Charging AC Adapter during lightning storms. Failure to observe this precaution could result in electric shock.
- Do not damage, modify, forcibly tug or bend the USB cable, place it under heavy objects, or expose it to heat or flames. Should the insulation be damaged and the wires become exposed, take it to a Nikon-authorized service representative for inspection. Failure to observe these precautions could result in fire or electric shock.
- Do not handle the plug or Charging AC Adapter with wet hands. Failure to observe this precaution could result in electric shock.
- Do not use with travel converters or adapters designed to convert from one voltage to another or with DC-to-AC inverters. Failure to observe this precaution could damage the product or cause overheating or fire.

 **Use appropriate cables**

When connecting cables to the input and output jacks, use only the cables provided or sold by Nikon for the purpose, to maintain compliance with product regulations.

 **Handle moving parts with care**

Be careful that your fingers or other objects are not pinched by the lens cover or other moving parts.

 **CD-ROMs**

The CD-ROMs included with this device should not be played back on audio CD equipment. Playing CD-ROMs on an audio CD player could cause hearing loss or damage the equipment.

 **Observe caution when using the flash**

Using the flash close to your subject's eyes could cause temporary visual impairment. Particular care should be observed if photographing infants, when the flash should be no less than 1 m (3 ft 4 in.) from the subject.

 **Do not operate the flash with the flash window touching a person or object**

Failure to observe this precaution could result in burns or fire.

 **Avoid contact with liquid crystal**

Should the monitor break, care should be taken to avoid injury caused by broken glass and to prevent liquid crystal from the monitor touching the skin or entering the eyes or mouth.

 **Turn the power off when using inside an airplane or the hospital**

Turn the power off while inside the airplane during take off or landing. Follow the instructions of the hospital when using while in a hospital. The electromagnetic waves given out by this camera may disrupt the electronic systems of the airplane or the instruments of the hospital.

 **3D Images**

Do not continuously view 3D images recorded with this device for extended periods, whether on a television, monitor, or other display.

In the case of children whose visual systems are still maturing, consult a pediatrician or ophthalmologist prior to use and follow their instructions.

Prolonged viewing of 3D images may cause eye strain, nausea, or discomfort. Cease use should any of these symptoms occur and consult a physician if necessary.

Notices

Notices for Customers in the U.S.A.

IMPORTANT SAFETY INSTRUCTIONS -

SAVE THESE INSTRUCTIONS.

DANGER - TO REDUCE THE RISK OF FIRE OR ELECTRIC SHOCK, CAREFULLY FOLLOW THESE INSTRUCTIONS

For connection to a supply not in the U.S.A., use an attachment plug adapter of the proper configuration for the power outlet if needed.

The power supply unit is intended to be correctly orientated in a vertical or floor mount position.

Federal Communications Commission (FCC) Radio Frequency Interference Statement

This equipment has been tested and found to comply with the limits for a Class B digital device, pursuant to Part 15 of the FCC rules. These limits are designed to provide reasonable protection against harmful interference in a residential installation. This equipment generates, uses, and can radiate radio frequency energy and, if not installed and used in accordance with the instructions, may cause harmful interference to radio communications. However, there is no guarantee that interference will not occur in a particular installation. If this

equipment does cause harmful interference to radio or television reception, which can be determined by turning the equipment off and on, the user is encouraged to try to correct the interference by one or more of the following measures:

- Reorient or relocate the receiving antenna.
- Increase the separation between the equipment and receiver.
- Connect the equipment into an outlet on a circuit different from that to which the receiver is connected.
- Consult the dealer or an experienced radio/television technician for help.



Nikon

COOLPIX S6300

CAUTIONS

Modifications

The FCC requires the user to be notified that any changes or modifications made to this device that are not expressly approved by Nikon Corporation may void the user's authority to operate the equipment.

Interface Cables

Use the interface cables sold or provided by Nikon for your equipment. Using other interface cables may exceed the limits of Class B Part 15 of the FCC rules.

Notice for customers in the State of California

WARNING

Handling the cord on this product will expose you to lead, a chemical known to the State of California to cause birth defects or other reproductive harm.

Wash hands after handling.

Nikon Inc.,
1300 Walt Whitman Road
Melville, New York 11747-3064
USA
Tel: 631-547-4200

Notice for customers in Canada

CAUTION

This Class B digital apparatus complies with Canadian ICES-003.

ATTENTION

Cet appareil numérique de la classe B est conforme à la norme NMB-003 du Canada.

Notices for customers in Europe

CAUTIONS

RISK OF EXPLOSION IF BATTERY IS REPLACED BY AN INCORRECT TYPE.

DISPOSE OF USED BATTERIES ACCORDING TO THE INSTRUCTIONS.

This symbol indicates that this product is to be collected separately.



The following apply only to users in European countries:

- This product is designated for separate collection at an appropriate collection point. Do not dispose of as household waste.
- For more information, contact the retailer or the local authorities in charge of waste management.

This symbol on the battery indicates that the battery is to be collected separately.







































The following apply only to users in European countries:



















































- All batteries, whether marked with this symbol or not, are designated for separate collection at an appropriate collection point. Do not dispose of as household waste.
- For more information, contact the retailer or the local authorities in charge of waste management.

Table of Contents

Introduction	ii
Read This First	ii
Confirming the Package Contents	ii
About This Manual	iii
Information and Precautions	iv
For Your Safety	vi
WARNINGS	vi
Notices	ix
<hr/>	
Parts of the Camera and Basic Operations	1
Parts of the Camera	2
The Camera Body	2
Controls Used in Shooting Mode	4
Controls Used in Playback Mode	5
The Monitor	6
Basic Operations	9
Switching Between Shooting Mode and Playback Mode	9
Using the Rotary Multi Selector	10
Using Menus (the MENU Button)	11
Attaching the Camera Strap	13
<hr/>	
The Basics of Shooting and Playback	15
Preparation 1 Insert the Battery	16
Preparation 2 Charge the Battery	18
Preparation 3 Insert a Memory Card	20
Internal Memory and Memory Cards	21
Approved Memory Cards	21
Step 1 Turn the Camera On	22
Turning the Camera On and Off	23
Setting the Display Language, Date, and Time	24
Step 2 Select a Shooting Mode	26
Available Shooting Modes	27
Step 3 Frame a Picture	28
Using the Zoom	29
Step 4 Focus and Shoot	30
Step 5 Play Back Images	32
Changing How Images Are Displayed	33
Step 6 Delete Unwanted Images	34

Shooting Features	37
📷 (Auto) Mode	38
Changing 📷 (Auto) Mode Settings	38
Options Available in the Auto Shooting Menu.....	39
Scene Mode (Shooting Suited to Scenes)	41
Changing Scene Mode Settings.....	41
Characteristics of Each Scene.....	42
Special Effects Mode (Applying Effects When Shooting)	51
Changing Special Effects Mode Settings.....	52
Smart Portrait Mode (Capturing Images of Smiling Faces)	53
Changing Smart Portrait Mode Settings	55
Options Available in the Smart Portrait Menu.....	56
Subject Tracking Mode (Focusing on a Moving Subject)	57
Changing Subject Tracking Mode Settings.....	59
Options Available in the Subject Tracking Menu	59
Features That Can Be Set Using the Multi Selector	61
Available Features	61
Using the Flash (Flash Modes).....	62
Using the Self-timer	64
Using Macro Mode	65
Adjusting Brightness (Exposure Compensation).....	66
Default Settings	67
Changing the Image Size (Image Mode)	69
Image Mode Settings (Image Size and Quality)	69
Features That Cannot Be Used Simultaneously	71
Using Face Detection.....	73
Using Skin Softening.....	75
Focus Lock	76
Playback Features.....	77
Selecting Certain Types of Images for Playback	78
Available Playback Modes	78
Switching Between Playback Modes	78
Features Available in Playback Mode (Playback Menu)	79
Connecting the Camera to a TV, Computer, or Printer	81
Using ViewNX 2	82
Installing ViewNX 2	82
Transferring Images to the Computer	84
Viewing Images.....	85

Recording and Playing Back Movies.....	87
Recording Movies	88
Changing Movie Recording Settings (the Movie Menu)	91
Playing Back Movies.....	92
General Camera Setup.....	93
The Setup Menu	94
Reference Section	 1
Using Easy Panorama (Shooting and Playback)	 2
Shooting with Easy Panorama.....	 2
Viewing Images Captured with Easy Panorama.....	 4
Using 3D Photography	 5
Favorite Pictures Mode	 7
Adding Images to Albums.....	 7
Playing Back Images in Albums.....	 8
Removing Images from Albums	 8
Changing the Favorites Album Icon.....	 9
Auto Sort Mode	 10
Auto Sort Mode Categories.....	 10
List by Date Mode	 12
Viewing and Deleting Images Captured Continuously (Sequence).....	 13
Viewing Images in a Sequence.....	 13
Deleting Images in a Sequence.....	 15
Editing Still Images.....	 16
Editing Features.....	 16
 Quick Retouch: Enhancing Contrast and Saturation.....	 18
 D-Lighting: Enhancing Brightness and Contrast	 18
 Skin Softening: Softening Skin Tones	 19
 Filter Effects: Applying Digital Filter Effects.....	 20
 Small Picture: Reducing the Size of an Image	 21
 Crop: Creating a Cropped Copy.....	 22
Connecting the Camera to a TV (Viewing Images on a TV)	 23
Connecting the Camera to a Printer (Direct Print).....	 25
Connecting the Camera to a Printer.....	 26
Printing Individual Images.....	 27
Printing Multiple Images.....	 28
Recording Movies in Slow Motion and Fast Motion (HS Movie).....	 31
Editing Movies.....	 34

The Shooting Menu (for  (Auto) Mode)	 36
White Balance (Adjusting Hue)	 36
Continuous Shooting	 38
ISO Sensitivity	 41
Color Options	 42
AF Area Mode	 43
Autofocus Mode	 45
The Smart Portrait Menu	 46
Skin Softening	 46
Smile Timer	 46
Blink Proof	 47
The Subject Tracking Menu	 48
Autofocus Mode	 48
Face Priority Tracking	 48
The Playback Menu	 49
 Print Order (Creating a DPOF Print Order)	 49
 Slide Show	 53
 Protect	 54
 Rotate Image	 56
 Voice Memo	 57
 Copy (Copy Between Internal Memory and Memory Card)	 59
 Sequence Display Options	 61
 Choose Key Picture	 61
The Movie Menu	 62
Movie Options	 62
Open with HS Footage	 63
Autofocus Mode	 64
Wind Noise Reduction	 64
The Setup Menu	 65
Welcome Screen	 65
Time Zone and Date	 66
Monitor Settings	 69
Print Date (Imprinting Date and Time)	 71
Vibration Reduction	 72
Motion Detection	 73
AF Assist	 74
Digital Zoom	 74
Sound Settings	 75
Auto Off	 76
Format Memory/Format Card	 77
Language	 78
TV Settings	 79

Charge by Computer.....	80
Blink Warning.....	82
Eye-Fi Upload.....	84
Filmstrip.....	85
Reset All.....	86
Firmware Version.....	89
File and Folder Names.....	90
Optional Accessories.....	91
Error Messages.....	92
<hr/>	
Technical Notes and Index.....	1
Maximizing Camera Life and Performance.....	2
The Camera.....	2
The Battery.....	3
Charging AC Adapter.....	4
Memory Cards.....	4
Cleaning and Storage.....	5
Cleaning.....	5
Storage.....	5
Troubleshooting.....	6
Specifications.....	13
Supported Standards.....	16
Index.....	17



A series of horizontal dashed lines spanning the width of the page, intended for handwriting practice. There are 15 lines in total, starting from the top right and extending to the bottom left.



Parts of the Camera and Basic Operations

This chapter describes the parts of the camera and also explains how to use basic camera features.

Parts of the Camera	2
The Camera Body	2
Controls Used in Shooting Mode	4
Controls Used in Playback Mode	5
The Monitor	6
Basic Operations	9
Switching Between Shooting Mode and Playback Mode	9
Using the Rotary Multi Selector.....	10
Using Menus (the MENU Button)	11
Attaching the Camera Strap	13

➔ If you want to start using the camera right away, see “The Basics of Shooting and Playback” (📖15).

Parts of the Camera

The Camera Body

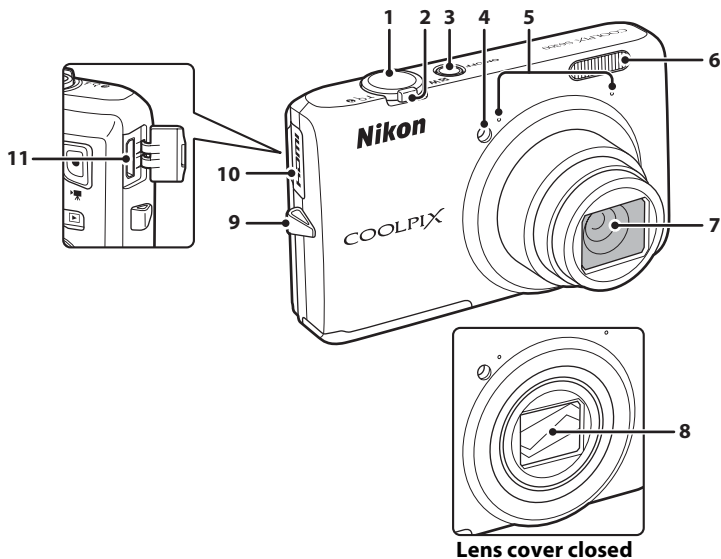

Parts of the Camera and Basic Operations



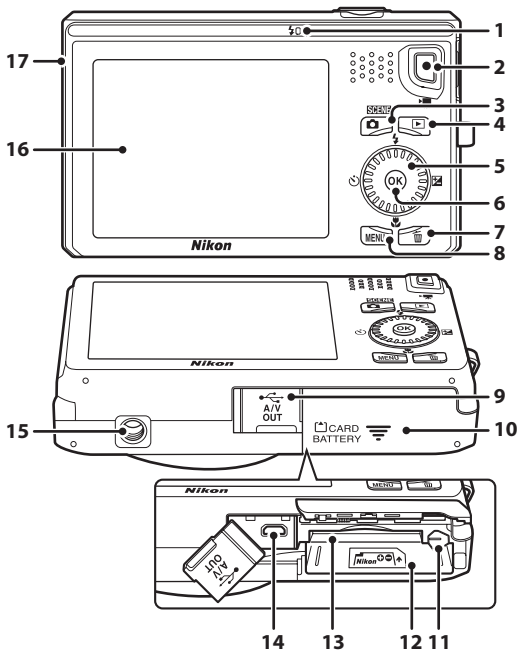





1	Shutter-release button.....4, 5, 30	5	Microphone (stereo).....79, 88
2	Zoom control.....4, 5, 29	6	Flash.....62
	W : wide-angle.....4, 29	7	Lens
	T : telephoto.....4, 29	8	Lens cover
	: thumbnail playback.....5, 33	9	Eyelet for camera strap.....13
	: playback zoom.....5, 33	10	HDMI connector cover.....81
	: help.....41	11	HDMI mini connector (Type C).....81
3	Power switch/power-on lamp.....22		
4	Self-timer lamp.....64		
	AF-assist illuminator.....95		





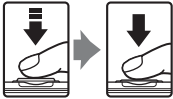







1	Charge lamp.....19, 81
	Flash lamp.....62
2	(movie-record) button.....4, 5, 88
3	(shooting mode) button4, 5, 9, 26
4	(playback) button4, 5, 9, 32, 78
5	Rotary multi selector (multi selector) 10
6	(apply selection) button5, 10
7	(delete) button4, 5, 34, 57
8	MENU (menu) button 4, 5, 11, 39, 79, 91, 94

9	Connector cover 18, 81
10	Battery-chamber/ memory card slot cover..... 16, 17
11	Battery latch16
12	Battery chamber.....16
13	Memory card slot.....20
14	USB/audio/video output connector18, 81
15	Tripod socket
16	Monitor6, 26
17	Speaker.....79, 92

Controls Used in Shooting Mode

Control	Name	Main Function	
	Shooting mode button	Changes the shooting mode (displays the shooting mode selection screen).	26
	Zoom control	Zooms in and out; rotate to T (Q) to zoom in and make the subject larger, and rotate to W (R) to zoom out and view a wider area.	29
	Rotary multi selector	See "Using the Rotary Multi Selector" for more information.	10, 11
	MENU button	Displays and hides the menu.	11, 39, 91, 94
	Shutter-release button	When pressed halfway (i.e., if you stop pressing when you feel resistance): Sets focus and exposure. When pressed all the way: Releases the shutter.	30
	Movie-record button	Starts and stops movie recording.	88
	Playback button	Plays back images.	9, 32, 78, 92
	Delete button	Deletes the last image that was saved.	34

Controls Used in Playback Mode

Control	Name	Main Function	
	Playback button	<ul style="list-style-type: none"> Changes the playback mode (displays the playback mode selection screen). When the camera is off, press and hold this button to turn the camera on in playback mode. 	78 23, 32
	Zoom control	<ul style="list-style-type: none"> When rotated to T (Q): Magnifies the image. When rotated to W (R): Displays thumbnails or the calendar. Adjusts the volume when playing back voice memos and movies. 	33 33 79, 92,  57
	Rotary multi selector	See "Using the Rotary Multi Selector" for more information.	10, 11
	Apply selection button	<ul style="list-style-type: none"> Switches from image thumbnail or zoomed image display to full-frame display. Plays back movies. Displays individual images in a sequence when only the key picture is displayed for the sequence. Performs scroll playback of images captured using Easy panorama. 	33 92 32 48
	MENU button	Displays and hides the menu.	11, 79, 94
	Delete button	Deletes images.	34
	Shooting mode button	Returns to shooting.	–
	Shutter-release button		–
	Movie-record button		–

The Monitor



- The information that is displayed in the monitor during shooting and playback changes depending on the camera's settings and state of use.

By default, information is displayed when the camera is first turned on and when you operate the camera, and turns off after a few seconds (when

Monitor settings (📖94) → **Photo info** is set to **Auto info**).

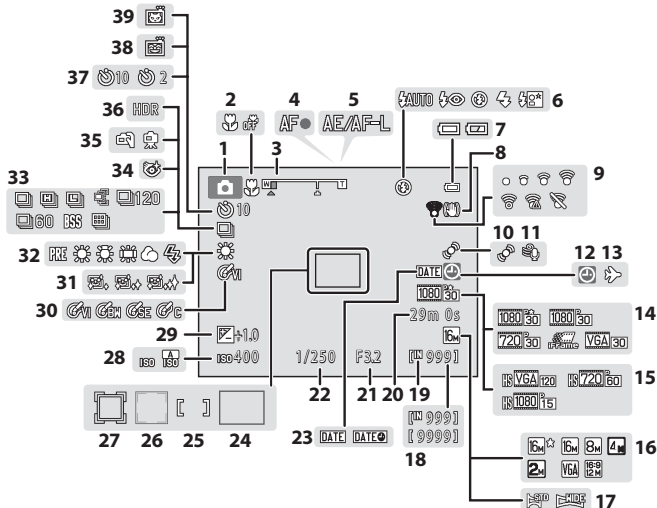
Shooting Mode



1	Shooting mode	26, 27	21	Aperture value.....	30
2	Macro mode	65	22	Shutter speed.....	30
3	Zoom indicator.....	29, 65	23	Print date	95
4	Focus indicator	30	24	Focus area (auto)	30, 40
5	AE/AF-L indicator	 5	25	Focus area (for manual or center)	40
6	Flash mode.....	62	26	Focus area (face detection, pet detection).....	40, 49, 53
7	Battery level indicator	22	27	Focus area (subject tracking mode)	40, 57
8	Vibration reduction icon.....	95	28	ISO sensitivity	39
9	Eye-Fi communication indicator	96	29	Exposure compensation value.....	66
10	Motion detection icon	95	30	Color options.....	40
11	Wind noise reduction	91	31	Skin softening	56
12	“Date not set” indicator	25, 94,  92	32	White balance mode	39
13	Travel destination icon.....	94	33	Continuous shooting mode	39
14	Movie options (normal speed movies)	91	34	Blink proof icon	56
15	Movie options (HS movies)	91	35	Hand-held/tripod	43, 45
16	Image mode	69	36	Backlighting (HDR).....	47
17	Easy panorama.....	48	37	Self-timer indicator	64
18	Number of exposures remaining (still images).....	22	38	Smile timer.....	56
19	Internal memory indicator	22	39	Pet portrait auto release	49
20	Movie length.....	88			

Playback Mode

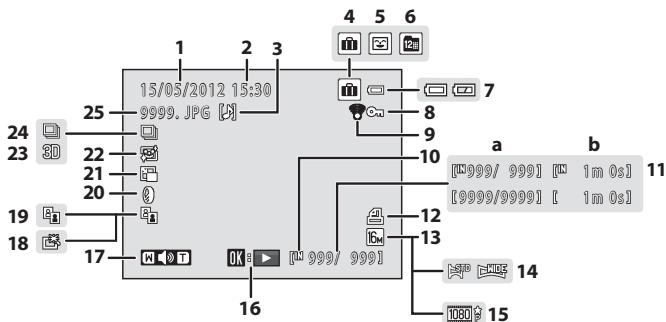



1	Date of recording	24	14	Easy panorama	48
2	Time of recording	24	15	Movie options	91
3	Voice memo indicator	79,	57	Easy panorama playback guide	48,
4	Album icon in favorite pictures mode	78,	7	16	Sequence playback guide
5	Category icon in auto sort mode	78,	10	Movie playback guide	92
6	List by date icon	78,	12	17	Volume indicator
7	Battery level indicator	22	79, 92,	57	18
8	Protect icon	79	79	Quick retouch icon	79
9	Eye-Fi communication indicator	96	19	D-Lighting icon	79
10	Internal memory indicator	32	79	20	Filter effects icon
11	(a) Current image number/ total number of images	32	79	21	Small picture icon
	(b) Movie length	92	79	22	Skin softening icon
12	Print order icon	79	79	23	3D image icon
13	Image mode	69	50	24	Sequence display (when Individual pictures is selected)
			80	25	File number and type
			90		

Basic Operations

Switching Between Shooting Mode and Playback Mode





The camera has two modes of operation: Shooting mode, which is used for taking pictures, and playback mode, which is used for viewing pictures.

To switch to playback mode, press the  (playback) button.

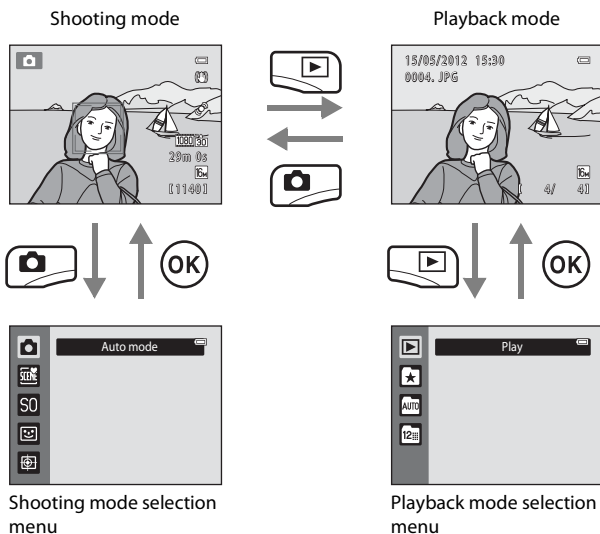
To switch to shooting mode, press the  (shooting mode) button.

- While using playback mode, you can also switch to shooting mode by pressing the shutter-release button or the  (movie-record) button.



- If you press the  (shooting mode) button while using shooting mode, the shooting mode selection menu is displayed, from which you can select one of the available shooting modes ( 27).
- If you press the  (playback) button while using playback mode, the playback mode selection menu is displayed, from which you can select one of the available playback modes ( 78).

Using the Rotary Multi Selector

Rotate the rotary multi selector, press its upper (▲), lower (▼), left (◀), or right (▶), or press the **OK** button.

- The rotary multi selector is sometimes referred to as “the multi selector” in this manual.

In Shooting Mode

Rotate to select an item.*

Displays the ⌚ (self-timer) menu (☞64).

Applies the current selection.

Displays the 📁 (macro mode) menu (☞65).

Displays the ⚡ (flash mode) menu (☞62).

Displays the 📏 (exposure compensation) guide (☞66).

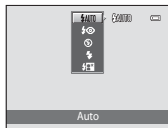

* Items can also be selected by pressing the rotary multi selector up or down.

In Playback Mode

Selects the previous image, moves the displayed area when the image is magnified (☞33).¹

Plays back movies (☞92), etc.²

Selects the next image, moves the displayed area when the image is magnified (☞33).¹

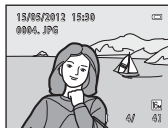

¹ Previous or subsequent images can also be selected by rotating the rotary multi selector.

² When displaying image thumbnails or when the image is magnified, this button switches the camera to full-frame display.

When Displaying Menus

Selects the item to the left, returns to the previous screen.

Applies the current selection (next screen is displayed).

Selects the item below.*

Selects the item above.*

Selects the item to the right, continues to the next screen (current selection is applied).

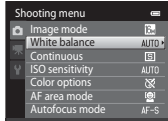

* Items can also be selected by rotating the rotary multi selector.

Using Menus (the MENU Button)

If you press the **MENU** button while the shooting screen or playback screen is displayed, the menu for the current mode is displayed. Once the menu is displayed, you can change various settings.

Shooting mode

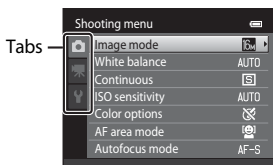
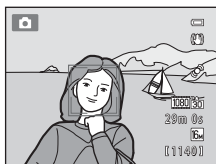

tab:

Displays the settings that can be changed for the current shooting mode (📖26). Depending on the current shooting mode, the tab icon that is displayed will be different.

tab:

Displays movie recording settings.

tab:

Displays the setup menu, where you can change a number of general settings.

Playback mode

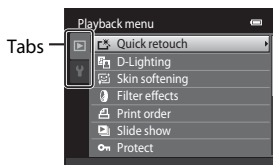
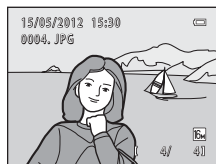

tab:

Displays the settings that can be changed for the current playback mode (📖78). Depending on the current playback mode, the tab icon that is displayed will be different.

tab:

Displays the setup menu, where you can change a number of general settings.

If Tabs Are Not Displayed

If you press the **MENU** button and the screen that allows you to change the image mode is displayed, press the rotary multi selector to display the tabs.

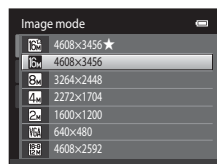

Switching Between Tabs

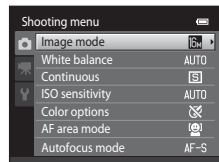

Press the rotary multi selector ◀ to highlight the tab.

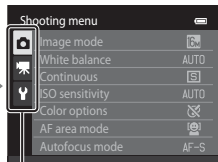

Press the rotary multi selector ▲ or ▼ to select a tab, and press either the **OK** button or ▶.

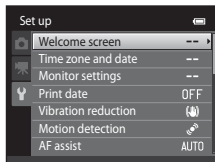

The selected menu is displayed.

Selecting Menu Items

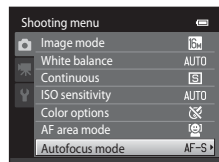

Press the rotary multi selector ▲ or ▼ to select an item, and then press ▶ or the **OK** button.

Items can also be selected by rotating the rotary multi selector.

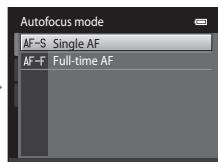

Press ▲ or ▼ to select an item and then press the **OK** button.

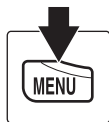

When you are finished changing settings, press the **MENU** button to exit the menu.

When the Menu Contains Two or More Pages

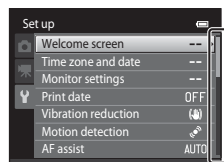

A guide indicating the page position is displayed.

Attaching the Camera Strap

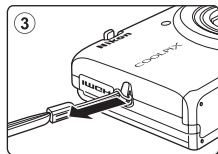
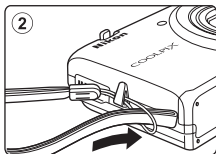
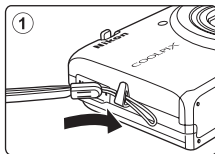



A series of horizontal dashed lines spanning the width of the page, intended for handwriting practice.

The Basics of Shooting and Playback

Preparation

Preparation 1 Insert the Battery	16
Preparation 2 Charge the Battery	18
Preparation 3 Insert a Memory Card	20



Shooting

Step 1 Turn the Camera On	22
Setting the Display Language, Date, and Time (First Use After Purchase)	24
Step 2 Select a Shooting Mode	26
Step 3 Frame a Picture	28
Step 4 Focus and Shoot	30



Playback

Step 5 Play Back Images	32
Step 6 Delete Unwanted Images	34

Preparation 1 Insert the Battery

- 1 Open the battery-chamber/memory card slot cover.

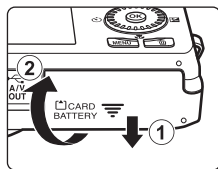

- 2 Insert the included EN-EL12 battery (rechargeable Li-ion battery).

- Use the battery to push the orange battery latch in the direction indicated by the arrow (①), and fully insert the battery (②).
- When the battery is inserted correctly, the battery latch will lock the battery in place.

Battery latch

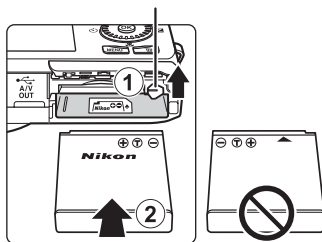

✓ Inserting the Battery Correctly

Inserting the battery upside down or backwards could damage the camera. Be sure to check that the battery is in the correct orientation.

- 3 Close the battery-chamber/memory card slot cover.

- Charge the battery before the first use or when the battery is running low. See “Preparation 2 Charge the Battery” (18) for more information.

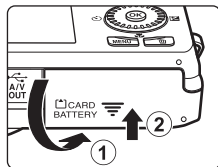

Removing the Battery

Turn the camera off and be sure that the power-on lamp and the monitor have turned off before opening the battery-chamber/memory card slot cover.

To eject the battery, open the battery-chamber/memory card slot cover and slide the orange battery latch up in the direction indicated by the arrow (①). The battery can then be removed by hand (②). Do not pull it at an angle.

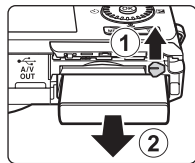

High Temperature Caution

The camera, battery, and memory card may be hot immediately after using the camera. Observe caution when removing the battery or memory card.

Notes About the Battery

Be sure to read and follow the warnings for the battery on page vii and in “The Battery” (ⓘ3) before use.

Preparation 2 Charge the Battery

1 Prepare the included Charging AC Adapter EH-69P.

If a plug adapter* is included with your camera, attach the plug adapter to the plug on the Charging AC Adapter. Push the plug adapter firmly until it is securely held in place. Once the two are connected, attempting to forcibly remove the plug adapter could damage the product.

* The shape of the plug adapter varies according to the country or region in which the camera was purchased.

The Charging AC Adapter comes with the plug adapter attached in Argentina and Korea.

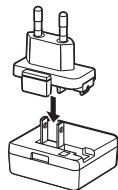
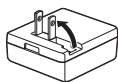

2 Make sure the battery is installed in the camera, and then connect the camera to the Charging AC Adapter in order of ① to ③.

- Keep the camera turned off.
- Be sure that plugs are properly oriented. Do not attempt to insert plugs at an angle, and do not use force when connecting or disconnecting the plugs.

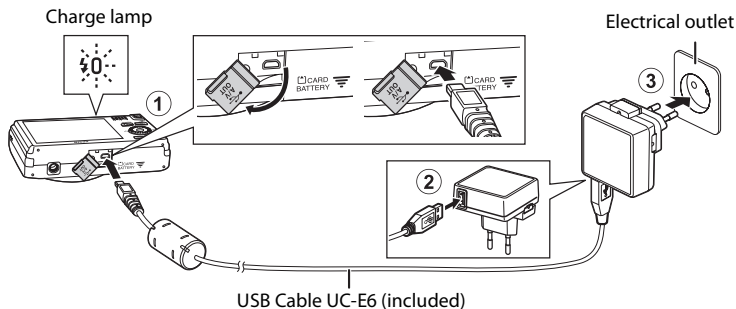

- The charge lamp slowly flashes green to indicate that the battery is charging.
- About 3 hours and 50 minutes are required to charge a fully exhausted battery.
- When the battery has been completely charged, the charge lamp turns off.
- See “The Charge Lamp” (📖19) for more information.

3 Disconnect the Charging AC Adapter from the electrical outlet and then disconnect the USB cable.

- When the camera is connected to an electrical outlet with the Charging AC Adapter, the camera cannot be turned on.

The Charge Lamp

Status	Description
Flashes slowly (green)	The battery is charging.
Off	The battery is not charging. When charging is complete, the charge lamp stops flashing green and turns off.
Flashes quickly (green)	<ul style="list-style-type: none"> The ambient temperature is not suited to charging. Charge the battery indoors with an ambient temperature of 5°C to 35°C (41°F to 95°F). The USB cable or Charging AC Adapter is not properly connected, or there is a problem with the battery. Disconnect the USB cable or unplug the Charging AC Adapter and correctly connect it again, or change the battery.

Notes About the Charging AC Adapter

Be sure to read and follow the warnings for the Charging AC Adapter EH-69P on page vii and in “Charging AC Adapter” (🔧4) before use.

Charging Using a Computer or Battery Charger

- You can also charge the Rechargeable Li-ion Battery EN-EL12 by connecting the camera to a computer (📖81, 🛠️80).
- You can use the Battery Charger MH-65 (available separately; 🛠️91) to charge the EN-EL12 without using the camera.

Notes About an AC Power Source

- You can use the AC Adapter EH-62F (available separately; 🛠️91) to supply power to the camera from an electrical outlet for taking pictures and playing back images.
- Do not, under any circumstances, use another make or model of AC adapter other than the EH-62F. Failure to observe this precaution could result in overheating or in damage to the camera.

Preparation 3 Insert a Memory Card

- 1 Be sure that the power-on lamp and the monitor are off and open the battery-chamber/memory card slot cover.

- Be sure to turn off the camera before opening the cover.

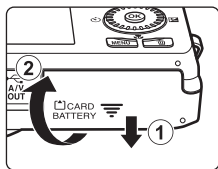

- 2 Insert the memory card.

- Slide the memory card in until it clicks into place.

✓ Inserting the Memory Card Correctly

Inserting the memory card upside down or backwards could damage the camera and the memory card. Be sure to check that the memory card is in the correct orientation.

Memory card slot

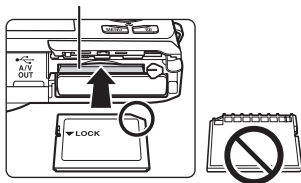

- 3 Close the battery-chamber/memory card slot cover.

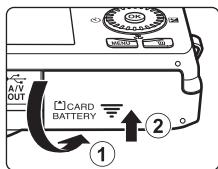

✓ Formatting Memory Cards

- The first time you insert a memory card that has been used in another device into this camera, be sure to format it with this camera.
- **All data stored on a memory card is permanently deleted when the card is formatted.** If there is data saved on the memory card that you wish to keep, copy that data to a computer before formatting.
- To format a memory card, insert the card into the camera, press the **MENU** button, and select **Format card** in the setup menu (p.94).

✓ Notes About Memory Cards

See "Memory Cards" (p.4) and the documentation included with your memory card for more information.

Removing Memory Cards

Turn the camera off and be sure that the power-on lamp and the monitor have turned off before opening the battery-chamber/memory card slot cover.

Gently push the memory card into the camera (①) to partially eject the card, and then remove the card (②). Do not pull it at an angle.

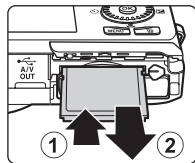

High Temperature Caution

The camera, battery, and memory card may be hot immediately after using the camera. Observe caution when removing the battery or memory card.

Internal Memory and Memory Cards

Camera data, including images and movies, can be saved in either the camera's internal memory (approximately 25 MB) or on a memory card. To use the camera's internal memory for shooting or playback, first remove the memory card.

Approved Memory Cards

The following Secure Digital (SD) memory cards have been tested and approved for use in this camera.

- Memory cards with an SD Speed Class rating of 6 or faster are recommended for recording movies. When using a memory card with a lower Speed Class rating, movie recording may stop unexpectedly.

	SD memory card	SDHC memory card ²	SDXC memory card ³
SanDisk	2 GB ¹	4 GB, 8 GB, 16 GB, 32 GB	64 GB
TOSHIBA	2 GB ¹	4 GB, 8 GB, 16 GB, 32 GB	64 GB
Panasonic	2 GB ¹	4 GB, 8 GB, 12 GB, 16 GB, 32 GB	48 GB, 64 GB
Lexar	–	4 GB, 8 GB, 16 GB, 32 GB	64 GB, 128 GB

¹ If the memory card will be used with a card reader or similar device, make sure that the device supports 2 GB cards.

² SDHC compliant.

If the memory card will be used with a card reader or similar device, make sure that the device supports SDHC.

³ SDXC compliant.

If the memory card will be used with a card reader or similar device, make sure that the device supports SDXC.

- Contact the manufacturer for details on the above cards. We cannot guarantee camera performance when using memory cards made by other manufacturers.



Step 1 Turn the Camera On

1 Press the power switch to turn on the camera.

- **If you are turning the camera on for the first time after purchase**, see “Setting the Display Language, Date, and Time” (📖24).
- The lens extends and the monitor turns on.

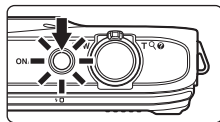

2 Check the battery level indicator and the number of exposures remaining.

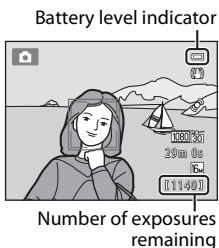

Battery level indicator

Display	Description
	The battery level is high.
	The battery level is low. Prepare to charge or replace the battery.
 Battery exhausted.	The camera cannot take pictures. Recharge or replace with a fully charged battery.

Number of Exposures Remaining

The number of pictures that can be taken is displayed.

- is displayed when no memory card is inserted in the camera, and images will be saved in the internal memory (approximately 25 MB).
- The number of exposures remaining depends on the amount of available memory in the internal memory or memory card, and also varies depending on the image quality and image size (determined by the image mode setting; 📖70).
- The number of remaining exposures shown in the illustrations in this manual is for example purposes only.

Turning the Camera On and Off

- When the camera is turned on, the power-on lamp (green) will light and then the monitor will turn on (the power-on lamp turns off when the monitor turns on).
- To turn off the camera, press the power switch. When the camera turns off, the power-on lamp and the display turn off.
- To turn the camera on in playback mode, press and hold the  (playback) button. The lens will not extend.

Power Saving Function (Auto Off)

If no operations are performed for a while, the monitor will turn off, the camera will enter standby mode, and the power-on lamp will flash. If no operations are performed for approximately another three minutes, the camera will turn off automatically.

While the camera is in standby mode, the monitor turns back on if you perform any of the following operations:

→ Press the power switch, shutter-release button,  (shooting mode) button,  (playback) button, or  (movie-record) button

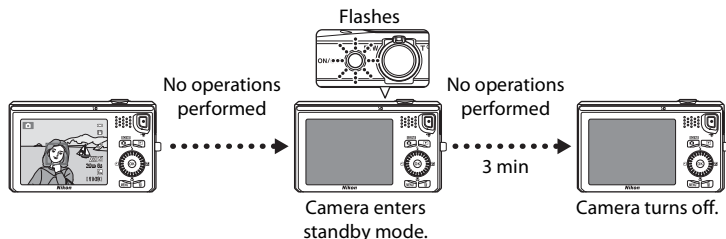

- The time that elapses before the camera enters standby mode can be changed using the **Auto off** setting in the setup menu (94).
- By default, the camera enters standby mode in about one minute when you are using shooting mode or playback mode.
- If you are using the optional AC Adapter EH-62F, the camera enters standby mode after 30 minutes (fixed).

Setting the Display Language, Date, and Time

When the camera is turned on for the first time, the language-selection screen and the date and time setting screen for the camera clock are displayed.

- 1 Press the multi selector ▲ or ▼ to select the desired language and press the **OK** button.

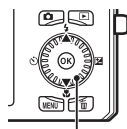

Multi selector

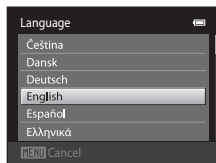

- 2 Press ▲ or ▼ to select **Yes** and press the **OK** button.

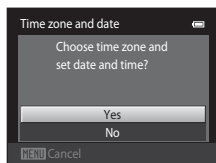

- 3 Press ◀ or ▶ to select your home time zone and press the **OK** button.

- See “Daylight Saving Time” (📖25) for information about daylight saving time.

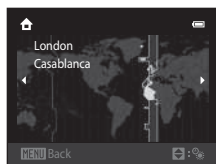
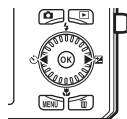

- 4 Press ▲ or ▼ to select the date format and press the **OK** button or ▶.

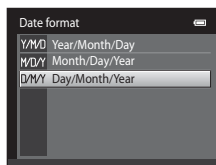

- 5 Press ▲, ▼, ◀, or ▶ to set the date and time, and press the **OK** button.

- Select a field: Press ▶ or ◀ (changes between **D**, **M**, **Y**, hour, and minute).
- Edit the value: Rotate the multi selector, or press ▲ or ▼.
- Confirm the setting: Select the minute field and press the **OK** button or ▶.

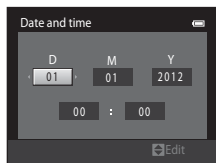

6 Press ▲ or ▼ to select **Yes** and press the **OK** button.

- When settings are finished, the lens extends and the camera switches to shooting mode.

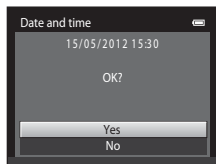



Daylight Saving Time

If daylight saving time is in effect, press the multi selector ▲ to enable the daylight saving time function while setting the region in step 3. When the daylight saving time function is enabled,  is displayed at the top of the monitor.

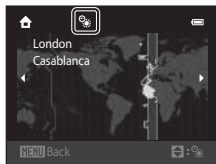
Press ▼ to disable the daylight saving time function.



Changing the Language Setting and the Date and Time Setting

- You can change these settings using the **Language** and **Time zone and date** settings in the  setup menu (📖94).
- You can enable and disable daylight saving time by selecting **Time zone and date** and then **Time zone** in the  setup menu. When enabled, the clock moves forward one hour; when disabled, the clock moves back one hour. When the travel destination (➔) is selected, the time difference between the travel destination and the home time zone (🏠) is automatically calculated and the date and time in the selected region are saved at the time of shooting.
- If you exit without setting the date and time,  will flash when the shooting screen is displayed. Use the **Time zone and date** setting in the setup menu to set the date and time (📖94).

The Clock Battery

- The camera's clock is powered by a backup battery that is separate from the camera's main battery.
- The backup battery charges when the main battery is inserted into the camera or when the camera is connected to an optional AC adapter, and can provide several days of backup power after about ten hours of charging.
- If the camera's backup battery becomes exhausted, the date and time setting screen is displayed when the camera is turned on. Set the date and time again. See step 2 (📖24) of "Setting the Display Language, Date, and Time" for more information.

Imprinting the Shooting Date in Printed Images

- Set the date and time before shooting.
- You can permanently imprint the shooting date in images as they are captured by setting **Print date** in the setup menu (📖94).
- If you want the shooting date to be printed without using the **Print date** setting, print using the ViewNX 2 software (📖82).

Step 2 Select a Shooting Mode

1 Press the button.

- The shooting mode selection menu, which allows you to select the desired shooting mode, is displayed.

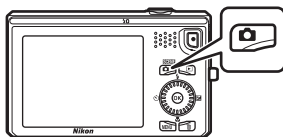

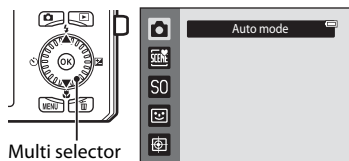

2 Press the multi selector or to select a shooting mode.

-  (auto) mode is used in this example. Select  **Auto mode**.







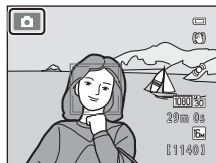











3 Press the button.





- The camera switches to  (auto) mode and the  icon is displayed.
- See “Shooting Mode” (📖6) in “The Monitor” for information about the shooting mode screen.
- The shooting mode setting is saved when the camera is turned off.



Available Shooting Modes

	Auto mode 📖38
Used for general shooting. Settings can be adjusted in the shooting menu (📖39) to suit the shooting conditions and the type of shot you want to capture.	
	Scene mode 📖41
Camera settings are optimized according to the scene that you select. When using scene auto selector, the camera automatically selects the optimum scene mode when you frame a picture, making it even easier to take pictures using settings that suit the scene.	
<ul style="list-style-type: none"> To select a scene, first display the shooting mode selection menu and then press the multi selector . Select the desired scene by pressing , , , or , and then press the  button. 	
S0	Special effects 📖51
Effects can be applied to images during shooting. Six different effects are available.	
<ul style="list-style-type: none"> To select an effect, first display the shooting mode menu and then press the multi selector . Select the desired effect by pressing , , , or , and then press the  button. 	
	Smart portrait 📖53
When the camera detects a smiling face, you can take a picture automatically without pressing the shutter-release button (smile timer). You can also use the skin softening option to smooth the skin tones of human faces.	
	Subject tracking 📖57
Ideal for focusing on moving subjects.	

Features That Are Available in Shooting Mode

- The multi selector , , , and  can be used to set the corresponding features. See “Features That Can Be Set Using the Multi Selector” (📖61) for more information.
- Press the **MENU** button to display the menu for the selected shooting mode. See “Shooting Features” (📖37) for information about the settings available in the menu for the current shooting mode.

Step 3 Frame a Picture

1 Hold the camera steady.

- Keep fingers, hair, the camera strap, and other objects away from the lens, flash, AF assist-illuminator, microphone, and speaker.
- When taking pictures in portrait (“tall”) orientation, turn the camera so that the flash is above the lens.

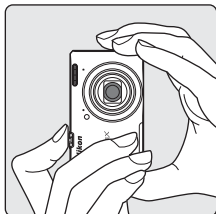
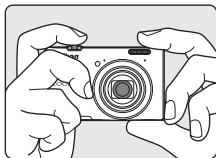

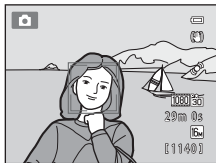

2 Frame the picture.

- When the camera detects a human face, that face is framed by a yellow double border (focus area) (default setting).
- Up to 12 faces can be detected. When the camera detects more than one face, the face closest to the camera is framed by a double border and the others by single borders.
- When shooting non-human subjects or when no faces are detected, the focus area is not displayed. Position the main subject near the center of the frame.



When Using a Tripod

- We recommend using a tripod to stabilize the camera in the following situations.
 - When shooting in dim lighting or when the flash mode (63) is set to  (off)
 - When using the telephoto setting
- Set **Vibration reduction** to **Off** in the setup menu (94) when using a tripod to stabilize the camera during shooting.

Using the Zoom

Use the zoom control to activate optical zoom.

- To zoom in closer to the subject, rotate the zoom control to **T** (telephoto).
- To zoom out and view a larger area, rotate the zoom control to **W** (wide-angle).

When you turn the camera on, the zoom moves to the maximum wide-angle position.

- A zoom indicator is displayed at the top of the monitor when the zoom control is rotated.

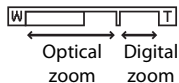
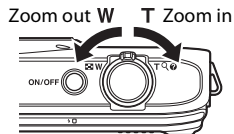

Digital Zoom

When the camera is zoomed in to the maximum optical zoom position, rotating and holding the zoom control at **T** triggers digital zoom.

Digital zoom can magnify the subject up to about 4x beyond the maximum magnification of the optical zoom.

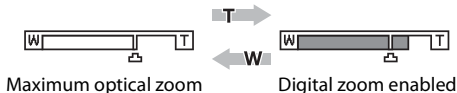

- When you are using digital zoom, the camera focuses on the subject in the center of the frame and the focus area is not displayed.

Digital Zoom and Interpolation

Unlike optical zoom, digital zoom uses a digital imaging process known as interpolation to magnify images, resulting in slight deterioration of picture quality according to the image mode (📖69) and digital zoom magnification.

Interpolation is applied at zoom positions beyond 📷 when taking still images.

When zoom is increased beyond the 📷 position, interpolation is initiated and the zoom indicator turns yellow to indicate that interpolation is being applied.

The position of 📷 moves to the right as image size decreases, allowing you to confirm the zoom position at which shooting without interpolation is possible at the current image mode setting.

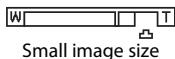

- Digital zoom can be disabled from the **Digital zoom** option in the setup menu (📖94).

Step 4 Focus and Shoot

1 Press the shutter-release button halfway, i.e., press the button slightly until you feel resistance.

- When you press the shutter-release button halfway, the camera sets the focus and exposure (shutter speed and aperture value). Focus and exposure remain locked while the shutter-release button is pressed halfway.
- When a face is detected:
The camera focuses on the face framed by the double border. When the subject is in focus, the double border glows green.

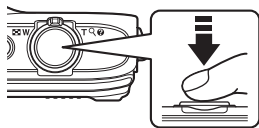

- When a face is not detected:
The camera has nine focus areas, and automatically selects the focus areas containing the subject closest to the camera. When the subject is in focus, the focus areas that are in focus (up to nine areas) glow green.

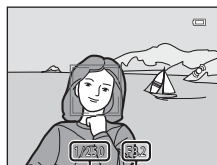

Shutter speed Aperture value

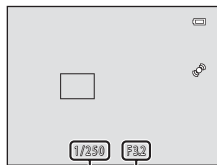

Shutter speed Aperture value

- When you are using digital zoom, the camera focuses on the subject in the center of the frame and the focus area is not displayed. When the camera has focused, the focus indicator () glows green.
- While the shutter-release button is pressed halfway, the focus area or focus indicator may flash red. This indicates that the camera is unable to focus. Modify the composition and press the shutter-release button halfway again.

2 Press the shutter-release button the rest of the way down.

- The shutter is released and the image will be saved to the memory card or internal memory.
- If you press the shutter-release button with too much force, the camera may shake, causing images to be blurred. Press the button gently.



✔ Note on Recording Images and Saving Movies

The indicator showing the number of exposures remaining or the indicator showing the maximum movie length flashes while images are being recorded or while a movie is being saved. **Do not open the battery-chamber/memory card slot cover or remove the battery or memory card** while an indicator is flashing. Doing this could result in loss of data, or in damage to the camera or the memory card.

✔ Subjects Not Suitable for Autofocus

The camera may not focus as expected in the following situations. In some rare cases, the subject may not be in focus despite the fact that the focus area or the focus indicator glows green:

- Subject is very dark
- Objects of sharply differing brightness are included in the scene (e.g. the sun behind the subject makes that subject appear very dark)
- No contrast between the subject and surroundings (e.g. a portrait subject, wearing a white shirt, is standing in front of a white wall)
- Several objects are at different distances from the camera (e.g. the subject is inside a cage)
- Subjects with repeating patterns (window blinds, buildings with multiple rows of similarly shaped windows, etc.)
- Subject is moving rapidly

In the situations noted above, try pressing the shutter-release button halfway to refocus several times, or focus on another subject positioned at the same distance from the camera as the actual desired subject, and use focus lock (📖76).

✔ Notes About Face Detection

See “Using Face Detection” (📖73) for more information.

✍ When the Subject Is Close to the Camera

If the camera cannot focus, try shooting with macro mode (📖65) or the **Close-up** scene mode (📖45).

✍ AF-assist Illuminator and Flash

If the subject is dimly lit, the AF-assist illuminator (📖95) may light when the shutter-release button is pressed halfway, and the flash (📖62) may fire when the shutter-release button is pressed all the way down.

✍ To Make Sure You Do Not Miss a Shot

If you are concerned that you might miss a shot, press the shutter-release button all the way without first pressing it halfway.



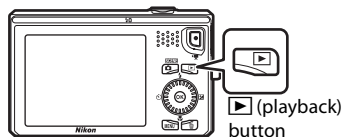

Step 5 Play Back Images

1 Press the (playback) button.

- When you switch from shooting mode to playback mode, the last image saved will be displayed full-frame.



2 Use the multi selector to select an image to display.

- Display the previous image:  or 
- Display the subsequent image:  or 
- You can also scroll through images by rotating the multi selector.



Display the previous image



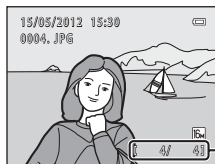





Display the next image





Current image number/
total number of images

- Remove the memory card from the camera to play back images saved in the camera's internal memory.  is displayed near the current image number/total number of images display.
- To return to shooting mode, press the  button, the shutter-release button, or the  button.

Viewing Images

- Images may be displayed briefly at low resolution while being read from the memory card or internal memory.
- When images in which the face of a person (73) or a pet (49) was detected at the time of shooting are displayed in full-frame playback mode, depending upon the orientation of the detected face, the images may be automatically rotated for playback display (except images captured in a series).
- You can change the orientation of an image using **Rotate image** in the playback menu (79).
- Each series of images captured using continuous shooting is saved in a sequence, and by default, only the first image in the sequence (key picture) is displayed to represent them (80). Press the  button to display them as individual images. Press  to return to the key picture only display.

More Information

- See "Features Available in Playback Mode (Playback Menu)" (79) for more information.
- See "Selecting Certain Types of Images for Playback" (78) for more information.

Changing How Images Are Displayed

When using playback mode, you can change how images are displayed by rotating the zoom control to **W** (📐) and **T** (🔍).



Playback Zoom

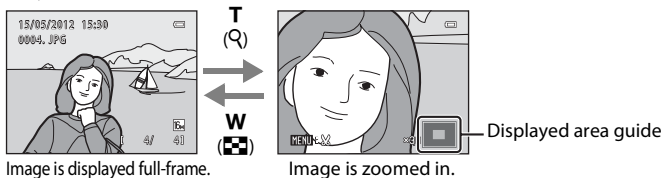

- You can change the zoom ratio by rotating the zoom control to **W** (📐) and **T** (🔍). Images can be zoomed up to 10x.
- To view a different area of the image, press the multi selector **▲**, **▼**, **◀**, or **▶**.
- If you are viewing an image that was captured using face detection (📖73) or pet detection (📖49) function, the camera zooms in on the face detected at the time of shooting (except when viewing an image captured in a series). If the camera detected multiple faces when the image was captured, press **▲**, **▼**, **◀**, or **▶** to display a different face. To zoom in on an area of the image where there are no faces, adjust the magnification rate and then press **▲**, **▼**, **◀**, or **▶**.
- You can crop the image and save the displayed area of the image as a separate file by pressing the **MENU** button (📖22).
- Press the **OK** button to return to full-frame playback mode.

Thumbnail Display, Calendar Display

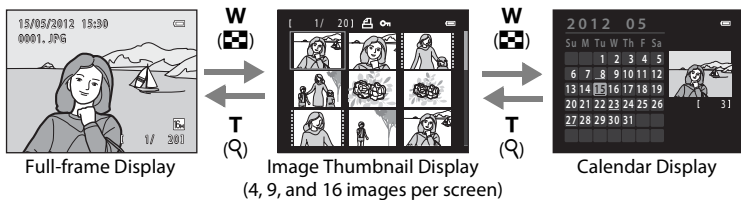



- You can view several images on one screen, making it easy to find the image you want.
- You can change the number of thumbnails displayed by rotating the zoom control to **W** (📐) and **T** (🔍).
- Rotate the multi selector, or press **▲**, **▼**, **◀**, or **▶** to select an image and then press the **OK** button to display that image full-frame.
- When 16 thumbnails are displayed, rotate the zoom control to **W** (📐) to switch to calendar display.
- While using calendar display mode, rotate the multi selector, or press **▲**, **▼**, **◀**, or **▶** to select a date and then press the **OK** button to display the first image captured on that day.

Step 6 Delete Unwanted Images

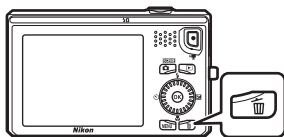
- 1 Press the  button to delete the image currently displayed in the monitor.



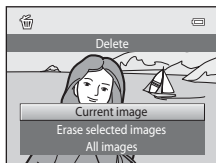

- 2 Press the multi selector  or  to select the desired deletion method and press the  button.

- **Current image:** Only the current image is deleted.
- **Erase selected images:** Multiple images can be selected and deleted. See “Operating the Erase Selected Images Screen” (p.35) for more information.
- **All images:** All images are deleted.
- To exit without deleting, press the **MENU** button.



- 3 Press  or  to select **Yes** and press the  button.

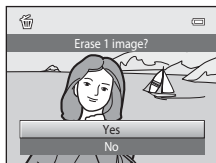

- Deleted images cannot be recovered.
- To cancel, press  or  to select **No** and press the  button.



Notes About Deletion

- Deleted images cannot be recovered. Copy important images to a computer or other media before deleting them from the camera.
- Protected images (p.79) cannot be deleted.

Deleting Images in a Sequence

- If you press the  button and delete a key picture while only key pictures are displayed for sequences of images (p.32), all images in the sequence, including the key picture, are deleted.
- To delete individual images in a sequence, press the  button to display them one at a time and press the .

Deleting the Last Image Captured While in Shooting Mode

When using shooting mode, press the  button to delete the last image that was saved.

Operating the Erase Selected Images Screen

- 1** Press the multi selector ◀ or ▶ to select an image to be deleted, and then press ▲ to display ✓.
- To undo the selection, press ▼ to remove ✓.
 - Rotate the zoom control (📖) to **T** (🔍) to switch back to full-frame playback or **W** (🖼️) to display thumbnails.



- 2** Add ✓ to all images that you want to delete and then press the Ⓚ button to confirm the selection.
- A confirmation dialog is displayed. Follow the instructions displayed in the monitor.

Selecting Certain Types of Images for Deletion

When using favorite pictures mode, auto sort mode, or list by date mode (📖78), you can select images registered as favorites, images in a certain category, or images captured on a specific date for deletion.



A series of horizontal dashed lines spanning the width of the page, intended for handwriting practice. There are 15 lines in total, starting from the top right and extending to the bottom left.

Shooting Features



This chapter describes the camera's shooting modes and the features that are available when using each shooting mode.

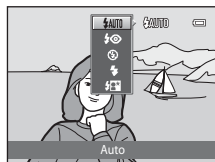
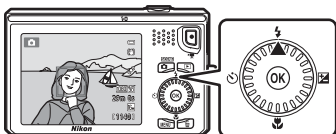
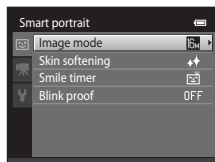
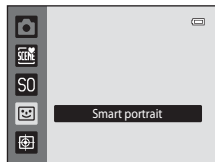
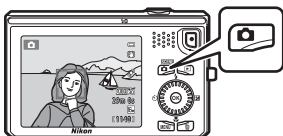

You can select shooting modes and adjust settings according to the shooting conditions and the kind of images you want capture.



(Auto) Mode

Used for general shooting. Settings can be adjusted in the shooting menu (39) to suit the shooting conditions and the type of shot you want to capture.







Enter shooting mode →  (shooting mode) button →  (auto) mode (26-27)

- You can change how the camera selects the area of the frame to focus on by pressing the **MENU** button, selecting the  tab, and then selecting **AF area mode** (40).

The default setting is **Face priority**.

If the camera detects a face, it focuses on that face. See “Using Face Detection” (73) for more information. If no faces are detected, the camera automatically selects one or more of the nine focus areas containing the subject closest to the camera. When the subject is in focus, the focus area (active focus area) lights in green (maximum of nine areas).

Changing (Auto) Mode Settings

- Features that can be set using the multi selector (61): Flash mode (62), self-timer (64), macro mode (65), and exposure compensation (66)
- Features that can be set by pressing the **MENU** button: Options available in the auto shooting menu (39)

Camera Settings That Cannot Be Applied Simultaneously



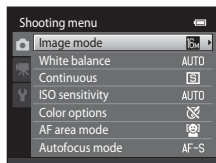

Options Available in the Auto Shooting Menu

When using (auto) mode, the following settings can be changed.

Select (auto) mode → MENU button



Option	Description	
Image mode	Allows you to select the combination of image size and image quality used when saving images (69). This setting is also applied to other shooting modes.	69
White balance	Allows you to adjust the color tones of the image to match what you see with your eye. Although Auto (default setting) can be used in most shooting conditions, if the desired color tones are not achieved, adjust white balance to suit the sky conditions or light source. <ul style="list-style-type: none"> When white balance is set to settings other than Auto or Flash, set the flash mode (62) to (off). 	36
Continuous	Allows you to capture a series of images. <ul style="list-style-type: none"> When Continuous H, Continuous L, Pre-shooting cache, or BSS is selected, images are captured while the shutter-release button is held all the way down. When Continuous H: 120 fps, Continuous H: 60 fps, or Multi-shot 16 is selected, the number of images determined by the setting are captured when the shutter-release button is pressed all the way. There is no need to hold the shutter-release button down. The default setting is Single (i.e., only one image is captured at a time). 	38
ISO sensitivity	Higher ISO sensitivity allows darker subjects to be captured. Additionally, even with subjects of similar brightness, pictures can be taken at faster shutter speeds, and blurring caused by camera shake and subject movement can be reduced. When ISO sensitivity is set to Auto (default setting), the camera sets the ISO sensitivity automatically, and ISO is displayed while shooting when ISO sensitivity increases.	41



Option	Description	
Color options	Allows you to change the color tones of images at the time of shooting. The available settings are Standard color (default setting), Vivid color , Black-and-white , Sepia , and Cyanotype .	 42
AF area mode	Allows you to determine how the camera selects the focus area that is used for autofocus; the available settings are Face priority (default setting), Auto , Manual , and Center .	 43
Autofocus mode	When Single AF is selected, the camera focuses only while the shutter-release button is pressed halfway. When Full-time AF is selected, the camera focuses even when the shutter-release button is not pressed halfway. You may hear the sound of the camera focusing.	 45

 **Camera Settings That Cannot Be Applied Simultaneously**





















Some settings cannot be used with other functions (71).

Scene Mode (Shooting Suited to Scenes)

When one of the following scenes is selected, camera settings are automatically optimized for the selected scene.

Enter shooting mode →  (shooting mode) button →  (second icon from the top*) →
▶ → select a scene (📖26-27)

* The icon of the last scene selected is displayed. The default setting is  (scene auto selector).

 Scene auto selector (default setting; 📖42)	 Portrait (📖42)	 Landscape (📖42)	 Sports (📖43)
 Night portrait (📖43)	 Party/indoor (📖44)	 Beach (📖44)	 Snow (📖44)
 Sunset (📖44)	 Dusk/dawn (📖44)	 Night landscape (📖45)	 Close-up (📖45)
 Food (📖46)	 Museum (📖46)	 Fireworks show (📖46)	 Black and white copy (📖47)
 Backlighting (📖47)	 Easy panorama (📖48)	 Pet portrait (📖49)	 3D 3D photography (📖50)

To View a Description (Help Display) of Each Scene

Select the desired scene from the scene selection screen and rotate the zoom control (📖2) to **T** (🔍) to view a description of that scene. To return to the original screen, rotate the zoom control to **T** (🔍) again.









Changing Scene Mode Settings





- Depending on the scene, the multi selector ▲ (🔼), ▼ (🔽), ◀ (🔀), and ▶ (🔁) can be used to set the corresponding features. See “Features That Can Be Set Using the Multi Selector” (📖61) and “Default Settings” (📖67) for more information.
- Features that can be set by pressing the **MENU** button: Image mode, which is the combination of image size and image quality (📖69).

Characteristics of Each Scene

Scene auto selector

The camera simplifies shooting by automatically selecting the optimum scene mode from the list below when the shot is framed.

: Portrait, : Landscape, : Night portrait, : Night landscape, : Close-up, : Backlighting, : Other scenes

- When the camera selects a scene mode, the shooting mode icon displayed in the shooting screen changes to that for the scene mode currently enabled.
- The focus area depends on the composition of the picture. When the camera detects a human face, it focuses on that face (□73).
- When the camera selects  (night portrait), flash mode is fixed at fill flash with slow sync and red-eye reduction (when $\$$ AUTO (auto) is selected) and the camera captures one image at a slower shutter speed.
- When the camera selects  (night landscape), flash mode is fixed at  (off), regardless of the setting made, and the camera captures one image at a slower shutter speed.
- Depending upon shooting conditions, the camera may not select the desired scene mode. Should this occur, switch to  (auto) mode (□26) or select the desired scene mode manually.
- Digital zoom cannot be used.

Portrait

Use this mode for portraits.

- When the camera detects a human face, it focuses on that face (□73).
- The camera softens skin tones by applying the skin softening function (□75).
- If no faces are detected, the camera focuses on the subject in the center of the frame.
- Digital zoom cannot be used.



Landscape

Use this mode for vivid landscapes and cityscapes.

- The focus area or focus indicator (□7) always glows green when the shutter-release button is pressed halfway.



Sports

Use this mode when shooting sporting events. The camera captures a series of still images that allow you to clearly see detailed movements in a moving subject.







- The camera focuses on the area in the center of the frame.
- Press and hold the shutter-release button all the way to capture images continuously. Up to 6 images are captured continuously at a rate of about 1.9 fps (when image mode is set to )
- The camera focuses even when the shutter-release button is not pressed halfway. You may hear the sound of the camera focusing.
- Focus, exposure, and hue are fixed at the values determined with the first image in each series.
- The frame rate with continuous shooting may vary depending upon the current image mode setting, the memory card used, or shooting condition.



Night portrait

Use this mode for evening and night portraits that include background scenery. The flash fires to light the portrait subject while preserving background lighting to achieve a natural balance between the main subject and background ambience. From the screen displayed after the  **Night portrait** scene mode is selected, select **Hand-held** or **Tripod**.



- **Hand-held:**
 - The  icon is displayed in the shooting screen.
 - When the  icon at the top left of the monitor lights in green, press the shutter-release button all the way to capture a series of images which will be combined into a single image and saved.
 - Once the shutter-release button is pressed all the way, hold the camera still until a still image is displayed. After taking a picture, do not turn the camera off before the monitor switches to the shooting screen.
 - The angle of view (i.e., the area visible in the frame) seen in the saved image will be narrower than that seen in the monitor at the time of shooting.
 - If the subject moves while the camera is shooting continuously, the image may be distorted, overlapped, or blurred.
- **Tripod** (default setting): Select this option when using a tripod or other means to stabilize the camera during shooting.
 - The  icon is displayed in the shooting screen.
 - **Vibration reduction** ()95) is automatically set to **Off** regardless of the setting in the setup menu.
 - One image is captured at a slow shutter speed when the shutter-release button is pressed all the way.
- When the camera detects a human face, it focuses on that face ()73).
- The camera softens skin tones by applying the skin softening function ()75).
- If no faces are detected, the camera focuses on the subject in the center of the frame.
- Digital zoom cannot be used.

Scene Mode (Shooting Suited to Scenes)

Party/indoor

Suitable for taking pictures at parties. Captures the effects of candlelight and other indoor background lighting.

- The camera focuses on the area in the center of the frame.
- To avoid the effects of camera shake, hold the camera steady when shooting in dark surroundings. Set **Vibration reduction to Off** in the setup menu (📖94) when using a tripod to stabilize the camera during shooting.



Beach

Captures the brightness of such subjects as beaches or sunlit expanses of water.

- The camera focuses on the area in the center of the frame.



Snow

Captures the brightness of sunlit snow.

- The camera focuses on the area in the center of the frame.



Sunset

Preserves the deep hues seen in sunsets and sunrises.

- The camera focuses on the area in the center of the frame.





Dusk/dawn

Preserves the colors seen in the weak natural light before sunrise or after sunset.

- The focus area or focus indicator (📖7) always glows green when the shutter-release button is pressed halfway.







 Use of a tripod is recommended when using scene modes indicated with . Set **Vibration reduction to Off** in the setup menu (📖94) when using a tripod to stabilize the camera during shooting.

Night landscape

Captures the atmosphere of night landscapes.







From the screen displayed after the  **Night landscape** scene mode is selected, select **Hand-held** or **Tripod**.

- **Hand-held** (default setting): Select this option to produce shots with reduced blurring and noise even when the camera is hand-held.
 - The  icon is displayed in the shooting screen.
 - When the  icon at the top left of the monitor lights in green, press the shutter-release button all the way to capture a series of images which will be combined into a single image and saved.
 - Once the shutter-release button is pressed all the way, hold the camera still until a still image is displayed. After taking a picture, do not turn the camera off before the monitor switches to the shooting screen.
 - The angle of view (i.e., the area visible in the frame) seen in the saved image will be narrower than that seen in the monitor at the time of shooting.
- **Tripod**: Select this option when using a tripod or other means to stabilize the camera during shooting.
 - The  icon is displayed in the shooting screen.
 - **Vibration reduction** () is automatically set to **Off** regardless of the setting in the setup menu.
 - One image is captured at a slow shutter speed when the shutter-release button is pressed all the way.
- The focus area or focus indicator () always glows green when the shutter-release button is pressed halfway.
- Digital zoom cannot be used.



Close-up

Use this mode to photograph flowers, insects, and other small objects at close range.



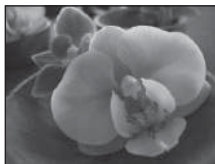





- Macro mode () is enabled and the camera automatically zooms to the closest position at which it can focus.
- You can move the focus area. To move the focus area, press the  button, and then rotate the multi selector or press , , , or . To change settings for any of the following functions, first press the  button to cancel focus-area selection, then change the settings as desired.
 - Flash mode
 - Self-timer
 - Exposure compensation
- The camera focuses even when the shutter-release button is not pressed halfway. You may hear the sound of the camera focusing.



Scene Mode (Shooting Suited to Scenes)

Food

Use this mode when taking pictures of food.

- Macro mode (65) is enabled and the camera automatically zooms to the closest position at which it can focus.
- You can adjust hue by pressing the multi selector  and . The hue setting is saved in the camera's memory even after the camera is turned off.
- You can move the focus area. To move the focus area, press the  button, and then rotate the multi selector or press , , , or .

To change settings for any of the following functions, first press the  button to cancel focus-area selection, then change the settings as desired.

- Hue
- Self-timer
- Exposure compensation
- The camera focuses even when the shutter-release button is not pressed halfway. You may hear the sound of the camera focusing.

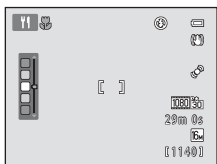

Museum

Use indoors where flash photography is prohibited (for example, in museums and art galleries) or in other settings in which you do not want to use the flash.

- The camera focuses on the area in the center of the frame.
- The camera captures a series of up to ten images while the shutter-release button is held all the way down, and the sharpest image in the series is automatically selected and saved (BSS (Best Shot Selector)).





Fireworks show



Slow shutter speeds are used to capture the light from fireworks.

- Camera focuses at infinity.
- The focus indicator () always glows green when the shutter-release button is pressed halfway.



: Use of a tripod is recommended when using scene modes indicated with . Set **Vibration reduction to Off** in the setup menu (94) when using a tripod to stabilize the camera during shooting.

Black and white copy

Provides clear images of text or drawings on a whiteboard or in print.

- The camera focuses on the area in the center of the frame.
- Use together with macro mode (65) when shooting subjects that are close to the camera.



Backlighting

Use when light is coming from behind the subject, throwing features or details into shadow.

From the screen displayed after the  **Backlighting** scene mode is selected, enable or disable the high dynamic range (HDR) function.



- When **HDR** is set to **Off** (default setting): The flash fires to prevent the subject from being hidden in shadow.
 - The camera focuses on the area in the center of the frame.
 - When the shutter-release button is pressed all the way down, one image is captured.
- When **HDR** is set to **On**: Use when taking pictures with very bright and dark areas in the same frame.
 - The **HDR** icon is displayed in the shooting screen.
 - The camera focuses on the area in the center of the frame. Digital zoom cannot be used.
 - When the shutter-release button is pressed all the way, the camera shoots images continuously at high speed, and saves the following two images.
 - A non-HDR composite image
 - An HDR composite image in which the loss of details in highlights or shadows is minimized
 - The second image saved is an HDR composite image. If there is only enough memory to save one image, an image processed by D-Lighting (79) at the time of shooting, in which dark areas of the image are corrected, is the only image saved.
 - Once the shutter-release button is pressed all the way, hold the camera still until a still image is displayed. After taking a picture, do not turn the camera off before the monitor switches to the shooting screen.
 - The angle of view (i.e., the area visible in the frame) seen in the saved image will be narrower than that seen in the monitor at the time of shooting.



Easy panorama



Allows you to take a panorama picture viewable on the camera simply by moving the camera in the desired direction.

- From the screen displayed after the  **Easy panorama** scene mode is selected, select the shooting range from **Normal (180°)** or **Wide (360°)**.
- Press the shutter-release button all the way down, remove your finger from the button, and then slowly pan the camera horizontally. Shooting automatically ends when the camera captures the specified shooting range.
- The camera focuses at the center of the frame when shooting starts.
- The zoom position is fixed at wide-angle.
- If you press the  button when a panorama captured using easy panorama is displayed in full-frame playback mode, the panorama is displayed so that the short edge of the panorama fits on the monitor, and the image scrolls automatically. See “Using Easy Panorama (Shooting and Playback)” (602) for more information.

Notes About Printing Panoramas



When printing panoramas, the entire image may not be able to be printed depending on the printer's settings. Additionally, printing may not be possible depending on the printer.

Pet portrait

Use this mode when taking pictures of dogs or cats. When the camera detects the face of a dog or cat, the camera focuses on that face. Once the camera has focused, by default it automatically releases the shutter (pet portrait auto release).





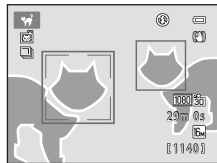

- From the screen displayed after the  **Pet portrait** scene mode is selected, select **Single** or **Continuous**.

- **Single**: Images are captured one at a time.
- **Continuous**: Three images are captured continuously when a face is focused on (at a rate of about 1.9 fps when image mode is  **4608x3456**). While **Continuous** is selected, the  is displayed in the shooting screen.

- When the camera detects a face, a double border (focus area) is displayed around the face, and the double border glows green when the camera has focused. The faces of up to five pets can be detected at the same time. When the camera detects more than one face, the face displayed largest in the monitor is framed by a double border and the others by single borders.



- If no pet faces are detected, the shutter can be released by pressing the shutter-release button.
 - If no pet faces are detected, the camera focuses on the subject at the center of the frame.
 - When **Continuous** is selected, up to 6 images are captured continuously at a rate of about 1.9 fps (when image mode is set to  **4608x3456**) while the shutter-release button is held all the way down.
 - Press the multi selector  (⊙) to change the auto release setting.
 - **Pet portrait auto release** (default setting): The camera automatically releases the shutter when it focuses on the detected face. While **Pet portrait auto release** is selected, the  icon is displayed in the shooting screen.
 - **Off**: The shutter is released only when the shutter-release button is pressed.
 - Digital zoom cannot be used.
 - Depending on the distance of the pet from the camera, the speed of the pet's movement, the direction the pet is facing, the ambient brightness of the pet's face, etc., pet faces may not be detected and other subjects may be displayed with a border.
 - **Pet portrait auto release** turns off automatically when:
 - Five bursts have been taken.
 - Internal memory or the memory card is full.
- To continue taking pictures with **Pet portrait auto release**, press the multi selector  (⊙) and change the setting again.

3D 3D photography

Use this mode for taking 3D pictures viewable in three dimensions on a 3D-compatible TV or monitor. The camera captures one image for each eye to simulate a three-dimensional image.

Images captured in this mode are saved at an image size of $\frac{16:9}{2.0}$ (1920 × 1080).

- After taking the first picture by pressing the shutter-release button, move the camera horizontally to the right so that the subject is aligned with the guide on the monitor. The camera captures the second image automatically.
- The focus area can be moved from the center of the frame to a different position. To move the focus area, before taking the first picture, press the **OK** button, and then rotate the multi selector or press **▲**, **▼**, **◀**, or **▶**. To change settings for any of the following functions, first press the **OK** button to cancel focus-area selection, then change the settings as desired.
 - Macro mode
 - Exposure compensation
- The maximum telephoto zoom position is limited to an angle of view equivalent to that of 127 mm lens in 35mm [135] format.
- The angle of view (i.e., the area visible in the frame) seen in the saved image will be narrower than that seen in the monitor at the time of shooting.
- Movies cannot be recorded in 3D.
- The two captured images are saved as a 3D image (MPO file) consisting of the left and right eye images. The first image (the left eye image) is also saved as a JPEG file. See "Using 3D Photography" (P.55) for more information.

Notes About Taking 3D Pictures

In some shooting conditions, such as when the subject is moving, dark, or low in contrast, the second shot may not be taken or the 3D image may not be saved.

Playing Back 3D Images



- 3D images cannot be played back in 3D on the camera monitor. Only the left eye image of a 3D image is displayed during playback.
- To view 3D images in 3D, a 3D-compatible TV or monitor is required. Use a 3D-compatible HDMI cable to connect the camera and these devices (P.81) for 3D viewing.
- When connecting the camera using an HDMI cable, set **TV settings** in the setup menu (P.94) as follows:
 - **HDMI: Auto** (default setting) or **1080i**
 - **HDMI 3D output: On** (default setting)
- When the camera is connected via HDMI and images are played back, it may take a while to display images when switching between 3D images and non-3D images. Playback zoom is not possible while images are played back in 3D.
- Refer to the documentation included with the TV or monitor for details on how to make the settings.

Caution for Viewing 3D Images

When viewing 3D images on a 3D-compatible TV or monitor for an extended period of time, you may experience discomfort such as eye strain or nausea. Carefully read the documentation included with your TV or monitor to ensure proper use.

Special Effects Mode (Applying Effects When Shooting)



Effects can be applied to images during shooting.



Enter shooting mode →  (shooting mode) button → SO (third icon from the top*) →  select an effect (26-27)

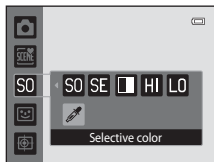

* The icon of the last effect selected is displayed. The default setting is SO (soft).

The following six effects are available.







Category	Description
SO Soft* (default setting)	Softens the image by adding a slight blur to the entire image.
SE Nostalgic sepia*	Adds a sepia tone and reduces the contrast to simulate the qualities of an old photograph.
 High-contrast monochrome	Changes the image to black and white and gives it sharp contrast.
HI High key	Gives the entire image a bright tone.
LO Low key	Gives the entire image a dark tone.
 Selective color	Creates a black and white image in which only the specified color remains.

* The  **HS 120 fps (640×480)** setting in **Movie Options** (91) cannot be used with this setting. If you try to use both settings at the same time, only the setting made first is enabled.

- The camera focuses on the area in the center of the frame.
- When **Selective color** is selected, rotate the multi selector or press  or  to select the desired color from the slider.

To change settings for any of the following functions, first press the  button to cancel color selection, then change the settings as desired.

- Flash mode (62)
- Self-timer (64)
- Macro mode (65)
- Exposure compensation (66)

To return to the color selection screen, press the  button again.

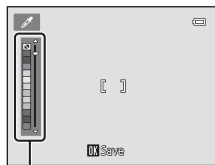

Slider

Changing Special Effects Mode Settings

- Features that can be set using the multi selector (📖61): Flash mode (📖62), self-timer (📖64), macro mode (📖65), and exposure compensation (📖66)
- Features that can be set by pressing the **MENU** button: Image mode, which is the combination of image size and image quality (📖69).

Smart Portrait Mode (Capturing Images of Smiling Faces)

When the camera detects a smiling face, you can take a picture automatically without pressing the shutter-release button (smile timer). You can use the skin softening option to smooth the skin tones of human faces.

Enter shooting mode → 📷 (shooting mode) button → 😊 Smart portrait mode (📖26-27)

1 Without pressing the shutter-release button, frame the picture and wait for the subject to smile.

- When the camera detects a human face, a yellow double border (focus area) is displayed around that face. When the camera has focused on that face, the double border will turn green for a moment and focus is locked.
- Up to three faces can be detected. When the camera detects more than one face, a double border is displayed around the face closest to the center of the frame, and single borders are displayed around the other faces.
- If the camera detects that the face framed by the double border is smiling, the **Smile timer** (📖56) feature is activated and the shutter is automatically released.
- After the camera releases the shutter, it will continue to detect faces and smiles, and will release the shutter again if it detects a smiling face.

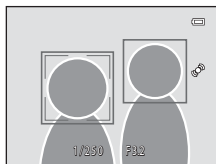

2 End shooting.

- Any one of the following operations can be used to cancel smile detection and stop shooting.
 - Turn the camera off.
 - Set **Smile timer** (📖56) to **Off**.
 - Press the 📷 button and select a different shooting mode.

Notes About Smart Portrait Mode

- Digital zoom cannot be used.
- Under some shooting conditions, the camera may be unable to detect faces or detect smiles.
- See “Notes About Face Detection” (📖74) for more information.

Auto Power Off in Smile Timer Mode

When **Smile timer** is set to **On**, the auto power off function (📖95) is activated and the camera turns off when either of the situations indicated below persists and no other operations are performed.

- The camera does not detect any faces.
- The camera detected a face, but cannot detect a smile.

When the Self-timer Lamp Flashes

When using smile timer, the self-timer lamp flashes when the camera detects a face and flashes quickly immediately after the shutter is released.

Releasing the Shutter Manually

The shutter can also be released by pressing the shutter-release button. If no faces are detected, the camera focuses on the subject at the center of the frame.

Changing Smart Portrait Mode Settings

- Features that can be set using the multi selector (📖61): Flash mode (📖62), self-timer (📖64), and exposure compensation (📖66)
- Features that can be set by pressing the **MENU** button: Options available in the smart portrait menu (📖56).

Camera Settings That Cannot Be Applied Simultaneously





Some settings cannot be used with other functions (📖71).

Options Available in the Smart Portrait Menu

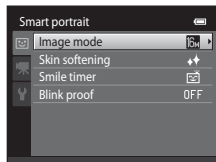
When using  smart portrait mode, the following settings can be changed.

Select smart portrait mode → MENU button





Option	Description	
Image mode	Allows you to select the combination of image size and image quality used when saving images ( 69). If you change the image mode setting, the new setting is applied to all shooting modes.	69
Skin softening	Allows you to set the skin softening effect. The camera softens skin tones by applying the skin softening function before saving images. You can select the amount of effect that is applied. The default setting is Normal .	 46
Smile timer	When On (default setting) is selected, the camera detects human faces and then automatically releases the shutter whenever a smile is detected. Self-timer cannot be used with this feature.	 46
Blink proof	When On is selected, the camera automatically releases the shutter twice each time a picture is taken. Of the two shots, one in which the subject's eyes are open is saved. The flash cannot be used when On is selected. The default setting is Off .	 47

Camera Settings That Cannot Be Applied Simultaneously

Some settings cannot be used with other functions (71).

Subject Tracking Mode (Focusing on a Moving Subject)

Use this mode to focus on a subject that is moving when taking pictures.

Enter shooting mode →  (shooting mode) button →  Subject tracking mode (📖26-27)

When you register a subject, subject tracking begins and the focus area automatically follows the subject.

1 Register a subject.

- When taking pictures of people:

Face priority tracking (📖59) can be used to detect a human face and then automatically register that person as the subject to be tracked.

If the subject is not registered automatically, align the subject that you want to register with the white border in the center of the monitor and press the  button.

- When taking pictures of non-human subjects:

Align the subject that you want to register with the white border in the center of the monitor and press the  button.

If a person visible in the frame is automatically registered, set **Face priority tracking** to **Off** and register the desired subject again.

- When the camera is unable to focus on the subject, the border will glow red. Change the composition and try registering the subject again.
- When the subject is registered, a yellow border (focus area) is displayed around that subject and the camera begins tracking that subject.
- To cancel subject registration, press the  button.
- If the camera cannot track the registered subject anymore, the focus area will disappear and the registration will be canceled. Register the subject again.

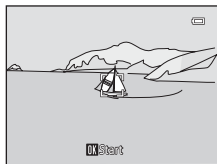
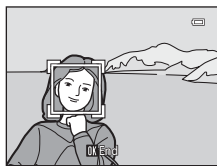

2 Press the shutter-release button to take a picture.

- The camera focuses on the focus area when the shutter release button is pressed halfway. The focus area will glow green and focus will be locked.
- Press the shutter-release button all the way down to release the shutter.

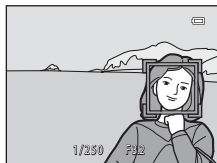

Subject Tracking Mode (Focusing on a Moving Subject)

Notes About Subject Tracking Mode

- Adjust zoom position, flash mode, exposure compensation, and menu settings prior to registering the subject.
- Subject tracking may not be possible in certain shooting conditions.
- Digital zoom cannot be used.

Changing Subject Tracking Mode Settings





- Features that can be set using the multi selector (📖61): Flash mode (📖62), exposure compensation (📖66)
- Features that can be set by pressing the **MENU** button: Options available in the subject tracking menu (📖59).

Options Available in the Subject Tracking Menu

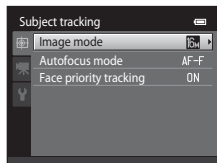
When using  subject tracking mode, the following settings can be changed.

Select subject tracking mode → **MENU** button



Option	Description	
Image mode	Allows you to select the combination of image size and image quality used when saving images (📖69). If you change the image mode setting, the new setting is applied to all shooting modes.	69
Autofocus mode	Set Autofocus mode (📖40) used for subject tracking mode. When Full-time AF (default setting) is selected, once a subject is registered for subject tracking, the camera continuously focuses until the shutter-release button is pressed halfway to lock the focus. The sound of the lens drive will be heard while the camera focuses. Changes made to the autofocus mode setting in this mode will not be applied to the autofocus mode setting in  (auto) mode. The autofocus mode setting applied in subject tracking mode is saved in the camera's memory even after the camera is turned off.	 48
Face priority tracking	When On is selected (default setting), if the camera detects a person's face, that person is automatically registered as the subject to be tracked, and subject tracking begins tracking that person. If a person whom you do not want to track is automatically registered, or when shooting non-human subjects, select Off if a person is in the frame.	 48

Notes About Face Priority Tracking

- Only one subject can be tracked. If the camera detects multiple faces at the same time, the face closest to the center of the frame is tracked.
- When the frame includes more than one face, the face detected by the camera and registered as the subject to be tracked depends upon a variety of factors, including the direction in which the faces are looking.
- Depending on shooting conditions, such as whether or not the subject is facing the camera, the face may not be detected properly. Additionally, the camera may be unable to detect faces in the following situations:
 - When faces are partially hidden by sunglasses or otherwise obstructed
 - When faces take up too much or too little of the frame
- When the camera is unable to track the registered subject, press the **OK** button to track again, or set **Face priority tracking** to **Off**, frame the picture so that the subject is inside the border in the center of the frame, and press the **OK** button to register the subject again.

Features That Can Be Set Using the Multi Selector

When shooting, the multi selector **▲** (⚡), **▼** (🌸), **◀** (🕒), and **▶** (📷) can be used to set the following features.

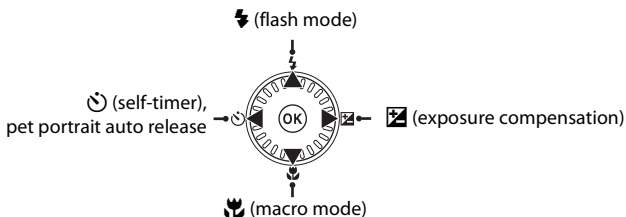

Available Features

The features that are available vary with the shooting mode, as shown below.

- See “Default Settings” (📖67) for information about each mode’s default settings.

	📷 (auto)	Scene	Special Effects	Smart Portrait Mode	Subject Tracking Mode
⚡ Flash mode (📖62)	✓	1	✓	✓ ²	✓
🕒 Self-timer (📖64)	✓		✓	✓ ²	–
🕒 Pet portrait auto release (📖49)	–		–	–	–
🌸 Macro (📖65)	✓		✓	–	–
📷 Exposure compensation (📖66)	✓		✓	✓	✓

¹ Varies by the scene. See “Default Settings” (📖67) for more information.

² Varies by the smart portrait menu setting. See “Default Settings” (📖67) for more information.

Using the Flash (Flash Modes)

You can set the flash mode to match the shooting conditions.

- 1 Press the multi selector ▲ (⚡ flash mode).



- 2 Use the multi selector to select the desired mode and press the OK button.

- See “Available Flash Modes” (📖63) for more information.
- If a setting is not applied by pressing the OK button within a few seconds, the selection will be canceled.
- When ⚡AUTO (auto) is applied, ~~⚡~~AUTO is only displayed for a few seconds, regardless of the setting in **Monitor settings** (📖94).

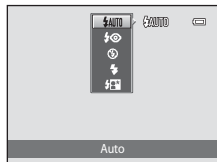

- 3 Frame the subject and take a picture.



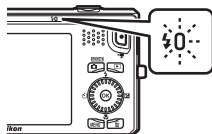

- The flash lamp indicates the status of the flash when you press the shutter-release button halfway.
 - On: The flash will fire when you press the shutter-release button all the way down.
 - Flashing: The flash is charging. The camera cannot take pictures.
 - Off: The flash will not fire when a picture is taken.
- If the battery is low, the monitor will turn off in order to save power while the flash is charging.



Effective Range of the Flash

When ISO sensitivity is set to **Auto**, the flash has a range of 0.5 to 5.6 m (1 ft 8 in. to 18 ft) at the maximum wide-angle zoom position and a range of 1.0 to 3.1 m (3 ft 4 in. to 10 ft) at the maximum telephoto zoom position.

Available Flash Modes

 AUTO	Auto
	The flash fires automatically when lighting is dim.
	Auto with red-eye reduction
	Reduce red-eye in portraits caused by the flash.
	Off
	The flash will not fire. We recommend using a tripod to stabilize the camera when shooting in dark surroundings.
	Fill flash
	The flash fires whenever a picture is taken. Use to “fill-in” (illuminate) shadows and backlit subjects.
	Slow sync
	Auto flash mode is combined with slow shutter speed. Suited to evening and night portraits that include background scenery. The flash illuminates main subject; slow shutter speeds are used to capture background at night or under dim lighting.

The Flash Mode Setting

- The setting varies with the shooting mode. See “Available Features” (📖61) and “Default Settings” (📖67) for more information.
- Some settings cannot be used with other functions (📖71).
- The flash mode setting applied in  (auto) mode is saved in the camera’s memory even after the camera is turned off.

Red-eye Reduction

This camera uses **Advanced Red-Eye Reduction** (In-Camera Red-Eye Fix).

If the camera detects red eye while saving an image, the affected area will be processed to reduce red-eye before the image is saved.

Note the following when shooting:

- More time than usual is required to save images.
- Red-eye reduction may not produce the desired results in all situations.
- In some cases, red-eye correction may be applied to areas of an image unnecessarily. In these cases, select another flash mode and take the picture again.

Using the Self-timer

The camera is equipped with a self-timer that releases the shutter ten seconds or two seconds after you press the shutter-release button. The self-timer is useful when you want to be in the picture you are taking, and when you want to avoid the effects of camera shake that occur when you press the shutter-release button. When using the self-timer, use of a tripod is recommended. Set **Vibration reduction to Off** in the setup menu (📖94) when using a tripod to stabilize the camera during shooting.

1 Press the multi selector ◀ (🕒 self-timer).

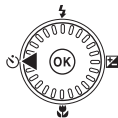

2 Use the multi selector to select 🕒 10s or 🕒 2s and press the OK button.

- 🕒 10s (ten seconds): Use on important occasions, such as weddings.
- 🕒 2s (two seconds): Use to prevent camera shake.
- When the shooting mode is the **Pet portrait** scene mode, 📷 (pet portrait auto release) is displayed (📖49). The self-timer settings 🕒 10s and 🕒 2s cannot be used.
- If a setting is not applied by pressing the OK button within a few seconds, the selection will be canceled.

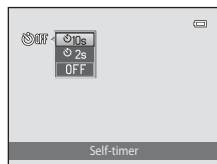

3 Frame the picture and press the shutter-release button halfway.

- Focus and exposure will be set.

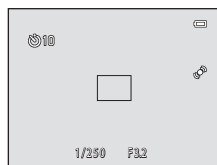

4 Press the shutter-release button the rest of the way down.

- The self-timer starts, and the number of seconds remaining before the shutter is released is displayed in the monitor. The self-timer lamp flashes while the timer is counting down. About one second before the shutter is released, the lamp stops flashing and glows steadily.
- When the shutter is released, the self-timer will be set to **OFF**.
- To stop the timer before a picture is taken, press the shutter-release button again.

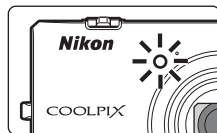
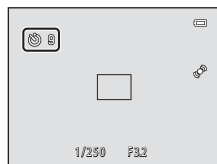

Using Macro Mode

When using macro mode, the camera can focus on objects as close as 10 cm (4 in.) from the front of the lens.

This feature is useful when taking close-up pictures of flowers and other small subjects.

- 1 Press the multi selector ▼ (🌸 macro mode).



- 2 Use the multi selector to select **ON** and press the **OK** button.

- The macro mode icon (🌸) is displayed.
- If a setting is not applied by pressing the **OK** button within a few seconds, the selection will be canceled.

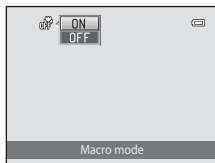

- 3 Use the zoom control to set the zoom ratio to a position where 🌸 and the zoom indicator glow green.

- How close you can be to the subject when shooting depends on the zoom ratio. When the zoom ratio is set to a position where 🌸 and the zoom indicator glow green, the camera can focus on subjects as close as 30 cm (1 ft) from the lens. When the zoom is at the maximum wide-angle position, (at the position where 🌄 is displayed), the camera can focus on subjects as close as 10 cm (4 in.) from the lens.



✓ Notes About Using the Flash

The flash may be unable to light the entire subject at distances of less than 50 cm (1 ft 8 in.).

📎 Autofocus

When using macro mode in the 📷 (auto) mode, you can focus without pressing the shutter-release button halfway by setting **Autofocus mode** (📖40) in the shooting menu (📖39) to **Full-time AF**. When using other shooting modes, **Full-time AF** is turned on automatically when macro mode is turned on (except when using the **Pet portrait** scene mode).

You may hear the sound of the camera focusing.

📎 The Macro Mode Setting

- Macro mode cannot be used when using certain shooting modes. See "Default Settings" (📖67) for more information.
- The macro mode setting applied in 📷 (auto) mode is saved in the camera's memory even after the camera is turned off, and reapplied the next time 📷 (auto) mode is selected.

Adjusting Brightness (Exposure Compensation)

By adjusting exposure compensation when taking pictures, you can adjust overall image brightness.

- 1 Press the multi selector ► (☒ exposure compensation).

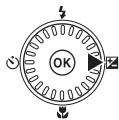

- 2 Use the multi selector to select a compensation value.

- To make the image brighter, apply positive (+) exposure compensation.
- To make the image darker, apply negative (-) exposure compensation.

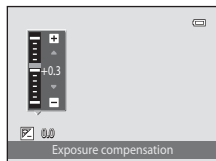

- 3 Press the **OK** button to apply the compensation value.

- If you do not press the **OK** button within a few seconds, the menu will disappear.
- When an exposure compensation value other than **0.0** is applied, the value is displayed with the ☒ indicator in the monitor.

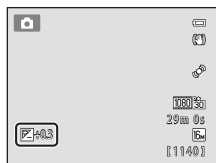

- 4 Press the shutter-release button to take a picture.

- To turn off exposure compensation, return to step 1 and change the value to **0.0**.

Exposure Compensation Value

The exposure compensation value applied in  (auto) mode is saved in the camera's memory even after the camera is turned off.

Default Settings

Default settings for each shooting mode are described below.

- Information about scene modes can be found on the next page.

	Flash (📖62)	Self-timer (📖64)	Macro (📖65)	Exposure compensation (📖66)
📷 (auto)	⚡AUTO	Off	Off	0.0
S0 (special effects)	Ⓢ	Off	Off	0.0
😊 (smart portrait)	⚡AUTO ¹	Off ²	Off ³	0.0
👤 (subject tracking)	⚡AUTO	Off ³	Off ³	0.0

¹ Cannot be used when **Blink proof** is set to **On**.





































² Can be set when **Smile timer** is set to **Off**.

³ The setting cannot be changed.

- The setting applied in 📷 (auto) mode is saved in the camera's memory even after the camera is turned off except for the self-timer setting.

Features That Can Be Set Using the Multi Selector

Default settings for scene modes are described below.

	Flash (☰62)	Self-timer (☰64)	Macro (☰65)	Exposure compensation (☰66)
 (☰42)	⚡AUTO ¹	Off	Off ²	0.0
 (☰42)		Off	Off ²	0.0
 (☰42)	 ²	Off	Off ²	0.0
 (☰43)	 ²	Off ²	Off ²	0.0
 (☰43)	 ³	Off	Off ²	0.0
 (☰44)	 ⁴	Off	Off ²	0.0
 (☰44)	⚡AUTO	Off	Off ²	0.0
 (☰44)	⚡AUTO	Off	Off ²	0.0
 (☰44)	 ²	Off	Off ²	0.0
 (☰44)	 ²	Off	Off ²	0.0
 (☰45)	 ²	Off	Off ²	0.0
 (☰45)	 ²	Off	On ²	0.0
 (☰46)	 ²	Off	On ²	0.0
 (☰46)	 ²	Off	Off	0.0
 (☰46)	 ²	Off ²	Off ²	0.0 ²
 (☰47)	 ²	Off	Off	0.0
 (☰47)	 ⁵	Off	Off ²	0.0
 (☰48)	 ²	Off ²	Off ²	0.0
 (☰49)	 ²	 ⁶	Off	0.0
3D (☰50)	 ²	Off ²	Off	0.0

¹ ⚡AUTO (auto) and  (off) can be selected. When ⚡AUTO (auto) is selected, the camera automatically selects the flash mode appropriate for the scene it has selected.

² The setting cannot be changed.

³ The setting cannot be changed. The flash mode setting is fixed at fill flash with red-eye reduction.

⁴ Slow sync with red-eye reduction flash mode may be used.

⁵ Flash is fixed at  (fill flash) when **HDR** is set to **Off**, and is fixed at  (off) when **HDR** is set to **On**.

⁶ Self-timer cannot be used. Pet portrait auto release can be turned on or off (☰49).

Camera Settings That Cannot Be Applied Simultaneously











Some settings cannot be used with other functions (☰71).

Changing the Image Size (Image Mode)

Enter shooting mode → MENU button → Image mode



You can use the **Image mode** setting in the shooting menu to select the combination of image size and compression ratio that is used when saving images. Select the image mode best suited to the manner in which images will be used and the capacity of the internal memory or memory card. The higher the image mode setting, the larger the size at which it can be printed, but the number of images that can be saved is reduced.

Image Mode Settings (Image Size and Quality)

Image mode*	Description
 4608×3456★	Images will be higher quality than  . The compression ratio is approximately 1:4.
 4608×3456 (default setting)	Best choice in most situations. The compression ratio is approximately 1:8.
 3264×2448	
 2272×1704	
 1600×1200	Smaller size than  ,  , or  and therefore allows more images to be saved. The compression ratio is approximately 1:8.
 640×480	Suited to full-screen display on a TV with an aspect ratio of 4:3, or distribution by e-mail. The compression ratio is approximately 1:8.
 4608×2592	Images with an aspect ratio of 16:9 are saved. The compression ratio is approximately 1:8.

* The total number of pixels captured, and the number of pixels captured horizontally and vertically.

Example:  **4608×3456** = approx. 16 megapixels, 4608 × 3456 pixels







The icon for the current setting is displayed in the monitor in shooting and playback modes (, ).

Notes About Image Mode

- The setting is also applied to other shooting modes.
- Some settings cannot be used with other functions ().
- The image mode cannot be selected in **3D photography** or **Easy panorama** scene mode (.

Number of Images That Can Be Saved

The following table lists the approximate number of images that can be saved in the internal memory and on a 4 GB memory card. Note that due to JPEG compression, the number of images that can be saved varies greatly depending on the composition of the image. In addition, this number may vary depending on the make of the memory card, even when the memory cards have the same specified capacity.

Image mode	Internal memory (approx. 25 MB)	Memory card ¹ (4 GB)	Print size ² (cm/in.)
 4608×3456★	2	590	Approx. 39 × 29/15 × 11.5
 4608×3456	4	1140	Approx. 39 × 29/15 × 11.5
 3264×2448	8	2230	Approx. 28 × 21/11 × 8
 2272×1704	18	4560	Approx. 19 × 14/7.5 × 5.6
 1600×1200	40	8610	Approx. 13 × 10/5.3 × 4
 640×480	132	24100	Approx. 5 × 4/2 × 1.5
 4608×2592	5	1470	Approx. 39 × 22/15 × 8.5

¹ If the number of exposures remaining is 10,000 or more, the number of exposures remaining display shows "9999".

² Print size at an output resolution of 300 dpi. Print sizes are calculated by dividing the number of pixels by printer resolution (dpi) and multiplying by 2.54 cm (1 in.). However, at the same image size, images printed at higher resolutions will print smaller than the size indicated, and those printed at lower resolutions will print larger than the size indicated.

Features That Cannot Be Used Simultaneously

Some shooting settings cannot be used with other functions.

Restricted function	Option	Description
Flash mode	Continuous (📖39)	When a setting other than Single is selected, the flash cannot be used.
	Blink proof (📖56)	When Blink proof is set to On , the flash cannot be used.
Self-timer	Smile timer (📖56)	When Smile timer is used for shooting, the self-timer cannot be used.
Image mode	Continuous (📖39)	<p>Image mode is set as follows depending on the continuous shooting setting:</p> <ul style="list-style-type: none"> • Continuous H: 120 fps: 📷 (image size: 640 × 480 pixels) • Continuous H: 60 fps: 📷 (image size: 1280 × 960 pixels) • Multi-shot 16: 📷 (image size: 2560 × 1920 pixels)
White balance	Color options (📖40)	When using Black-and-white , Sepia , or Cyanotype , the White balance setting is fixed at Auto .
Continuous	Self-timer (📖64)	When using the self-timer, Continuous is fixed at Single .
ISO sensitivity	Continuous (📖39)	When Pre-shooting cache , Continuous H: 120 fps , Continuous H: 60 fps , or Multi-shot 16 is selected, the ISO sensitivity setting is automatically specified according to the brightness.
Print date	Continuous (📖39)	When Pre-shooting cache , Continuous H: 120 fps , Continuous H: 60 fps is selected, date and time cannot be imprinted on images.

Features That Cannot Be Used Simultaneously

Restricted function	Option	Description
Motion detection	Continuous (📖39)	When a setting other than Single or BSS is selected, Motion detection is disabled.
	ISO sensitivity (📖39)	When the ISO sensitivity is set to any setting other than Auto , Motion detection is disabled.
Blink warning	Continuous (📖39)	When a setting other than Single is selected, Blink warning is disabled.
Digital zoom	Continuous (📖39)	When Multi-shot 16 is selected, digital zoom cannot be used.
Shutter sound	Continuous (📖39)	When a setting other than Single is selected, the shutter sound is disabled.

✔ Notes About Digital Zoom

- Depending on the shooting mode or the current settings, digital zoom may not be available (📷74).
- When digital zoom is in effect, the camera focuses in the center of the frame.

Using Face Detection

In the following shooting modes, the camera uses face detection to automatically focus on human faces. If the camera detects more than one face, a double border is displayed around the face that the camera will focus on, and single borders are displayed around the other faces.

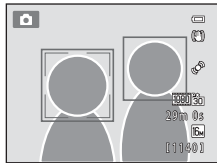

Shooting mode	Number of faces that can be detected	Focus area (double border)
When AF area mode (📖40) in 📷 (auto) mode is set to Face priority . Scene auto selector, Portrait, or Night portrait scene mode (📖41)	Up to 12	The face closest to the camera
Smart portrait mode (📖53)	Up to 3	The face closest to the center of the frame

* For more information about face detection while using subject tracking mode, see “Subject Tracking Mode (Focusing on a Moving Subject)” (📖57).

- When using **📷 (auto)** mode, if you press the shutter-release button halfway while no faces are detected or while framing a shot with no faces in it, the camera selects the focus area (up to nine areas) containing the subject closest to the camera.
- When **Scene auto selector** is selected, the focus area changes depending on which scene the camera selects.
- If no faces are detected when the shutter-release button is pressed halfway in **Portrait** and **Night portrait** scene modes or in smart portrait mode, the camera will focus on the subject in the center of the frame.

Notes About Face Detection

- The camera's ability to detect faces depends on a variety of factors, including whether or not the subject is facing the camera. Additionally, the camera may be unable to detect faces in the following situations:
 - When faces are partially hidden by sunglasses or otherwise obstructed
 - When faces take up too much or too little of the frame
- When the frame includes more than one face, the faces detected by the camera and the face on which the camera focuses depend upon a variety of factors, including the direction in which the faces are looking.
- In some rare cases, such as those described in "Subjects Not Suitable for Autofocus" (📖31), the subject may not be in focus even though the double border turns green. If the camera does not focus, change AF area mode to **Manual** or **Center** in  (auto) mode, and try focus lock shooting (📖76) by focusing on another subject that is the same distance from the camera.

Viewing Images That Were Captured Using Face Detection

- During playback, the camera automatically rotates images according to the orientation of the faces that were detected at the time of shooting (except when viewing an image captured in a series).
- When zooming in on an image displayed full-frame by rotating the zoom control to **T** (📖), the image will be enlarged so that the face that was detected at the time of shooting is displayed in the center of the monitor (📖33; except when viewing an image captured in a series).

Using Skin Softening

When the shutter is released when using one of the following shooting modes, the camera detects one or more human faces (up to three), and processes the image to soften facial skin tones before saving the image.

- **Scene auto selector** (📖42), **Portrait** (📖42), or **Night portrait** (📖43) scene mode is selected.
- Smart portrait mode (📖53)

Skin softening can also be applied to saved images (📖79).

✔ Notes About Skin Softening

- It may take more time than usual to save images after shooting.
- Under some shooting conditions, the desired skin softening results may not be achieved, and skin softening may be applied to areas of the image where there are no faces. If the desired results are not produced, switch to another shooting mode and then try shooting again.
- The skin softening level cannot be adjusted when shooting in **Portrait** or **Night portrait** scene mode, or when the camera selects one of these scenes while in scene auto selector scene mode.

Focus Lock

You can use focus lock to focus on off-center subjects when center is selected for AF area mode.

The following procedure describes how to use focus lock when using  (auto) mode with **AF area mode** (40) set to **Center**.

1 Position the subject in the center of the frame.

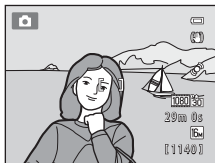

2 Press the shutter-release button halfway.

- Confirm that the focus area glows green.
- Focus and exposure are locked.



3 Continue holding down the shutter-release button halfway and recompose the picture.

- Be sure to maintain the same distance between the camera and the subject while the shutter-release button is pressed halfway.

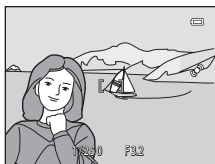

4 Press the shutter-release button the rest of the way down to take the picture.



Playback Features

This chapter describes how to select certain types of images for playback as well as some of the features available when playing back images.

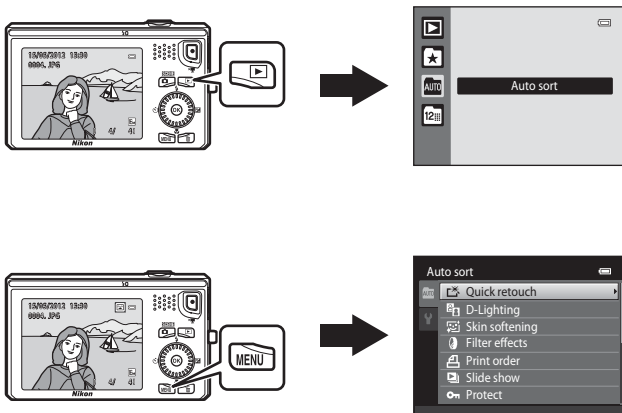

Selecting Certain Types of Images for Playback

You can change the playback mode according to the type of images you want to view.

Available Playback Modes

 **Play**  32

All images are played back. When you switch from shooting mode to playback mode, this mode is selected.

 **Favorite pictures**  7

Play back images added to an album. You must add images to an album before you can select this mode ( 80).

 **Auto sort**  10

Images are automatically sorted into categories, such as portraits, landscapes, and movies.

 **List by date**  12

Images captured on the selected date are played back.

Switching Between Playback Modes

1 When viewing images in full-frame playback mode or thumbnail playback mode, press the  button.

- The playback mode selection menu is displayed, from which you can select one of the available playback modes.







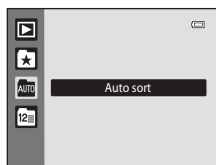

2 Use the multi selector to select the desired mode and press the  button.

- If you select **Play**, the playback screen is displayed.
- When an option other than **Play** is selected, the album, category, or shooting date selection screen is displayed.
- To return to the current playback mode without switching playback modes, press the  button.



















3 Select an album, category, or shooting date, and press the  button.











- For  favorite pictures, see  7.
- For  auto sort, see  10.
- For  list by date, see  12.
- Repeat from step 1 to select a different album, category, or shooting date.







Features Available in Playback Mode (Playback Menu)

When viewing images in full-frame playback mode or thumbnail playback mode, you can configure the menu operations listed below by pressing the **MENU** button. When using favorite pictures (★), auto sort (AUTO), or list by date (12) mode, the menu for the current playback mode is displayed.

Option	Description	
 Quick retouch ^{1,2}	Allows you to create retouched copies in which contrast and saturation have been enhanced.	 18
 D-Lighting ^{1,2}	Allows you to create copies with enhanced brightness and contrast, brightening dark portions of an image.	 18
 Skin softening ^{1,2}	When this feature is enabled, the camera detects faces in images and creates a copy with softer facial skin tones.	 19
 Filter effects ^{1,2}	Digital filter effects can be used to apply a variety of effects to images. Effect types include Soft, Selective color, Cross screen, Fisheye, Miniature effect, and Painting.	 20
 Print order ^{3,4}	When using a printer to print images saved on the memory card, you can use the Print order function to select which images are printed, and how many copies of each image are printed.	 49
 Slide show ³	Allows you to view images saved in the internal memory or on a memory card in an automatic slide show.	 53
 Protect ³	Protects selected images from accidental deletion.	 54
 Rotate image ^{2,4}	Specifies the orientation in which saved images are displayed during playback.	 56
 Small picture ^{1,2}	Creates a small copy of the current image. This feature is useful for creating copies for display on Web pages or e-mail attachments.	 21
 Voice memo ²	Allows you to use the camera's microphone to record voice memos and attach them to images. You can also play back and delete voice memos.	 57
 Copy ⁵	Allows you to copy images between the internal memory and a memory card.	 59

Features Available in Playback Mode (Playback Menu)

Option	Description	
 Sequence display options	Allows you to select whether to display only the key picture for a sequence of images captured continuously or to display the sequence as individual images.	 61
 Choose key picture	Allows you to change the key picture for images captured in sequence (sequence of images;  32). When making this setting, first select an image from the sequence you want to change before pressing the MENU button.	 61
 Favorite pictures	Allows you to add images to an album. This option is not displayed in favorite pictures mode.	 7
 Remove from favorites	Allows you to remove images from an album. This option is displayed only in favorite pictures mode.	 8

¹ Images are edited and saved as separate files. Certain restrictions apply (16, 17). For example, images captured at an **Image mode** (69) setting of  **4608x2592** or images captured with **Easy panorama** (48) or **3D photography** (50) cannot be edited, and the same editing feature cannot be applied multiple times.

² This function is not available when only the key pictures are displayed for sequences of images. To use this function, press the  button to display the images in a sequence individually.

³ When using list by date mode, press the **MENU** button from the list of dates screen (12) to apply the same function to all images captured on the selected date.

⁴ This function is not available for images captured in **3D photography** scene mode (41).

⁵ This function is not displayed when using favorite pictures mode, auto sort mode, or list by date mode.

Connecting the Camera to a TV, Computer, or Printer

You can enhance your enjoyment of images and movies by connecting the camera to a TV, computer, or printer.

- Before connecting the camera to an external device, make sure the remaining battery level is sufficient and turn the camera off. For information about the connection methods and subsequent operations, refer to the documentation included with the device in addition to this document.

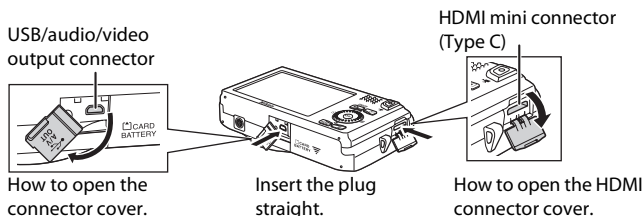

Viewing images on a TV

23



Images and movies captured with the camera can be viewed on a TV. Connection method: Connect the video and audio plugs of the included Audio Video Cable EG-CP16 to the TV's input jacks. Alternatively, connect a commercially available HDMI cable (Type C) to the TV's HDMI input jack.

Viewing and organizing images on a computer

82



If you transfer images to a computer, you can perform simple retouching and manage image data in addition to playing back images and movies.

Connection method: Connect the camera to the computer's USB port with the included USB Cable UC-E6.

- Before connecting to a computer, install ViewNX 2 on the computer using the included ViewNX 2 Installer CD-ROM. For information about using the ViewNX 2 Installer CD-ROM and transferring images to a computer, see page 82.
- If any USB devices that draw the power from the computer are connected, disconnect them from the computer before you connect the camera to it. Connecting the camera and other USB-powered devices to the same computer simultaneously may cause a camera malfunction or excessive power supply from the computer, which could damage the camera or memory card.

Printing images without using a computer

26



If you connect the camera to a PictBridge-compatible printer, you can print images without using a computer.

Connection method: Connect the camera directly to the printer's USB port with the included USB Cable UC-E6.

Using ViewNX 2

ViewNX 2 is an all-in-one software package which enables you to transfer, view, edit and share images.

Install ViewNX 2 using the included ViewNX 2 Installer CD-ROM.



Installing ViewNX 2

- An Internet connection is required.

Compatible Operating Systems

Windows

- Windows 7 Home Basic/Home Premium/Professional/Enterprise/Ultimate (Service Pack 1)
- Windows Vista Home Basic/Home Premium/Business/Enterprise/Ultimate (Service Pack 2)
- Windows XP Home Edition/Professional (Service Pack 3)

Macintosh

- Mac OS X (version 10.5.8, 10.6.8, 10.7.2)

Refer to the Nikon website for the latest information on operating system compatibility.

- 1** Start the computer and insert the ViewNX 2 Installer CD-ROM into the CD-ROM drive.

- Mac OS: When the **ViewNX 2** window is displayed, double-click the **Welcome** icon.

2 Select a language in the language selection dialog to open the installation window.

- If the desired language is not available, click **Region Selection** to choose a different region and then choose the desired language (the **Region Selection** button is not available in the European release).
- Click **Next** to display the installation window.



3 Start the installer.

- We recommend clicking **Installation Guide** in the installation window to check the installation help information and system requirements before installing ViewNX 2.
- Click **Typical Installation (Recommended)** in the installation window.

4 Download the software.

- When the **Software Download** screen is displayed, click **I agree - Begin download**.
- Follow the on-screen instructions to install the software.

5 Exit the installer when the installation completion screen is displayed.

- Windows: Click **Yes**.
- Mac OS: Click **OK**.

The following software is installed:

- ViewNX 2 (consisting of the three modules below)
 - Nikon Transfer 2: For transferring images to the computer
 - ViewNX 2: For viewing, editing, and printing transferred images
 - Nikon Movie Editor: For basic editing of transferred movies
- Panorama Maker 6 (for creating a single panorama image of a landscape, etc. from a series of images that each capture a separate portion of the subject)

6 Remove the ViewNX 2 Installer CD-ROM from the CD-ROM drive.

Transferring Images to the Computer

1 Choose how images will be copied to the computer.

Choose one of the following methods:

- **Direct USB connection:** Turn the camera off and ensure that the memory card is inserted in the camera. Connect the camera to the computer using the supplied USB Cable UC-E6. The camera automatically turns on. To transfer images that are saved in the camera's internal memory, remove the memory card from the camera before connecting it to the computer.

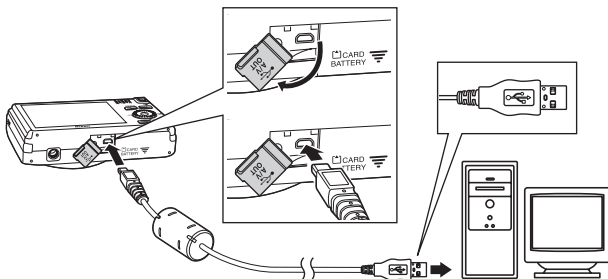

- **SD card slot:** If your computer is equipped with an SD card slot, the card can be inserted directly in the slot.
- **SD card reader:** Connect a card reader (available separately from third-party suppliers) to the computer and insert the memory card.

If a message is displayed prompting you to choose a program, select Nikon Transfer 2.

• When using Windows 7

If the dialog shown at right is displayed, follow the steps below to select Nikon Transfer 2.

- 1 Under **Import pictures and videos**, click **Change program**. A program selection dialog will be displayed; select **Import File using Nikon Transfer 2** and click **OK**.
- 2 Double-click **Import File**.



If the memory card contains a large number of images, it may take a while for Nikon Transfer 2 to start. Wait until Nikon Transfer 2 starts.

✓ Connecting the USB Cable

The connection may not be recognized if the camera is connected to the computer via a USB hub.

2 Transfer images to the computer.

- Confirm that the name of the connected camera or removable disk is displayed as the "Source" on the "Options" title bar of Nikon Transfer 2 (①).
- Click **Start Transfer** (②).

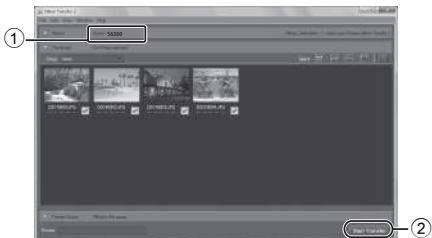

- At default settings, all the images on the memory card will be copied to the computer.

3 Terminate the connection.

- If the camera is connected to the computer, turn the camera off and disconnect the USB cable. If you are using a card reader or card slot, choose the appropriate option in the computer operating system to eject the removable disk corresponding to the memory card and then remove the card from the card reader or card slot.

Viewing Images

Start ViewNX 2.

- Images are displayed in ViewNX 2 when transfer is complete.
- Consult online help for more information on using ViewNX 2.



Starting ViewNX 2 Manually

- **Windows:** Double-click the **ViewNX 2** shortcut on the desktop.
- **Mac OS:** Click the **ViewNX 2** icon in the Dock.



A series of horizontal dashed lines spanning the width of the page, intended for handwriting practice. There are 15 lines in total, starting from the top right and extending to the bottom left.

Recording and Playing Back Movies

You can record movies by simply pressing the  (movie-record) button.

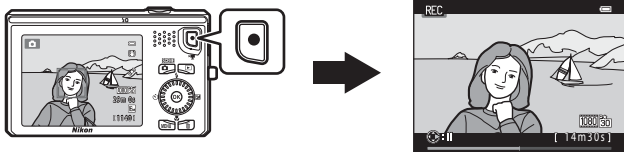

In playback mode, press the  button to play a movie.

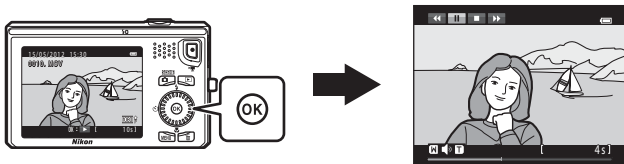

Recording Movies

You can record movies by simply pressing the **●** (▶ movie-record) button. The settings made for still images, such as hue and white balance, are applied when recording movies.

1 Display the shooting screen.

- The icon for the selected movie option is displayed. The default setting is **1080p30 HD 1080p★ (1920×1080)** (91).
 - * The remaining recording time shown in the illustrations in this manual is for example purposes only.

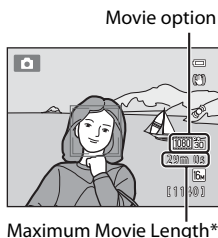

2 Press the **●** (▶ movie-record) button to start movie recording.

- The camera focuses on the subject in the center of the frame. Focus areas are not displayed during recording.
- When an option with 16:9 aspect ratio, such as **1080p30 HD 1080p★ (1920×1080)**, is selected for **Movie options**, the monitor display changes to an aspect ratio of 16:9 with movie recording (the area indicated on the right is recorded).
- If **Photo info** in the **Monitor settings** (94) in the setup menu is set to **Movie frame+auto info**, the area that will be visible in the movie can be confirmed before movie recording starts.
- The approximate remaining movie length is displayed. **M** is displayed while saving to the internal memory.
- Press the multi selector ▶ to pause recording (except when **iFrame 540 (960×540)** is selected in **Movie options** or when HS movie recording; 91). Press ▶ again to resume recording.
- Recording automatically stops about five minutes after recording is paused or when the maximum movie length has been recorded.

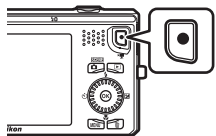

3 Press the **●** (▶ movie-record) button again to end recording.

✓ Note on Recording Images and Saving Movies

The indicator showing the number of exposures remaining or the indicator showing the maximum movie length flashes while images are being recorded or while a movie is being saved. **Do not open the battery-chamber/memory card slot cover or remove the battery or memory card** while an indicator is flashing. Doing this could result in loss of data, or in damage to the camera or the memory card.

✓ Notes About Movie Recording

- Memory cards with an SD Speed Class rating of 6 or faster are recommended when recording movies (📖31). Movie recording may stop unexpectedly when memory cards with a lower Speed Class rating are used.
- There may be some degradation in image quality when digital zoom is used. When recording movies, the digital zoom can magnify the image up to 4x the maximum optical zoom ratio.
- When recording ends, digital zoom turns off.
- The sounds of zoom control operation, zoom, autofocus lens drive movement, vibration reduction, and aperture operation when brightness changes may be recorded.
- The following phenomena may be seen in the monitor while recording movies. These phenomena are saved in the recorded movies.
 - Banding may occur in images under fluorescent, mercury-vapor, or sodium-vapor lighting.
 - Subjects that move quickly from one side of the frame to the other, such as a moving train or car, may appear skewed.
 - The entire movie image may be skewed when the camera is panned.
 - Lighting or other bright areas may leave residual images when the camera is moved.
- Depending on the distance to the subject or the amount of zoom applied, subjects with repeating patterns (fabrics, lattice windows, etc.) may have colored stripes (interference patterns, moire, etc.) in them during movie recording and playback. This occurs when the pattern in the subject and the layout of the image sensor interfere with each other; it is not a malfunction.

✓ Camera Temperature

- The camera may become warm when shooting movies for an extended period of time or when the camera is used in a hot area.
- If the inside of the camera becomes extremely hot when recording movies, the camera will automatically stop recording after 30 seconds. The amount of time remaining until the camera stops recording (🕒30 s) is displayed. Five seconds after the camera stops recording, it turns itself off. Leave the camera off until the inside of the camera has cooled.

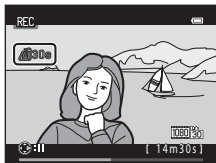





✓ Notes About Autofocus

Autofocus may not perform as expected (📖31). Should this occur, try the following:

1. Set **Autofocus mode** in the movie menu to **AF-S Single AF** (default setting) before starting movie recording.
2. Frame another subject—positioned at the same distance from the camera as the intended subject—in the center of the frame, press the **● (📷 movie-record)** button to start recording, and then modify the composition.



Movie Options and Maximum Movie Length

Movie options (📖91)	Internal memory (approx. 25 MB)	Memory card (4 GB)*
 HD 1080p★ (1920×1080) (default setting)	11 s	35 min
 HD 1080p (1920×1080)	14 s	40 min
 HD 720p (1280×720)	25 s	50 min
 iFrame 540 (960×540)	7 s	20 min
 VGA (640×480)	56 s	2 h 30 min

All figures are approximate. The maximum movie length may vary depending on the make of the memory card, even among memory cards of the same capacity.

* The maximum file size for a single movie is 4 GB and the maximum movie length for a single movie is 29 minutes, even when there is sufficient free space on the memory card for longer recording. When recording a movie, the remaining recording time that is displayed is the amount of recording time available for one movie.

Functions Available with Movie Recording





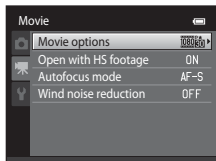

- The exposure compensation, white balance, and color options settings for the current shooting mode are also applied with movie recording. The tone that results from using scene mode (📖41) or special effects mode (📖51) is also applied to movies. When macro mode is enabled, movies of subjects closer to the camera can be recorded. Confirm settings before starting movie recording.
- The self-timer (📖64) can be used. When the  (movie-record) button is pressed after the self-timer is enabled, the camera focuses on the subject in the center of the frame and starts movie recording after the specified two or ten seconds.
- The flash will not fire.
- Press the **MENU** button to select the  (movie) tab and adjust movie menu settings before starting movie recording (📖91).

Changing Movie Recording Settings (the Movie Menu)

Enter shooting mode → MENU button →  tab (11)

The following settings can be changed.



Option	Description	
Movie options	<p>Select the movie type.</p> <ul style="list-style-type: none"> Select either normal speed movies or HS (high speed) movies, which enable slow motion or fast motion playback. To record HS movies, select an HS movie option. 	 62
Open with HS footage	<p>When you select an HS movie option in Movie options, choose from On (default setting) or Off to determine whether or not the camera records HS movies when movie recording starts.</p> <ul style="list-style-type: none"> When Off is selected, the camera records a normal speed movie when recording starts. Press the  button to switch back and forth between HS movie recording and normal speed movie recording. 	 63
Autofocus mode	<p>When AF-S Single AF (default setting) is selected, focus is locked when movie recording begins. When AF-F Full-time AF is selected, the camera focuses continuously while recording.</p> <p>When AF-F Full-time AF is selected, the sound of the camera focusing may be heard in recorded movies. If you want to prevent the sound of the camera focusing from being recorded, select AF-S Single AF.</p> <ul style="list-style-type: none"> When an HS movie option is selected in Movie options, the setting is fixed at AF-S Single AF. 	 64
Wind noise reduction	<p>Set whether or not to reduce wind noise during movie recording.</p> <ul style="list-style-type: none"> When an HS movie option is selected in Movie options, the setting is fixed at OFF Off. 	 64

Playing Back Movies

Press the  button to enter playback mode.

Movies are indicated by the movie options icon (91).



Press the  button to play back movies. **Movie options**



Functions Available During Playback

Rotate the multi selector to advance or rewind the movie.





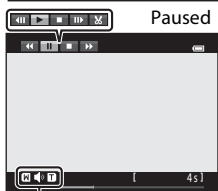













Playback controls are displayed at the top of the monitor.

Press the multi selector  or  to select a control. The operations described below are available.



Volume indicator

During playback





Function	Icon	Description
Rewind		Hold down the  button to rewind the movie.*
Advance		Hold down the  button to advance the movie.*
Pause		Press the  button to pause playback. The following operations can be performed while playback is paused using the controls displayed at the top in the monitor.
		 Press the  button to rewind the movie one frame. Hold down the  button for continuous rewinding.*
		 Press the  button to advance the movie one frame. Hold down the  button for continuous advancing.*
		 Press the  button to resume playback.
	 Press the  button to display the movie edit screen, which allows you to cut out unwanted portions of a movie and save the desired portion.	
End		Press the  button to return to full-frame playback mode.

* The movie can also be advanced or rewound by rotating the multi selector.

Adjusting volume

Rotate the zoom control to **T** or **W** (2) during playback.

Deleting movies

To delete a movie, select the desired movie in full-frame playback mode (32) or thumbnail playback mode (33) and press the  button (34).



Notes About Playing Back Movies

The COOLPIX S6300 is not able to play back movies recorded with another make or model of digital camera.

General Camera Setup

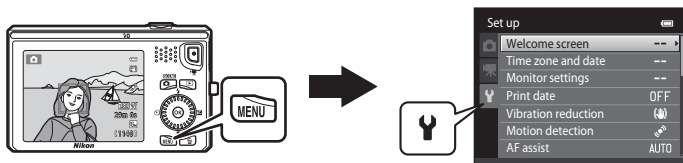
This chapter describes the various settings that can be adjusted in the  setup menu.



- See “Using Menus (the **MENU** Button)” ( 11) for information about using the camera’s menus.
- For further details about each setting, refer to “The Setup Menu” in the Reference Section ( 65).







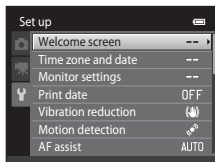







The Setup Menu

Press the **MENU** button → **Y** (setup) tab (📖11)













The following settings can be changed in the setup menu by selecting the **Y** tab.



Option	Description	📖
Welcome screen	Allows you to select the image displayed as the welcome screen when the camera is turned on. Select COOLPIX to display the COOLPIX logo. Select Select an image to use a picture taken with the camera as the welcome screen. The welcome screen is not displayed by default.	🔑65
Time zone and date	Allows you to set settings related to the camera's date and time. The Time zone setting allows you to specify the time zone where the camera is mainly used and whether or not daylight saving time is in effect. When the travel destination (📍) is selected, the camera automatically calculates the time difference between the travel destination and the home time zone (🏠), and saves images using the date and time of the travel destination.	🔑66
Monitor settings	Allows you to adjust settings related to the monitor. <ul style="list-style-type: none"> • Photo info allows you to select the kind of information that is displayed during shooting mode and playback mode. If you select Framing grid+auto info, a grid is displayed when shooting to help you frame the shot. • The Image review setting allows you to determine whether or not the captured image is displayed immediately after shooting. • Brightness allows you to adjust the brightness of the monitor. 	🔑69

Option	Description	
Print date	<p>Allows you to imprint the shooting date and time on images at the time of shooting. The default setting is Off.</p> <ul style="list-style-type: none"> The shooting date and time cannot be imprinted on images in the following situations: <ul style="list-style-type: none"> When using Night portrait (when Hand-held is selected), Night landscape (when Hand-held is selected), Easy panorama, or 3D photography scene mode When the continuous shooting setting (39) is set to Pre-shooting cache, Continuous H: 120 fps, or Continuous H: 60 fps. When shooting movies 	 71
Vibration reduction	<p>Allows you to reduce blurring caused by camera shake when shooting. The default setting is On.</p> <ul style="list-style-type: none"> When using a tripod to stabilize the camera during shooting, set this feature to Off to prevent this feature from malfunctioning. 	 72
Motion detection	<p>When set to Auto (default setting), if the camera detects camera shake or subject movement at the time of shooting, it automatically increases ISO sensitivity and shutter speed to reduce blurring. The  indicator glows green when the camera detects camera shake and increases shutter speed.</p> <ul style="list-style-type: none"> When using certain shooting modes or settings, motion is not detected. In these cases the  indicator is not displayed. 	 73
AF assist	<p>When set to Auto (default setting), the AF-assist illuminator (2) lights when shooting in dark surroundings to help the camera focus.</p> <ul style="list-style-type: none"> The illuminator has a range of about 1.9 m (6 ft 3 in.) at the maximum wide-angle position and about 1.1 m (3 ft 7 in.) at the maximum telephoto position. Even if Auto is selected, the AF-assist illuminator may not light depending on the position of the focus area or the scene mode that is selected. 	 74
Digital zoom	<p>When set to On (default setting), if you rotate the zoom control to T () when the camera is already zoomed in to the maximum optical zoom position, the digital zoom is activated (29).</p>	 74
Sound settings	<p>Allows you to turn various camera sounds on and off.</p> <ul style="list-style-type: none"> Camera operation sounds are disabled when using certain modes, such as the Pet portrait scene mode. 	 75
Auto off	<p>Allows you to set the amount of time that passes before the monitor turns off to save power. The default setting is 1 min.</p>	 76

The Setup Menu

Option	Description	
Format memory/ Format card	<p>Allows you to format the internal memory (only when a memory card is not inserted) or the memory card (when a memory card is inserted).</p> <ul style="list-style-type: none"> • All data stored in the internal memory or on the memory card is deleted during formatting and cannot be restored. Be sure to save important images by transferring them to a computer before formatting. 	 77
Language	Allows you to change the camera's display language.	 78
TV settings	Set these settings to match your TV. You can select the video output mode (NTSC or PAL) and adjust HDMI output settings.	 79
Charge by computer	<p>When set to Auto (default setting), you can charge the camera's battery by connecting the camera to a computer (provided that the computer is able to supply power).</p> <ul style="list-style-type: none"> • When charging by computer, it may take more time to charge the battery than when using the Charging AC Adapter EH-69P. Additionally, when charging by computer and transferring images to the computer, it takes more time to charge the battery. 	 80
Blink warning	Immediately after taking a picture using face detection ( 73) (except when using smart portrait mode), if the camera detects a subject with closed eyes, the camera displays the message Did someone blink? , allowing you to check the image. The default setting is Off .	 82
Eye-Fi upload	Set whether or not to enable the function for sending images to a computer using a commercially available Eye-Fi card. The default setting is Disable .	 84
Filmstrip	When On is selected, thumbnails of previous and subsequent images are displayed at the bottom of the monitor when you rotate the multi selector quickly while viewing an image in full-frame display ( 32). The default setting is Off .	 85
Reset all	<p>Allows you to reset the camera's settings to their default values.</p> <ul style="list-style-type: none"> • Certain settings such as Time zone and date and Language are not reset. 	 86
Firmware version	View the current camera firmware version.	 89



Reference Section

The Reference Section provides detailed information and hints about using the camera.

Shooting

Using Easy Panorama (Shooting and Playback)	2
Using 3D Photography	5

Playback

Favorite Pictures Mode.....	7
Auto Sort Mode	10
List by Date Mode	12
Viewing and Deleting Images Captured Continuously (Sequence)	13
Editing Still Images	16
Connecting the Camera to a TV (Viewing Images on a TV).....	23
Connecting the Camera to a Printer (Direct Print)	25

Movies

Recording Movies in Slow Motion and Fast Motion (HS Movie)	31
Editing Movies	34

Menu





The Shooting Menu (for (Auto) Mode).....	36
The Smart Portrait Menu.....	46
The Subject Tracking Menu	48
The Playback Menu.....	49
The Movie Menu	62
The Setup Menu.....	65

Additional Information

File and Folder Names	90
Optional Accessories	91
Error Messages	92

Using Easy Panorama (Shooting and Playback)

Shooting with Easy Panorama

Enter shooting mode →  (shooting mode) button →  (second icon from the top*) →  →  (easy panorama)



* The icon of the last scene selected is displayed. The default setting is  (scene auto selector).

1 Choose **Normal (180°)** or **Wide (360°)** as the shooting range and press the button.

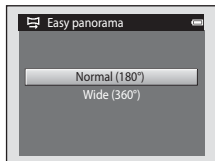
- When the camera is readied in the horizontal position, the image size (width × height) is as follows.
 - **Normal (180°)**: 3200 × 560 when moved horizontally, 1024 × 3200 when moved vertically
 - **Wide (360°)**: 6400 × 560 when moved horizontally, 1024 × 6400 when moved vertically
- When the camera is readied in the vertical position, the direction and the width and height are switched.



2 Frame the first edge of the panorama scene, and then press the shutter-release button halfway to focus.

- The zoom position is fixed at the maximum wide-angle position.
- A grid is displayed in the monitor.
- The camera focuses on the subject at the center of the frame.
- Exposure compensation ()66 can be set.
- If the focus and exposure are not correct, try using focus lock ()76).

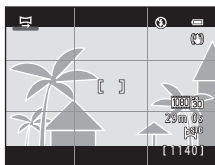

3 Press the shutter-release button all the way, and then remove your finger from the shutter-release button.

-  is displayed to indicate the direction of camera movement.



4 Move the camera slowly and straight in one of the four directions, and begin shooting.

- When the camera detects which direction it is moving in, shooting begins.
- A guide indicating the current shooting position is displayed.
- When the shooting position guide reaches the edge, shooting ends.



Guide

Example of camera movement

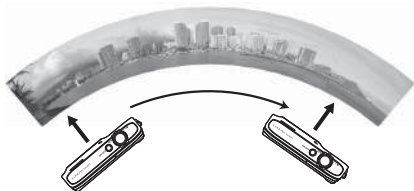

- The operator, without shifting position, moves the camera horizontally or vertically in an arc so that the guide travels from one edge to the other.
- Shooting stops if the guide does not reach the edge within about 15 seconds (when **Normal (180°)** is selected) or within about 30 seconds (when **Wide (360°)** is selected) after shooting starts.

✓ Notes About Easy Panorama Shooting

- The range of the image seen in the saved image will be narrower than that seen in the monitor at the time of shooting.
- If the camera is moved too quickly or shaken too much, or if the subject is too uniform (e.g. walls or darkness), an error may occur.
- If shooting is stopped before the camera reaches the half-way point in the panorama range, a panorama image is not saved.
- If more than half of the panorama range is captured but shooting ends before reaching the edge of the range, the range not captured is recorded and displayed in gray.

Viewing Images Captured with Easy Panorama

Switch to playback mode (📖32), display an image captured using easy panorama in full-frame playback mode, and then press the **OK** button to display the short edge of the image using the entire monitor and automatically move (scroll) the displayed area.

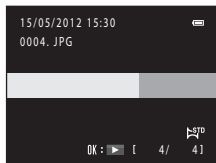

- The image scrolls in the direction that was used when shooting.
- Rotate the multi selector to advance or rewind. Playback controls are displayed at the top of the monitor during playback. Press the multi selector ◀ or ▶ to choose a control, and then press the **OK** button to perform the following operations.



Function	Icon	Description	
Rewind	⏮	Hold down the OK button to scroll backward quickly.*	
Advance	⏭	Hold down the OK button to scroll forward quickly.*	
Pause	⏸	The following operations can be performed while playback is paused using the controls displayed at the top in the monitor.	
		⏮	Hold down the OK button to rewind.*
		⏭	Hold down the OK button to scroll.*
		▶	Resume automatic scrolling.
End	■	Switch to full-frame playback mode.	



* Scrolling can also be performed by rotating the multi selector.

📌 Notes About Easy Panorama Scroll Playback

The COOLPIX S6300 may not be able to scroll the playback of, or zoom in on, easy panorama images captured with another make or model of digital camera.







Using 3D Photography

The camera captures one image for each eye to simulate a three-dimensional image on a 3D-compatible TV or monitor.

Enter shooting mode →  (shooting mode) button →  (second icon from the top*) →  → 3D (3D photography)

* The icon of the last scene selected is displayed. The default setting is  (scene auto selector).

1 Frame the subject.

- The focus area can be moved from the center of the frame to a different position. To move the focus area, before taking the first picture, press the  button, and then rotate the multi selector or press , , , or . To change settings for any of the following functions, first press the  button to cancel focus-area selection, then change the settings as desired.
 - Macro mode
 - Exposure compensation

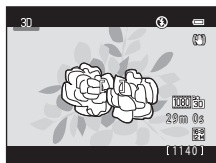

2 Press the shutter-release button to take the first picture.

- The focus, exposure, and white balance are locked after the first shot, and **AE/AF-L** is displayed on the monitor.



3 Move the camera horizontally to the right until the translucent guide is aligned with the subject.

- To cancel shooting, press the  button.

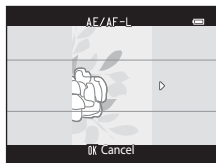

4 Wait for the camera to automatically take the second picture.

- The camera automatically captures the second image when it detects that the subject is aligned with the guide.
- Shooting is canceled if the subject is not aligned with the guide within approximately ten seconds.

Notes About 3D Photography

- Moving subjects are not suited to 3D photography. We recommend shooting still subjects.
- Images have a less pronounced 3D feel as the distance between the camera and background is increased.
- Images may have a less pronounced 3D feel when the subject is dark or when the second image is not aligned precisely.
- Be careful of camera shake when shooting with a high zoom ratio.
- The maximum telephoto zoom position is limited to an angle of view equivalent to that of 127 mm lens in 35mm [135] format.
- The angle of view (i.e., the area visible in the frame) seen in the saved image will be narrower than that seen in the monitor at the time of shooting.
- Images captured under dim lighting may appear grainy with noise.
- If the camera does not take the second picture and cancels the shooting even when you align the guide with the subject, try shooting with the shutter-release button.

Notes and Cautions for Viewing 3D Images



- 3D images cannot be played back in 3D on the camera monitor. See "Playing Back 3D Images" (p.50) for more information.
- When viewing 3D images on a 3D-compatible TV or monitor for an extended period of time, you may experience discomfort such as eye strain or nausea. Carefully read the documentation included with your TV or monitor to ensure proper use.

Favorite Pictures Mode





After shooting, you can add your favorite still images to albums; there are nine albums available. After you add images to an album, you can use favorite picture mode to view those images easily.







- By creating albums for certain subjects or events, you can find your favorite images easily.
- The same image can be added to multiple albums.
- Up to 200 images can be added to each album.

Adding Images to Albums

Press the  button (playback mode) → MENU button →  Favorite pictures

- Images cannot be added to albums in favorite pictures playback mode.

1 Rotate the multi selector or press  or  to choose an image and press  to display .

- You can add  to multiple images. To remove , press .
- Rotate the zoom control (2) to **T** () to switch back to full-frame playback or **W** () to 12-image thumbnail display.
- Press the  button to display the album selection screen.



2 Use the multi selector to select the desired album and press the  button.

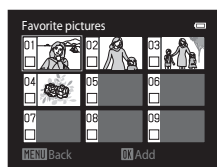

- The selected images are added and the camera switches to the playback menu.
- To add the same image to multiple albums, repeat from step 1.







Notes About Favorite Pictures

When images are added to an album, they are not moved from the folder to which they were saved (90) or copied to the album. Only the file names of the images are added to the album. When using favorite pictures mode, images are played back by retrieving the images that correspond to the file names added to the albums.

Playing Back Images in Albums



Press the  button (playback mode) →  button →  Favorite pictures



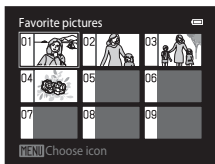

Use the multi selector to select an album and then press the  button to play back the images that have been added to the selected album.







- The following operations are available from the album selection screen.
 - MENU** button: Changes the album icon ()9).
 -  button: Deletes all images in the selected album.
- When viewing images in full-frame playback mode or thumbnail playback mode, press the **MENU** button to select a feature from the favorite pictures menu (79).



Removing Images from Albums

Enter  Favorite pictures mode → select the album containing the image you want to remove →  button → **MENU** button →  Remove from favorites

1 Rotate the multi selector or press  or  to choose an image and press  to display .

- You can add  to multiple images. To remove , press .
- Rotate the zoom control (2) to **T** () to switch back to full-frame playback or **W** () to 12-image thumbnail display.
- Press the  button to display a removal confirmation screen.





2 Select **Yes** and press the  button.

- To cancel removal, select **No**.



Notes About Deletion

If an image is deleted while using favorite pictures mode, the image will not only be removed from the album, but the corresponding image file will also be permanently deleted from the internal memory or the memory card.





Changing the Favorites Album Icon

Press the  button (playback mode) →  button →  Favorite pictures

1 Use the multi selector to select an album and press the **MENU** button.

2 Press  or  to select an icon color and press the **OK** button.



3 Press , , , or  to select an icon and press the **OK** button.

- The icon changes and the monitor display returns to the list of albums screen.

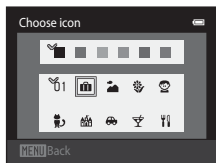





Notes About Album Icons



- Set the album icons separately for the internal memory and for the memory card.
- To change the album icons for the internal memory, first remove the memory card from the camera.
- The default setting for the icon is the number icon (black).

Auto Sort Mode

Images are automatically sorted into categories, such as portraits, landscapes, and movies.







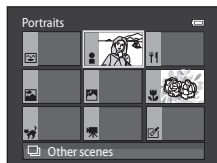

















Press the  button (playback mode) →  button →  Auto sort

Use the multi selector to select a category and then press the  button to play back the images in the selected category.

- The following operation is available while the category selection screen is displayed.
 -  button: Deletes all images in the selected category.
- When viewing images in full-frame playback mode or thumbnail playback mode, press the **MENU** button to select a feature from the auto sort menu (79).





Auto Sort Mode Categories



Option	Description
 Smile	Images captured in smart portrait mode ( 53) with the smile timer setting set to On
 Portraits	Images captured in  (auto) mode ( 26) with face detection ( 73) Images captured in Portrait* , Night portrait* , Party/indoor , and Backlighting* scene mode ( 41) Images captured in smart portrait mode ( 53) with the smile timer setting set to Off
 Food	Images captured in Food scene mode ( 41)
 Landscape	Images captured in Landscape* scene mode ( 41)
 Dusk to dawn	Images captured in Night landscape* , Sunset , Dusk/dawn , and Fireworks show scene mode ( 41)
 Close-ups	Images captured in  (auto) mode with macro mode ( 65) Images captured in Close-up* scene mode ( 41)
 Pet portrait	Images captured in the Pet portrait ( 49) scene mode
 Movie	Movies ( 88).
 Retouched copies	Copies created using editing functions ( 16)
 Other scenes	All other images that cannot be defined by the categories described above

* Images captured in scene auto selector scene mode (42) are also sorted to the appropriate categories.





Notes About Auto Sort Mode

- Up to 999 images and movie files can be sorted to each category in auto sort mode. If 999 images or movies have already been sorted to a specific category, new images and movies cannot be sorted to that category nor can they be displayed in auto sort mode. You can play back images and movies that could not be sorted to a category by using normal playback mode (32) or list by date mode (.
- Images and movies copied from the internal memory to a memory card, or vice versa, cannot be played back in auto sort mode (.
- Images or movies saved by a camera other than the COOLPIX S6300 cannot be played back in auto sort mode.

List by Date Mode

Press the  button (playback mode) →  button →  List by date

Use the multi selector to select a date and then press the  button to play back the images captured on the selected date.

- The first image that was captured on the selected date is displayed.
- The following operations are available while the shooting date selection screen is displayed.
 - **MENU** button: You can select one of the following functions in the list by date menu (79) and apply it to all images captured on the selected date.
 - print order, slide show, protect
 -  button: Deletes all images captured on the selected date.
- When viewing images in full-frame playback mode or thumbnail playback mode, press the **MENU** button to select a feature from the list by date menu (79).
- Calendar display (33) cannot be used in list by date mode.





Notes About List by Date Mode

- Up to 29 dates can be selected. If images exist for more than 29 dates, all images saved earlier than most recent 29 dates will be combined under **Others**.
- The 9,000 most recent images can be displayed in list by date mode.
- Images captured when the camera's date is not set are treated as images captured on January 1, 2012.

Viewing and Deleting Images Captured Continuously (Sequence)

Viewing Images in a Sequence





Each series of images captured using the following settings is saved in a sequence.

-  (auto) mode (38)
 - Continuous H
 - Continuous L
 - Pre-shooting cache
 - Continuous H: 120 fps
 - Continuous H: 60 fps
- Scene mode (41)
 - Sports
 - Pet portrait (when **Continuous** is selected)

By default, only the first image of a sequence (key picture) is displayed to represent the images in the sequence in full-frame playback mode or thumbnail playback mode (33).

- When only the key picture is displayed for a sequence, the picture cannot be zoomed in on.

When only the key picture is displayed for a sequence, press the  button to display each image in a sequence individually.

- To display the previous or next image, rotate the multi selector, or press  or .
- To return to key picture only display, press the multi selector .
- To display images in a sequence as thumbnails, set **Sequence display options** to **Individual pictures** in the playback menu (61).

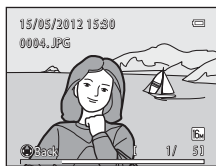

Sequence Display Options

- Select **Sequence display options** () in the playback menu to set all sequences to be displayed using their key pictures or to display them as individual images.
- Images captured continuously with cameras other than the COOLPIX S6300 cannot be displayed as a sequence.

Changing Key Picture in Sequence

A sequence's key picture can be changed using **Choose key picture** () in the playback menu.

Playback Menu Options Available When Using Sequence

When the **MENU** button is pressed, the following menu operations are available for the images in that sequence.

- Quick retouch¹ ()
- Skin softening¹ ()
- Print order² ()
- Protect² ()
- Small picture¹ ()
- Copy² ()
- Choose key picture ()
- D-Lighting¹ ()
- Filter effects¹ ()
- Slide show ()
- Rotate image¹ ()
- Voice memo¹ ()
- Sequence display options ()
- Favorite pictures² ()

¹ This operation is not available when only a key picture is displayed. Display the images in the sequence individually and then press the **MENU** button.

² If the **MENU** button is pressed when only a key picture displayed, the same settings can be applied to all images in that sequence. Press the **MENU** button after displaying individual images to apply settings to each displayed image.

Deleting Images in a Sequence

If **Sequence display options** (👁️61) in the playback menu is set to **Key picture only**, images to be deleted vary as described below. To display the screen for selecting the deletion method, press the 🗑️ button.

- If only key pictures are displayed for sequences when the 🗑️ button is pressed:
 - **Current image:** When a key picture is selected, all images in that sequence are deleted.
 - **Erase selected images:** When a key picture is selected in the erase selected images screen (📖35), all pictures in the sequence are deleted.
 - **All images:** All images are deleted, including the sequence represented by the currently displayed key picture.
- If the 🕒 button has been pressed and each individual image in the sequence is displayed before pressing the 🗑️ button:
Deletion methods change as follows.
 - **Erase current picture:** The image currently displayed is deleted.
 - **Erase selected images:** When multiple images in the sequence are selected in the erase selected images screen (📖35), the selected images are deleted.
 - **Erase entire sequence:** All images in the sequence, including the image currently displayed, are deleted.

Editing Still Images

Editing Features

Use the COOLPIX S6300 to edit images in-camera and save them as separate files (📷90). The editing functions described below are available.

Editing function	Description
Quick retouch (📷18)	Easily create retouched copies in which contrast and saturation have been enhanced.
D-Lighting (📷18)	Create a copy of the current image with enhanced brightness and contrast, brightening dark portions of the image.
Skin softening (📷19)	Make facial skin tones softer.
Filter effects (📷20)	Digital filter effects can be used to apply a variety of effects to images. Effect types include Soft , Selective color , Cross screen , Fisheye , Miniature effect , and Painting .
Small picture (📷21)	Create a small copy of images suitable for use as e-mail attachments.
Crop (📷22)	Crop a portion of the image. Use to zoom in on a subject or arrange a composition.

✓ Notes About Image Editing

- Images captured at an **Image mode** (📖69) setting of **4608x2592** cannot be edited.
- The editing functions of COOLPIX S6300 cannot be used for images captured with another make or model of digital camera.
- Images captured using **Easy panorama** (📖48) or **3D photography** (📖50) cannot be edited.
- If no face is detected in an image, a copy cannot be created using the skin softening function (📷19).
- Edited copies created with COOLPIX S6300 may not be displayed properly on another make or model of digital camera. It may also be impossible to transfer them to a computer using another make or model of digital camera.
- Editing functions are not available when there is not enough free space in the internal memory or on the memory card.
- To edit an individual image in a sequence of images (📷13) when only the key picture is displayed, perform one of the procedures described below:
 - Press the **OK** button to display a sequence of images as individual images and select an image in the sequence.
 - Set **Sequence display options** (📷61) in the playback menu to **Individual pictures** to display them as individual images and select an image.



Restrictions on Image Editing

When an edited copy is further modified with another editing function, check the following restrictions.



Editing function used	Editing functions to use
Quick retouch D-Lighting Filter effects	The skin softening, small picture, or crop function can be used. The quick retouch, D-Lighting, and filter effects functions cannot be used together.
Skin softening	The quick retouch, D-Lighting, filter effects, small picture, or crop function can be used.
Small picture Crop	Another editing function cannot be used.



- Copies created with editing functions cannot be further edited with the same function used to create them.
- When combining the small picture or crop function and another editing function, use the small picture and crop functions after other editing functions have been applied.
- You can apply skin softening to images that were captured using skin softening (46).



Original and Edited Images

- Copies created with editing functions are not deleted if the original images are deleted. The original images are not deleted if copies created with editing functions are deleted.
- Edited copies are saved with the same shooting date and time as the original.
- Print order (49) and protect settings (54) do not remain effective in edited copies.

Quick Retouch: Enhancing Contrast and Saturation



Press the  button (playback mode) → select an image → MENU button →  Quick retouch

Press the multi selector  or  to select the amount of effect applied and press the  button.

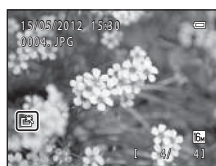
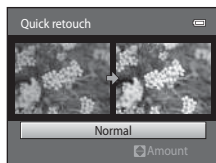
- The original version is displayed on the left and the edited version is displayed on the right.
- To exit without saving the copy, press .
- Copies created with the quick retouch function are indicated by the  icon displayed during playback.



D-Lighting: Enhancing Brightness and Contrast

Press the  button (playback mode) → select an image → MENU button →  D-Lighting

Use the multi selector to select **OK** and press the  button.

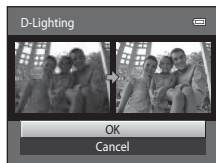

- The original version is displayed on the left and the edited version is displayed on the right.
- Copies created with the D-Lighting function are indicated by the  icon displayed during playback.



More Information

See "File and Folder Names" ( 90) for more information.

Skin Softening: Softening Skin Tones



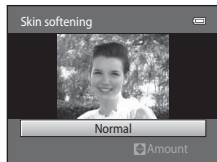

Press the  button (playback mode) → select an image → MENU button →  Skin softening

1 Press the multi selector ▲ or ▼ to select the degree of softening and press the button.

- The confirmation dialog is displayed with the face to which skin softening was applied enlarged at the center of the monitor.
- To exit without saving the copy, press .



2 Check the preview of the copy.

- Skin tones in up to 12 faces, in the order of that closest to the center of the frame, are softened.
- If more than one face was softened, press  or  to display a different face.
- Press the MENU button to adjust the degree of softening. The monitor display returns to that shown in step 1.
- When the  button is pressed, a new, edited copy is created.
- Copies created with the skin softening function are indicated by the  icon displayed during playback.

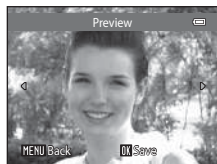



Notes About Skin Softening



- Depending upon the direction in which faces are looking, or the brightness of faces, the camera may be unable to accurately recognize faces, or the skin softening function may not perform as expected.
- If no faces are detected in the image, a warning is displayed and the screen returns to the playback menu.



More Information

See "File and Folder Names" ( 90) for more information.

Filter Effects: Applying Digital Filter Effects

Press the  button (playback mode) → select an image → MENU button →  Filter effects



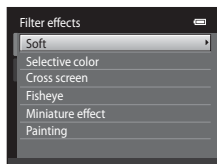

Type	Description
Soft	Soften the image by adding a slight blur around the center of the image. In images captured with face priority () or pet detection () selected, areas around faces will be blurred.
Selective color	Keep one specified color in the image, and change the other colors to black and white.
Cross screen	Produce star-like rays of light that radiate outward from bright objects such as sunlight reflections or street lights. This effect is suitable for night scenes.
Fisheye	Make an image look as if it were captured with a fisheye lens. This effect is well-suited for images captured in macro mode.
Miniature effect	Make an image look like a miniature scene captured in macro mode. This effect is well-suited for images captured from a high vantage point with the main subject at the center of the image.
Painting	Give images a hand-painted appearance.

1 Press the multi selector  or  to select the filter effect type and press the .

- When **Cross screen**, **Fisheye**, **Miniature effect**, or **Painting** is selected, proceed to step 3.



2 Adjust the effect and press the .

- When using **Soft**: Press  or  to select the range of the effect.
- When using **Selective color**: Rotate the multi selector, or press  or  to select the color to be retained.
- Press  to return to the **Filter effects** selection screen without making any changes.

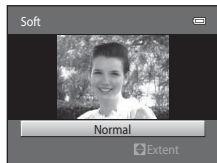

Example: **Soft**

3 Confirm the effect and press the **OK** button.

- A new, edited copy is created.
 - To exit without saving the copy, press **◀**.
-
- Copies created using the filter effects function are indicated by the **Ⓢ** icon displayed during playback.

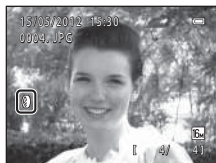
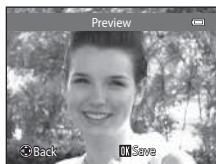

Small Picture: Reducing the Size of an Image

Press the **▶** button (playback mode) → select an image → **MENU** button → **Small picture**

1 Press the multi selector **▲** or **▼** to select the desired copy size and press the **OK** button.

- The available sizes are **640×480**, **320×240** and **160×120**.

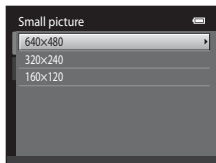

2 Select **Yes** and press the **OK** button.

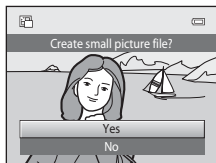

- A new, small copy is created (compression ratio of approximately 1:16).
- The copy is displayed with a black frame.



More Information







See "File and Folder Names" (0690) for more information.

Crop: Creating a Cropped Copy

Create a copy containing only the portion visible in the monitor when **MENU**  is displayed with playback zoom () enabled. Cropped copies are saved as separate files.

1 Enlarge the picture for cropping (.

2 Refine copy composition.

- Rotate the zoom control to **T** () or **W** () to adjust the zoom ratio.
- Press the multi selector , , , or  to scroll the image so that only the portion to be copied is visible in the monitor.



3 Press the **MENU** button.

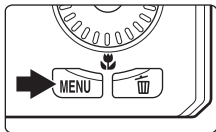

4 Use the multi selector to select **Yes** and press the  button.

- A cropped copy is created.



Image Size

As the area to be saved is reduced, the image size (pixels) of the cropped copy is also reduced. When the image size of the cropped copy is 320 × 240 or 160 × 120, a black frame is displayed around the image, and the small picture icon  is displayed in the left of the monitor in playback mode.

Cropping the Image in Its Current “Tall” Orientation

Use the **Rotate image** option () to rotate the image so that it is displayed in landscape orientation. After cropping the image, rotate the cropped image back to “tall” orientation. The image displayed in “tall” orientation can be cropped by zooming in on the image until the black bars displayed on the both sides of the monitor disappear. The cropped image is displayed in landscape orientation.

More Information

See “File and Folder Names” () for more information.

Connecting the Camera to a TV (Viewing Images on a TV)

Connect the camera to a TV to play back images or movies on the TV. If your TV is equipped with an HDMI jack, a commercially available HDMI cable can be used to connect the camera to the TV.

- 1 Turn off the camera.

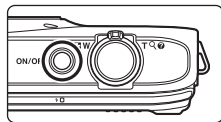

- 2 Connect the camera to the TV.

When using the included audio/video cable

Connect the yellow plug to the video-in jack and the white and red plugs to the audio-in jacks on the TV.

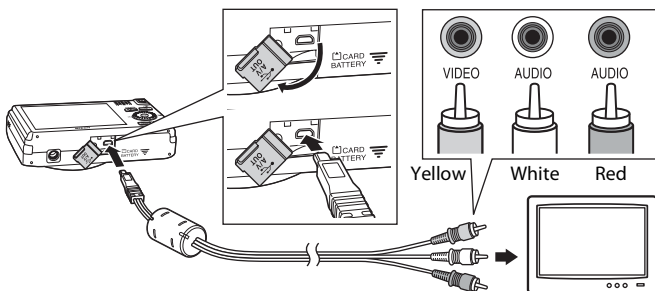

When using a commercially available HDMI cable

Connect the plug to the HDMI jack on the TV.

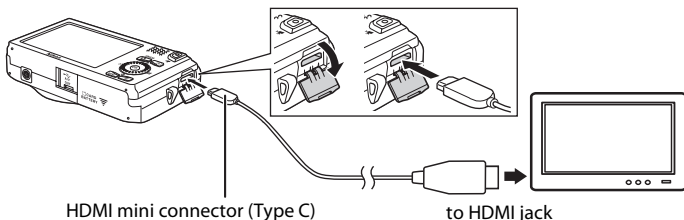

3 Set the TV's input to external video input.

- See the documentation provided with your TV for details.

4 Hold down the button to turn on the camera.

- The camera enters playback mode and images are displayed on the TV.
- While connected to the TV, the camera monitor will remain off.

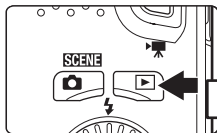

Notes About Connecting the HDMI Cable

An HDMI cable is not included. Use a commercially available HDMI cable to connect the camera to a high-definition TV. The output terminal on this camera is an HDMI mini connector (type C). When purchasing an HDMI cable, be sure that the device end of the cable is an HDMI mini connector.

Notes About Connecting the Cable

- When connecting the cable, be sure that the plug is properly oriented. Do not force the plug into the camera. When disconnecting the cable, do not pull the plug at an angle.
- Do not connect cables to the HDMI mini connector (Type C) and to the USB/audio/video output connector simultaneously.

If the Images Are Not Displayed on the TV

Be sure that the camera's video mode setting in the **TV settings** () under the setup menu conforms to the standard used by your TV.

Using a TV Remote Control (HDMI Device Control)

The remote control of an HDMI-CEC-compatible TV can be used to control playback.

It can be used instead of the camera's multi selector and zoom control to select images, start and pause movie playback, switch between full-screen playback mode and 4-image thumbnail display, etc.

- Set the **HDMI device control** setting () of **TV settings** to **On** (default setting) and then connect the camera and TV using an HDMI cable.
- Aim the remote control at the TV when operating it.
- Refer to the TV's operating instructions for information about the TV's HDMI-CEC compatibility.

Connecting the Camera to a Printer (Direct Print)

Users of PictBridge-compatible (🔦16) printers can connect the camera directly to the printer and print images without using a computer.

Follow the procedures below to print images.

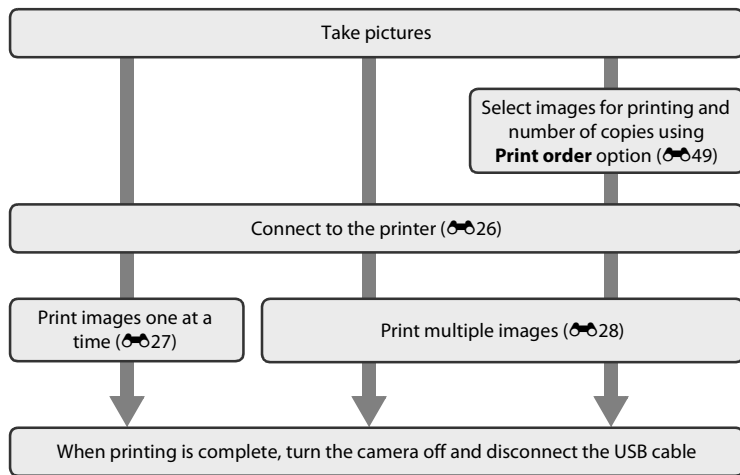

✔ Notes About Power Source

- When connecting the camera to a printer, use a fully charged battery to prevent the camera from turning off unexpectedly.
- If the AC Adapter EH-62F (available separately) is used, COOLPIX S6300 can be powered from an electrical outlet. Do not use any other make or model of AC adapter as it may cause the camera to heat up or malfunction.

📎 Printing Images

Images saved on a memory card can be printed by transferring the images to a computer or connecting the camera directly to a printer. The following printing methods are also available:

- Inserting a memory card into a DPOF-compatible printer's card slot
- Taking a memory card to a digital photo lab

For printing using these methods, specify the images and the number of prints each to the memory card using the **Print order** option in the playback menu (🔦49).

Connecting the Camera to a Printer

- 1 Turn off the camera.

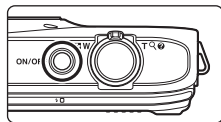

- 2 Turn on the printer.

- Check printer settings.

- 3 Connect the camera to the printer using the included USB cable.

- Be sure that plugs are properly oriented. Do not attempt to insert plugs at an angle, and do not use force when connecting or disconnecting the plugs.

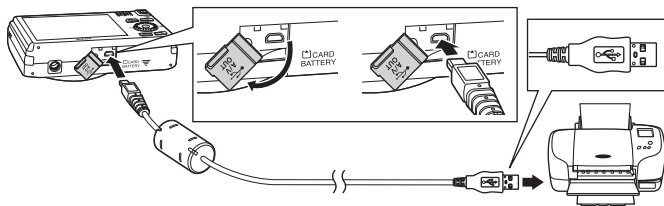

- 4 The camera is automatically turned on.

- When properly connected, the **PictBridge** startup screen (①) will be displayed in the camera monitor, followed by the **Print selection** screen (②).

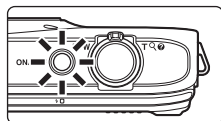

①



②

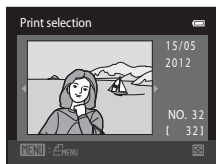

✔ If the PictBridge Startup Screen Is not Displayed

Turn the camera off and disconnect the USB cable. Set the **Charge by computer** option (080) in the camera's setup menu to **Off** and reconnect the cable.

Printing Individual Images

After properly connecting the camera to the printer (📷26), follow the procedures described below to print an image.

1 Use the multi selector to select the desired image and press the **OK** button.

- Rotate the zoom control to **W** (🖼️) to display 12 thumbnails, and **T** (📷) to switch back to full-frame playback.

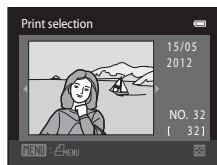

2 Select **Copies** and press the **OK** button.

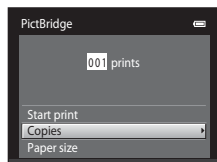

3 Select the desired number of copies (up to nine) and press the **OK** button.

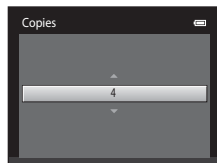

4 Select **Paper size** and press the **OK** button.

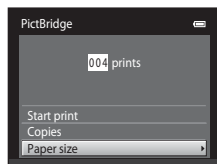

5 Select the desired paper size and press the **OK** button.

- To specify paper size using settings on the printer, select **Default** in the paper size option.

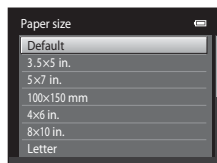

- 6** Select **Start print** and press the **OK** button.

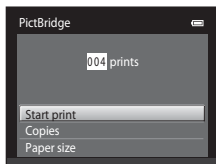

- 7** Printing begins.

- Monitor display returns to the print selection screen shown in step 1 when printing is complete.
- To cancel printing before all copies have been printed, press the **OK** button.

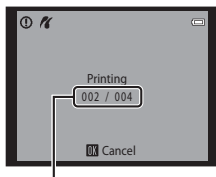

Current number of copies/
total number of copies

Printing Multiple Images

After properly connecting the camera to the printer (26), follow the procedures described below to print multiple images.

- 1** When the **Print selection** screen is displayed, press the **MENU** button.

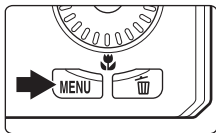

- 2** Use the multi selector to select **Paper size** and press the **OK** button.

- To exit the print menu, press the **MENU** button.

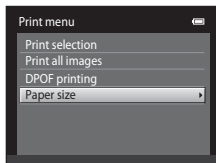

- 3** Select the desired paper size and press the **OK** button.

- To specify paper size using settings on the printer, select **Default** in the paper size option.

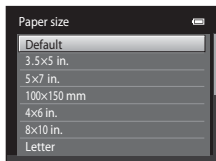

- 4** Select **Print selection**, **Print all images**, or **DPOF printing** and press the **OK** button.

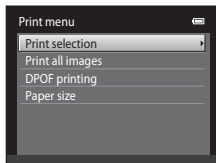

Print selection

Select images (up to 99) and the number of copies (up to nine) of each.

- Rotate the multi selector, or press ◀ or ▶ to select images, and press ▲ or ▼ to specify the number of copies to be printed.
- Images selected for printing are indicated by the check mark (✓) and the numeral indicating the number of copies to be printed. If no copies have been specified for images, the selection is canceled.
- Rotate the zoom control to **T** (Q) to switch back to full-frame playback or **W** (E) to display 12 thumbnails.
- Press the **OK** button when setting is complete.
- When the screen shown on the right is displayed, select **Start print** and press the **OK** button to start printing. Select **Cancel** and press the **OK** button to return to the print menu.

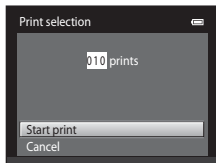

Print all images

One copy each of all images saved in the internal memory, or on the memory card, is printed.

- When the screen shown on the right is displayed, select **Start print** and press the **OK** button to start print. Select **Cancel** and press the **OK** button to return to the print menu.

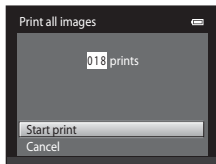

DPOF printing

Print images for which a print order was created using the **Print order** option (49).

- When the screen shown on the right is displayed, select **Start print** and press the **OK** button to start printing. Select **Cancel** and press the **OK** button to return to the print menu.
- To view the current print order, select **View images** and press the **OK** button. To print images, press the **OK** button again.

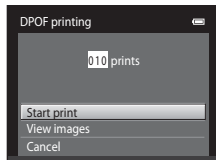

5 Printing begins.

- Monitor display returns to the print menu shown in step 2 when printing is complete.
- To cancel printing before all copies have been printed, press the **OK** button.

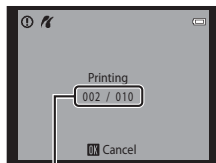

Current number of copies/
total number of copies

Paper Size

The camera supports the following paper sizes: **Default** (the default paper size for the printer connected to the camera), **3.5x5 in.**, **5x7 in.**, **100x150 mm**, **4x6 in.**, **8x10 in.**, **Letter**, **A3**, and **A4**. Only sizes supported by the printer will be displayed.

Recording Movies in Slow Motion and Fast Motion (HS Movie)

HS (high speed) movies can be recorded. The portions of the movie recorded using HS movie can be played back in slow motion at 1/4 or 1/2 of normal playback speed, or played back in fast motion at a speed two times faster than normal speed. While recording movies, the camera can be switched from normal speed movie recording to slow motion or fast motion movie recording.

- See “HS Movie” (📷33) for more information.

- 1 Display the movie menu (📷62), use the multi selector to choose **Movie options**, and then press the **OK** button.

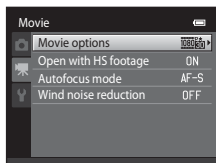

- 2 Confirm or change HS movie settings, and then press the **OK** button.

- See “Movie Options” (📷62) for more information.

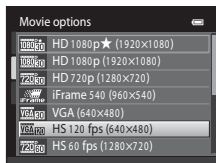



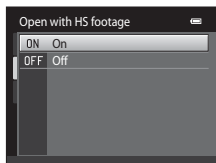

- 3 Select **Open with HS footage** and press **OK** to choose whether the camera records normal speed movies or HS movies (slow motion or fast motion movies) when movie recording starts.

- **On** (default setting): HS movies are recorded when recording begins.
- **Off**: Normal speed movies are recorded when recording begins. Press the **OK** button to switch to HS movie recording at the point where the camera should record for slow motion or fast motion playback.
- Press the **MENU** button after changing the settings and return to the shooting screen.



4 Press the (movie-record) button to start recording.

- Movie recording begins after the monitor briefly turns off.
- The camera focuses at the center of the frame. Focus areas are not displayed during recording.
- Movie recording starts in HS mode when the **Open with HS footage** checkbox in the movie menu is checked.
- Movie recording starts at normal speed when the **Open with HS footage** checkbox in the movie menu is not checked. Press the  button to switch to HS movie recording at the point where the camera should record for slow motion or fast motion playback.
- When an HS movie reaches the maximum length for HS movies (, or when the  button is pressed, the camera switches to normal speed movie recording. The camera switches between normal speed movie recording and HS movie recording each time the  button is pressed.
- When recording HS movies, the maximum movie length display changes and displays the remaining movie length for HS movie recording.
- The HS movie options that are displayed change depending on the type of movie being recorded.

HS movie options

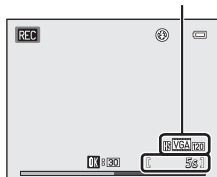

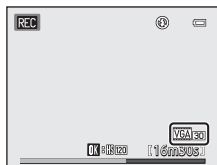

When recording HS movies



When recording normal speed movies

5 Press the (movie-record) button to end recording.

Notes About HS Movie

- Sound is not recorded.
- Zoom position, focus, exposure, and white balance are locked when the  movie-record button is pressed to start HS movie recording.
- The **VGA120 HS 120 fps (640×480)** setting cannot be used with **Soft** or **Nostalgic sepia** in special effects mode (51). If you try to use both settings at the same time, only the setting made first is enabled. Even if you first select **Soft** or **Nostalgic sepia** in special effects mode and then switch to another shooting mode and select **VGA120 HS 120 fps (640×480)**, the movie options setting automatically changes to **72060 HS 60 fps (1280×720)** when you return to special effects mode and select **Soft** or **Nostalgic sepia**.

HS Movie

Recorded movies are played back at about 30 frames per second, including portions recorded using HS movie.

When **Movie options** (62) is set to **VGA120 HS 120 fps (640×480)** or **72060 HS 60 fps (1280×720)**, movies that can be played back in slow motion can be recorded. When set to **108015 HS 15 fps (1920×1080)**, movies that can be played back in fast motion at a speed two times faster than normal speed can be recorded.

Portions recorded at VGA120 HS 120 fps (640×480):

High-speed capturing is possible for up to ten seconds. Portions captured at high speed are played back in slow motion at a speed four times slower than normal speed.

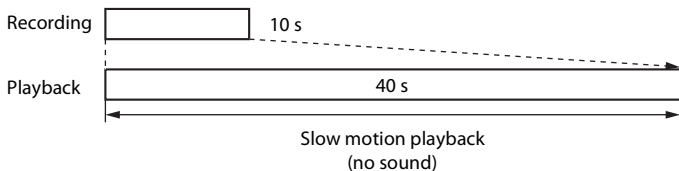

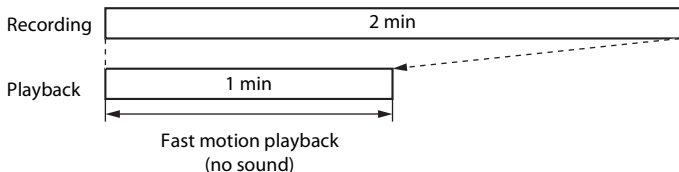

Portions recorded at 108015 HS 15 fps (1920×1080):

A movie of up to two minutes in length is recorded when shooting for the purpose of high-speed playback. Playback is two times faster.







Returning from HS Movie Setting to Normal Speed Movie Setting

In **Movie options** in the movie menu, select the normal speed movie type and press the  button (62).

Editing Movies



The desired portions of a recorded movie can be saved as a separate file (except movies recorded using  **iFrame 540 (960x540)** (60/62)).





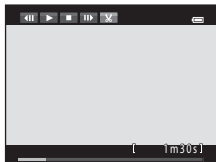

1 Play back the desired movie and pause at the start point of the portion that is to be extracted (92).

2 Press the multi selector  or  to choose the  control, and then press the  button.



- The movie edit screen is displayed.





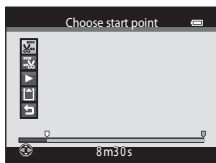

3 Press  or  to choose the  control (choose start point).





- When editing begins, the frame where playback was paused is the start point.
- Rotate the multi selector or press  or  to move the start point to the beginning of the desired portion of the movie.
- To cancel editing, press  or  to choose  (return), and press the  button.

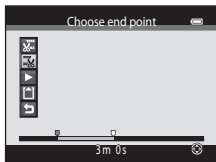

4 Press  or  to choose the  control (choose end point).

- Rotate the multi selector or press  or  to move the end point on the right edge to the end of the desired portion of the movie.
- Select  (preview) and press the  button to play back the specified portion of the movie that will be saved. While the preview is playing, rotate the zoom control to **T/W** to adjust the volume. Rotate the multi selector to advance or rewind the movie. While the preview is playing back, press the  button again to stop playback.



5 When the settings are finished, press  or  to choose  **Save** and press the  button.

6 Choose **Yes** and press the **OK** button.

- The edited movie is saved.

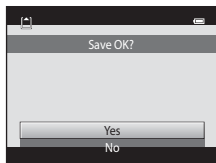

Notes About Movie Editing

- Use a sufficiently charged battery to prevent the camera from turning off during editing. When the battery level display is , movie editing is not possible.
- A movie that was created by editing cannot be trimmed again. To trim another area of the movie, select and edit the original movie.
- Movies are trimmed in one-second intervals, therefore the actual trimmed portion of the movie may differ slightly from the selected start and end points. Movies cannot be trimmed so that they are less than two seconds long.
- Editing functions are not available when there is not enough free space in the internal memory or on the memory card to save the edited copies.

More Information

See "File and Folder Names" ( 90) for more information.

The Shooting Menu (for (Auto) Mode)







- See “Changing the Image Size (Image Mode)” (69) for information about **Image mode**.

White Balance (Adjusting Hue)

Select  (auto) mode → MENU button → White balance



The color of light reflected from an object varies with the color of the light source. The human brain is able to adapt to changes in the color of the light source, with the result that white objects appear white whether seen in the shade, direct sunlight, or under incandescent lighting. Digital cameras can mimic this adjustment by processing images according to the color of the light source. This is known as “white balance.” For natural colors, select a white balance setting that matches the light source before shooting.

Although **Auto** (default setting) can be used under most types of lighting, white balance can be adjusted to suit the sky conditions or light source and achieve more natural color tones in the image.

Option	Description
AUTO Auto (default setting)	White balance is automatically adjusted to suit lighting conditions. Best choice in most situations.
PRE Preset manual	Useful when shooting under unusual lighting. See “Using Preset Manual” for more information ( 37).
 Daylight	White balance adjusted for direct sunlight.
 Incandescent	Use under incandescent lighting.
 Fluorescent	Use under fluorescent lighting.
 Cloudy	Use when taking pictures under overcast skies.
 Flash	Use with the flash.

The current white balance setting is indicated by an icon when shooting (6). No icon is displayed when **Auto** is selected.

Notes About White Balance



- Some settings cannot be used with other functions (71).
- Set the flash to  (off) when white balance is set to any setting other than **Auto** and **Flash** (62).

Using Preset Manual

The preset manual option is used with mixed lighting or to compensate for light sources with a strong color cast when the desired effect has not been achieved with white balance settings like **Auto** and **Incandescent** (for example, to make images shot under a lamp with a red shade look as though they had been shot under white light).

Use the procedure below to measure the white balance value under the lighting used during shooting.

1 Place a white or gray reference object under the lighting that will be used during shooting.

2 Display the shooting menu (, 11, 39), use the multi selector to select **PRE Preset manual** in the **White balance** menu, and press the  button.

- The camera zooms in to the position for measuring white balance.

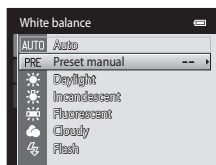

3 Select **Measure**.

- To apply the most recently measured white balance value, select **Cancel** and press the  button. The white balance setting will not be measured again and the most recently measured value will be set.

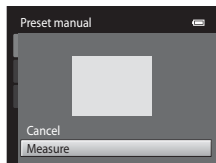

4 Frame the reference object in the measuring window.

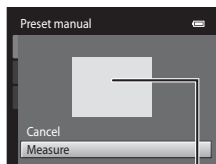

Measuring window

5 Press the  button to measure a value for preset manual.

- The shutter is released and the new white-balance value is set. No image is saved.











Notes About Preset Manual



A value for flash lighting cannot be measured with **Preset manual**. When shooting using the flash, set **White balance** to **Auto** or **Flash**.

Continuous Shooting

Select  (auto) mode → MENU button → Continuous

Change settings to continuous or BSS (Best Shot Selector).

Option	Description
 Single (default setting)	One picture is taken each time the shutter-release button is pressed.
 Continuous H	While the shutter-release button is held all the way down, images are captured continuously at a rate of about 6 fps (when image mode is set to  4608×3456). Shooting ends when the shutter-release button is released, or 7 images have been captured.
 Continuous L	While the shutter-release button is held all the way down, up to 6 images are captured continuously at a rate of up to about 1.9 fps (when image mode is set to  4608×3456). Shooting ends when the shutter-release button is released.
 Pre-shooting cache	Pre-shooting cache makes it easy to capture perfect moments, by saving images from before the shutter-release button was pressed all the way. Pre-shooting cache shooting begins when the shutter-release button is pressed halfway, and continues when the shutter-release button is pressed all the way ( 40). <ul style="list-style-type: none"> • Frame rate: up to 10.6 fps • Number of frames: Up to 5 frames (including up to two frames captured in the pre-shooting cache) Shooting ends when the shutter-release button is released or when the maximum number of frames has been shot.
 120 Continuous H: 120 fps	Each time the shutter-release button is pressed all the way, 50 frames are captured at a speed of about 1/120 s or faster. Image mode is fixed at  (image size: 640 × 480 pixels).
 60 Continuous H: 60 fps	Each time the shutter-release button is pressed all the way, 25 frames are captured at a speed of about 1/60 s or faster. Image mode is fixed at  (image size: 1280 × 960 pixels).

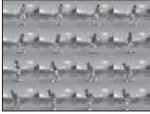
Option	Description
 BSS (Best Shot Selector)	<p>The “Best Shot Selector” is recommended when shooting with the flash off or the camera zoomed in, or in other situations in which inadvertent motion can result in blurred images. When BSS is on, the camera takes up to ten pictures while the shutter-release button is held down. The sharpest image in the series is automatically selected and saved.</p> <ul style="list-style-type: none"> • BSS is best suited to shooting subjects that are not moving. When shooting moving subjects or when the composition of the picture changes while shooting, the desired results may not be achieved.
 Multi-shot 16	<p>Each time the shutter-release button is pressed, the camera takes 16 shots at a rate of about 30 fps and arranges them in a single image.</p> <ul style="list-style-type: none"> • Image mode is fixed at  (image size: 2560 × 1920 pixels). • Digital zoom cannot be used. 

The current continuous shooting setting is indicated by an icon when shooting (6). No icon is displayed when **Single** is selected.

Notes About Continuous Shooting



- When a setting other than **Single** is selected, flash cannot be used. Focus, exposure, and white balance are fixed at the values determined with the first image in each series.
- It may take some time to save the images after shooting. The amount of time it takes to finish saving the images depends on the number of images, image mode, the write speed of the memory card, etc.
- When ISO sensitivity increases, noise may appear in captured images.
- The frame rate with continuous shooting may vary depending upon the current image mode setting, the memory card used, or shooting condition.
- When **Continuous** is set to **Pre-shooting cache**, **Continuous H: 120 fps**, **Continuous H: 60 fps**, or **Multi-shot 16**, banding or variance in brightness or hue may occur in images that were captured under lighting that flickers at high speeds, such as fluorescent, mercury-vapor, or sodium-vapor lighting.
- Some settings cannot be used with other functions (71).

Notes About BSS

BSS is suited for shooting stationary subjects. BSS may not produce the desired results if the subject moves or the composition changes.

Pre-shooting Cache

When **Pre-shooting cache** is selected, shooting begins when the shutter-release button is pressed halfway for 0.5 seconds or longer, and images captured before the shutter-release button is pressed all the way are saved along with images captured after the shutter-release button is pressed all the way. Up to two images can be saved in the pre-shooting cache.

The pre-shooting cache setting can be confirmed in the monitor when shooting (6). The pre-shooting cache icon () lights in green while the shutter-release button is pressed halfway.

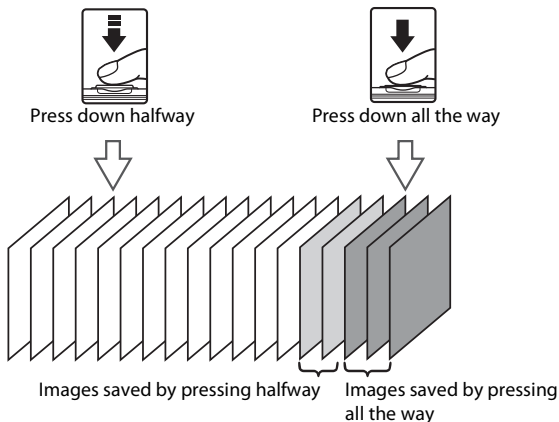



- If the number of exposures remaining is less than five, shooting with the pre-shooting cache is not possible. Before shooting, check that there are five or more exposures remaining.

Images Captured in Continuous Shooting Mode

- Each time images are captured using **Continuous H**, **Continuous L**, **Pre-shooting cache**, **Continuous H: 120 fps**, or **Continuous H: 60 fps**, the captured images are saved as a “sequence” (13).

More Information

- See “Subjects Not Suitable for Autofocus” (31) for more information.
- See “Viewing and Deleting Images Captured Continuously (Sequence)” (13) for more information.

ISO Sensitivity

Select  (auto) mode → MENU button → ISO sensitivity



When ISO sensitivity is increased, less light is needed when taking pictures.

Higher ISO sensitivity allows darker subjects to be captured. Additionally, even with subjects of similar brightness, pictures can be taken at faster shutter speeds, and blurring caused by camera shake and subject movement can be reduced.

- Although higher ISO sensitivity is effective when shooting darker subjects, shooting without the flash, shooting while using the zoom, etc., images may contain noise.

Option	Description
Auto (default setting)	Sensitivity is ISO 125 when there is sufficient lighting; the camera compensates by raising sensitivity to a maximum of ISO 1600 when lighting is dim.
Fixed range auto	Select the range in which the camera automatically adjusts ISO sensitivity, from ISO 125-400 or ISO 125-800 . The camera will not increase sensitivity beyond the maximum value in the selected range. Set the maximum value for ISO sensitivity for effective control over the amount of “grain” that appears in images.
125, 200, 400, 800, 1600, 3200	Sensitivity is locked at the specified value.

The current ISO sensitivity setting is indicated by an icon when shooting ( 6).

- When **Auto** is selected, the  icon is not displayed at ISO 125, but is displayed if the ISO sensitivity automatically increases to more than 125.
- When **Fixed range auto** is selected,  and the maximum value for ISO sensitivity is displayed.





Notes About ISO Sensitivity

Motion detection ( 73) does not function when the ISO sensitivity is set to any setting other than **Auto**.

Color Options

Select  (auto) mode → MENU button → Color options

Make colors more vivid or save images in monochrome.

Option	Description
 Standard color (default setting)	Use for images exhibiting natural color.
 Vivid color	Use to achieve a vivid, "photoprint" effect.
 Black-and-white	Save images in black-and-white.
 Sepia	Save images in sepia tones.
 Cyanotype	Save images in cyan-blue monochrome.

The current color options setting is indicated by an icon when shooting (6). When **Standard color** is selected, no icon is displayed. Color tones shown in the monitor during shooting change according to the selected color option.





Notes About Color Options

Some settings cannot be used with other functions (71).

AF Area Mode

Select  (auto) mode → MENU button → AF area mode

Use this option to determine how the camera selects the focus area for autofocus.

Option	Description
 Face priority (default setting)	<p>When the camera detects a human face, it focuses on that face. See “Using Face Detection” (📖73) for more information.</p> <p>If more than one face is detected, the camera focuses on the face closest to the camera.</p> <p>When taking pictures of subjects other than people, or framing a subject with which no face is detected, the AF area mode setting switches to Auto, and the camera will automatically select the focus area (up to nine areas) containing the subject closest to the camera.</p>
 Auto	<p>The camera has nine focus areas, and automatically selects the focus areas containing the subject closest to the camera.</p> <p>Press the shutter-release button halfway to activate the focus area.</p> <p>When the shutter-release button is pressed halfway, the focus areas that are in focus (up to nine areas) selected by the camera will be displayed in the monitor.</p>
 Manual	<p>Select one of 99 focus areas in the monitor. This option is suited to situations in which the intended subject is relatively still and not positioned in the center of the frame. Rotate the multi selector, or press ▲, ▼, ◀, or ▶ to move the focus area to where the subject is, and take a picture.</p> <p>To cancel focus area selection and adjust flash, macro mode, self-timer, and exposure compensation settings, press the  button. To return to the focus area selection screen, press the  button again.</p>

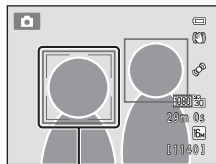

Focus area

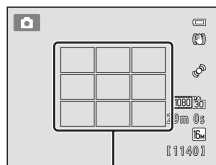

Focus areas

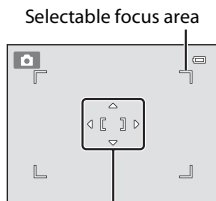

Selectable focus area

Focus area

The Shooting Menu (for (Auto) Mode)

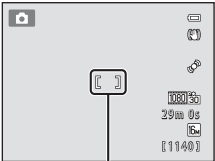
Option	Description
 Center	<p>The camera focuses on the subject in the center of the frame. The focus area is always displayed in the center of the screen.</p>  <p>Focus area</p>

Notes About AF Area Mode

- When digital zoom is in effect, focus will be on the center of the screen regardless of the **AF area mode** setting.
- Autofocus may not perform as expected (31).

Autofocus Mode

Select  (auto) mode → MENU button → Autofocus mode

Select how the camera focuses.

Option	Description
AF-S Single AF (default setting)	The camera focuses when the shutter-release button is pressed halfway.
AF-F Full-time AF	The camera focuses continuously until the shutter-release button is pressed down halfway. Use with moving subjects. The sound of lens drive movement will be heard while the camera focuses.

Autofocus Mode Setting

Autofocus mode can be set independently for both subject tracking mode and  (auto) mode.

Autofocus Mode for Movie Recording

Autofocus mode for movie recording can be set with **Autofocus mode** (64) in the movie menu.

The Smart Portrait Menu

- See “Changing the Image Size (Image Mode)” (📖69) for information about **Image mode**.

Skin Softening

Select smart portrait mode → MENU button → Skin softening

Enable skin softening.

Option	Description
⬆️ High	When the shutter is released, the camera detects one or more human faces (up to three), and processes the image to soften facial skin tones before saving the image. You can select the amount of effect that is applied.
⬆️ Normal (default setting)	
⬆️ Low	
OFF Off	Turns skin softening off.

The current setting can be confirmed by the indicator displayed in the monitor during shooting (📖7). No indicator is displayed when **Off** is selected. The effects of skin softening are not visible when framing pictures for shooting. Check the degree of skin softening performed in playback mode.

Smile Timer

Select smart portrait mode → MENU button → Smile timer

The camera detects human faces and then automatically releases the shutter whenever a smile is detected.



Option	Description
😊 On (default setting)	Enables smile timer.
OFF Off	Turns the smile timer off.

The current smile timer setting is indicated by an icon when shooting (📖7). No icon is displayed when **Off** is selected.

Blink Proof

Select smart portrait mode → MENU button → Blink proof

The camera automatically releases the shutter twice each time a picture is taken. Of the two shots, one in which the subject's eyes are open is saved.

Option	Description
 On	Enables blink warning. Flash cannot be used when On is selected. If the camera saved an image in which the subject's eyes may have been closed, the dialog shown on the right is displayed for a few seconds. 
OFF Off (default setting)	Turns the blink warning off.

The current blink proof setting is indicated by an icon when shooting (📖7). No icon is displayed when **Off** is selected.

The Subject Tracking Menu

- See “Changing the Image Size (Image Mode)” (📖69) for information about **Image mode**.

Autofocus Mode

Select subject tracking mode → MENU button → Autofocus mode

Determines how the camera focuses when using subject tracking mode.

Option	Description
AF-S Single AF	The camera focuses when the shutter-release button is pressed halfway.
AF-F Full-time AF (default setting)	Once a subject is registered for subject tracking, the camera continuously focuses until the shutter-release button is pressed halfway to lock the focus. The sound of lens drive movement can be heard.

- Changes made to the autofocus mode setting in this mode will not be applied to the autofocus mode setting in 📷 (auto) mode.
- The autofocus mode setting applied in subject tracking mode is saved in the camera’s memory even after the camera is turned off.

Face Priority Tracking

Select subject tracking mode → MENU button → Face priority tracking

Once the camera detects a person’s face, it registers the subject and begins tracking that person.

Option	Description
On (default setting)	Enables face priority tracking.
Off	Disables face priority tracking. If a person whom you do not want to track is automatically registered, or when shooting non-human subjects, select Off if a person is in the frame.

The Playback Menu

- See “Editing Still Images” (👁️16) for information about image editing features.
- See “Favorite Pictures Mode” (👁️7) for information about **Favorite pictures** and **Remove from favorites**.

🖨️ Print Order (Creating a DPOF Print Order)

Press the ▶️ button (playback mode) → MENU button → 🖨️ Print order

When printing images saved on the memory card using any of the following methods, the **Print order** option in the playback menu is used to create digital “print orders” for printing on DPOF-compatible devices.

- Inserting the memory card into a DPOF-compatible (👁️16) printer’s card slot.
- Taking the memory card to a digital photo lab.
- Connecting the camera to a PictBridge-compatible (👁️16) printer (👁️25). A print order can also be created for images saved in the internal memory if the memory card is removed from the camera.

1 Use the multi selector to select **Select images** and press the OK button.

- In favorite pictures, auto sort, or list by date mode, the screen shown on the right is not displayed. Proceed to the step 2.

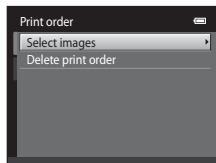

2 Select images (up to 99) and the number of copies (up to nine) of each.

- Rotate the multi selector, or press ◀️ or ▶️ to select images, and press ▲ or ▼ to specify the number of copies to be printed.
- Images selected for printing are indicated by the check mark icon and the numeral indicating the number of copies to be printed. If no copies have been specified for images, the selection is canceled.
- Rotate the zoom control to T (👁️) to switch to full-frame playback. Rotate the zoom control to W (🖼️) to switch back to 12-thumbnail display.
- Press the OK button when setting is complete.



3 Select whether or not to print shooting date and shooting information.

- Select **Date** and press the **OK** button to print the shooting date on all images in the print order.
- Select **Info** and press the **OK** button to print shooting information (shutter speed and aperture value) on all images in the print order.
- Select **Done** and press the **OK** button to complete the print order.

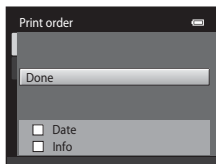

Images selected for printing are indicated by the  icon during playback.

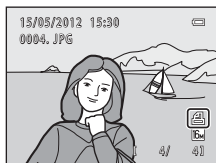

Notes About Printing Shooting Date and Shooting Information

When the **Date** and **Info** settings are enabled in the print order option, shooting date and shooting information are printed on images when a DPOF-compatible () printer that supports printing of shooting date and shooting information is used.

- Shooting information cannot be printed when the camera is connected to a DPOF-compatible printer via the included USB cable ()
- Note that **Date** and **Info** settings are reset each time the **Print order** option is displayed.
- The date printed is that saved when the image was captured.

Changing the camera's date using the **Date and time** or **Time zone** in the **Time zone and date** option in the setup menu after an image has been captured has no effect on the date printed on the image.



✓ Notes About Print Order

- Print orders cannot be created for images captured in **3D photography** scene mode.
- When a print order is created in favorite pictures mode, auto sort mode, or list by date mode, the screen shown below is displayed if images other than those in the selected album, category, or shooting date have been marked for printing.
 - If you select **Yes**, print order settings for other images are not changed and only the current print order settings are changed.
 - Select **No** to remove print marking from previously marked images and restrict the print order to images in the selected category or captured on the selected shooting date.

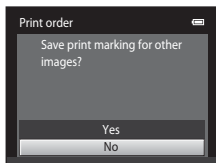

Favorite pictures mode or
auto sort mode

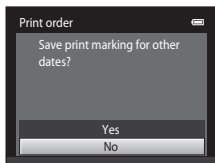

List by date mode

If the total number of the images in a print order exceeds 99, the screen shown below will be displayed.

- Select **Yes** to remove images previously added from the print order and restrict the print order to images just marked.
- Select **Cancel** to remove the images just added from the print order and restrict the print order to images previously marked.

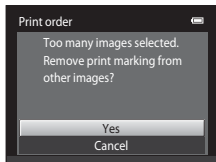

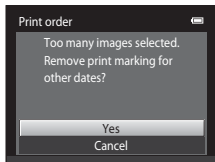

Favorite pictures mode or
auto sort mode



List by date mode

Canceling Existing Print Order



Select **Delete print order** in step 1 of “ Print Order (Creating a DPOF Print Order)” (0049) and press the  button to remove print marking from all images and cancel the print order.

Print Date

Using the **Print date** option (0071) in the setup menu, shooting date and time can be imprinted on images at the time of shooting. Images with the date imprinted on them can be printed from printers that do not support printing of the date on images.



Only the date and time imprinted on images with the print date option will be printed, even if the **Print order** date option is enabled.

Slide Show

Press the  button (playback mode) → MENU button →  Slide show



Play back images, saved in the internal memory or on a memory card, one by one in an automated “slide show.”

1 Use the multi selector to select **Start** and press the .

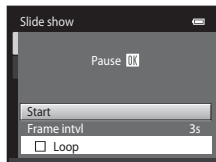
- To change the interval between images, select **Frame intvl**, select the desired interval time, and press the  button before selecting **Start**.
- To repeat the slide show automatically, select **Loop** and press the  button before selecting **Start**. The check mark () will be added to the loop option when enabled.





2 The slide show begins.

- While the slide show is in progress, press the multi selector  to display the next image or  to display the previous image. Hold down either button to fast forward or rewind.
- To end or pause the slide show, press the  button.







3 Choose End or Restart.



- The display at right appears when the last slide is displayed or the show is paused. Highlight  and press the  button to return to Step 1, or select  to restart the show.



Notes About Slide Show

- Only the first frame of movies included in a slide show is displayed.
- When **Key picture only** is selected as the method to display sequences (, 13), only the key picture is displayed.
- Images captured using easy panorama (, 48, , 2) are displayed full-frame when played in a slide show. They do not scroll.
- The maximum playback time is up to 30 minutes even if **Loop** is enabled (, 76).



Protect

Press the  button (playback mode) → MENU button →  Protect

Protects selected images from accidental deletion.

Select images to protect or cancel protection for previously protected images from the image selection screen. See “The Image Selection Screen” (55) for more information.

Note that formatting the camera’s internal memory or the memory card will permanently delete protected files (77).

Protected images are indicated by the  icon during playback (8).

The Image Selection Screen

When using one of the following features, a screen like that shown on the right is displayed when selecting images.

- Print order > **Select images** (👁️49)
- Protect (👁️54)
- Rotate image (👁️56)
- Copy > **Selected images** (👁️59)
- Choose key picture (👁️61)
- Favorite pictures (👁️7)
- Remove from favorites (👁️8)
- Welcome screen > **Select an image** (👁️65)
- Delete image > **Erase selected images** (📖34)



Follow the procedures described below to select the images.

1 Rotate the multi selector, or press ◀ or ▶ to select an image.

- Rotate the zoom control (📖2) to **T** (🔍) to switch to full-frame playback or **W** (📑) to switch back to 12-thumbnail display.
- Only one image can be selected for **Rotate image**, **Choose key picture**, and **Welcome screen**. Proceed to step 3.



2 Press ▲ or ▼ to select or deselect (or to specify the number of copies).



- When an image is selected, a check mark (☑️) is displayed with the image. Repeat steps 1 and 2 to select additional images.





3 Press the Ⓞ button to apply image selection.

- When **Selected images** is selected, a confirmation dialog is displayed. Follow the instructions displayed in the monitor.

Rotate Image

Press the  button (playback mode) → MENU button →  Rotate image

Specify the orientation in which saved images are displayed during playback. Still images can be rotated 90 degrees clockwise or 90 degrees counterclockwise. Images that were saved in portrait (“tall”) orientation can be rotated up to 180 degrees in either direction.

Select an image from the image selection screen (55). When the Rotate image screen is displayed, rotate the multi selector, or press  or  to rotate the image 90 degrees.

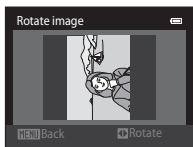

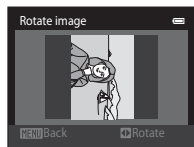

Rotate 90 degrees
counterclockwise





Rotate 90 degrees
clockwise

Press the  button to finalize display orientation, and save orientation information with the image.

Notes About Image Rotation

- Images captured with another make or model of digital camera or captured with **3D photography** (50) cannot be rotated on the COOLPIX S6300.
- Images captured in sequence cannot be rotated when only the key pictures are displayed for them. First display the images individually, and then rotate the desired image (13).



Voice Memo

Press the  button (playback mode) → select an image → MENU button →  Voice memo

Use the camera's microphone to record voice memos for images.

- The voice memo recording screen is displayed for images that do not have a voice memo, and the voice memo playback screen is displayed for images that have a voice memo (i.e., images that display  in full-frame playback mode).

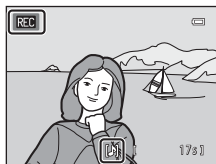

Recording Voice Memos

- Press and hold the  button to record a voice memo (up to 20 seconds).
- Do not touch the microphone during recording.
- During recording, **REC** and  flash in the monitor.
- When recording ends, the voice memo playback screen is displayed.



Playing Voice Memos



 is displayed for images with a voice memo when in full-frame playback mode.

- Press the  button to play the voice memo. Press the button again to stop playback.
- Rotate the zoom control to **T** or **W** during playback to adjust playback volume.
- Press the multi selector  before or after playing back a voice memo to return to the playback menu. Press the **MENU** button to exit the playback menu.





Deleting Voice Memos

Press the  button while the screen described in "Playing Voice Memos" is displayed.

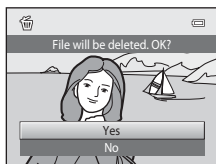
When the confirmation dialog is displayed, press the multi selector  or  to select **Yes** and press the  button. Only the voice memo will be deleted.





Notes About Voice Memos

- When an image with a voice memo attached is deleted, both the image and its voice memo are deleted.
- You cannot delete voice memos attached to protected images (54).
- Voice memos cannot be recorded for an image that already has a voice memo attached to it. The current voice memo must be deleted before a new voice memo can be recorded.
- This camera cannot record voice memos for images captured with another make or model of digital camera.
- Voice memos cannot be recorded for images captured in sequence when only the key pictures are displayed for sequences of images. First display the images individually, and then record voice memos (13).

More Information

See “File and Folder Names” (90) for more information.

Copy (Copy Between Internal Memory and Memory Card)

Press the  button (playback mode) → MENU button →  Copy

Copy images between the internal memory and a memory card.

- 1 Use the multi selector to select a destination option to which images are copied and press the  button.

- **Camera to card:** Copy images from internal memory to memory card.
- **Card to camera:** Copy images from memory card to internal memory.

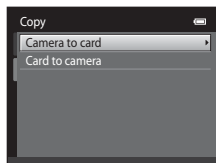



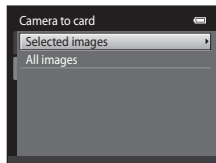

- 2 Select a copy option and press the  button.



- **Selected images:** Copy images selected from the image selection screen (55).
- **All images:** Copy all images.



Notes About Copying Images

- JPEG-, MOV-, WAV-, and MPO-format files can be copied. Files saved in any other format cannot be copied.
- If voice memos (57) are attached to images selected for copying, voice memos are copied with the images.
- Operation is not guaranteed with images captured with another make of camera or that have been modified on a computer.
- When copying images for which **Print order** (49) options are enabled, the print order settings are not copied. However, when copying images for which **Protect** (54) is enabled, the protect setting is copied.
- Images or movies copied from the internal memory or a memory card cannot be displayed in auto sort mode (10).
- If an image added to an album (7) is copied, the copied image is not added to the album.

Notes About Copying Images in a Sequence

- If you select a key picture of a sequence in **Selected images** when only the key picture is displayed for the sequence (13), all images in the sequence are copied.
- If you press the **MENU** button and select **Current sequence** after you press the  button and display images in a sequence as individual images, all images in the sequence are copied.
- If you press the  button and display images in a sequence as individual images, only **Card to camera** (memory card to internal memory) image copy is available.

If “Memory contains no images.” Is Displayed



If a memory card that contains no images is inserted into the camera, **Memory contains no images.** will be displayed when the camera is switched to playback mode. Press the **MENU** button to select **Copy** in the playback menu and copy the images saved in the camera’s internal memory to the memory card.

More Information



See “File and Folder Names” (90) for more information.

Sequence Display Options



Press the  button (playback mode) → MENU button →  Sequence display options



Choose the method used to display a series of images shot continuously (sequence) (13) when viewing them in full-frame playback mode (32) and in thumbnail playback mode (33).

Settings are applied to all sequences, and the setting is saved in the camera's memory even if the camera is turned off.

Option	Description
Individual pictures	Set all pictures in all sequences to be displayed individually.  is displayed on the playback screen ( 8).
Key picture only (default setting)	Set all sequences to be displayed using their key pictures only.

Choose Key Picture

Press the  button (playback mode) → select an image in a sequence → MENU button →  Choose key picture

When **Sequence display options** is set to **Key picture only**, the key picture displayed in full-frame playback mode (32) and thumbnail playback mode (33) can be set for each sequence of images.



- When changing this setting, before pressing the **MENU** button, first select the desired sequence using full-frame playback mode or thumbnail playback mode.
- When the key picture selection screen is displayed, select an image. See “The Image Selection Screen” (55) for more information.

The Movie Menu







Movie Options

Enter shooting mode → MENU button →  tab → Movie options

Select the desired movie option to record. Larger image sizes and faster movie bitrates mean greater image quality and larger movie file sizes.



- The movie bitrate is the volume of movie data recorded per second. Variable bitrate (VBR) encoding is used to automatically adjust the bitrate depending on the subject being recorded. When recording movies of a subject with large amounts of motion, the file size increases.
- See “Movie Options and Maximum Movie Length” ()90 for information about maximum movie length.
- When recording normal speed movies, select one of the normal speed movie options ()62), and when recording HS movies, select one of the HS movie options ()63).

Normal Speed Movie Options

Type	Description
 HD 1080p★ (1920×1080) (default setting)	Movies with an aspect ratio of 16:9 are recorded. This option is suited to playback on a widescreen TV. <ul style="list-style-type: none">• Movie bitrate: Approx. 14.8 Mbps
 HD 1080p (1920×1080)	Movies with an aspect ratio of 16:9 are recorded. This option is suited to playback on a widescreen TV. <ul style="list-style-type: none">• Movie bitrate: Approx. 12.3 Mbps
 HD 720p (1280×720)	Movies with an aspect ratio of 16:9 are recorded. <ul style="list-style-type: none">• Movie bitrate: Approx. 6.1 Mbps
 iFrame 540 (960×540)	Movies with an aspect ratio of 16:9 are recorded. A format supported by Apple Inc. <ul style="list-style-type: none">• Movie bitrate: Approx. 20.7 Mbps Movies cannot be edited ()34). When recording movies to the internal memory, recording may stop unexpectedly in some shooting conditions. When recording movies of important events, recording to a memory card (class 6 or higher) is recommended.
 VGA (640×480)	Movies with an aspect ratio of 4:3 are recorded. <ul style="list-style-type: none">• Movie bitrate: Approx. 2.9 Mbps

- The frame rate is approximately 30 fps for all options.

HS Movie Options

Type	Description
 HS 120 fps (640×480)	1/4-speed slow motion movies with a 4:3 aspect ratio are recorded. <ul style="list-style-type: none"> • Max. recording time*: 10 seconds (playback time: 40 seconds) • Movie bitrate: 2.9 Mbps
 HS 60 fps (1280×720)	1/2-speed slow motion movies with a 16:9 aspect ratio are recorded. <ul style="list-style-type: none"> • Max. recording time*: 30 seconds (playback time: 1 minute) • Movie bitrate: 6.1 Mbps
 HS 15 fps (1920×1080)	2× speed fast motion movies with a 16:9 aspect ratio are recorded. <ul style="list-style-type: none"> • Max. recording time*: 2 minutes (playback time: 1 minute) • Movie bitrate: 12.3 Mbps

* The maximum recording time shown here refers only to the portion of the movie that is recorded in slow motion or fast motion.

More Information

See “File and Folder Names” (90) for more information.

Open with HS Footage

Enter shooting mode → MENU button →  tab → Open with HS footage



Select whether the camera records normal speed movies or HS movies (slow motion or fast motion movies) when movie recording starts.

Option	Description
ON On (default setting)	Record HS movies when movie recording begins.
OFF Off	Record normal speed movies when movie recording begins. Press the  button to switch to HS movie recording at the point where the camera should record for slow motion or fast motion playback.

Autofocus Mode

Enter shooting mode → MENU button →  tab → Autofocus mode

Select how the camera focuses in movie mode.

Option	Description
AF-S Single AF (default setting)	Focus is locked when the  ( movie-record) button is pressed to start recording. Select this option when the distance between the camera and the subject will remain fairly consistent.
AF-F Full-time AF	Camera focuses continuously. Select this option when the distance between the camera and subject will change significantly during recording. The sound of the camera focusing may be heard in the recorded movie. Use of Single AF is recommended to prevent the sound of the camera focusing from interfering with recording.

- When an HS movie option is selected in **Movie options**, the setting is fixed at **Single AF**.

Wind Noise Reduction

Enter shooting mode → MENU button →  tab → Wind noise reduction

Allows you to reduce wind noise during movie recording.

Option	Description
 On	Reduces the sound produced when wind passes over the microphone. Use when recording movies in locations with strong winds. Other sounds may become difficult to hear during playback.
OFF Off (default setting)	Wind noise reduction is not enabled.

- The current wind noise reduction setting is indicated by an icon when shooting (6). No icon is displayed when **Off** is selected.
- When an HS movie option is selected in **Movie options**, the setting is fixed at **Off**.

The Setup Menu

Welcome Screen

Press the MENU button → Y tab → Welcome screen

Select whether or not a welcome screen is displayed when the camera is turned on.

Option	Description
None (default setting)	The camera enters shooting or playback mode without displaying the welcome screen.
COOLPIX	The camera displays a welcome screen and enters shooting or playback mode.
Select an image	Displays an image selected for the welcome screen. When the image selection screen is displayed, select an image (655) and press the OK button. <ul style="list-style-type: none">As the selected image is saved by the camera, it will be displayed when the camera is turned on even if the original image is deleted.Images captured at an Image mode (69) setting of 4608x2592, images captured using Easy panorama or 3D photography, and copies created at a size of 320 x 240 or smaller using the small picture (621) or crop (622) function, cannot be selected.

Time Zone and Date

Press the MENU button → Y tab → Time zone and date

Set the camera clock.

Option	Description
Date and time	<p>Set camera clock to current date and time. Use the multi selector to set the date and time in the date screen.</p> <ul style="list-style-type: none"> • Select an item: Press ► or ◀ (changes between D, M, Y, hour, and minute). • Edit the highlighted item: Rotate the multi selector, or press ▲ or ▼. • Apply the setting: Select the minute setting and press the OK button.
Date format	The available date formats are Year/Month/Day , Month/Day/Year , and Day/Month/Year .
Time zone	Home time zone (🏠) can be specified and daylight saving time can be enabled or disabled. When Travel destination (📍) is selected, the time difference (⌚68) between the travel destination and the home time zone (🏠) is automatically calculated and the date and time in the selected region are saved. This can be useful when travelling.

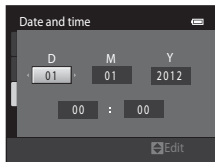

Selecting the Travel Destination Time Zone

- 1 Use the multi selector to select **Time zone** and press the **OK** button.

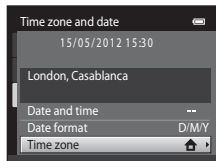

- 2 Select ► **Travel destination** and press the **OK** button.

- The date and time displayed in the monitor changes according to the region currently selected.

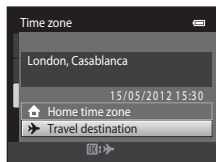

3 Press **▶**.

- The travel destination screen is displayed.

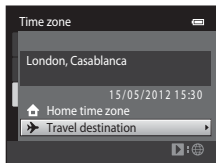

4 Press **◀** or **▶** to select the travel destination time zone.

- If daylight saving time is in effect, press **▲** to enable daylight saving time function. is displayed at the top of the monitor and the camera clock is advanced one hour. Press **▼** to disable the daylight saving time function.
- Press the **OK** button to apply the travel destination time zone.
- While the travel destination time zone is selected, the icon will be displayed in the monitor when the camera is in shooting mode.

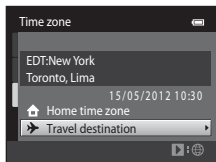
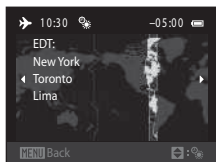

Home Time Zone

- To switch to the home time zone, select **Home time zone** in step 2 and press the **OK** button.
- To change the home time zone, select **Home time zone** in step 2, and complete steps 3 and 4.

Daylight Saving Time

When daylight saving time starts or ends, turn the daylight saving time function on or off from the time zone selection screen displayed in step 4.

Imprinting Date on Images

Enable the **Print date** option (71) in the setup menu after the date and time have been set. When the **Print date** option is enabled, images will be saved with shooting date imprinted on them.

The Setup Menu

Time Zones

The camera supports the time zones listed below.

For time zones not listed below, set the camera clock to local time from the **Date and time** option.

UTC +/-	Location	UTC +/-	Location
-11	Midway, Samoa	+1	Madrid, Paris, Berlin
-10	Hawaii, Tahiti	+2	Athens, Helsinki, Ankara
-9	Alaska, Anchorage	+3	Moscow, Nairobi, Riyadh, Kuwait, Manama
-8	PST (PDT): Los Angeles, Seattle, Vancouver	+4	Abu Dhabi, Dubai
-7	MST (MDT): Denver, Phoenix	+5	Islamabad, Karachi
-6	CST (CDT): Chicago, Houston, Mexico City	+5.5	New Delhi
-5	EST (EDT): New York, Toronto, Lima	+6	Colombo, Dhaka
-4.5	Caracas	+7	Bangkok, Jakarta
-4	Manaus	+8	Beijing, Hong Kong, Singapore
-3	Buenos Aires, Sao Paulo	+9	Tokyo, Seoul
-2	Fernando de Noronha	+10	Sydney, Guam
-1	Azores	+11	New Caledonia
±0	London, Casablanca	+12	Auckland, Fiji

Monitor Settings

Press the MENU button →  tab → Monitor settings

Set the options below.



Option	Description
Photo info	Select information displayed in the monitor during shooting and playback. See "Photo Info" ( 70) for more information.
Image review	This setting determines whether or not the captured image is displayed immediately after shooting. The default setting is On .
Brightness	Select from five settings for monitor brightness. The default setting is 3 .

Photo Info

Select whether or not the photo information is displayed in the monitor.
See “The Monitor” (📖6) for information about indicators displayed in the monitor.

	Shooting mode	Playback mode
Show info		
Auto info (default setting)	Current settings and operational guides are displayed as in Show info above. If no operations are performed for a few seconds, the information is hidden, as in Hide info below. Information will be displayed again when the next operation is performed.	
Hide info		
Framing grid+auto info		
	In addition to information shown with Auto info above, a framing grid is displayed to help frame pictures. It is not displayed when recording movies.	The current settings or operation guide is displayed, as in Auto info above.
Movie frame+auto info		
	In addition to information shown with Auto info above, a frame is displayed before recording begins that represents the area that will be captured when recording movies. It is not displayed when recording movies.	The current settings or operation guide is displayed, as in Auto info above.

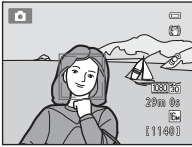
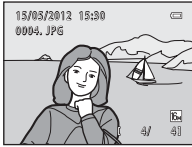
Print Date (Imprinting Date and Time)

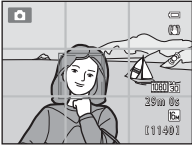
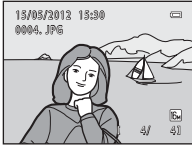
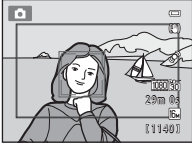
Press the **MENU** button → **Y** tab → Print date

The shooting date and time can be imprinted on the images when shooting, allowing the information to be printed even from printers that do not support date printing (📷50).



Option	Description
DATE Date	Date is imprinted on images.
DATE Date and time	Date and time are imprinted on images.
OFF Off (default setting)	Date and time are not imprinted on images.

The current print date setting is indicated by an icon when shooting (📖6). No icon is displayed when **Off** is selected.

✔ Notes About Print Date

- Imprinted dates form a permanent part of image data and cannot be deleted. The date and time cannot be imprinted on images after they have been captured.
- The date cannot be imprinted in the following situations:
 - When using **Night portrait** (when **Hand-held** is selected), **Night landscape** (when **Hand-held** is selected), **Easy panorama**, or **3D photography** scene mode
 - When the continuous shooting setting (📖39) is set to **Pre-shooting cache**, **Continuous H: 120 fps**, or **Continuous H: 60 fps**.
 - When shooting movies
- Dates imprinted at an **Image mode** setting (📖69) of **VGA 640×480** may be difficult to read. Select an **Image mode** setting of **2M 1600×1200** or larger when using print date.
- The date is saved using the format selected in the setup menu's **Time zone and date** item (📖24, 📷66).

📎 Print Date and Print Order

When printing with a DPOF-compatible printer that can print the shooting date and shooting information, you can use the **Print order** option (📷49) to print this information in images, even if the **Print date** function was set to **Off** at the time of shooting.

Vibration Reduction

Press the **MENU** button → **Y** tab → Vibration reduction

Reduce the effects of camera shake while shooting. Vibration reduction effectively reduces blur, caused by slight hand movement known as camera shake, which commonly occurs when shooting with zoom applied or at slow shutter speeds. The effects of camera shake are reduced when recording movies, in addition to when taking still pictures.

Set **Vibration reduction** to **Off** when using a tripod to stabilize the camera during shooting.

Option	Description
 On (default setting)	Vibration reduction is enabled.
OFF Off	Vibration reduction is disabled.

The current vibration reduction setting is indicated by an icon when shooting (6). No icon is displayed when **Off** is selected.















Notes About Vibration Reduction

- After turning on the camera or after switching from playback mode to shooting mode, wait for the shooting mode screen to be displayed completely before taking pictures.
- Due to characteristics of the vibration reduction function, images displayed in the camera's monitor immediately after shooting may be displayed blurry.
- Vibration reduction may be unable to completely eliminate the effects of camera shake in some situations.
- When the **Night landscape** or **Night portrait** scene mode is set to **Tripod**, vibration reduction is turned off.

Motion Detection

Press the MENU button →  tab → Motion detection

Enable motion detection to reduce the effects of subject movement and camera shake when shooting still images.

Option	Description
 Auto (default setting)	<p>When the camera detects subject movement or camera shake, the ISO sensitivity and shutter speed are automatically increased to reduce blurring.</p> <p>However, motion detection does not function in the following situations:</p> <ul style="list-style-type: none"> • When the flash fires. • In  (auto) mode, when Continuous (38) is set to any setting other than Single or BSS. • In  (auto) mode, when ISO sensitivity (41) is set to any setting other than Auto. • In the following scene modes: Sports (43), Night portrait (43), Dusk/dawn (44), Night landscape (45), Museum (46), Fireworks show (46), Backlighting (47), Easy panorama (48), Pet portrait (49), and 3D photography (50) • When subject tracking mode is selected.
OFF Off	Motion detection is disabled.

The current motion detection setting is indicated by an icon when shooting (6). When the camera detects camera shake or subject movement, it increases shutter speed and the motion detection icon turns green. No icon is displayed when **Off** is selected.

Notes About Motion Detection

- Motion detection may be unable to completely eliminate the effects of subject movement and camera shake in some situations.
- Motion detection may not function if the subject exhibits significant movement or is too dark.
- The images captured using motion detection may be somewhat “grainy” in appearance.

AF Assist

Press the MENU button → Y tab → AF assist

Enable or disable AF-assist illuminator, which assists autofocus operation when the subject is dimly lit.

Option	Description
Auto (default setting)	AF-assist illuminator will be used to assist the focus operation when the subject is dimly lit. The illuminator has a range of about 1.9 m (6 ft 3 in.) at the maximum wide-angle position and about 1.1 m (3 ft 7 in.) at the maximum telephoto position. Note that for some scene modes (such as Museum (📖46) and Pet portrait (📖49)) or focus areas, the AF-assist illuminator may not light even when Auto is selected.
Off	AF-assist illuminator does not light. The camera may be unable to focus under dim lighting.

Digital Zoom

Press the MENU button → Y tab → Digital zoom

Enable or disable digital zoom.

Option	Description
On (default setting)	When the camera is zoomed in to the maximum optical zoom position, rotating the zoom control to T (📖) triggers digital zoom (📖29).
Off	Digital zoom will not be activated.

👍 Notes About Digital Zoom

- When digital zoom is in effect, the camera focuses at the center of the frame.
- Digital zoom cannot be used in the following situations.
 - When **Scene auto selector**, **Portrait**, **Night portrait**, **Night landscape**, **Backlighting** (when **HDR** is set to **On**), **Easy panorama**, **Pet portrait**, or **3D photography** is selected in scene mode
 - When smart portrait mode is selected
 - When subject tracking mode is selected
 - When **Continuous** is set to **Multi-shot 16**

Sound Settings

Press the MENU button → Y tab → Sound settings

Adjust the following sound settings.

Option	Description
Button sound	Select On (default setting) or Off . When On is selected, a beep will sound once when operations are completed successfully, twice when the camera acquires focus on the subject, and three times when an error is detected. Start-up sound will also play when the camera is turned on.
Shutter sound	Select On (default setting) or Off . The shutter sound is disabled even if On is selected, when using any continuous shooting settings other than Single (0-038) or when recording movies.

Notes About Sound Settings

Button sounds and the shutter sound are disabled when using the **Pet portrait** scene mode.

Auto Off

Press the MENU button → Y tab → Auto off

If no operations are performed for a specified amount of time, the monitor turns off and the camera enters standby mode (📖23).

This setting determines the amount of time that passes before the camera enters standby mode. You can select **30 s**, **1 min** (default setting), **5 min**, or **30 min**.



When the Monitor Has Turned Off to Save Power

- When the camera is in standby mode, the power-on lamp flashes.
- If no operations are performed for approximately another three minutes, the camera will turn off automatically.
- When the power-on lamp is flashing, pressing any of the following buttons will turn the monitor back on:
Power switch, shutter-release button, 📷 button, ▶ button, or ● (🎬 movie-record) button



Notes About Auto Off

- The time that passes before the camera enters standby mode is fixed in the following situations:
 - When a menu is displayed: 3 minutes
 - During slide show playback: Up to 30 minutes
 - When the AC adapter EH-62F is connected: 30 minutes
- The camera does not enter standby mode when transferring images using an Eye-Fi card.

Format Memory/Format Card

Press the MENU button → Y tab → Format memory/Format card

Use this option to format the internal memory or a memory card.

Formatting the internal memory or memory cards permanently deletes all data. Data that has been deleted cannot be restored. Be sure to transfer important images to a computer before formatting.

Formatting the Internal Memory

To format the internal memory, remove the memory card from the camera. The **Format memory** option is displayed in the setup menu.

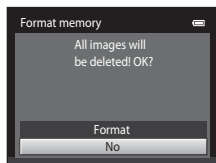

Formatting Memory Cards

When a memory card is inserted in the camera, the **Format card** option is displayed in the setup menu.

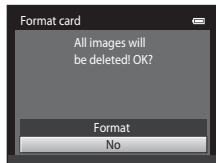

✓ Notes About Formatting Internal Memory and Memory Cards

- Album icon settings (009) are reset to their default settings (number icons) when the internal memory or memory card is formatted.
- Do not turn the camera off or open the battery-chamber/memory card slot cover during formatting.
- The first time you insert a memory card that has been used in another device into this camera, be sure to format it with this camera.

Language

Press the **MENU** button → **Y** tab → Language

Select one of 29 languages for display of camera menus and messages.

Čeština	Czech
Dansk	Danish
Deutsch	German
English	(default setting)
Español	Spanish
Ελληνικά	Greek
Français	French
Indonesia	Indonesian
Italiano	Italian
Magyar	Hungarian
Nederlands	Dutch
Norsk	Norwegian
Polski	Polish
Português (BR)	Brazilian Portuguese
Português (PT)	European Portuguese

Русский	Russian
Română	Romanian
Suomi	Finnish
Svenska	Swedish
Tiếng Việt	Vietnamese
Türkçe	Turkish
Українська	Ukrainian
عربي	Arabic
简体中文	Simplified Chinese
繁體中文	Traditional Chinese
日本語	Japanese
한글	Korean
ภาษาไทย	Thai
हिन्दी	Hindi

TV Settings

Press the **MENU** button → **Y** tab → TV settings

Adjust settings for connection to a TV.

Option	Description
Video mode	Select from NTSC and PAL .
HDMI	Select a resolution for HDMI output from Auto (default setting), 480p , 720p , or 1080i . When Auto is selected, the option best suited to the TV to which the camera is connected is automatically selected from 480p , 720p , or 1080i .
HDMI device control	Select whether or not the camera can receive signals from a TV that supports the HDMI-CEC standard when it is connected to the TV via HDMI. When On (default setting) is selected, the TV's remote control can be used to control the camera during playback. See "Using a TV Remote Control (HDMI Device Control)" (6624) for more information.
HDMI 3D output	Set the method used to output 3D images captured with this camera to HDMI devices. Select On (default setting) to play back 3D images in 3D.



HDMI and HDMI-CEC

HDMI (High-Definition Multimedia Interface) is a multimedia interface. HDMI-CEC (HDMI-Consumer Electronics Control) allows compatible devices to inter-operate.

Charge by Computer

Press the MENU button → Y tab → Charge by computer

Select whether or not the battery inserted into the camera is charged when the camera is connected to a computer via the USB cable (81).

Option	Description
Auto (default setting)	When the camera is connected to a computer that is running, the battery inserted into the camera is automatically charged using power supplied by the computer.
Off	The battery inserted into the camera is not charged when the camera is connected to a computer.

Notes About Connecting the Camera to a Printer

- The battery cannot be charged with connection to a printer, even if the printer complies with the PictBridge standard.
- When **Auto** is selected for **Charge by computer**, it may be impossible to print images with direct connection of the camera to some printers. If the PictBridge startup screen is not displayed in the monitor after the camera is connected to a printer and turned on, turn the camera off and disconnect the USB cable. Set **Charge by computer** to **Off** and reconnect the camera to the printer.

Notes About Charging with Connection to a Computer

- The battery cannot be charged, nor can data be transferred, when the camera is connected to a computer before the camera's display language and date and time have been set (📖24). If the camera's clock battery (📖25) has been exhausted, the date and time must be reset before the battery can be charged or images can be transferred with connection to a computer. In this case, use the Charging AC Adapter EH-69P (📖18) to charge the battery and then set the camera's date and time.
- If the camera is turned off, charging will also stop.
- If the computer enters sleep mode while charging, charging will stop and the camera may turn off.
- When disconnecting the camera from the computer, turn the camera off and then disconnect the USB cable.
- About 4 hours are required to charge a fully exhausted battery. Charging time increases when images are transferred while the battery is charging.
- When the camera is connected to a computer, an application installed on the computer, such as Nikon Transfer 2, may start. If the camera was connected to the computer for the sole purpose of charging the battery, exit the application.
- The camera turns off automatically if there is no communication with the computer for 30 minutes after the battery has finished charging.
- Depending upon computer specifications, settings, and power supply and allocation, it may be impossible to charge the battery using a computer connection while it is inserted into the camera.

The Charge Lamp

The following chart explains charge lamp status when the camera is connected to a computer.

Charge lamp	Description
Flashes slowly (green)	Battery charging.
Off	Battery not charging. If the charge lamp changes from slow flashing (green) to off while the power-on lamp is lit, charging is complete.
Flashes quickly (green)	<ul style="list-style-type: none"> • The ambient temperature is not suited to charging. Charge the battery indoors with an ambient temperature of 5°C to 35°C (41°F to 95°F). • The USB cable is not connected correctly, or the battery is faulty. Make sure the USB cable is connected correctly and replace the battery if necessary. • The computer is in sleep mode and is not supplying power. Wake up the computer. • The battery cannot be charged because the computer cannot supply power to the camera due to the computer's settings or its specifications.

Blink Warning

Press the MENU button →  tab → Blink warning

Select whether or not the camera detects human subjects that have blinked using face detection (📖73) when shooting in the following modes:

-  (auto) mode (when **Face priority** (🔧43) is selected for AF area mode option)
- **Scene auto selector** (📖42), **Portrait** (📖42), or **Night portrait** (📖43) scene mode

Option	Description
On	When the camera detects that one or more human subjects may have blinked in an image captured using face detection, the Did someone blink? screen is displayed in the monitor. The face of the human subject that may have blinked when the shutter was released is framed by a yellow border. Should this occur, check the image and determine whether or not another image should be captured. See “The Blink Warning Screen” (🔧83) for more information.
Off (default setting)	Blink warning is disabled.

Notes About Blink Warning







The blink warning does not function at continuous settings other than **Single** (🔧38).

The Blink Warning Screen

When the **Did someone blink?** screen shown on the right is displayed in the monitor, the operations described below are available.



If no operations are performed within a few seconds, the camera automatically returns to shooting mode.



Function	Control	Description
Enlarge the detected face that blinked	T (Q)	Rotate the zoom control to T (Q).
Switch to full-frame playback	W (checkered flag)	Rotate the zoom control to W (checkered flag).
Select the face to be displayed		If the camera detects that more than one human subject blinked, press ◀ or ▶ to switch the display to another face.
Delete the image		Press the  button.
Switch to shooting mode		Press the  button or the shutter-release button.
		

Eye-Fi Upload

Press the MENU button →  tab → Eye-Fi upload





Option	Description
 Enable	Upload images created by the camera to a preselected destination.
 Disable (default setting)	Images will not be uploaded.

Notes About Eye-Fi Cards

- Note that images will not be uploaded if signal strength is insufficient even if **Enable** is selected.
- Select **Disable** where wireless devices are prohibited.
- Refer to the instruction manual of your Eye-Fi card for more information. In the event of malfunction, contact the card manufacturer.
- The camera can be used to turn Eye-Fi cards on and off, but may not support other Eye-Fi functions.
- The camera is not compatible with the endless memory function. When it is set on a computer, disable the function. If the endless memory function is enabled, the number of pictures taken may not be displayed correctly.
- Eye-Fi cards are for use only in the country of purchase. Observe all local laws concerning wireless devices.
- Leaving the setting as **Enable** will result in the battery being depleted in a shorter period of time.

Eye-Fi communication indicator

The communication status of the Eye-Fi card in the camera can be confirmed on the monitor (.

- : **Eye-Fi upload** is set to **Disable**.
-  (lights): Eye-Fi upload enabled; waiting to begin upload.
-  (flashes): Eye-Fi upload enabled; uploading data.
- : Eye-Fi upload enabled but no images available for upload.
- : An error occurred. The camera cannot control the Eye-Fi card.

Supported Eye-Fi Cards

As of November 2011, the following Eye-Fi cards can be used. Be sure that the Eye-Fi card firmware has been updated to the latest version.

- Eye-Fi Connect X2 SDHC 4GB
- Eye-Fi Mobile X2 SDHC 8GB
- Eye-Fi Pro X2 SDHC 8GB

Filmstrip

Press the MENU button → Y tab → Filmstrip

Allows you to select whether or not the filmstrip is displayed when you rotate the multi selector quickly in full-frame display.

Option	Description
On	<p>Image thumbnails are displayed at the bottom of the monitor when you rotate the multi selector quickly while viewing an image in full-frame display. You can view thumbnails of previous and subsequent images, and select an image. While the filmstrip is displayed, you can hide it by pressing the OK button.</p> 
Off (default setting)	Disables the filmstrip.

Notes About Filmstrip Display

To display the filmstrip in normal playback mode, ten or more images must be saved in the camera's internal memory or on the memory card.

To display the filmstrip in favorite pictures, auto sort, or list by date mode, ten or more images must be saved in the selected album, category, or date.

Reset All

Press the MENU button → Y tab → Reset all

When **Reset** is selected, the camera's settings will be restored to their default values.

Basic Shooting Functions

Option	Default value
Flash mode (📖62)	Auto
Self-timer (📖64)	Off
Macro mode (📖65)	Off
Exposure compensation (📖66)	0.0

Shooting Menu

Option	Default value
Image mode (📖69)	📷 4608×3456
White balance (🔍36)	Auto
Continuous (🔍38)	Single
ISO sensitivity (🔍41)	Auto
Color options (🔍42)	Standard color
AF area mode (🔍43)	Face priority
Autofocus mode (🔍45)	Single AF

Scene Mode

Option	Default value
Scene mode setting in the shooting mode selection menu (📖41)	Scene auto selector
Night portrait (📖43)	Tripod
Night landscape (📖45)	Hand-held
Hue adjustment in food mode (📖46)	Center
HDR in backlighting scene mode (📖47)	Off
Easy panorama (📖48)	Normal (180°)
Continuous shooting in pet portrait mode (📖49)	Continuous
Pet portrait auto release in pet portrait mode (📖49)	On

Special effects mode

Option	Default value
Special effects mode setting in the shooting mode selection menu (📖51)	Soft

Smart Portrait Menu

Option	Default value
Skin softening (🔍46)	Normal
Smile timer (🔍46)	On
Blink proof (🔍47)	Off

Subject Tracking Menu

Option	Default value
Autofocus mode (🔍48)	Full-time AF
Face priority tracking (🔍48)	On

Movie Menu

Option	Default value
Movie options (🔍62)	HD 1080p★ (1920×1080)
Open with HS footage (🔍63)	On
Autofocus mode (🔍64)	Single AF
Wind noise reduction (🔍64)	Off

Setup Menu

Option	Default value
Welcome screen (🔍65)	None
Photo info (🔍69)	Auto info
Image review (🔍69)	On
Brightness (🔍69)	3
Print date (🔍71)	Off
Vibration reduction (🔍72)	On
Motion detection (🔍73)	Auto
AF assist (🔍74)	Auto
Digital zoom (🔍74)	On
Button sound (🔍75)	On
Shutter sound (🔍75)	On

The Setup Menu

Option	Default value
Auto off (Fn76)	1 min
HDMI (Fn79)	Auto
HDMI device control (Fn79)	On
HDMI 3D output (Fn79)	On
Charge by computer (Fn80)	Auto
Blink warning (Fn82)	Off
Eye-Fi upload (Fn84)	Disable
Filmstrip (Fn85)	Off

Others

Option	Default value
Paper size (Fn27, Fn28)	Default
Frame interval for Slide show (Fn53)	3 s
Sequence display options (Fn61)	Key picture only

- Selecting **Reset all** also clears the current file number (Fn90) from memory. Numbering will continue from the lowest number available. To reset file numbering to "0001", delete all images saved in the internal memory or on the memory card (Fn34) before selecting **Reset all**.
- The following menu settings will remain unaffected when menus are reset with **Reset all**.

Shooting menu: Preset manual data (Fn37) acquired for **White balance**

Playback menu: **Choose key picture** (Fn61)

Setup menu: **Time zone and date** (Fn66), **Language** (Fn78), and **Video mode** (Fn79) under **TV settings**

Others: Favorite album icon (Fn9)

Firmware Version

Press the MENU button → Y tab → Firmware version

View the current camera firmware version.

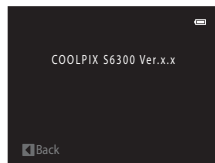

File and Folder Names

Images, movies, or voice memos are assigned file names as follows.

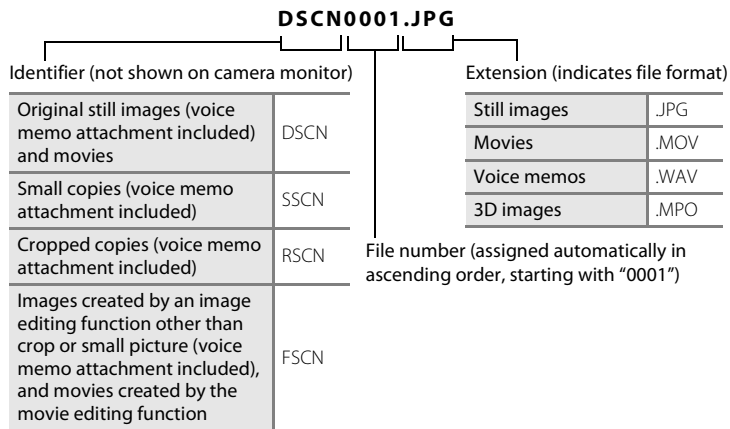

- Files are saved in folders named with a folder number followed by "NIKON" (e.g. "100NIKON"). When the number of files within a folder reaches 9999, a new folder will be created. File numbers will be assigned automatically starting with "0001".
- Voice memo file names have the same identifier and file number as the image to which the voice memo is attached.
- Files copied using **Copy>Selected images** are copied to the current folder, where they are assigned new file numbers in ascending order starting from the largest file number in memory. **Copy>All images** copies all folders from the source medium; file names do not change but new folder numbers are assigned in ascending order, starting from the largest folder number on the destination medium (📷59).
- A single folder can hold up to 200 images; if the current folder already contains 200 images, a new folder, named by adding one to the current folder name, will be created the next time an image is captured. If the current folder is numbered 999 and contains 200 images, or an image is numbered 9999, no further images can be captured until the internal memory or memory card is formatted (📷77), or a new memory card is inserted.



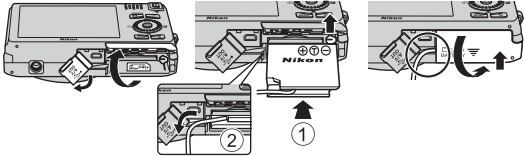

Optional Accessories











Rechargeable battery	Rechargeable Li-ion Battery EN-EL12 ¹
Charging AC adapter	Charging AC Adapter EH-69P ^{1,2}
Battery charger	Battery Charger MH-65 (Charging time when no charge remains: Approx. 2 h 30 min)
AC adapter	AC Adapter EH-62F (connect as shown)  <p>Be sure that the power connector cord has been properly aligned in power connector and battery chamber grooves before closing the battery-chamber/memory card slot cover. If part of the cord runs out of the grooves, the cover or cord may be damaged when the cover is closed.</p>
USB cable	USB Cable UC-E6 ¹
Audio/video cable	Audio Video Cable EG-CP16 ¹

¹ Included with the camera at the time of purchase (📖ii).











² When using in other countries, use a plug adapter (commercially available) as necessary. For more information about plug adapters, consult your travel agency.







Error Messages

Display	Cause/Solution	
 (flashes)	Clock not set. Set date and time.	 66
Battery exhausted.	Charge or replace battery.	16, 18
Battery temperature high	Battery temperature is high. Turn off camera, and allow battery to cool down before resuming use. After five seconds, this message will disappear, the monitor will turn off, and the power-on lamp will flash quickly. After the lamp flashes for three minutes, the camera will turn off automatically. Pressing the power switch also turns off the camera.	23
The camera will turn off to prevent overheating.	Inside of the camera has become hot. Turn off camera, and allow battery to cool down before resuming use.	–
 ● (● flashes red)	Camera cannot focus. <ul style="list-style-type: none"> • Refocus. • Use focus lock. 	30, 31 76
Please wait for the camera to finish recording.	Camera cannot perform other operations until saving is complete. Wait until message clears from display automatically when saving is complete.	–
Memory card is write protected.	Write-protect switch is in “lock” position. Slide write-protect switch to “write” position.	–
Not available if Eye-Fi card is locked.	Write-protect switch of Eye-Fi card is in “lock” position. Slide the write-protect switch to “write” position.	–
	Error accessing Eye-Fi card. <ul style="list-style-type: none"> • Use an approved card. • Check that terminals are clean. • Confirm that Eye-Fi card is correctly inserted. 	 84 20 20
This card cannot be used.	Error accessing memory card. <ul style="list-style-type: none"> • Use approved card. • Check that terminals are clean. • Confirm that memory card is correctly inserted. 	21 20 20
This card cannot be read.		







Display	Cause/Solution	
Card is not formatted. Format card? Yes No	Memory card has not been formatted for use in COOLPIX S6300. Formatting deletes all data saved on the memory card. Be sure to select No and make copies of any images which need to be kept before formatting the memory card. Select Yes and press the  button to format the memory card.	 4
Out of memory.	Memory card is full. <ul style="list-style-type: none"> Select smaller image size. Delete images. Insert new memory card. Remove memory card and use internal memory. 	69 34, 92 20 21
Image cannot be saved.	Error occurred while saving image. Format internal memory or memory card.	 77
	Camera has run out of file numbers. Insert a new memory card or format internal memory or memory card.	 90
	Image cannot be used for welcome screen. The following images cannot be registered as welcome screen. <ul style="list-style-type: none"> Images captured at an Image mode setting of  4608x2592 Images captured using Easy panorama and 3D photography Images reduced to 320 x 240 size or smaller with cropping or small image editing 	 65
	Insufficient space to save a copy. Delete images from destination.	34
Album is full. No further pictures can be added.	200 images have already been added to album. <ul style="list-style-type: none"> Remove some images from album. Add to other albums. 	 8  7
Sound file cannot be saved.	A voice memo cannot be attached to this file. <ul style="list-style-type: none"> Voice memos cannot be attached to movies. Select an image captured with this camera. 	–  58
A blink was detected in the picture just taken.	One or more portrait subjects may have blinked when the picture was taken. Check the image in playback mode.	32, 56

Error Messages

Display	Cause/Solution	
Image cannot be modified.	Cannot edit selected image. <ul style="list-style-type: none"> • Select images that support editing function. • Movies cannot be edited. 	 17 –
Cannot record movie.	Time out error while saving movie on the memory card. Select memory card with faster write speed.	20
Memory contains no images.	No images in the internal memory or memory card. <ul style="list-style-type: none"> • Remove the memory card from the camera to play back images saved in the camera's internal memory. • To copy the images saved in the camera's internal memory to the memory card, press the MENU button to select Copy in the playback menu. 	20  59
	No images have been added to the selected album. <ul style="list-style-type: none"> • Add images to the album. • Select an album to which images are added. 	 7  8
	No images are contained in the category selected in auto sort mode. Select the category containing the sorted images.	 10
File contains no image data.	File not created with this camera.	–
This file cannot be played back.	File cannot be viewed on this camera. View file using a computer or the devices used to create or edit this file.	–
All images are hidden.	No images available for a slide show.	 53
This image cannot be deleted.	Image is protected. Disable protection.	 54
Travel destination is in the current time zone.	Destination in same time zone as home.	 68
Unable to create panorama.	Could not shoot using easy panorama. Shooting with easy panorama may not be possible in the following situations. <ul style="list-style-type: none"> • When shooting does not end after a certain amount of time. • When the camera is moved too fast. • When the camera is not moved properly in the panorama direction. 	 2
Unable to create panorama. Pan the camera in one direction only.		
Unable to create panorama. Pan the camera more slowly.		

Display	Cause/Solution	
Shooting failed	When taking 3D pictures, the first shot could not be successfully taken. <ul style="list-style-type: none"> • Try shooting again. • In some shooting conditions, such as when the subject is moving, dark, or low in contrast, shooting may not be possible. 	 5
Failed to take second shot	When taking 3D images, the second shot could not be successfully taken after the first shot. <ul style="list-style-type: none"> • Try shooting again. After taking the first shot, move the camera horizontally and frame the subject so that it is aligned with the guide. • In some shooting conditions, such as when the subject is moving, dark, or low in contrast, the second shot may not be taken. 	 5 —
Failed to save 3D image	Failed to save the 3D images. <ul style="list-style-type: none"> • Try shooting again. • Delete unnecessary images. • 3D images may not be created depending on the shooting conditions, such as when the subject is moving, dark, or low in contrast, and they cannot be saved. 	 5 34 —
Lens error	Lens error. Turn camera off and then on again. If error persists, contact retailer or Nikon-authorized service representative.	22
Communications error	Error occurred during communication with printer. Turn camera off and reconnect USB cable.	 26
System error	Error has occurred in camera's internal circuitry. Turn camera off, remove and reinsert battery, and turn camera on. If error persists, contact retailer or Nikon-authorized service representative.	16, 23
Printer error: check printer status.	Printer error. Check printer. After solving the problem, select Resume and press the  button to resume printing.*	—
Printer error: check paper	Specified size of paper is not loaded in printer. Load the specified paper size, select Resume , and press the  button to resume printing.*	—

Error Messages

Display	Cause/Solution	
Printer error: paper jam	Paper has jammed in printer. Remove the jammed paper, select Resume , and press the  button to resume printing.*	–
Printer error: out of paper	No paper is loaded in printer. Load the specified paper size, select Resume , and press the  button to resume printing.*	–
Printer error: check ink	Ink error. Check ink, select Resume , and press the  button to resume printing.*	–
Printer error: out of ink	Running out of ink or ink cartridge is empty. Replace ink cartridge, select Resume , and press the  button to resume printing.*	–
Printer error: file corrupt	An error caused by the image file has occurred. Select Cancel and press the  button to cancel printing.	–

* See the documentation provided with your printer for further guidance and information.



Technical Notes and Index

Maximizing Camera Life and Performance	2
The Camera.....	2
The Battery.....	3
Charging AC Adapter.....	4
Memory Cards.....	4
Cleaning and Storage.....	5
Cleaning.....	5
Storage.....	5
Troubleshooting.....	6
Specifications.....	13
Supported Standards.....	16
Index.....	17

Maximizing Camera Life and Performance

The Camera

To ensure continued enjoyment of this Nikon product, observe the precautions described below in addition to the warnings in “For Your Safety” (📖vi) when using or storing the device.

✔ Do Not Drop

The product may malfunction if subjected to strong shock or vibration.

✔ Handle the Lens and All Moving Parts with Care

Do not apply force to the lens, lens cover, monitor, memory card slot, or battery chamber. These parts are easily damaged. Applying force to the lens cover could result in camera malfunction or damage to the lens. Should the monitor break, care should be taken to avoid injury caused by broken glass and to prevent the liquid crystal from the display touching the skin or entering the eyes or mouth.

✔ Keep Dry

The device will be damaged if immersed in water or subjected to high humidity.

✔ Avoid Sudden Changes in Temperature

Sudden changes in temperature, such as when entering or leaving a heated building on a cold day, can cause condensation to form inside the device. To prevent condensation, place the device in a carrying case or a plastic bag before exposing it to sudden changes in temperature.

✔ Keep away from Strong Magnetic Fields

Do not use or store this device in the vicinity of equipment that generates strong electromagnetic radiation or magnetic fields. Strong static charge or the magnetic fields produced by equipment such as radio transmitters could interfere with the monitor, damage data saved on the memory card, or affect the product’s internal circuitry.

✔ Do Not Point the Lens at Strong Light Sources for Extended Periods

Avoid pointing the lens at the sun or other strong light sources for extended periods when using or storing the camera. Intense light may cause deterioration of the image sensor, producing a white blur effect in photographs.

✔ Turn the Product off Before Removing or Disconnecting the Power Source

Do not remove the battery while the product is on, or while images are being saved or deleted. Forcibly cutting power in these circumstances could result in loss of data or in damage to product memory or internal circuitry.

Notes on the Monitor

- Monitors and electronic viewfinders are constructed with extremely high precision; at least 99.99% of pixels are effective, with no more than 0.01% being missing or defective. Hence while these displays may contain pixels that are always lit (white, red, blue, or green) or always off (black), this is not a malfunction and has no effect on images recorded with the device.
- Images in the monitor may be difficult to see under bright lighting.
- The monitor is lit by an LED backlight. Should the monitor begin to dim or flicker, contact your Nikon-authorized service representative.

The Battery

- Check the battery level before using the camera and replace or charge the battery if necessary. Do not continue charging once the battery is fully charged as this will result in reduced battery performance. Whenever possible, carry a fully charged spare battery when taking pictures on important occasions.
- Do not use the battery at ambient temperatures below 0°C (32°F) or above 40°C (104°F).
- Charge the battery indoors with an ambient temperature of 5°C to 35°C (41°F to 95°F) before use.
- When charging the battery inserted into the COOLPIX S6300 using the Charging AC Adapter EH-69P or a computer, the charge capacity may decrease at battery temperatures 45°C to 60°C (113°F to 140°F).
- The battery is not charged at battery temperatures below 0°C (32°F) or above 60°C (140°F).
- Note that the battery may become hot during use; wait for the battery to cool before charging. Failure to observe these precautions could damage the battery, impair its performance, or prevent it from charging normally.
- On cold days, the capacity of batteries tends to decrease. If an exhausted battery is used at a low temperature, the camera will not turn on. Be sure that the battery is fully charged before heading outside to take pictures in cold weather. Keep spare batteries in a warm place and exchange as necessary. Once warmed, a cold battery may recover some of its charge.
- Dirt on the battery terminals can prevent the camera from functioning. Should the battery terminals become dirty, wipe them off with a clean, dry cloth before use.
- If the battery will not be used for some time, insert it in the camera and run it flat before removing it for storage. The battery should be stored in a cool location with an ambient temperature of 15°C to 25°C (59°F to 77°F). Do not store the battery in hot or extremely cold locations.
- Always remove the battery from the camera or optional battery charger when it is not being used. When inserted, minute amounts of current are drawn from the battery even when not in use. This may result in excessive draining of the battery and complete loss of function. Turning the camera on or off while the battery is exhausted can result in reduced battery life.
- Recharge the battery at least once every six months and completely exhaust it before returning it to storage.
- After removing the battery from the camera or optional battery charger, replace the included terminal cover and store it in a cool place.
- A marked drop in the time a fully-charged battery retains its charge, when used at room temperature, indicates that the battery needs to be replaced. Purchase a new EN-EL12 battery.
- Replace the battery when it no longer holds a charge. Used batteries are a valuable resource. Please recycle used batteries in accordance with local regulations.

Charging AC Adapter

- The Charging AC Adapter EH-69P is for use only with compatible devices. Do not use with another make or model of device.
- The EH-69P is compatible with AC 100-240 V, 50/60 Hz electrical outlets. When using in other countries, use a plug adapter (commercially available) as necessary. For more information about plug adapters, consult your travel agency.
- Do not, under any circumstances, use another make or model of AC adapter other than Charging AC Adapter EH-69P or USB-AC adapter. Failure to observe this precaution could result in overheating or in damage to the camera.

Memory Cards

- Use only Secure Digital memory cards. See “Approved Memory Cards” (📖21) for recommended memory cards.
- Observe the precautions noted in the documentation included with your memory card.
- Do not affix labels or stickers to the memory card.
- Do not format the memory card using a computer.
- When you use memory cards that have been used with other devices for the first time, be sure to format them with this camera. We recommend formatting new memory cards with this camera before using them with this camera.
- Note that **formatting a memory card permanently deletes all images and other data on the memory card**. If there is data saved on the memory card that you wish to keep, copy that data to a computer before formatting.
- If the message **Card is not formatted. Format card?** is displayed when the camera is turned on, the memory card must be formatted. If there is data on the memory card that you do not want to delete, select **No** and press the **(X)** button. Copy that data to a computer before formatting. To format the memory card, select **Yes**.
- Observe the following precautions while formatting the memory card, saving and deleting images, and copying images to a computer, otherwise data or the memory card itself may be damaged.
 - Do not open the battery-chamber/memory card slot cover or remove the memory card or battery.
 - Do not turn off the camera.
 - Do not disconnect the AC adapter.

Cleaning and Storage

Cleaning

Lens	Avoid touching glass parts with your fingers. Remove dust or lint with a blower (typically a small device with a rubber bulb attached to one end that is pumped to produce a stream of air out the other end). To remove fingerprints or other stains that cannot be removed with a blower, wipe the lens with a soft cloth, using a spiral motion that starts at the center of them and working toward the edges. If this fails, clean the lens using a cloth lightly dampened with commercial lens cleaner.
Monitor	Remove dust or lint with a blower. To remove fingerprints and other stains, clean the monitor with a soft, dry cloth, being careful not to apply pressure.
Body	Use a blower to remove dust, dirt, or sand, then wipe gently with a soft, dry cloth. After using the camera at the beach or other sandy or dusty environment, wipe off any sand, dust, or salt with a dry cloth lightly dampened with fresh water and dry thoroughly. Note that foreign matter inside the camera could cause damage not covered by the warranty.

Do not use alcohol, thinner, or other volatile chemicals.

Storage

Turn the camera off when not in use. Be sure that the power-on lamp is off before putting the camera away. Remove the battery if the camera will not be used for an extended period. Do not store the camera with naphtha or camphor moth balls, or in any of the following locations:

- Next to equipment that produces strong electromagnetic fields, such as televisions or radios
- Exposed to temperatures below -10°C (14°F) or above 50°C (122°F)
- Places that are poorly ventilated or subject to humidity of over 60%





To prevent mold or mildew, take the camera out of storage at least once a month. Turn the camera on and release the shutter a few times before putting the camera away again.











For storing the battery, follow the precautions in "The Battery" (🔋:3) in "Maximizing Camera Life and Performance" (🔋:2).

Troubleshooting

If the camera fails to function as expected, check the list of common problems below before consulting your retailer or Nikon-authorized service representative.

Power, Display, Settings Issues









Problem	Cause/Solution	
Battery inserted in the camera cannot be charged.	<ul style="list-style-type: none">• Confirm all connections.• Off is selected for Charge by computer in the setup menu.• When charging by connecting the camera to a computer, battery charging stops when the camera is turned off.• When charging by connecting the camera to a computer, battery charging stops when the computer is suspended (sleeping), and the camera may turn off.• Depending upon computer specifications, settings, and status, charging the battery inserted in the camera may not be possible via computer connection.	18 96,  80 96 96 –
Camera cannot be turned on.	<ul style="list-style-type: none">• Battery is exhausted.• The camera cannot be turned on while connected to an electrical outlet via the Charging AC Adapter.	22 18
Camera turns off without warning.	<ul style="list-style-type: none">• Battery is exhausted.• Camera has turned off automatically to save power.• The camera or battery have become too cold and cannot operate properly.• The camera turns off if the Charging AC Adapter is connected while the camera is on.• The camera turns off if the USB cable connecting it to a computer or printer is disconnected. Reconnect the USB cable.• Inside of the camera has become hot. Leave the camera off until the inside of the camera has cooled, and then try turning it on again.	22 95  3 18 81, 84,  26 –













Problem	Cause/Solution	
Monitor is blank.	<ul style="list-style-type: none"> • Camera is off. • Standby mode for saving power: press the power switch, the shutter-release button,  button,  button, or  movie-record) button. • When flash lamp flashes, wait until flash has charged. • Camera and computer are connected via USB cable. • Camera and TV are connected via audio/video cable or HDMI cable. 	23 2, 23 62 81, 84 81,  23
Monitor is hard to read.	<ul style="list-style-type: none"> • Adjust monitor brightness. • Monitor is dirty. Clean monitor. 	94,  69  5
Date and time of recording are not correct.	<ul style="list-style-type: none"> • If camera clock has not been set, “Date not set” indicator flashes during shooting and movie recording. Images and movies saved before clock is set are dated “01/01/2012 00:00”. Set the correct time and date from the Time zone and date option in the setup menu. • Check camera clock regularly against more accurate timepieces and reset as required. 	24, 94,  66
No indicators displayed in monitor.	Hide info is selected for Photo info . Select Show info .	94,  69
Print date not available.	Camera clock has not been set.	24, 94,  66
Date not imprinted on images even when Print date is enabled.	<ul style="list-style-type: none"> • The current shooting mode is one that does not support Print date. • The date cannot be imprinted on movies. 	95,  71
Screen for setting time zone and date is displayed when camera is turned on.	Clock battery is exhausted; all settings were restored to their default values.	24, 25
Camera settings reset.		
Monitor turns off, and the power-on lamp flashes quickly.	Battery temperature is high. Turn off camera and allow battery to cool down before resuming use. After the lamp flashes for three minutes, the camera will turn off automatically. Pressing the power switch also turns off the camera.	23
Camera becomes hot.	The camera may become hot when used for an extended period of time to shoot movies or send images using an Eye-Fi card, or when used in a hot environment; this is not a malfunction.	–

Characteristics of Digital Cameras







In extremely rare instances, unusual characters may appear in the monitor and the camera may stop functioning. In most cases, this phenomenon is caused by a strong external static charge. Turn the camera off, remove and reinsert the battery, then turn the camera on again. In the event of continued malfunction, contact your retailer or Nikon-authorized service representative. Note that disconnecting the power source as described above may result in the loss of any data not saved to internal memory or the memory card at the time the problem occurred. Data already saved will not be affected.

Shooting Issues









Problem	Cause/Solution	
Cannot switch to shooting mode.	Disconnect HDMI cable or USB cable.	81, 84,  23,  26
No image captured when the shutter-release button is pressed.	<ul style="list-style-type: none"> When camera is in playback mode, press the  button, the shutter-release button, or the  button. When menus are displayed, press the MENU button. Battery is exhausted. When flash lamp flashes, flash is charging. 	9, 32 11 22 62
Cannot take 3D pictures.	In some shooting conditions, such as when the subject is moving, dark, or low in contrast, the second shot may not be taken or the 3D image may not be saved.	–
Camera cannot focus.	<ul style="list-style-type: none"> Subject is too close. Try shooting using macro mode, or the Scene auto selector or Close-up scene mode. The intended subject is one with which autofocus does not perform well. Set AF assist in the setup menu to Auto. Turn camera off and then on again. 	42, 45, 65 31 95,  74 23
Images are blurred.	<ul style="list-style-type: none"> Use flash. Increase the ISO sensitivity value. Enable vibration reduction or motion detection. Use BSS (Best Shot Selector). Use tripod and self-timer. 	62 39 95 39, 46,  38 64
Bright specks appear in images captured with flash.	Flash is reflecting off particles in air. Set the flash mode setting to  (off).	63

Problem	Cause/Solution	
Flash does not fire.	<ul style="list-style-type: none"> • The flash mode is set to  (off). • Scene mode with which the flash does not fire is selected. • On is selected for Blink proof in smart portrait menu. • Another function that restricts flash is enabled. 	62 68 56 71
Digital zoom cannot be used.	<ul style="list-style-type: none"> • Digital zoom is set to Off in the setup menu. • Digital zoom cannot be used in the following situations. <ul style="list-style-type: none"> - When Scene auto selector, Portrait, Night portrait, Night landscape, Backlighting (when HDR is set to On), Easy panorama, Pet portrait, or 3D photography is selected in scene mode - When smart portrait mode is selected - When subject tracking mode is selected - When Continuous in the shooting menu is set to Multi-shot 16 	95,  74 42, 43, 49 53 57 39,  38
Image mode not available.	Another function that restricts the Image mode option is enabled.	71
No sound when shutter is released.	Off is selected for Sound settings > Shutter sound in setup menu. No sound is produced with some shooting modes and settings, even when On is selected.	95,  75
AF-assist illuminator does not light.	Off is selected for the AF assist option in the setup menu. AF-assist illuminator may not light depending on the position of the focus area or the current scene mode, even when Auto is selected.	95,  74
Images appear smeared.	Lens is dirty. Clean lens.	 5
Colors are unnatural.	White balance or hue is not adjusted properly.	39, 46,  36
Randomly spaced bright pixels ("noise") appear in image.	The subject is dark, so shutter speed is too slow or ISO sensitivity is too high. Noise can be reduced by: <ul style="list-style-type: none"> • Using flash. • Specifying a lower ISO sensitivity setting. 	62 39,  41
Images are too dark (underexposed).	<ul style="list-style-type: none"> • The flash mode is set to  (off). • Flash window is blocked. • Subject is beyond flash range. • Adjust exposure compensation. • Increase ISO sensitivity. • Subject is backlit. Select Backlighting scene mode or set the flash mode setting to  (fill flash). 	62 28 62 66 39,  41 47, 62







Troubleshooting

Problem	Cause/Solution	
Images are too bright (overexposed).	Adjust exposure compensation.	66
Unexpected results when flash set to  (auto with red-eye reduction).	When taking pictures with  (auto with red-eye reduction) or fill flash with slow sync and red-eye reduction in Night portrait scene mode, In-Camera Red Eye Fix may be applied to areas not affected by red-eye in rare cases. Use any scene mode other than Night portrait , and change the flash mode to any setting other than  (auto with red-eye reduction) and try taking a picture again.	43, 62
Skin tones are not softened.	<ul style="list-style-type: none"> • In some shooting conditions, facial skin tones may not be softened. • Use Skin softening in the playback menu for images containing four or more faces. 	54 79,  19
Saving images takes time.	It may take more time to save images in the following situations. <ul style="list-style-type: none"> • When the noise reduction function is in operation, such as when shooting in a dark environment. • When the flash mode is set to  (auto with red-eye reduction). • When shooting in Night landscape, Night portrait, or Backlighting (when HDR is set to On) scene mode • When the skin softening function is applied while shooting. • When using continuous shooting mode 	– 63 43, 45, 47 42, 43, 56 39,  38
A ring-shaped belt or rainbow-colored stripe appears in the monitor or images.	When shooting with backlighting or when a very strong light source (such as sunlight) is in the frame, a ring-shaped belt or rainbow-colored stripe (ghosting) may occur. Change the position of the light source, or frame the picture so that the light source does not enter the frame and try again.	–

Playback Issues

Problem	Cause/Solution	
File cannot be played back.	<ul style="list-style-type: none"> File or folder was overwritten or renamed by computer or other make of camera. The COOLPIX S6300 is not able to play back movies recorded with another make or model of digital camera. 	<p>–</p> <p>92</p>
Cannot zoom in on image.	<ul style="list-style-type: none"> Playback zoom cannot be used with movies, small pictures, or images that have been cropped to a size of 320 × 240 or smaller. 3D images cannot be enlarged when the camera is connected via HDMI and they are played back in 3D. The COOLPIX S6300 may not be able to zoom in on images captured with another make or model of digital camera. 	<p>–</p> <p>50</p> <p>–</p>
Cannot record voice memos.	<ul style="list-style-type: none"> Voice memos cannot be attached to movies. Voice memos cannot be attached to images captured with other cameras. Voice memos attached to images using another camera cannot be played back on this camera. 	<p>–</p> <p>79, 57</p>
Cannot use quick retouch, D-Lighting, skin softening, filter effects, small picture, or crop.	<ul style="list-style-type: none"> These options cannot be used with movies. Confirm the conditions that are required for editing images. Camera is unable to edit images captured with other cameras. 	<p>–</p> <p>79, 16, 17</p> <p>79, 16, 17</p>
Cannot rotate image.	The COOLPIX S6300 cannot rotate images captured with another make or model of digital camera, or ones captured with 3D photography .	<p>–</p>
Images are not displayed on TV.	<ul style="list-style-type: none"> Video mode or HDMI is not correctly set in the TV settings setup menu. Cables are connected to the HDMI mini connector (Type C) and to the USB/audio/video output connector simultaneously. Memory card contains no images. Replace the memory card. Remove the memory card to play back images from the internal memory. 	<p>96, 79</p> <p>81, 84, 23, 26</p> <p>20</p>
Album icons are reset to their default icons, images added to albums cannot be displayed in favorite pictures mode.	Data saved in the internal memory or on the memory card may not be played back correctly if overwritten by a computer.	<p>–</p>

Troubleshooting

Problem	Cause/Solution	
<p>The saved images are not displayed in auto sort mode.</p>	<ul style="list-style-type: none"> • The desired image was sorted to a category other than the category currently displayed. • Images saved by a camera other than the COOLPIX S6300 and images copied using the Copy option cannot be displayed in auto sort mode. • Images saved in the internal memory or on the memory card may not be played back correctly if overwritten by a computer. • Up to 999 images and movies in total can be added to each category. If the desired category already contains 999 images or movies in total, new images or movies cannot be added. 	<p>78, 10</p> <p>78, 10</p> <p>–</p> <p>78, 10</p>
<p>Nikon Transfer 2 does not start when camera is connected.</p>	<ul style="list-style-type: none"> • Camera is off. • Battery is exhausted. • USB cable is not correctly connected. • Camera is not recognized by the computer. • Confirm system requirements. • Computer is not set to start Nikon Transfer 2 automatically. For more information about Nikon Transfer 2, refer to help information contained in ViewNX 2. 	<p>23</p> <p>22</p> <p>81, 84</p> <p>–</p> <p>82</p> <p>84</p>
<p>The PictBridge startup screen is not displayed when the camera is connected to a printer.</p>	<p>With some PictBridge-compatible printers, the PictBridge startup screen may not be displayed and it may be impossible to print images when Auto is selected for the Charge by computer option in the setup menu. Set the Charge by computer option to Off and reconnect the camera to the printer.</p>	<p>96, 80</p>
<p>Images to be printed are not displayed.</p>	<ul style="list-style-type: none"> • Memory card contains no images. Replace the memory card. • Remove the memory card to print images from the internal memory. • Images captured using 3D photography cannot be printed. 	<p>20</p> <p>20</p> <p>41</p>
<p>Cannot select paper size with camera.</p>	<p>Paper size cannot be selected from the camera in the following situations, even when printing from a PictBridge-compatible printer. Use the printer to select paper size.</p> <ul style="list-style-type: none"> • The printer does not support the paper sizes specified by the camera. • The printer automatically selects the paper size. 	<p>81, 27,</p> <p>28</p> <p>–</p>

Specifications

Nikon COOLPIX S6300 Digital Camera

Type	Compact digital camera
Effective pixels	16.0 million
Image sensor	¹ /2.3-in. type CMOS; approx. 16.79 million total pixels
Lens	10× optical zoom, NIKKOR lens
Focal length	4.5-45.0mm (angle of view equivalent to that of 25-250 mm lens in 35mm [135] format)
f/-number	f/3.2-5.8
Construction	8 elements in 8 groups (1 ED lens element)
Digital zoom	Up to 4× (angle of view equivalent to that of approx. 1000 mm lens in 35mm [135] format)
Vibration reduction	Lens shift
Autofocus (AF)	Contrast-detect AF
Focus range (from lens)	<ul style="list-style-type: none">• [W]: Approx. 50 cm (1 ft 8 in.) to ∞, [T]: Approx. 1 m (3 ft 4 in.) to ∞• Macro mode: Approx. 10 cm (4 in.) to ∞ (wide-angle position)
Focus-area selection	Face priority, auto (9-area automatic selection), manual with 99 focus areas, center, subject tracking
Monitor	6.7-cm (2.7-in.), approx. 230k-dot, TFT LCD with anti-reflection coating and 5-level brightness adjustment
Frame coverage (shooting mode)	Approx. 98% horizontal and 98% vertical
Frame coverage (playback mode)	Approx. 100% horizontal and 100% vertical
Storage	
Media	Internal memory (approx. 25 MB), SD/SDHC/SDXC memory card
File system	DCF, Exif 2.3, DPOF, and MPF compliant
File formats	Still pictures: JPEG 3D images: MPO Sound files (Voice Memo): WAV Movies: MOV (Video: H.264/MPEG-4 AVC, Audio: AAC stereo)
Image size (pixels)	<ul style="list-style-type: none">• 16M (High) [4608 × 3456★]• 16M [4608 × 3456]• 8M [3264 × 2448]• 4M [2272 × 1704]• 2M [1600 × 1200]• VGA [640 × 480]• 16:9 [4608 × 2592]

Specifications

ISO sensitivity (Standard output sensitivity)	<ul style="list-style-type: none">• ISO 125, 200, 400, 800, 1600, 3200• Auto (auto gain from ISO 125 to 1600)• Fixed range auto (ISO 125 to 400, 125 to 800)
Exposure	
Metering	256-segment matrix, center-weighted (digital zoom less than 2x), spot (digital zoom 2x or more)
Exposure control	Programmed auto exposure with motion detection and exposure compensation (–2.0 to +2.0 EV in steps of $\frac{1}{3}$ EV)
Shutter	Mechanical and CMOS electronic shutter
Speed	<ul style="list-style-type: none">• $\frac{1}{2000}$–1 s• $\frac{1}{4000}$–$\frac{1}{120}$ s (Continuous H: 120 fps)• $\frac{1}{4000}$–$\frac{1}{60}$ s (Continuous H: 60 fps)• 4 s (Fireworks show scene mode)
Aperture	Electronically-controlled ND filter (–2.0 AV) selection
Range	2 steps (f/3.2 and f/6.4 [W])
Self-timer	Can be selected from 10 s and 2 s
Flash	
Range (approx.) (ISO sensitivity: Auto)	[W]: 0.5 to 5.6 m (1 ft 8 in. to 18 ft) [T]: 1.0 to 3.1 m (3 ft 4 in. to 10 ft)
Flash control	TTL auto flash with monitor preflashes
Interface	Hi-Speed USB
Data transfer protocol	MTP, PTP
Video output	Can be selected from NTSC and PAL
HDMI output	Can be selected from Auto, 480p, 720p, and 1080i
I/O terminal	Audio/video (A/V) output; digital I/O (USB) HDMI mini connector (Type C) (HDMI output)
Supported languages	Arabic, Chinese (Simplified and Traditional), Czech, Danish, Dutch, English, Finnish, French, German, Greek, Hindi, Hungarian, Indonesian, Italian, Japanese, Korean, Norwegian, Polish, Portuguese (European and Brazilian), Romanian, Russian, Spanish, Swedish, Thai, Turkish, Ukrainian, Vietnamese
Power sources	One Rechargeable Li-ion Battery EN-EL12 (included) AC Adapter EH-62F (available separately)
Charging time	Approx. 3 h and 50 min (when using Charging AC Adapter EH-69P and when no charge remains)
Battery life (EN-EL12)	Still pictures*: Approx. 230 shots Movies: Approx. 1 h (HD 1080p ★ (1920x1080)) The maximum file size for a single movie is 4 GB and the maximum movie length for a single movie is 29 minutes, even when there is sufficient free space on the memory card for longer recording.

Tripod socket	1/4 (ISO 1222)
Dimensions (W × H × D)	Approx. 93.6 × 57.7 × 26.0 mm (3.7 × 2.3 × 1.1 in.) (excluding projections)
Weight	Approx. 160 g (5.7 oz) (including battery and SD memory card)
Operating environment	
Temperature	0°C to 40°C (32°F to 104°F)
Humidity	Less than 85% (no condensation)

- Unless otherwise stated, all figures are for a camera with a fully-charged Rechargeable Li-ion Battery EN-EL12 operated at an ambient temperature of 25°C (77°F).
- * Based on Camera and Imaging Products Association (CIPA) standards for measuring the life of camera batteries. Measured at 23 (±2)°C (73 (±4)°F); zoom adjusted with each shot, flash fired with every other shot, image mode set to **6** **4608×3456**. Battery life may vary depending on shooting interval and length of time menus and images are displayed.

Rechargeable Li-ion Battery EN-EL12

Type	Rechargeable lithium-ion battery
Rated capacity	DC 3.7 V, 1050 mAh
Operating temperature	0°C to 40°C (32°F to 104°F)
Dimensions (W × H × D)	Approx. 32 × 43.8 × 7.9 mm (1.3 × 1.7 × 0.3 in.)
Weight	Approx. 22.5 g (0.8 oz) (excluding terminal cover)

Charging AC Adapter EH-69P

Rated input	AC 100-240 V, 50/60 Hz, 0.068-0.042 A
Rated output	DC 5.0 V, 550 mA
Operating temperature	0°C to 40°C (32°F to 104°F)
Dimensions (W × H × D)	Approx. 55 × 22 × 54 mm (2.2 × 0.9 × 2.2 in.) (excluding plug adapter) For Argentina: Approx. 55 × 59 × 63 mm (2.2 × 2.4 × 2.5 in.) For Korea: Approx. 55 × 59 × 66.5 mm (2.2 × 2.4 × 2.7 in.)
Weight	Approx. 55 g (2.0 oz) (excluding plug adapter) For Argentina and Korea: Approx. 80 g (2.9 oz)

Specifications

- Nikon will not be held liable for any errors this manual may contain.
- The appearance of this product and its specifications are subject to change without notice.

Supported Standards

- **DCF:** Design Rule for Camera File System is a standard widely used in the digital camera industry to ensure compatibility among different makes of camera.
- **DPOF:** Digital Print Order Format is an industry-wide standard that allows images to be printed from print orders saved on memory cards.
- **Exif version 2.3:** Exchangeable image file format (Exif) version 2.3 for digital still cameras is a standard that allows information saved with photographs to be used for optimal color reproduction when images are output from Exif-compliant printers.
- **PictBridge:** A standard developed cooperatively by the digital camera and printer industries, allowing photographs to be output directly to a printer without connecting the camera to a computer.

Index

Symbols

- Auto mode 22, 26, 38
- Scene mode 41
- Special effects mode 51
- Smart portrait mode 53
- Subject tracking mode 57
- Playback mode 32, 78
- Favorite pictures mode 78,
- Auto sort mode 78,
- List by date mode 78,
- Setup menu 94
- T** (Telephoto) 29
- W** (Wide-angle) 29
- Playback zoom 33
- Thumbnail display 33
- Help 41
- (movie-record) button 4, 5
- Shooting mode button 4, 5, 9
- Playback button 4, 5, 9, 32
- Apply selection button 5, 10
- MENU** button 4, 5, 11, 39, 79, 91, 94
- Delete button 4, 5, 34,

Flash mode 62

Self-timer 64

Macro mode 65

Exposure compensation 66

AE/AF-L

Numerics

3D photography **3D** 50,

3D pictures 50,

A

AC adapter 19,

AF area mode 40,

AF assist 95,

Album

Aperture value 30

Audio/video cable 81, 23,

Audio/video-in jack 81, 23

Auto flash 63

Auto mode 26, 38

Auto off 23, 95, 76

Auto sort menu 79, 10

Auto sort mode 78, 10

Autofocus 40, 59, 65, 91, 45, 64

Autofocus mode 40, 59, 91, 45, 48, 64

B

Backlighting 47

Battery 16, 18, 25

Battery chamber 3

Battery charger 19,

Battery latch 16

Battery level 22

Battery-chamber/memory card slot cover 3, 16, 20

Beach 44

Best Shot Selector 46,

Black and white copy 47

Black-and-white 40,

Blink proof 56,

Blink warning 96,

Brightness 94,

BSS 46,

Button sound 75

C

Charge by computer 96,

Charge lamp 3, 19

Charger 18,

Charging AC Adapter 18,

























































Choose key picture 80, 13, 61

Close-up 45

Color options 40,

Compression ratio 69

Index

- Computer 81, 84
- Connector cover 3
- Continuous 39, 38
- Copying images 79, 59
- Crop 22
- Cyanotype 40, 42
- D**
- Date 24, 94, 66
- Date and time 24, 94, 66
- Date format 24, 66
- Daylight 36
- Daylight saving time 25, 94, 67
- Delete 34, 15, 57
- Digital zoom 29, 95, 74
- Direct print 81, 25
- D-Lighting 79, 18
- DPOF 16
- DPOF print 30
- DSCN 90
- Dusk/dawn 44
- E**
- Easy panorama playback 48, 4
- Easy panorama 48, 2
- EH-69P 18, 91
- EN-EL12 16, 18, 91
- Exposure compensation 66
- Extension 90
- Eye-Fi upload 96, 84
- Eyeflet for camera strap 2
- E**
- Face detection 73
- Face priority 40, 43
- Face priority tracking 59, 48
- Favorite pictures menu 79, 8
- Favorite pictures mode 78, 7
- File name 90
- Fill flash 63
- Filmstrip 96, 85
- Filter effects 79, 20
- Fireworks show 46
- Firmware version 96, 89
- Fixed range auto 41
- Flash 62
- Flash lamp 62
- Flash mode 62, 63
- Flash off 63
- Focus 30, 40, 43
- Focus area 30
- Focus indicator 7
- Focus lock 76
- Folder name 90
- Food 46
- Format internal memory 96, 77
- Format memory cards 20, 96, 77
- Formatting 20, 96, 77
- FSCN 90
- Full-frame playback 32
- Full-time AF 40, 91, 45, 64
- H**
- HDMI 79
- HDMI cable 23
- HDMI device control 79
- HDMI mini connector 2
- HDR 47
- Help 41
- High key 51
- High-contrast monochrome 51
- High-speed continuous 39, 38
- HS movie 91, 31, 63
- I**
- Identifier 90
- Image copy 59
- Image mode 69
- Image review 94, 69
- Image size 69
- Imprinting date and time 71

Internal memory 21
 ISO sensitivity 39, 41
J
 JPG 90
L
 Landscape 42
 Language 96, 78
 Lens 2, 13
 Lens cover 2
 List by date menu 79, 12
 List by date mode 78, 12
 Low key LO 51
M
 Macro mode 65
 Memory capacity 22
 Memory card 20
 Memory card slot 20
 Microphone 2
 Monitor 6, 5
 Monitor settings 94, 69
 Motion detection 95, 73
 MOV 90
 Movie editing 92, 34
 Movie length 90
 Movie menu 91
 Movie options 91, 62
 Movie playback 92
 Movie recording 88, 62
 MPO 90
 Multi selector 4, 5, 10
 Multi-shot 16 39
 Museum 46
N
 Night landscape 45
 Night portrait 43
 Nikon Transfer 2 83, 85
 Nostalgic sepia SE 51
 Number of exposures remaining 22, 70

O
 Open with HS footage 91, 31, 63
 Optical zoom 29
 Optional accessories 91
P
 Panorama Maker 6 83
 Paper size 27, 28
 Party/indoor 44
 Pet portrait auto release 49
 Pet portrait 49
 Photo info 94, 69
 PictBridge 81, 25, 16
 Playback 32, 92, 57
 Playback menu 79, 49
 Playback mode 9, 32, 78
 Playback zoom 33
 Portrait 42
 Power 22, 23
 Power switch 22, 23
 Power-on lamp 22, 23
 Preset manual 37
 Pre-shooting cache 39, 38, 40
 Pressing halfway 4
 Print 79, 27, 28, 49
 Print date 25, 95, 71
 Print order 79, 49
 Print order date option 25, 50
 Printer 81, 25
 Protect 79, 54
Q
 Quick retouch 79, 18
R
 Rechargeable battery 91
 Rechargeable Li-ion battery 16, 18, 91
 Recording movies 88, 62

Index

Recording slow motion movies 91,
31, 63

Red-eye reduction 63

Remove from favorites 8

Reset all 96, 86

Rotary multi selector 4, 5, 10

Rotate image 79, 56

RSCN 90

S

Scene auto selector 42

Scene mode 41, 42

Selective color 51

Self-timer 64

Self-timer lamp 2, 64

Sepia 40, 42

Sequence display options 80, 13,
61

Setup menu 94

Shooting 26, 28, 30

Shooting menu 39, 36

Shooting mode 9, 26

Shutter sound 75

Shutter speed 30

Shutter-release button 4, 5, 30

Single 39, 38

Single AF 40, 91, 45, 64

Skin softening 56, 79, 19, 46

Slide show 79, 53

Slow sync 63

Small picture 79, 21

Smart portrait menu 56, 46

Smart portrait mode 53

Smile timer 56, 46

Snow 44

Soft 51

Sound settings 95, 75

Speaker 3

Special effects mode 51

Sports 43

SSCN 90

Standard color 40, 42

Strap 13

Subject tracking menu 59, 48

Subject tracking mode 57

Sunset 44

T

Time difference 94, 68

Time zone 94, 66, 68

Tripod socket 3, 15

TV 81, 23

TV settings 96, 79

U

USB cable 81, 84, 26, 91

USB/audio/video output connector 81,
84, 23, 25

V

Vibration reduction 95, 72

Video mode 79

ViewNX 2 82

Vivid color 40, 42

Voice memo 79, 57

Volume 92, 57

W

WAV 90

Welcome screen 94, 65

White balance 39, 36

Wind noise reduction 91, 64

Z

Zoom control 4, 5, 29

Zoom in 29

Zoom out 29

Nikon

No reproduction in any form of this manual, in whole or in part (except for brief quotation in critical articles or reviews), may be made without written authorization from NIKON CORPORATION.



NIKON CORPORATION

© 2012 Nikon Corporation

YP2E03(11)
6MM20811-03