

Nikon

DIGITAL CAMERA

COOLPIX S4300

Reference Manual



En

Trademark Information

- Microsoft, Windows and Windows Vista are either registered trademarks or trademarks of Microsoft Corporation in the United States and/or other countries.
- Macintosh, Mac OS, and QuickTime are trademarks of Apple Inc., registered in the U.S. and other countries.
- Adobe and Acrobat are registered trademarks of Adobe Systems Inc.
- SDXC, SDHC, and SD Logos are trademarks of SD-3C, LLC.
- PictBridge is a trademark.
- All other trade names mentioned in this manual or the other documentation provided with your Nikon product are trademarks or registered trademarks of their respective holders.

Introduction

Parts of the Camera and Basic Operations

Basic Steps for Shooting and Playback

Shooting Features

Playback Features

Recording and Playing Back Movies

General Camera Setup

Reference Section

Technical Notes and Index

Read This First

Thank you for purchasing the Nikon COOLPIX S4300 digital camera. Before using the camera, please read the information in "For Your Safety" (📖vi) and familiarize yourself with the information provided in this manual. After reading, please keep this manual handy and refer to it to enhance your enjoyment of your new camera.

Confirming the Package Contents

In the event that any items are missing, please contact the store where you purchased the camera.



COOLPIX S4300
Digital Camera



Camera Strap



Rechargeable Li-ion Battery
EN-EL19
(with battery case)

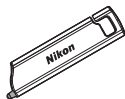

Stylus TP-1

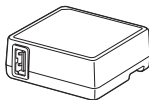

Charging AC Adapter
EH-69P*

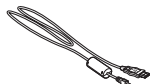

USB Cable UC-E6

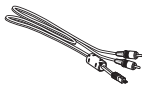

Audio Video Cable EG-CP14



ViewNX 2 Installer CD



Reference Manual CD

- Warranty

* A plug adapter is included only in countries or regions where required, and its shape varies with country or region of purchase (📖18).

NOTE: A memory card is not included with the camera.

About This Manual







If you want to start using the camera right away, see “Basic Steps for Shooting and Playback” (📖15).

To learn about the parts of the camera and basic operations, see “Parts of the Camera and Basic Operations” (📖1).

Other Information

- Symbols and Conventions

To make it easier to find the information you need, the following symbols and conventions are used in this manual:

Symbol	Description
	This icon marks cautions, information that should be read before use, to prevent damage to the camera.
	This icon marks notes, information that should be read before using the camera.
  / 	These icons indicate other pages containing relevant information;  : “Reference Section”,  : “Technical Notes and Index.”

- SD, SDHC, and SDXC memory cards are referred to as “memory cards” in this manual.
- The setting at the time of purchase is referred to as the “default setting.”
- The names of menu options displayed in the camera monitor, and the names of buttons or messages displayed on a computer monitor appear in bold.
- In this manual, images are sometimes omitted from monitor display samples so that monitor indicators can be more clearly shown.
- Illustrations and monitor content shown in this manual may differ from the actual product.

Information and Precautions

Life-Long Learning

As part of Nikon's "Life-Long Learning" commitment to ongoing product support and education, continually updated information is available online at the following sites:

- For users in the U.S.A.: <http://www.nikonusa.com/>
- For users in Europe and Africa: <http://www.europe-nikon.com/support/>
- For users in Asia, Oceania, and the Middle East: <http://www.nikon-asia.com/>

Visit these sites to keep up-to-date with the latest product information, tips, answers to frequently asked questions (FAQs), and general advice on digital imaging and photography. Additional information may be available from the Nikon representative in your area. Visit the site below for contact information:

<http://imaging.nikon.com/>

Use Only Nikon Brand Electronic Accessories

Nikon COOLPIX cameras are designed to the highest standards and include complex electronic circuitry. Only Nikon brand electronic accessories (including battery chargers, batteries, Charging AC Adapter, and AC adapters) certified by Nikon specifically for use with this Nikon digital camera are engineered and proven to operate within the operational and safety requirements of this electronic circuitry.

THE USE OF NON-NIKON ELECTRONIC ACCESSORIES COULD DAMAGE THE CAMERA AND MAY VOID YOUR NIKON WARRANTY.

The use of third-party rechargeable Li-ion batteries not bearing the Nikon holographic seal could interfere with normal operation of the camera or result in the batteries overheating, igniting, rupturing, or leaking.

For more information about Nikon brand accessories, contact a local authorized Nikon dealer.



Holographic seal:

Identifies this device as an authentic Nikon product.

Before Taking Important Pictures

Before taking pictures on important occasions (such as at weddings or before taking the camera on a trip), take a test shot to ensure that the camera is functioning normally. Nikon will not be held liable for damages or lost profits that may result from product malfunction.

About the Manuals

- No part of the documentation included with this product may be reproduced, transmitted, transcribed, stored in a retrieval system, or translated into any language in any form, by any means, without Nikon's prior written permission.
- Nikon reserves the right to change the specifications of the hardware and software described in the documentation at any time and without prior notice.
- Nikon will not be held liable for any damages resulting from the use of this product.
- While every effort was made to ensure that the information in the documentation is accurate and complete, we would appreciate it were you to bring any errors or omissions to the attention of the Nikon representative in your area (address provided separately).

Notice Concerning Prohibition of Copying or Reproduction

Note that simply being in possession of material that was digitally copied or reproduced by means of a scanner, digital camera or other device may be punishable by law.

• Items prohibited by law from being copied or reproduced

Do not copy or reproduce paper money, coins, securities, government bonds or local government bonds, even if such copies or reproductions are stamped "Sample." The copying or reproduction of paper money, coins, or securities which are circulated in a foreign country is prohibited. Unless the prior permission of the government was obtained, the copying or reproduction of unused postage stamps or post cards issued by the government is prohibited. The copying or reproduction of stamps issued by the government and of certified documents stipulated by law is prohibited.

• Cautions on certain copies and reproductions

The government has issued cautions on copies or reproductions of securities issued by private companies (shares, bills, checks, gift certificates, etc.), commuter passes or coupon tickets, except when a minimum of necessary copies are to be provided for business use by a company. Also, do not copy or reproduce passports issued by the government, licenses issued by public agencies and private groups, ID cards and tickets, such as passes and meal coupons.

• Comply with copyright notices

The copying or reproduction of copyrighted creative works such as books, music, paintings, woodcut prints, maps, drawings, movies, and photographs is governed by national and international copyright laws. Do not use this product for the purpose of making illegal copies or to infringe copyright laws.

Disposing of Data Storage Devices

Please note that deleting images or formatting data storage devices such as memory cards or built-in camera memory does not completely erase the original image data. Deleted files can sometimes be recovered from discarded storage devices using commercially available software, potentially resulting in the malicious use of personal image data. Ensuring the privacy of such data is the user's responsibility.

Before discarding a data storage device or transferring ownership to another person, erase all data using commercial deletion software, or format the device and then completely refill it with images containing no private information (for example, images of empty sky). Be sure to also replace any images selected for the **Select an image** option in the **Welcome screen** setting (📷188). Care should be taken to avoid injury or damage to property when physically destroying data storage devices.

For Your Safety

To prevent damage to your Nikon product or injury to yourself or to others, read the following safety precautions in their entirety before using this equipment. Keep these safety instructions where all those who use the product will read them. The consequences that could result from failure to observe the precautions listed in this section are indicated by the following symbol:



This icon marks warnings, information that should be read before using this Nikon product, to prevent possible injury.

WARNINGS

Turn off in the event of malfunction

Should you notice smoke or an unusual smell coming from the camera or Charging AC Adapter, unplug the Charging AC Adapter and remove the battery immediately, taking care to avoid burns. Continued operation could result in injury. After removing or disconnecting the power source, take the equipment to a Nikon-authorized service representative for inspection.

Do not disassemble

Touching the internal parts of the camera or Charging AC Adapter could result in injury. Repairs should be performed only by qualified technicians. Should the camera or Charging AC Adapter break open as the result of a fall or other accident, take the product to a Nikon-authorized service representative for inspection, after unplugging the product and/or removing the battery.

Do not use the camera or Charging AC Adapter in the presence of flammable gas

Do not use electronic equipment in the presence of flammable gas, as this could result in explosion or fire.

Handle the camera strap with care

Never place the strap around the neck of an infant or child.

Keep out of reach of children

Particular care should be taken to prevent infants from putting the battery or other small parts into their mouths.

Do not remain in contact with the camera, battery charger, or AC adapter for extended periods while the devices are on or in use.

Parts of the devices become hot. Leaving the devices in direct contact with the skin for extended periods may result in low-temperature burns.

Observe caution when handling the battery

The battery may leak, overheat, or explode if improperly handled. Observe the following precautions when handling the battery for use in this product:

- Before replacing the battery, turn the product off. If you are using the Charging AC Adapter/AC adapter, be sure it is unplugged.
- Use only a Rechargeable Li-ion Battery EN-EL19 (included). Charge the battery by using a camera that supports battery charging. To perform this operation, use either Charging AC Adapter EH-69P (included) or the **Charge by computer** function. The Battery Charger MH-66 (available separately) is also available to charge the battery without using a camera.
- When inserting the battery, do not attempt to insert it upside down or backwards.
- Do not short or disassemble the battery or attempt to remove or break the battery insulation or casing.
- Do not expose the battery to flame or to excessive heat.
- Do not immerse in or expose to water.
- Return the battery to the battery case for transportation. Do not transport or store with metal objects such as necklaces or hairpins.

- The battery is prone to leakage when fully discharged. To avoid damage to the product, be sure to remove the battery when no charge remains.
- Discontinue use immediately should you notice any change in the battery, such as discoloration or deformation.
- If liquid from the damaged battery comes in contact with clothing or skin, rinse immediately with plenty of water.

Observe the following precautions when handling the Charging AC Adapter

- Keep dry. Failure to observe this precaution could result in fire or electric shock.
- Dust on or near the metal parts of the plug should be removed with a dry cloth. Continued use could result in fire.
- Do not handle the plug or go near the Charging AC Adapter during lightning storms. Failure to observe this precaution could result in electric shock.
- Do not damage, modify, forcibly tug or bend the USB cable, place it under heavy objects, or expose it to heat or flames. Should the insulation be damaged and the wires become exposed, take it to a Nikon-authorized service representative for inspection. Failure to observe these precautions could result in fire or electric shock.

- Do not handle the plug or Charging AC Adapter with wet hands. Failure to observe this precaution could result in electric shock.
- Do not use with travel converters or adapters designed to convert from one voltage to another or with DC-to-AC inverters. Failure to observe this precaution could damage the product or cause overheating or fire.

 **Use appropriate cables**

When connecting cables to the input and output jacks, use only the cables provided or sold by Nikon for the purpose, to maintain compliance with product regulations.

 **Handle moving parts with care**

Be careful that your fingers or other objects are not pinched by the lens cover or other moving parts.

 **CD-ROMs**

The CD-ROMs included with this device should not be played back on audio CD equipment. Playing CD-ROMs on an audio CD player could cause hearing loss or damage the equipment.

 **Observe caution when using the flash**

Using the flash close to your subject's eyes could cause temporary visual impairment. Particular care should be observed if photographing infants, when the flash should be no less than one meter (3 ft 4 in.) from the subject.

 **Do not operate the flash with the flash window touching a person or object**

Failure to observe this precaution could result in burns or fire.

 **Avoid contact with liquid crystal**

Should the monitor break, care should be taken to avoid injury caused by broken glass and to prevent liquid crystal from the monitor touching the skin or entering the eyes or mouth.

 **Turn the power off when using inside an airplane or the hospital**

Turn the power off while inside the airplane during take off or landing. Follow the instructions of the hospital when using while in a hospital. The electromagnetic waves given out by this camera may disrupt the electronic systems of the airplane or the instruments of the hospital.

Notices

Notices for Customers in the U.S.A.

IMPORTANT SAFETY INSTRUCTIONS— SAVE THESE INSTRUCTIONS.

DANGER - TO REDUCE THE RISK OF FIRE OR ELECTRIC SHOCK, CAREFULLY FOLLOW THESE INSTRUCTIONS

For connection to a supply not in the U.S.A., use an attachment plug adapter of the proper configuration for the power outlet if needed.

The power supply unit is intended to be correctly orientated in a vertical or floor mount position.

Federal Communications Commission (FCC) Radio Frequency Interference Statement

This equipment has been tested and found to comply with the limits for a Class B digital device, pursuant to Part 15 of the FCC rules. These limits are designed to provide reasonable protection against harmful interference in a residential installation. This equipment generates, uses, and can radiate radio frequency energy and, if not installed and used in accordance with the instructions, may cause harmful interference to radio communications. However, there is no guarantee that interference will not occur in a particular installation. If this equipment does cause harmful interference to radio or television reception, which can be determined by turning the equipment off and on, the user is encouraged to try to correct

the interference by one or more of the following measures:

- Reorient or relocate the receiving antenna.
- Increase the separation between the equipment and receiver.
- Connect the equipment into an outlet on a circuit different from that to which the receiver is connected.
- Consult the dealer or an experienced radio/television technician for help.



Nikon
COOLPIX S4300

CAUTIONS

Modifications

The FCC requires the user to be notified that any changes or modifications made to this device that are not expressly approved by Nikon Corporation may void the user's authority to operate the equipment.

Interface Cables

Use the interface cables sold or provided by Nikon for your equipment. Using other interface cables may exceed the limits of Class B Part 15 of the FCC rules.

Notice for customers in the State of California

WARNING

Handling the cord on this product will expose you to lead, a chemical known to the State of California to cause birth defects or other reproductive harm.

Wash hands after handling.

Nikon Inc.,
1300 Walt Whitman Road
Melville, New York 11747-3064
USA
Tel: 631-547-4200

Notice for customers in Canada

CAUTION

This Class B digital apparatus complies with Canadian ICES-003.

ATTENTION

Cet appareil numérique de la classe B est conforme à la norme NMB-003 du Canada.

Notices for customers in Europe

CAUTIONS

RISK OF EXPLOSION IF BATTERY IS REPLACED BY AN INCORRECT TYPE.

DISPOSE OF USED BATTERIES ACCORDING TO THE INSTRUCTIONS.

This symbol indicates that this product is to be collected separately.

The following apply only to users in European countries:



- This product is designated for separate collection at an appropriate collection point. Do not dispose of as household waste.
- For more information, contact the retailer or the local authorities in charge of waste management.

This symbol on the battery indicates that the battery is to be collected separately.



















































The following apply only to users in European countries:



























- All batteries, whether marked with this symbol or not, are designated for separate collection at an appropriate collection point. Do not dispose of as household waste.
- For more information, contact the retailer or the local authorities in charge of waste management.

Table of Contents

Introduction	ii
Read This First	ii
Confirming the Package Contents	ii
About This Manual	iii
Information and Precautions	iv
For Your Safety	vi
WARNINGS	vi
Notices	ix
Parts of the Camera and Basic Operations	1
Parts of the Camera	2
The Camera Body	2
Operating the Touch Panel	4
Tapping	4
Dragging	4
Dragging and Dropping	4
Using the Stylus	5
Indicators and Operations of the Monitor/Touch Panel	6
Shooting Mode (Information Indicators)	6
Shooting Mode (Operation Controls)	7
Playback Mode (Information Display)	8
Playback Mode (Operation Controls)	9
Switching Between Shooting Mode and Playback Mode	10
Using Menus (MENU Tab)	11
Pressing the Shutter-release Button	13
Attaching the Camera Strap	13
Basic Steps for Shooting and Playback	15
Preparation 1 Insert the Battery	16
Preparation 2 Charge the Battery	18
Preparation 3 Insert a Memory Card	20
Internal Memory and Memory Cards	21
Approved Memory Cards	21
Step 1 Turn the Camera On	22
Turning the Camera On and Off	23
Setting the Display Language, Date and Time	24
Step 2 Select a Shooting Mode	26
Available Shooting Modes	27
Step 3 Frame a Picture	28
Using the Zoom	29

Step 4 Focus and Shoot	30
Step 5 Play Back Images	32
Changing How Images Are Displayed	33
Step 6 Delete Unwanted Images.....	34
<hr/>	
Shooting Features	37
Using  (Auto) Mode.....	38
Adjusting the  (Auto) Mode Settings	38
Options Available in the Auto Shooting Menu.....	39
Scene Mode (Shooting Suited to Scenes)	41
Changing the Scene Mode Settings.....	41
Scene Mode (Shooting Suited to Scenes).....	43
Special Effects Mode (Applying Effects When Shooting)	50
Changing Special Effects Mode Settings.....	50
Smart Portrait Mode (Capturing Images of Smiling Faces)	51
Changing the Smart Portrait Mode Settings	53
Smart Portrait Menu Options	53
Basic Shooting Settings	54
Functions Available for Each Shooting Mode	54
Using the Flash (Flash Modes)	55
Using the Self-timer	57
Using Macro Mode	59
Adjusting Brightness (Exposure Compensation)	61
Default Settings	62
 Changing the Image Size (Image Mode).....	64
Image Mode Settings (Image Size and Quality)	64
Functions that Cannot Be Applied Simultaneously	66
Face Detection	68
Skin Softening	70
<hr/>	
Playback Features.....	71
Selecting Certain Types of Images for Playback.....	72
Available Playback Modes.....	72
Switching Between Playback Modes	73
Setting the Picture Rating	74
Functions Available in Playback Mode (Playback Menu)	75
Connecting the Camera to a TV, Computer, or Printer	76
Using ViewNX 2	77
Installing ViewNX 2	77
Transferring Images to the Computer	79
Viewing Images.....	80

Recording and Playing Back Movies.....	81
Recording Movies	82
Changing Movie Recording Settings (The Movie Menu)	85
Movie Playback.....	86
General Camera Setup.....	87
The Setup Menu	88
Reference Section	 01
Using the Draw Option	 02
Using Panorama Assist.....	 03
Favorite Pictures Mode	 05
Adding Images to Albums.....	 05
Viewing Images in an Album	 06
Removing Images from Albums	 07
Changing Icons Assigned to Albums.....	 08
Auto Sort Mode	 09
List by Date Mode	 11
Editing Images (Still Images).....	 12
Editing Functions.....	 12
 Paint.....	 14
 Quick Retouch: Enhancing Contrast and Saturation.....	 17
 D-Lighting: Enhancing Brightness and Contrast	 18
 Stretch: Stretching Images	 19
 Perspective Control: Adjusting a Sense of Perspective	 20
 Filter Effects: Applying Digital Filter Effects	 21
 Glamour Retouch: Softening Skin and Making Faces Looking Smaller with Larger Eyes.....	 23
 Small Picture: Reducing Image Size	 24
 Crop: Creating a Cropped Copy	 25
Connecting the Camera to a TV (Playback on a TV)	 27
Connecting the Camera to a Printer (Direct Print)	 29
Connecting the Camera to a Printer.....	 30
Printing Images One by One	 31
Printing Multiple Images.....	 32
The Shooting Menu (for  (Auto) Mode)	 35
 Touch Shooting	 35
 ISO Sensitivity	 42
 Continuous	 43
 White Balance (Adjusting Hue)	 44

The Smart Portrait Menu	0047
 Skin Softening	0047
 Blink Proof	0048
 Smile Timer	0048
The Playback Menu	0049
 Slide Show	0049
 Protect	0051
 Print Order (Creating a DPOF Print Order)	0053
 Rotate Image	0057
 Voice Memo	0058
 Copy (Copy Between Internal Memory and Memory Card)	0060
The Movie Menu	0062
 Movie Options	0062
 Movie AF Mode	0062
 Wind Noise Reduction	0063
The Setup Menu	0064
 Welcome Screen	0064
 Time Zone and Date	0065
 Monitor Settings	0068
DATE Print Date (Imprinting Date and Time)	0070
 Vibration Reduction	0071
 Motion Detection	0072
 AF Assist	0073
 Digital Zoom	0073
 Sound Settings	0074
 Auto Off	0075
 Format Memory/Format Card	0076
 Language	0077
VIDEO Video Mode	0077
 Charge by Computer	0078
 Blink Warning	0080
 Eye-Fi Upload	0082
 Reset All	0083
Ver Firmware Version	0085
File and Folder Names	0086
Optional Accessories	0087
Error Messages	0088

Technical Notes and Index	1
Maximizing Camera Life and Performance	2
The Camera	2
The Battery	3
Charging AC Adapter	4
Memory Cards	4
Cleaning and Storage	5
Cleaning	5
Storage	5
Troubleshooting	6
Specifications	13
Supported Standards	16
Index	17



A series of horizontal dashed lines spanning the width of the page, intended for handwriting practice. There are 15 lines in total, starting from the top right and extending to the bottom left.



Parts of the Camera and Basic Operations

This chapter describes the parts of the camera and also explains how to use basic camera features.

Parts of the Camera	2
The Camera Body	2
Operating the Touch Panel	4
Tapping	4
Dragging	4
Dragging and Dropping	4
Using the Stylus	5
Indicators and Operations of the Monitor/Touch Panel ...	6
Shooting Mode (Information Indicators)	6
Shooting Mode (Operation Controls)	7
Playback Mode (Information Display)	8
Playback Mode (Operation Controls)	9
Switching Between Shooting Mode and Playback Mode	10
Using Menus (MENU Tab)	11
Pressing the Shutter-release Button.....	13
Attaching the Camera Strap	13

➔ If you want to start using the camera right away, see “Basic Steps for Shooting and Playback” (📖15).

Parts of the Camera

The Camera Body

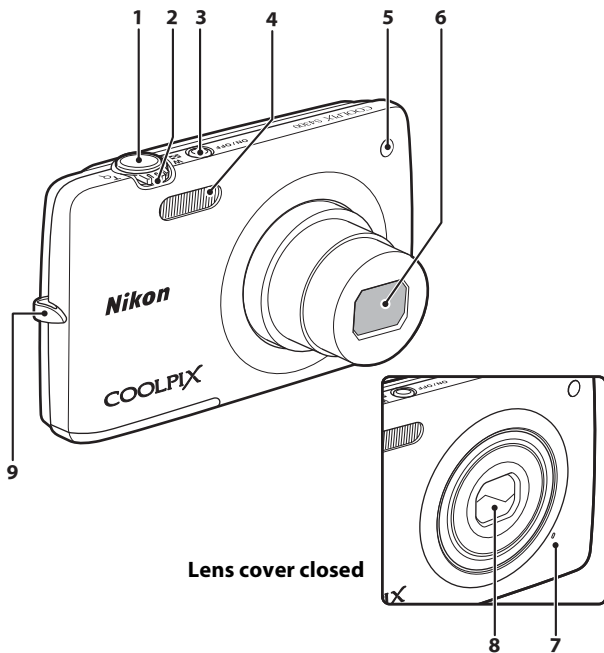

Lens cover closed

1	Shutter-release button.....	13, 30
	Zoom control.....	29
	W : Wide-angle.....	29
2	T : Telephoto.....	29
	: Thumbnail playback.....	33
	: Playback zoom.....	33
3	Power switch/power-on lamp.....	22, 23,

4	Flash.....	55
	Self-timer lamp.....	57
5	AF-assist illuminator.....	89,
6	Lens	
7	Built-in microphone.....	82,
8	Lens cover.....	: 2
9	Eyelet for camera strap.....	13

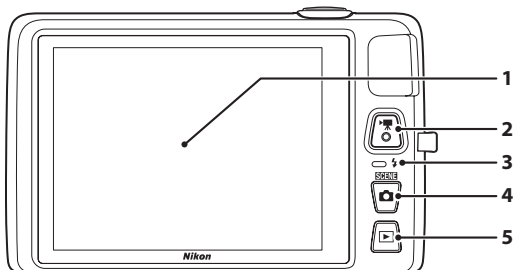

Under the connector cover

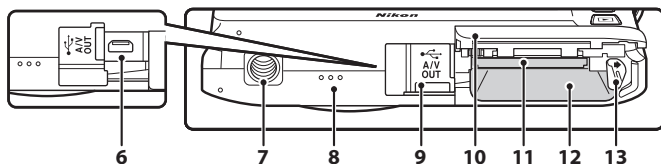

1	Monitor/touch panel	6
2	● (movie-record) button	82
3	Charge lamp	19, 79
	Flash lamp	55
4	📷 (shooting mode) button	10, 26
5	▶ (playback) button	10, 32, 73
6	USB/audio/video output connector	18, 76, 27, 30

7	Tripod socket	
8	Speaker	86, 59
9	Connector cover	18, 76, 27, 30
10	Battery-chamber/ memory card slot cover	16, 20
11	Memory card slot	20
12	Battery chamber	16
13	Battery latch	16, 17

Operating the Touch Panel

The monitor on the COOLPIX S4300 is a touch panel display. Use a finger or the included stylus to operate the touch panel.

Tapping

Tap the touch panel.

Use this operation to:

- Select icons.
- Select images in thumbnail playback mode (📖33).
- Perform touch shutter, touch AF/AE, or subject tracking operations (📖39).
- Display the menu options by tapping the **MENU** tab during shooting or playback (📖11).

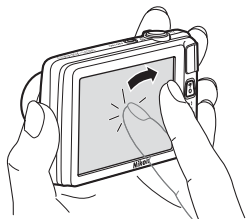

Dragging

Drag your finger across the touch panel and remove it from the touch panel.

Use this operation to:

- Scroll through images in full-frame playback mode (📖32).
- Move the visible portion of an image enlarged with playback zoom (📖33).
- Use sliders to adjust exposure compensation (📖61) or other settings.

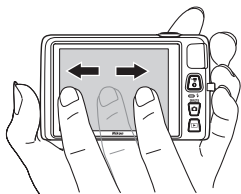

Dragging and Dropping

Place your finger on the touch panel, drag it to the desired location (①), and remove it from the touch panel (②).

Use this operation to:

- Apply the rating setting (📖74).

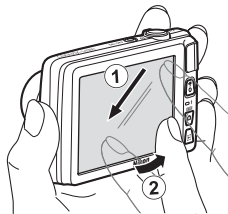

Using the Stylus

Use the stylus for operations, such as when using the draw option (📖47) or the paint option (📖75), that require more precision than using a finger.



Attaching the Stylus

Attach the stylus to the strap as shown.

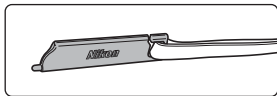

✔ Notes About the Touch Panel

- Do not press on the touch panel with pointed objects other than the included stylus.
- Do not apply unnecessary pressure to the touch panel.

✔ Notes About Tapping/Dragging

- The camera may not respond if your finger is left in one place too long.
- The camera may not respond if the followings are performed:
 - Bounce your finger off the display.
 - Drag your finger over too short a distance.
 - Stroke the display too lightly.
 - Move your finger too quickly.
- The camera may not respond if something else is touching the touch panel when your finger touches it.

✔ Notes About the Touch Panel

- Keep the stylus out of reach of small children.
- Do not carry the camera by the stylus. The stylus may slip off the strap and the camera may fall.

Indicators and Operations of the Monitor/Touch Panel

Shooting Mode (Information Indicators)

- The information displayed on the monitor varies with the camera settings or status. At the default setting, the indicators below are displayed when the camera is turned on or is in operation, and they disappear after a few seconds elapse (when **Photo info** is set to **Auto info** in **Monitor settings** (88)). Tap **DISP** to display them again.

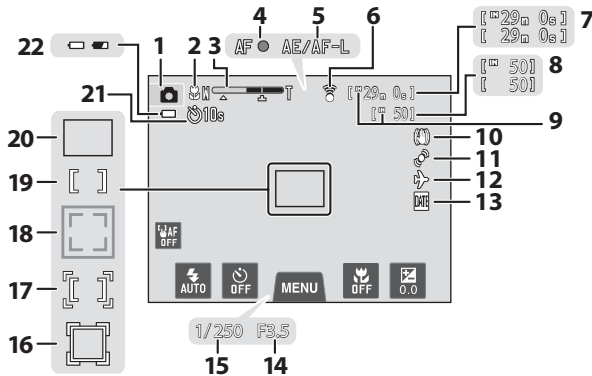

1	Shooting mode ¹	38, 41, 50, 51
2	Macro mode.....	59
3	Zoom indicator.....	29, 59
4	Focus indicator.....	30
5	AE/AF-L indicator.....	84
6	Eye-Fi communication indicator.....	90, 82
7	Movie lengths.....	82
8	Number of exposures remaining (still images) ²	22
9	Internal memory indicator.....	22
10	Vibration reduction icon.....	89, 71
11	Motion detection icon.....	89, 72
12	"Date not set" indicator.....	24, 65, 88
	Travel destination icon.....	88, 65

13	Print date indicator.....	88, 70
14	Aperture.....	30
15	Shutter speed.....	30
16	Focus area (subject tracking mode).....	39, 38
17	Focus area (touch AF/AE).....	39, 40, 40
18	Focus area (face or pet detection).....	30, 49, 51
19	Focus area (center).....	
20	Focus area (auto).....	30
21	Self-timer indicator.....	57
22	Battery level indicator.....	22

¹ Indicators displayed vary with current shooting mode.

² Indicator is displayed when there are 50 or fewer exposures remaining.

Shooting Mode (Operation Controls)

Tap the following controls to change settings.

- Tap the **MENU** tab to display the menu options and shooting settings can be changed (📖11).
- The controls available and indicators displayed vary with shooting mode and the current camera settings.

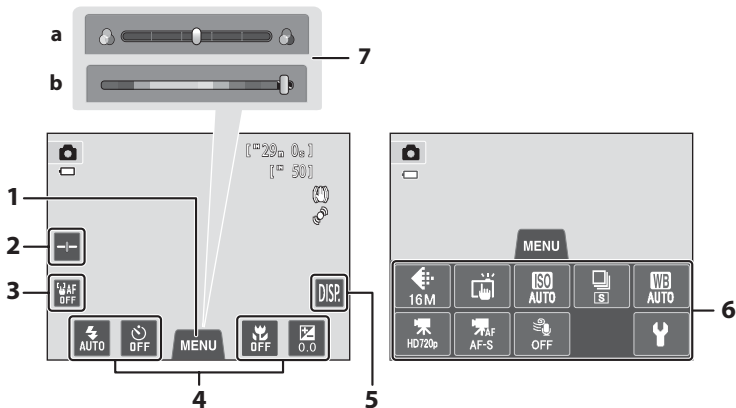

1	MENU Tab.....	11
2	Slider display	42, 50
3	Touch AF/AE cancellation.....	🎮40
4	Basic shooting settings.....	54

5	Information redisplay.....	11
6	Menu options	11
a	Scene effect adjustment slider	42
7	Selective color adjustment slider	50

Playback Mode (Information Display)

- The information displayed on the monitor varies with the image played back and the current camera status.
- At the default setting, the indicators below are displayed when the camera is turned on or is in operation, and they disappear after a few seconds elapse (when **Photo info** is set to **Auto info** in **Monitor settings** (📖88)).

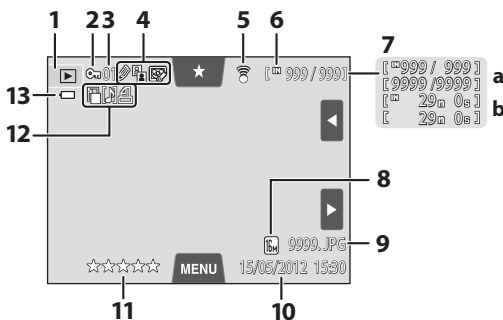

1	Playback mode ¹ 32, 72, 📷5, 📷9, 📷11	6	Internal memory indicator 32
2	Protect icon 75, 📷51	7	a Current frame number/ total number of frames 32
3	Album icon in favorite pictures mode ³ 72, 📷5 Category icon in auto sort mode ³ 72, 📷9	7	b Movie length 86
4	🖌️ Paint icon 75, 📷14 👉 Quick retouch icon 75, 📷17 📷 D-Lighting icon 75, 📷18 🌀 Filter effects icon 75, 📷21 📏 Stretch icon 75, 📷19 📐 Perspective control icon 75, 📷20 👩 Glamour retouch icon 75, 📷23 👧 Skin softening icon 70, 📷23	8	Image mode ² 64 Movie options ² 85, 📷62
5	Eye-Fi communication indicator 90, 📷82	9	File number and type 📷86
		10	Date/time of recording 24
		11	Rating indicator 74
		12	🖼️ Small picture icon 75, 📷24 🗣️ Voice memo icon 75, 📷59 🖨️ Print order icon 75, 📷53
		13	Battery level indicator 22

¹ Indicators displayed vary with current playback mode.

² Indicators displayed vary depending on the setting for shooting.

³ The icon for the selected album or category in auto sort mode currently selected in playback mode is displayed.

Playback Mode (Operation Controls)

Tap the following controls to change settings.

- Tap the **MENU** tab to display the menu options and deleting or editing will be available (📖11).
- The controls available and indicators displayed vary with the image played back and the current camera settings.





1	Movie playback.....	86
2	Rating Tab.....	74
3	Display previous/next image.....	32

4	MENU tab.....	11
5	Menu options.....	12



Switching Between Shooting Mode and Playback Mode

The camera has two modes of operation: Shooting mode, which is used for taking pictures, and playback mode, which is used for viewing images.

While using shooting mode, press the  (playback) button to switch to playback mode; while using playback mode, press the  (shooting mode) button to switch to shooting mode.

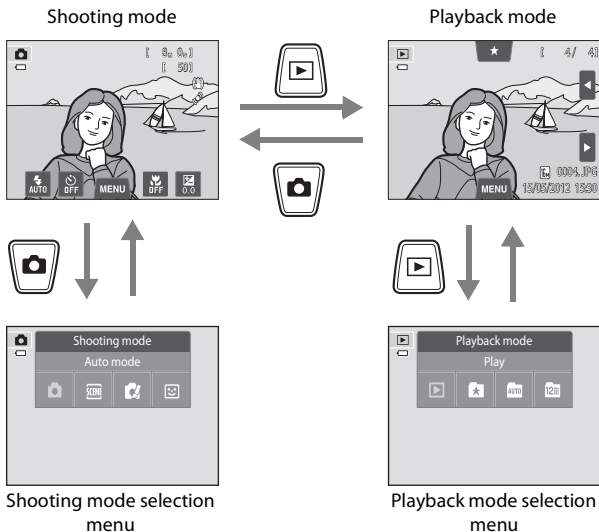
- While using playback mode, you can also switch to shooting mode by pressing the shutter-release button or the  (movie-record) button.



- If you press the  (shooting mode) button while the shooting screen is displayed, the shooting mode selection menu is displayed, from which you can select one of the available shooting modes (📖26).
- If you press the  (playback) button while the playback screen is displayed, the playback mode selection menu is displayed, from which you can select one of the available playback modes (📖72).
- To select a desired shooting or playback mode, tap the icon of that mode.

Using Menu (MENU Tab)

During Shooting

Use the **MENU** tab to change the settings of each shooting mode.

- Change the settings before shooting.
- You can also change the general camera settings using the setup menu.

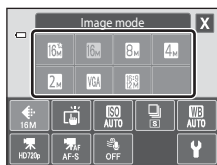
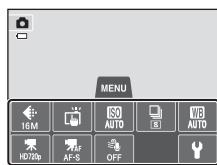
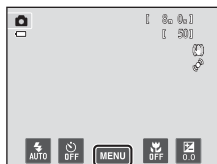

Tap the MENU tab

- The icons of menu options that can be changed in the current mode are displayed.
- If the **MENU** tab is hidden, tap **DISP.**

Tap a menu option

- The setting screen of the selected menu option is displayed.
- Tap **Y** to display the setup menu.
- To hide the menu options, tap the **MENU** tab.

Tap a setting option to apply the setting

- Tap an icon to apply the setting of that item.
- To finish using the setting screen, tap **X**.

During Playback

Use the **MENU** tab to delete or edit images.

- Select images before making changes. You can select images by dragging them while the menu option selection screen is displayed.
- You can also change the general camera settings using the setup menu.

Parts of the Camera and Basic Operations



Tap the MENU tab

- The icons of menu options that can be changed in the current mode are displayed.
- If the **MENU** tab is hidden, tap the monitor.



Tap a menu option

- The setting screen of the selected menu option is displayed.
- Tap **Y** to display the setup menu.
- To hide the menu options, tap the **MENU** tab.

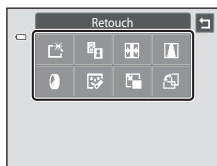

Tap a setting option to apply the setting

- To return to the previous screen, tap **←**.

Pressing the Shutter-release Button

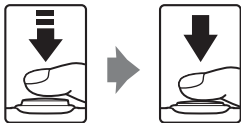

When pressed halfway (i.e., when pressed lightly until you feel a slight resistance): Sets focus and exposure.

When pressed all the way (i.e., if you press the button all the way down): Releases the shutter.

- You can also release the shutter by tapping the monitor. See “ Touch shooting” (39) for more information.

Attaching the Camera Strap

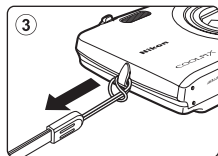
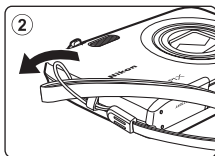
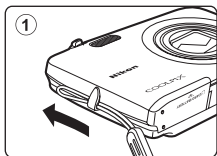



A series of horizontal dashed lines spanning the width of the page, intended for handwriting practice. There are 15 lines in total, starting from the top right and extending to the bottom left.



Basic Steps for Shooting and Playback

Preparation

Preparation 1 Insert the Battery	16
Preparation 2 Charge the Battery	18
Preparation 3 Insert a Memory Card	20



Shooting

Step 1 Turn the Camera On	22
Setting the Display Language, Date and Time (First Use After Purchase)	24
Step 2 Select a Shooting Mode	26
Step 3 Frame a Picture	28
Step 4 Focus and Shoot	30



Playback

Step 5 Play Back Images	32
Step 6 Delete Unwanted Images	34

Preparation 1 Insert the Battery

- 1** Open the battery-chamber/memory card slot cover.

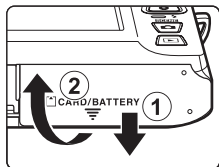

- 2** Insert the included Rechargeable Li-ion Battery EN-EL19.

- Use the edge of the battery to push the orange battery latch in the direction indicated by the arrow (①) and fully insert the battery (②).
- When the battery is properly inserted, the battery latch will lock it in place.

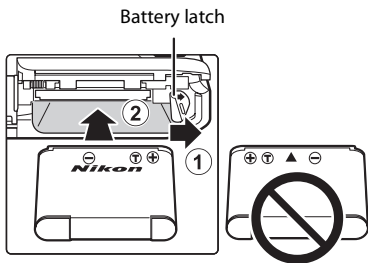

✓ **Inserting the Battery Correctly**

Inserting the battery upside down or backwards could damage the camera. Be sure to check that the battery is in the correct orientation.

- 3** Close the battery-chamber/memory card slot cover.

- Charge the battery before first use or when it is running low. See page 18 for more information.

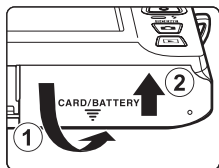

Removing the Battery

Turn the camera off and be sure that the power-on lamp and the monitor have turned off and open the battery-chamber/memory card slot cover.

Push the orange battery latch in the direction indicated by the arrow (①), to partially eject the battery. Pull the battery straight out of the camera (②); do not pull it at an angle.

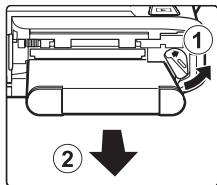

High Temperature Caution

The camera, battery, and memory card may be hot immediately after using the camera. Observe caution when removing the battery or memory card.

Note About the Battery

Be sure to read and follow the warnings for the battery on page vii and the section, “The Battery” (ⓘ:3), before use.

Preparation 2 Charge the Battery

1 Prepare the included Charging AC Adapter EH-69P.

- If a plug adapter* is included, attach the plug adapter to the plug on the Charging AC Adapter. Push the plug adapter firmly until it is securely held in place. Once the two are connected, attempting to forcibly remove the plug adapter could damage the product.

* The shape of the plug adapter varies according to the country or region in which the camera was purchased. The Charging AC Adapter comes with the plug adapter attached in Argentina and Korea.

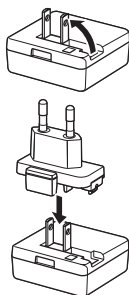

2 Make sure the battery is installed in the camera, and then connect the camera to the Charging AC Adapter in order of ① to ③.

- Keep the camera turned off.
- Be sure that plugs are properly oriented. Do not attempt to insert plugs at an angle, and do not use force when connecting or disconnecting the plugs.

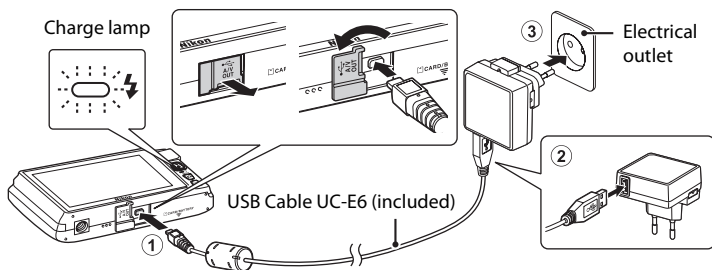

- The charge lamp slowly flashes green to indicate that the battery is charging.
- About 2 hours and 30 minutes are required to charge a fully exhausted battery.
- When the battery has been completely charged, the charge lamp turns off.
- See "Understanding the Charge Lamp" (📖 19) for more information.

3 Disconnect the Charging AC Adapter from the electrical outlet and then disconnect the USB cable.

- When the camera is connected to the electrical outlet with the EH-69P, the camera cannot be turned on.

Understanding the Charge Lamp

Charge lamp	Description
Flashes slowly (green)	The battery is charging.
Off	The battery is not charging. When charging is complete, the charge lamp stops flashing green and turns off.
Flashes quickly (green)	<ul style="list-style-type: none"> The ambient temperature is not suited to charging. Charge the battery indoors with an ambient temperature of 5°C to 35°C (41°F to 95°F). The USB cable or Charging AC Adapter is not properly connected, or there is a problem with the battery. Disconnect the USB cable or unplug the Charging AC Adapter and correctly connect it again, or change the battery.

Note About Charging AC Adapter

Be sure to read and follow the warnings for the Charging AC Adapter on page vii and the section, “The Battery” (p. 3), before use.

Charging Using Computer or Battery Charger

- Connecting the COOLPIX S4300 to a computer also charges the Rechargeable Li-ion Battery EN-EL19 (p. 76, p. 78).
- Rechargeable Li-ion Battery EN-EL19 can also be charged using the Battery Charger MH-66 (available separately; p. 87).

AC Power Supply

- If the AC Adapter EH-62G (available separately; p. 87) is used, COOLPIX S4300 can be powered from an electrical outlet and operated for shooting or playback.
- Do not, under any circumstances, use another make or model of AC adapter other than the EH-62G. Failure to observe this precaution could result in overheating or in damage to the camera.

Preparation 3 Insert a Memory Card

- 1 Be sure that the power-on lamp and the monitor are off and open the battery-chamber/memory card slot cover.

- Be sure to turn off the camera before opening the cover.

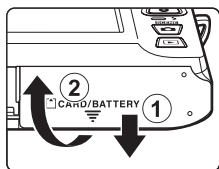

- 2 Insert the memory card.

- Slide the memory card in correctly until it clicks into place.

✓ Inserting the Memory Card

Inserting the memory card upside down or backwards could damage the camera or the memory card. Be sure to check that the memory card is in the correct orientation.

Memory card slot

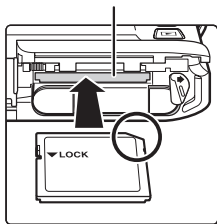

- 3 Close the battery-chamber/memory card slot cover.

✓ Formatting Memory Cards

- The first time you insert a memory card that has been used in another device into this camera, be sure to format it with this camera.
- **All data stored on a memory card is permanently deleted when the card is formatted.** Be sure to transfer important images to a computer and save them before formatting.
- To format a memory card, insert the memory card into the camera and select **Format card** (📖89) from the setup menu (📖88).

✓ Note About Memory Cards

Refer to the documentation included with the memory card, as well as "Memory Cards" (🔧4) in "Maximizing Camera Life and Performance".

Removing Memory Cards

Turn the camera off and be sure that the power-on lamp and the monitor have turned off and open the battery-chamber/memory card slot cover.

Gently push the memory card into the camera (①) to partially eject the card. Pull the memory card straight out of the camera (②); do not pull it at an angle.

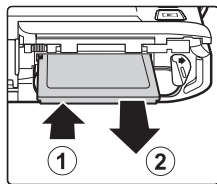

High Temperature Caution

The camera, battery, and memory card may be hot immediately after using the camera. Observe caution when removing the battery or memory card.

Internal Memory and Memory Cards

Camera data, including still images and movies, can be saved in either the camera's internal memory (approximately 74 MB) or on a memory card. To use the camera's internal memory for shooting or playback, first remove the memory card.

Approved Memory Cards

The following Secure Digital (SD) memory cards have been tested and approved for use in this camera.

- Memory cards with an SD Speed Class rating of 6 or faster are recommended for recording movies. When using a memory card with a lower Speed Class rating, movie recording may stop unexpectedly.

	SD memory card	SDHC memory card ²	SDXC memory card ³
SanDisk	2 GB ¹	4 GB, 8 GB, 16 GB, 32 GB	64 GB
TOSHIBA	2 GB ¹	4 GB, 8 GB, 16 GB, 32 GB	64 GB
Panasonic	2 GB ¹	4 GB, 8 GB, 12 GB, 16 GB, 32 GB	48 GB, 64 GB
Lexar	–	4 GB, 8 GB, 16 GB, 32 GB	64 GB, 128 GB

¹ If the memory card will be used with a card reader or similar device, make sure that the device supports 2 GB cards.

² SDHC compliant. If the memory card will be used with a card reader or similar device, make sure that the device supports SDHC.

³ SDXC compliant. If the memory card will be used with a card reader or similar device, make sure that the device supports SDXC.

- Contact the manufacturer for details on the above cards. We cannot guarantee camera performance when using memory cards made by other manufacturers.



Step 1 Turn the Camera On

1 Press the power switch to turn on the camera.

- **If you are turning the camera on for the first time after purchase, see “Setting the Display Language, Date and Time”** (📖24).
- The lens will extend, and the monitor will turn on.

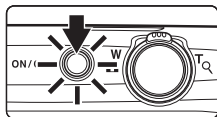

2 Check the battery level indicator and the number of exposures remaining.

Battery level indicator

Number of exposures remaining

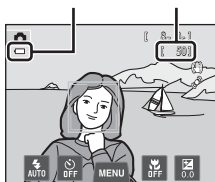

Battery level indicator	Description
	The battery level is high.
	The battery level is low. Prepare to charge or replace the battery.
 Battery exhausted.	The camera cannot take pictures. Recharge or replace with a fully charged battery.

Number of Exposures Remaining

Indicator is displayed when there are 50 or fewer exposures remaining.

-  is displayed when no memory card is inserted in the camera, and images will be saved in the internal memory (approximately 74 MB).
- The number of exposures remaining depends on the remaining capacity of the internal memory or memory card, and the image quality and image size (image mode) (📖65).
- The number of remaining exposures shown in the illustrations in this manual is for example purposes only.



Turning the Camera On and Off

- When the camera is turned on, the power-on lamp (green) will light and then the monitor will turn on (the power-on lamp turns off when the monitor turns on).
- To turn off the camera, press the power switch. When the camera is turned off, both the power-on lamp and the display turn off.
- To turn on the camera in playback mode, press and hold the  (playback) button. The lens will not extend.

Power Saving Function (Auto Off)

If no operations are performed for a while, the monitor will turn off, the camera will enter standby mode, and the power-on lamp will flash. If no operations are performed for approximately another three minutes, the camera will turn off automatically.

To reactivate the monitor while the power-on lamp is flashing, press any of the following buttons:

- Power switch, shutter-release button,  (shooting mode) button,  (playback) button or  (movie-record) button.

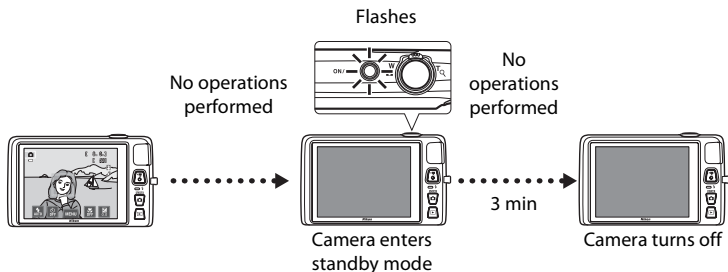

- The time that elapses before the camera enters standby mode can be changed using the **Auto off** setting in the setup menu (88).
- By default, the camera enters standby mode in about one minute when you are using shooting mode or playback mode.
- If you are using the optional AC Adapter EH-62G (available separately), the camera enters standby mode after 30 minutes (fixed).

Step 1 Turn the Camera On

Setting the Display Language, Date and Time

When the camera is turned on for the first time, the language-selection screen and the date and time setting screen for the camera clock are displayed.

1 Tap the desired language.

- For more information about operating the touch panel, see "Operating the Touch Panel" (📖4).



2 Tap Yes.

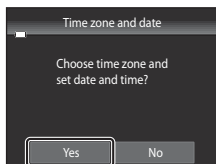

3 Tap ◀ or ▶ to select your home time zone and tap OK.

- For information about "Daylight Saving Time", see page 25.
- Tap ⏪ to return to the previous screen.



4 Tap the order in which the day, month, and year are displayed.

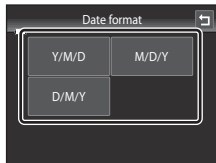

5 Edit the date and time and tap OK.

- Tap the desired field and ▲ or ▼ to edit the value.

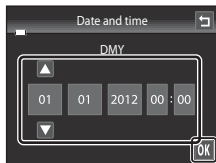

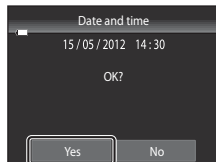

6 Tap Yes.

- The settings are applied, the lens extends, and the camera enters shooting mode.







Daylight Saving Time

If daylight saving time is in effect, tap  in the time zone selection screen displayed in step 3 to turn on the daylight saving time option.

- When the daylight saving time option is enabled,  is displayed at the top of the monitor. To turn off the daylight saving time option, tap  again.





Changing the Language or the Date and Time Setting

- You can change these settings using the **Language** and **Time zone and date** settings in the setup menu (88).
- You can enable or disable daylight saving time by selecting **Time zone and date** and then **Time zone** in the setup menu. When enabled, the clock moves forward one hour; when disabled, the clock moves back one hour. When the travel destination () is selected, the time difference between the travel destination and the home time zone () is automatically calculated and the date and time in the selected region are saved at the time of shooting.
- If you exit without setting the date and time,  will flash when the shooting screen is displayed. Use the **Time zone and date** setting in the setup menu to set the date and time.

The Clock Battery

- The camera clock is powered by the backup battery that is separate from the camera's main battery.
- The backup battery charges when the main battery is inserted into the camera or when the camera is connected to an optional AC adapter, and can provide several days of backup power after about ten hours of charging.
- If the backup battery becomes exhausted, the date and time setting screen is displayed when the camera is turned on. Set the date and time again. See "Setting the Display Language, Date and Time" (step 2, 24) for more information.

Imprinting the Shooting Date in Printed Images

- Set the date and time before shooting.
- You can permanently imprint the shooting date on images as they are taken by setting **Print date** in the setup menu (88).
- If you want the shooting date to be printed without using the **Print date** setting, print using the ViewNX 2 software (77).



Step 2 Select a Shooting Mode

1 Press the button in shooting mode.

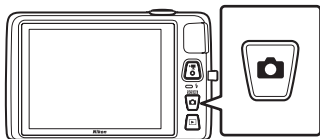
- The shooting mode selection menu, which allows you to select the desired shooting mode, is displayed.



2 Tap the desired shooting mode icon.

-  (auto) mode is used in this example. Tap  **Auto mode**.
- See “Indicators and Operations of the Monitor/Touch Panel” (📖6) for more information.
- The shooting mode setting is saved even after the camera is turned off.

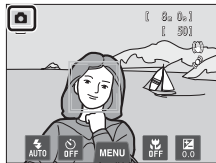
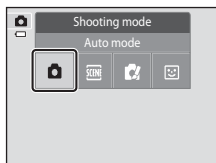

Available Shooting Modes



Auto mode

38

Used for general shooting. Settings can be adjusted in the shooting menu (39) to suit the shooting conditions and the type of shot you want to capture.



Scene

41

When a shooting scene is selected, the camera settings are optimized to take pictures of that type of scene.

- To select a scene mode, tap the icon of the desired scene mode in the shooting mode selection menu.



Special effects

50

Effects can be applied to images during shooting. Six different effects are available.

- To select an effect, first display the shooting mode menu and then tap the desired effect icon.



Smart portrait

51

When the camera detects a smiling face, you can take a picture automatically without pressing the shutter-release button (smile timer). The skin softening option can be used to make skin tones of human faces appear smoother.



Features That Are Available in Each Shooting Mode

- You can change the settings for the flash mode, self-timer, macro mode, and exposure compensation. See “Basic Shooting Settings” (54) for more information.
- When using shooting mode, tap the **MENU** tab (11) to display the menu options for the selected mode. See “Shooting Features” (37) for information about the menu options available for the current shooting mode.

Step 3 Frame a Picture

1 Hold the camera steadily in both hands.

- Keep fingers and other objects away from the lens, flash, AF assist-illuminator, microphone, and speaker.
- When taking pictures in portrait (“tall”) orientation, turn the camera so that the built-in flash is above the lens.

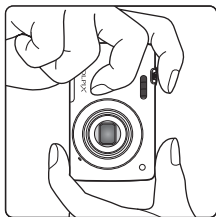
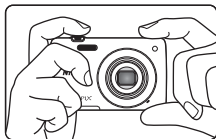

2 Frame the picture.

- When the camera detects a human face, that face is framed by a yellow double border (focus area) (default setting).
- Up to 12 faces can be detected. When the camera detects more than one face, the face closest to the camera is framed by a double border and the others by a single border.
- When shooting non-human subjects or when no faces are detected, the focus area is not displayed. Position the main subject near the center of the frame.

Shooting mode icon

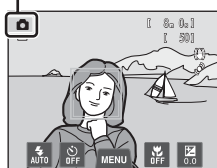

Using a Tripod

- We recommend using a tripod to stabilize the camera when shooting in the following situations:
 - When shooting in dim lighting or when the flash mode (📖56) is set to  (**Off**).
 - When using the telephoto setting.
- Set **Vibration reduction** (📖89) to **Off** in the setup menu when using a tripod to stabilize the camera during shooting.

Using the Zoom

Use the zoom control to activate optical zoom.

- To zoom in closer to the subject, rotate the zoom control to **T** (telephoto).
- To zoom out and view a larger area, rotate the zoom control to **W** (wide-angle).
- The zoom position is set at the maximum wide-angle position when the camera is turned on.
- A zoom indicator is displayed at the top of the monitor when the zoom control is rotated.

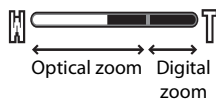
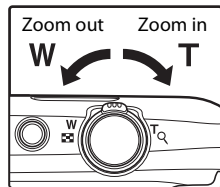

Digital Zoom

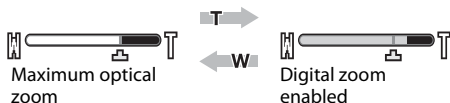

When the camera is zoomed in to the maximum optical zoom position, rotating and holding the zoom control at **T** triggers digital zoom. The subject is magnified up to 4x the maximum optical zoom ratio.



- The camera focuses at the center of the frame and the focus area is not displayed when digital zoom is in effect.

Digital Zoom and Interpolation

Unlike optical zoom, digital zoom uses a digital imaging process known as interpolation to magnify images, resulting in slight deterioration of image quality according to the image mode (📖64) and digital zoom magnification.

Interpolation is applied at zoom positions beyond  when taking still images. When zoom is increased beyond the  position, interpolation is initiated and the zoom indicator turns yellow to indicate that interpolation is being applied.  moves to the right as the image size becomes smaller, allowing you to confirm the zoom position that can be used to capture still images without image degradation before shooting at the current image size setting.



- Digital zoom can be disabled from the **Digital zoom** option (📖89) in the setup menu.

Step 4 Focus and Shoot

1 Press the shutter-release button halfway, i.e., press the button lightly until you feel a slight resistance.

- When you press the shutter-release button halfway, the camera sets focus and exposure (shutter speed and aperture value). Focus and exposure remain locked while the shutter-release button is pressed halfway.

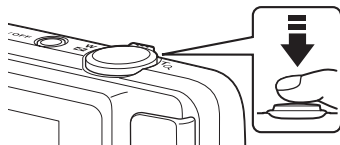

- When a face is detected:
The camera focuses on the face framed by the double border. When the subject is in focus, the double border turns green.

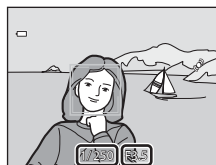

Shutter speed Aperture value

- When a face is not detected:
The camera has nine focus areas, and automatically selects the focus areas containing the subject closest to the camera. When the subject is in focus, the focus areas that are in focus (up to nine areas) glow green.

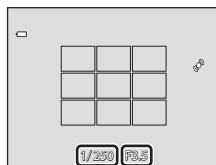

Shutter speed Aperture value

- When digital zoom is used, the focus area is not displayed and the camera focuses at the center of the frame. Once focus has been acquired, the focus indicator (book icon) will glow green.
- While the shutter-release button is pressed halfway, the focus area or focus indicator may flash red. This indicates that the camera is unable to focus. Modify the composition and press the shutter-release button again.

2 Press the shutter-release button all the way, i.e., press the button the rest of the way down.

- The shutter is released and the image will be recorded to the memory card or internal memory.
- If you press the shutter-release button with too much force, the camera may shake, causing images to be blurred. Press the button gently.



✔ Note on Recording Images and Saving Movies

The indicator showing the number of exposures remaining or the indicator showing the maximum movie length flashes while images are being recorded or while a movie is being saved. **Do not open the battery-chamber/memory card slot cover or remove the battery or memory card** while an indicator is flashing. Doing this could result in loss of data, or in damage to the camera or the memory card.

✔ Subjects Not Suitable for Autofocus

Autofocus may not perform as expected in the following situations. In some rare cases, the subject may not be in focus despite the fact that the focus area or the focus indicator glows green.

- Subject is very dark
- Objects of sharply differing brightness are included in the scene (e.g. the sun behind the subject makes that subject appear very dark)
- No contrast between the subject and surroundings (e.g. a portrait subject, wearing a white shirt, is standing in front of a white wall)
- Several objects are at different distances from the camera (e.g. the subject is inside a cage)
- Regular geometric patterns (e.g. window blinds or windows on a skyscraper)
- Subject is moving rapidly

In the situations noted above, try pressing the shutter-release button halfway to refocus several times, or focus on another subject (📖40). When focusing on another subject, be sure that the alternate subject is at the same distance from the camera as the intended subject while the shutter-release button is pressed halfway.

✔ When the Subject Is Close to the Camera

If the camera cannot focus, try shooting with macro mode (📖59) or in the **Close-up** scene mode (📖46).

✔ Note About Face Detection

See “Notes About the Face Detection Function” (📖69) for more information.

📎 Touch Shutter

At the default setting, the shutter can be released by simply tapping a subject in the monitor (📖39) without pressing the shutter-release button. The **Touch shutter** option can be changed to the **Touch AF/AE** option, which allows the camera to set the focus and exposure on the subject that is tapped on the monitor. When using the **Touch AF/AE** option, the image is taken by pressing the shutter-release button.

📎 AF-assist Illuminator and Flash

If the subject is poorly lit, the AF-assist illuminator (📖89) may light up when the shutter-release button is pressed halfway, or the flash (📖55) may fire when the shutter-release button is pressed all the way down.

📎 To Make Sure You Do Not Miss a Shot

If you are concerned that you might miss a shot, press the shutter-release button all the way without first pressing it halfway.

Step 5 Play Back Images

1 Press the (playback) button.

- When you switch from shooting mode to playback mode, the last image saved will be displayed full-frame playback mode.



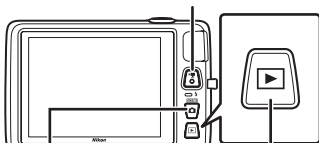



● ( movie-record) button



 (shooting mode) button

 (playback) button

2 Drag the current image to display the previous or next image.



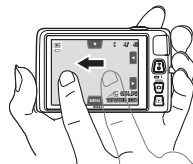
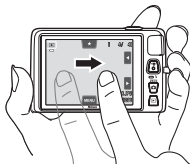

- To display the previous image, drag the image to the right or tap .
- To display the next image, drag the image to the left or tap .
- Tap and hold  or  to scroll backward or forward through the images.
- Remove the memory card from the camera to play back images saved in the camera's internal memory.  is displayed near the current image number/total number of images display.
- Press the  button or shutter-release button to switch to shooting mode. Pressing the ● ( movie-record) button will also return the camera to shooting mode.

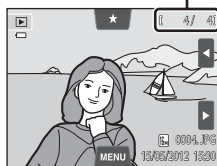



Current frame number/
total number of frames



Viewing Images

- Images may be displayed briefly at low resolution immediately after switching to the next or previous image.
- Images taken using face detection ( 68) or pet detection ( 49) will be rotated and displayed automatically in full-frame playback mode, based on the orientation of the faces detected, except pictures taken using **Continuous**, **BSS**, and **Multi-shot 16** ( 39), or the subject tracking function ( 39).
- The orientation of images can be changed using **Rotate image** ( 75).

Selecting Types of Images for Playback

- See "Functions Available in Playback Mode (Playback Menu)" ( 75) for more information.
- See "Selecting Certain Types of Images for Playback" ( 72) for more information.

Changing How Images Are Displayed

When using playback mode, you can change how images are displayed by rotating the zoom control to **W** (📐) and **T** (🔍) (📖2).

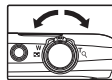

Playback Zoom

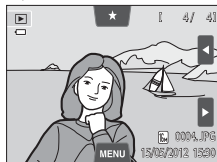

Image is displayed full-frame

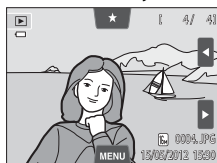

Image is zoomed in

Display area guide

- Images can be zoomed up to 10x. You can adjust the zoom ratio by rotating the zoom control to **W** (📐) and **T** (🔍).
- To view a different area of the image, drag the image or tap ▲, ▼, ◀, or ▶.
- If you are viewing a image that was taken using face detection (📖68) or pet detection (📖49), the camera zooms in on the face detected at the time of shooting, except for pictures taken with **Continuous**, **BSS**, and **Multi-shot 16** or the subject tracking function. If the camera detected multiple faces when the picture was taken, tap 📷 or 🐾 to display a different face. Rotate the zoom control to **W** (📐) or **T** (🔍) to change the zoom ratio and return to normal magnification.
- To delete images, tap 🗑️.
- You can crop the image and save the displayed area of the image as a separate file by tapping ✂️ (📖25).
- Tap ✕ or double-tap an image to return to full-frame playback mode.

Thumbnail Playback



Full-frame display



Image thumbnail display
(4, 9, and 16 images per screen)

Scroll bar

- You can view several images on one screen, making it easy to find the image you want.
- You can change the number of thumbnails displayed by rotating the zoom control to **W** (📐) or **T** (🔍).
- To scroll through the images, drag your finger up or down on the monitor or scroll bar, or tap ▲ or ▼.
- Tap an image to display it in full-frame playback mode.

Step 6 Delete Unwanted Images

- 1 Playback an image to be deleted, tap the **MENU** tab to display the menu options (📖12), and tap .



- 2 Tap the desired delete option.

- **Current image:** Delete the currently displayed full-frame image or movie (📖86).
- **Erase selected images:** Select multiple images and delete them. See “Operating the Erase Selected Images Screen” (📖35) for more information.
- **All images:** Delete all images.
- If step 1 is performed in thumbnail playback mode (📖33), select either **Erase selected images** or **All images**.

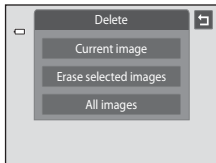

- 3 Tap **Yes** on the delete confirmation dialog.

- Deleted images cannot be recovered.
- To exit without deleting the image, tap  or **No**.

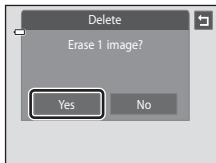







Notes About Deletion

- Once deleted, images cannot be recovered. Transfer important images to a computer before deleting them.
- Protected images cannot be deleted (📖75).

Operating the Erase Selected Images Screen

1 Tap an image to display .

- To deselect the image, tap the image again and  will be hidden.
- Tap  or  or drag the scroll bar vertically to scroll through the display.
- Tap  or , or rotate the zoom control to **T** () or **W** () to change the number of images displayed.



2 Display to all images to delete and tap **OK** to apply the selection.

- The confirmation screen is displayed. Follow the onscreen instructions for more operations.

Selecting Certain Types of Images for Deletion

When using favorite pictures mode, auto sort mode, or list by date mode, you can select images for deletion from an album, category, or shooting date (72).



A series of horizontal dashed lines spanning the width of the page, intended for handwriting practice.

Shooting Features

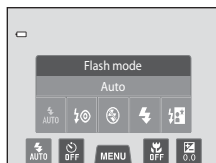
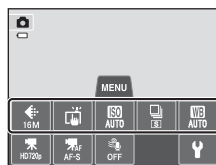
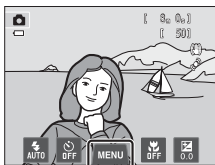
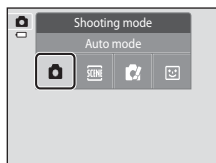
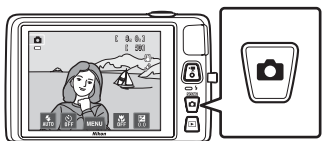

This chapter describes the camera's shooting modes and the features that are available when using each shooting mode.

You can select shooting modes and adjust settings according to the shooting conditions and the kind of images you want to capture.



Using (Auto) Mode

Used for general shooting. Settings can be adjusted in the shooting menu (📖39) to suit the shooting conditions and the type of shot you want to capture.

On the shooting screen →  (shooting mode) button →  (auto) mode (📖26–27)

- If the camera detects a human face, the camera automatically focuses on it (see “Face Detection” (📖68) for more information).
- If no faces are detected, the camera automatically selects one or more of the nine focus areas containing the subject closest to the camera. When the subject is in focus, the focus area (active focus area) lights in green (maximum of nine areas).
- At the default setting, the shutter can be released by simply tapping a subject in the monitor (📖39) without pressing the shutter-release button. The **Touch shutter** option can be changed to the **Touch AF/AE** option, which allows the camera to set the focus and exposure on the subject that is tapped on the monitor (touch shutter) (📖39).
- The **Subject tracking** option, which moves the active focus area to track the registered subject, can be enabled (📖39).

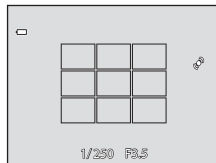



Adjusting the (Auto) Mode Settings





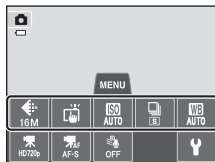











- You can change the settings for the flash mode, self-timer, macro mode, and exposure compensation. See “Basic Shooting Settings” (📖54) for more information.
- If you tap the **MENU** tab (📖11), the menu options available in  (auto) mode are displayed. See “Options Available in the Auto Shooting Menu” (📖39) for more information.

Options Available in the Auto Shooting Menu

In  (auto) mode, the following options can be changed.



On the  (Auto) mode shooting screen → Tap the **MENU** tab ()



Option	Description	
 Image mode	Allows you to select the combination of image size and image quality used when saving images ( 64). The default setting is  4608×3456 . This setting is applied to other shooting modes.	64
 /Touch shooting	Select between Touch shutter (default setting), which allows you to release the shutter by tapping the monitor, Touch AF/AE , which allows you to set the focus area by tapping the monitor, and Subject tracking , which moves the focus area to track the registered subject.	 35
 ISO sensitivity	Higher ISO sensitivity allows you to take pictures of darker subjects. Additionally, even with subjects of similar brightness, images can be taken at faster shutter speeds, and blurring caused by camera shake and subject movement can be reduced. When ISO sensitivity is set to Auto (default setting), the camera sets the ISO sensitivity automatically.	 42
 Continuous	Allows you to select from continuous settings of Single , Continuous , BSS ( 47), or Multi-shot 16 . The default setting is Single (i.e., only one image is captured at a time). In Continuous , while the shutter-release button is held down, up to 6 images are taken at a rate of about 1.3 frames per second (fps) when Image mode is set to  4608×3456 .	 43
 White balance	Allows you to adjust the colors in the image to suit the light source, which can make colors appear as they do to the eye. Although Auto (default setting) can be used under most types of lighting, white balance can be adjusted to suit the sky conditions or light source and achieve more natural color tones in the image. Set the flash mode ( 55) to  (Off) when white balance is set to any setting other than Auto and Flash .	 44

Functions That Cannot Be Used Simultaneously

There are functions with which these settings cannot be enabled (66).

Shooting Subjects Not Suitable for Autofocus

When shooting a subject that is not suitable for autofocus (31), try pressing the shutter-release button halfway to refocus several times, or try the following techniques.

- 1 Switch to  (auto) mode (38) and select **Touch AF/AE** for the touch shooting setting.

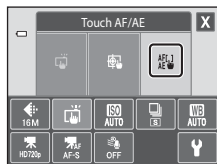

- 2 Tap another subject that is as far from the camera as the desired subject.

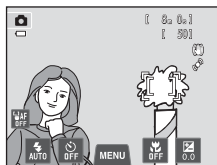

- 3 Press the shutter-release button halfway.

- The camera focuses on the subject and the focus area glows green.
- Exposure is locked for the subject on which focus is acquired when the shutter-release button is pressed halfway.

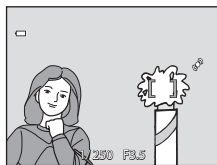

- 4 Continue holding down the shutter-release button halfway and recompose the image.

- Be sure to maintain the same distance between the camera and the subject while the shutter-release button is pressed halfway.

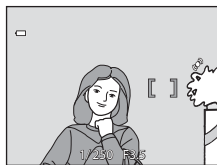

- 5 Press the shutter-release button the rest of the way down to take the picture.



Scene Mode (Shooting Suited to Scenes)

When one of the following scenes is selected, camera settings are automatically optimized for the selected scene.

On the shooting screen → (shooting mode) button → Scene → select a scene (📖26–27)

Scene auto selector (📖43)	Portrait (📖43)	Landscape (📖43)	Sports (📖44)
Night portrait (📖44)	Party/indoor (📖44)	Beach (📖45)	Snow (📖45)
Sunset (📖45)	Dusk/dawn (📖45)	Night landscape (📖46)	Close-up (📖46)
Food (📖46)	Museum (📖47)	Fireworks show (📖47)	Black and white copy (📖47)
Draw (📖47)	Backlighting (📖48)	Panorama assist (📖48)	Pet portrait (📖49)

Displaying a Description of Each Scene Mode (Help Display)

When is tapped in the scene selection screen, the help selection screen is displayed. Tap a scene icon to display a description of the features of that mode. Tap to return to the help selection screen.



Changing the Scene Mode Settings

- You can change the settings for the flash mode, self-timer, macro mode, and exposure compensation for some scenes. See “Default Settings” (📖62) for more information.
- If you tap the **MENU** tab (📖11), the available menu options are displayed. You can set the **Image mode** (📖64) and **Touch shooting** (📖39) settings in scene mode (the settings cannot be changed in some scenes).
 - If you change the **Image mode** setting, the new setting is applied to all shooting modes.
 - **Touch shutter** (default setting) or **Touch AF/AE** can be selected for **Touch shooting**.







Adjusting Scene Effect

The scene effect adjustment slider is displayed by tapping  in the scene modes listed below.

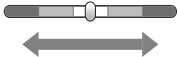
- Tap or drag the scene effect adjustment slider to adjust the degree of effect to be applied to pictures taken in the selected scene mode.
- After you finish making the adjustment, tap  to hide the scene effect adjustment slider.

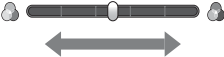







Scene effect adjustment slider

 Food	 <p>More blue More red</p>
 Landscape,  Close-up	 <p>Less vivid More vivid</p>
 Sunset,  Dusk/dawn	 <p>More blue More red</p>

Scene Mode (Shooting Suited to Scenes)

Scene auto selector

The camera simplifies shooting by automatically selecting the optimum scene mode as shown below when the shot is framed.

: Portrait, : Landscape, : Night portrait, : Night landscape, : Close-up, : Backlighting, : Other scenes

- When the camera automatically selects a scene mode, the shooting mode icon displayed in the shooting screen changes to that for the scene mode currently enabled.
- The area of the frame that the camera focuses on (AF area) depends on the composition of the image. When the camera detects a human face, it focuses on that face. See “Face Detection” (📖68) for more information.
- Depending upon shooting conditions, the camera may not select the desired scene mode. Should this occur, switch to  (auto) mode (📖38) or select the desired scene mode manually.
- Digital zoom is not available.

Portrait

Use this mode for portraits.

- The camera detects a human face and focuses on it (📖68).
- The camera smoothes skin tones by applying the skin softening function (📖70).
- If no faces are detected when the shutter-release button is pressed halfway, the camera focuses on the subject at the center of the frame.
- Digital zoom is not available.



Landscape

Use this mode for vivid landscapes and cityscapes.

- The focus area or focus indicator (📖30) always glows green when the shutter-release button is pressed halfway.
- Use the scene effect adjustment slider (📖42) to adjust image saturation.



Scene Mode (Shooting Suited to Scenes)

Sports

Use this mode when shooting sporting events. The camera captures a series of still images that allow you to clearly see detailed movements in a moving subject.

- The camera focuses at the center of the frame. The area focused can be changed by the touch shutter (📖39) or touch AF/AE (📖39).
- To take pictures continuously, hold down the shutter-release button. Up to 6 images are taken at a rate of about 1.3 frames per second (fps) when image mode is set to **16M 4608x3456**.
- The camera continuously adjusts focus even when the shutter-release button is not pressed halfway. You may hear the sound of the camera focusing.
- Focus, exposure, and hue are fixed at the values determined with the first image in each series.
- The maximum frame rate with continuous shooting may vary depending upon the current image mode setting, the memory card used, or shooting condition.
- Continuous shooting is disabled and only one picture can be taken at a time when the shutter is released using the **Touch shutter** function (📖39).



Night portrait



Use this mode for portraits taken at sunset or at night.

- The camera detects a human face and focuses on it (📖68).
- The camera smoothes skin tones by applying the skin softening function (📖70).
- If no faces are detected when the shutter-release button is pressed halfway, the camera focuses on the subject at the center of the frame.
- Digital zoom is not available.



Party/indoor

Captures the effects of candlelight and other indoor background lighting.

- The camera focuses at the center of the frame. The area focused can be changed by the touch shutter (📖39) or touch AF/AE (📖39).
- Hold the camera steady when shooting in dark conditions. Set **Vibration reduction** (📖89) to **Off** when using a tripod to stabilize the camera.



Use of a tripod is recommended in scene modes indicated with . Set **Vibration reduction** to **Off** in the setup menu (📖88) when using a tripod to stabilize the camera during shooting.

 Beach

Captures the brightness of such subjects as beaches or sunlit expanses of water.

- The camera focuses at the center of the frame. The area focused can be changed by the touch shutter (📖39) or touch AF/AE (📖39).

 Snow

Captures the brightness of such subjects as snowfield.

- The camera focuses at the center of the frame. The area focused can be changed by the touch shutter (📖39) or touch AF/AE (📖39).

 Sunset

Preserves the deep hues seen in sunsets and sunrises.

- The camera focuses at the center of the frame.
- Use the scene effect adjustment slider (📖42) to adjust image color.

 Dusk/dawn

Preserves the colors seen in the weak natural light before sunrise or after sunset.

- The focus area or focus indicator (📖30) always glows green when the shutter-release button is pressed halfway.
- Use the scene effect adjustment slider (📖42) to adjust image color.



Scene Mode (Shooting Suited to Scenes)

Night landscape







Slow shutter speeds are used to produce stunning night landscapes.

- The focus area or focus indicator () always glows green when the shutter-release button is pressed halfway.



Close-up





Photograph flowers, insects and other small objects at close range.

- Macro mode () is enabled and the camera automatically zooms to the closest position at which it can focus.
- The camera focuses at the center of the frame. The area focused can be changed by the touch shutter () or touch AF/AE ().
- Use the scene effect adjustment slider () to adjust image saturation.
- The camera continuously adjusts focus even when the shutter-release button is not held down halfway. You may hear the sound of the camera focusing.





Food

Use when taking pictures of food.



- Macro mode () is enabled and the camera automatically zooms to the closest position at which it can focus.
- The camera focuses at the center of the frame. The area focused can be changed by the touch shutter () or touch AF/AE ().
- Use the scene effect adjustment slider () to adjust the subject's hue affected by the lighting. This adjustment is stored in the camera's memory even after the camera is turned off.
- The camera continuously adjusts focus even when the shutter-release button is not held down halfway. You may hear the sound of the camera focusing.



Use of a tripod is recommended in scene modes indicated with . Set **Vibration reduction** to **Off** in the setup menu () when using a tripod to stabilize the camera during shooting.

Museum

Use indoors where flash photography is prohibited (for example, in museums and art galleries) or in other settings in which you do not want to use the flash.

- The camera focuses at the center of the frame. The area focused can be changed by the touch shutter () or touch AF/AE (.
- The camera captures a series of up to 10 images while the shutter-release button is held all the way down, and the sharpest image in the series is automatically selected and saved (BSS (Best Shot Selector)).
- BSS (Best Shot Selector) is disabled with touch shutter shooting (.



Fireworks show



Slow shutter speeds are used to capture the expanding burst of light from a firework.

- Camera focuses at infinity.
- The focus indicator () always glows green when the shutter-release button is pressed halfway.



Black and white copy

Provides clear images of text or drawings on a whiteboard or in print.

- The camera focuses at the center of the frame. The area focused can be changed by the touch shutter () or touch AF/AE (.
- Use with macro mode () when shooting a subject at close distance.

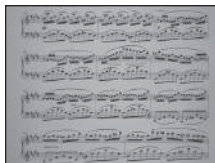



Draw

Write a memo or draw an image on the touch panel display and save it as an image. The image is saved at an image mode setting of  **640x480**. See “Using the Draw Option” () for more information.

Backlighting

Use when light is coming from behind the subject, throwing features or details into shadow. The flash fires automatically to “fill in” (illuminate) shadows.







- The camera focuses at the center of the frame. The area focused can be changed by the touch shutter () or touch AF/AE ().



Panorama assist









Takes a series of pictures that you can join together into a panorama on a computer (.

- Tap , , , or  to select the direction in which images will be joined in the completed panorama.
- After taking the first picture using the shutter-release button or touch shutter, take the necessary shots while checking how each picture will connect to the next. To finish shooting, tap .
- Transfer the images to a computer and use Panorama Maker 6 (, ) to join them into a single panorama.

Pet portrait

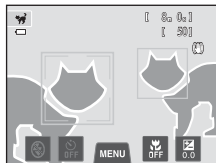

Use this mode for taking portraits of pets (dogs or cats). When the camera detects the face of a dog or cat, it focuses on the face and automatically releases the shutter (pet portrait auto release) 3 times at the default setting.

- A double border (focus area) is displayed around the detected face, and it turns green when the focus is acquired.
 - Up to five faces can be detected. When the camera detects more than one face, the double border is displayed around the largest face, and single borders are displayed around the others.
 - If the shutter-release button is pressed when no pet faces are detected, the camera focuses on the subject at the center of the frame.
 - To change the  **Continuous** setting used in this mode, tap the **MENU** tab to display the menu options.
 - **Single**: The camera takes one picture at a time.
 - **Continuous** (default setting): When the pet portrait auto release function is activated and the focus is acquired on the detected face, the camera releases the shutter 3 times (continuous shooting speed rate: about 1.2 frames per second when the image mode setting is  **4608x3456**). When the pet portrait auto release function is disabled, up to 6 pictures can be continuously taken at a rate of about 1.3 frames per second while the shutter-release button is held down (when the image mode setting is  **4608x3456**).
 - To change the  **Pet portrait auto release** setting, tap the **MENU** tab to display the menu options.
 - **On** (default setting): The shutter is automatically released when the focus is acquired on the detected face.
 - **Off**: The shutter is released using the shutter-release button or touch shutter ( 39).
 - Digital zoom is not available.
 - Factors such as the distance between the pet and the camera, the orientation or brightness of the face, and the speed at which the pet is moving may prevent the camera from detecting the faces of dogs or cats or may cause it to detect faces other than those of dogs or cats.
 - Pet portrait auto release turns off automatically when:
 - Five bursts have been taken.
 - Internal memory or the memory card is full.
- To continue taking pictures with **Pet portrait auto release**, select the **MENU** tab and change the  **Pet portrait auto release** setting to **On** again.





Special Effects Mode (Applying Effects When Shooting)

Effects can be applied to images during shooting.

On the shooting screen →  (shooting mode) button →  Special effects → select an effect (📖26–27)

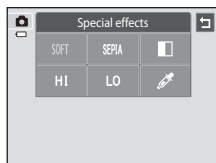
The following six effects are available.



Category	Description
SOFT Soft	Softens the image by adding a slight blur to the entire image.
SEPIA Nostalgic sepia	Adds a sepia tone and reduces the contrast to simulate the qualities of an old photograph.
 High-contrast monochrome	Changes the image to black and white and gives it sharp contrast.
HI High key	Gives the entire image a bright tone.
LO Low key	Gives the entire image a dark tone.
 Selective color	Creates a black and white image in which only the specified color remains.

- When **Selective color** is selected, tap or drag the slider to select the color to keep.
- After you select the desired color, tap **X** to hide the slider. To return to the color selection screen, tap **+**.





Changing Special Effects Mode Settings

- You can change the settings for the flash mode, self-timer, macro mode, and exposure compensation. See “Basic Shooting Settings” (📖54) for more information.
- Tap the **MENU** tab (📖11) to display the available menu options. You can set the **Image mode** (📖64) and **Touch shooting** (📖39) settings in special effects mode.
 - If you change the **Image mode** setting, the new setting is applied to all shooting modes.
 - **Touch shutter** (default setting) or **Touch AF/AE** can be selected for **Touch shooting**.

Smart Portrait Mode (Capturing Images of Smiling Faces)

When the camera detects a smiling face, you can take a picture automatically without pressing the shutter-release button (smile timer). You can use the skin softening option to smooth the skin tones of human faces.

On the shooting screen →  (shooting mode) button →  Smart portrait (26–27)

1 Frame a picture and wait for the subject to smile without pressing the shutter-release button.

- When the camera detects a human face, a yellow double border (focus area) is displayed around that face. When focus is acquired on that face, the double border will turn green for a moment and focus is locked.
- Up to three faces can be detected. When the camera detects more than one face, the double border is displayed around the face closest to the center of the frame, and single borders around the others. Tap the face framed by a single border to change the focus area to that face.
- If the camera detects that the face framed by the double border is smiling, **Smile timer** (53) is activated and the shutter is automatically released.
- Each time the shutter is released, the camera again initiates face detection and smile detection operations for continuous automatic shooting.



2 End shooting.

- Any one of the following operations can be used to cancel smile detection and stop shooting.
 - Turn the camera off.
 - Set **Smile timer** to **Off**.
 - Press the  button and select other shooting mode.

Notes About Smart Portrait Mode

- Digital zoom is not available.
- Under some shooting conditions, the camera may be unable to detect faces or smiles.
- See “Notes About the Face Detection Function” (📖69) for more information.

Auto Off in Smile Timer Mode

When **Smile timer** is set to **On**, the auto off function (📖89) is activated and the camera turns off when either of the situations indicated below persists and no other operations are performed.

- The camera does not detect any faces.
- The camera detected a face, but cannot detect a smile.

Self-timer Lamp

The self-timer lamp flashes slowly when the smile timer is enabled and the camera detects a face, and it flashes quickly immediately after the shutter is released.

Releasing the Shutter Manually

The shutter can also be released by pressing the shutter-release button. If no faces are detected, the camera focuses on the subject at the center of the frame.

Changing the Smart Portrait Mode Settings

- You can change the settings for the flash mode, self-timer, and exposure compensation. See “Basic Shooting Settings” (📖54) for more information.
- If you tap the **MENU** tab (📖11), the menu options available in smart portrait mode are displayed. See “Smart Portrait Menu Options” (📖53) for more information.

Smart Portrait Menu Options

In smart portrait mode, the following options can be changed.

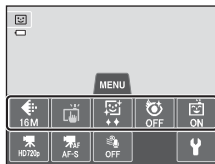

On the smart portrait mode shooting screen → Tap the **MENU** tab (📖11)

Option	Description	
🔙 Image mode	Allows you to select the combination of image size and image quality used when saving images (📖64). The default setting is 16M 4608x3456 . This setting is applied to other shooting modes.	64
📷/AE-L/AF-L Touch shooting	Choose from Touch shutter (default setting), which allows you to release the shutter by tapping the monitor, or Touch AF/AE , which allows you to set the focus area by tapping the monitor.	📷35
👤 Skin softening	Allows you to set the skin softening effect. The camera softens facial skin tones by applying the skin softening function before saving images. You can select the amount of effect that is applied. The default setting is Normal .	📷47
👁 Blink proof	When On is selected, the camera automatically releases the shutter twice each time a picture is taken. Of the two shots, one in which the subject's eyes are open is saved. Flash cannot be used when On is selected. The default setting is Off .	📷48
🕒 Smile timer	When On (default setting) is selected, the camera uses face detection to detect a human face, and then automatically releases the shutter whenever a smile is detected. The self-timer cannot be used with this feature.	📷48

🔑 Functions That Cannot Be Used Simultaneously

There are functions with which these settings cannot be enabled (📖66).

Basic Shooting Settings

When in shooting mode, you can set the following functions by tapping the icons at the bottom of the monitor:

- 1 Flash mode
 - 2 Self-timer
 - 3 Macro mode
 - 4 Exposure compensation
- When the icons are hidden, tap **DISP.**

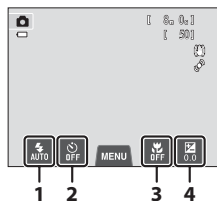

Functions Available for Each Shooting Mode

The functions that can be set vary depending on the shooting mode, as shown below.

- See “Default Settings” (📖62) for more information on the default settings in each shooting mode.

Functions				
Flash mode (📖55)	✓	1	✓	✓ ²
Self-timer (📖57)	✓		✓	✓ ²
Macro mode (📖59)	✓		✓	—
Exposure compensation (📖61)	✓		✓	✓

¹ Varies by the scene. See “Default Settings” (📖62) for more information.

² Varies by the smart portrait menu settings. See “Default Settings” (📖62) for more information.

Functions That Cannot Be Used Simultaneously

Using the Flash (Flash Modes)

Flash mode can be selected to suit the shooting conditions.

1 Tap the flash mode icon.



2 Tap the desired flash mode icon.

- See “Available Flash Modes” (📖56) for more information.
- Tap the flash mode setting icon to return to the previous screen.
- If you tap any other icon, the setting screen for that item is displayed.

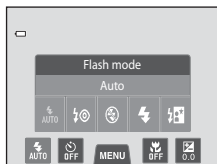

3 Frame the subject and take a picture.

- The flash lamp indicates flash status when the shutter-release button is pressed halfway.
 - On: The flash will fire when you press the shutter-release button all the way down.
 - Flashing: The flash is charging. The camera cannot take pictures.
 - Off: The flash will not fire when a picture is taken.
- If the battery is low, the monitor will be turned off while the flash is charging.

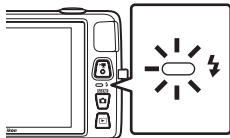

Effective Range of the Flash

When ISO sensitivity is set to **Auto**, the flash has a range of 0.5–4.5 m (1 ft 8 in.–14 ft) at the maximum wide-angle zoom position and a range of 0.5–2.4 m (1 ft 8 in.–7 ft 10 in.) at the maximum telephoto zoom position.

Available Flash Modes



Auto

Flash fires automatically when lighting is poor.



Auto with red-eye reduction

Suited to images of people. This option reduces the “red-eye” phenomenon that caused by the use of flash.



Off

Flash will not fire even when lighting is dim.

- We recommend using a tripod to stabilize the camera when shooting in dim lighting.



Fill flash

Flash fires whenever an image is taken. Use to “fill-in” (illuminate) shadows and backlit subjects.



Slow sync

Auto flash mode is combined with slow shutter speed.

Suited to evening and night portraits that include background scenery.

Flash illuminates main subject; slow shutter speeds are used to capture background at night or under dim lighting.



The Flash Mode Setting

- The flash mode setting varies with shooting mode.
 - See “Default Settings” (📖62) for more information.
 - See “Functions Available for Each Shooting Mode” (📖54) for more information.
- There are functions with which this setting cannot be enabled (📖66).
- The flash mode setting applied in 📷 (auto) mode is stored in the camera’s memory even after the camera is turned off.



Red-eye Reduction

This camera uses advanced red-eye reduction (“In-Camera Red-Eye Fix”).

If the camera detects red-eye when an image is taken, the affected area is processed to reduce red-eye before the image is saved.

Note the following when shooting:

- More time than usual is required to save images.
- Red-eye reduction may not produce the desired results in some situations.
- In extremely rare instances, areas not subject to red-eye may be affected by red-eye reduction processing; in these cases, choose another flash mode and try again.

Using the Self-timer

The camera is equipped with a self-timer that releases the shutter ten seconds or two seconds after you press the shutter-release button. The self-timer is useful when you want to be in the picture you are taking, and when you want to avoid the effects of camera shake that occur when you press the shutter-release button. When using the self-timer, use of a tripod is recommended. Set **Vibration reduction** to **Off** in the setup menu (📖88) when using a tripod to stabilize the camera during shooting.

1 Tap the self-timer icon.



2 Tap 10s or 2s.

- **10s** (ten seconds): Use on important occasions, such as weddings
- **2s** (two seconds): Use to prevent camera shake
- The mode selected for self-timer is displayed.
- Tap the self-timer setting icon to return to the previous screen.
- If you tap any other icon, the setting screen for that item is displayed.



3 Frame the picture and press the shutter-release button halfway.

- Focus and exposure will be set.



4 Press the shutter-release button the rest of the way down.

- The self-timer starts, and the number of seconds remaining before the shutter is released is displayed in the monitor. The self-timer lamp flashes while the timer is counting down. About one second before the shutter is released, the lamp stops flashing and glows steadily.
- When the shutter is released, the self-timer will be set to **OFF**.
- To stop the timer before an image is taken, press the shutter-release button again.



Note About Self-timer

There are functions with which this setting cannot be enabled (66).

Using Macro Mode

When using macro mode, the camera can focus on objects as close as approximately 5 cm (2.0 in.) from the front of the lens. This feature is useful when taking close-up images of flowers and other small subjects.

1 Tap the macro mode icon.



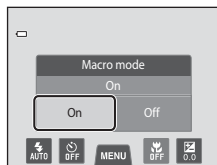

2 Tap ON.

- Tap the macro mode setting icon to return to the previous screen.
- If you tap any other icon, the setting screen for that item is displayed.



3 Use the zoom control to set the zoom ratio to a position where and the zoom indicator glow green.

- How close you can be to the subject when shooting depends on the zoom ratio. When the zoom ratio is set to a position where  and the zoom indicator glow green, the camera can focus on subjects as close as approximately 10 cm (4.0 in.) from the lens. The camera can focus on subjects as close as approximately 5 cm (2.0 in.) from the lens when the zoom is at the maximum wide-angle position (at the position where  is displayed).

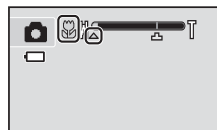

Note About Using the Flash

The flash may be unable to light the entire subject at distances of less than 50 cm (1 ft 8 in.).

Autofocus

When taking still pictures in macro mode, the camera continuously adjusts the focus until the shutter-release button is pressed halfway to lock the focus. Therefore, the sound of lens focus motor can be heard.

The Macro Mode Setting

- Macro mode cannot be used depending on the shooting mode. See "Default Settings" (📖62) for more information.
- There are functions with which this setting cannot be enabled (📖66).
- The macro mode setting applied in  (auto) mode is stored in the camera's memory even after the camera is turned off.

Adjusting Brightness (Exposure Compensation)

Exposure compensation is used to alter exposure from the value suggested by the camera to make images brighter or darker.

1 Tap the exposure compensation icon.



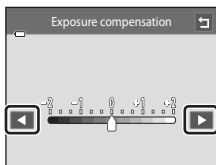

2 Tap or to change the exposure compensation value.

- To make the image brighter, apply positive (+) exposure compensation.
- To make the image darker, apply negative (-) exposure compensation.
- You can also drag the slider to change the value.
- If no operations are performed for a few seconds, the monitor display returns to the shooting screen.



3 Press the shutter-release button to take a picture.

- To exit the setting screen without taking a picture, tap .
- To cancel the exposure compensation, return to step 1, revert the value to 0, and tap .

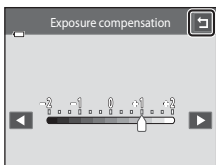











Exposure Compensation Value

The exposure compensation value applied in  (auto) mode is stored in the camera's memory even after the camera is turned off.

Default Settings

The default settings for each function in each shooting mode are described below.

- See the next page for information about the default settings in the scene modes.

	Flash mode ( 55)	Self-timer ( 57)	Macro mode ( 59)	Exposure compensation ( 61)
 (auto)	 AUTO	Off	Off	0.0
 (Special effects)	 AUTO	Off	Off	0.0
 (Smart portrait)	 AUTO ¹	Off ²	Off ³	0.0







































¹ The function cannot be used when **Blink proof** is set to **On**.

² The function can be used when **Smile timer** is set to **Off**.

³ The setting cannot be changed.

- The setting applied in  (auto) mode is saved in the camera's memory even after the camera is turned off (except the self-timer setting).

The default settings for each function in scene mode are described below.

	Flash mode (43)	Self-timer (57)	Macro mode (59)	Exposure compensation (61)
 (43)	 ¹ AUTO	Off	- ³	0
 (43)		Off	Off ²	0
 (43)		Off	Off ²	0
 (44)		Off ²	Off ²	0
 (44)		Off	Off ²	0
 (44)		Off	Off ²	0
 (45)	 ¹ AUTO	Off	Off ²	0
 (45)	 ¹ AUTO	Off	Off ²	0
 (45)		Off	Off ²	0
 (45)		Off	Off ²	0
 (46)		Off	Off ²	0
 (46)		Off	On ²	0
 (46)		Off	On ²	0
 (47)		Off	Off	0
 (47)		Off ²	Off ²	0 ²
 (47)		Off	Off	0
 (47)	-	-	-	-
 (48)		Off	Off ²	0
 (48)		Off	Off	0
 (49)		- ⁶	Off	0

¹ The camera automatically selects the optimum flash mode for the scene mode it has selected ([43](#)).  (**Off**) can be selected manually.

² The setting cannot be changed.

³ When the camera selects close-up scene mode in scene auto selector scene mode, macro mode ([59](#)) is enabled.

⁴ The flash mode setting is fixed at fill flash with slow sync with red-eye reduction.

⁵ The setting may change to slow sync with red-eye reduction.

⁶ Self-timer is disabled. **Pet portrait auto release** shutter can be enabled or disabled ([49](#)).

Functions That Cannot Be Used Simultaneously

There are functions with which these settings cannot be enabled ([66](#)).











◀ Changing the Image Size (Image Mode)

- You can use the **Image mode** setting in the shooting menu to select the combination of image size and compression ratio that is used when saving images.

On the shooting screen → Tap the MENU tab → ◀ Image mode

Set the image mode best suited to the manner in which images will be used and the capacity of the internal memory or memory card. The higher the image mode setting, the larger the size at which it can be printed, but limiting the number of images that can be recorded.



Image Mode Settings (Image Size and Quality)

Image mode*	Description
 4608×3456 ★	Higher quality than  , suitable for enlargements or high-quality prints. The compression ratio is approximately 1:4.
 4608×3456 (default setting)	Best choice in most situations. The compression ratio is approximately 1:8.
 3264×2448	
 2272×1704	
 1600×1200	Smaller size than  ,  , or  allows more images to be stored. The compression ratio is approximately 1:8.
 640×480	Suited to full-screen display on a television with an aspect ratio of 4:3, or distribution by e-mail. The compression ratio is approximately 1:8.
 4608×2592	Images with an aspect ratio of 16:9 are recorded. The compression ratio is approximately 1:8.

* The total number of pixels recorded, and the number of pixels recorded horizontally and vertically.







Example:  **4608×3456** = Approx. 16 megapixels, 4608 × 3456 pixels

Image Mode

- The setting can also be changed in shooting modes other than  (auto) mode by tapping the **MENU** tab to display the menu options and then tapping the .
- Changes made to the image mode setting are applied to all shooting modes.
- There are functions with which this setting cannot be enabled (66).

Number of Exposures Remaining

The following table lists the approximate number of images that can be stored in internal memory and on a 4 GB memory card. Note that the number of images that can be stored will differ depending on the composition of the image (due to JPEG compression). In addition, this number may vary depending on the make of memory card, even when the memory cards have the same specified capacity.

Image mode	Internal memory ¹ (approx. 74 MB)	Memory card ^{1,2} (4 GB)	Print size ³ (cm/in.)
 4608×3456 ★	7	490	Approx. 39 × 29/15 × 11.5
 4608×3456	14	950	Approx. 39 × 29/15 × 11.5
 3264×2448	29	1980	Approx. 28 × 21/11 × 8
 2272×1704	63	3750	Approx. 19 × 14/7.5 × 5.6
 1600×1200	138	7550	Approx. 13 × 10/5.3 × 4
 640×480	447	24000	Approx. 5 × 4/2 × 1.5
 4608×2592	19	1200	Approx. 39 × 22/15 × 8.5

¹ The number of exposures remaining is displayed on the shooting screen when 50 or fewer remain (22).



² If there are 10,000 or more pictures saved in the camera, “9999” is displayed on the playback screen as the current frame number or total number of frames.

³ Print size at an output resolution of 300 dpi. Print sizes are calculated by dividing the number of pixels by printer resolution (dpi) and multiplying by 2.54 cm (1 in.). However, at the same image size, images printed at higher resolutions will print smaller than the size indicated, and those printed at lower resolutions will print larger than the size indicated.

Functions that Cannot Be Applied Simultaneously

Some shooting settings cannot be used with other functions.

Restricted function	Option	Description
Flash mode	Continuous (📖39)	When Continuous , BSS , or Multi-shot 16 is selected, flash is disabled.
	Blink proof (📖53)	When On is selected, flash is disabled.
Self-timer	Subject tracking (📖39)	When the touch shooting is set to Subject tracking , self-timer is disabled.
Macro mode	Subject tracking (📖39)	When the touch shooting is set to Subject tracking , macro mode is disabled.
Image mode	Continuous (📖39)	When Multi-shot 16 is selected, the Image mode setting is fixed at 5 (image size: 2560 × 1920 pixels).
	ISO sensitivity (📖39)	When the ISO sensitivity setting is 3200 , the available Image mode settings are limited to 4 , 2272×1704 , 2 , 1600×1200 , and 1 , 640×480 . If an image size other than these is set before changing the ISO sensitivity to 3200 , it automatically changes to 4 , 2272×1704 .
ISO sensitivity	Continuous (📖39)	When Multi-shot 16 is selected, the ISO sensitivity setting is automatically specified according to the brightness.
Continuous	Self-timer (📖57)	When taking a picture using the self-timer, the continuous setting is fixed to Single .
	Touch shutter (📖39)	When using the touch shutter function, one image is taken each time the monitor is tapped.
Motion detection	Subject tracking (📖39)	When taking a picture using the subject tracking function, Motion detection is disabled.
	Continuous (📖39)	When Multi-shot 16 is selected, Motion detection is not enabled.
	ISO sensitivity (📖39)	When a setting other than Auto is selected for ISO sensitivity , Motion detection is disabled.
Blink warning	Continuous (📖39)	When Continuous , BSS , or Multi-shot 16 is selected, Blink warning is disabled.

Restricted function	Option	Description
Digital zoom	Continuous  39	When Multi-shot 16 is selected, digital zoom is not available.
	Subject tracking  39	When the touch shooting is set to Subject tracking , digital zoom is disabled.

Notes About Digital Zoom

- Digital zoom cannot be used depending on the shooting mode (73).
- The camera focuses on the subject at the center of the frame when digital zoom is in effect.

Face Detection

In the following shooting modes, the camera uses face detection to automatically focus on human faces. If the camera detects more than one face, a double border is displayed around the face that the camera will focus on, and single borders are displayed around the other faces.

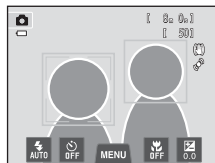

Shooting mode	Number of faces that can be detected	Focus area (double border)
(auto) mode (📖38)	Up to 12	The face closest to the camera
Scene auto selector, Portrait, Night portrait scene mode (📖41)		
Smart portrait mode (📖51)	Up to 3	The face closest to the center of the frame

- In (auto) mode, if no faces are detected when the shutter-release button is pressed halfway, the camera automatically selects one (or more) of the nine focus areas containing the subject closest to the camera.
- In **Scene auto selector** scene mode, the focus area changes depending on the selected scene.
- In **Portrait** and **Night portrait** scene modes or smart portrait mode, if no faces are detected when the shutter-release button is pressed halfway, the camera will focus on the subject at the center of the frame.
- Tap a face framed by a single border to change the focus area to that face (📖39).
- In subject tracking mode, subject tracking begins when a detected face framed by a border is tapped (📖39).

✔ Notes About the Face Detection Function

- The camera may be unable to detect faces in the following situations:
 - When faces are partially hidden by sunglasses or other obstructions
 - When faces take up too much or too little of the frame
- When the frame includes more than one face, the faces detected by the camera and the face on which the camera focuses depend upon a variety of factors, including the direction in which the faces are looking.
- In some rare cases, such as those described in “Subjects Not Suitable for Autofocus” (📖31), the subject may not be in focus even though the double border turns green. Should this occur, refocus on another subject positioned at the same distance from the camera as the actual portrait subject (📖40).

📎 Notes About Images Including Detected Faces

- When images in which a face was detected during shooting are played back, the images will be automatically rotated for playback display according to the orientation of the face detected, except pictures that were taken using **Continuous, BSS, Multi-shot 16** (📖39), or the subject tracking function (📖39).
- In full-frame playback mode, the image is enlarged with the detected face at the center of the screen when the zoom control is rotated to **T** (📖) or when the detected face is double-tapped (📖33), except pictures that were taken using **Continuous, BSS, Multi-shot 16** (📖39), or the subject tracking function (📖39).

Skin Softening

If you are using one of the shooting modes listed below when the shutter is released, the camera detects one or more human faces (up to three), and processes the image to soften facial skin tones before saving the image.

- **Scene auto selector** (📖43), **Portrait** (📖43) or **Night portrait** (📖44) scene mode
- Smart portrait mode
- Editing functions such as **Skin softening** can be applied to saved images by using **Glamour retouch** (📖75).

✔ Notes About Skin Softening

- More time than usual may be required to save an image when shooting with skin softening function.
- In some shooting conditions, facial skin tones may not be softened or parts other than face may be modified though the camera detects a face. If the desired results are not produced, set **Skin softening** to **Off** and shoot again.
- The skin softening level cannot be adjusted when **Portrait** or **Night portrait** is selected in the scene mode (including 📖 Scene auto selector scene mode).

Playback Features



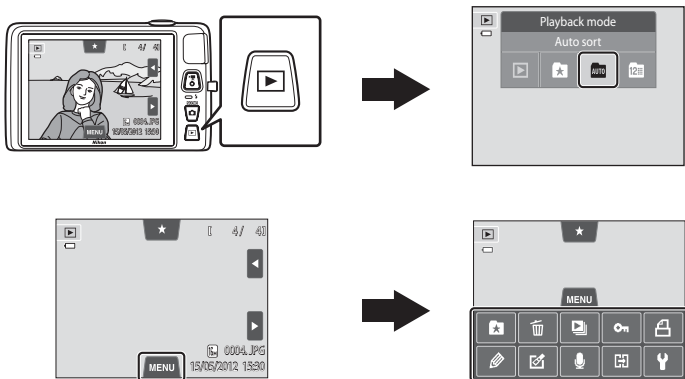





This chapter describes how to select certain types of images for playback as well as some of the features available when playing back images.



Selecting Certain Types of Images for Playback

You can change the playback mode according to the type of images you want to view.

Available Playback Modes

	Play	 32
All images are played back. When you switch from shooting mode to playback mode, this mode is selected.		
	Favorite pictures	 5
Only images added to albums are played back. Images should be added to albums before selecting this mode ( 75).		
	Auto sort	 9
Images are automatically sorted into categories, such as portraits, landscapes, and movies. You can play back images in a specific category only.		
	List by date	 11
Only images captured on the same date are played back.		



Switching Between Playback Modes

1 Press the button in playback mode.

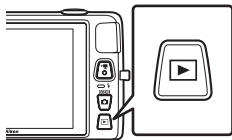
- The screen used to select a playback mode (the playback mode selection menu) is displayed.







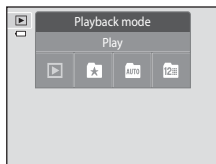

2 Tap the desired playback mode icon.

- If you select  (playback), the playback screen is displayed.
- When an option other than  (playback) is selected, the album, category or shooting date selection screen is displayed.
- To return to the current playback mode, press the  button.



3 Tap an album, category or shooting date.

- For  Favorite Pictures Mode, see 5
- For  Auto Sort Mode, see 9
- For  List by Date Mode, see 11
- Repeat the procedure from step 1 to select an album, category or shooting date again.

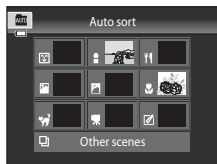

Auto sort mode

Setting the Picture Rating

If images have been assigned a rating of one to five, they can be played back in groups defined by rating.

- To set a rating, tap the rating tab in full-frame playback or thumbnail playback (📖 33) mode and drag and drop the desired rating icon onto an image.
- Drag and drop another icon to change the rating.
- Drag and drop ★0 to cancel the rating.
- An image's rating can be confirmed by the number of ☆ shown in full-frame playback mode.
- While setting the ratings, drag the current image to display the previous or next image. It is possible to zoom or switch to thumbnail display by using the zoom control (W 📐)/T (🔍)).

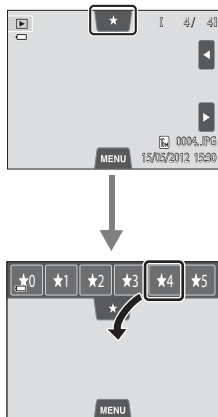

Playing Back images by Rating

Tap the rating tab in full-frame playback or thumbnail playback mode and tap a rating icon to display the images with that rating.

- The icon of the tapped rating turns yellow, and only the images assigned with the selected rating are displayed. Multiple ratings can be selected.
- To stop displaying images of a selected rating, tap the icon of the rating to deselect it.
- To stop playback by rating, deselect all ratings.

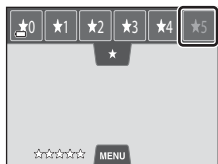

👍 Notes About the Rating

- Each rating can be applied to a maximum of 999 images.
- The ratings applied on the COOLPIX S4300 are not recognized by your computer.

Functions Available in Playback Mode (Playback Menu)

If you tap the **MENU** tab when viewing images in full-frame playback mode or thumbnail playback mode, the following menu options are displayed.

- Tap an icon to display the menu for that option (📖12).



Item	Description	
Favorite pictures	Add images to an album. In favorite pictures mode, remove images from an album.	5
Delete ¹	Delete images or movies.	34
Slide show ¹	Play back images, stored in the internal memory or on a memory card, one by one in an automated slide show.	49
Protect ¹	Protect selected images from accidental deletion.	51
Print order ¹	When using a printer to print images saved on the memory card, you can use the Print order function to select which images are printed, and how many copies of each image are printed.	53
Paint ²	Draw on images or add decorations to images. Painted copies are stored as separate files.	14
Retouch ²	Edit images. Available editing functions are Quick retouch , D-Lighting , Stretch , Perspective control , Filter effects , Glamour retouch , and Small picture .	12
	Rotate image is available to set the orientation of images when they are played back on the camera.	57
Voice memo	Record voice memos using the camera's built-in microphone and attach them to images. Voice memo can also be played back and deleted.	58
Copy ^{1,3}	Allows you to copy images between the internal memory and a memory card.	60

¹ This function can also be performed in thumbnail playback mode. If the camera is switched to thumbnail playback mode while images are played back in favorite pictures, auto sort, or list by date mode, this function can be performed only on the images sorted to the selected folder, category or date.

² The selected image is edited, and the copy is saved with a different file name. Pictures taken, or movies at an image mode setting of **4608x2592** (📖64) cannot be edited. Once an image has been edited, some editing functions may become unavailable (12, 13).

³ This function cannot be selected when using favorite pictures mode, auto sort mode, or list by date mode.

Connecting the Camera to a TV, Computer, or Printer

You can enhance your enjoyment of images and movies by connecting the camera to a TV, computer, or printer.

- Before connecting the camera to an external device, make sure the remaining battery level is sufficient and the camera is turned off. For information about the connection methods and subsequent operations, refer to the documentation included with the device in addition to this document.

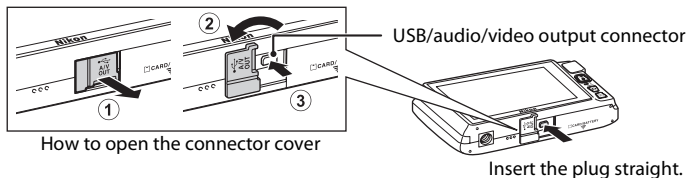

Viewing images on a TV

27



Images and movies captured with the camera can be viewed on a TV. Connection method: Connect the video and audio plugs of the included Audio Video Cable EG-CP14 to the TV's input jacks.

Viewing and organizing images on a computer

77



If you transfer images to a computer, you can perform simple retouching and manage image data in addition to playing back images and movies.

Connection method: Connect the camera to the computer's USB port with the included USB Cable UC-E6.

- Before connecting to a computer, install ViewNX 2 on the computer using the included ViewNX 2 Installer CD-ROM. For information about using the ViewNX 2 Installer CD-ROM and transferring images to a computer, see page 79.
- If any USB devices that draw the power from the computer are connected, disconnect them from the computer before you connect the camera to it. Connecting the camera and other USB-powered devices to the same computer simultaneously may cause a camera malfunction or excessive power supply from the computer, which could damage the camera or memory card.

Printing images without using a computer

29



If you connect the camera to a PictBridge-compatible printer, you can print images without using a computer.

Connection method: Connect the camera directly to the printer's USB port with the included USB Cable UC-E6.

Using ViewNX 2

ViewNX 2 is an all-in-one software package which enables you to transfer, view, edit and share images.

Install ViewNX 2 using the included ViewNX 2 Installer CD-ROM.



Installing ViewNX 2

- An Internet connection is required.

Compatible Operating Systems

Windows

- Windows 7 Home Basic/Home Premium/Professional/Enterprise/Ultimate (Service Pack 1)
- Windows Vista Home Basic/Home Premium/Business/Enterprise/Ultimate (Service Pack 2)
- Windows XP Home Edition/Professional (Service Pack 3)

Macintosh

- Mac OS X (version 10.5.8, 10.6.8, 10.7.2)

Refer to the Nikon website for the latest information on operating system compatibility.

1 Start the computer and insert the ViewNX 2 Installer CD-ROM into the CD-ROM drive.

- Mac OS: When the **ViewNX 2** window is displayed, double-click the **Welcome** icon.

2 Select a language in the language selection dialog to open the installation window.

- If the desired language is not available, click **Region Selection** to choose a different region and then choose the desired language (the **Region Selection** button is not available in the European release).
- Click **Next** to display the installation window.



3 Start the installer.

- We recommend clicking **Installation Guide** in the installation window to check the installation help information and system requirements before installing ViewNX 2.
- Click **Typical Installation (Recommended)** in the installation window.

4 Download the software.

- When the **Software Download** screen is displayed, click **I agree - Begin download**.
- Follow the on-screen instructions to install the software.

5 Exit the installer when the installation completion screen is displayed.

- Windows: Click **Yes**.
- Mac OS: Click **OK**.

The following software is installed:

- ViewNX 2 (consisting of the three modules below)
 - Nikon Transfer 2: For transferring images to the computer
 - ViewNX 2: For viewing, editing, and printing transferred images
 - Nikon Movie Editor: For basic editing of transferred movies
- Panorama Maker 6 (for creating a single panorama photo using a series of images shot in panorama assist scene mode)

6 Remove the ViewNX 2 Installer CD-ROM from the CD-ROM drive.

Transferring Images to the Computer

1 Choose how images will be copied to the computer.

Choose one of the following methods:

- **Direct USB connection:** Turn the camera off and ensure that the memory card is inserted in the camera. Connect the camera to the computer using the supplied USB cable UC-E6. The camera automatically turns on. To transfer images that are saved in the camera's internal memory, remove the memory card from the camera before connecting it to the computer.

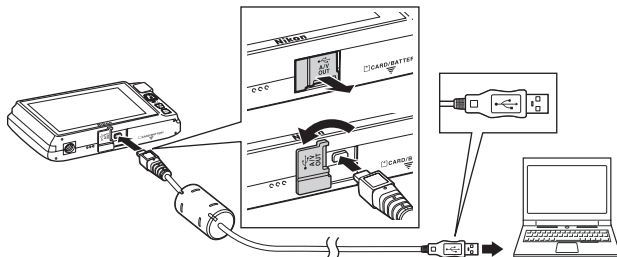

- **SD card slot:** If your computer is equipped with an SD card slot, the card can be inserted directly in the slot.
- **SD card reader:** Connect a card reader (available separately from third-party suppliers) to the computer and insert the memory card.

If a message is displayed prompting you to choose a program, select Nikon Transfer 2.

• When using Windows 7

If the dialog shown at right is displayed, follow the steps below to select Nikon Transfer 2.

- 1 Under **Import pictures and videos**, click **Change program**. A program selection dialog will be displayed; select **Import File using Nikon Transfer 2** and click **OK**.
- 2 Double-click **Import File**.



If the memory card contains a large number of images, it may take a while for Nikon Transfer 2 to start. Wait until Nikon Transfer 2 starts.

✓ Connecting the USB Cable

The connection may not be recognized if the camera is connected to the computer via a USB hub.

2 Transfer images to the computer.

- Confirm that the name of the connected camera or removable disk is displayed as the “Source” on the “Options” title bar of Nikon Transfer 2 (①).
- Click **Start Transfer** (②).

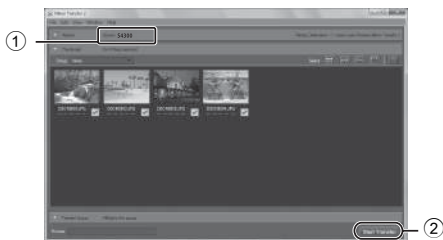

- At default settings, all the images on the memory card will be copied to the computer.

3 Terminate the connection.

- If the camera is connected to the computer, turn the camera off and disconnect the USB cable. If you are using a card reader or card slot, choose the appropriate option in the computer operating system to eject the removable disk corresponding to the memory card and then remove the card from the card reader or card slot.

Viewing Images

Start ViewNX 2.

- Images are displayed in ViewNX 2 when transfer is complete.
- Consult online help for more information on using ViewNX 2.

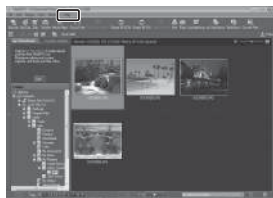

Starting ViewNX 2 Manually

- **Windows:** Double-click the **ViewNX 2** shortcut on the desktop.
- **Mac OS:** Click the **ViewNX 2** icon in the Dock.

Recording and Playing Back Movies

You can record movies by simply pressing the  (movie-record) button.

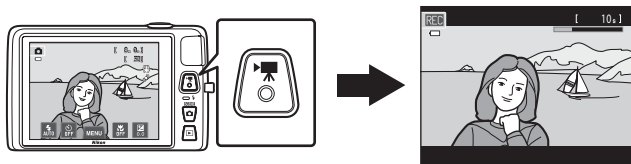

In playback mode, tap  to play a movie.

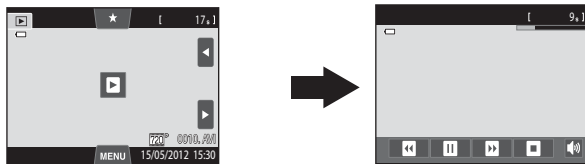

Recording Movies

You can record movies by simply pressing the **●** (▶ movie-record) button. The settings made for still images, such as hue and white balance, are applied when recording movies.

- The maximum file size for a single movie is 2 GB or the maximum movie length for a single movie is 29 minutes, even when there is sufficient free space on the memory card for longer recording (📖84).
- When no memory card is inserted (when recording in the internal memory), **Movie options** (📖85) is set to **VGA (640×480)** by default. **HD 720p (1280×720)** cannot be selected.

1 Turn on the camera and be sure that it is in shooting mode.

- Movies can be recorded in any shooting mode (📖26) except **Draw** scene mode.

* Maximum movie length shown in the illustrations may differ from the actual display.

Maximum Movie Length*



2 Press the **●** (▶ movie-record) button to start movie recording.

- Recording begins after the monitor turns off briefly.
- The camera focuses at the center of the frame. Focus areas are not displayed during recording.
- When **HD 720p (1280×720)** (default setting) is selected for **Movie options** (📖85), monitor display changes to an aspect ratio of 16:9 with movie recording (the area indicated at right is recorded).
- If **Photo info** in the **Monitor settings** (📖88) in the setup menu is set to **Movie frm+auto info**, the area that will be visible in the movie can be confirmed before movie recording starts.
- The approximate remaining movie length is displayed. **11** is displayed while saving to the internal memory.
- Recording stops automatically when the maximum movie recording time has elapsed.

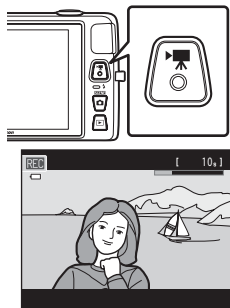

3 Press the **●** (▶ movie-record) button again to end recording.

✔ Note on Recording Images and Saving Movies

The indicator showing the number of exposures remaining or the indicator showing the maximum movie length flashes while images are being recorded or while a movie is being saved. **Do not open the battery-chamber/memory card slot cover or remove the battery or memory card** while an indicator is flashing. Doing this could result in loss of data, or in damage to the camera or the memory card.

✔ Recording Movies

- Memory cards with an SD Speed Class rating of 6 or faster are recommended when recording movies (📖21). Movie recording may stop unexpectedly when memory cards with a lower Speed Class ratings are used.
- When recording movies with **HD 720p (1280×720)** selected for **Movie options**, the angle of view (the area captured in the recorded movie) is smaller than when taking still pictures.
- You cannot change the optical zoom ratio once movie recording has started.
- While recording movies, you can operate the digital zoom by using the zoom control. The digital zoom can magnify the image up to 4x the maximum optical zoom ratio.
- Digital zoom degrades image quality. When recording ends, digital zoom is disabled.
- In some cases, movie recordings may capture the sounds of the camera itself, such as those made by the zoom control, autofocus, vibration reduction, or aperture control when the brightness changes.
- Smear (🌀3) visible in the monitor with movie recording will be recorded with movies. Avoiding bright objects such as the sun, reflections of the sun, and electric lights when recording movies is recommended.
- When recording or playing back movies, colored stripes (interference patterns or moiré) may appear on subjects that have a regular, repeating grid, such as pattern of weave in cloths or windows in a building, depending on the shooting distance or zoom ratio. This phenomenon occurs when the subject's pattern interferes with the camera sensor grid, and it does not indicate a malfunction.

✔ Notes About Autofocus for Movie Recording

- When **AF-S Single AF** (default setting) is selected for **Movie AF mode**, focus is locked by pressing the **● (📹 movie-record)** button to start recording (📖85).
- Autofocus may not perform as expected (📖31). Should this occur, try the following:
 1. Set **Movie AF mode** to **AF-S Single AF** (default setting) before starting movie recording.
 2. Frame a different subject (positioned at the same distance from the camera as the intended subject) in the center of the frame, press the **● (📹 movie-record)** button to start recording, and then modify the composition.

✓ Notes About Camera Temperature

- The camera temperature may increase significantly when used for an extended period of time for movie recording, etc. or when used in places with high ambient temperature.
- If the camera becomes extremely hot while recording a movie, the camera automatically terminates recording after 30 seconds. The camera monitor displays the number of seconds (🕒 30s) remaining until automatic termination is activated. Five seconds after movie recording is terminated, the camera turns off. Wait until the internal temperature decreases before using it again.



📝 Movie Options and Maximum Recording Time

Movie Options	Internal memory (approx. 74 MB)	Memory card ² (4 GB)
📺 HD 720p (1280×720)	– ¹	15 min
📺 VGA (640×480)	44 s	45 min
📺 QVGA (320×240)	2 min 40 s	2 h 45 min

All figures are approximate. The maximum recording time may vary by make of memory card.

¹ 📺 **HD 720p (1280×720)** cannot be selected when recording in the internal memory.

² The maximum file size for a single movie is 2 GB or the maximum recording time for a single movie is 29 minutes, even when there is sufficient free space on the memory card for longer recording. The maximum recording time that can be recorded for a single movie is displayed during recording.

📝 Functions Available with Movie Recording









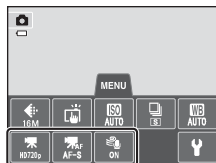

- The current exposure compensation setting, the white balance setting specified for 📷 (auto) mode, the scene effect adjustment slider specified for scene mode setting, and the tone resulting from the special effects mode are also applied with movie recording. When macro mode is enabled, movies of subjects close to the camera can be recorded. Confirm the settings before starting movie recording.
- The self-timer (🕒 57) can be used. When the 📷 (📷 movie-record) button is pressed after the self-timer is enabled, the camera focuses at the center of the frame and starts movie recording after the specified two or ten seconds.
- The flash will not fire.
- To set the movie menu settings, tap the **MENU** tab before starting movie recording (📷 85).

Changing Movie Recording Settings (The Movie Menu)

On the shooting screen → Tap the MENU tab (📖11)

The following menu options can be adjusted.



Option	Description	📖
 Movie options	<p>The following movie types are available:  HD 720p (1280×720) (default setting),  VGA (640×480),  QVGA (320×240). Movies with an aspect ratio of 16:9 can be recorded by selecting  HD 720p (1280×720).</p> <ul style="list-style-type: none"> When recording in the internal memory, the default setting is  VGA (640×480). 	 62
 AF Movie AF mode	<p>Select between AF-S Single AF (default setting), which locks focus when movie recording starts, and AF-F Full-time AF which focuses continuously during movie recording.</p> <p>When AF-F Full-time AF is selected, the sound of the camera focusing may be heard in the recorded movie. If you want to prevent the sound of the camera focusing from being recorded, select AF-S Single AF.</p>	 62
 Wind noise reduction	<p>Set On or Off (default setting) to select whether wind noise is reduced when recording movies.</p>	 63

Movie Playback

Select the desired movie in playback mode (📖32) and tap 🎬.

- Movies can be recognized by 🎬 icon displayed on it.
- The movie is played back.
- To adjust the volume before playback, tap the MENU tab to display the menu options and tap 🔊.



Operations during Movie Playback

Tap the monitor during playback to display the playback control panel at the bottom in the monitor.

Tap a playback control to perform the corresponding operation. The operations described below are available by tapping the icons in the panel.

During playback



To	Use	Description
Adjust volume	🔊	Tap 🔊 to adjust volume.
Rewind	⏮	Tap and hold ⏮ to rewind movie.
Advance	⏭	Tap and hold ⏭ to advance movie.
Pause	⏸	Pause playback. The following operations can be performed while playback is paused.
		⏮ Rewind movie back one frame. Tap and hold ⏮ for continuous frame-by-frame rewind.
		⏭ Advance movie forward one frame. Tap and hold ⏭ for continuous frame-by-frame advance.
	🎬	Tap 🎬 displayed at the center of the screen to resume playback.
End	⏹	End movie playback and return to full-frame playback mode.

✔ Note About Movie Playback

Movies recorded by a camera other than the COOLPIX S4300 cannot be played back.

🔧 Adjusting the Volume

Rotate the zoom control to **T** or **W** (📖2) during playback.

🗑 Deleting Movie Files

See "Step 6 Delete Unwanted Images" (📖34) for more information.

General Camera Setup

This chapter describes the various settings that can be adjusted in the  setup menu.

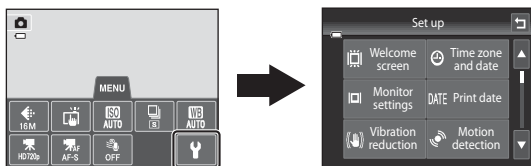

- See “Using Menus (MENU Tab)” (📖11) for information about using the camera’s menus.
- For further details about each setting, refer to “The Setup Menu” (🔧64) in the Reference Section.







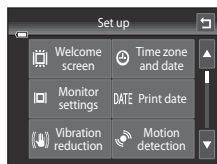











The Setup Menu

Tap the **MENU** tab → Tap the **Y** (setup) tab (📖11)















The following menu options can be changed.



Option	Description	
Welcome screen	Allows you to select the image displayed as the welcome screen when the camera is turned on. Select COOLPIX to display the COOLPIX logo. Select Select an image to use a picture taken with the camera as the welcome screen.	64
Time zone and date	Allows you to set settings related to the camera's date and time. The Time zone setting allows you to specify the time zone where the camera is mainly used and whether or not daylight saving time is in effect. When the travel destination () is selected, the camera automatically calculates the time difference between the travel destination and the home time zone () and saves images using the date and time of the travel destination.	65
Monitor settings	Allows you to select whether or not to display information on the shooting screen and playback screen. If you select Framing grid+auto info , a grid is displayed when shooting to help you frame the shot. The default setting is Auto info . You can also set the image review settings and the monitor brightness.	68
DATE Print date	Allows you to imprint the shooting date and time on images at the time of shooting. The default setting is Off . <ul style="list-style-type: none"> The date cannot be imprinted in the following situations: <ul style="list-style-type: none"> When using Panorama assist scene mode When shooting movies 	70

Option	Description	
 Vibration reduction	Allows you to reduce blurring caused by camera shake when shooting. The default setting is On . <ul style="list-style-type: none"> When using a tripod to stabilize the camera during shooting, set this feature to Off. 	 71
 Motion detection	Enable or disable motion detection, which reduces the effects of subject movement and camera shake in still images. The default setting is Auto .	 72
 AF assist	When set to Auto , the AF-assist illuminator ( 2) lights up when shooting in dark surroundings to help the camera focus. The default setting is Auto . <ul style="list-style-type: none"> The illuminator has a range of about 1.9 m (6 ft 2 in.) at the maximum wide-angle position and about 1.1 m (3 ft 7 in.) at the maximum telephoto position. Even if Auto is selected, the AF-assist illuminator may not light depending on the position of the focus area or the scene mode that is selected. 	 73
 Digital zoom	When set to On , rotating the zoom control to T () at the maximum optical zoom position triggers digital zoom feature ( 29). The default setting is On .	 73
 Sound settings	Allows you to turn various camera sounds on and off. The Button sound and Shutter sound settings are On by default. <ul style="list-style-type: none"> When using certain shooting modes or settings, the operation sound is disabled. 	 74
 Auto off	Allows you to set the amount of time that passes before the monitor turns off to save power. The default setting is 1 min .	 75
 Format memory/Format card	Allows you to format the internal memory (only when a memory card is not inserted) or the memory card (when a memory card is inserted). <ul style="list-style-type: none"> All data stored in the internal memory or on the memory card is deleted during formatting and cannot be restored. Be sure to transfer important images to a computer and save them before formatting. 	 76

The Setup Menu

Option	Description	
 Language	Choose the language used for camera monitor display.	 77
VIDEO Video mode	Adjust video mode settings for connection to a television. Select from NTSC and PAL .	 77
 Charge by computer	When set to Auto (default setting), you can charge the camera's battery by connecting the camera to a computer (provided that the computer is able to supply power). <ul style="list-style-type: none"> When charging by computer, it takes more time to charge the battery than when using the Charging AC Adapter EH-69P. Additionally, when charging by computer and transferring pictures to the computer simultaneously, it takes more time to charge the battery. 	 78
 Blink warning	Immediately after taking a picture using face detection ( 68) (except when using smart portrait mode), if the camera detects a subject with closed eyes, the camera displays the message Did someone blink? , allowing you to check the image. The default setting is Off .	 80
 Eye-Fi upload	Set whether or not to enable the function for sending images to a computer using a commercially available Eye-Fi card. The default setting is Disable .	 82
 Reset all	Allows you to reset the camera's settings to their default values. Certain settings such as Time zone and date and Language are not reset.	 83
Ver Firmware version	View the current camera firmware version.	 85



Reference Section

The Reference Section provides detailed information and hints for using the camera.

Shooting

Using the Draw Option.....	2
Using Panorama Assist	3

Playback

Favorite Pictures Mode.....	5
Auto Sort Mode.....	9
List by Date Mode	11
Editing Images (Still Images)	12
Connecting the Camera to a TV (Playback on a TV).....	27
Connecting the Camera to a Printer (Direct Print)	29

Menu

The Shooting Menu (for (Auto) Mode).....	35
The Smart Portrait Menu	47
The Playback Menu.....	49
The Movie Menu	62
The Setup Menu.....	64

Additional Information

File and Folder Names	86
Optional Accessories	87
Error Messages	88













Using the Draw Option

Write a memo or draw an image on the touch panel display and save it as an image. The image is saved at an image mode setting of **VGA 640×480**.

1 Set the shooting mode to Draw.

- See “Scene Mode (Shooting Suited to Scenes)” (p.41) for information about setting the shooting mode to **Draw**.

2 Write a memo or draw images.

- Tap  (pen) to write text or draw images (p.15).
- Tap  (eraser) to erase text or images (p.15).
- Tap  or rotate the zoom control to **T** () to display the image in full-frame playback mode and tap  or rotate the zoom control to **T** () again to enlarge the image display by 3X. Tap , ,  or  to change the portion of the image visible in the monitor. Tap  or rotate the zoom control to **W** () to return to the original display size.



3 Tap **OK**.

- Tap , before tapping **OK**, to undo the last operation applied using the pen or erase tool (up to the last five operations can be undone).
- If you tap **X**, a confirmation dialog is displayed. Tap **Yes** to quit without saving the drawing.

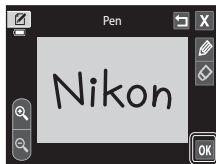

4 Tap **Yes**.

- The memo is saved.

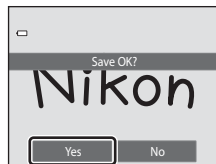

Using Panorama Assist

Use a tripod for the best results. Set **Vibration reduction** (📖89) to **Off** in the setup menu when using a tripod to stabilize the camera during shooting.

1 Set the shooting mode to 📷 **Panorama assist**.

- See “Scene Mode (Shooting Suited to Scenes)” (📖41) for information about setting the shooting mode to **Panorama assist**.
- Panorama direction icons are displayed to show the direction in which images will be joined.

2 Tap a direction icon.

- Select the direction in which images will be joined in the completed panorama: right (▶), left (◀), up (▲) or down (▼).
- A different direction can be selected by tapping a different panorama direction icon.
- Change shooting settings (📖41) before the first image is taken in the next step.



3 Frame the first portion of the panorama scene and take the first picture.

- The camera focuses on the subject at the center of the frame.
- One third of the image will be displayed as translucent.



4 Take the next picture.

- Frame the next image so that one-third of the frame overlaps the previous image and press the shutter-release button.
- Repeat this process until the necessary number of images have been taken to complete the scene.



5 Tap **X** when shooting is complete.

- The camera returns to step 2.



✓ Notes About Panorama Assist

- Apply or adjust shooting settings (📖41) before releasing the shutter for the first image. Shooting settings cannot be changed after the first image is taken. Images cannot be deleted, nor can zoom operate after the first picture has been taken.
- Shooting for the panorama series is terminated if the auto off function (👁️75) initiates standby mode during shooting. Setting the time allowed to elapse before the auto off function is enabled to a longer setting is recommended.

✍️ AE/AF-L Indicator

In **Panorama assist** scene mode, exposure, white balance, and focus for all images in a panorama are fixed at the values for the first image in each series.

When the first picture is taken, **AE/AF-L** is displayed to indicate that exposure, white balance, and focus are locked.



✍️ Panorama Creation with Panorama Maker 6

- Transfer images to a computer (📖79) and use Panorama Maker 6 to join them in a single panorama.
- Panorama Maker 6 can be installed on a computer using the included ViewNX 2 Installer CD (📖77).
- After installation is complete, follow the procedure described below to start Panorama Maker 6.

Windows: Choose **Start** menu>**All Programs**>**ArcSoft Panorama Maker 6**>**Panorama Maker 6**.

Mac OS X: Open **Applications** and double-click the **Panorama Maker 6** icon.

- For more information on using Panorama Maker 6, refer to the on-screen instructions and help information contained in Panorama Maker 6.

✍️ More Information

See "File and Folder Names" (👁️86) for more information.

Favorite Pictures Mode

You can sort your favorite pictures into nine albums (this option is not available for movies). Once they are added, you can choose to play back only favorite pictures by selecting favorite pictures mode.

- Categorizing albums by theme or type of subject makes it easier to find a particular image.
- A single image can be added to multiple albums.
- Up to 200 images can be added to each album.

Adding Images to Albums

1 Display the desired image in full-frame playback mode and tap the **MENU** tab.

- In favorite pictures mode, images cannot be added to albums.

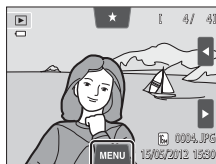

2 Tap .



3 Tap the desired album.



- The image is added to the selected album, and the monitor display returns to the favorite pictures screen.
- You can repeatedly add the same image to other albums by tapping them.
- Drag the current image to change the image to add.
- Tap  to finish adding images.



Viewing Images in an Album

▶ button (playback mode) → ▶ button → ★ Favorite pictures

Select the album you want to display and tap an album icon to play back images in the selected album.

- If you tap  on the album selection screen, you can change the album icons (their colors and designs) (8).
- If you tap the **MENU** tab in full-frame or thumbnail playback mode, you can select the playback options (75).

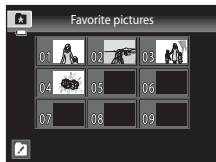

Note About Deleting Images in Favorite Pictures Mode

When images are added to albums, they are not physically copied to albums or moved from the folder to which they were originally recorded. Only the file names of images are added to albums. In favorite pictures mode, the images corresponding to the file names in the specified album are played back.

Deleting an image in favorite pictures mode deletes not only the image from the album, but also deletes the image file from the internal memory or memory card permanently.

Removing Images from Albums

To remove an image from an album without permanently deleting it, follow the procedures described below.

- Select the desired image in full-frame display in favorite pictures mode, tap the **MENU** tab to display the menu options, and then tap . The confirmation dialog is displayed.
- Tap **Yes** to remove the image from the album.

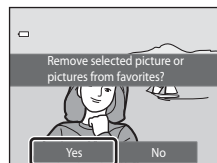

Changing Icons Assigned to Albums

The color and design of icon assigned to an album can be changed to reflect the theme of images included in the album.

1 Tap in the album selection screen (.

- The album icon and icon color selection screen is displayed.

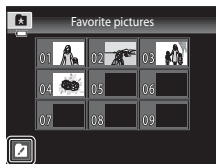

2 Tap the desired icon, tap or drag the slider to select the icon's color, and tap **OK**.

- The album selection screen is displayed.

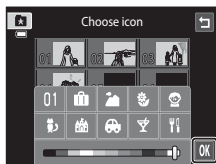

3 Tap the desired album.

- The icon is changed.
- To select a different icon and color again, tap  before tapping the album.



Notes About Icons for Albums

Choose icons for albums separately for the internal memory and for every memory card used.

- To change the icon for an album containing images stored in the internal memory, remove the memory card from the camera.
- The default setting for icons are numbers.

Auto Sort Mode

Images are automatically sorted into categories, such as portraits, landscapes, and movies.







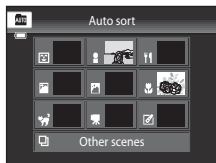

















▶ button (playback mode) → ▶ button →  Auto sort

Select the category you want to display and tap a category icon to play back images in the selected category.

- If you tap the **MENU** tab in full-frame or thumbnail playback mode, you can select the playback options (75).





Auto Sort Mode Categories

Category	Description
 Smile	Pictures taken in smart portrait mode ( 51) with the smile timer setting set to On .
 Portraits	Pictures taken in  (auto) mode ( 38) with the face detection function ( 68). Pictures taken in Portrait* , Night portrait* , Party/indoor , and Backlighting* scene modes ( 41). Pictures taken in smart portrait mode ( 51) with the smile timer setting set to Off .
 Food	Pictures taken in Food scene mode ( 41).
 Landscape	Pictures taken in Landscape* scene mode ( 41).
 Dusk to dawn	Pictures taken in Night landscape* , Sunset , Dusk/dawn , and Fireworks show scene modes ( 41).
 Close-ups	Pictures taken in  (auto) mode with the macro mode setting ( 59). Pictures taken in Close-up* scene mode ( 41).
 Pet portrait	Pictures taken in Pet portrait scene mode ( 41).
 Movie	Movies ( 82).
 Retouched copies	Copies created using editing functions ( 12).
 Other scenes	All other images that cannot be defined by the categories described above.

* Pictures taken in scene auto selector scene mode (43) are also sorted into the appropriate categories.

Notes About Auto Sort Mode

- Up to 999 images and movie files can be sorted into each category in auto sort mode. If 999 images or movies have already been sorted into a specific category, new images and movies cannot be sorted into that category or displayed in auto sort mode. Display images and movies that could not be sorted into a category in normal playback mode (32) or list by date mode (11).
- Images or movies copied from the internal memory to a memory card, or vice versa (60), cannot be displayed in auto sort mode.
- Images or movies recorded by a camera other than the COOLPIX S4300 cannot be displayed in auto sort mode.

List by Date Mode

▶ button (playback mode) → ▶ button → 📅 List by date

Select the date you want to display and tap a date to play back pictures taken on the selected date.

- To change the displayed month, tap ◀ or ▶.
- If you tap the **MENU** tab in full-frame or thumbnail playback mode, you can select the playback options (📖75).

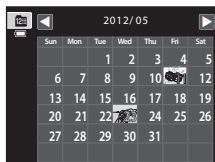

✔ Notes About List by Date Mode

- Up to 9,000 of the most recently recorded images can be displayed in list by date mode.
- Pictures taken before the date and time have been set are recognized as having been taken on January 1, 2012.

Editing Images (Still Images)

Editing Functions

Use the COOLPIX S4300 to edit images in-camera and store them as separate files (86). The editing functions described below are available.

Editing function	Description
Paint (14)	Draw on images, or add decorations to images.
Quick retouch (17)	Easily create retouched copies in which contrast and saturation have been enhanced.
D-Lighting (18)	Create a copy of the current image with enhanced brightness and contrast, brightening dark portions of the image.
Stretch (19)	Stretch the current image horizontally to make the subject appear thinner or wider.
Perspective control (20)	Adjust the perspective of pictures taken in landscape orientation. Apply perspective control similar to that available with shift lenses. This option is suited to images of buildings or architecture.
Filter effects (21)	Apply a variety of effects using digital filter. The available effects are Color options , Soft , Selective color , Cross screen , Fisheye , Miniature effect and Painting .
Glamour retouch (23)	Make facial skin tone softer and make faces look smaller with larger eyes.
Small picture (24)	Create a small copy of images suitable for use as e-mail attachments.
Crop (25)	Crop a portion of the image. Use to zoom in on a subject or arrange a composition.

See page 57 for the rotate image function for more information.

Notes About Image Editing

- Pictures taken at an **Image mode** setting (64) of **4608x2592** cannot be edited.
- The editing functions of COOLPIX S4300 cannot be used for pictures taken with another make or model of digital cameras.
- If no face is detected in an image, a copy cannot be created using the glamour retouch function (23).
- Edited copies created with COOLPIX S4300 may not be displayed properly on a different model of digital camera. It may also be impossible to transfer them to a computer using a different model of digital camera.
- Editing functions are not available when there is not enough free space in the internal memory or on the memory card to store the edited copies.
- Images created in draw scene mode (2) can only be edited with the paint, small picture, or crop function.



Restrictions on Image Editing

When an edited copy is further modified with another editing function, check the following restrictions.



Editing function used	Editing function to use
Paint	The paint, small picture, or crop function can be used.
Quick retouch D-Lighting Stretch Perspective control Filter effects	The paint, small picture, glamour retouch, or crop function can be used.
Glamour retouch	The editing functions other than glamour retouch can be used.
Small picture	Another editing function cannot be used.
Crop	Another editing function cannot be used. However, the paint function can be applied to cropped copies saved at an image size of 640 × 480 pixels or larger.

- Copies created with editing functions other than the paint function cannot be further edited with the same function used to create them.
- When combining the small picture or crop function and another editing function, use the small picture or crop functions after other editing function have been applied.
- Retouch effects such as the glamour retouch function's skin softening effect can be applied to pictures taken with the skin softening function (47).













Original and Edited Images

- Copies created with editing functions are not deleted when the original images are deleted. The original images are not deleted when copies created with editing functions are deleted.
- Edited copies are stored with the same recording date and time as the original.
- The rating settings (74), protect settings (51), and print order (53) of the original image are not applied to edited copies.

Paint

 button (playback mode) → select an image → Tap the **MENU** tab →  Paint

1 Use the , , , and tools to paint images.

- For more information about using each tool, see “Write and Draw on images” ( 15).
- Tap  or rotate the zoom control to **T** () to display the image in full-frame playback mode and tap  or rotate the zoom control to **T** () again to enlarge the image display by 3x. Tap , , , or  to change the portion of the image visible in the monitor. Tap  or rotate the zoom control to **W** () to return to the original display size.
- Tap  to undo the last operation applied using the pen, eraser, or decoration tool (up to the last five operations can be undone).

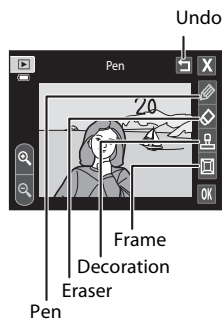

2 Tap .

- If you tap  when a drawing has not been saved, a confirmation dialog is displayed. Tap **Yes** to quit without saving the drawing.

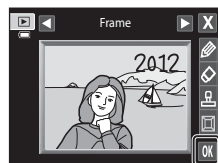

3 Tap **Yes**.

- A new, painted copy is created.
- Pictures taken at an **Image mode** setting ( 64) of  **2272x1704** or larger are saved at a size of 2048 x 1536, pictures taken at  **1600x1200** or  **640x480** are saved at a size of 640 x 480.
- Painted copies can be recognized by the  icon displayed during playback.



Using the Paint Tools

Write and Draw on images

Tap  to write or draw on images.

You can change the color and thickness of the pen using the palette. To hide the palette, tap  or the image.

- Tap or drag the pen color slider to select pen color.
- Tap the pen thickness slider to select pen thickness.

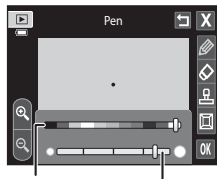

Pen color Pen thickness

Erase Paint Tool Additions

Tap  to erase additions to images using the paint or decoration tool.

You can change the size of the eraser using the palette. To hide the palette, tap  or the image.

- Tap the eraser size slider to select the size of the eraser.

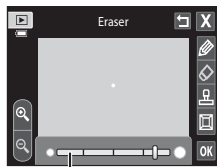



Eraser size

Add Decorations

Tap  to add a decoration.

You can change the decoration type or size using the palette. To hide the palette, tap  or the image.

- Decoration type can be selected from 14 types.
- Tap the decoration size slider to select the decoration size.
- When  is selected for the decoration type,  (day, month, year) and  (day, month, year, time) options are available.

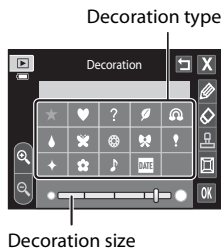



Add a Frame

Tap  to add a frame around the image.

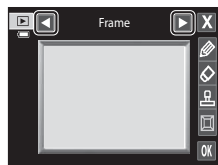
- Tap  or  to display seven different frames one at a time. Tap  to select a frame.





Notes About Shooting Date Decoration

- When the shooting date decoration is added to pictures taken at an **Image mode** setting () of **VCA 640×480**, the shooting date may be difficult to read. Set **Image mode** to  **1600×1200** or larger when shooting.
- The date added with the shooting date decoration uses the **Date format** setting selected in the setup menu's **Time zone and date** item (.
- The date and time added with the shooting date decoration are the date and time at which the picture was taken. These cannot be changed.

More Information

See "File and Folder Names" () for more information.

Quick Retouch: Enhancing Contrast and Saturation

 button (playback mode) → Tap the MENU tab → Tap  Retouch →  Quick retouch

- 1 Choose the degree of enhancement and tap .



- 2 Tap **Yes**.

- A new, retouched copy is created.
- Copies created with the quick retouch option can be recognized by the  icon displayed in playback mode.

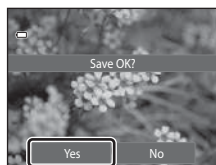

More Information

See “File and Folder Names” ( 86) for more information.

D-Lighting: Enhancing Brightness and Contrast

 button (playback mode) → Tap the **MENU** tab → Tap  Retouch →  D-Lighting

1 Tap .

- The original version is shown on the left and the edited version is displayed on the right.

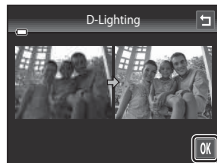

2 Tap **Yes**.

- A new, edited copy is created.
- Copies created with the D-Lighting function can be recognized by the  icon displayed in playback mode.





More Information

See "File and Folder Names" ( 86) for more information.

Stretch: Stretching Images

 button (playback mode) → Tap the **MENU** tab → Tap  Retouch →  Stretch

- 1 Tap  or , or tap or drag the slider at the bottom of the screen to adjust stretch effect.

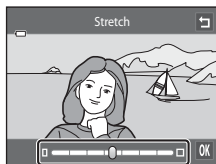

- 2 Tap .

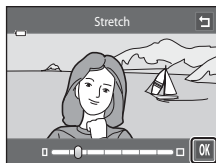

- 3 Tap **Yes**.

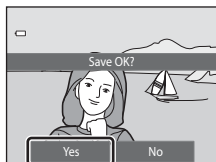

- A new, stretched copy is created.
- Stretched copies can be recognized by the  icon displayed in playback mode.





More Information

See "File and Folder Names" ( 86) for more information.

Perspective Control: Adjusting a Sense of Perspective

-  button (playback mode) → Tap the **MENU** tab → Tap  Retouch →  Perspective control

- 1** Tap  or , or tap or drag the slider at the bottom of the screen to adjust perspective control.

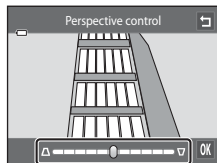

- 2** Tap .

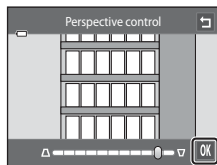

- 3** Tap **Yes**.

- A new, edited copy is created.
- Copies created using the perspective control function can be recognized by the  icon displayed in playback mode.

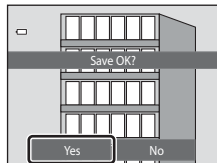











More Information

See "File and Folder Names" (86) for more information.

Filter Effects: Applying Digital Filter Effects

▶ button (playback mode) → Tap the MENU tab → Tap  Retouch →  Filter effects

Type	Description
 Color options	Modify color tones using color effects. The available effects are  (vivid color),  (black-and-white),  (sepia), and  (cyanotype).
 Soft	Give the image a soft look by blurring the area surrounding the point that is tapped.
 Selective color	Keep one specified color in the image, and change the other colors to black and white.
 Cross screen	Produce star-like rays of light that radiate outward from bright objects such as sunlight reflections and city lights. This effect is suitable for night scenes.
 Fisheye	Make an image look as if it were taken with a fisheye lens. This effect is well-suited for pictures taken in macro mode.
 Miniature effect	Make an image look like a miniature scene taken in macro mode. This effect is well-suited for pictures taken from a high vantage point with the main subject at the center of the image.
 Painting	Give images a hand-painted appearance.

1 Tap the icon of the desired effect.

- While the menu options are displayed, you can switch the image by dragging the image.



2 Adjust the effect.

- **Color options:** Select the color and tap **OK**.
- **Soft:** Tap the area where you want to apply the effect, select the level of the effect, and tap **OK**.
- **Selective color:** Tap the color slider to select the color to keep and tap **OK**.
- **Cross screen, Fisheye, Miniature effect, Painting:** Check the results of the effect and tap **OK**.
- Tap **⏪** to return to the filter effects menu screen shown in step 1 without making any changes.

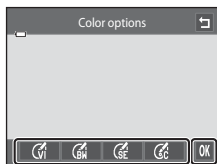

Example: **Color options**

3 Tap **Yes** in the confirmation dialog.



- A new, edited copy is created.
- Copies created using the filter effects function can be recognized by the **📷** icon displayed in playback mode.



More Information

See "File and Folder Names" (**📷**86) for more information.

Glamour Retouch: Softening Skin and Making Faces Looking Smaller with Larger Eyes



 button (playback mode) → Tap the **MENU** tab → Tap  Retouch →
 Glamour retouch

1 Tap **All** or **Skin softening**.

- **All:** Soften facial skin tones, make faces look smaller, and make eyes look larger.
- **Skin softening:** Soften facial skin tones.
- The preview screen is displayed.



2 Preview the result of the effect.

- Skin tones in up to 12 faces, in the order of that closest to the center of the frame, are softened.
- Tap **Before** or **After** to view the image with or without the effects.
- If more than one face were retouched, tap  or  to display a different face.
- To change the effect, tap  to return to step 1.
- Tap **OK** to display the confirmation dialog for saving the new copy.

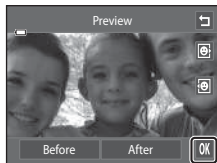

3 Tap **Yes**.

- A new, edited copy is created.
- Copies created using the glamour retouch function can be recognized by the  icon displayed in playback mode.





Notes About Glamour Retouch

- The glamour retouch function may not perform as expected depending on the direction in which the faces are looking or the brightness of the faces in the image.
- If no faces are detected in the image, the glamour retouch function cannot be used.



More Information

See "File and Folder Names" (86) for more information.

Small Picture: Reducing Image Size

 button (playback mode) → Tap the **MENU** tab → Tap  Retouch →  Small picture

1 Tap the desired small copy size control and tap **OK**.

- The  **640×480**,  **320×240**, and  **160×120** sizes are available.



2 Tap **Yes**.



- A new, smaller copy is created (compression ratio of approximately 1:16).
- The copy is displayed with a black frame.



More Information

See “File and Folder Names” (86) for more information.

✂ Crop: Creating a Cropped Copy

Create a copy containing only the portion visible in the monitor when  is displayed with playback zoom () enabled. Cropped copies are stored as separate files.

1 Enlarge the picture for cropping ()

2 Refine copy composition.

- Rotate the zoom control to **T** () or **W** () to adjust the zoom ratio.
- Drag the image or tap , , , and  so that only the portion you want to keep is visible in the monitor.

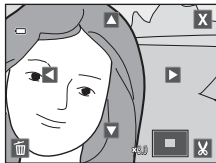

3 Tap .

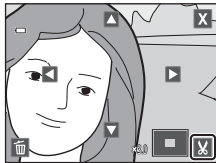

4 Tap **Yes**.

- A new, cropped copy is created.



Editing Images (Still Images)

Image Size

As the area to be saved is reduced, the image size (pixels) of the cropped copy is also reduced. When the size of the cropped copy is 320×240 or 160×120 , a black frame is displayed around the image, and the small picture icon  is displayed on the left of the screen.

Cropping the Picture in its Current “Tall” Orientation

Use the **Rotate image** option (57) to rotate the image so that it is displayed in landscape orientation. After cropping the image, rotate the cropped image back to “tall” orientation. The image displayed in “tall” orientation can be cropped by zooming in on the image until the black bars displayed on the both sides of the monitor disappear. The cropped image is displayed in landscape orientation.

More Information

See “File and Folder Names” (86) for more information.

Connecting the Camera to a TV (Playback on a TV)

Connect the camera to a television using the included audio/video cable to play back images full-frame or in a slide show, or to play back movies, on a television.

1 Turn off the camera.

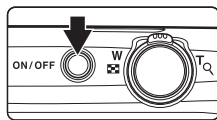

2 Connect the camera to the TV using the included audio/video cable.

- Connect the yellow plug to the video-in jack and the white plug to the audio-in jack on the TV.
- Be sure that plugs are properly oriented. Do not attempt to insert plugs at an angle, and do not use force when connecting or disconnecting the plugs.

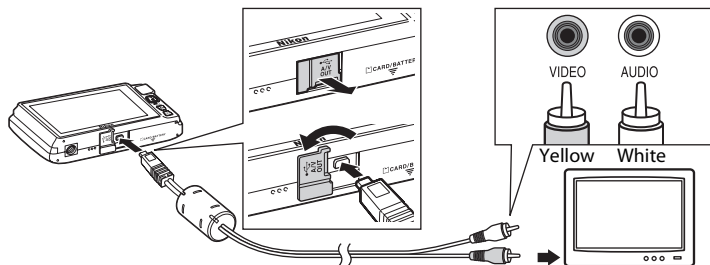

3 Tune the television to the video channel.

- See the documentation provided with your television for details.

4 Hold down the button to turn on the camera.

- The camera enters playback mode and images are displayed on the television.
- While connected to the TV, the camera monitor will remain off.
- See "Operations with TV Connection" ( 28) for more information.

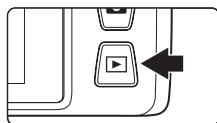



Operations with TV Connection

While images are displayed full-frame on the TV, the previous or next image can be viewed by dragging your finger across the camera monitor.

When the first frame of a movie is displayed, the movie can be played back by tapping the camera monitor.

- Tap the camera monitor to turn TV display off and display the image in the camera monitor. When images are displayed in the camera monitor, tap the controls displayed to operate the camera.
- Images cannot be cropped.
- Images will be automatically displayed on the TV in the following situations.
 - No operations are performed for a few seconds.
 - A slide show is played back.
 - A movie is played back.

Video Mode

Be sure that the camera's video mode setting conforms to the standard used by your television. Specify the **Video mode** option (77) in the setup menu (88).

Connecting the Camera to a Printer (Direct Print)

Users of PictBridge-compatible (🔦16) printers can connect the camera directly to the printer and print images without using a computer. Follow the procedures below to print images.

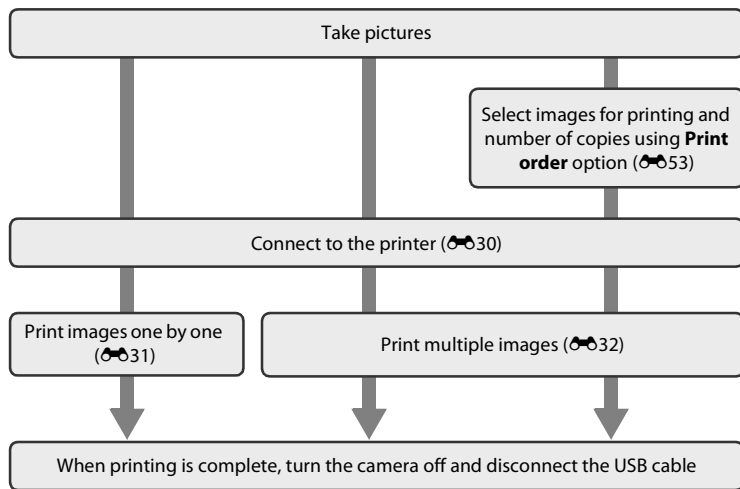

✔ Notes About Power Source

- When connecting the camera to a printer, use a fully charged battery to prevent the camera from turning off unexpectedly.
- If the AC Adapter EH-62G (available separately) is used, COOLPIX S4300 can be powered from an electrical outlet. Do not use any other make or model of AC adapter as they may cause the camera to overheat or malfunction.

📎 Printing images

Images saved on a memory card can be printed by transferring the images to a computer or connecting the camera directly to a printer. The following printing methods are also available:

- Inserting a memory card into a DPOF-compatible printer's card slot
- Taking a memory card to a digital photo lab

For printing using these methods, specify the images and the number of prints each to the memory card using the **Print order** menu (🔦53).

Connecting the Camera to a Printer

- 1 Turn off the camera.

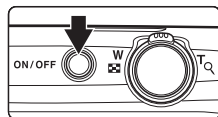

- 2 Turn on the printer.

- Check printer settings.

- 3 Connect the camera to the printer using the included USB cable.

- Be sure that plugs are properly oriented. Do not attempt to insert plugs at an angle, and do not use force when connecting or disconnecting the plugs.

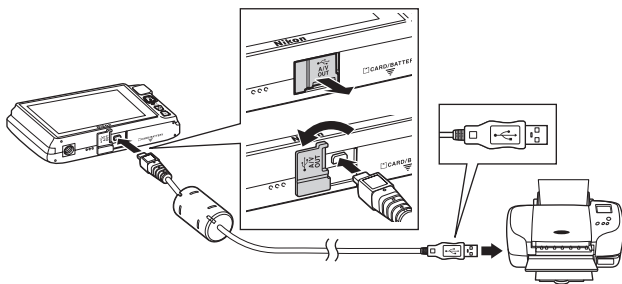

- 4 The camera is automatically turned on.

- When properly connected, the **PictBridge** startup screen (1) will be displayed in the camera monitor, followed by the image selection screen (2).

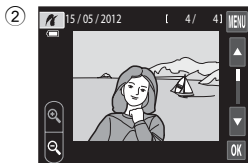
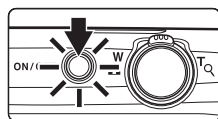

If the PictBridge Startup Screen Is not Displayed

Turn the camera off and disconnect the USB cable. Set the **Charge by computer** option (78) in the camera's setup menu to **Off**, then connect the camera again.

Printing Images One by One

After properly connecting the camera to the printer (📷30), follow the procedure described below to print an image.

1 Tap **▲** or **▼** to choose the desired image and tap **OK**.

- Tap **📷** or rotate the zoom control to **W** (📷) to switch to nine-thumbnail display. Tap **📷** or rotate the zoom control to **T** (📷) to switch back to full-frame playback.



2 Tap **Copies**.

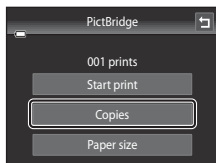



3 Tap the desired number of copies (up to nine).

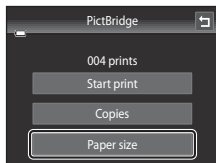

4 Tap **Paper size**.



5 Tap the desired paper size.

- Tap  or  to display additional options.
- To specify paper size using printer settings, choose **Default** in the paper size menu.

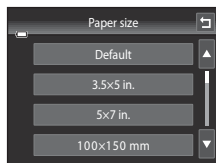
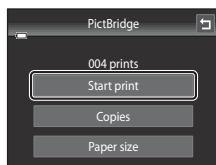
**6** Tap **Start print**.**7** Printing begins.

- Monitor display returns to the print selection screen shown in step 1 when printing is complete.

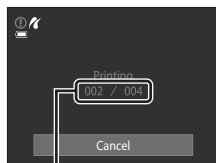

Current number of copies/
total number of prints

Printing Multiple Images

After properly connecting the camera to the printer (030), follow the procedure described below to print multiple images.

1 When the image selection screen is displayed, tap **MENU**.**2** Tap **Paper size**.

- To exit the print menu, tap .

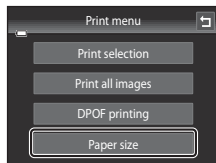

3 Tap the desired paper size.

- Tap or to display additional options.
- To specify paper size using printer settings, choose **Default** in the paper size option.

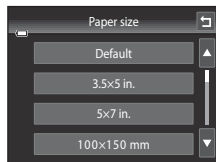
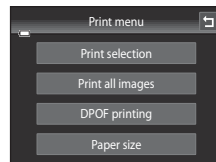
**4** Tap **Print selection**, **Print all images**, or **DPOF printing**.**Print selection**

Choose images (up to 99) and the number of copies (up to nine) of each.

- Tap the desired image and tap or at the bottom of the monitor to specify the number of copies to be printed.
- Images selected for printing can be recognized by the check mark () and the numeral indicating the number of copies to be printed. If no copies have been specified for images, the selection is canceled.
- Tap or rotate the zoom control to **T** () to switch to full-frame playback. Tap or rotate the zoom control to **W** () to switch back to 9-thumbnail display.
- Tap to cancel the selection of all images.
- Tap when setting is complete.
- When the screen shown at right is displayed, tap **Start print** to start printing. Tap **Cancel** to return to the print menu.

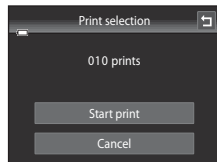

Connecting the Camera to a Printer (Direct Print)

Print all images

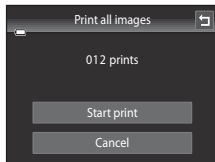

One copy each of all images stored in the internal memory, or on the memory card, is printed.

- When the screen shown at right is displayed, tap **Start print** to start printing. Tap **Cancel** to return to the print menu.



DPOF printing

Print images for which a print order was created using the **Print order** option (53).

- When the screen shown at right is displayed, tap **Start print** to start printing. Tap  to return to the print menu.
- To view the current print order, tap **View images**. To print images, tap .

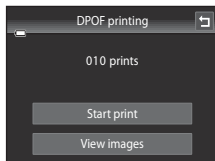

5 Printing begins.

- Monitor display returns to the print menu (step 2) when printing is complete.

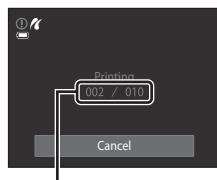



Current number of copies/
total number of prints





Paper Size



The camera supports the following paper sizes: **Default** (the default paper size for the printer connected to the camera), **3.5×5 in.**, **5×7 in.**, **100×150 mm**, **4×6 in.**, **8×10 in.**, **Letter**, **A3**, and **A4**. Only sizes supported by the printer will be displayed. To specify paper size using printer settings, choose **Default** in the paper size option.







The Shooting Menu (for (Auto) Mode)

- See “ Changing the Image Size (Image Mode)” (64) for information about  **Image mode**.





/ / **Touch Shooting**

On the  (auto) mode shooting screen → Tap the **MENU** tab → / /  Touch shooting



- The touch shooting function can be used in  (auto) mode and other shooting modes (except with **Subject tracking**).
- The **Touch shutter** and **Touch AF/AE** operations differ according to the current shooting mode (, ).

Option	Description	
 Touch shutter (default setting)	Pictures can be taken by simply tapping the monitor.	 36
 Subject tracking	Use this option to take pictures of moving subjects. Tap the subject on which the camera will focus. The focus area will automatically move to track the subject.	 38
 Touch AF/AE	Tap the monitor to set the focus area. Press the shutter-release button to take the picture with the focus and exposure achieved with the focus area.	 40

Tapping the Monitor to Release the Shutter (Touch Shutter)





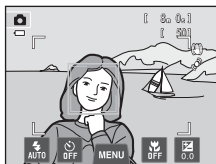
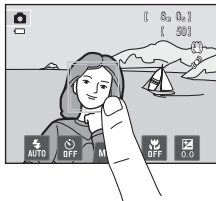

On the  (auto) mode shooting screen → Tap the MENU tab → Tap // Touch shooting →  Touch shutter

Tap the desired subject to take a picture.

- Do not use force when tapping the monitor as this may cause slight movement of the camera, resulting in blurred images.
- When digital zoom is in effect, the camera focuses on the subject in the center of the frame.
- The shutter-release button can also be used when the touch shutter option is selected.
- If  is displayed when the monitor is tapped, the shutter cannot be released. Tap an area within  or a border displayed when the camera detects a face.













Notes About Touch Shutter

- When taking pictures with **Continuous** or **BSS** in **Continuous** setting (43) enabled, or in **Sports** or **Museum** scene mode (41), use the shutter-release button to take pictures. Only one picture can be taken at a time using the touch shutter function.
- Prevent shooting with accidental tapping of the monitor in  (auto) mode and some scene modes by changing the touch shooting setting to **Touch AF/AE** (40). At this setting, the shutter is not released when the monitor is tapped.
- When shooting subjects with which autofocus may not perform as expected, the subject may not be in focus (31).
- When a subject displayed in the monitor is tapped with the self-timer (57) enabled, the camera locks focus and releases the shutter after ten or two seconds.
- There are functions with which this setting cannot be enabled (66).

 **Shooting Modes That Support Touch Shutter**

The touch shutter can be used in  (auto) mode and other shooting modes. Touch shutter operation differs according to the current shooting mode as follows.

Shooting mode	Touch shutter operation
 (auto) mode ( 38), Sports, Party/indoor, Beach, Snow, Close-up, Food, Museum, Black and white copy, and Backlighting scene modes ( 41)	Tap the intended subject. Focus and exposure are set for the area tapped. When the camera detects more than one face, tap a face framed by a single border to set focus and exposure for that face.
Scene auto selector scene mode ( 41), Special effects ( 50), and smart portrait mode (when Smile timer is set to Off ;  51)	<ul style="list-style-type: none"> • When the camera detects any faces, tap a face framed by a border. Focus and exposure are set on the tapped face. • When no face is detected, the camera focuses at the area tapped.
Portrait and Night portrait scene modes ( 41)	Only a border displayed by the face detection function can be selected. When the camera detects more than one face, tap a face framed by a single border to set focus and exposure for that face.
Landscape, Sunset, Dusk/dawn, Night landscape, Fireworks show, and Panorama assist scene modes ( 41)	Focus and exposure are set for the same focus area used when pictures are taken by pressing the shutter-release button. See “Scene Mode (Shooting Suited to Scenes)” ( 43) for more information.
Smart portrait mode (when Smile timer is set to On ;  51)	Touch shutter cannot be enabled. When the camera detects more than one face, tap a face framed by a single border to move the focus area to that face.
Pet portrait scene mode ( 41)	When Pet portrait auto release is set to On : Touch shutter cannot be enabled. When set to Off : Only borders displayed by the pet face detection function can be selected. When the camera detects more than one pet’s face, tap a face framed by a single border to move the focus area to that face.

📷 Focusing on a Moving Subject (Subject Tracking)

On the 📷 (auto) mode shooting screen → Tap the MENU tab → Tap 📷/📷/📷 Touch shooting → 📷 Subject tracking

In 📷 (auto) mode (📖38), the touch shooting setting can be changed from **Touch shutter** (default setting) to **Subject tracking**.

- 📷 (subject tracking) is enabled only in 📷 (auto) mode.

1 Register a subject.

- Tap the desired tracking subject in the monitor.
 - The subject is registered.
 - When the camera detects any faces, tap a face framed by a border to register it as the subject and begin tracking. If the camera detects more than one face, the borders around the faces that are not selected disappear.
 - When a subject other than a face is registered, a yellow focus area is displayed on the subject and the camera begins tracking the subject.
 - When the border framing the subject glows red, the camera is unable to focus. Change the composition and try again.
- If the tapped area does not contain a subject that can be registered, [] is displayed in the monitor. Tap a subject within [].
- Tap another subject to change a subject to follow.
- To cancel the registration of the subject, tap 📷, displayed at left in the monitor.
- If the camera cannot track the registered subject anymore, the focus area will disappear and the registration will be canceled. Register the subject again.

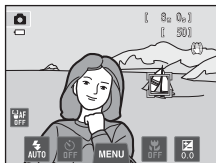
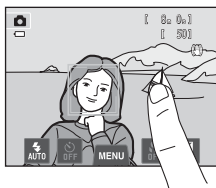





2 Press the shutter-release button to take a picture.

- The camera focuses on the focus area when the shutter-release button is pressed halfway. The focus area will glow green and focus will be locked.
- When the camera is unable to focus, the focus area will flash. Press the shutter-release button halfway again to focus.
- If the shutter-release button is pressed halfway while the focus area is not displayed, the camera focuses on the subject at the center of the frame.
- Press the shutter-release button all the way down to release the shutter.





Notes About Subject Tracking Mode

- Digital zoom is not available.
- The sound of the lens focus motor can be heard when the subject tracking function is working.
- Adjust zoom position and apply shooting settings (38) before registering the subject. If these settings are adjusted after the subject has been registered, subject registration will be canceled.
- It may be impossible to register the desired subject, or the camera may be unable to track the registered subject or may begin tracking a different subject, if the subject is moving rapidly, if there is a significant amount of camera shake, or if the camera detects a similar subject. The camera's ability to accurately track the registered subject is also dependent upon the size and brightness of the subject.
- In some rare cases, subjects with which autofocus may not perform as expected (31) may be out of focus despite the fact that the focus area glows green. In this situation, focus on another subject which is at the same distance from the camera as the intended subject (40).
- There are functions with which this setting cannot be enabled (66).





Touch Shooting Setting

Subject registration with subject tracking will be canceled when the camera is turned off.

Tapping the Monitor to Focus (Touch AF/AE)

On the  (auto) mode shooting screen → Tap the MENU tab → Tap /Touch shooting →  Touch AF/AE

1 Tap the subject on which the camera focuses.

-  or a double border will be displayed at the area tapped.
- When digital zoom is applied, the focus area cannot be selected.
- To cancel the focus area selection, tap  displayed at left in the monitor.
- If a position on which focus cannot be acquired is tapped,  will be displayed in the monitor. Tap another position inside .

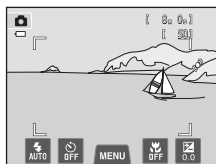
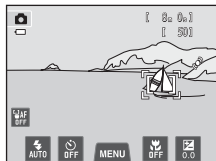

2 Press the shutter-release button to take a picture.

- Press the shutter-release button halfway to acquire focus and exposure, and press it all the way down to release the shutter.













Notes About Touch AF/AE

- When shooting subjects with which autofocus may not perform as expected, the subject may not be in focus ()31).

Shooting Modes That Enable Touch AF/AE Function

Touch AF/AE can be used in  (auto) mode and other shooting modes. Touch AF/AE operation differs according to the current shooting mode as follows.

Shooting mode	Touch AF/AE operation
 (auto) mode ()38), Sports, Party/indoor, Beach, Snow, Close-up, Food, Museum, Black and white copy, and Backlighting scene modes ()41)	Focus and exposure are set for the area tapped.
Scene auto selector scene mode ()41), Special effects ()50), and smart portrait mode (when Smile timer is set to Off ; )51)	<ul style="list-style-type: none"> When the camera detects a face, only a face framed by a border can be selected. When the camera detects more than one face, tap a face framed by a single border to move the focus area to that face. When no face is detected, the camera focuses at the area tapped.
Portrait and Night portrait scene modes ()41), and smart portrait mode (when Smile timer is set to On ; )51)	Only a border displayed by the face detection function can be selected. When the camera detects more than one face, tap a face framed by a single border to move the focus area to that face.
Landscape, Sunset, Dusk/dawn, Night landscape, Fireworks show, and Panorama assist scene modes ()41)	Focus area cannot be changed.
Pet portrait scene mode* ()41)	When Pet portrait auto release is set to On : Touch AF/AE is disabled. When set to Off : Only borders displayed by the pet face detection function can be selected. When the camera detects more than one pet's face, tap a face framed by a single border to set the focus and exposure on that face.

* Set **Pet portrait auto release** to **Off** to enable touch shutter (default setting) or touch AF/AE.

ISO ISO Sensitivity

On the 📷 (auto) mode shooting screen → Tap the MENU tab → ISO ISO sensitivity

The higher the sensitivity, the less light is needed to expose an image, allowing capturing darker subjects.

Additionally, even with subjects of similar brightness, pictures can be taken at faster shutter speeds, and blurring caused by camera shake and subject movement can be reduced.

- Although higher ISO sensitivity is effective when shooting darker subjects, shooting without the flash, shooting while using the zoom, etc., images may contain noise.

Option	Description
AUTO Auto (default setting)	Sensitivity is ISO 80 when there is sufficient lighting; when lighting is poor, the camera compensates by raising sensitivity to a maximum of ISO 1600.
A ISO Fixed range auto	Choose the range in which the camera automatically adjusts ISO sensitivity from ISO 80-400 or ISO 80-800 . The camera will not increase sensitivity beyond the maximum value in the selected range. Set the maximum value for ISO sensitivity for effective control over the amount of “grain” that appears in images.
80, 100, 200, 400, 800, 1600, 3200	Sensitivity is locked at the specified value.

✔ Notes About ISO Sensitivity



- There are functions with which this setting cannot be enabled (📖66).
- **Motion detection** (📷72) does not function when the ISO sensitivity is set to any setting other than **Auto**.

✔ ISO 3200





When **ISO sensitivity** is set to **3200**, the available **Image mode** settings are limited to **4K 2272×1704**, **2K 1600×1200**, and **VGA 640×480**. The 📷 indicates the ISO sensitivity setting.



Continuous

On the  (auto) mode shooting screen → Tap the **MENU** tab →  Continuous

Enable continuous shooting or **BSS** (Best Shot Selector).

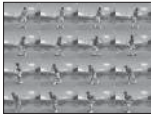
Option	Description
 Single (default setting)	One picture is taken each time the shutter-release button is pressed.
 Continuous	While the shutter-release button is held down, up to 6 pictures are taken at a rate of about 1.3 frames per second (at an Image mode setting of  4608×3456).
BSS BSS (Best Shot Selector)	The “Best Shot Selector” is recommended when shooting with the flash off or the camera zoomed in, or in other situations in which inadvertent motion can result in blurred images. When BSS is on, the camera takes up to 10 pictures while the shutter-release button is held down. The sharpest image in the series is automatically selected and saved.
 Multi-shot 16	Each time the shutter-release button is pressed, the camera takes 16 shots at a rate of about 30 fps and arranges them in a single image. <ul style="list-style-type: none"> • Image mode is fixed at  (2560 × 1920). • Digital zoom is not available. 

Notes About Continuous Shooting

- When **Continuous**, **BSS**, or **Multi-shot 16** is selected, the flash is disabled. Focus, exposure, and white balance are fixed at the values determined with the first image in each series.
- The frame rate with continuous shooting may vary depending upon the current image mode setting, the memory card used, or shooting condition.
- There are functions with which this setting cannot be enabled (66).



Note About BSS

BSS is effective when taking pictures of still subjects. BSS may not produce the desired results if the subject moves or the composition changes while the shutter-release button is held down.







Note About Multi-shot 16

Smear (3) visible in the monitor when shooting with **Multi-shot 16** enabled will be recorded with images. Avoiding bright objects such as the sun, reflections of the sun, and electric lights when shooting with **Multi-shot 16** enabled is recommended.

WB White Balance (Adjusting Hue)

On the  (auto) mode shooting screen → Tap the **MENU** tab →  White balance

The color of light reflected from an object varies with the color of the light source. The human brain is able to adapt to changes in the color of the light source, with the result that white objects appear white whether seen in the shade, direct sunlight, or under incandescent lighting. Digital cameras can mimic this adjustment by processing images according to the color of the light source. This is known as “white balance.” For natural colors, choose a white balance setting that matches the light source before shooting. Although the default setting, **Auto**, can be used under most types of lighting, the white balance setting suited to a particular light source can be specified manually to achieve more accurate results.

Option	Description
AUTO Auto (default setting)	White balance automatically adjusted to suit lighting conditions. Best choice in most situations.
PRE Preset manual	Useful when shooting under unusual lighting. See “Preset Manual” ( 45) for more information.
 Daylight	White balance adjusted for direct sunlight.
 Incandescent	Use under incandescent lighting.
 Fluorescent	Use under fluorescent lighting.
 Cloudy	Use when taking pictures under overcast skies.
 Flash	Use with the flash.

 Note About White Balance

At white-balance settings other than **Auto** or **Flash**, turn the flash off () (55).

Preset Manual

The preset manual option is effective with mixed lighting or to compensate for light sources with a strong color cast when the desired effect has not been achieved with white balance settings like **Auto** and **Incandescent** (for example, to make pictures taken under a lamp with a red shade look as though they had been shot under white light). Follow the procedure below to measure the white balance value according to the light source when shooting.

- 1 Place a white or gray reference object under the lighting that will be used during shooting.
- 2 Tap the **MENU** tab to display the menu options () and tap **WB**.

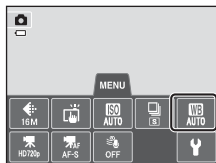

- 3 Tap **PRE**.
 - The lens extends to the zoom position for measurement.

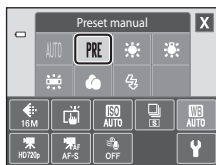

- 4 Frame the white or gray reference object in the measuring window.
 - To apply the most recently measured value for preset manual instead of taking a new measurement, tap **Cancel**. The most recently measured value is set for white balance, and a new measurement is not performed.

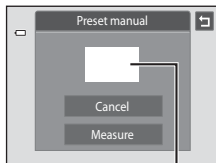

Measuring window

- 5 Tap **Measure** to measure a new white balance value.
 - The shutter is released and the new white balance value for preset manual is set. No image is saved.

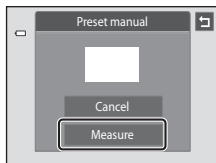



The Shooting Menu (for (Auto) Mode)

Note About Preset Manual

A value for flash lighting cannot be measured with **Preset manual**. When shooting using the flash, set **White balance** to **Auto** or **Flash**.



The Smart Portrait Menu

- See “ Changing the Image Size (Image Mode)” (64) for information about **Image mode**.
- See “Touch shooting” in “The Shooting Menu (for  (Auto) Mode)” for information about  **Touch shooting** (35).

Skin Softening

On the smart portrait mode screen → Tap the **MENU** tab →  Skin softening

Enable skin softening.

Option	Description
 High	When the shutter is released, the camera detects one or more human faces (up to three), and processes the image to soften facial skin tones before saving the image. You can select the amount of effect that is applied.
 Normal (default setting)	
 Low	
OFF Off	Turns skin softening off.

The effects of skin softening are not visible when framing images for shooting. Check the degree of skin softening performed in playback mode.

Blink Proof

On the smart portrait mode screen → Tap the **MENU** tab →  Blink proof

The camera automatically releases the shutter twice each time an image is taken. Of the two shots, one in which the subject's eyes are open is saved.

Option	Description
ON On	When On is selected, the flash is disabled. If the camera saved an image in which the subject's eyes may have been closed, the dialog shown at right is displayed for a few seconds.
OFF Off (default setting)	Turns the blink warning off.

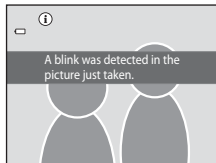

Smile Timer

On the smart portrait mode screen → Tap the **MENU** tab →  Smile timer

The camera detects human faces and then automatically releases the shutter whenever a smile is detected.

Option	Description
ON On (default setting)	Enables smile timer.
OFF Off	Turns the smile timer off.

The Playback Menu

- See “Favorite Pictures Mode” (🔍5) for information about 🌟 **Favorite pictures**.
- See “Step 6 Delete Unwanted Images” (📖34) for information about 🗑️ **Delete**.
- See “Editing Images (Still Images)” (🔍12) for information about 🖌️ **Paint** and 🪄 **Retouch**.

📺 Slide Show

▶ button (playback mode) → Tap the MENU tab → 📺 Slide show

Playback images stored in the internal memory or on a memory card one by one in an automated “slide show.”

1 Tap **Start**.

- To change the effect, tap 📁 **Effects** before tapping **Start**, and select from **Classic**, **Zoom**, or **Animated**.
- To change the interval between images, tap 🕒 **Frame intvl** and select the desired interval before tapping **Start**.
- To repeat the slide show automatically, tap 🔄 **Loop** before tapping **Start**.
- To exit without playing back images in a slide show, tap 🏠.

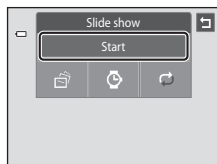







2 The slide show begins.

- Tap the monitor to display the operation panel at the bottom of the screen.

Tap the icons in the operation panel to perform the corresponding operation. The following operations are available.







To	Tap	Description
Rewind		Tap and hold  to rewind slide show.
Advance		Tap and hold  to advance slide show.
Pause		Pause playback. • To resume playback, tap  displayed at the center of the screen.
End		End slide show.

Notes About Slide Show

- Only the first frame of movies included in slide show is displayed.
- Even when **Loop** is selected, the slide show will only be played for a maximum of 30 minutes (0:30).

Protect

 button (playback mode) → Tap the MENU tab →  Protect

Protect selected images from accidental deletion. Protected images are recognized by the  icon (8) in playback mode.

Protecting One Image

Tap **ON** On.

- The selected image is protected.
- To exit without protecting images, tap .



Note About Protecting Images

Note that formatting the camera's internal memory or the memory card will permanently delete protected files (76).

Protecting Multiple Images

Multiple images can be protected at a time.

- 1 Switch to thumbnail playback mode (📖33), tap the **MENU** tab to display the menu options, and tap **On**.

- The monitor display switches to the image selection screen.

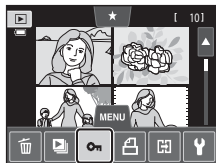

- 2 Tap the desired images to be protected.

- When an image is selected, a check mark (✔) is displayed. To cancel the selection, tap the image again.
- Tap **Q** or **Q**, or rotate the zoom control to **T** (🔍) or **W** (🔍) to change the number of images displayed.



- 3 Tap **OK**.

- The selected images are protected.
- To exit without protecting images, tap **Off**.



Removing Protection from Images

- To remove protection from an image, display a protected image in full-frame playback mode, follow the procedure in “Protecting One Image” (🔑51), and tap **Off** in “Protecting One Image”.
- To remove protection from multiple images at a time, uncheck protected images in step 2 of “Protecting Multiple Images”.

Print Order (Creating a DPOF Print Order)

▶ button (playback mode) → Tap the MENU tab → Print order

When printing images stored on the memory card using any of the following methods, the **Print order** option in the playback menu is used to create digital “print orders” for printing on DPOF-compatible devices.

- Inserting the memory card into a DPOF-compatible (PictBridge 16) printer's card slot.
- Taking the memory card to a digital photo lab.
- Connecting the camera to a PictBridge-compatible (PictBridge 16) printer (PictBridge 29). A print order can also be created for images stored in the internal memory if the memory card is removed from the camera.

Creating a Print Order for One Image

- 1 Tap the desired number of copies (up to nine) and tap **OK**.

- To exit without making the print order setting, tap **Cancel**.

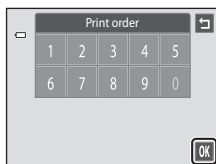

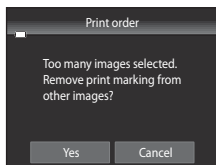

- If the total number of images in a print order, including images just added, exceeds 99, the screen shown at right will be displayed.
 - Tap **Yes** to remove images previously added from the print order and restrict the print order to images just marked.
 - Tap **Cancel** to remove the images just added from the print order and restrict the print order to images previously marked.

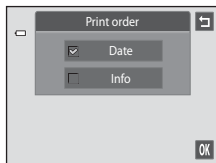

2 Choose whether or not to print shooting date and photo information.

- Tap **Date** to place in the checkbox to imprint the shooting date on the image.
- Tap **Info** to place in the checkbox to imprint the photo information (shutter speed and aperture value) on the image.
- Tap **OK** to complete the print order.



Images selected for printing are recognized by the  icon displayed with playback.

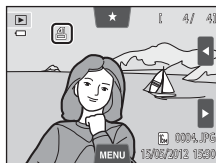







Creating a Print Order for Multiple Images

- 1 Switch to thumbnail playback mode (📖33), tap the **MENU** tab to display the menu options, and tap .

- The monitor display switches to the print order setting screen.



- 2 Tap the desired images to print (up to 99) and tap  or  at the bottom in the monitor to specify the number of copies (up to nine) for each.

- Images selected for printing can be recognized by the check mark (✔) and the numeral indicating the number of copies to be printed. If no copies have been specified for images, the selection is canceled.
- Tap  or , or rotate the zoom control to **T** () or **W** () to change the number of images displayed.
- Tap  to remove print markings from all images and cancel the print order.
- Tap **OK** when setting is complete.



- 3 Choose whether or not to print shooting date and photo information.

- Tap **Date** to place in the checkbox to imprint the shooting date on all images in the print order.
- Tap **Info** to place in the checkbox to imprint the photo information (shutter speed and aperture value) on all images in the print order.
- Tap **OK** to complete the print order.

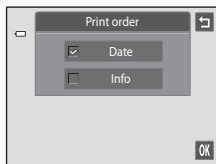

Canceling Print Order

- To remove a print marking from an image, display an image selected for printing in full-frame playback mode, follow the procedure in “Creating a Print Order for One Image” (🔗53), and tap “0” in step 1.
- To remove print markings from multiple images at a time, remove the print markings of the desired images in step 2 of “Creating a Print Order for Multiple Images” (🔗55). Tap  to remove print markings from all images.

✓ Notes About Printing Shooting Date and Photo Information

When the **Date** and **Info** options are enabled in the print order option, shooting date and photo information are printed on images when a DPOF-compatible printer (🔗16) that supports printing of shooting date and photo information is used.

- Photo information cannot be printed when the camera is connected directly to a printer, via the included USB cable, for DPOF printing (🔗34).
- Note that **Date** and **Info** settings are reset each time the **Print order** option is displayed.
- The date printed is that recorded when the picture was taken. Changing the **Date and time** and **Time zone** settings using the **Time zone and date** option in the setup menu after a picture has been taken has no effect on the date printed on the image.





Print Date

When date and time of recording are imprinted on images using the **Print date** option (🔗70) in the setup menu, images are recorded with shooting date and time imprinted on the picture when they are taken. Images with the date imprinted on them can be printed from printers that do not support printing of the date on images.

Only the date and time imprinted on images using the **Print date** option will be printed, even if the date print option is enabled in the **Print order** menu.

Rotate Image

 button (playback mode) → Tap the **MENU** tab → Tap  Retouch →  Rotate image

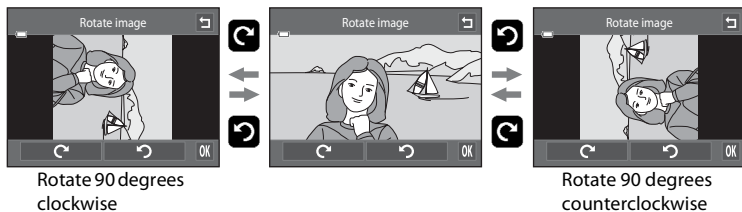

Specify the orientation in which recorded images are displayed during playback. Still images can be rotated 90 degrees clockwise or 90 degrees counterclockwise. Images that were recorded in portrait (“tall”) orientation can be rotated up to 180 degrees in either direction.

- Tap  or  to rotate the image 90 degrees.



- Tap **OK** to finalize display orientation and save the orientation information with the image.
- To exit without rotating image, tap .

Voice Memo





 button (playback mode) → select an image → Tap the **MENU** tab →  Voice memo

Use the camera's built-in microphone to record voice memos for images.

When you select an image with a voice memo attached, you can play back the voice memo.

- If you select an image that has no voice memo, the voice memo recording screen is displayed; if you select an image that has a voice memo (i.e., an image indicated by  in full-frame playback mode), the voice memo playback screen is displayed.

Recording Voice Memos



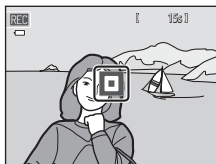

- Tap  to record a voice memo up to about 20 seconds in length.
 - Do not touch the built-in microphone during recording.
 - To exit without recording voice memos, tap .
-
- During recording, **REC** flashes in the monitor.
 - Recording ends when  is tapped during recording.
 - When recording ends, the voice memo playback screen is displayed. Follow the instructions in "Playing Voice Memos" ( 59) to play the voice memo.



More Information

See "File and Folder Names" ( 86) for more information.

Playing Voice Memos

- Tap  to play the voice memo.
- Tap  to stop playback.
- Tap  during playback to adjust playback volume.
-  flashes during playback.
- To exit without playing voice memos, tap .



Deleting Voice Memos

Tap  while the screen described in “Playing Voice Memos” is displayed. Tap **Yes** to delete only the voice memo.

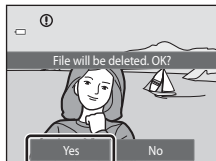

Notes About Voice Memos

- When a image with a voice memo attached is deleted, both the image and its voice memo are deleted.
- When an image with an attached voice memo is protected, neither the image nor the voice memo can be deleted.
- If a voice memo already exists for the current image, it must be deleted before a new voice memo can be recorded.
- The COOLPIX S4300 is not able to record a voice memo for pictures taken with another make or model of digital camera.

☰ Copy (Copy Between Internal Memory and Memory Card)

▶ button (playback mode) → Tap the MENU tab → ☰ Copy

Copy images between the internal memory and a memory card.

1 Tap the desired option from the copy screen.

- **Camera to card:** Copy images from internal memory to memory card.
- **Card to camera:** Copy images from memory card to internal memory.

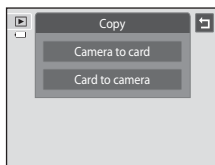

2 Tap the desired copy option.

- **Selected images:** Copy images selected. Proceed to step 3.
- **All images:** Copy all images. When a confirmation dialog is displayed, tap **Yes**. Images are copied. To return to the playback menu without copying, tap **No**.

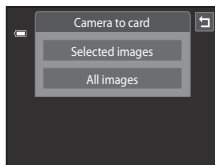

3 Tap the images to be copied.

- When an image is selected, a check mark is displayed. To cancel the selection, tap the image again. A check mark is removed.
- Tap **Q** or rotate the zoom control to **T** (🔍) to switch to full-frame playback and tap **Q** or rotate the zoom control to **W** (☰) to switch back to nine -thumbnail display.



4 Tap **OK**.

- When a confirmation dialog is displayed, tap **Yes**. Images are copied. To return to the playback menu without copying, tap **No**.



Notes About Copying images

- JPEG-, AVI-, and WAV-format files can be copied. Files recorded in any other format cannot be copied.
- If voice memos (🗣️58) are attached to images selected for copying, voice memos are copied with the images.
- Operation is not guaranteed with pictures taken with another make of camera or that have been modified on a computer.
- When copying images selected for **Print order** (🖨️53), the print marking is not copied. However, rating (📖74) and **Protect** (🔒51) settings are copied with images.
- Images or movies copied from the internal memory to a memory card, or vice versa, cannot be displayed in auto sort mode (🔄9).
- When images added to albums (📁5) are copied, the copies are not automatically added to the same albums as the original images.

“Memory contains no images.” Message

If there are no images stored on a memory card inserted in the camera when playback mode is applied, the message **Memory contains no images.** will be displayed. Tap the **MENU** tab and tap  to display copy options screen and copy the images saved in the camera’s internal memory to the memory card.

More Information



See “File and Folder Names” (🔗86) for more information.

The Movie Menu

Movie Options

On the shooting screen → Tap the MENU tab → Movie options

Select the desired movie option to record. A larger image size improves the image quality and increases the file size.

Option	Description
 HD 720p (1280×720) (default setting*)	Movies with an aspect ratio of 16:9 are recorded.
 VGA (640×480)	Movies with an aspect ratio of 4:3 are recorded.
 QVGA (320×240)	Movies with an aspect ratio of 4:3 are recorded.

* When recording in the internal memory, the default setting is  **VGA (640×480)**.

- The frame rate is approximately 30 fps for all options.

More Information

See “File and Folder Names” (6086) for more information.

Movie AF Mode

On the shooting screen → Tap the MENU tab → Movie AF mode

Choose how the camera focuses with recording movies.

Option	Description
AF-S Single AF (default setting)	Focus is locked when the ● (Movie-record) button is pressed to start recording. Select this option when the distance between the camera and the subject will remain fairly consistent.
AF-F Full-time AF	Camera focuses continuously during movie recording. Select this option when the distance between the camera and the subject will change. The sound of the camera focusing may be heard in the recorded movie. To prevent sound of camera focusing from interfering with recording, use of Single AF is recommended.

Wind Noise Reduction

On the shooting screen → Tap the MENU tab →  Wind noise reduction

Select whether wind noise is reduced when recording movies.









Option	Description
ON On	Records while minimizing the noise of wind blowing on the microphone. Suitable for recording in strong winds. During playback, not only wind noise, but other sounds may also become difficult to hear.
OFF Off (default setting)	Wind noise is not reduced.

The Setup Menu

Welcome Screen

Tap the MENU tab → Tap  (Setup menu) →  Welcome screen

Choose whether or not a welcome screen is displayed when the camera is turned on.

Option	Description
None (default setting)	The camera enters shooting or playback mode without displaying the welcome screen.
COOLPIX	The camera displays a welcome screen and enters shooting or playback mode.
Select an image	<p>Displays an image selected for the welcome screen. When the image selection screen is displayed, select an image and tap .</p> <ul style="list-style-type: none">On the image selection screen, tap  or rotate the zoom control to T () to switch to full-frame playback, and tap  or rotate the zoom control to W () to switch back to nine thumbnail display.As the selected image is stored in the camera, it will be displayed when the camera is turned on even if the original image is deleted.Pictures taken at an Image mode ( 64) setting of  4608x2592, and copies created at a size of 320 x 240 or smaller using the small picture ( 24) or crop ( 25) function, cannot be used.



🕒 Time Zone and Date

Tap the MENU tab → Tap 🛠️ (Setup menu) → 🕒 Time zone and date

Set the camera clock.

Option	Description
Date and time	<p>Set camera clock to current date and time. Tap the items (day, month, year, hour, and minute) on the displayed screen to set the date and time.</p> <ul style="list-style-type: none"> To select the item: tap the desired item. To edit the highlighted item: tap ▲ or ▼. To apply the setting: tap OK.
Date format	<p>Select the order in which the day, month, and year are displayed from Y/M/D (year/month/day), M/D/Y (month/day/year), and D/M/Y (day/month/year).</p>
Time zone	<p>🏠 Home time zone can be specified and daylight saving time is enabled or disabled from time zone options. When the travel destination is set, the camera automatically calculates the time difference (🕒67) between the travel destination (➡️) and the home time (🏠) and saves images using the date and time of the travel destination. Useful when traveling.</p>

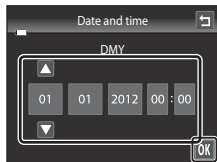

Selecting Travel Destination Time Zone

1 Tap **Time zone**.

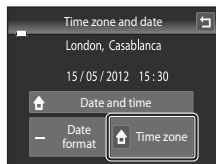

2 Tap ➡️ **Travel destination**.

- The date and time displayed in the monitor changes according to the region currently selected.

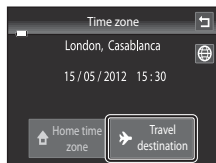



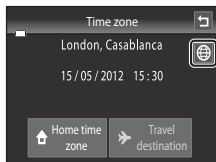

3 Tap .

- The time zone selection screen is displayed.



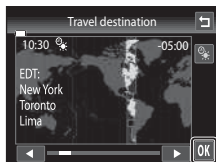

4 Tap or to choose the travel destination time zone and tap **OK**.

- If daylight saving time is in effect, tap  to enable daylight saving time function.  is displayed at the top of the monitor and the camera clock is advanced one hour. Tap  again to disable the daylight saving time function.
- While the travel destination time zone is selected, the  icon will be displayed in the monitor when the camera is in shooting mode.



Home Time Zone

- To switch to the home time zone, tap  **Home time zone** in step 2.
- To change the home time zone, tap  **Home time zone** in step 2 and perform the same procedure as for  **Travel destination** to set the home time zone.

Daylight Saving Time

When daylight saving time starts or ends, turn the daylight saving time option on or off from the time zone selection screen displayed in step 4.

Imprinting Date on images

Enable the **Print date** option () in the setup menu after the date and time have been set. When the **Print date** option is enabled, images will be recorded with shooting date imprinted on them.

Time Zones

The camera supports the time zones listed below.

For time zones not listed below, set the camera clock to local time from the **Date and time** option.

UTC +/-	Location	UTC +/-	Location
-11	Midway, Samoa	+1	Madrid, Paris, Berlin
-10	Hawaii, Tahiti	+2	Athens, Helsinki, Ankara
-9	Alaska, Anchorage	+3	Moscow, Nairobi, Riyadh, Kuwait, Manama
-8	PST (PDT): Los Angeles, Seattle, Vancouver	+4	Abu Dhabi, Dubai
-7	MST (MDT): Denver, Phoenix	+5	Islamabad, Karachi
-6	CST (CDT): Chicago, Houston, Mexico City	+5.5	New Delhi
-5	EST (EDT): New York, Toronto, Lima	+6	Colombo, Dhaka
-4.5	Caracas	+7	Bangkok, Jakarta
-4	Manaus	+8	Beijing, Hong Kong, Singapore
-3	Buenos Aires, Sao Paulo	+9	Tokyo, Seoul
-2	Fernando de Noronha	+10	Sydney, Guam
-1	Azores	+11	New Caledonia
±0	London, Casablanca	+12	Auckland, Fiji

Monitor Settings

Tap the **MENU** tab → Tap **Y** (Setup menu) → **Monitor settings**

Set the options below.

Option	Description
Photo info	Set the information displayed in the monitor during playback.
Image review	<ul style="list-style-type: none"> • On (default setting): Image is automatically displayed in the monitor immediately after it is taken and the monitor display returns to shooting mode. • Off: Image is not displayed after it is taken.
Brightness	Choose from five settings for monitor brightness. The default setting is 3 .

Photo Info

Select whether or not the photo information is displayed in the monitor.

See “Playback Mode (Information Display)” (📖8) for more information.

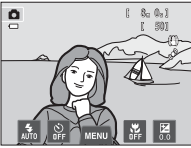
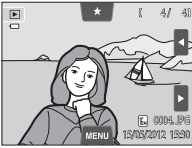
	Shooting mode	Playback mode
Show info		
Auto info (default setting)	<p>Current settings and operational guides are displayed as in Show info above. If no operations are performed for a few seconds, information is hidden. Information will be displayed again when the next operation is performed.</p> <p>During shooting, some of the control icons and shooting information are hidden if no operations are performed for a few seconds. They are displayed again when DISP is tapped.</p>	

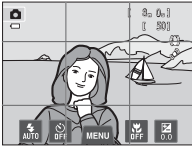
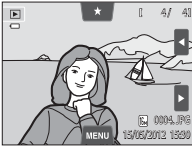
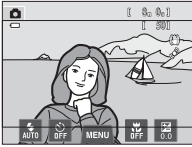

	Shooting mode	Playback mode
Framing grid+auto info	 <p>A framing grid is displayed as a reference for framing a picture. The grid is not displayed when recording movies.</p>	 <p>The current settings and operational guides are displayed, as in Auto info.</p>
Movie frm+auto info	 <p>When recording movies, a frame that represents the area that will be captured is displayed before recording begins. The frame is not displayed when the shutter release button is pressed halfway or while recording.</p>	<p>The current settings and operational guides are displayed, as in Auto info.</p>

DATE Print Date (Imprinting Date and Time)

Tap the **MENU** tab → Tap  (Setup menu) → **DATE** Print date





The shooting date and time can be imprinted on the images with shooting, allowing the information to be printed even from printers that do not support date printing (56).



Option	Description
 Date	Date is imprinted on the images.
 Date and time	Date and time are imprinted on the images.
Off (default setting)	Date and time are not imprinted on images.

The current print date setting can be confirmed in the camera monitor with shooting (6). When **Off** is selected, no icon is displayed.



Notes About Print Date

- Imprinted dates form a permanent part of image data and cannot be deleted. The date and time cannot be imprinted on pictures after they have been taken.
- The date is not imprinted in the following situations:
 - Pictures taken in **Panorama assist** scene mode
 - Movies
- Dates imprinted at an **Image mode** setting (64) of  **640×480** may be difficult to read. Choose an **Image mode** setting of  **1600×1200** or larger when using the **Print date** option.
- The date is recorded using the format selected in the setup menu's **Time zone and date** item (24, 65).

Print Date and Print Order

If using a DPOF-compatible printer that supports the printing of shooting date and photo information, it is possible to use the **Print order** option (53) to print such information even on pictures that were not taken using the **Print date** option.

Vibration Reduction

Tap the MENU tab → Tap  (Setup menu) →  Vibration reduction

Select the vibration reduction option for shooting.

Vibration reduction reduces blur, caused by slight hand movement known as camera shake, which commonly occurs when shooting with telephoto zoom applied or at slow shutter speeds. The effects of camera shake are reduced when recording movies, in addition to when taking still pictures. Set **Vibration reduction to Off** when using a tripod to stabilize the camera during shooting.



Option	Description
 On (default setting)	Lens-shift method vibration reduction reduces the effects of camera shake.
OFF Off	Vibration reduction is disabled.

The current vibration reduction setting can be confirmed in the camera monitor with shooting (6). When **Off** is selected, no icon is displayed.











Notes About Vibration Reduction

- Vibration reduction may take a few seconds to activate after the power is turned on, or the camera enters shooting mode from playback mode. Wait until the image of the monitor stabilizes before shooting.
- Due to characteristics of the vibration reduction function, images displayed in the camera's monitor immediately after shooting may be displayed blurry.
- Vibration reduction may be unable to completely eliminate the effects of camera shake in some situations.

Motion Detection

Tap the **MENU** tab → Tap  (Setup menu) →  Motion detection

Enable motion detection to reduce the effects of subject movement and camera shake when shooting still images.



Option	Description
Auto (default setting)	<p>When the camera detects the subject movement or camera shake, the ISO sensitivity and shutter speed are automatically increased to reduce blurring.</p> <p>However, motion detection does not function in the following situations:</p> <ul style="list-style-type: none"> • When the touch shooting setting is set to Subject tracking. • When the flash fires. • When ISO sensitivity ()42 is set to Fixed range auto, or ISO sensitivity is fixed at a particular value in  (auto) mode. • When Multi-shot 16 ()43 is selected. • When Sports ()44, Night portrait ()44, Dusk/dawn ()45, Night landscape ()46, Museum ()47, Fireworks show ()47, Backlighting ()48 or Pet portrait ()49 scene mode is enabled.
Off	Motion detection is not enabled.

The current motion detection setting can be confirmed in the camera monitor with shooting ()6). The motion detection icon turns green when the camera detects camera shake and increases shutter speed. When **Off** is selected, no icon is displayed.

Notes About Motion Detection

- Motion detection may be unable to completely eliminate the effects of subject movement and camera shake in some situations.
- Motion detection may not function if the subject exhibits significant movement or is too dark.
- The images captured using motion detection may be somewhat “grainy” in appearance.

AF Assist

Tap the MENU tab → Tap  (Setup menu) →  AF assist



Enable or disable AF-assist illumination, which assists autofocus operation when the subject is dimly lit.

Option	Description
Auto (default setting)	AF-assist illumination will be used to assist the focus operation when the subject is dimly lit. The illuminator has a range of about 1.9 m (6 ft 2 in.) at the maximum wide-angle position and about 1.1 m (3 ft 7 in.) at the maximum telephoto position. Note that for some scene modes or focus areas, AF-assist illuminator may not light up even when Auto is selected.
Off	AF-assist illuminator does not light up. The camera may be unable to focus under dim lighting.

Digital Zoom

Tap the MENU tab → Tap  (Setup menu) →  Digital zoom

Enable or disable digital zoom.

Option	Description
On (default setting)	When the camera is zoomed in to the maximum optical zoom position, rotating the zoom control to T () triggers digital zoom ( 29).
Off	Digital zoom will not be activated (except during movie recording).

Notes About Digital Zoom

- When digital zoom is in effect, the camera focuses at the center of the frame.
- Digital zoom cannot be used in the following situations.
 - When **Subject tracking** is selected for touch shooting.
 - When **Scene auto selector, Portrait, Night portrait,** or **Pet portrait** scene mode is selected.
 - When smart portrait mode is selected.
 - When **Multi-shot 16** (43) is selected.

Sound Settings

Tap the MENU tab → Tap  (Setup menu) →  Sound settings



Adjust the following sound settings.

Option	Description
Button sound	Select On (default setting) or Off . When On is selected, a beep will sound once when operations are completed successfully, twice when the camera acquires focus on the subject, and three times when an error is detected. Start-up sound will also play when the camera is turned on.
Shutter sound	Select On (default setting) or Off . No sound is played with shutter release when some features such as continuous shooting or BSS (Best Shot Selector) are enabled or recording movies, even if On is selected.

Note About Sound Settings

In **Pet portrait** scene mode, button and shutter sounds are disabled.



Auto Off

Tap the MENU tab → Tap  (Setup menu) →  Auto off

When the camera is on and a period of time passes without any operations having been performed, the monitor will be turned off and the camera will enter standby mode () to save power.

In this option, set the time allowed to elapse before the camera enters standby mode. **30 s**, **1 min** (default setting), **5 min**, and **30 min** can be selected.



When the Monitor Turns off for the Power Saving Function

- Power-on lamp flashes in standby mode.
- Camera turns off after approximately three minutes passes in standby mode.
- To reactivate the monitor while the power on lamp is flashing, press any of the following buttons:
 - The power switch, shutter-release button,  button, or  (movie-record) button

Auto Off Settings

- The time allowed to elapse before the camera enters standby mode is fixed in the following situations:
 - When a setting screen, mode selection menu, or the setup menu is displayed: three minutes
 - During slide show playback: up to 30 minutes
 - When the AC adapter EH-62G is connected: 30 minutes
- The camera does not enter standby mode when transferring images using an Eye-Fi card.

Format Memory/Format Card

Tap the **MENU** tab → Tap  (Setup menu) →  **Format memory**/ **Format card**

Use this option to format the internal memory or a memory card.

Formatting the internal memory or memory cards permanently deletes all data.

Deleted data cannot be recovered. Be sure to transfer important images to a computer before formatting.

Formatting the Internal Memory

To format the internal memory, remove the memory card from the camera.

The **Format memory** option is displayed in the setup menu.

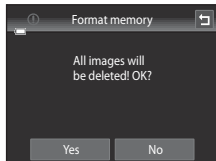

Formatting a Memory Card

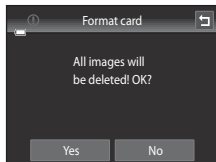

A memory card can be formatted when it is inserted in the camera. The **Format card** option is displayed in the setup menu.



Formatting Internal Memory and Memory Cards

- Formatting the internal memory or memory card restores album icon settings () to the default setting (displayed as number).
- Do not turn the camera off or open the battery-chamber/memory card slot cover during formatting.
- The first time you insert a memory card that has been used in another device into this camera, be sure to format it with this camera.

Language

Tap the **MENU** tab → Tap  (Setup menu) →  Language

Choose one of 29 languages for display of camera menus and messages.

Čeština	Czech
Dansk	Danish
Deutsch	German
English	(default setting)
Español	Spanish
Ελληνικά	Greek
Français	French
Indonesia	Indonesian
Italiano	Italian
Magyar	Hungarian
Nederlands	Dutch
Norsk	Norwegian
Polski	Polish
Português (BR)	Brazilian Portuguese
Português (PT)	Portuguese



Русский	Russian
Română	Romanian
Suomi	Finnish
Svenska	Swedish
Tiếng Việt	Vietnamese
Türkçe	Turkish
Українська	Ukrainian
عربي	Arabic
简体中文	Simplified Chinese
繁體中文	Traditional Chinese
日本語	Japanese
한글	Korean
ภาษาไทย	Thai
हिन्दी	Hindi

VIDEO Video Mode

Tap the **MENU** tab → Tap  (Setup menu) → **VIDEO** Video mode

Adjust video mode settings for connection to a television. Select from **NTSC** and **PAL**.

Charge by Computer

Tap the MENU tab → Tap  (Setup menu) →  Charge by computer



Choose whether or not the battery inserted into the camera is charged when the camera is connected to a computer via the USB cable.

Option	Description
Auto (default setting)	When the camera is connected to a computer that is running, the battery inserted into the camera is automatically charged using power supplied by the computer.
Off	The battery inserted into the camera is not charged when the camera is connected to a computer.

Notes About Connecting the Camera to a Printer

- The battery cannot be charged with connection to a printer, even if the printer complies with the PictBridge standard.
- When **Auto** is selected for **Charge by computer**, it may be impossible to print images with direct connection of the camera to some printers. If the **PictBridge** startup screen is not displayed in the monitor after the camera is connected to a printer and turned on, turn the camera off and disconnect the USB cable. Set **Charge by computer** to **Off** and reconnect the camera to the printer.

Notes About Charging with Connection to a Computer



- The battery cannot be charged, nor can data be transferred, when the camera is connected to a computer before the camera's display language and date and time have been set ( 24). If the camera's clock battery ( 25) has been exhausted, the date and time must be reset before the battery can be charged or images can be transferred with connection to a computer. In this case, use the Charging AC Adapter EH-69P ( 18) to charge the battery and then set the camera's date and time.
- If the camera is turned off, charging will also stop.
- If a computer enters sleep mode while charging, charging will stop and the camera may turn off.
- When disconnecting the camera from a computer, turn the camera off and then disconnect the USB cable.
- About 2 hours and 30 minutes are required to charge a fully exhausted battery. Charging time increases when images are transferred while the battery is charging.
- When the camera is connected to a computer, an application installed on the computer, such as Nikon Transfer 2, may start. If the camera was connected to the computer for the sole purpose of charging the battery, exit the application.
- The camera turns off automatically if there is no communication with the computer for 30 minutes after the battery has finished charging.
- Depending upon computer specifications, settings, and power supply and allocation, it may be impossible to charge the battery inserted into the camera via computer connection.

Charge Lamp

The following chart explains charge lamp status when the camera is connected to a computer.

Charge lamp	Description
Flashes slowly (green)	Battery charging.
Off	Battery not charging. If the charge lamp changes from slow flashing (green) to off while the power-on lamp is lit, charging is complete.
Flashes quickly (green)	<ul style="list-style-type: none"> The ambient temperature is not suited to charging. Charge the battery indoors with an ambient temperature of 5°C to 35°C (41°F to 95°F). A USB cable is not correctly connected or the battery is faulty. Reconnect the USB cable correctly or replace the battery. Computer is in sleep mode and does not supply power. Reboot the computer. The battery cannot be charged as computer's specifications or settings do not support power supply to the camera.

Blink Warning

Tap the MENU tab → Tap  (Setup menu) →  Blink warning

Specify whether or not the camera detects human subjects that have blinked when shooting with face detection (68) in the following modes.

-  (auto) mode (38).
- **Scene auto selector** (43), **Portrait** (43), or **Night portrait** (44) is selected for the scene mode.

Option	Description
On	When the camera detects that one or more human subjects may have blinked in an image captured using face detection, the Did someone blink? screen is displayed in the monitor. The face of the human subject that may have blinked when the shutter was released is framed by a yellow border. Should this occur, check the picture and determine whether or not another picture should be taken. See “Operating the Blink Warning Screen” ( 81) for more information.
Off (default setting)	Blink warning is not enabled.

Note About Blink Warning





The blink warning does not function at continuous settings of **Continuous**, **BSS**, or **Multi-shot 16**.

Operating the Blink Warning Screen

When the **Did someone blink?** screen is displayed in the monitor, the operations described below are available.

If no operations are performed within a few seconds, the camera automatically returns to shooting mode.



Function	Icon/Button	Description
Enlarge the detected face that blinked	T (Q)	Rotate the zoom control to T (Q). If the camera detects that more than one human subject blinked, tap  or  to switch display to another face.
Switch to full-frame playback	W (Q)	Rotate the zoom control to W (Q).
Delete the image		Tap  .
Switch to shooting mode	OK	Tap OK . The shutter-release button can also be pressed to return to shooting mode.

Eye-Fi Upload

Tap the MENU tab → Tap  (Setup menu) →  Eye-Fi upload





Option	Description
Enable	Upload images created by the camera to a preselected destination.
Disable (default setting)	Images will not be uploaded.

Notes About Eye-Fi Cards

- Note that images will not be uploaded if signal strength is insufficient even if **Enable** is selected.
- Select **Disable** where wireless devices are prohibited.
- Refer to the instruction manual of your Eye-Fi card for more information. In the event of malfunction, contact the card manufacturer.
- The camera can be used to turn Eye-Fi cards on and off, but may not support other Eye-Fi functions.
- The camera is not compatible with the endless memory function. When it is set on a computer, disable the function. If the endless memory function is enabled, the number of pictures taken may not be displayed correctly.
- Eye-Fi cards are for use only in the country of purchase. Observe all local laws concerning wireless devices.
- Leaving the setting as **Enable** will result in the battery being depleted in a shorter period of time.

Eye-Fi communication indicator

The communication status of the Eye-Fi card in the camera can be confirmed on the monitor (6).



- : **Eye-Fi upload** is set to **Disable**.
-  (lights): Eye-Fi upload enabled; waiting to begin upload.
-  (flashes): Eye-Fi upload enabled; uploading data.
- : Eye-Fi upload enabled but no images available for upload.
- : An error occurred. The camera cannot control the Eye-Fi card.

Supported Eye-Fi Cards

As of November 2011, the following Eye-Fi cards can be used. Be sure that the Eye-Fi card firmware has been updated to the latest version.





- Eye-Fi Connect X2 SDHC 4GB
- Eye-Fi Mobile X2 SDHC 8GB
- Eye-Fi Pro X2 SDHC 8GB

Reset All









Tap the MENU tab → Tap  (Setup menu) →  Reset all

When **Reset** is selected, the camera's settings will be restored to their default values.





Basic Shooting Functions

Option	Default value
Flash mode ( 55)	Auto
Self-timer ( 57)	Off
Macro mode ( 59)	Off
Exposure compensation ( 61)	0

Auto Mode Shooting Mode

Option	Default value
Image mode ( 64)	 4608×3456
Touch shooting ( 36,  38,  40)	Touch shutter
ISO sensitivity ( 42)	Auto
Continuous ( 43)	Single
White balance ( 44)	Auto

Scene Mode

Option	Default value
Scene mode setting in the shooting mode selection menu ( 41)	Scene auto selector
Scene effect adjustment slider ( 42)	Center
Continuous in pet portrait mode ( 49)	Continuous
Pet portrait auto release in pet portrait mode ( 49)	On



Special Effects Mode

Option	Default value
Special effects mode setting in the shooting mode selection menu ( 50)	Soft

Smart Portrait Mode

Option	Default value
Skin softening (🔍47)	Normal
Blink proof (🔍48)	Off
Smile timer (🔍48)	On

Movie Menu

Option	Default value
Movie options (🔍62)	When using a memory card:  HD 720p (1280x720) When using the internal memory:  VGA (640x480)
Movie AF mode (🔍62)	Single AF
Wind noise reduction (🔍63)	Off

Setup Menu

Option	Default value
Welcome screen (🔍64)	None
Photo info (🔍68)	Auto info
Image review (🔍68)	On
Brightness (🔍68)	3
Print date (🔍70)	Off
Vibration reduction (🔍71)	On
Motion detection (🔍72)	Auto
AF assist (🔍73)	Auto
Digital zoom (🔍73)	On
Button sound (🔍74)	On
Shutter sound (🔍74)	On
Auto off (🔍75)	1 min
Charge by computer (🔍78)	Auto
Blink warning (🔍80)	Off
Eye-Fi upload (🔍82)	Disable

Others

Option	Default value
Paper size (0031, 0032)	Default
Frame interval for slide show (0049)	3 s
Slide show effects (0049)	Classic

- Choosing **Reset all** also clears the current file number (0086) from memory. Numbering will continue from the lowest number available. To reset file numbering to "0001", delete all images (0034) stored in the internal memory or on the memory card before selecting **Reset all**.
- The following menu settings will remain unaffected when menus are reset with **Reset all**.
Shooting settings: Preset manual data (0045) acquired for **White balance**
Setup menu: **Time zone and date** (0065), **Language** (0077), and **Video mode** (0077)

Ver. Firmware Version

Tap the MENU tab → Tap  (Setup menu) → Ver. Firmware version

View the current camera firmware version.

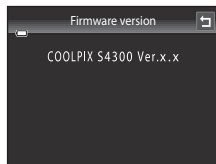

File and Folder Names

Images, movies, or voice memos are assigned file names as follows.

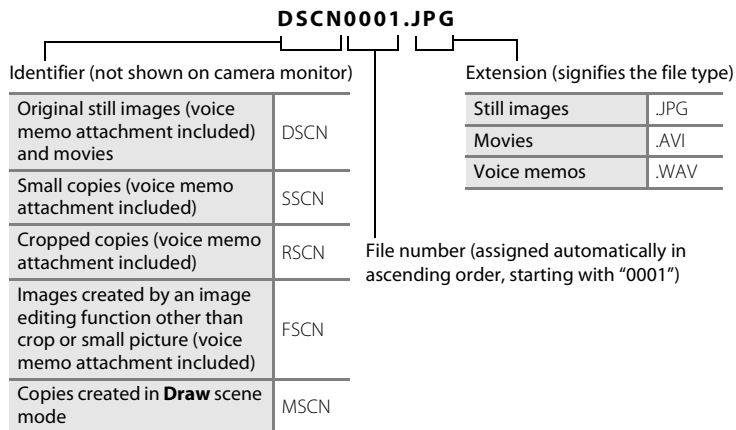

- Files are stored in folders named with a folder number followed by a five-character identifier: "P_" plus a three-digit sequence number for pictures taken using **Panorama assist** scene mode (e.g. "101P_001"; 03) and "NIKON" for all other images (e.g. "100NIKON"). When the number of files within a folder reaches 9999, a new folder will be created. File numbers will be assigned automatically starting with "0001."
- Voice memo file names have the same identifier and file number as the image to which the voice memo is attached.
- Files copied using **Copy>Selected images** are copied to the current folder, where they are assigned new file numbers in ascending order starting from the largest file number in memory. **Copy>All images** copies all folders from the source medium; file names do not change but new folder numbers are assigned in ascending order, starting from the largest folder number on the destination medium (60).
- A single folder can hold up to 200 files; if the current folder already contains 200 files, a new folder, named by adding one to the current folder name, will be created the next time a file is stored. If the current folder is numbered 999 and contains 200 files, or a file is numbered 9999, no further files can be stored until the internal memory or memory card is formatted (76), or a new memory card is inserted.

Optional Accessories

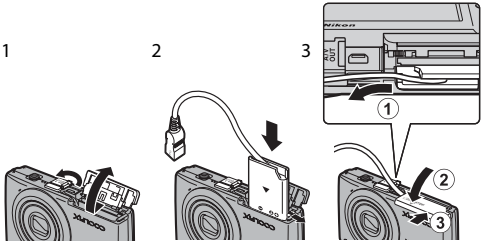



Rechargeable battery	Rechargeable Li-ion Battery EN-EL19 ¹
Charging AC Adapter	Charging AC Adapter EH-69P ^{1, 2}
Battery charger	Battery Charger MH-66 (Charging time when no charge remains: approx. 1 hours 50 minutes)
AC adapter	AC Adapter EH-62G (connect as shown)  <p>Be sure that the power connector cord has been properly aligned in power connector and battery chamber/memory card slot grooves before closing the battery-chamber/memory card slot cover. If part of the cord runs out of the grooves, the cover or cord may be damaged when the cover is closed.</p>
USB cable	USB Cable UC-E6 ¹
Audio/video cable	Audio Video Cable EG-CP14 ¹









¹ Included with the camera at the time of purchase (→  ii).

² When using in other countries, use a plug adapter (available commercially) as necessary. For more information about plug adapters, consult your travel agency.









Error Messages



The following table lists the error messages and other warnings displayed in the monitor, as well as the solutions for dealing with them.

Display	Cause/Solution	
 (flashes)	Clock not set. Set date and time.	 65
Battery exhausted.	Charge or change battery.	16, 18
Battery temperature high	Battery temperature is high. Turn off camera, and allow battery to cool down before resuming use. After five seconds, the monitor will turn off, and the power-on lamp will flash quickly. After the lamp flashes for three minutes, the camera will turn off automatically. Pressing the power switch also turns off the camera.	23
The camera will turn off to prevent overheating.	The camera has become hot. The camera turns off automatically. Leave the camera off until it has cooled and then turn it on again.	84
 ● (● flashes red)	Camera cannot focus. <ul style="list-style-type: none"> • Refocus. • Focus on another subject positioned at the same distance from the camera as the intended subject. 	30, 31 40
Please wait for the camera to finish recording.	Camera cannot perform other operations until saving is complete. Wait until message clears from display automatically when recording is complete.	–
Memory card is write protected.	Write-protect switch is in "lock" position. Slide write-protect switch to "write" position.	–
Not available if Eye-Fi card is locked.	Write-protect switch of Eye-Fi card is in "lock" position. Slide the write-protect switch to "write" position.	–
	Error accessing Eye-Fi card. <ul style="list-style-type: none"> • Use an approved card. • Check that connectors are clean. • Confirm that memory card is correctly inserted. 	 82 20 20

Display	Cause/Solution	
This card cannot be used.	Error accessing memory card.	
This card cannot be read.	<ul style="list-style-type: none"> • Use approved card. • Check that connectors are clean. • Confirm that memory card is correctly inserted. 	21 20 20
Card is not formatted. Format card? Yes No	Memory card has not been formatted for use in COOLPIX S4300. Formatting deletes all data stored on the memory card. If you need to keep copies of any images, make sure to tap No and save the copies to a computer or other medium before formatting the memory card. Tap Yes to format the memory card.	20
Out of memory.	Memory card is full. <ul style="list-style-type: none"> • Choose smaller image size. • Delete images. • Insert new memory card. • Remove memory card and use internal memory. 	64 34 20 21
Image cannot be saved.	Error occurred while recording image. Format internal memory or memory card.	 76
	Camera has run out of file numbers. Insert new memory card, or format internal memory or memory card.	22,  76,  86
	Image cannot be used for welcome screen. The following images cannot be registered as welcome screen. <ul style="list-style-type: none"> • Pictures taken at an Image mode setting of  4608x2592 • Images reduced to 320 x 240 size or smaller with cropping or small picture editing 	 64
	Insufficient space to save a copy. Delete images from destination.	34
Album is full. No further pictures can be added.	200 images have already been added to album. <ul style="list-style-type: none"> • Remove some images from album. • Add to other albums. 	 7  5
A blink was detected in the picture just taken.	One or more portrait subjects may have blinked when the picture was taken. Check the image in playback mode.	53,  48

Error Messages

Display	Cause/Solution	
Image cannot be modified.	Cannot edit selected image. <ul style="list-style-type: none"> • Select images that support editing function. • Movies cannot be edited. 	 12 –
Cannot record movie.	Time out error while recording movie. Choose memory card with faster write speed.	21, 83
Memory contains no images.	No images in the internal memory or memory card. <ul style="list-style-type: none"> • Remove the memory card from the camera to play back images stored in the camera's internal memory. • To copy image from internal memory to memory card, display the playback menu and select Copy. 	21  60
	The image has not been added to album. <ul style="list-style-type: none"> • Add the image to album. • Choose the album to which image was added. 	 5  6
	No images are contained in the category selected in auto sort mode. Select the category containing the sorted images.	 9
File contains no image data.	File not created with COOLPIX S4300. File cannot be viewed on COOLPIX S4300. View file using a computer or the device used to create or edit this file.	–
This file cannot be played back.		
All images are hidden.	No images are available for a slide show.	 49
This image cannot be deleted.	Image is protected. Disable protection.	 51
Travel destination is in the current time zone.	Destination in same time zone as home.	 67
Rating maximum reached. No further pictures can be rated.	999 pictures have already been rated. Cancel the rating setting of them.	74

Display	Cause/Solution	
No images with this rating found.	There are no images with the selected rating. <ul style="list-style-type: none"> • Apply the rating to images. • Select a rating that has been applied to images. 	74
Lens error	The lens is not working properly. Turn camera off and then on again. If error persists, contact retailer or Nikon-authorized service representative.	22, 23
Communications error	Error occurred during communication with printer. Turn camera off and reconnect USB cable.	 30
System error	Error has occurred in camera's internal circuitry. Turn camera off, remove and reinsert battery, and turn camera on. If error persists, contact retailer or Nikon-authorized service representative.	17
Printer error: check printer status.	An error occurred with the printer. Check printer. After solving the problem, tap Resume to resume printing.*	–
Printer error: check paper	Specified size of paper is not loaded in printer. Load the specified paper, tap Resume to resume printing.*	–
Printer error: paper jam	Paper has jammed in printer. Eject the jammed paper, tap Resume to resume printing.*	–
Printer error: out of paper	No paper is loaded in printer. Load the specified paper, tap Resume to resume printing.*	–
Printer error: check ink	An error occurred with the ink. Check ink, tap Resume to resume printing.*	–
Printer error: out of ink	Running out of ink or ink cartridge is empty. Replace ink cartridge, tap Resume to resume printing.*	–
Printer error: file corrupt	An error occurred with the image file to be printed. Tap Cancel to cancel printing.	–

* See the documentation provided with your printer for further guidance and information.



A series of horizontal dashed lines for handwriting practice, spanning the width of the page.



Technical Notes and Index

Maximizing Camera Life and Performance	2
The Camera.....	2
The Battery.....	3
Charging AC Adapter.....	4
Memory Cards.....	4
Cleaning and Storage	5
Cleaning.....	5
Storage.....	5
Troubleshooting	6
Specifications.....	13
Supported Standards.....	16
Index	17

Maximizing Camera Life and Performance

To ensure continued enjoyment of this Nikon product, observe the precautions described below in addition to the warnings in “For Your Safety” (📖vi) when using or storing the device.

The Camera

✔ **Keep Dry**

The device will be damaged if immersed in water or subjected to high humidity.

✔ **Do Not Drop**

The product may malfunction if subjected to strong shock or vibration.

✔ **Handle the Lens and All Moving Parts with Care**

Do not apply force to the lens, lens cover, monitor, memory card slot or battery chamber. These parts are easily damaged. Applying force to the lens cover could result in camera malfunction or damage to the lens. Should the monitor break, care should be taken to avoid injury caused by broken glass and to prevent the liquid crystal from the display touching the skin or entering the eyes or mouth.

✔ **Do Not Point the Lens at Strong Light Sources for Extended Periods**

Avoid pointing the lens at the sun or other strong light sources for extended periods when using or storing the camera. Intense light may cause deterioration of the CCD image sensor, producing a white blur effect in photographs.

✔ **Keep Away from Strong Magnetic Fields**

Do not use or store this device in the vicinity of equipment that generates strong electromagnetic radiation or magnetic fields. Strong static charge or the magnetic fields produced by equipment such as radio transmitters could interfere with the monitor, damage data stored on the memory card, or affect the product’s internal circuitry.

✔ **Avoid Sudden Changes in Temperature**

Sudden changes in temperature, such as when entering or leaving a heated building on a cold day, can cause condensation to form inside the device. To prevent condensation, place the device in a carrying case or a plastic bag before exposing it to sudden changes in temperature.

✔ **Turn the Product Off Before Removing or Disconnecting the Power Source or Memory Card**

Do not remove the battery while the product is on, or while images are being recorded or deleted. Forcibly cutting power in these circumstances could result in loss of data or in damage to product memory or internal circuitry.

 **Notes on Monitors**

- Monitors and electronic viewfinders are constructed with extremely high precision; at least 99.99% of pixels are effective, with no more than 0.01% being missing or defective. Hence while these displays may contain pixels that are always lit (white, red, blue, or green) or always off (black), this is not a malfunction and has no effect on images recorded with the device.
- White or colored streaks may be visible when bright subjects are framed in the monitor. This phenomenon, known as “smear,” occurs when extremely bright light strikes the image sensor; it is characteristic of image sensors and does not indicate a malfunction. Smear may also take the form of partial discoloration in the monitor during shooting. It does not appear in images recorded with the camera except in the cases of movies and of images recorded with **Multi-shot 16** selected for **Continuous**. When shooting in these modes, we recommend that you avoid bright subjects such as the sun, reflected sunlight, and electric lights.
- Images in the monitor may be difficult to see under bright lighting.
- The monitor is lit by an LED backlight. Should the monitor begin to dim or flicker, contact your Nikon-authorized service representative.

The Battery

- Check the battery level before using the camera and replace or charge the battery if necessary. Do not continue charging once the battery is fully charged as this will result in reduced battery performance. Whenever possible, carry a fully charged spare battery when taking pictures on important occasions.
- Do not use the battery at ambient temperatures below 0°C (32°F) or above 40°C (104°F).
- Charge the battery indoors with an ambient temperature of 5°C to 35°C (41°F to 95°F) before use.
- When charging the battery inserted into the COOLPIX S4300 using the Charging AC Adapter EH-69P or a computer, the battery is not charged at battery temperatures below 0°C (32°F) or above 45°C (113°F)
- Note that the battery may become hot during use; wait for the battery to cool before charging. Failure to observe these precautions could damage the battery, impair its performance, or prevent it from charging normally.
- On cold days, the capacity of batteries tends to decrease. Be sure that the battery is fully charged before heading outside to take pictures in cold weather. Keep spare batteries in a warm place and exchange as necessary. Once warmed, a cold battery may recover some of its charge.
- Dirt on the battery terminals can prevent the camera from functioning. Should the battery terminals become dirty, wipe them off with a clean, dry cloth before use.
- If the battery will not be used for some time, insert it in the camera and completely exhaust before removing it for storage. The battery should be stored in a cool location with an ambient temperature of 15°C to 25°C (59°F to 77°F). Do not store the battery in hot or extremely cold locations.
- Always remove the battery from the camera or optional battery charger when it is not being used. When inserted, minute amounts of current flow even when unused, and the battery may become excessively drained and no longer function. Turning the camera on or off while the battery is exhausted can result in reduced battery life.
- Recharge the battery at least once every six months and completely exhaust it before returning it to storage.
- After removing the battery from the camera or optional battery charger, return the battery to the battery case and store in a cool place.

Maximizing Camera Life and Performance

- A marked drop in the time a fully-charged battery retains its charge, when used at room temperature, indicates that the battery needs to be replaced. Purchase a new EN-EL19 battery.
- Replace the battery when it no longer holds a charge. Used batteries are a valuable resource. Please recycle used batteries in accordance with local regulations.

Charging AC Adapter

- The Charging AC Adapter EH-69P is for use only with compatible devices. Do not use with another make or model of device.
- The EH-69P is compatible with AC 100-240 V, 50/60 Hz electrical outlets. When using in other countries, use a plug adapter (available commercially) as necessary. For more information about plug adapters, consult your travel agency.
- Do not, under any circumstances, use another make or model of AC adapter other than Charging AC Adapter EH-69P or USB-AC adapter. Failure to observe this precaution could result in overheating or in damage to the camera.

Memory Cards

- Use only Secure Digital memory cards. See “Approved Memory Cards” (📖21) for more information about memory cards.
- Observe the precautions noted in the documentation included with your memory card.
- Do not affix labels or stickers to the memory card.
- When you use memory cards that have been used with other devices for the first time, be sure to format them with this camera. We recommend formatting new memory cards with this camera before using them with this camera.
- Note that **formatting permanently deletes all images and other data on the memory card**. Be sure to make copies of any images you wish to keep before formatting the memory card.
- If the message **Card is not formatted. Format card?** is displayed when the camera is turned on, the memory card must be formatted. If there is data that you do not want to delete, tap **No**. Copy the necessary data to a computer, etc. If you want to format the card, tap **Yes**. The confirmation dialog will be displayed. To start formatting, tap **OK**.
- Do not perform the following during formatting, while data is being written to or deleted from the memory card, or during data transfer to a computer. Failure to observe this precaution could result in the loss of data or in damage to the camera or memory card:
 - Open the battery-chamber/memory card slot cover to remove/insert the battery or memory card.
 - Turn off the camera.
 - Disconnect the AC adapter.
- Do not format the memory card using a computer.

Cleaning and Storage

Cleaning

Do not use alcohol, thinner, or other volatile chemicals.

Lens	Avoid touching glass parts with your fingers. Remove dust or lint with a blower (typically a small device with a rubber bulb attached to one end that is pumped to produce a stream of air out the other end). To remove fingerprints or other stains that cannot be removed with a blower, wipe the lens with a soft cloth, using a spiral motion that starts at the center of the lens and working toward the edges. If this fails, clean the lens using a cloth lightly dampened with commercial lens cleaner.
Monitor	Remove dust or lint with a blower. To remove fingerprints and other stains, clean the monitor with a soft, dry cloth, being careful not to apply pressure.
Body	Use a blower to remove dust, dirt or sand, then wipe gently with a soft, dry cloth. After using the camera at the beach or other sandy or dusty environment, wipe off any sand, dust, or salt with a dry cloth lightly dampened with fresh water and dry thoroughly. Note that foreign matter inside the camera could cause damage not covered by the warranty.

Storage

Turn the camera off when not in use. Be sure that the power-on lamp is off before putting the camera away. Remove the battery if the camera will not be used for an extended period. Do not store the camera with naphtha or camphor moth balls, or in any of the following locations:

- Next to equipment that produces strong electromagnetic fields, such as televisions or radios
- Exposed to temperatures below -10°C (14°F) or above 50°C (122°F)
- Places that are poorly ventilated or subject to humidity of over 60%









To prevent mold or mildew, take the camera out of storage at least once a month. Turn the camera on and release the shutter a few times before putting the camera away again.













- For storing the battery, follow the precautions in “The Battery” (🔋 3) in “Maximizing Camera Life and Performance”.

Troubleshooting

If the camera fails to function as expected, check the list of common problems below before consulting your retailer or Nikon-authorized service representative.

Display, Settings and Power Supply

Problem	Cause/Solution	
Battery inserted in the camera cannot be charged.	<ul style="list-style-type: none">• Confirm all plugs.• Off is selected for Charge by computer in the setup menu.• When charging by connecting the camera to a computer, battery charging stops when the camera is turned off.• When charging by connecting the camera to a computer, battery charging stops if the computer is suspended (sleeping), and the camera may turn off.• Depending upon computer specifications, settings, and status, charging the battery inserted in the camera may not be possible via computer connection.	18 90,  78 90,  78 90,  78 —
Camera cannot be turned on.	<ul style="list-style-type: none">• Battery is exhausted.• The camera cannot be turned on while connected to an electrical outlet via the Charging AC Adapter.	22 18
Camera turns off without warning.	<ul style="list-style-type: none">• Battery is exhausted.• The camera automatically turns off to save power if no operations are performed for an extended period of time• The camera and battery may not work properly at low temperatures. • The camera turns off if the Charging AC Adapter is connected while the camera is on.• The camera turns off if the USB cable connecting it to a computer or printer is disconnected. Reconnect the USB cable.• The internal temperature of the camera is high. Leave the camera off until it has cooled and then turn it on again.	22  75  3 18 76, 79,  30 —







Problem	Cause/Solution	
Monitor is blank.	<ul style="list-style-type: none"> • Camera is off. • Standby mode for saving power: press the power switch, the shutter-release button,  button,  button, or  button. • When flash lamp flashes, wait until flash has charged. • Camera and computer are connected via USB cable. • Camera and TV are connected via audio/video cable. 	23 23,  75 55 76, 79 76,  27
Monitor is hard to read.	<ul style="list-style-type: none"> • Adjust monitor brightness. • Monitor is dirty. Clean monitor. 	88,  68  5
Date and time of recording are not correct.	<ul style="list-style-type: none"> • If camera clock has not been set, “Date not set” indicator flashes during shooting and movie recording. Images and movies recorded before clock is set are dated “00/00/0000 00:00” or “01/01/2012 00:00” respectively. Set the correct time and date from the Time zone and date option in the setup menu. • The camera clock is not as accurate as ordinary watches or clocks. Periodically compare the time of the camera clock with that of a more accurate timepiece and reset as required. 	24,  65 25,  65
No indicators displayed in monitor.	Auto info is selected for Photo info in Monitor settings in the setup menu.	88,  68
Print date not available.	Camera clock has not been set.	24,  65
Date not appearing on images even when Print date is enabled.	<ul style="list-style-type: none"> • The current shooting mode is one that does not support Print date. • Date cannot be imprinted on movies. 	88,  70
Time zone and date setting screen appears when the camera is turned on.	Clock battery is exhausted; all settings were restored to their default values.	24, 25
Camera settings reset.		
Monitor turns off, and the power-on lamp flashes quickly.	Battery temperature is high. Turn off camera and allow battery to cool down before resuming use. After the lamp flashes for three minutes, the camera will turn off automatically. Pressing the power switch also turns off the camera.	23













Problem	Cause/Solution	
Camera becomes hot.	The camera may become hot when used for an extended period of time to shoot movies or send images using an Eye-Fi card, or when used in a hot environment; this is not a malfunction.	84

Electronically Controlled Cameras













In extremely rare instances, unusual characters may appear in the monitor and the camera may stop functioning. In most cases, this phenomenon is caused by a strong external static charge. Turn the camera off, remove and reinsert the battery, then turn the camera on again. In the event of continued malfunction, contact your retailer or Nikon-authorized service representative. Note that disconnecting the power source as described above may result in the loss of any data not recorded to internal memory or the memory card at the time the problem occurred. Data already recorded will not be affected.

Shooting







Problem	Cause/Solution	
No picture taken.	<ul style="list-style-type: none"> When camera is in playback mode, or setting items or the setup menu are displayed, press the shutter-release button. 	32
	<ul style="list-style-type: none"> Battery is exhausted. 	22
	<ul style="list-style-type: none"> When flash lamp flashes, flash is charging. 	55
Camera cannot focus.	<ul style="list-style-type: none"> The subject is too close to the camera. Try shooting using macro mode, or Scene auto selector or Close-up scene mode. 	41, 59
	<ul style="list-style-type: none"> The intended subject is one with which autofocus does not perform well. Set AF assist in the setup menu to Auto. Turn camera off and then on again. 	31 89,  73 23
Images are blurred.	<ul style="list-style-type: none"> Use flash. Increase the ISO sensitivity value. Enable vibration reduction or motion detection. Use BSS (Best Shot Selector). Use a tripod to stabilize the camera when shooting (using the self-timer at the same time is more effective). 	55 39,  42 89,  71,  72 39, 47,  43 57

Problem	Cause/Solution	
Streaks of light or partial discoloration are visible in the monitor.	Smear may occur when extremely bright light strikes the image sensor. When shooting with Continuous set to Multi-shot 16 and when recording movies, avoiding bright objects, such as the sun, reflections of the sun, and electric lights is recommended.	 3
Bright specks appear in pictures taken with flash.	Flash is reflecting off particles in air. Set the flash mode setting to  (Off).	56
Flash does not fire.	<ul style="list-style-type: none"> • The flash mode is set to  (Off). • Scene mode with which the flash does not function is selected. • On is selected for Blink proof in smart portrait mode. • Another function that restricts flash is enabled. 	56 56 53,  48 66
Optical zoom cannot be used.	Optical zoom cannot be used while recording movies.	83
Digital zoom cannot be used.	<ul style="list-style-type: none"> • Digital zoom is set to Off in the setup menu. • Digital zoom is not available in the following situations. <ul style="list-style-type: none"> - Subject tracking is selected for the touch shooting setting. - When Scene auto selector, Portrait, Night portrait, or Pet portrait scene mode is selected. - When shooting in smart portrait mode - When Continuous is set to Multi-shot 16. 	89,  73 39,  38 43, 44, 49 51 39,  43
Image mode not available.	Another function that restricts the Image mode option is enabled.	66
No sound when shutter is released.	<ul style="list-style-type: none"> • Off is selected for Sound settings>Shutter sound in setup menu. No sound is heard with some shooting modes and settings, even when On is selected. • The speaker is being blocked. Do not cover the speaker. 	89,  74 3, 28
AF-assist illuminator does not light up.	Off is selected for the AF assist option in the setup menu. AF-assist illuminator may not light up depending on the position of the focus area or the current scene mode, even when Auto is selected.	89,  73
Images appear smeared.	Lens is dirty. Clean lens.	 5
Colors are unnatural.	White balance does not match light source.	39,  44







Troubleshooting

Problem	Cause/Solution	
Randomly spaced bright pixels (“noise”) appear in image.	Shutter speed too slow or ISO sensitivity is high as the subject is dark. Noise can be reduced by: <ul style="list-style-type: none"> • Using flash. • Specifying a lower ISO sensitivity setting. 	55 39,  42
Randomly spaced bright pixels (“noise”) appear in movies.	When recording movies in dim lighting, the image may become somewhat “grainy” in appearance. This occurs when the ISO sensitivity increases, and it does not indicate a malfunction.	–
Images are too dark (underexposed).	<ul style="list-style-type: none"> • The flash mode is set to  (Off) • Flash window is blocked. • Subject is beyond flash range. • Adjust exposure compensation. • Increase ISO sensitivity. • Subject is backlit. Select Backlighting scene mode or set the flash mode setting to  (Fill flash). 	56 28 55 61 39,  42 48, 55
Images are too bright (overexposed).	Adjust exposure compensation.	61
Unexpected results when flash set to  (Auto with red-eye reduction).	When taking pictures with  (Auto with red-eye reduction) or fill flash with slow sync and red-eye reduction in Night portrait scene mode, In-Camera Red-Eye Fix may be applied to areas not affected by red-eye. Use any scene mode other than Night portrait , and change the flash mode to any setting other than  (Auto with red-eye reduction) and try shooting again.	44, 55
Skin tones are not softened.	<ul style="list-style-type: none"> • Under some shooting conditions, facial skin tones may not be softened. • Select  (Skin softening) for Glamour retouch in the retouch menu for images containing four or more faces. 	70 70,  23
Saving images takes time.	It may take more time to save images in the following situations. <ul style="list-style-type: none"> • When the noise reduction function is in operation. • When flash mode is set to  (Auto with red-eye reduction). • When the skin softening function is applied while shooting. 	– 56 43, 44, 70,  47
Colored circles or light streaks appear in the monitor or images.	When shooting with backlighting or when a very strong light source (such as sunlight) is in the frame, colored circles or light streaks (ghosting) may occur. Change the position of the light source, or frame the picture so that the light source does not enter the frame and try again.	–

Playback

Problem	Cause/Solution	
File cannot be played back.	<ul style="list-style-type: none"> File or folder was overwritten or renamed by computer or other make of camera. The COOLPIX S4300 is not able to playback movies recorded with another make or model of digital camera. 	– 86
Cannot zoom in on image.	<ul style="list-style-type: none"> Pictures taken with cameras other than COOLPIX S4300 may not be enlarged. Playback zoom cannot be used with movies, small pictures, or images that have been cropped to a size of 320 × 240 or smaller. 	–
Cannot record or play back voice memos.	<ul style="list-style-type: none"> Voice memos cannot be attached to movies. Voice memos cannot be attached to images taken with other cameras. Voice memos attached to images using another camera cannot be played back on this camera. 	86 75,  59
Cannot edit images.	<ul style="list-style-type: none"> These options cannot be used with movies. These options cannot be used with pictures taken at an Image mode setting of  4608×2592. Select images that support editing functions. Camera is unable to edit pictures taken with other cameras. 	86 64, 75 75,  12 75,  12
Images not displayed on television.	<ul style="list-style-type: none"> Choose correct Video mode. Memory card contains no images. Replace the memory card. Remove the memory card to play back pictures from the internal memory. TV display is turned off and images are displayed in the camera monitor. 	90,  77 20 90,  28
Album icon restored to default settings, or images added to album not displayed in favorite pictures mode.	Data on the memory card may not be played back correctly if overwritten by a computer.	–

Troubleshooting

Problem	Cause/Solution	
<p>The recorded images are not displayed in auto sort mode.</p>	<ul style="list-style-type: none"> • The desired image was sorted into a category other than the category currently displayed. • Images recorded by a camera other than the COOLPIX S4300 and images copied using the Copy option cannot be displayed in auto sort mode. • Images recorded in the internal memory or on the memory card may not be played back correctly if overwritten by a computer. • Up to 999 images or movies in total can be added to each category. If the desired category already contains 999 images or movies in total, new images or movies cannot be added. 	<p>72, 9</p> <p>75, 60</p> <p>–</p> <p>10</p>
<p>Nikon Transfer 2 does not start when camera is connected.</p>	<ul style="list-style-type: none"> • Camera is off. • Battery is exhausted. • USB cable is not correctly connected. • Camera is not recognized by the computer. • Confirm system requirements. • Computer is not set to start Nikon Transfer 2 automatically. For more information on Nikon Transfer 2, refer to help information contained in ViewNX 2. 	<p>23</p> <p>22</p> <p>76, 79</p> <p>–</p> <p>77</p> <p>80</p>
<p>The PictBridge startup screen is not displayed when the camera is connected to a printer.</p>	<p>With some PictBridge-compatible printers, the PictBridge startup screen may not be displayed and it may be impossible to print images when Auto is selected for the Charge by computer option in the setup menu. Set the Charge by computer option to Off and reconnect the camera to the printer.</p>	<p>90, 78</p>
<p>Images to be printed are not displayed.</p>	<ul style="list-style-type: none"> • Memory card contains no images. Replace the memory card. • Remove the memory card to print images from the internal memory. 	<p>20</p> <p>21</p>
<p>Cannot select paper size with camera.</p>	<p>Paper size cannot be selected from the camera in the following situations, even when printing from a PictBridge-compatible printer. Select paper size from the printer.</p> <ul style="list-style-type: none"> • The printer does not support the paper size specified by the camera. • The printer automatically selects the paper size. 	<p>31,</p> <p>32</p> <p>–</p>

Specifications

Nikon COOLPIX S4300 Digital Camera

Type	Compact digital camera
Effective pixels	16.0 million
Image sensor	1/2.3-in. type CCD; total pixels: approx. 16.44 million
Lens	6x optical zoom, NIKKOR lens
Focal length	4.6–27.6mm (angle of view equivalent to that of 26–156 mm lens in 35mm [135] format)
f/-number	f/3.5–6.5
Construction	5 elements in 5 groups
Digital zoom	Up to 4x (angle of view equivalent to that of approx. 624 mm lens in 35mm [135] format)
Vibration reduction	Lens shift
Autofocus (AF)	Contrast-detect AF
Focus range (from lens)	<ul style="list-style-type: none">• [W]: Approx. 50 cm (1 ft 8 in.) to ∞• [T]: Approx. 1.0 m (3 ft 4 in.) to ∞• Macro mode: Approx. 5 cm (2 in.) (wide-angle position) to ∞
Focus-area selection	Face priority, auto (9-area automatic selection), center, manual (focus area can be selected using the touch panel), subject tracking
Monitor	7.5-cm (3-in.), approx. 460k-dot, TFT LCD (touch panel) with antireflection coating, and 5-level brightness adjustment
Frame coverage (shooting mode)	Approx. 98% horizontal and 98% vertical (compared to actual image)
Frame coverage (playback mode)	Approx. 100% horizontal and 100% vertical (compared to actual image)
Storage	
Media	<ul style="list-style-type: none">• Internal memory (approx. 74 MB)• SD/SDHC/SDXC memory card
File system	DCF, Exif 2.3, and DPOF compliant
File formats	Still images: JPEG Sound files (Voice Memo): WAV Movies: AVI (Motion-JPEG compliant)
Image size (pixels)	<ul style="list-style-type: none">• 16M (High image quality) [4608 × 3456 ★]• 16M [4608 × 3456]• 8M [3264 × 2448]• 4M [2272 × 1704]• 2M [1600 × 1200]• VGA [640 × 480]• 16:9 [4608 × 2592]

Specifications

ISO sensitivity (Standard output sensitivity)	<ul style="list-style-type: none">• ISO 80, 100, 200, 400, 800, 1600, 3200• Auto (auto gain from ISO 80 to 1600)• Fixed range auto (ISO 80 to 400, 80 to 800)
Exposure	
Metering	256-segment matrix, center-weighted (digital zoom less than 2x), spot (digital zoom 2x or more)
Exposure control	Programmed auto exposure with motion detection and exposure compensation (-2.0 to +2.0 EV in steps of 1/3 EV)
Shutter	Mechanical and charge-coupled electronic shutter
Speed	1/2000–1 s 4 s (when scene mode is set to Fireworks show)
Aperture	Electronically-controlled ND filter (-3.3 AV) selection
Range	2 steps (f/3.5 and f/11.5 [W])
Self-timer	Can be selected from 10 and 2 second duration
Built-in flash	
Range (approx.) (ISO sensitivity: Auto)	[W]: 0.5 to 4.5 m (1 ft 8 in. to 14 ft) [T]: 0.5 to 2.4 m (1 ft 8 in. to 7 ft 10 in.)
Flash control	TTL auto flash with monitor preflashes
Interface	Hi-Speed USB
Data Transfer Protocol	MTP, PTP
Video output	Can be selected from NTSC and PAL
I/O terminal	Audio video output/digital I/O (USB)
Supported languages	Arabic, Chinese (Simplified and Traditional), Czech, Danish, Dutch, English, Finnish, French, German, Greek, Hindi, Hungarian, Indonesian, Italian, Japanese, Korean, Norwegian, Polish, Portuguese (European and Brazilian), Romanian, Russian, Spanish, Swedish, Thai, Turkish, Ukrainian, Vietnamese
Power sources	One Rechargeable Li-ion Battery EN-EL19 (included) AC Adapter EH-62G (available separately)
Charging time	Approx. 2 hours and 30 minutes (when using Charging AC Adapter EH-69P and when no charge remains)
Battery life (EN-EL19)	Still images*: Approx. 180 shots Movies: Approx. 1 h 15 min (HD 720p (1280x720)). (Each movie is limited to a file size of 2 GB and a movie length of 29 minutes, even when there is sufficient free space on the memory card for longer recording.)
Tripod socket	1/4 (ISO 1222)
Dimensions (W x H x D)	Approx. 95.5 x 58.9 x 20.8 mm (3.8 x 2.4 x 0.9 in.) (excluding projections)

Weight	Approx. 139 g (5.0 oz) (with battery and SD memory card)
Operating environment	
Temperature	0°C to 40°C (32°F to 104°F)
Humidity	Less than 85% (no condensation)

- Unless otherwise stated, all figures are for a camera with a fully-charged Rechargeable Li-ion Battery EN-EL19 operated at an ambient temperature of 25°C (77°F).

* Based on Camera and Imaging Products Association (CIPA) standards for measuring the life of camera batteries. Measured at 23 (±2) °C (73 (±4) °F); zoom adjusted with each shot, flash fired with every other shot, image mode set to  **4608×3456**. Battery life may vary depending on shooting interval and length of time menus and images are displayed.

Rechargeable Li-ion Battery EN-EL19

Type	Rechargeable lithium-ion battery
Rated capacity	DC 3.7 V, 700 mAh
Operating temperature	0°C to 40°C (32°F to 104°F)
Dimensions (W × H × D)	Approx. 31.5 × 39.5 × 6 mm (1.3 × 1.6 × 0.3 in.) (excluding projections)
Weight	Approx. 14.5 g (0.5 oz) (excluding battery case)

Charging AC Adapter EH-69P

Rated input	AC 100–240 V, 50/60 Hz, 0.068–0.042 A
Rated output	DC 5.0 V, 550 mA
Operating temperature	0°C to 40°C (32°F to 104°F)
Dimensions (W × H × D)	Approx. 55 × 22 × 54 mm (2.2 × 0.9 × 2.2 in.) (excluding plug adapter) For Argentina: Approx. 55 × 59 × 63 mm (2.2 × 2.4 × 2.5 in.) For Korea: Approx. 55 × 59 × 66.5 mm (2.2 × 2.4 × 2.7 in.)
Weight	Approx. 55 g (2.0 oz) (excluding plug adapter) For Argentina and Korea: Approx. 80 g (2.9 oz)

Specifications































Nikon will not be held liable for any errors this manual may contain. The appearance of this product and its specifications are subject to change without notice.

Supported Standards











- **DCF:** Design Rule for Camera File System is a standard widely used in the digital camera industry to ensure compatibility among different makes of camera.
- **DPOF:** Digital Print Order Format is an industry-wide standard that allows images to be printed from print orders stored on memory card.
- **Exif version 2.3:** This camera supports Exchangeable image file format (Exif) version 2.3 for digital still cameras, a standard that allows information stored with photographs to be used for optimal color reproduction when images are output from Exif-compliant printers.
- **PictBridge:** A standard developed cooperatively by the digital camera and printer industries, allowing photographs to be output directly to a printer without connecting the camera to a computer.

Index









Symbols

-  Auto mode 22, 26, 38
-  Scene mode 41
-  Special effects mode 50
-  Smart portrait mode 51
-  Playback mode 32, 72
-  Favorite pictures mode 72, 
-  Auto sort mode 72, 
-  List by date mode 72, 
-  Setup menu 88, 
- T** (Telephoto) 2, 29
- W** (Wide-angle) 2, 29
-  Playback zoom 2, 33
-  Thumbnail playback 2, 33
-  Shooting mode button 3, 10, 26
-  Playback button 3, 10, 32
-  (🎬 movie-record) button 3, 82
- MENU** Menu tab 11, 12
-  Exit icon 11
-  Return icon 12
- AE/AF-L** 
- A**
- AC adapter 19, 
- AF area 6, 30, 68
- AF assist 89, 
- Album 72, 
 - adding images to 75, 
 - removing images from 75, 
- Aperture 30
- Audio/video cable 76, 
- Audio/video-in jack 76, 
- Auto flash 56
- Auto off 89, 
- Auto shooting menu 39
- Autofocus 60
- AVI 







B

- Back light  48
- Battery ii, 16, 18, 25, 
- Battery chamber 3
- Battery charger 19, 
- Battery latch 3, 16
- Battery level 22
- Battery-chamber/memory card slot cover 3, 16, 20
- Beach  45
- Black and white copy  47
- Blink proof 53, 
- Blink warning 90, 
- Brightness 88, 
- BSS (Best Shot Selector) 39, 47, 
- Built-in microphone 2
- Button sound 89, 

C

- Charge by computer 90, 
- Charge lamp 19, 
- Charging AC Adapter ii, 18, 
- Close-up  46
- Cloudy 
- Compression ratio 64
- Computer 76, 79
- Connector cover 3
- Continuous 39, 
- Copying images 75, 
- Crop 33, 

D

- Date format 24, 88, 
- Daylight 
- Daylight saving time 25, 88, 
- Delete 34, 
- Digital zoom 29, 89, 
- Direct print 76, 
- D-Lighting 75, 



Index

DPOF  16

DPOF print  34

Drag 4

Drag and drop 4

Draw  47,  82

DSCN  86

Dusk/dawn  45

E

EH-69P ii, 18,  87

EN-EL19 ii, 16, 18,  87

Exposure compensation 61

Extension  86

Eye-Fi upload 90,  82

Eyelet for camera strap 2

E

Face detection 28, 68

File names  86

Fill flash 56

Filter effects 75,  21

Fireworks show  47

Firmware version 90,  85

Fixed range auto  42

Flash 2, 54

Flash lamp 3, 55

Flash mode 55

Flash off 56

Fluorescent  44

Focus 13, 30

Focus indicator 30

Folder names  86

Food  46

Format 20, 89,  76

Format internal memory 89,  76

Format memory card 20, 89,  76

FSCN  86

Full-frame playback 32

Full-time AF 85,  62

G

Glamour retouch 75,  23

H

HD 720p 85,  62

Help 41

High key  50

High-contrast monochrome  50

I

Identifier  86

Image mode 64, 65

Image review  68

Image size 64

Imprinting date and time 25,  56

Incandescent  44

Internal memory 6, 22, 82

ISO sensitivity 39,  42

J

JPG  86

L

Landscape  43

Language 90,  77

Lens 2,  13

Lens cover 2

Low key  50

M

Macro mode 59

Memory card 20, 21

Memory card slot 3, 20

Monitor 3, 6,  5

Monitor settings 88,  68

Motion detection 89,  72

Movie AF mode 85,  62

Movie length 82, 84

Movie menu 85,  62

Movie options 85,  62

Movie playback 86

Movie recording 82

MSCN  86

Multi-shot 16 39, 43

Museum  47

N

Night landscape  46

Night portrait  44

Nikon Transfer 2 78, 80

Nostalgic sepia **SEPIA** 50

Number of exposures remaining 22, 65

O

Optical zoom 29

Optional accessories 87

P

Paint 75, 14

Panorama assist  48, 3

Panorama Maker 6 48, 78, 4



Paper size 31, 32

Party/indoor  44

Perspective control 75, 20

Pet portrait auto release 49

Pet portrait  49

PictBridge 76, 29, 16

Playback 32, 86, 59

Playback menu 75, 49



Portrait  43

Power 22, 23, 24

Power switch/power-on lamp 2, 22, 23

Preset manual 45

Press halfway 13, 30

Print 75, 76, 31, 32

Print date 25, 88, 70

Print order 75, 53

Printer 76, 29

Protect 75, 51

Q

Quick retouch 75, 17

QVGA 62

R

Rating 9, 74

Rechargeable battery 87

Rechargeable Li-ion battery ii, 16, 18, 87

Red-eye reduction 56

Remaining recording time 84

Reset all 90, 83

Retouch 75, 12

Rotate image 75, 57

RSCN 86

S

Scene auto selector  43

Scene Effect 42

Scene mode 41, 43

Selective color  50

Self-timer 2, 57

Self-timer lamp 52, 58

Setting the date and time 24, 88, 65

Setup menu 88, 64

Shooting 22, 28, 30

Shooting menu 38, 35

Shooting mode 10, 26

Shutter sound 89, 74

Shutter speed 30

Shutter-release button 2, 13, 30

Single 39, 43

Single AF 85, 62

Skin softening 53, 70, 47

Slide show 75, 49

Slow Sync 56

Small picture 75, 24

Smart portrait menu 53

Smart portrait mode 51

Smile Timer 53, 48

Snow  45

Soft **SOFT** 50

Sound settings 89, 74

Speaker 3

Index

Sports  44

SSCN  86

Strap 13

Stretch 75,  19

Stylus 5

Subject tracking 39,  38



Sunset  45

I

Tap 4

Telephoto 29

Televisions 76,  27

Time zone 24, 88,  65,  67

Time zone and date 24, 88,  65

Touch AF/AE 39,  40



Touch shooting 39,  35



Touch shutter 39,  36

Tripod socket 3,  14

TV  27

U

USB cable ii, 18, 76, 79,  30,  87

USB/audio/video output connector 18, 76,  27,  30

V

VGA 84,  62

Vibration reduction 89,  71

Video mode 90,  77

ViewNX 2 77

Voice memo 75,  58

Volume 86,  59

W

WAV  86

Welcome screen 88,  64

White balance 39,  44

Wide-angle 29

Wind noise reduction 85,  63

Z

Zoom 29

Zoom control 2, 29



A series of horizontal dashed lines spanning the width of the page, intended for handwriting practice.



A series of horizontal dashed lines spanning the width of the page, intended for handwriting practice.

Nikon

No reproduction in any form of this manual, in whole or in part (except for brief quotation in critical articles or reviews), may be made without written authorization from NIKON CORPORATION.



NIKON CORPORATION

© 2012 Nikon Corporation

YP2E03(11)
6MM21911-03