

Nikon

DIGITAL CAMERA

COOLPIX S31

Reference Manual



En



Feature Highlights of the COOLPIX S31

Let your camera take over

Point and Shoot **34**

When you set the camera to  Point and shoot, the camera automatically enters scene auto selector mode. There's no need to change the mode: simply point the camera at the subject. The camera determines the shooting conditions and changes the settings appropriately. This feature allows you to spend less time changing camera settings and more time taking pictures!

Take pictures underwater

Shoot Under Water **45**

Set **Choose a style** to **Shoot under water** and take bright, clear underwater pictures even in low light. White balance settings are adjusted for underwater shooting so that colors are reproduced accurately. You'll have plenty of shots to remember your underwater adventures by!

Add voice messages to your pictures

Exchange Messages **66**

You can add messages to your pictures. Enjoy listening to recorded messages and recording replies to messages. Use this feature to exchange messages with friends and family, or to capture the sounds and atmosphere of your pictures so that your audience can share your experiences.

Have fun sharing your pictures

Slide Show **66**

Add effects and music to your pictures and create an original slide show. Three effects are available. You can liven up your slide shows by having the built-in animations appear in your pictures. Sharing pictures with friends and family has never been this fun!

Introduction

Parts of the Camera and Basic Operations

The Basics of Shooting and Playback

Shooting Features

Playback Features

Recording and Playing Back Movies

General Camera Setup

Reference Section

Technical Notes and Index

Read This First

Thank you for purchasing the Nikon COOLPIX S31 digital camera. Before using the camera, please read the information in “For Your Safety” (📖 ix) and “<Important> Shockproof, Waterproof, Dustproof, Condensation” (📖 xv), and familiarize yourself with the information provided in this manual. After reading, please keep this manual handy and refer to it to enhance your enjoyment of your new camera.

About This Manual





If you want to start using the camera right away, see “The Basics of Shooting and Playback” (📖 9).

To learn about the parts of the camera and basic operations, see “Parts of the Camera and Basic Operations” (📖 1).

Other Information

- Symbols and Conventions

To make it easier to find the information you need, the following symbols and conventions are used in this manual:

Icon	Description
	This icon indicates cautions and information that should be read before using the camera.
	This icon indicates notes and information that should be read before using the camera.
	These icons indicate other pages containing relevant information;  : "Reference Section",  : "Technical Notes and Index."

- SD, SDHC, and SDXC memory cards are referred to as "memory cards" in this manual.
- The setting at the time of purchase is referred to as the "default setting."
- The names of menu items displayed in the camera monitor, and the names of buttons or messages displayed on a computer monitor appear in bold.
- In this manual, images are sometimes omitted from monitor display samples so that monitor indicators can be more clearly shown.
- Illustrations and monitor content shown in this manual may differ from the actual product.

Information and Precautions

Life-Long Learning

As part of Nikon's "Life-Long Learning" commitment to ongoing product support and education, continually updated information is available online at the following sites:

- For users in the U.S.A.: <http://www.nikonusa.com/>
- For users in Europe and Africa: <http://www.europe-nikon.com/support/>
- For users in Asia, Oceania, and the Middle East: <http://www.nikon-asia.com/>

Visit these sites to keep up-to-date with the latest product information, tips, answers to frequently asked questions (FAQs), and general advice on digital imaging and photography. Additional information may be available from the Nikon representative in your area. Visit the site below for contact information:

<http://imaging.nikon.com/>

Use Only Nikon Brand Electronic Accessories

Nikon COOLPIX cameras are designed to the highest standards and include complex electronic circuitry. Only Nikon brand electronic accessories (including battery chargers, batteries, and AC adapters) certified by Nikon specifically for use with this Nikon digital camera are engineered and proven to operate within the operational and safety requirements of this electronic circuitry.

THE USE OF NON-NIKON ELECTRONIC ACCESSORIES COULD DAMAGE THE CAMERA AND MAY VOID YOUR NIKON WARRANTY.

The use of third-party rechargeable Li-ion batteries not bearing the Nikon holographic seal could interfere with normal operation of the camera or result in the batteries overheating, igniting, rupturing, or leaking.

For more information about Nikon brand accessories, contact a local authorized Nikon dealer.

Holographic seal: Identifies this device as an authentic Nikon product.



Before Taking Important Pictures

Before taking pictures on important occasions (such as at weddings or before taking the camera on a trip), take a test shot to ensure that the camera is functioning normally. Nikon will not be held liable for damages or lost profits that may result from product malfunction.

About the Manuals

- No part of the manuals included with this product may be reproduced, transmitted, transcribed, stored in a retrieval system, or translated into any language in any form, by any means, without Nikon's prior written permission.
- Nikon reserves the right to change the specifications of the hardware and software described in these manuals at any time and without prior notice.
- Nikon will not be held liable for any damages resulting from the use of this product.
- While every effort was made to ensure that the information in these manuals is accurate and complete, we would appreciate it were you to bring any errors or omissions to the attention of the Nikon representative in your area (address provided separately).

Notice Concerning Prohibition of Copying or Reproduction

Note that simply being in possession of material that was digitally copied or reproduced by means of a scanner, digital camera or other device may be punishable by law.

• **Items prohibited by law from being copied or reproduced**

Do not copy or reproduce paper money, coins, securities, government bonds or local government bonds, even if such copies or reproductions are stamped "Sample." The copying or reproduction of paper money, coins, or securities which are circulated in a foreign country is prohibited. Unless the prior permission of the government was obtained, the copying or reproduction of unused postage stamps or post cards issued by the government is prohibited.

The copying or reproduction of stamps issued by the government and of certified documents stipulated by law is prohibited.

• **Cautions on certain copies and reproductions**

The government has issued cautions on copies or reproductions of securities issued by private companies (shares, bills, checks, gift certificates, etc.), commuter passes, or coupon tickets, except when a minimum of necessary copies are to be provided for business use by a company. Also, do not copy or reproduce passports issued by the government, licenses issued by public agencies and private groups, ID cards and tickets, such as passes and meal coupons.

• **Comply with copyright notices**

The copying or reproduction of copyrighted creative works such as books, music, paintings, woodcut prints, maps, drawings, movies, and photographs is governed by national and international copyright laws. Do not use this product for the purpose of making illegal copies or to infringe copyright laws.

Disposing of Data Storage Devices

Please note that deleting images or formatting data storage devices such as memory cards or built-in camera memory does not completely erase the original image data. Deleted files can sometimes be recovered from discarded storage devices using commercially available software, potentially resulting in the malicious use of personal image data. Ensuring the privacy of such data is the user's responsibility.

Before discarding a data storage device or transferring ownership to another person, erase all data using commercial deletion software, or format the device and then completely refill it with images containing no private information (for example, pictures of empty sky). Care should be taken to avoid injury or damage to property when physically destroying data storage devices.

For Your Safety

To prevent damage to your Nikon product or injury to yourself or to others, read the following safety precautions in their entirety before using this equipment. Keep these safety instructions where all those who use the product will read them.



This icon marks warnings, information that should be read before using this Nikon product, to prevent possible injury.

WARNINGS

Turn off in the event of malfunction

Should you notice smoke or an unusual smell coming from the camera or Battery Charger, unplug the AC adapter and remove the battery immediately, taking care to avoid burns. Continued operation could result in injury. After removing or disconnecting the power source, take the equipment to a Nikon-authorized service representative for inspection.

Do not disassemble

Touching the internal parts of the camera or Battery Charger could result in injury. Repairs should be performed only by qualified technicians. Should the camera or Battery Charger break

open as the result of a fall or other accident, take the product to a Nikon-authorized service representative for inspection, after unplugging the product and/or removing the battery.

Do not use the camera or Battery Charger in the presence of flammable gas

Do not use electronic equipment in the presence of flammable gas, as this could result in explosion or fire.

Handle the camera strap with care

Never place the strap around the neck of an infant or child.

 Keep out of reach of children

Particular care should be taken to prevent infants from putting the battery, brush, or other small parts into their mouths.

 Do not remain in contact with the camera, battery charger, or AC adapter for extended periods while the devices are on or in use

Parts of the devices become hot. Leaving the devices in direct contact with the skin for extended periods may result in low-temperature burns.

 Observe caution when handling the battery

The battery may leak, overheat, or explode if improperly handled. Observe the following precautions when handling the battery for use in this product:

- Before replacing the battery, turn the product off. If you are using the Battery Charger/AC adapter, be sure it is unplugged.
- Use only a Rechargeable Li-ion Battery EN-EL12 (included). Charge the battery by inserting it in a Battery Charger MH-65 (included).
- When inserting the battery, do not attempt to insert it upside down or backwards.
- Do not short or disassemble the battery or attempt to remove or break battery insulation or casing.
- Do not expose the battery to flame or to excessive heat.
- Do not immerse in or expose to water.
- Replace the terminal cover when transporting the battery. Do not transport or store with metal objects such as necklaces or hairpins.
- The battery is prone to leakage when fully discharged. To avoid damage to the product, be sure to remove the battery when no charge remains.
- Discontinue use immediately should you notice any change in the battery, such as discoloration or deformation.
- If liquid from the damaged battery comes in contact with clothing or skin, rinse immediately with plenty of water.

Observe the following precautions when handling the Battery Charger

- Keep dry. Failure to observe this precaution could result in fire or electric shock.
- Dust on or near the metal parts of the plug should be removed with a dry cloth. Continued use could result in fire.
- Do not handle the power cable or go near the battery charger during lightning storms. Failure to observe this precaution could result in electric shock.
- Do not damage, modify, forcibly tug or bend the power cable, place it under heavy objects, or expose it to heat or flame. Should the insulation be damaged and the wires become exposed, take it to a Nikon-authorized service representative for inspection. Failure to observe these precautions could result in fire or electric shock.
- Do not handle the plug or battery charger with wet hands. Failure to observe this precaution could result in electric shock.

- Do not use with travel converters or adapters designed to convert from one voltage to another or with DC-to-AC inverters. Failure to observe this precaution could damage the product or result in overheating or fire.

Use appropriate cables

When connecting cables to the input and output jacks, use only the cables provided or sold by Nikon for the purpose, to maintain compliance with product regulations.

Handle moving parts with care

Be careful that your fingers or other objects are not pinched by the lens cover or other moving parts.

CD-ROMs

The CD-ROMs included with this device should not be played back on audio CD equipment. Playing CD-ROMs on an audio CD player could cause hearing loss or damage the equipment.

 **Observe caution when using the flash**

Using the flash close to your subject's eyes could cause temporary visual impairment. Particular care should be observed if photographing infants, when the flash should be no less than 1 m (3 ft 4 in.) from the subject.

 **Do not operate the flash with the flash window touching a person or object**

Failure to observe this precaution could result in burns or fire.

 **Avoid contact with liquid crystal**

Should the monitor break, care should be taken to avoid injury caused by broken glass and to prevent liquid crystal from the monitor touching the skin or entering the eyes or mouth.

 **Turn the power off when using inside an airplane or the hospital**

Turn the power off while inside the airplane during take off or landing. Follow the instructions of the hospital when using while in a hospital. The electromagnetic waves given out by this camera may disrupt the electronic systems of the airplane or the instruments of the hospital.

Notices

Notice for Customers in the U.S.A.

Federal Communications Commission (FCC) Radio Frequency Interference Statement

This equipment has been tested and found to comply with the limits for a Class B digital device, pursuant to Part 15 of the FCC rules. These limits are designed to provide reasonable protection against harmful interference in a residential installation. This equipment generates, uses, and can radiate radio frequency energy and, if not installed and used in accordance with the instructions, may cause harmful interference to radio communications. However, there is no guarantee that interference will not occur in a particular installation. If this equipment does cause harmful interference to radio or television reception, which can be determined by turning the equipment off and on, the user is encouraged to try to correct the interference by one or more of the following measures:

- Reorient or relocate the receiving antenna.
- Increase the separation between the equipment and receiver.
- Connect the equipment into an outlet on a circuit different from that to which the receiver is connected.
- Consult the dealer or an experienced radio/television technician for help.



Nikon

COOLPIX S31

CAUTIONS

Modifications

The FCC requires the user to be notified that any changes or modifications made to this device that are not expressly approved by Nikon Corporation may void the user's authority to operate the equipment.

Interface Cables

Use the interface cables sold or provided by Nikon for your equipment. Using other interface cables may exceed the limits of Class B Part 15 of the FCC rules.

Notice for customers in the State of California

WARNING

Handling the cord on this product will expose you to lead, a chemical known to the State of California to cause birth defects or other reproductive harm.

Wash hands after handling.

Nikon Inc.,
1300 Walt Whitman Road Melville,
New York 11747-3064 USA
Tel: 631-547-4200

Notice for customers in Canada

CAUTION

This Class B digital apparatus complies with Canadian ICES-003.

ATTENTION

Cet appareil numérique de la classe B est conforme à la norme NMB-003 du Canada.

Notices for customers in Europe

CAUTIONS

RISK OF EXPLOSION IF BATTERY IS REPLACED BY AN INCORRECT TYPE.

DISPOSE OF USED BATTERIES ACCORDING TO THE INSTRUCTIONS.

This symbol indicates that this product is to be collected separately.



The following apply only to users in European countries:

- This product is designated for separate collection at an appropriate collection point. Do not dispose of as household waste.
- For more information, contact the retailer or the local authorities in charge of waste management.

This symbol on the battery indicates that the battery is to be collected separately.



The following apply only to users in European countries:

- All batteries, whether marked with this symbol or not, are designated for separate collection at an appropriate collection point. Do not dispose of as household waste.
- For more information, contact the retailer or the local authorities in charge of waste management.

<Important> Shockproof, Waterproof, Dustproof, Condensation

- Make sure to read the following instructions as well as the instructions provided in “Caring for the Product” (☞:2).

Notes About Shockproof Performance

This camera has passed Nikon’s in-house test (drop test from a height of 1.2 m (3.9 ft) on a 5 cm (2 in.) thick plywood panel) compliant with MIL-STD 810F Method 516.5-Shock*.

This test does not guarantee the waterproof performance of the camera or that the camera will be free from damage or trouble under all conditions.

Changes in appearance, such as paint peeling off and deformation of the drop shock portion are not subject to the Nikon’s in-house test.

* U.S. Department of Defense test method standard.

This drop test drops 5 cameras in 26 directions (8 edges, 12 corners, and 6 faces) from a height of 122 cm (48 in.) to make sure that one to five cameras pass the test (if any defect is detected during the test, another five cameras are tested to make sure that the test criteria are satisfied for one to five cameras).

● Do not subject the camera to excessive shock, vibration or pressure by dropping or hitting it.

Failure to observe this precaution could cause water to seep inside the camera and result in camera malfunction.

- Do not use the camera deeper than 5 m (16.4 ft) underwater.
- Do not subject the camera to water pressure by exposing it to high-pressure running water.
- Do not sit down with the camera in the pocket of your trousers.
Do not forcibly stuff the camera into a bag.

Notes About Waterproof and Dustproof Performances

The camera is equivalent to IEC/JIS waterproof grade 8 (IPX8) and IEC/JIS dustproof grade 6 (IP6X) and enables shooting pictures underwater at a depth of 5 m (16.4 ft) for up to 60 minutes.*

This rating does not guarantee the waterproof performance of the camera or that the camera will be free from damage or trouble under all conditions.

* This rating indicates that the camera has been designed to withstand the specified water pressure for the specified period of time when the camera is used according to the methods defined by Nikon.

● **If the camera is subjected to excessive shock, vibration or pressure by dropping or hitting it, the waterproof performance is not guaranteed.**

- If the camera is exposed to shocks, it is recommended to consult your retailer or Nikon-authorized service representative to confirm the waterproof performance (charged service).
 - Do not use the camera deeper than 5 m (16.4 ft) underwater.
 - Do not subject the camera to water pressure by exposing it to rapid flowing water or waterfalls.
 - Your Nikon warranty may not cover troubles caused by water seeping inside the camera due to improper handling of the camera.
- The waterproof performance of this camera is designed to work for fresh water and seawater only.
- The inner portion of this camera is not waterproof. Water seeping inside the camera could cause a malfunction.
- Accessories are not waterproof.
- If liquids or water droplets come into contact with the outside of the camera or the inside of the battery-chamber/memory card slot cover, immediately wipe the liquids off with a soft dry cloth. Do not insert wet memory cards or the battery.

If the battery-chamber/memory card slot cover is opened or closed under wet conditions near a waterfront or underwater, this could cause water to seep inside the camera or result in camera malfunction.

Do not open or close the cover with wet hands. This could cause water to seep inside the camera or result in camera malfunction.

- If a foreign substance adheres to the outside of the camera or the inside of the battery-chamber/memory card slot cover (such as the hinge, memory card slot, and connectors), remove it immediately with a blower. If a foreign substance adheres to the waterproof packing inside the battery-chamber/memory card slot cover, remove it with the included brush. Do not use the included brush for anything other than cleaning the waterproof packing.
- If a foreign substance such as suntan oil, sunscreen lotion, hot spring, bath mix powder, detergent, soap, organic solvent, oil, or alcohol adheres to the camera, immediately wipe it off.
- Do not leave the camera in high-temperature conditions of 40°C (104°F) or more (in particular, a place exposed to direct sunlight, inside the cabin of a car, on a boat, on the beach, or near a heating device) for a long period of time. This could cause deterioration of the waterproof performance.

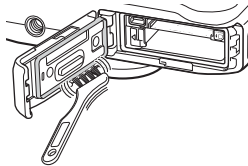

Before Using the Camera Underwater

1. Make sure that there are no foreign substances inside the battery-chamber/memory card slot cover.

- Any foreign substances such as sand, dust or hair inside the battery-chamber/memory card slot cover should be removed with a blower.
- Any liquid such as water droplets inside the battery-chamber/memory card slot cover should be wiped off with a soft dry cloth.

2. Make sure that the waterproof packing (📖 3) of the battery-chamber/memory card slot cover is not cracked or deformed.

- The waterproof performance of waterproof packing may start to deteriorate after one year.
If the waterproof packing begins to deteriorate, consult your retailer or Nikon-authorized service representative.

3. Make sure that the battery-chamber/memory card slot cover is firmly closed.

- Slide the cover until it clicks into place.

Notes About Using the Camera Underwater

Observe the following precautions to prevent water from seeping inside the camera.

- Do not dive into water deeper than 5 m (16.4 ft) with the camera.
- Do not continuously use the camera underwater for 60 minutes or more.
- Use the camera in the water temperature range 0°C–40°C (32°F–104°F) when using it underwater.
Do not use the camera at hot springs.
- Do not open or close the battery-chamber/memory card slot cover underwater.
- Do not subject the camera to shock when using it underwater.
Do not jump into water with the camera or subject it to high water pressure conditions such as rapids or waterfalls.
- This camera does not float in water. Make sure not to drop the camera underwater.

Cleaning After Using the Camera Underwater

- After using the camera underwater, clean the camera within 60 minutes. If you leave the camera in wet conditions where salt particles or other foreign substances adhere to it, this could cause damage, discoloration, corrosion, a bad smell or deterioration of waterproof performance.
- Before cleaning the camera, thoroughly remove water droplets, sand, salt particles, or other foreign substances from your hands, body, and hair.
- It is recommended to clean the camera indoors to avoid a place where it could be exposed to water spray or sand.
- Do not open the battery-chamber/memory card slot cover until all foreign substances are washed off with water and all moisture is wiped off.

1. Keep the battery-chamber/memory card slot cover closed and wash off the camera with fresh water.

Lightly rinse the camera with tap water, or immerse the camera in a shallow basin filled with freshwater for about 10 minutes.

- If the buttons or switches do not operate properly, foreign substances may have adhered to the camera.
Foreign substances can cause the camera to malfunction; wash the camera thoroughly.

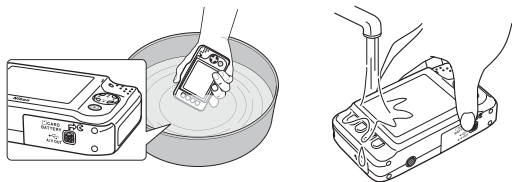

2. Wipe off water droplets with a soft cloth and dry the camera in the well-ventilated and shady place.

- Place the camera on a dry cloth to dry it.
Water will flow out from openings in the microphone or speakers.
 - Do not dry the camera with hot air from a hair dryer or clothes dryer.
 - Do not use chemicals (such as benzine, thinner, alcohol, or cleanser), soap, or neutral detergents.
- If the waterproof packing or body of the camera becomes deformed, the waterproof performance will deteriorate.

3. After making sure that there are no water droplets on the camera, open the battery-chamber/memory card slot cover, gently wipe off any water remaining inside the camera with a dry soft cloth, and use the blower to remove any foreign substances.

- If you open the cover before the camera is thoroughly dried, water droplets may fall on the memory card or battery.
The water droplets may also seep inside the battery-chamber/memory card slot cover (in locations such as waterproof packing, hinges, memory card slot, or terminals). If that happens, wipe the water off with a dry soft cloth.
- If the cover is closed when the inside is wet, this could cause condensation or malfunction.
- If the microphone or speaker openings are clogged with water droplets, the sound may deteriorate or become distorted.
 - Wipe the water off with a dry soft cloth.
 - Do not puncture the microphone or speaker openings with a sharp implement. If the inside of the camera is damaged, the waterproof performance will deteriorate.

Notes About Operating Temperature and Humidity and Condensation

The operation of this camera has been tested at temperatures -10°C – $+40^{\circ}\text{C}$ (14°F – 104°F).

When you use the camera in cold climate regions, observe the following precautions. Keep the camera and spare batteries in a warm place before use.

- The performance of the batteries (number of pictures shot and shooting time) will drop temporarily.
- If the camera is in a very cold state, the performance may drop temporarily, for example, the monitor may be darker than normal immediately after the camera is turned on or residual images may be produced.
- When snow or water droplets adhere to the exterior of the camera, immediately wipe them off.
 - If the buttons or switches are frozen, they may not operate smoothly.
 - If the microphone or speaker openings are clogged with water droplets, the sound may deteriorate or become distorted.

- **Operating environmental conditions such as temperature and humidity may cause fogging (condensation) on the inside of the monitor, lens, or flash window. This is not a camera malfunction or defect.**

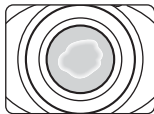

- **Environmental conditions that are likely to cause condensation inside of the camera**

Fogging (condensation) may occur on the inside of the monitor, lens, or flash window in the following environmental conditions where there are sharp temperature changes or high humidity.

- The camera is suddenly immersed in low temperature underwater from high temperature on land.
- The camera is moved from a cold place to a warm place, such as inside a building.
- The battery-chamber/memory card slot cover is open or closed in a high-humidity environment.

- **Clearing the fogging**

- Open the battery-chamber/memory card slot cover after turning off the camera in a place where the ambient temperature is stable (avoid any place that has high temperature/high humidity, sand or dust).

To clear the fogging, remove the battery and memory card, and leave the camera with the battery-chamber/memory card slot cover open to allow the camera to adjust to the ambient temperature.

- If the fogging does not clear, consult your retailer or Nikon-authorized service representative.



























Table of Contents













































Introduction	ii
Read This First	ii
About This Manual	iii
Information and Precautions	v
For Your Safety	ix
WARNINGS	ix
Notices	xiii
<Important> Shockproof, Waterproof, Dustproof, Condensation	xv
Notes About Shockproof Performance	xv
Notes About Waterproof and Dustproof Performances	xvi
Before Using the Camera Underwater	xvii
Notes About Using the Camera Underwater	xviii
Cleaning After Using the Camera Underwater	xviii
Notes About Operating Temperature and Humidity and Condensation	xxi

Parts of the Camera and Basic Operations	1
The Camera Body	2
Attaching the Camera Strap	4
The Monitor	5
Shooting Mode	5
Playback Mode	6
Using the Flexible Buttons	7

The Basics of Shooting and Playback	9
Preparation 1 Charge the Battery	10
Preparation 2 Insert the Battery	12
Preparation 3 Insert a Memory Card	14
Internal Memory and Memory Cards	15
Preparation 4 Set the Display Language, Date, and Time	16
Step 1 Turn the Camera On	20
Turning the Camera On and Off	21
Step 2 Frame a Picture	22
Using the Zoom	23
Step 3 Focus and Shoot	24
The Shutter-release Button	25
Step 4 Play Back Images	26
Step 5 Delete Images	28

Shooting Features	31
Features Available in Shooting Mode (Shooting Menu)	32
 Point and Shoot	34
Using the Flash	35
Using the Self-timer	37
Using the Smile Timer	39
Using Skin Softening	41
Choose a Style (Shooting Suited to Scenes and Effects)	42
Characteristics of Each Style	43
Decorate	48
Change Colors	49

Change Sounds	52	Reference Section	 1
Choose a Size.....	54	Have Fun with Pictures.....	 2
Choose a Photo Size.....	54	Exchange Messages.....	 2
Choose a Movie Frame Size.....	56	Leave a Message	 2
Features That Cannot Be Used		Leave a Reply	 4
Simultaneously.....	58	Play Recordings.....	 5
Focusing.....	60	Erase Recordings.....	 5
Using Face Detection.....	60	Picture Play.....	 7
Focus Lock.....	61	Picture Play Features	 7
Playback Features.....	63	Soften Pictures.....	 9
Playback Zoom	64	Add Starbursts.....	 10
Thumbnail Display	65	Add a Fisheye Effect	 11
Features Available in Playback Mode		Add a Diorama Effect.....	 12
(Playback Menu).....	66	Toy Camera	 13
Connecting the Camera to a TV, Computer,		Change Colors.....	 14
or Printer	68	Highlight Colors.....	 15
Using ViewNX 2	70	Decorate	 16
Installing ViewNX 2	70	Make Photo Albums	 17
Transferring Images to the Computer	73	Making Photo Albums.....	 17
Viewing Images.....	75	View	 19
Recording and Playing Back Movies....	77	Favorites.....	 19
Recording Movies	78	Adding Images to Favorites.....	 19
Playing Back Movies	81	Removing Images from Favorites.....	 20
General Camera Setup.....	83	Slide Show.....	 21
Camera Settings Menu	84	Choose Pictures.....	 21
		Choose a Theme.....	 25
		View Movie.....	 26

Settings.....		27	Technical Notes and Index		1
More Playback Options		27	Caring for the Product.....		2
View by Date		27	The Camera.....		2
View Favorites		29	The Battery.....		5
Print Order/Retouch		30	The Battery Charger		6
Retouch.....		30	Memory Cards		7
Print Order.....		35	Cleaning and Storage.....		8
Camera Settings		38	Cleaning		8
Welcome Screen.....		38	Storage.....		9
Date and Time		39	Troubleshooting		10
Brightness		40	Specifications		17
Print Date		41	Approved Memory Cards.....		22
Electronic VR		42	Supported Standards.....		23
AF Assist		43	Index.....		24
Format Memory/Format Card.....		44			
Language		45			
Menu Background.....		46			
Video Mode		46			
Reset All.....		47			
Firmware Version.....		49			
Connections.....		50			
Connecting the Camera to a TV.....		50			
Connecting the Camera to a Printer ...		52			
Connecting the Camera to a Printer...		53			
Printing Individual Images.....		55			
Printing Multiple Images		57			
Additional Information		61			
File and Folder Names		61			
Optional Accessories		63			
Error Messages.....		64			



Parts of the Camera and Basic Operations

This chapter describes the parts of the camera and also explains how to use basic camera features.

The Camera Body	2
Attaching the Camera Strap.....	4
The Monitor	5
Shooting Mode	5
Playback Mode	6
Using the Flexible Buttons	7

➔ If you want to start using the camera right away, see “The Basics of Shooting and Playback” (📖 9).

The Camera Body

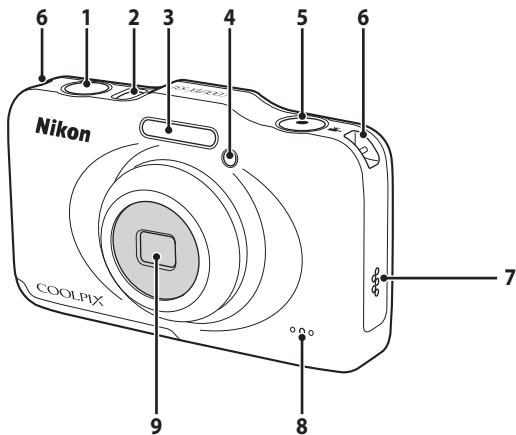

1	Shutter-release button.....	24
2	Power switch/power-on lamp.....	20
3	Flash.....	35
4	Self-timer lamp.....	37
	AF-assist illuminator.....	84

5	● (movie-record) button.....	78
6	Eyelets for camera strap.....	4
7	Speaker.....	82
8	Microphone.....	78
9	Lens (with protective glass)	

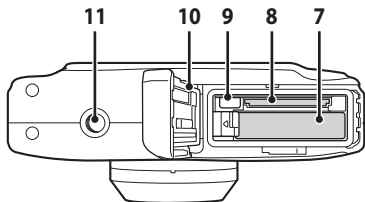
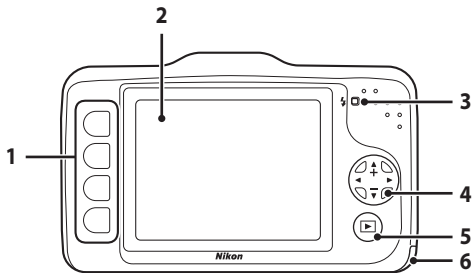

1	Flexible buttons.....	7, 32, 66
2	Monitor	5
3	Flash lamp.....	35
4	Multi selector	
	▲: Telephoto	23
	▼: Wide-angle.....	23
5	▶ (shooting/playback mode) button....	26

6	Battery-chamber/ memory card slot cover	12, 14
7	Battery chamber	12
8	Memory card slot.....	14
9	USB/audio/video output connector	68
10	Waterproof packing	xvi, xvii
11	Tripod socket.....	19

Attaching the Camera Strap

Pass the strap through either the left or right strap eyelet and attach the strap.

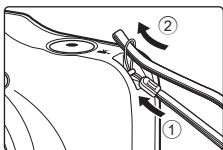

The Monitor

- The information that is displayed in the monitor during shooting and playback changes depending on the camera's settings and state of use.



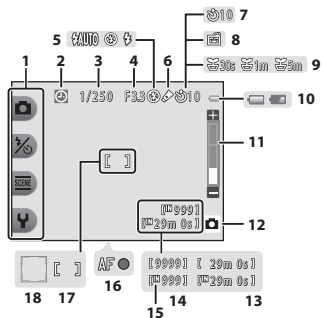

Shooting Mode

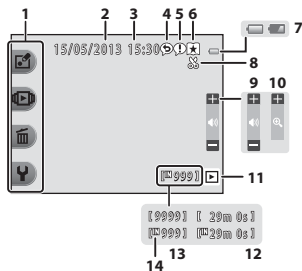

1	Flexible icons.....	7	10	Battery level indicator	20
2	“Date not set” indicator.....	19, 84, 64	11	Zoom indicator	23
3	Shutter speed	25	12	Shooting mode.....	34, 42
4	Aperture value.....	25	13	Movie recording time.....	57, 78
5	Flash mode.....	35	14	Number of exposures remaining.....	20, 55
6	Change colors icon.....	49	15	Internal memory indicator	20
7	Self-timer indicator.....	37	16	Focus indicator	24
8	Smile timer.....	39	17	Focus area.....	24
9	Shoot at intervals icon	44	18	Focus area (face detection)	24

Playback Mode



1	Flexible icons.....	7	8	Crop indicator	64
2	Date of recording	16	9	Volume	82
3	Time of recording.....	16	10	Switch to full-frame	65
4	Message (reply).....	66,  4	11	Playback mode	66
5	Message	66,  2	12	Movie/message recording time...66,  5	
6	Favorites indicator	66,  19	13	Current image number	26
7	Battery level indicator.....	20	14	Internal memory indicator	26

If Information Is Not Displayed During Shooting Mode and Playback Mode

Apart from certain information such as the battery level, focus indicator, or focus area, information is not displayed if no operations are performed for several seconds. Information is displayed again when either a flexible button or the multi selector is pressed.

Using the Flexible Buttons

If you press a flexible button while the shooting screen or playback screen is displayed, the menu for the current mode is displayed. Once the menu is displayed, you can change various settings.

In this document, the flexible buttons are referred to as “flexible button 1” through “flexible button 4”, in order from top to bottom.

Shooting mode

Flexible button 1

Flexible button 2

Flexible button 3

Flexible button 4



Playback mode

Flexible button 1

Flexible button 2

Flexible button 3

Flexible button 4

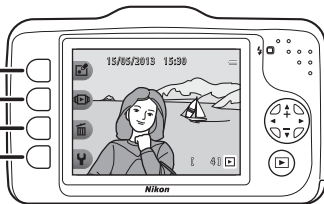

Selecting Items

- To select an item, press the flexible button next to it.
- When  is displayed, press flexible button 1 to return to the previous screen.

Shooting mode

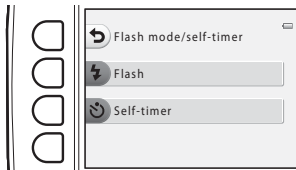

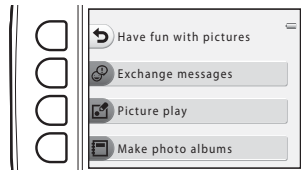

Playback mode

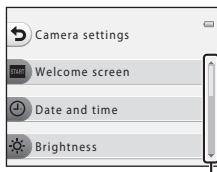

- When the menu content continues on another page, a guide indicating the page position is displayed.

Press the multi selector  or  to display other pages.



Press  or  to display other pages.

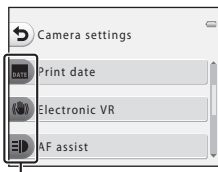

To select an item, press the flexible button next to the item.

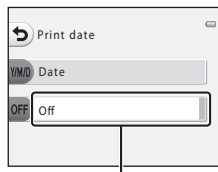

The last setting selected (including the default setting) is displayed in white.

Notes About Setting Menu Items

Some menu items cannot be selected depending on how the camera is set up. These menu items are displayed in gray.



The Basics of Shooting and Playback

Preparation

Preparation 1 Charge the Battery	10
Preparation 2 Insert the Battery	12
Preparation 3 Insert a Memory Card	14
Preparation 4 Set the Display Language, Date, and Time.....	16



Shooting

Step 1 Turn the Camera On.....	20
Step 2 Frame a Picture	22
Step 3 Focus and Shoot.....	24



Playback

Step 4 Play Back Images	26
Step 5 Delete Images.....	28

Preparation 1 Charge the Battery

- 1** Connect the power cable in the order indicated below.

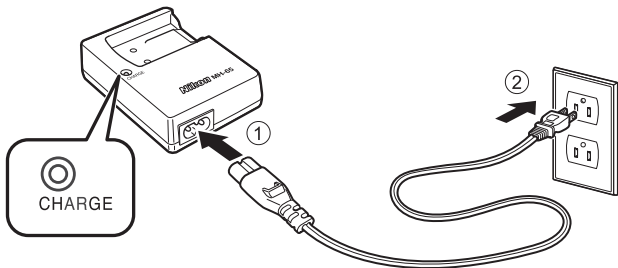

- 2** Insert the included Rechargeable Li-ion Battery EN-EL12 into the included Battery Charger MH-65 by sliding the battery forward (1), and then press down until it locks into place (2).

- The CHARGE lamp starts flashing when charging starts.
- A fully-exhausted battery charges in about 2 hours and 30 minutes.
- When charging is complete, the CHARGE lamp lights.
- See “Understanding the CHARGE Lamp” (11).

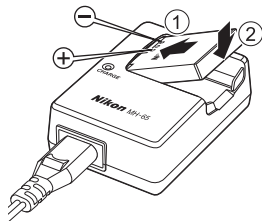

- 3** When charging is complete, remove the battery, and then unplug the charger.

Understanding the CHARGE Lamp

Status	Description
Flashes	Battery charging.
On	Battery fully charged.
Flashes quickly	<ul style="list-style-type: none">• The battery is not inserted correctly. Remove the battery and reinsert it into the battery charger so that the battery is lying flat.• The ambient temperature is not suited to charging. Charge the battery indoors with an ambient temperature of 5°C–35°C (41°F–95°F) before use.• The battery is faulty. Stop charging immediately, unplug the charger, and take both the battery and charger to your retailer or Nikon-authorized service representative.

Notes About the Battery Charger

- Be sure to read and follow the warnings in “For Your Safety” (📖 ix) thoroughly before using the battery charger.
- Be sure to read and follow the warnings in “The Battery Charger” (🔌6) thoroughly before using the battery charger.

Notes About the Battery

- Be sure to read and follow the warnings in “For Your Safety” (📖 ix) thoroughly before using the battery.
- Be sure to read and follow the warnings in “The Battery” (🔌5) thoroughly before using the battery.

AC Power Source

- You can use the AC Adapter EH-62F (available separately; 🔌63) to power the camera from an electrical outlet, enabling taking and playing back pictures.
- Do not, under any circumstances, use an AC adapter other than the EH-62F. Failure to observe this precaution could result in overheating or in damage to the camera.

Preparation 2 Insert the Battery

- 1 Open the battery-chamber/memory card slot cover.

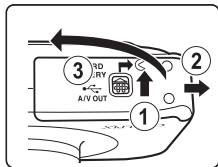

- 2 Insert the included battery.

- Use the battery to push the orange battery latch in the direction indicated by the arrow (1), and fully insert the battery (2).
- When the battery is inserted correctly, the battery latch will lock the battery in place.

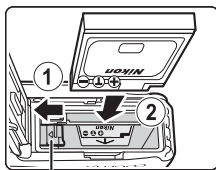

Battery latch



✓ Inserting the Battery Correctly

Inserting the battery upside down or backwards could damage the camera. Be sure to check that the battery is in the correct orientation.

- 3 Close the battery-chamber/memory card slot cover.

- Charge the battery before the first use or when the battery is running low (10).

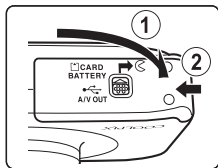

Removing the Battery

Turn the camera off (📖 21) and be sure that the power-on lamp and the monitor have turned off before opening the battery-chamber/memory card slot cover.

To eject the battery, open the battery-chamber/ memory card slot cover and slide the orange battery latch in the direction indicated by the arrow (①). The battery can then be removed by hand (②). Do not pull it at an angle.

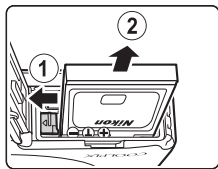

✔ High Temperature Caution

The camera, battery, and memory card may be hot immediately after using the camera. Observe caution when removing the battery or memory card.

✔ Opening and Closing the Battery-chamber/Memory Card Slot Cover

Do not open and close the battery chamber/memory card slot cover in a sandy or dusty environment or with wet hands. If the cover is closed without removing foreign particles, water may seep inside the camera or the camera may become damaged.

- If foreign particles get inside the cover or camera, immediately remove them with a blower or brush.
- If liquid such as water gets inside the cover or camera, immediately wipe it off with a soft and dry cloth.

Preparation 3 Insert a Memory Card

- 1 Confirm that the power-on lamp and the monitor are off and then open the battery-chamber/memory card slot cover.
 - Turn off the camera before opening the cover.

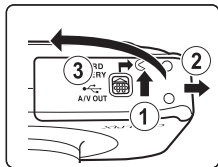

- 2 Insert a memory card.
 - Slide the memory card in until it clicks into place.

- Inserting a Memory Card**
Inserting a memory card upside down or backwards could damage the camera and the memory card. Be sure to check that the memory card is in the correct orientation.

Memory card slot

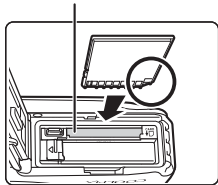

- 3 Close the battery-chamber/memory card slot cover.

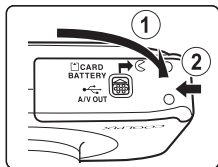

✔ Formatting a Memory Card

- The first time you insert a memory card that has been used in another device into this camera, be sure to format it with this camera.
- **All data stored on a memory card is permanently deleted when the card is formatted.** Be sure to save important images by transferring them to a computer before formatting.
- To format a memory card, insert the card into the camera, and then select **Format card** (📖 84) in the camera settings menu (📖 84).

✔ Notes About Memory Cards

See “Memory Cards” (📖 7) and the documentation included with your memory card for more information.

Removing the Memory Card

Before opening the battery-chamber/memory card slot cover, turn the camera off and confirm that the power-on lamp and the monitor are off.

Press the memory card in lightly with your finger (①) to partially eject it, and then pull it out straight (②).

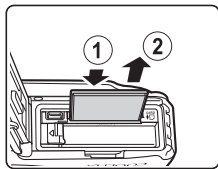

✔ High Temperature Caution

The camera, battery, and memory card may be hot immediately after using the camera. Observe caution when removing the battery or memory card.

Internal Memory and Memory Cards

Camera data, including images and movies, can be saved either in the camera's internal memory (approx. 26 MB) or on a memory card. To use the camera's internal memory for shooting or playback, first remove the memory card.

Preparation 4 Set the Display Language, Date, and Time

When the camera is turned on for the first time, the language-selection screen, the date and time setting screen for the camera clock, and the menu background setting screen are displayed.

1 Press the power switch to turn on the camera.

- When the camera is turned on, the power-on lamp (green) lights and then the monitor turns on (the power-on lamp turns off when the monitor turns on).

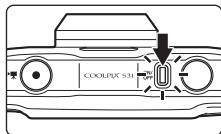

2 Press the multi selector ◀ or ▶ to display the desired language, and then press flexible button 4 (OK).

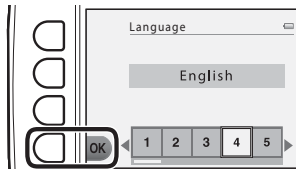

3 Press flexible button 3 (O Yes).

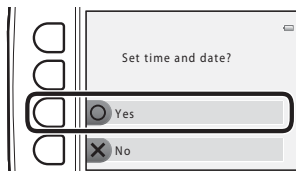

- 4** Use flexible button 2, 3, or 4 to select the date format.

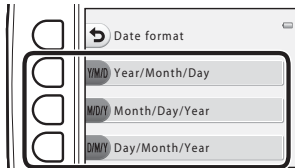

- 5** Press ▲, ▼, ◀, or ▶ to set the date and time, and then press flexible button 4 (OK).

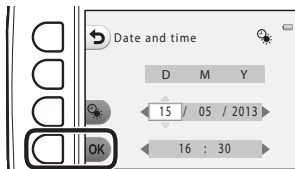

- Select an item: Press ▶ or ◀ (changes between **D, M, Y**, hour, and minute).
- Edit the date and time: Press ▲ or ▼.
- Apply the setting: Select the minute setting and then press flexible button 4 (OK).
- Press flexible button 3 (☀) to enable daylight saving time. When the daylight saving time function is enabled, ☀ is displayed in the monitor. Press flexible button 3 (☀) again to disable the daylight saving time function.

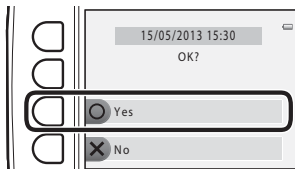

- 6** Press flexible button 3 (Yes).



7 Press ◀ or ▶ to select the background image to be displayed when a menu or setting screen is displayed, and then press flexible button 4 (**OK**).

- To restore the default background image, press flexible button 3 (**RESET**).
- The camera enters shooting mode and you can take pictures using  Point and shoot ( 20).

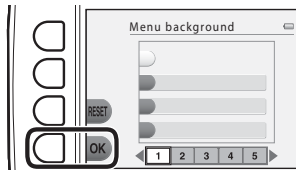

Changing the Language Setting, the Date and Time Setting, and the Menu Background Setting

- You can change the **Language** (🔍45), **Date and time** (🔍39), and **Menu background** (🔍46) settings in the 📷 camera settings menu (📖 84).
- You can enable and disable daylight saving time by selecting **Date and time** (🔍39) in the 📷 camera settings menu. When enabled, the clock moves forward one hour; when disabled, the clock moves back one hour.
- If you exit without setting the date and time, 📷 flashes when the shooting screen is displayed. If still images are taken without setting the date and time, the shooting date and time are not displayed during playback. Use the **Date and time** setting in the camera settings menu to set the date and time (📖 84, 🔍39).

The Clock Battery

- The camera's clock is powered by an internal backup battery. The backup battery is charged when the main battery is inserted into the camera or when the camera is connected to an optional AC adapter, and can provide several days of backup power after about 10 hours of charging.
- If the camera's backup battery becomes exhausted, the date and time setting screen is displayed when the camera is turned on. Set the date and time again. → Step 3 of "Preparation 4 Set the Display Language, Date, and Time" (📖 16)

Imprinting the Shooting Date in Printed Images

- Set the date and time before shooting.
- You can permanently imprint the shooting date in images as they are captured by setting **Print date** (🔍41) in the camera settings menu (📖 84).
- If you want the shooting date to be printed without using the **Print date** setting, print using the ViewNX 2 software (📖 70).

Step 1 Turn the Camera On

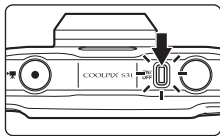

1 Press the power switch to turn on the camera.

- The monitor turns on.



2 Check the battery level indicator and the number of exposures remaining.

Battery Level Indicator

Display	Description
	Battery level high.
	Battery level low. Prepare to charge or replace the battery.
Battery exhausted.	Cannot take pictures. Charge or replace the battery.

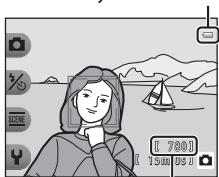

Battery level indicator



Number of exposures remaining

Number of Exposures Remaining

The number of pictures that can be taken is displayed.

-  is displayed when no memory card is inserted in the camera, and images are saved in the internal memory (approx. 26 MB).
- The number of exposures remaining depends on the amount of available memory in the internal memory or memory card, and also varies depending on the **Photo size** setting under **Choose a size**  54).

Turning the Camera On and Off

- When the camera is turned on, the power-on lamp (green) lights and then the monitor turns on (the power-on lamp turns off when the monitor turns on).
- To turn off the camera, press the power switch. When the camera turns off, the power-on lamp and the monitor turn off.
- Press and hold the  (shooting/playback mode) button to turn on the camera and switch to playback mode.



Power Saving Function (Auto Off)

- If no operations are performed for a while, the monitor turns off, the camera enters standby mode, and the power-on lamp flashes. If no operations are performed for approx. another three minutes, the camera turns off automatically.

While the camera is in standby mode, the monitor turns back on if you perform any of the following operations:

- Press the power switch, shutter-release button,  (shooting/playback mode) button, or  (movie-record) button

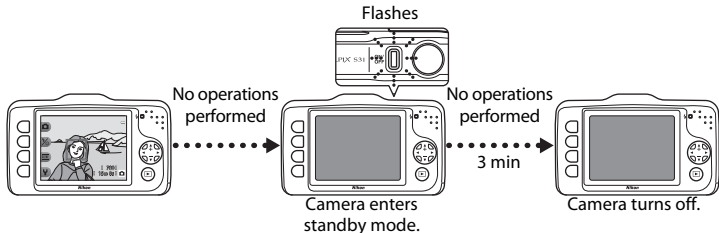

- The camera enters standby mode within 30 minutes while playing a slide show.
- If you are using the optional AC Adapter EH-62F, the camera enters standby mode after 30 minutes (fixed).

Step 2 Frame a Picture

1 Hold the camera steady.

- Keep fingers, hair, the camera strap, and other objects away from the lens, flash, and microphone.

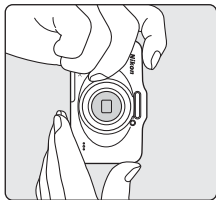
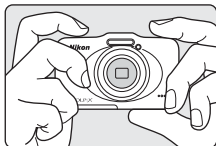

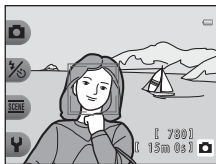

2 Frame the picture.

- Aim the camera at the desired subject.



When Using a Tripod

We recommend using a tripod to stabilize the camera in the following situations.

- When shooting in dimly lit conditions with the flash mode ( 35) set to  **Flash off**
- When zooming in on the subject

Using the Zoom

When you press the multi-selector ▲ or ▼, the zoom indicator is displayed on the right side of the monitor and the optical zoom is activated.

- To zoom in closer to the subject, press ▲ (telephoto).
- To zoom out and view a larger area, press ▼ (wide-angle).

When you turn the camera on, the zoom moves to the maximum wide-angle position.

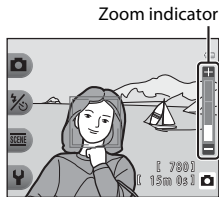
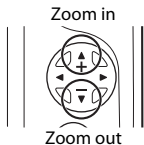

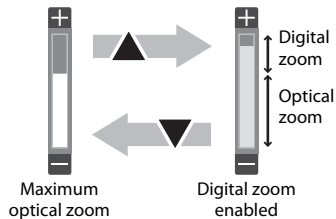

- If you press ▲ when the camera is zoomed in to the maximum optical zoom position, you can use the digital zoom to magnify the image further by up to about 4x.



Digital Zoom and Interpolation

Unlike optical zoom, digital zoom uses a digital imaging process known as interpolation to magnify images, resulting in slight deterioration of picture quality depending on the image size and the digital zoom magnification.

When using digital zoom, we recommend reducing the image size in  **Photo size** under  **Choose a size** in order to minimize image deterioration (📖 54).

Step 3 Focus and Shoot

1 Press the shutter-release button halfway (📖 25).

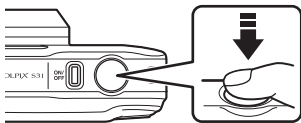

- When a face is detected:
The camera focuses on the face framed by the yellow double border (focus area). When the subject is in focus, the double border turns green.
- When no faces are detected:
The camera focuses on the subject in the center of the frame. When the camera has focused, the focus area turns green.
- When you are using digital zoom, the camera focuses on the subject in the center of the frame and the focus area is not displayed. When the camera has focused, the focus indicator (📖 5) lights in green.
- While the shutter-release button is pressed halfway, the focus area or focus indicator may flash in red. This indicates that the camera is unable to focus. Modify the composition and then press the shutter-release button halfway again.





2 Press the shutter-release button the rest of the way down (📖 25).

- The shutter is released and the image is saved.



The Shutter-release Button

<p>Press halfway</p>		<p>To set focus and exposure (shutter speed and aperture value), press the shutter-release button halfway, stopping when you feel resistance. Focus and exposure remain locked while the shutter-release button is pressed halfway.</p>
<p>Press all the way</p>		<p>While pressing the shutter-release button halfway, press the shutter-release button the rest of the way down to release the shutter and take a picture. Do not use force when pressing the shutter-release button, as this may result in camera shake and blurred images. Press the button gently.</p>

✓ Notes About Saving Data

After taking pictures or recording movies, the number of exposures remaining or the remaining recording time flashes while images or movies are being saved. **Do not open the battery-chamber/memory card slot cover.** Image and movie data could be lost and the camera or memory card could be damaged.

✓ Notes About Focus

Subjects Not Suitable for Autofocus →  62

Flash

If the subject is dimly lit, the flash ( 35) may fire when you press the shutter-release button all the way down.

To Make Sure You Do Not Miss a Shot

If you are concerned that you might miss a shot, press the shutter-release button all the way without first pressing it halfway.





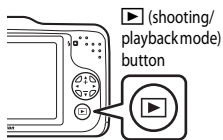

Step 4 Play Back Images

1 Press the (shooting/playback mode) button.

- The camera switches to playback mode and the last image saved is displayed full-frame.



2 Use the multi selector to select an image to display.

- Display the previous image: Press 
- Display the next image: Press 
- Press and hold  or  to scroll quickly through images.
- Remove the memory card from the camera to play back images saved in the camera's internal memory.  is displayed near the current image number.
- To return to shooting mode, press the  (shooting/playback mode) button, shutter-release button, or the  (movie-record) button.

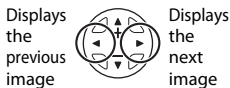



Current image number

Viewing Images

- Images may be displayed briefly at low resolution immediately after switching to the previous image or next image.
- When images in which the face ( 60) was detected at the time of shooting are displayed, depending upon the orientation of the detected face, the images are automatically rotated for playback display (except images captured using **Shoot at intervals** and **Take a series of pictures**).

More Information

- Playback Zoom →  64
- Thumbnail Display →  65
- Features Available in Playback Mode (Playback Menu) →  66

Step 5 Delete Images

- 1** Display the image you want to delete in the monitor and then press flexible button 3 (🗑).

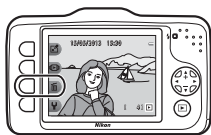

- 2** Press flexible button 2, 3, or 4 to select the deletion method.

- 🗑 **Erase this picture only:** Only the current image is deleted.
- 📖 **Erase selected pictures:** Multiple images can be selected and deleted (📖 29).
- **ALL Erase all pictures:** All images currently saved are deleted.
- To exit without deleting, press flexible button 1 (↩).



- 3** Press flexible button 3 (○ Yes).

- Deleted images cannot be recovered.
- To exit without deleting, press flexible button 4 (✕ No).

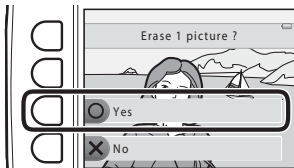

Selecting which images you want to delete

1 Press the multi selector ◀ or ▶ to select an image to be deleted, and then press flexible button 2 (✓).

- A check mark appears next to the selected image.
- A check mark is displayed or removed every time you press flexible button 2 (✓).
- Press flexible button 3 (RESET) to remove all check marks.

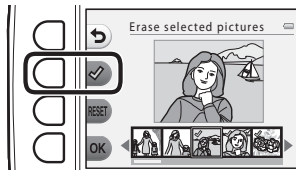

2 Add check marks to all images that you want to delete, and then press flexible button 4 (OK) to confirm the selection.

- A confirmation dialog is displayed. Follow the instructions displayed in the monitor.

✓ Notes About Deletion

- Deleted images cannot be recovered. Copy important images to a computer before deleting them from the camera.
- If you delete an image that has recorded messages attached, both the image and its messages are deleted (📖 66).
- Images that have been added to favorites (📖 66) cannot be selected.



A series of ten horizontal dashed lines spanning the width of the page, intended for handwriting practice.











Shooting Features



This chapter describes  Point and shoot and the features that are available when shooting. You can adjust settings according to the shooting conditions and the kind of pictures you want to take.

Features Available in Shooting Mode (Shooting Menu) ...	32
 Point and Shoot	34
Using the Flash	35
Using the Self-timer.....	37
Using the Smile Timer	39
Choose a Style (Shooting Suited to Scenes and Effects) ...	42
Decorate.....	48
Change Colors.....	49
Change Sounds	52
Choose a Size	54
Features That Cannot Be Used Simultaneously.....	58
Focusing	60

Features Available in Shooting Mode (Shooting Menu)

Press a flexible button to display a menu. You can change the following settings.

Flexible button	Option	Description	
 Point and shoot	–	Sets the shooting mode to  Point and shoot.	34
 Flash mode/ self-timer	Flash	Allows you to set the flash mode.	35
	Self-timer	The camera's self-timer can release the shutter about 10 seconds after you press the shutter-release button. You can also set the smile timer.	37, 39
 More picture options	Choose a style	Allows you to select the scene settings and effects used for shooting.	42
	Decorate	Allows you to add a frame around your images when taking pictures. Seven different frames are available.	48
	Change colors	Allows you to select  Brighter/darker or  More vivid/less vivid from the menu, or use  Highlight colors to select one color to keep in your pictures and turn the rest of the colors to shades of black and white.	49

Flexible button	Option	Description	
 Settings	Change sounds	Allows you to configure the shutter and button sounds.	52
	Choose a size	Set the size of photos (still images) and movies.	54
	Camera settings	Allows you to change a number of general settings.	84



Features That Cannot Be Used Simultaneously

Some settings cannot be used with other functions ( 58).



Point and Shoot

When this camera is used for the first time, the shooting mode is set to  Point and shoot. When you frame a picture, the camera automatically determines the scene and selects the optimal settings, allowing you to take pictures with ease.

 Point and shoot is the default shooting mode for this camera.



- The area of the frame that the camera focuses on varies depending on the composition of the picture.
- When the camera detects a person's face, it focuses on that face ( 60). The skin softening feature makes the skin tones in people's faces appear smoother ( 41).
- The flash may fire when shooting in low light.
- When shooting in low light, the use of a tripod is recommended.
- The camera does not detect the scene when the digital zoom is being used.

Notes About Motion Detection

In  Point and shoot and **Shoot close-ups** ( 43), when the camera detects subject movement or camera shake, ISO sensitivity and shutter speed are increased to reduce blurring.

Using the Flash

You can set the flash mode to match the shooting conditions.

The flash mode selected while using  Point and shoot ( 34) is saved in the camera's memory even after the camera is turned off.

Enter shooting mode → flexible button 2 () → flexible button 2 ( Flash)

Available Flash Modes

AUTO Auto flash

- The flash fires automatically when lighting is dim.
-  AUTO is displayed in the shooting screen when this feature is enabled.

Flash off

The flash does not fire.

- We recommend using a tripod to stabilize the camera when shooting in dark surroundings.
-  is displayed in the shooting screen when this feature is enabled.

Always fire flash

- The flash fires whenever a picture is taken. Use to “fill-in” (illuminate) shadows and backlit subjects.
-  is displayed in the shooting screen when this feature is enabled.

- 1** Press flexible button 2 (**⚡AUTO Auto flash**), flexible button 3 (**🔋 Flash off**), or flexible button 4 (**⚡ Always fire flash**).

- To cancel, press flexible button 1 (**↩**).

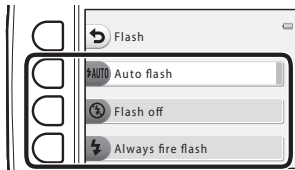

- 2** Frame the subject and take a picture.

✔ Features That Cannot Be Used Simultaneously

Some settings cannot be used with other functions (📖 58).

📌 The Flash Lamp

The flash lamp indicates the status of the flash when you press the shutter-release button halfway.

- On: The flash fires when a picture is taken.
- Flashing: The flash is charging. The camera cannot take pictures.
- Off: The flash does not fire when a picture is taken.

If the battery level is low, the monitor turns off while the flash is charging.

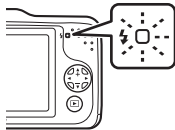

📌 Effective Range of the Flash



The flash has a range of approx. 0.5–3.5 m (1 ft 8 in.–11 ft) at the maximum wide-angle zoom position and a range of approx. 0.5–2.0 m (1 ft 8 in.–6 ft 6 in.) at the maximum telephoto zoom position.

Using the Self-timer

The camera's self-timer can release the shutter about 10 seconds after you press the shutter-release button. The self-timer is useful when you want to be in the picture you are taking, or when you want to avoid the effects of camera shake that occur when you press the shutter-release button. When using the self-timer, use of a tripod is recommended.

Enter shooting mode → flexible button 2 (1/6) → flexible button 3 (Self-timer)

1 Press flexible button 2 (10s 10 s).

-  is displayed.
- When  **Smile timer** is selected, the camera uses face detection to detect a person's face, and then automatically releases the shutter when a smile is detected ( 39).

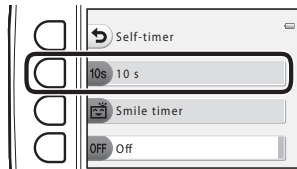

2 Frame the picture and press the shutter-release button halfway.

- Focus and exposure are set.



3 Press the shutter-release button the rest of the way down.

- The self-timer starts, and the number of seconds remaining before the shutter is released is displayed in the monitor. The self-timer lamp flashes while the timer is counting down. About one second before the shutter is released, the lamp stops flashing and glows steadily.
- When the shutter is released, the self-timer is set to **OFF off**.
- To stop the timer before a picture is taken, press the shutter-release button again.



Features That Cannot Be Used Simultaneously

Some settings cannot be used with other functions (📖 58).

Using the Smile Timer

If the camera detects smiling faces, the shutter is automatically released without pressing the shutter-release button. The skin softening function makes facial skin tones softer.

Enter shooting mode → flexible button 2 (📷) → flexible button 3 (⌚ Self-timer)

1 Press flexible button 3 (📷 Smile timer).

- 📷 is displayed.

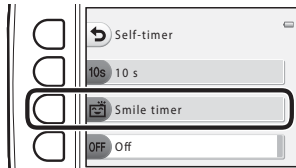

2 Frame the picture.

- Point the camera at a person's face. → "Using Face Detection" (📖 60)

3 Wait for the subject to smile. Do not press the shutter-release button.

- If the camera detects the smiling face of the person framed by the double border, the shutter is automatically released.
- After the camera releases the shutter, it continues to detect faces and smiles, and releases the shutter again if it detects a smiling face.

4 Stop shooting.

- You can turn off the smile timer by turning the camera off or by setting the self-timer to **OFF off**.

Notes About the Smile Timer

- Digital zoom cannot be used.
- Under some shooting conditions, the camera may be unable to detect faces or detect smiles.
- Notes About Face Detection → (📖 60)

Features That Cannot Be Used Simultaneously

Some settings cannot be used with other functions (📖 58).

Auto Off When Using Smile Timer

When using smile timer, auto off (📖 21) turns the camera off if no operations are performed in the following situations:

- The camera does not detect any faces.
- The camera detected a face, but cannot detect a smile.

When the Self-timer Lamp Flashes

When using smile timer, the self-timer lamp flashes when the camera detects a face, and flashes quickly immediately after the shutter is released.

Releasing the Shutter Manually

The shutter can also be released by pressing the shutter-release button. If no faces are detected, the camera focuses on the subject in the center of the frame.

More Information

Subjects Not Suitable for Autofocus → (📖 62)

Using Skin Softening

When the shutter is released when using  Point and shoot or smile timer, the camera detects one or more person's faces (up to three), and processes the image to soften facial skin tones.

Notes About Skin Softening

- It may take more time than usual to save images after shooting.
- Under some shooting conditions, the desired skin softening results may not be achieved, or skin softening may be applied to areas of the image where there are no faces.

Choose a Style (Shooting Suited to Scenes and Effects)

When one of the following styles (shooting scenes and effects) is selected, camera settings are automatically optimized for the selected scene.

Enter shooting mode → flexible button 3 (SCENE) → flexible button 2 (SCENE) Choose a style)

Press the multi selector ◀ or ▶ to select the desired style (shooting scene and effect), and then press flexible button 4 (OK).

- To cancel, press flexible button 1 (↵).



Shoot close-ups (📖 43) (default setting)	Photograph food (📖 43)
Shoot at intervals (📖 44)	Shoot under water (📖 45)
Take a series of pictures (📖 45)	Photograph fireworks (📖 46)
Mirror (📖 46)	Take soft pictures (📖 47)
Create a diorama effect (📖 47)	

✓ Features That Cannot Be Used Simultaneously



Some settings cannot be used with other functions (📖 58).

✍ Image Size





No matter which setting you choose for **Choose a style**, you can change the image size (📖 54).

Characteristics of Each Style

Shoot close-ups

- The camera automatically zooms to the closest position at which it can shoot.
- The closest distance at which the camera can focus varies depending on the zoom position. When the zoom is set to a position where the zoom indicator turns green, the camera can focus on subjects as close as about 20 cm (8 in.) from the front of the protective glass. When the zoom is at the maximum wide-angle position, the camera can focus on subjects as close as about 5 cm (2 in.) from the front of the protective glass.
- The camera focuses on the area in the center of the frame. Use focus lock to frame the picture on an object not in the center of the frame (📖 61).
- The camera focuses even when the shutter-release button is not pressed halfway. You may hear the sound of the camera focusing.
- The flash may be unable to light the entire subject at distances of less than 50 cm (1 ft 8 in.).
- The flash is set to  **Flash off**, but the setting can be changed (📖 35).
- The self-timer can be set, but  **Smile timer** is not available (📖 37, 39).



Photograph food

- The camera automatically zooms to the closest position at which it can shoot.
- The closest distance at which the camera can focus varies depending on the zoom position. When the zoom is set to a position where the zoom indicator turns green, the camera can focus on subjects as close as about 20 cm (8 in.) from the front of the protective glass. When the zoom is at the maximum wide-angle position, the camera can focus on subjects as close as about 5 cm (2 in.) from the front of the protective glass.
- Press the multi selector  or  to adjust the hue setting, and then press flexible button 4 (). The hue setting is saved in the camera's memory even after the camera is turned off.
- The camera focuses on the area in the center of the frame. Use focus lock to frame the picture on an object not in the center of the frame (📖 61).
- The camera focuses even when the shutter-release button is not pressed halfway. You may hear the sound of the camera focusing.
- The flash setting is fixed at  **Flash off** (📖 35).
- The self-timer can be set, but  **Smile timer** is not available (📖 37, 39).



🔍 Shoot at intervals

- The camera can automatically capture still images at pre-determined intervals. Images captured in one shooting are saved in one folder and can be viewed in a slide show (📖 66).
- Press flexible button 2 (**30s Shoot every 30 seconds**), flexible button 3 (**1m Shoot once a minute**), or flexible button 4 (**5m Shoot every 5 minutes**) to set the shooting interval.
- The maximum number of images that can be captured depends on the selected interval.
 - **Shoot every 30 seconds:** Approx. 400 images
 - **Shoot once a minute:** Approx. 210 images
 - **Shoot every 5 minutes:** Approx. 40 images
- When using this feature, use a fully charged battery to prevent the camera from turning off unexpectedly.
- When the camera detects a person's face, it focuses on that face (📖 60).
- If no faces are detected, the camera focuses on the subject in the center of the frame.
- Press the shutter-release button all the way down to capture the first image. In between each shot, the monitor turns off and the power-on lamp flashes. The monitor automatically turns on again just before the next image is captured.
- Press the shutter-release button halfway to stop shooting.
- The flash is set to **🔍AUTO Auto flash**, but the setting can be changed (📖 35).
- The self-timer is not available (📖 37).

Shoot under water

- Use when taking pictures underwater.
- The closest distance at which the camera can focus varies depending on the zoom position. When the zoom is set to a position where the zoom indicator turns green, the camera can focus on subjects as close as about 20 cm (8 in.) from the front of the protective glass. When the zoom is at the maximum wide-angle position, the camera can focus on subjects as close as about 5 cm (2 in.) from the front of the protective glass.
- The camera focuses on the subject in the center of the frame.
- Digital zoom cannot be used.
- See “<Important> Shockproof, Waterproof, Dustproof, Condensation” (📖 xv) for more information about using the camera underwater.
- The camera focuses even when the shutter-release button is not pressed halfway. You may hear the sound of the camera focusing.
- The flash may be unable to light the entire subject at distances of less than 50 cm (1 ft 8 in.).
- The flash is set to  **Flash off**, but the setting can be changed (📖 35).
- The self-timer can be set, but  **Smile timer** is not available (📖 37, 39).

Take a series of pictures

- The camera captures a series of still images that allow you to clearly see detailed movements in a moving subject.
- When the camera detects a person’s face, it focuses on that face (📖 60).
- If no faces are detected, the camera focuses on the subject in the center of the frame.
- Press and hold the shutter-release button all the way to capture four images at a rate of about 1.5 frames per second (fps) (when **Choose a size > Photo size** is set to  **Large (10 megapixels)**) (📖 54).
- Focus, exposure, and hue are fixed at the values determined with the first image in each series.
- The frame rate with continuous shooting may vary depending upon the current photo size setting, the memory card used, or shooting condition.
- The flash setting is fixed at  **Flash off** (📖 35).
- The self-timer is not available (📖 37).

🌸 Photograph fireworks







- The camera focuses at infinity.
- The focus indicator (📖 5) always turns green when the shutter-release button is pressed halfway.
- The flash setting is fixed at 📖 **Flash off** (📖 35).
- The self-timer is not available (📖 37).

🌀 Mirror





- You can take pictures that are laterally symmetrical over the center of the frame.
- The closest distance at which the camera can focus varies depending on the zoom position. When the zoom is set to a position where the zoom indicator turns green, the camera can focus on subjects as close as about 20 cm (8 in.) from the front of the protective glass. When the zoom is at the maximum wide-angle position, the camera can focus on subjects as close as about 5 cm (2 in.) from the front of the protective glass.
- The camera focuses on the area in the center of the frame.
- The right half of the screen is shaded. The unshaded left half is flipped to become the image of the right half. Frame the subject so that the image becomes laterally symmetrical over the center line of the screen.
- The camera focuses even when the shutter-release button is not pressed halfway. You may hear the sound of the camera focusing.
- The flash may be unable to light the entire subject at distances of less than 50 cm (1 ft 8 in.).
- The flash is set to 📖 **AUTO Auto flash**, but the setting can be changed (📖 35).
- The self-timer can be set, but 📖 **Smile timer** is not available (📖 37, 39).

📖: Shutter speed is reduced when using styles indicated with 📖; therefore, the use of a tripod is recommended.

Take soft pictures

- Softens the image by adding a slight blur to areas outside of the guide displayed in the monitor.
- The closest distance at which the camera can focus varies depending on the zoom position. When the zoom is set to a position where the zoom indicator turns green, the camera can focus on subjects as close as about 20 cm (8 in.) from the front of the protective glass. When the zoom is at the maximum wide-angle position, the camera can focus on subjects as close as about 5 cm (2 in.) from the front of the protective glass.
- The camera focuses on the area in the center of the frame.
- Digital zoom cannot be used.
- A guide is displayed in the monitor. Compose the shot so that the main subject is contained within the guide.
- The camera focuses even when the shutter-release button is not pressed halfway. You may hear the sound of the camera focusing.
- The flash may be unable to light the entire subject at distances of less than 50 cm (1 ft 8 in.).
- The flash is set to  **AUTO Auto flash**, but the setting can be changed ( 35).
- The self-timer can be set, but  **Smile timer** is not available ( 37, 39).

Create a diorama effect

- This effect is well-suited for images captured from a high vantage point with the main subject in the center of the image.
- The closest distance at which the camera can focus varies depending on the zoom position. When the zoom is set to a position where the zoom indicator turns green, the camera can focus on subjects as close as about 20 cm (8 in.) from the front of the protective glass. When the zoom is at the maximum wide-angle position, the camera can focus on subjects as close as about 5 cm (2 in.) from the front of the protective glass.
- The camera focuses on the subject in the center of the frame.
- Digital zoom cannot be used.
- A guide is displayed in the monitor. Compose the shot so that the main subject is contained within the guide.
- The camera focuses even when the shutter-release button is not pressed halfway. You may hear the sound of the camera focusing.
- The flash may be unable to light the entire subject at distances of less than 50 cm (1 ft 8 in.).
- The flash is set to  **Flash off**, but the setting can be changed ( 35).
- The self-timer can be set, but  **Smile timer** is not available ( 37, 39).

Decorate

You can add a frame around your images when taking pictures. Seven different frames are available.

Enter shooting mode → flexible button 3 (SCENE) → flexible button 3 (Decorate)

- The **Choose a size** > **Photo size** setting is fixed at **Small (2 megapixels)** (📖 54).

1 Press the multi selector ◀ or ▶ to select a frame, and then press flexible button 4 (OK).

- To cancel, press flexible button 1 (↵).
- You can press flexible button 3 (❌) to cancel the frame.

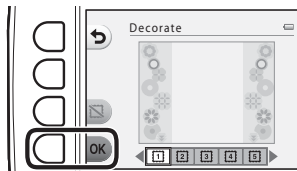

2 Frame the subject and take a picture.

- The frame is added to the picture.

✓ Notes About Decorate

- The area that is captured becomes smaller when a thicker frame is selected.
- When using borderless printing to print images that you have added frames to, the frames may not be printed.
- Images captured using **Decorate** cannot be edited using **Picture play** (📖 66) functions and cannot be cropped (📖 64).

✓ Features That Cannot Be Used Simultaneously

Some settings cannot be used with other functions (📖 58).

Change Colors

You can adjust brightness (exposure compensation) and vividness when taking pictures. You can also select one color to keep in your pictures and turn the rest of the colors to shades of black and white.

Enter shooting mode → flexible button 3 (SCENE) → flexible button 4 (Change colors)

- 1 Press flexible button 2 (Brighter/darker), flexible button 3 (More vivid/less vivid), or flexible button 4 (Highlight colors).

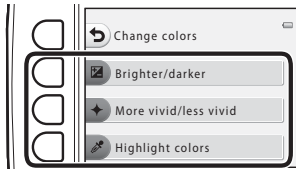

- 2 Press the multi selector button ◀ or ▶ to select the brightness, vividness, or to select the color you want to highlight.

- The screen displayed when **Brighter/darker** is selected in step 1 is used here as an example. Refer to the following information for details about each setting.
 - **Brighter/darker** (Adjusting Brightness (Exposure Compensation) (51))
 - **More vivid/less vivid** (Adjusting Vividness (Saturation) (51))
 - **Highlight colors** (51)
- Press flexible button 3 (RESET) to turn the effect off.

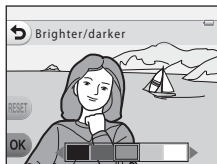

3 Press flexible button 4 (OK).

- To cancel, press flexible button 1 (↩).

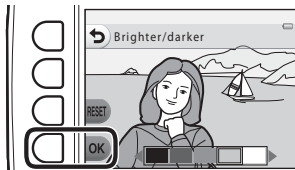

4 Frame the subject and take a picture.

✓ Features That Cannot Be Used Simultaneously

Some settings cannot be used with other functions (📖 58).

✎ Notes About Change Colors

- The **Brighter/darker**, **More vivid/less vivid** and **Highlight colors** settings are saved in the camera's memory even after the camera is turned off.
- Images adjusted with **Change colors** are indicated by 📷.

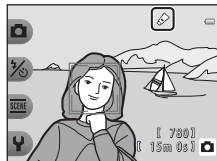

Adjusting Brightness (Exposure Compensation)

You can adjust the overall brightness of the image.

- Press ◀ and move the cursor to the left to make the overall image darker. Press ▶ and move the cursor to the right to make it brighter.

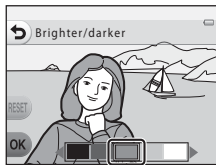

Cursor

◆ Adjusting Vividness (Saturation)

You can adjust the overall vividness of the image.

- Press ◀ and move the cursor to the left to make the overall image more dull. Press ▶ and move the cursor to the right to make it more vivid.



Cursor

Highlight Colors

Keep one specified color in the image, and change the other colors to black and white.

- Press the multi selector ◀ or ▶ to move the cursor and select the color to highlight.



Cursor

Change Sounds

Allows you to configure the shutter and button sounds. You can select one of eight different sounds, or turn sounds off.

Enter shooting mode → flexible button 4 (🔇) → flexible button 2 (🎵 Change sounds)

📷 Pick a shutter sound

Allows you to select the sound heard when the shutter is released and when the focus has been locked.

When using **Take a series of pictures** (📖 45) or when recording movies, the shutter sound is not heard.

- If you select 🎵, the shutter sound and the sound heard when the focus has been locked are muted.

📷 Pick a button sound

Allows you to select the beep heard when the camera switches between shooting and playback modes, when using the menus, when the camera is connected to a computer or printer, etc.

- Regardless of this setting, standard sounds are heard when an error occurs and when the camera is turned on.
- If you select 🎵, button sounds and the sound heard when an error occurs and when the camera is turned on are muted.

🔇 Turn sound off



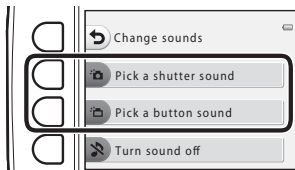

When the mute is canceled, the shutter sound and button sound used before muting will be used again.

1 Press flexible button 2 or flexible button 3.

- 📷 **Pick a shutter sound:** Set the shutter sound.
- 📷 **Pick a button sound:** Set the button sound.
- Press flexible button 4 (🔇 **Turn sound off**) to mute all sounds.
To cancel the mute, press this button again.



2 Press the multi selector ◀ or ▶ to select the type of sound.

- : Set the standard sounds.
- : Sounds are not heard.
- Press flexible button 3 (▶) to play the selected sound.
- To cancel, press flexible button 1 (◀).
- The screen displayed when  **Pick a shutter sound** was selected in step 1 is shown here as an example, but the procedure is the same if you select  **Pick a button sound**.

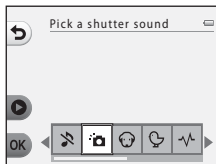

3 Press flexible button 4 (OK).

- The sound is set.

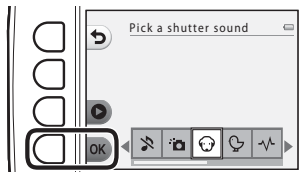

✓ Features That Cannot Be Used Simultaneously

Some settings cannot be used with other functions (📖 58).

Choose a Size

Set the size of pictures (still images) and movies.

Choose a Photo Size

You can select the combination of image size and image quality (i.e., image compression ratio) that is used when saving images. The higher the image mode setting, the larger the size at which images can be printed, and the lower the compression ratio, the higher the quality of the images, but the number of images that can be saved ( 55) decreases.



Enter shooting mode → flexible button 4 () → flexible button 3 ( Choose a size) → flexible button 2 ( Photo size)

Photo size ¹	Size ¹ (pixels)	Compression ratio	Aspect ratio	Print size ² (cm/in.)
■ Large (10 megapixels) (default setting)	3648 × 2736	approx. 1:4	4:3	approx. 31 × 23/ 12 × 9
■ Medium (4 megapixels)	2272 × 1704	approx. 1:8	4:3	approx. 19 × 14/ 7.5 × 5.6
■ Small (2 megapixels)	1600 × 1200	approx. 1:8	4:3	approx. 13 × 10/ 5.3 × 4

¹ The total number of pixels captured, and the number of pixels captured horizontally and vertically. Example: ■ **Large (10 megapixels)** = approx. 10 megapixels, 3648 × 2736 pixels

² Print size at an output resolution of 300 dpi.

Print sizes are calculated by dividing the number of pixels by printer resolution (dpi) and multiplying by 2.54 cm (1 in.). However, at the same image size, images printed at higher resolutions will be printed smaller than the size indicated, and those printed at lower resolutions will be printed larger than the size indicated.

Features That Cannot Be Used Simultaneously

Some settings cannot be used with other functions ( 58).

Setting the Photo Size

- This setting also applies to **Choose a style** and **Change colors**.
- When **Decorate** ( 48) is selected, **Photo size** cannot be selected.

Number of Images That Can Be Saved

The following table lists the approximate number of images that can be saved on a 4 GB memory card. Note that due to JPEG compression, the number of images that can be saved varies greatly depending on the composition of the image, even when memory capacity and image mode settings remain constant. The number of images that can be saved may also vary depending on the type of memory card being used.

Photo size	Number of images that can be saved (4 GB)
■ Large (10 megapixels) (default setting)	780
■ Medium (4 megapixels)	3820
■ Small (2 megapixels)	7250



- If the number of exposures remaining is 10,000 or more, the number of exposures remaining display shows “9999”.
- To confirm the number of images that can be saved in the internal memory (approx. 26 MB), remove the memory card from the camera, and then check the number of remaining exposures displayed in the monitor when shooting.

Choose a Movie Frame Size

Select the desired movie type to record.

Larger image sizes mean greater image quality and larger movie file sizes.

Enter shooting mode → flexible button 4 (P) → flexible button 3 (M) Choose a size) → flexible button 3 (M) Movie frame size)

Movie frame size	Image size (number of pixels) Aspect ratio
 Large (720p) (default setting)*	1280 × 720 16:9
 Small (640)	640 × 480 4:3

* When no memory card is inserted (i.e., when using the camera's internal memory), the setting is fixed at  **Small (640)**.

- The frame rate is approx. 30 frames per second for all movie frame sizes.





Notes About Frame Rates

The frame rate is the number of frames per second.

Maximum Movie Recording Time

The following table lists the approximate recording time available when using a 4 GB memory card. Actual recording time and file size may vary depending on subject movement and image composition, even when memory capacity and movie frame size remain constant.

Available recording time may also vary depending on the type of memory card being used.

Movie frame size	Maximum recording time (4 GB) ²
 Large (720p) ¹	15 min
 Small (640)	45 min

¹ When no memory card is inserted (i.e., when using the camera's internal memory), the setting is fixed at  **Small (640)**.

² The maximum size for a single movie is 4 GB, and the maximum recording time for a single movie is 29 minutes, even when there is sufficient free space on the memory card. When recording a movie, the remaining recording time that is displayed is the amount of recording time available for one movie. If the camera becomes hot, movie recording may stop before these limits are reached.

- To confirm the maximum length of a movie that can be recorded in the internal memory (approx. 26 MB), remove the memory card from the camera, and then check the maximum recording time displayed in the monitor when shooting.

More Information

File and Folder Names →  61

Features That Cannot Be Used Simultaneously

Certain features cannot be used simultaneously.

Restricted function	Option	Description
Flash	Choose a style (📖 42)	Flash cannot be used when taking pictures using Photograph food , Take a series of pictures , or Photograph fireworks .
Self-timer	Choose a style (📖 42)	Self-timer cannot be used when taking pictures using Shoot at intervals , Take a series of pictures , or Photograph fireworks .
Smile timer	Choose a style (📖 42)	Smile timer cannot be used when any option in Choose a style is enabled.
	Highlight colors (📖 51)	Smile timer cannot be used when Highlight colors option is enabled.
Decorate	Smile timer (📖 39)	Decorate cannot be used when taking pictures using smile timer.
	Choose a style (📖 42)	Decorate cannot be used when any option in Choose a style is enabled.
Change colors	Smile timer (📖 39)	Change colors cannot be used when taking pictures using smile timer.
	Choose a style (📖 42)	Change colors cannot be used when any option in Choose a style is enabled.
Pick a shutter sound	Take a series of pictures (📖 45)	Shutter sound is not heard when taking pictures using Take a series of pictures .
Photo size	Decorate (📖 48)	The Photo size setting is fixed at Small (2 megapixels) when taking pictures using Decorate .
Print date	Take a series of pictures (📖 45)	The shooting date is not imprinted on the images when taking pictures using Take a series of pictures .

Restricted function	Option	Description
Electronic VR	Choose a style (📖 42)	Electronic VR is not available when taking pictures using Shoot at intervals , Take a series of pictures , or Photograph fireworks .
Digital zoom	Smile timer (📖 39)	Digital zoom cannot be used when taking pictures using smile timer.
	Choose a style (📖 42)	Digital zoom cannot be used when taking pictures using Shoot under water , Take soft pictures , or Create a diorama effect .

Using Face Detection

When using the following shooting modes and settings, the camera uses face detection to automatically focus on people's faces. If the camera detects more than one face, a double border is displayed around the face that the camera focuses on, and single borders are displayed around the other faces.

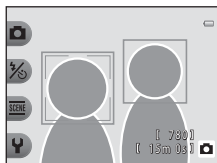

Shooting mode	Number of faces that can be detected	Focus area (double border)
Point and shoot (📖 34)	Up to 12	The face closest to the camera
Shoot at intervals (📖 44) and Take a series of pictures (📖 45) when using Choose a style		
Smile timer (📖 39)	Up to 3	The face closest to the center of the frame

- If no faces are detected when the shutter-release button is pressed halfway, the camera focuses on the subject in the center of the frame.

Notes About Face Detection

- The camera's ability to detect faces depends on a variety of factors, including whether or not the subject is facing the camera. Additionally, the camera may be unable to detect faces in the following situations:
 - When faces are partially hidden by sunglasses or otherwise obstructed
 - When faces take up too much or too little of the frame
- When the frame includes more than one person's face, the faces detected by the camera and the face on which the camera focuses depend upon a variety of factors, including the direction in which the faces are looking.
- In some rare cases, such as those described in "Subjects Not Suitable for Autofocus" (📖 62), the subject may not be in focus even though the double border turns green. Should this occur, try focus lock shooting (📖 61) by focusing on another subject that is the same distance from the camera.

Focus Lock

When the camera focuses on an object in the center of the frame, you can use focus lock to focus on an off-center subject. The following explains how to use focus lock when  Point and shoot is enabled and the focus area is displayed in the center of the frame.

1 Aim the camera at the subject so that the subject is in the center of the frame.

2 Press the shutter-release button halfway.

- Confirm that the focus area turns green.
- Focus and exposure are locked.

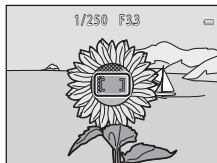

3 Continue holding down the shutter-release button halfway and recompose the picture.

- Be sure to maintain the same distance between the camera and the subject.

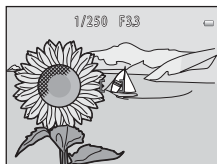

4 Press the shutter-release button the rest of the way down to take the picture.



Subjects Not Suitable for Autofocus

The camera may not focus as expected in the following situations. In some rare cases, the subject may not be in focus despite the fact that the focus area or the focus indicator turns green:

- Subject is very dark
- Objects of sharply differing brightness are included in the scene (e.g. the sun behind the subject makes that subject appear very dark)
- No contrast between the subject and surroundings (e.g. a portrait subject, wearing a white shirt, is standing in front of a white wall)
- Several objects are at different distances from the camera (e.g. an animal inside a cage)
- Subjects with repeating patterns (window blinds, buildings with multiple rows of similarly shaped windows, etc.)
- Subject is moving rapidly

In the situations noted above, try pressing the shutter-release button halfway repeatedly, or try focus lock shooting by focusing on another subject that is the same distance from the camera ( 61).

Playback Features

This chapter describes the features that are available when playing back images.

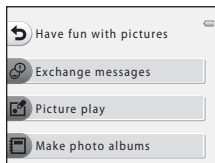

Playback Zoom	64
Thumbnail Display	65
Features Available in Playback Mode (Playback Menu) ...	66
Connecting the Camera to a TV, Computer, or Printer ...	68
Using ViewNX 2.....	70
Installing ViewNX 2.....	70
Transferring Images to the Computer	73
Viewing Images.....	75

Playback Zoom

Press the multi selector ▲ during full-frame playback mode (📖 26) to zoom in on the center of the image displayed in the monitor or on the face detected at the time of shooting if a face was detected.

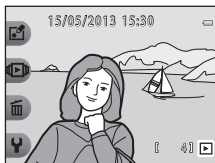

Image is displayed full-frame.



Image is zoomed in.

- You can change the zoom ratio by pressing ▲ or ▼. Images can be zoomed up to approx. 10x.
- To move the displayed area, press flexible button 3 (🔒) to lock the zoom ratio, and then press ▲, ▼, ◀, or ▶.
If you want to change the zoom ratio, press flexible button 3 (🔓) and then change the zoom ratio as desired.
- If you are viewing an image that was captured using face detection (📖 60), the camera zooms in on the face detected at the time of shooting (except when viewing an image captured using **Shoot at intervals** or **Take a series of pictures**). If the camera detected multiple faces when the image was captured, press ▲, ▼, ◀, or ▶ to display a different face. To zoom in on an area of the image where there are no faces, press flexible button 3 (🔓) and then press ▲.
- Press flexible button 1 (✂) to return to full-frame playback mode.

✂ Crop: Creating a Cropped Copy

When using playback zoom, you can crop the image and save the displayed area of the image as a separate file by pressing flexible button 4 (📄). The created image is indicated by ✂ during playback.

- As the area to be saved is reduced, the image size (pixels) of the cropped copy is also reduced.

📄 More Information

File and Folder Names → 📄61

Thumbnail Display

Press the multi selector ▼ in full-frame playback mode (📖 26) to display images in contact sheets of thumbnail images.

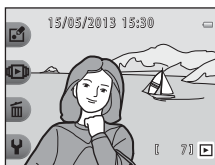

Full-frame display





























Image thumbnail display

- You can view multiple images on one screen, making it easy to find the image you want.
- Press ◀ or ▶ to select an image, and the selected image is magnified and displayed at the center of the screen. Select an image and press ▲, and the selected image is displayed in the full-frame playback mode.

Features Available in Playback Mode (Playback Menu)

When viewing images in full-frame playback mode, you can select one of the flexible buttons () and display the corresponding menu.

Playback menu	Option	Description	
 Have fun with pictures	Exchange messages ¹	Allows you to add voice messages to your images.	 2
	Picture play ¹	Allows you to edit your pictures using a variety of features.	 7
	Make photo albums ¹	Allows you to display images similarly to a photo album.	 17
 View	Favorites	Allows you to add your favorite images to favorites. This makes it easier to find the images you are looking for. You can also protect selected images from accidental deletion.	 19
	Slide show	Allows you to play back images, saved in the internal memory or on a memory card, one by one in an automated slide show.	 21
	View movie ²	Allows you to play back movies ( 81).	 81

Playback menu	Option	Description	
 Erase	Erase this picture only	Allows you to delete only the image currently displayed ( 28).	 28
	Erase selected pictures	Allows you to select multiple images and delete them ( 29).	 29
	Erase all pictures	Allows you to delete all images ( 28).	 28
 Settings	More playback options	Allows you to select a date and view images that were captured on that date or play back images added to favorites.	 27,  29
	Print order/retouch	Allows you to copy or rotate images or create a small copy of the current image. You can also specify the image to be printed and the number of copies to be printed.	 30,  33,  34,  35
	Camera settings	Allows you to change a number of general settings.	 38

¹ Available when a still image is displayed.

² Available when a movie is displayed.

Connecting the Camera to a TV, Computer, or Printer

You can enhance your enjoyment of images and movies by connecting the camera to a TV, computer, or printer.

- Before connecting the camera to an external device, make sure the remaining battery level is sufficient and turn the camera off. For information about the connection methods and subsequent operations, refer to the documentation included with the device in addition to this document.

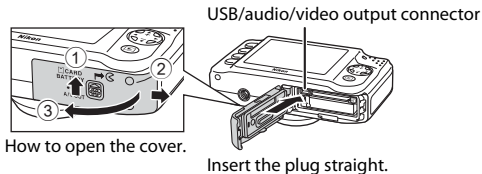

Viewing images on a TV

 50

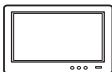

You can view the camera's images and movies on a TV.
Connection method: Connect the video and audio plugs of the optional audio/video cable to the TV's input jacks.

Viewing and organizing images on a computer

 70



If you transfer images to a computer, you can perform simple retouching and manage image data in addition to playing back images and movies.

Connection method: Connect the camera to the computer's USB input jack with the included USB Cable UC-E16.

- Before connecting to a computer, install ViewNX 2 on the computer using the included ViewNX 2 CD-ROM. For information about using the ViewNX 2 CD-ROM and transferring images to a computer, see page 70.

Printing images without using a computer

 53



If you connect the camera to a PictBridge-compatible printer, you can print images without using a computer.

Connection method: Connect the camera directly to the printer's USB input jack with the included USB cable.

Using ViewNX 2

ViewNX 2 is an all-in-one software package which enables you to transfer, view, edit and share images.

Install ViewNX 2 using the included ViewNX 2 CD-ROM.



Installing ViewNX 2

- An Internet connection is required.

Compatible Operating Systems

Windows

Windows 8, Windows 7, Windows Vista, Windows XP

Macintosh

Mac OS X 10.6, 10.7, 10.8

Refer to the Nikon website for details on system requirements, including the latest information on operating system compatibility.

1 Start the computer and insert the ViewNX 2 CD-ROM into the CD-ROM drive.

- Windows: If instructions for operating the CD-ROM are displayed in the window, follow the instructions to proceed to the installation window.
- Mac OS: When the **ViewNX 2** window is displayed, double-click the **Welcome** icon.

2 Select a language in the language selection dialog to open the installation window.

- If the desired language is not available, click **Region Selection** to choose a different region and then choose the desired language (the **Region Selection** button is not available in the European release).
- Click **Next** to display the installation window.



3 Start the installer.

- We recommend clicking **Installation Guide** in the installation window to check the installation help information and system requirements before installing ViewNX 2.
- Click **Typical Installation (Recommended)** in the installation window.

4 Download the software.

- When the **Software Download** screen is displayed, click **I agree - Begin download**.
- Follow the on-screen instructions to install the software.

5 Exit the installer when the installation completion screen is displayed.

- Windows: Click **Yes**.
- Mac OS: Click **OK**.

The following software is installed:

- ViewNX 2 (consisting of the three modules below)
 - Nikon Transfer 2: For transferring images to the computer
 - ViewNX 2: For viewing, editing, and printing transferred images
 - Nikon Movie Editor: For basic editing of transferred movies
- Panorama Maker (for creating a single panorama photo using a series of separate images)

6 Remove the ViewNX 2 CD-ROM from the CD-ROM drive.

Transferring Images to the Computer

1 Choose how images will be copied to the computer.

Choose one of the following methods:

- **Direct USB connection:** Turn the camera off and ensure that the memory card is inserted in the camera. Connect the camera to the computer using the included USB cable. Turn the camera on. To transfer images that are saved in the camera's internal memory, remove the memory card from the camera before connecting it to the computer.

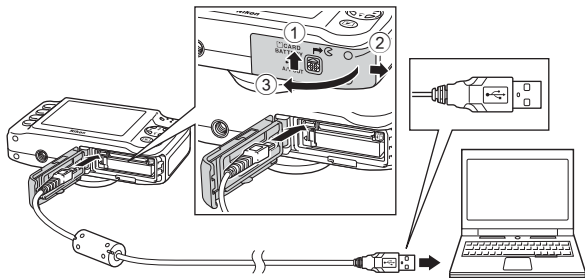

- **SD card slot:** If your computer is equipped with an SD card slot, the card can be inserted directly in the slot.
- **SD card reader:** Connect a card reader (available separately from third-party suppliers) to the computer and insert the memory card.

Connecting the USB Cable

The connection may not be recognized if the camera is connected to the computer via a USB hub.

If a message is displayed prompting you to choose a program, select Nikon Transfer 2.

- **When using Windows 7**

If the dialog shown at right is displayed, follow the steps below to select Nikon Transfer 2.

- 1 Under **Import pictures and videos**, click **Change program**. A program selection dialog will be displayed; select **Import File using Nikon Transfer 2** and click **OK**.
- 2 Double-click **Import File**.



If the memory card contains a large number of images, it may take a while for Nikon Transfer 2 to start. Wait until Nikon Transfer 2 starts.

2 Transfer images to the computer.

- Confirm that the name of the connected camera or removable disk is displayed as the "Source" on the "Options" title bar of Nikon Transfer 2 (①).
- Click **Start Transfer** (②).

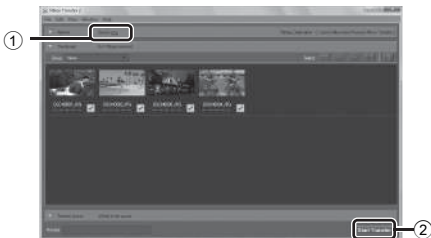

- At default settings, all the images on the memory card will be copied to the computer.

3 Terminate the connection.

- If the camera is connected to the computer, turn the camera off and disconnect the USB cable. If you are using a card reader or card slot, choose the appropriate option in the computer operating system to eject the removable disk corresponding to the memory card and then remove the card from the card reader or card slot.

Viewing Images

Start ViewNX 2.

- Images are displayed in ViewNX 2 when transfer is complete.
- Consult online help for more information on using ViewNX 2.



Starting ViewNX 2 Manually

- **Windows:** Double-click the **ViewNX 2** shortcut icon on the desktop.
- **Mac OS:** Click the **ViewNX 2** icon in the Dock.



A series of ten horizontal dashed lines spanning the width of the page, intended for handwriting practice.

Recording and Playing Back Movies

You can record movies by simply pressing the  movie-record button.

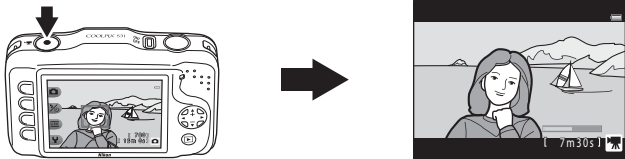

Recording Movies	78
Playing Back Movies.....	81

Recording Movies

You can record movies by simply pressing the **●** (🎥 movie-record) button.

When no memory card is inserted (i.e., when using the camera's internal memory), the movie frame size (📖 56) setting is fixed at **Small (640)**. **Large (720p)** is not available.

1 Display the shooting screen.

- You can select the movie frame size that is recorded. The default setting is **Large (720p)** (1280 × 720) (📖 56).
- When recording movies, the angle of view (i.e., the area visible in the frame) is narrower compared to that of still images.

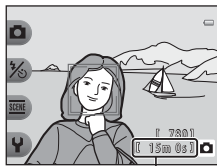

Maximum recording time

2 Press the **●** (🎥 movie-record) button to start recording a movie.

- The camera focuses on the subject in the center of the frame. Focus areas are not displayed during recording.
- When movie frame size is set to **Large (720p)** (1280 × 720), the monitor display changes to a 16:9 aspect ratio when recording movies.
- **📖** is displayed while saving to the internal memory.

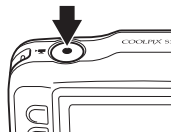





3 Press the **●** (🎥 movie-record) button again to end recording.

Notes About Saving Movies

After a movie has been recorded, it is not fully saved to the internal memory or memory card until monitor display returns to the shooting display. **Do not open the battery-chamber/memory card slot cover.** Removing the memory card or the battery while a movie is being saved may result in loss of the movie data or damage to the camera or to the memory card.

Notes About Movie Recording

- Memory cards with an SD Speed Class rating of 6 or faster are recommended when recording movies (:22). Movie recording may stop unexpectedly when memory cards with a lower Speed Class rating are used.
- The optical zoom ratio cannot be changed once recording starts.
- Use the multi selector  or  to operate digital zoom while recording movies. The zoom range is between the optical zoom ratio before recording a movie and up to 4x.
- Image quality degrades when digital zoom is used. When recording ends, digital zoom turns off.
- The sounds of multi selector operation, autofocus lens drive movement, and aperture operation when brightness changes may be recorded.
- Smear (:4) visible in the monitor with movie recording is recorded with movies. Avoiding bright objects such as the sun, reflections of the sun, and electric lights is recommended.
- Depending on the distance to the subject or the amount of zoom applied, subjects with repeating patterns (fabrics, lattice windows, etc.) may have colored stripes (interference patterns, moire, etc.) in them during movie recording and playback. This occurs when the pattern in the subject and the layout of the image sensor interfere with each other; it is not a malfunction.

Camera Temperature

- The camera may become warm when recording movies for an extended period of time or when the camera is used in a hot area.
- If the inside of the camera becomes extremely hot when recording movies, the camera will automatically stop recording after 10 seconds. The amount of time remaining until the camera stops recording (10s) is displayed. After the camera stops recording, it turns itself off. Leave the camera off until the inside of the camera has cooled.

Notes About Autofocus

Autofocus may not perform as expected (📖 62). Should this occur, try the following.

Frame another subject—positioned at the same distance from the camera as the intended subject—in the center of the frame, press the ● (🎬 movie-record) button to start recording, and then modify the composition.

Functions Available with Movie Recording



- The current setting for **Shoot close-ups** (📖 43), **Photograph food** (📖 43), **Shoot under water** (📖 45), **Brighter/darker** (📖 51), or **More vivid/less vivid** (📖 51) is applied when recording movies. Confirm settings before starting movie recording.
- The self-timer (📖 37) can be used. When the self-timer is enabled, the camera starts recording 10 seconds after you press the ● (🎬 movie-record) button.
- The flash does not fire.
- You can set the movie recording size (📖 56) before you start recording a movie by pressing a flexible button.

More Information

- Maximum Movie Recording Time → 📖 57
- File and Folder Names → 📷61

Playing Back Movies

1 Press the  (shooting/playback mode) button to switch to playback mode.

2 Press the multi selector  or  to select a movie and then press flexible button 2 ()

- Movies can be identified by the movie recording time indicator ( 6).

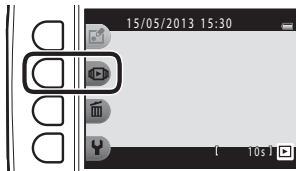

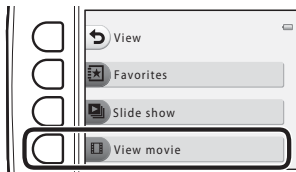

3 Press flexible button 4 ( **View movie**).

- You can play movies.



Deleting movies

To delete a movie, select the desired movie in full-frame playback mode ( 26) and then press flexible button 3 ()

Functions Available During Playback

You can use the flexible buttons to perform the following operations.

Paused



During playback

Volume indicator

Function	Icon	Description
Advance		Hold down the button to advance the movie.
Rewind		Hold down the button to rewind the movie.
Pause		Press the button to pause playback. The following operations can be performed while playback is paused.
		Press to advance the movie by one frame. Press and hold to advance the movie frame by frame.
		Press to rewind the movie by one frame. Press and hold to rewind the movie frame by frame.
		Press the button to resume playback.
End		Press the button to return to full-frame playback mode.

Adjusting Volume

Press the multi selector ▲ or ▼ during playback.

Notes About Playing Back Movies

This camera cannot play back movies recorded with another make or model of digital camera.

General Camera Setup

This chapter describes the various settings that can be adjusted in the  camera settings menu.

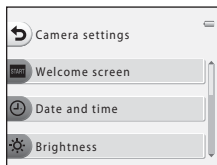
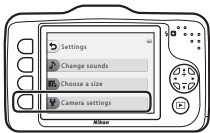













- See “Using the Flexible Buttons” (📖 7) for information about using the camera’s menus.
- For further details about each setting, refer to “ Camera Settings” in the Reference Section (🔍 38).

Camera Settings Menu

Enter shooting mode or playback mode → flexible button 4 (P) → flexible button 4 (P Camera settings)

The following items can be set in the camera settings menu:

Option	Description	
Welcome screen	Allows you to select whether or not the welcome screen is displayed when the camera is turned on.	 38
Date and time	Allows you to set the camera clock.	 39
Brightness	Allows you to adjust the brightness of the monitor.	 40
Print date	Allows you to imprint the shooting date on images.	 41
Electronic VR	Allows you to choose whether to use electronic VR (vibration reduction) when taking still pictures.	 42
AF assist	Allows you to enable and disable the AF-assist illuminator.	 43
Format memory/ Format card	Allows you to format the internal memory or the memory card.	 44
Language	Allows you to change the camera's display language.	 45
Menu background	Allows you to change the background used on the menu screen.	 46
Video mode	Allows you to adjust TV-connection settings.	 46
Reset all	Allows you to reset the camera's settings to their default values.	 47
Firmware version	Allows you to confirm the camera's firmware version.	 49



Reference Section

The Reference Section provides detailed information and hints about using the camera.

Have Fun with Pictures

Exchange Messages.....	2
Picture Play	7
Make Photo Albums	17

View

Favorites	19
Slide Show	21
View Movie	26

Settings

More Playback Options.....	27
Print Order/Retouch	30
Camera Settings	38

Connections

Connecting the Camera to a TV	50
Connecting the Camera to a Printer	52



Additional Information

File and Folder Names	61
Optional Accessories	63
Error Messages	64

Exchange Messages

You can record voice messages using the camera's microphone and attach the messages to your pictures.

- You can attach up to two messages to each image.

Enter playback mode → select an image → flexible button 1 () → flexible button 2 ( Exchange messages)

Leave a Message

- 1 Press flexible button 2 ( **Record**).



- 2 Press flexible button 2 ( **Leave a message**).

- You cannot select this option if the image already has a message attached to it. → "Leave a Reply" (4)



3 Press flexible button 2 (○).

- Recording starts. You can record a message for up to about 20 seconds.
- Press flexible button 2 (○) again to stop recording.
- Do not touch the camera's microphone during recording.
- If battery power runs out, recording stops automatically.
- The message is saved when you press flexible button 4 (OK) in step 4. You can re-record the message as long as you do not press flexible button 4.
- Press flexible button 3 (⏮) to play back the message.
- Press flexible button 1 (⏪) before or after recording a message to return to step 2.

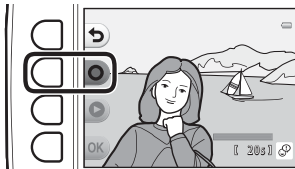

4 Press flexible button 4 (OK).

- **Message recorded** is displayed and the message is attached to the image.
- Images that have a recorded message are indicated by (🗣️) displayed during playback.

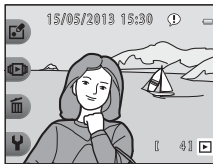
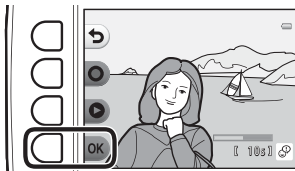

Leave a Reply

- 1 Press flexible button 2 (○ Record).



- 2 Press flexible button 3 (🗉 Leave a reply).

- You cannot select this option if the image does not have a message attached to it. → "Leave a Message" (🗉2)



- 3 Press flexible button 2 (○).

- Once recording starts, the operations are the same as explained in "Leave a Message" (🗉2).
- Images that have a recorded reply are indicated by 🗉 displayed during playback.

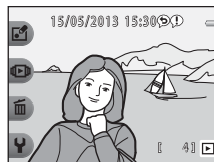
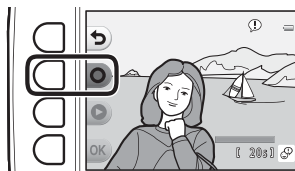

Play Recordings

Press flexible button 3 (▶ **Play recordings**).

- The camera plays the message. If two messages have been recorded, they are played back to back.
- Press flexible button 1 (⏮) to stop playback.
- Press the multi selector ▲ or ▼ during playback to adjust playback volume.
- If battery power runs out, playback stops automatically.

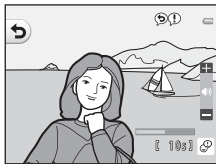

Erase Recordings

1 Press flexible button 4 (🗑 **Erase recordings**).

- If you select an image that has been added to favorites (🔖19), a confirmation message is displayed.
 - **○ Yes:** Removes the image from favorites and displays the screen displayed in step 2.
 - **✗ No:** Returns to step 1.

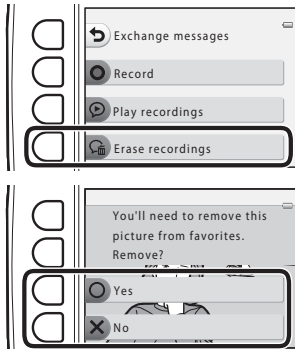

2 When the confirmation message is displayed, press flexible button 3 (O Yes).

- Only the message is deleted. If both a message and a reply have been recorded, they are both deleted.

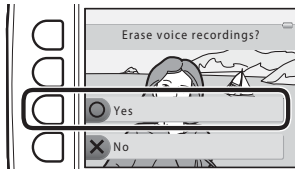

Notes About Exchange Messages

















- When an image with messages attached is deleted, both the image and its messages are deleted.
- Messages cannot be recorded for an image that already has two messages attached to it. To change the contents of the recording, delete the message and then re-record it.
- This camera cannot attach messages to images captured with another make or model of digital camera.

More Information

File and Folder Names → 61

You can use the following features to edit your images. Edited images are saved as separate files (61).

Picture Play Features

Editing function	Description
 Soften pictures ( 9)	Soften the image by adding a slight blur around the center of the image.
* Add starbursts ( 10)	Produce star-like rays of light that radiate outward from bright objects such as sunlight reflections or street lights. This effect is suitable for night scenes.
 Add a fisheye effect ( 11)	Make an image look as if it were captured with a fisheye lens. This effect is well-suited for images captured using Shoot close-ups ( 43).
 Add a diorama effect ( 12)	Make an image look like a miniature scene captured in macro mode. This effect is well-suited for images captured from a high vantage point with the main subject in the center of the image.
 Toy camera ( 13)	Make an image look as if it were shot with a toy camera. This effect is well-suited for landscapes.
 Change colors ( 14)	Four different colors are available.
 Highlight colors ( 15)	Keep one specified color in the image, and change the other colors to black and white.
 Decorate ( 16)	Add a frame around the image. Seven different frames are available.

Notes About Picture Play

- This camera cannot edit images captured with another make or model of digital camera.
- Edited copies created with this camera may not be displayed properly on another make or model of digital camera. It may also be impossible to transfer them to a computer using another make or model of digital camera.
- Editing functions are not available when there is not enough free space in the internal memory or on the memory card.



Restrictions on Editing

When an edited copy is further modified with another editing function, check the following restrictions.



Editing function used	Editing functions that can be added
Soften pictures, Add starbursts, Add a fisheye effect, Add a diorama effect, Toy camera, Change colors, Highlight colors	Decorate, Make photo albums, Small picture, Rotate pictures , or crop can be added.
Decorate	Make photo albums, Small picture, or Rotate pictures can be added.
Small picture	Make photo albums and Rotate pictures can be added.
Crop	Decorate, Make photo albums, and Rotate pictures can be added.

- Copies created with editing functions cannot be further edited with the same function used to create them.
- When combining the **Small picture** feature with another editing feature, use the other editing feature first, and apply the **Small picture** feature last.
- When combining the crop feature with another editing feature other than **Decorate**, apply the crop feature last.

Original and Edited Images

- Copies created with editing functions, excluding **Rotate pictures**, are not deleted if the original images are deleted. The original images are not deleted if copies created with editing functions are deleted.
- Edited copies are saved with the same shooting date and time as the original.
- If an image has been marked for Print order (35) or added to favorites (19), the edited copy of the image is not marked for Print order or added to favorites.

Soften Pictures

Enter playback mode → select an image → flexible button 1 () → flexible button 3 () → press ◀ or ▶ to select  → flexible button 4 (**OK**)

Soften the image by adding a slight blur around the center of the image. Four blur regions are available.

Press the multi selector ◀ or ▶ to select the area to be blurred, and then press flexible button 4 (**OK**).

- To add a slight blur to the entire image, press **ALL**.
- To cancel, press flexible button 1 ()

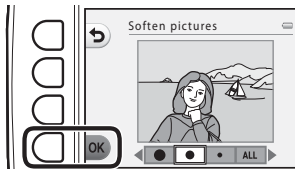

More Information

File and Folder Names →  061

* Add Starbursts

Enter playback mode → select an image → flexible button 1 (📷) → flexible button 3 (🖼️ Picture play) → press ◀ or ▶ to select * → flexible button 4 (OK)

Produce star-like rays of light that radiate outward from bright objects such as sunlight reflections or street lights. This effect is suitable for night scenes.

Confirm the effect and press flexible button 4 (OK).

- To cancel, press flexible button 1 (📷).

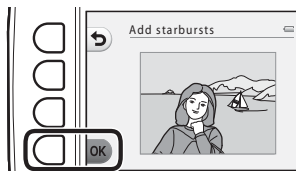

More Information

File and Folder Names → 📁61

Add a Fisheye Effect

Enter playback mode → select an image → flexible button 1 (📷) → flexible button 3 (🖼️ Picture play) → press ◀ or ▶ to select 📷 → flexible button 4 (OK)

Make an image look as if it were captured with a fisheye lens. This effect is well-suited for images captured using **Shoot close-ups** (📖 43) in the shooting menu.

Confirm the effect and press flexible button 4 (OK).

- To cancel, press flexible button 1 (📷).

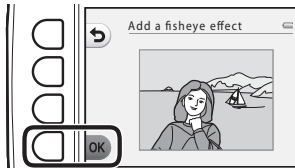

More Information

File and Folder Names → 📷61

Add a Diorama Effect

Enter playback mode → select an image → flexible button 1 (📷) → flexible button 3 (🖼️ Picture play) → press ◀ or ▶ to select  → flexible button 4 (OK)

Make an image look like a miniature scene captured in macro mode. This effect is well-suited for images captured from a high vantage point with the main subject in the center of the image.

Confirm the effect and press flexible button 4 (OK).

- To cancel, press flexible button 1 (📷).

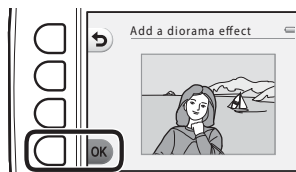

More Information

File and Folder Names →  061

Toy Camera

Enter playback mode → select an image → flexible button 1 (📷) → flexible button 3 (🖼️ Picture play) → press ◀ or ▶ to select 📄 → flexible button 4 (OK)

Make an image look as if it were shot with a toy camera. This effect is well-suited for landscapes.

Confirm the effect and press flexible button 4 (OK).

- To cancel, press flexible button 1 (📷).

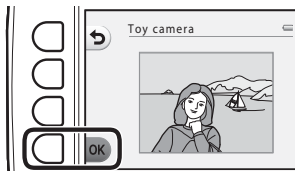

More Information

File and Folder Names → 📄61

Change Colors

Enter playback mode → select an image → flexible button 1 (🔍) → flexible button 3 (🖼️ Picture play) → press ◀ or ▶ to select  → flexible button 4 (OK)

Allows you to adjust image colors.

Press the multi selector ◀ or ▶ to select the desired setting, and then press flexible button 4 (OK).

- Four different settings are available.
 - 1 Vivid color (default setting): Use to achieve a vivid, photoprint effect.
 - 2 Black-and-white: Save images in black-and-white.
 - 3 Sepia: Save images in sepia tones.
 - 4 Cyanotype: Save images in cyan-blue monochrome.
- To cancel, press flexible button 1 (🔍).

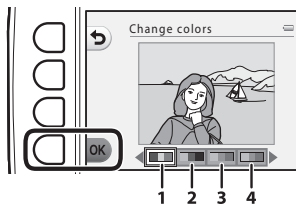

More Information

File and Folder Names →  61

Highlight Colors

Enter playback mode → select an image → flexible button 1 (📄) → flexible button 3 (🖼️ Picture play) → press ◀ or ▶ to select  → flexible button 4 (OK)

Keep one specified color in the image, and change the other colors to black and white.

Press the multi selector ◀ or ▶ to select a color, and then press flexible button 4 (OK).



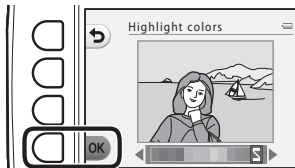

- To cancel, press flexible button 1 (📄).



More Information



File and Folder Names →  61



Decorate

Enter playback mode → select an image → flexible button 1 () → flexible button 3 () → press  or  to select  → flexible button 4 (OK)

You can add a frame around your images. Seven different frames are available. The image size of the edited copy varies depending on the size of the original image, as described below.

- When the original image is 2 megapixels (1600 × 1200) or larger, the copy is saved at 2 megapixels (1600 × 1200).
- When the original image is smaller than 2 megapixels (1600 × 1200), the copy is saved at the same size as the original.

Press the multi selector  or  to select a frame, and then press flexible button 4 (OK).

- The frame is added to the picture and saved as a new copy.
- To cancel, press flexible button 1 ()
- Press flexible button 3 () to remove the frame.

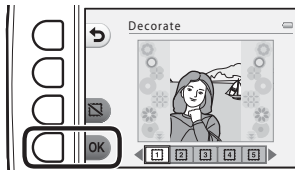

Notes About Decorate

- The frame is placed on top of the image and therefore replaces the area of the image underneath it. Thicker frames cover up a larger area of the image.
- When using borderless printing to print images that you have added frames to, the frames may not be printed.



More Information

File and Folder Names →  61

Make Photo Albums

You can display images similarly to a photo album. Five different photo album designs are available. The created album is saved as a separate image of 10 megapixels (3648 × 2736) in size.

Making Photo Albums

Enter playback mode → flexible button 1 () → flexible button 4 ( Make photo albums)

- 1 Press the multi selector  or  to select an image.



- 2 Press flexible button 2 () .

- A check mark is displayed.
- A check mark is displayed or removed every time you press flexible button 2 () .
- Press flexible button 3 (**RESET**) to remove all check marks.
- Images are arranged in an album in the order the check marks were added.
- Up to 20 images can be selected.

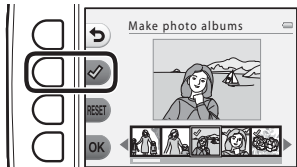

3 Press flexible button 4 (OK).



4 Press ◀ or ▶ to select the desired photo album design, and then press flexible button 4 (OK).

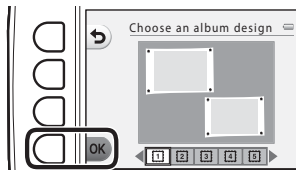

- Photo albums are displayed one page at a time. After all pages have been displayed, the camera returns to **Have fun with pictures** menu.
- To cancel before the photo album has been created, press flexible button 1 (X).

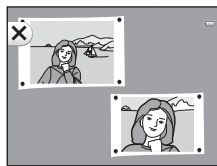

✓ Notes About Make Photo Albums



- Movies cannot be selected.
- Images captured with another make or model of digital camera cannot be selected.
- Editing functions other than **Rotate pictures** (633) cannot be added to images created using **Make photo albums**.

📎 More Information

File and Folder Names → 61

Favorites

By adding images to favorites you can sort your favorite images from others. Once images are added, use **View favorites** to play back only the images that have been added to favorites.

Enter playback mode → flexible button 2 () → flexible button 2 ( Favorites)

Adding Images to Favorites

- By viewing only the images that have been added to favorites, you can easily find the desired images.

Press the multi selector ◀ or ▶ to select an image, and then press flexible button 2 ()

- The image is added to favorites.
- You cannot add an image to favorites if it has already been added.
-  is displayed when viewing images that have been added to favorites.
- Up to 200 images can be added to favorites.

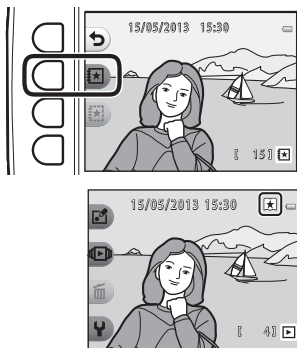

Adding Images to Favorites

When an image is added to favorites, it is protected from accidental deletion. Note that formatting the camera's internal memory or the memory card () permanently deletes images that have been added to favorites.

Removing Images from Favorites

Press the multi selector ◀ or ▶ to select the image you want to remove from favorites, and then press flexible button 3 (F3).

- The selected image is removed from favorites.

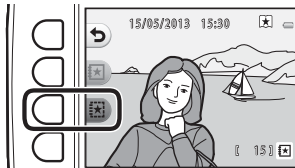

Slide Show

You can play back images, saved in the internal memory or on a memory card, one by one in an automated "slide show."

Background music is played during playback. Background music varies depending on the theme selected under **Choose a theme** (🎧 25).

Enter playback mode → flexible button 2 (🎵) → flexible button 3 (🖼️ Slide show)

Choose Pictures

1 Press flexible button 3 (🖼️ **Choose pictures**).

- To play back all images → step 3.

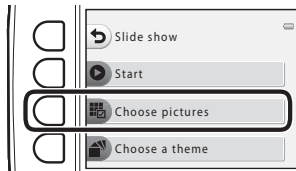

2 Press flexible button 2, 3, or 4 to select the images you want to play back.

- **View favorites**: Only images added to favorites are played back. Proceed to step 3.
- **Choose by date**: Only images captured on the same day are played back. Select a date from the calendar, press flexible button 4 (OK), and continue from step 3.
- **Pick a series**: Images captured using **Shoot at intervals** (📅 44) are played back consecutively. This option can be selected only when images have been captured using **Shoot at intervals** (🎧 23).



3 Press flexible button 2 (▶ Start).

- The slide show begins.



- To pause playback, press flexible button 4 (⏸).
- To exit, press flexible button 1 (↶).
- While the slide show is in progress, press the multi selector ▶ to display the next image or ◀ to display the previous image. Press and hold ▶ or ◀ to fast forward or rewind.
- Press ▲ or ▼ during playback to adjust the volume of the background music.



4 End the slide show or restart it.

- The screen shown on the right is displayed when the slide show is paused.
 - ✕: Returns to the screen displayed in step 1.
 - ⏸: Displays the next image.
 - ◀: Displays the previous image.
 - ▶: Resumes playback.



Pick a Series

1 Press flexible button 2 (📁 **Choose pictures**).

- The first image in the folder where images captured using the **Shoot at intervals** are saved is displayed.

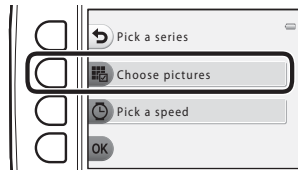

2 Press flexible button 2 (▶) or flexible button 3 (◀) to select the folder, and then press flexible button 4 (**OK**).

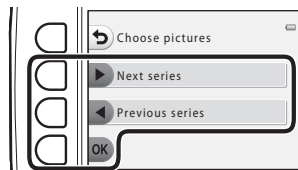

3 Press flexible button 3 (🕒 **Pick a speed**).

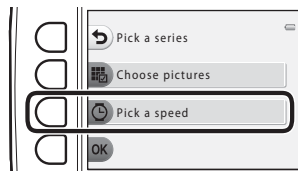

4 Press flexible button 2 (**Fast**), flexible button 3 (**Normal**) (default setting), or flexible button 4 (**Slow**) to select a desired speed.

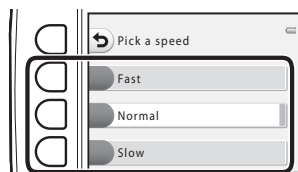

5 Press flexible button 4 (**OK**).

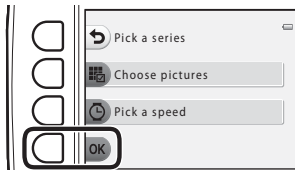

6 Press flexible button 2 (**▶ Start**).

- The slide show begins.

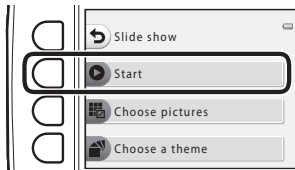

Choose a Theme

- 1** Press flexible button 4 (🏠 **Choose a theme**).

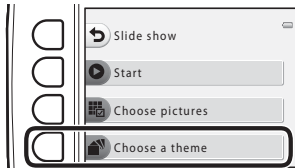

- 2** Press flexible button 2, 3, or 4 to select a playback theme.

- You can select **Animated** (default setting), **Pop art**, or **Classic**.

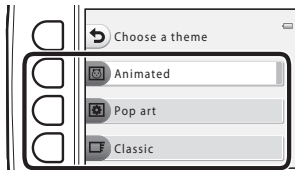

- 3** Press flexible button 2 (▶ **Start**).

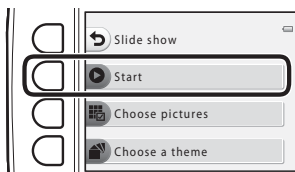

- The slide show begins.



✓ Notes About Slide Show

- Only the first frame of movies is displayed.
- The maximum playback time is up to about 30 minutes (📖 21).

View Movie

Enter playback mode → flexible button 2 () → flexible button 4 ( View movie)

Allows you to play back movies ( 81). Available when a movie is displayed.

More Playback Options

Allows you to select a date and view images that were captured on that date or play back images added to favorites.

Enter playback mode → flexible button 4 (⏮) → flexible button 2 (⏮) More playback options)

View by Date

- 1 Press flexible button 2 (📅 **View by date**).

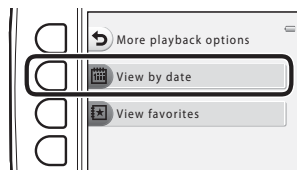

- 2 Press the multi selector ▲, ▼, ◀, or ▶ to select the desired date, and then press flexible button 4 (OK).

- Images are selected based on the selected date. The first image captured on that date is displayed.
- A white background of a date indicates that images were recorded on that date.
- Press flexible button 2 (▶) to display the next month. Press flexible button 3 (◀) to display the previous month.

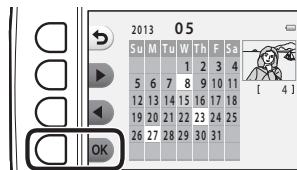

3 Press the multi selector ◀ or ▶ to view images.

- Press ▲ to magnify the image.
- Press ▼ to switch to thumbnail playback mode.
- Press flexible button 1 (↶) to return to the screen displayed in step 2.
- Press flexible button 4 (✕) to return to full-frame playback mode (📖 26).

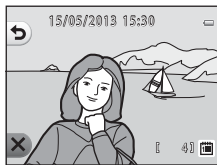



✓ Notes About View by Date



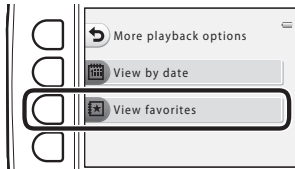

- The 9000 most recent images can be displayed.
- Images that were captured when the camera's date and time were not set are treated as images captured on January 1, 2013.
- Only the first frame of movies is displayed.
- Images cannot be edited when they are played back using **View by date**.

View Favorites

- 1 Press flexible button 3 ( **View favorites**).



- 2 Press the multi selector  or  to view images.

- Press  to magnify the image.
- Press  to switch to thumbnail playback mode.
- Press flexible button 1 () to return to the screen displayed in step 1.
- Press flexible button 4 () to return to full-frame playback mode ( 26).

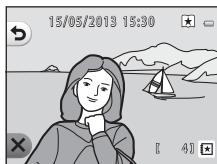



Notes About View Favorites

- Images cannot be edited when they are played back using **View favorites**.
- Only the first frame of movies is displayed.

Print Order/Retouch

Copy or rotate images or create a small copy of the current image. You can also specify the image to be printed and the number of copies to be printed.

Retouch

Enter playback mode → flexible button 4 () → flexible button 3 ( Print order/retouch)
→ flexible button 2 ( Retouch)



Copy

Copy images between the internal memory and a memory card.

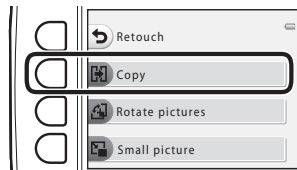
1 Press flexible button 2 (Copy).



2 Press flexible button 2 or 3 to select the copy source and destination.

-  **Camera to card:** Copies images from internal memory to memory card.
-  **Card to camera:** Copies images from memory card to internal memory.

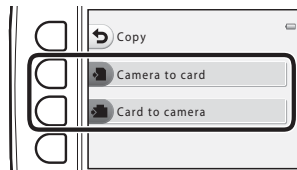

3 Press flexible button 2 or 3 to select the copy method.

- **Selected images:** Copies images selected from the image selection screen. Proceed to step 4.
- **All images:** Copies all images. Proceed to step 7.

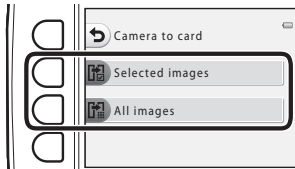

4 Press the multi selector ◀ or ▶ to select an image.



5 Press flexible button 2 (✓).

- A check mark is displayed next to the image.
- A check mark is displayed or removed each time you press flexible button 2 (✓).
- Press flexible button 3 (RESET) to remove all check marks.
- Repeat steps 4 and 5 to select additional images.



6 Press flexible button 4 (OK) to apply image selection.

- A confirmation dialog is displayed.



7 Press flexible button 3 (○ Yes).

- Images are copied.

Notes About Copying Images

- JPEG-, AVI-, and WAV-format files can be copied.
- Operation is not guaranteed with images captured with another make of camera or that have been modified on a computer.
- When copying images for which **Print order** () options are enabled, the print order settings are not copied.

If “Memory contains no images.” Is Displayed

If a memory card that contains no images is inserted into the camera, **Memory contains no images.** is displayed when the camera is switched to playback mode. You can copy images from the camera's internal memory to the memory card by pressing a flexible button and then selecting flexible button 3 ( Print order/retouch) → flexible button 2 ( Retouch).

More Information

File and Folder Names → 061

Rotate Pictures



After shooting, you can change the orientation in which still images are displayed.

Still images can be rotated 90 degrees clockwise or 90 degrees counterclockwise.

Images that were saved in portrait ("tall") orientation can be rotated up to 180 degrees in either direction.

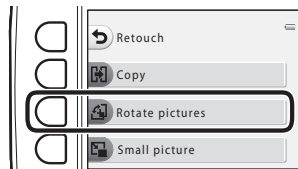
- 1** Press flexible button 3 ( **Rotate pictures**).



- 2** Press flexible button 2 () or flexible button 3 ().

- The image is rotated 90 degrees.

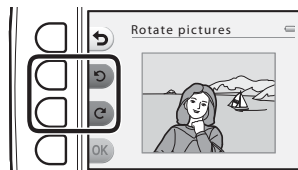

- 3** Press flexible button 4 (**OK**).

- The displayed orientation is applied, and the orientation information is saved with the image.

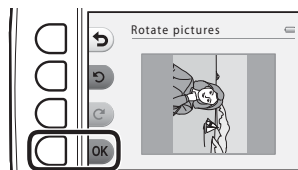

Notes About Rotate Pictures



This camera cannot rotate images captured with another make or model of digital camera.

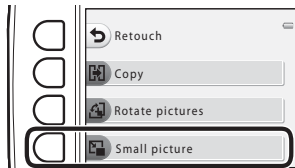

Small Picture

Create a small copy of the current image.

- 1** Press flexible button 4 ( **Small picture**).

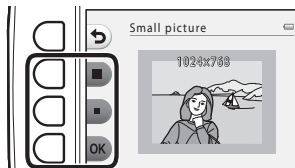

- 2** Press flexible button 2 () or flexible button 3 () to select the size of the image and then press flexible button 4 (**OK**).

- A new, edited copy is saved as a separate image with a compression ratio of 1:16.
- To cancel, press flexible button 1 (A screenshot of the 'Small picture' dialog box. The dialog has a title bar that says 'Small picture'. Below the title bar is a preview window showing a cartoon illustration of a woman with long hair, a landscape with mountains, and a small boat on a lake. Above the preview, the dimensions '1024x768' are displayed. To the left of the preview are three flexible buttons: the top one is selected (filled with a dark square), and the bottom one is labeled 'OK'. To the left of the dialog is a vertical column of four flexible buttons.

More Information

File and Folder Names → 61

Print Order

Enter playback mode → flexible button 4 (M) → flexible button 3 (Print order/retouch)
→ flexible button 3 (Print order)

When printing images saved on the memory card using any of the following methods, the **Print order** option in the playback menu is used to create digital “print orders”.

- Inserting the memory card into a DPOF-compatible (D23) printer's card slot.
- Taking the memory card to a digital photo lab.
- Connecting the camera to a PictBridge-compatible (D23) printer (D52). A print order can also be created for images saved in the internal memory if the memory card is removed from the camera.

1 Press flexible button 2 (Select images).



2 Select images (up to 99) and the number of copies (up to nine) of each.

- Press the multi selector ◀ or ▶ to select images, and then press flexible button 2 (+) or flexible button 3 (−) to set the number of copies for each.
- Images selected for printing are indicated by a check mark icon and the numeral indicating the number of copies to be printed. If no copies have been specified for an image, the selection is canceled.
- Press flexible button 4 (OK) when setting is complete.

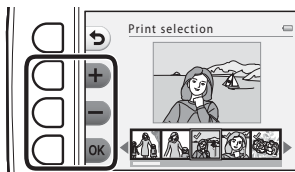

3 Press flexible button 2 or 3 to select whether or not to print shooting date and shooting information.

- **Date:** Print the shooting date on all images in the print order.
- **Info:** Print shooting information (shutter speed and aperture value) on all images in the print order.
- **Date** and **Info** turn on and off each time you press the corresponding flexible button.
- Press flexible button 4 (**OK**) to complete the print order.

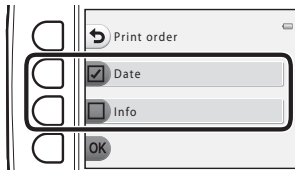

When Date is selected

✓ Notes About Printing Shooting Date and Shooting Information

When the **Date** and **Info** settings are enabled in the print order option, shooting date and shooting information are printed on images when a DPOF-compatible printer (🔗:23) that supports printing of shooting date and shooting information is used.

- Shooting information cannot be printed when the camera is connected to a DPOF-compatible printer via the included USB cable.
- Note that the **Date** and **Info** settings are reset each time the **Print order** option is displayed.
- The date printed is that saved when the image was captured. Changing the **Date and time** setting in the camera settings menu after an image has been captured has no effect on the date printed on the image.



✏ Canceling Existing Print Order

Press flexible button 3 (**RESET Delete print order**) in step 1 (🔗:35) of "🖨 Print Order" to remove print marking from all images and cancel the print order.

✏ Print Date



When shooting date is imprinted on images using the **Print date** option (🔗:41) in the camera settings menu, images are saved with shooting date imprinted on the image when they are captured. Images with the date imprinted on them can be printed from printers that do not support printing of the date on images.

Only the date imprinted on images with the print date option will be printed, even if the **Print order** date option is enabled.

Welcome Screen

Enter shooting mode or playback mode → flexible button 4 () → flexible button 4 ( Camera settings) → flexible button 2 ( Welcome screen)

Select whether or not the welcome screen is displayed when the camera is turned on.

Option	Description
 Off	The camera enters shooting or playback mode without displaying the welcome screen.
 On (default setting)	The camera displays an animated welcome screen and then enters shooting or playback mode. How often you use the camera and how many pictures you have taken with the camera affects the displayed characters.

Date and Time

Enter shooting mode or playback mode → flexible button 4 (P) → flexible button 4 (P Camera settings) → flexible button 3 (⊕ Date and time)

Set the camera clock.

Option	Description
⊕ Date format	The available date formats are Year/Month/Day , Month/Day/Year , and Day/Month/Year .
⊕ Date and time	<p>Allows you to set the camera's clock to the current date and time. Use the multi selector to set each item displayed on the screen.</p> <ul style="list-style-type: none">• Select an item: Press ► or ◀ (changes between D, M, Y, hour, minute).• Edit the highlighted item: Press ▲ or ▼.• Apply the setting: Select the minute setting and then press flexible button 4 (OK).• When using the camera in an area where daylight saving time is in effect, press flexible button 3 (☀) to adjust the camera's time for daylight saving time. When the daylight saving time function is enabled, ☀ is displayed in the monitor and the time advances one hour. Press flexible button 3 (☀) again to disable the daylight saving time function.

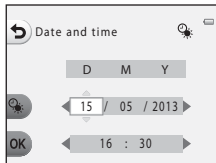

Brightness

Enter shooting mode or playback mode → flexible button 4 (P) → flexible button 4 (P Camera settings) → flexible button 4 (⚙️ Brightness)

Select from five settings for monitor brightness. The default setting is 3.

- Press the multi selector ◀ or ▶ to select the desired brightness and then press flexible button 4 (OK).

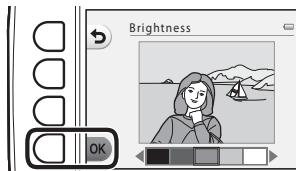

Print Date

Enter shooting mode or playback mode → flexible button 4 (P) → flexible button 4 (P Camera settings) → press ▼ → flexible button 2 (DATE) Print date)

The shooting date can be imprinted on the images even when shooting, allowing the information to be printed even from printers that do not support date printing (🔍37).



Option	Description
 Date	Date is imprinted on images.
OFF Off (default setting)	Date is not imprinted on images.

Notes About Print Date

- Imprinted dates form a permanent part of image data and cannot be deleted. The date cannot be imprinted on images after they have been captured.
- The date is not imprinted on movies and images captured using **Take a series of pictures**.
- The date is saved using the format selected in the setup menu's **Date and time** option (📖 16, 🔍39).



Print Date and Print Order

When printing with a DPOF-compatible printer that can print the shooting date and shooting information, you can use the **Print order** option (🔍35) to print this information in images, even if the **Print date** function was set to **Off** at the time of shooting.

Electronic VR

Enter shooting mode or playback mode → flexible button 4 (P) → flexible button 4 (P Camera settings) → press ▼ → flexible button 3 (VR) Electronic VR

Select whether to use electronic VR (vibration reduction) when taking still pictures.

Option	Description
 Auto	In the following conditions, the effects of camera shake are reduced when taking still pictures. <ul style="list-style-type: none">• When the flash mode is set to  Flash off• The shutter speed is slow• When the subject is dark
OFF Off (default setting)	Electronic VR is disabled.

Notes About Electronic VR

- Electronic VR is disabled while the flash is used.
- If the exposure period exceeds a certain period of time, electronic VR will not function.
- Electronic VR cannot be used when using the following styles.
 - **Shoot at intervals** (📖 44)
 - **Take a series of pictures** (📖 45)
 - **Photograph fireworks** (📖 46)
- Even when electronic VR is set to **Auto**, depending on the scene (📖 34) automatically selected by the camera when using  Point and shoot mode, the electronic VR may not function.
- The effectiveness of electronic VR decreases as camera shake increases.
- The images captured may become somewhat grainy.

AF Assist

Enter shooting mode or playback mode → flexible button 4 (P) → flexible button 4 (P Camera settings) → press ▼ → flexible button 4 (AF) AF assist

Enable or disable AF-assist illuminator, which assists autofocus operation when the subject is dimly lit.

Option	Description
Auto (default setting)	<p>The AF-assist illuminator lights automatically when the subject is dimly lit. The illuminator has a range of about 3.5 m (11 ft) at the maximum wide-angle position and about 2.0 m (6 ft 6 in.) at the maximum telephoto position.</p> <ul style="list-style-type: none">• When Photograph fireworks (📖 46) is selected under Choose a style, the AF-assist illuminator does not light.• Depending on the scene (📖 34) automatically selected by the camera when using 📷 Point and shoot mode, the AF-assist illuminator may not light.
Off	<p>The AF-assist illuminator does not light. The camera may be unable to focus under dim lighting.</p>

Format Memory/Format Card

Enter shooting mode or playback mode → flexible button 4 (P) → flexible button 4 (P Camera settings) → press ▼ twice → flexible button 2 (M) Format memory/
Format card)

Use this option to format the internal memory or a memory card.

Formatting the internal memory or memory cards permanently deletes all data. Data that has been deleted cannot be recovered. Be sure to transfer important data to a computer before formatting.

Formatting the Internal Memory

To format the internal memory, remove the memory card from the camera. The **Format memory** option is displayed in the camera settings menu.

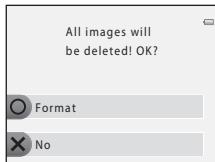

Formatting a Memory Card

When the memory card is inserted in the camera, the **Format card** option appears in the camera settings menu.

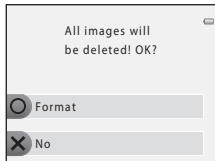

✓ Notes About Formatting Internal Memory and Memory Cards

- Do not turn the camera off or open the battery-chamber/memory card slot cover during formatting.
- The first time you insert a memory card that has been used in another device into this camera, be sure to format it with this camera.

Language

Enter shooting mode or playback mode → flexible button 4 (P) → flexible button 4 (P Camera settings) → press ▼ twice → flexible button 3 (Language)

Select one of 34 languages for display of camera menus and messages.

Čeština	Czech
Dansk	Danish
Deutsch	German
English	(Default setting)
Español	Spanish
Ελληνικά	Greek
Français	French
Indonesia	Indonesian
Italiano	Italian
Magyar	Hungarian
Nederlands	Dutch
Norsk	Norwegian
Polski	Polish
Português (BR)	Brazilian Portuguese
Português (PT)	European Portuguese
Русский	Russian
Română	Romanian

Suomi	Finnish
Svenska	Swedish
Tiếng Việt	Vietnamese
Türkçe	Turkish
Українська	Ukrainian
عربي	Arabic
বাংলা	Bengali
简体中文	Simplified Chinese
繁體中文	Traditional Chinese
हिन्दी	Hindi
日本語	Japanese
한국어	Korean
मराठी	Marathi
فارسی	Persian
தமிழ்	Tamil
తెలుగు	Telugu
ภาษาไทย	Thai

Menu Background

Enter shooting mode or playback mode → flexible button 4 (Y) → flexible button 4 (Y Camera settings) → press ▼ twice → flexible button 4 (Menu background)

Select one of five background designs to be used for a menu screen or thumbnail playback mode.

- Press the multi selector ◀ or ▶ to select the desired design and then press flexible button 4 (OK).
- To restore the default background image, press flexible button 3 (RESET).

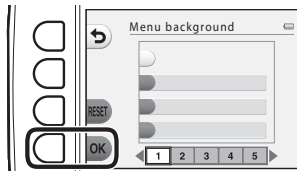

Video Mode

Enter shooting mode or playback mode → flexible button 4 (Y) → flexible button 4 (Y Camera settings) → press ▼ three times → flexible button 2 (Video mode)

Adjust settings for connection to a TV.

Select from **NTSC** and **PAL**.

Reset All

Enter shooting mode or playback mode → flexible button 4 (👉) → flexible button 4 (👉 Camera settings) → press ▼ three times → flexible button 3 (CLEAR Reset all)

When flexible button 3 (🔵 Reset) is selected, the camera's settings are restored to their default values.

Shooting Menu

Option	Default value
Flash mode (📖 35)	Auto flash
Self-timer (📖 37)	Off
Choose a style (📖 42)	Shoot close-ups
Hue adjustment in Photograph food (📖 43)	Center
Shoot at intervals (📖 44)	Shoot every 30 seconds
Decorate (📖 48)	Frame 1
Adjustments made using Change colors (📖 49)	Brighter/darker: ±0 More vivid/less vivid: Normal Highlight colors: No change
Pick a shutter sound in Change sounds (📖 52)	Standard sounds
Pick a button sound in Change sounds (📖 52)	Standard sounds
Choose a size (Photo size) (📖 54)	■ Large (10 megapixels)
Choose a size (Movie frame size) (📖 56)	When using a memory card: 📺 Large (720p) (1280×720)

Camera Settings Menu

Option	Default value
Brightness (📷40)	3
Print date (📷41)	Off
Electronic VR (📷42)	Off
AF assist (📷43)	Auto
Menu background (📷46)	1

Others

Option	Default value
Paper size (📷56, 📷57)	Default

- Selecting **Reset all** also resets the camera's file numbering (📷61). After a reset, the camera determines the largest file number in the internal memory or on the memory card and saves images using the next available file number. To reset file numbering to "0001", delete all images saved in the internal memory or on the memory card (📖 28) before selecting **Reset all**.
- The following menu settings will remain unaffected when menus are reset with **Reset all**.
Camera settings menu:

Welcome screen (📷38), **Date and time** (📷39), **Language** (📷45), and **Video mode** (📷46)

Firmware Version

Enter shooting mode or playback mode → flexible button 4 (P) → flexible button 4 (P Camera settings) → press ▼ three times → flexible button 4 (Ver. Firmware Version)

View the current camera firmware version.



Connecting the Camera to a TV

Connect the camera to a TV using an optional audio/video cable (63) to play back images or movies on the TV.

1 Turn off the camera.

2 Connect the camera to the TV.

- Connect the yellow plug of the audio/video cable to the video-in jack and the white plug to the audio-in jack on the TV.

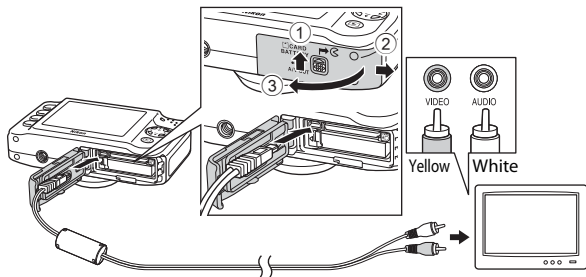

3 Set the TV's input to external video input.

- See your TV's documentation for details.

4 Hold down the (shooting/playback mode) button to turn on the camera.

- The camera enters playback mode and images are displayed on the TV.
- While connected to the TV, the camera monitor remains off.

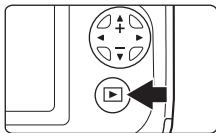

Notes About Connecting the Cable

When connecting the cable, be sure that the camera connector is properly oriented, do not insert the cable at an angle, and do not use excessive force. When disconnecting the cable, do not pull the connector at an angle.

If the Images Are Not Displayed on the TV

Be sure that the camera's **Video mode** (46) setting in the camera settings menu conforms to the standard used by your TV.

Connecting the Camera to a Printer

Users of PictBridge-compatible (📷23) printers can connect the camera directly to the printer and print images without using a computer. Follow the procedures below to print images.

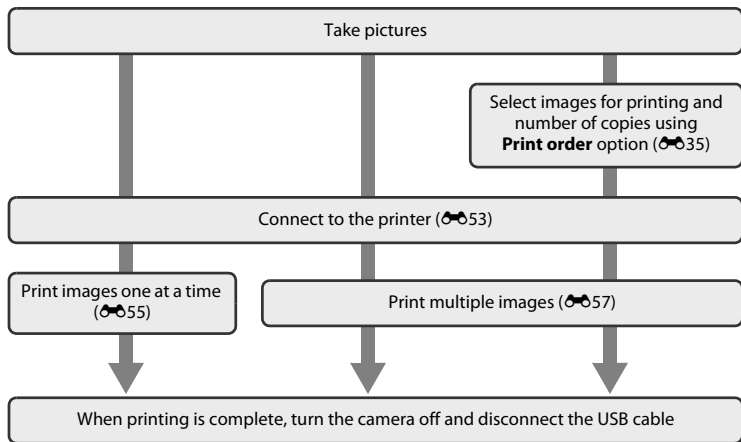



Notes About Power Source

- When connecting the camera to a printer, use a battery with a sufficient amount of charge remaining to prevent the camera from turning off unexpectedly.
- If the AC Adapter EH-62F (available separately) (63) is used, this camera can be powered from an electrical outlet. Do not, under any circumstances, use an AC adapter other than the EH-62F. Failure to observe this precaution could result in overheating or damage to the camera.



Printing Images

In addition to printing images transferred to a computer from your personal printer and printing over a direct camera-to-printer connection, the following options are also available for printing images saved on the memory card:

- Inserting the memory card into a DPOF-compatible printer's card slot
- Taking the memory card to a digital photo lab

When using these methods to print, you can use the **Print order** option in the playback menu to specify which images will be printed and how many copies of each image will be printed, and save these settings on the memory card (35).

Connecting the Camera to a Printer

- 1 Turn off the camera.
- 2 Turn on the printer.
 - Check printer settings.

3 Connect the camera to the printer using the included USB cable.

- Be sure that connectors are properly oriented, do not insert the cable at an angle, and do not use excessive force. When disconnecting the cable, do not remove the cable at an angle.

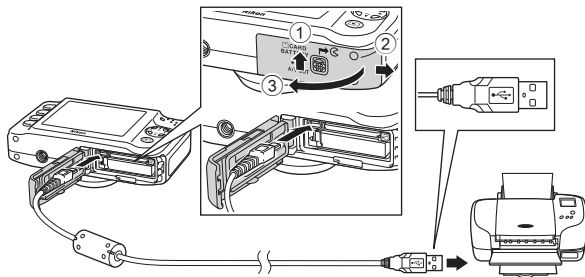

4 Turn on the camera.

- When properly connected, the **PictBridge** startup screen is displayed in the camera monitor, followed by the **Print selection** screen.

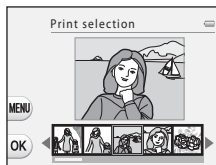

Printing Individual Images

After properly connecting the camera to the printer (📷53), follow the procedures described below to print an image.

- 1 Press the multi selector ◀ or ▶ to select an image to be printed, and then press flexible button 4 (OK).

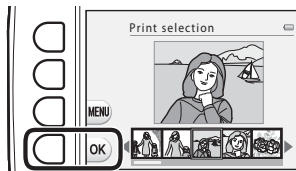

- 2 Press flexible button 3 (📄 Copies).

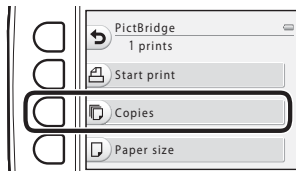

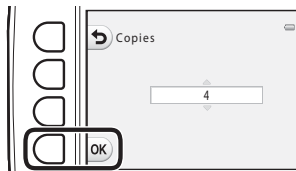

- 3 Press ▲ or ▼ to select the desired number of copies (up to nine) and then press flexible button 4 (OK).



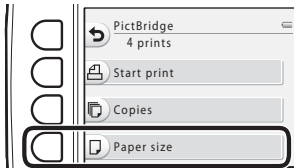

4 Press flexible button 4 ( **Paper size**).

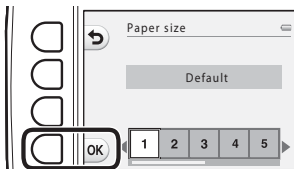

5 Press  or  to select the paper size, and then press flexible button 4 (**OK**).

- To specify paper size using settings on the printer, select **Default**.



6 Press flexible button 2 ( **Start print**).

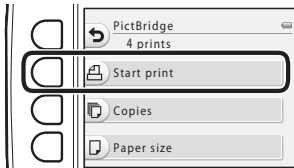

7 Printing begins.

- The screen returns to step 1 when printing is complete.

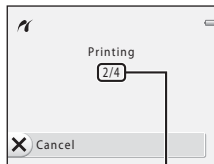

Current number of copies/
total number of copies

Printing Multiple Images

After properly connecting the camera to the printer (6-53), follow the procedures described below to print multiple images.

- 1 When the **Print selection** screen is displayed, press flexible button 3 (**MENU**).

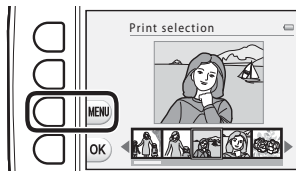

- 2 Press the multi selector ▼ and then press flexible button 2 (**Paper size**).

- To exit the print menu, press the flexible button 1 (↶).

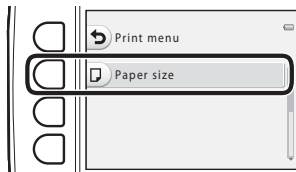

- 3 Press ◀ or ▶ to select the paper size, and then press flexible button 4 (**OK**).

- To specify paper size using settings on the printer, select **Default**.

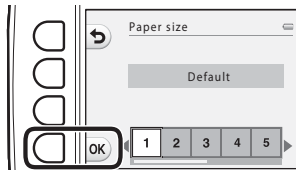

- 4 Press ▲, and then press flexible button 2 (☰ **Print selection**), flexible button 3 (**ALL Print all images**), or flexible button 4 (**DPOF DPOF printing**).

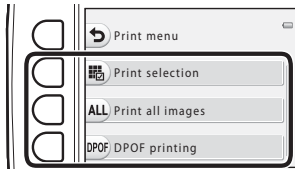

Print selection

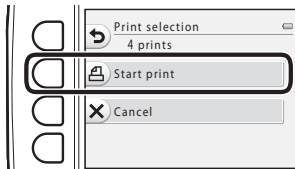
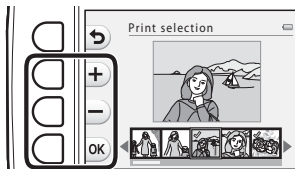

Select which images will be printed (up to 99) and how many copies of each image will be printed (up to nine).

- Press the multi selector ◀ or ▶ to select images. Press flexible button 2 (+) or flexible button 3 (−) to set the number of copies for each.
- Images selected for printing are indicated by a check mark and the numeral indicating the number of copies to be printed. If no copies have been specified for an image, the selection is canceled.
- Press flexible button 4 (OK) when setting is complete.
- When the screen shown on the right is displayed, press flexible button 2 (🖨️ **Start print**) to start printing. Press flexible button 1 (↶) to return to the **Print selection** screen. Press flexible button 3 (✕ **Cancel**) to return to the print menu.



Print all images



One copy of each image saved in the internal memory or on the memory card, is printed.

- When the screen shown on the right is displayed, press flexible button 2 ( **Start print**) to start printing. Press flexible button 1 () to return to the print menu.



DPOF printing

Print images for which a print order was created using the **Print order** option ( 35).

- When the screen shown on the right is displayed, press flexible button 2 ( **Start print**) to start printing. Press flexible button 1 () to return to the print menu.
- To view the current print order, press flexible button 3 ( **View images**). To start printing, press flexible button 4 (**OK**).

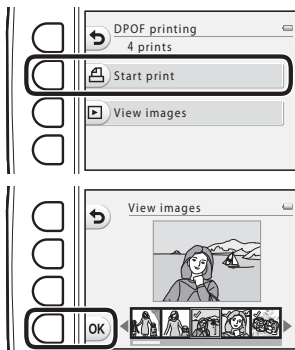

5 Printing begins.

- The screen returns to step 2 when printing is complete.

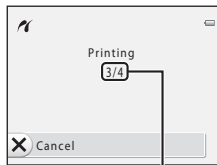

Current number of copies/
total number of copies

Paper Size

The camera supports the following paper sizes: **Default** (the default paper size for the printer connected to the camera), **3.5×5 in.**, **5×7 in.**, **100×150 mm**, **4×6 in.**, **8×10 in.**, **Letter**, **A3**, and **A4**. Only sizes supported by the printer are displayed.

File and Folder Names

Images, movies, and messages are assigned file names as follows.

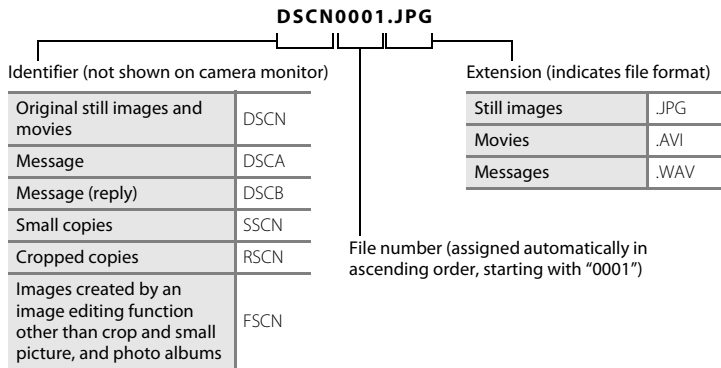

- Files are saved in folders named with a folder number followed by "NIKON" (e.g. "100NIKON"). When the number of files within a folder reaches 999, a new folder is created (e.g., "101NIKON" is created after "100NIKON"). When the file numbers within a folder reach 9999, a new folder is created. File numbers are assigned automatically starting with 0001. When shooting, a new folder is created each time the camera's internal clock changes dates. Note however that if the date changes while shooting continuously with **Shoot at intervals** or **Take a series of pictures**, a new folder is not created until shooting stops.
- Voice message file numbers are the same numbers as the images to which the messages are attached.



- Files copied using **Copy>Selected images** are copied to the current folder, where they are assigned new file numbers in ascending order starting from the largest file number in memory. **Copy>All images** copies all folders from the source medium; file names do not change but new folder numbers are assigned in ascending order, starting from the largest folder number on the destination medium (0030).
- When the current folder is numbered 999 and the file numbers reach 9999, no further images can be captured until the internal memory or memory card is formatted (0044), or a new memory card is inserted.

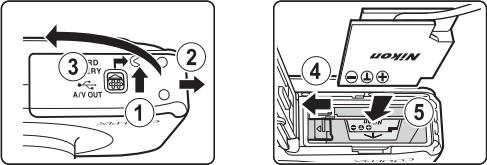





Optional Accessories







AC adapter	<p data-bbox="274 114 609 135">AC Adapter EH-62F (connect as shown)</p>  <p data-bbox="274 350 907 396">Fully insert the cord of the AC adapter into the slot in the AC adapter, then insert the AC adapter in the battery chamber.</p> <ul data-bbox="274 399 925 493" style="list-style-type: none">• While using the AC adapter, the battery-chamber/memory card slot cover cannot be closed. Do not pull the cord of the AC adapter. If the cord is pulled, the connection between the camera and power source is interrupted, and the camera turns off.
Audio/video cable	Audio Video Cable EG-CP14

Accessories are not waterproof.

Error Messages

Display	Cause/Solution	
 (flashes)	Clock not set. Set date and time.	 39
Battery exhausted.	Charge or replace the battery.	10, 12
Battery temperature high	Battery temperature is high. Turn off camera, and allow battery to cool down before resuming use. After five seconds, the monitor will turn off and the power-on lamp will begin flashing quickly. After the lamp flashes for three minutes, the camera will turn off automatically. Pressing the power switch also turns off the camera.	21
Battery temperature is elevated. The camera will turn off.	The battery has become hot. The camera turns off automatically. Allow the battery to cool down before turning it on again.	21
The camera will turn off to prevent overheating.	Inside of the camera has become hot. The camera turns off automatically. Allow the camera to cool down before turning it on again.	21
Please wait.	Wait until the image is saved and the message disappears from the display.	–
Memory card is write protected.	Write-protect switch is in “lock” position. Slide write-protect switch to “write” position.	–

Display	Cause/Solution	
This card cannot be used.	Error accessing memory card. <ul style="list-style-type: none"> • Use approved card. • Check that terminals are clean. • Confirm that memory card is correctly inserted. 	 :22 14 14
This card cannot be read.		
Card is not formatted. Format card? Yes No	Memory card has not been formatted for use in this camera. Formatting deletes all data saved on the memory card. Be sure to select flexible button 4 (X No) and make copies of any images which need to be kept before formatting the memory card. Select flexible button 3 (O Yes) to format the memory card.	 :7
Out of memory.	Memory card is full. <ul style="list-style-type: none"> • Change the setting for Choose a size > Photo size. • Delete images. • Insert new memory card. • Remove memory card and use internal memory. 	54 28, 81 14 15
Image cannot be saved.	Error occurred while saving image. Format internal memory or memory card.	 44
	Camera has run out of file numbers. Insert a new memory card or format internal memory or memory card.	14,  44,  61
	Insufficient space to save a copy. Delete images from destination.	28
Album is full. No further pictures can be added.	200 images have already been added to favorites. Remove some images from favorites.	 20

Display	Cause/Solution	
Image cannot be modified.	Cannot edit selected image. Select images that support editing function.	 8
Cannot record movie.	Time out error while saving movie on the memory card. Select a memory card with faster write speed.	14,  22
Memory contains no images.	No images in the internal memory or memory card. <ul style="list-style-type: none"> Remove the memory card from the camera to play back images saved in the camera's internal memory. To copy images from the internal memory to the memory card, select Copy in the print order/retouch menu. 	15  30
File contains no image data.	File not created with this camera. File cannot be viewed on this camera. View file using a computer or the device used to create or edit this file.	–
All images are hidden.	No images available for a slide show.	 21
Lens error	Lens error. Turn camera off and then on again. If error persists, contact retailer or Nikon-authorized service representative.	20
Communications error	Error occurred during communication with printer. Turn camera off and reconnect USB cable.	 53
System error	Error has occurred in camera's internal circuitry. Turn camera off, remove and reinsert battery, and turn camera on. If error persists, contact retailer or Nikon-authorized service representative.	12, 21

Display	Cause/Solution	
Printer error: check printer status.	Printer error. Check printer. After solving the problem, press flexible button 3 (○ Resume) to resume printing.*	–
Printer error: check paper	Specified size of paper is not loaded in printer. Load the specified size of paper and then press flexible button 3 (○ Resume) to resume printing.*	–
Printer error: paper jam	Paper has jammed in printer. Remove the jammed paper and then press flexible button 3 (○ Resume) to resume printing.*	–
Printer error: out of paper	No paper is loaded in printer. Load the specified size of paper and then press flexible button 3 (○ Resume) to resume printing.*	–
Printer error: check ink	Ink error. Check ink and then press flexible button 3 (○ Resume) to resume printing.*	–
Printer error: out of ink	Running out of ink or ink cartridge is empty. Replace ink cartridge and then press flexible button 3 (○ Resume) to resume printing.*	–
Printer error: file corrupt	An error caused by the image file has occurred. Select flexible button 4 (✕ Cancel) to cancel printing.	–

* See the documentation provided with your printer for further guidance and information.



A series of ten horizontal dashed lines spanning the width of the page, intended for handwriting practice.



Technical Notes and Index

Caring for the Product	2
The Camera.....	2
The Battery.....	5
The Battery Charger.....	6
Memory Cards	7
Cleaning and Storage	8
Cleaning.....	8
Storage.....	9
Troubleshooting	10
Specifications	17
Approved Memory Cards	22
Supported Standards.....	23
Index	24

Caring for the Product

The Camera

To ensure safe and continued enjoyment of your Nikon camera, observe the following precautions and the precautions noted in "For Your Safety" (📖 ix-xii) and "Important Shockproof, Waterproof, Dustproof, Condensation" (📖 xv-xxi) when using or storing your camera.

✔ Do Not Subject the Product to Strong Shocks

The product may malfunction if dropped or struck. Additionally, do not touch or apply force to the lens.

✔ Do Not Allow Damp to Enter Inside the Camera

COOLPIX S31 is provided with JIS/IEC protection class 8 (IPX8) equivalent waterproofing. If water seeps inside the camera, however, this could cause the components to rust and result in a high repair charge or the camera may not be repairable.

After using the camera at the beach or underwater, make sure that the battery-chamber/memory card slot cover is firmly closed, and then immerse the camera in a shallow container filled with freshwater for 10 minutes.

After using the camera underwater, do not leave the camera wet for 60 minutes or more. This could cause deterioration of the waterproofing performance.

✔ Prevent Water From Seeping Inside the Camera

If the inside of the camera becomes wet, this could result in camera malfunction and the camera may not be repairable. To prevent water seeping (water submersion) accidents, be sure to observe the following cautions when using the camera.

- When the battery-chamber/memory card slot cover is closed, make sure that the camera strap, hair, lint, dust, sand grains, other foreign substances, or dirt are not attached on the waterproofing packing and portions that make a contact with the waterproofing packing.
- Do not open or close the battery-chamber/memory card slot cover in areas exposed to water spray, high winds, dust or sand.

- When an external force is applied on the camera, it could become deformed or the airtight seals may become damaged and cause water to seep inside the camera. Do not place a heavy object on the camera, drop the camera, or apply excessive force on the camera.
- If water seeps inside the camera, immediately stop using the camera. Wipe off moisture from the camera, and at once take the camera to your Nikon-authorized service representative.

Shock and Vibration

Do not drop the camera, strike it against a hard object such as a rock, or throw it at a water surface. Do not leave the camera in an area subject to vibration. If the camera is subjected to excessive shock, this could result in camera malfunction or damage.

Maximum Depth

COOLPIX S31 is designed to withstand water pressure up to a depth of 5 m (16.4 ft) for approx. 60 minutes. At greater depth, water could seep inside the camera, resulting in camera malfunction.

Avoid Sudden Changes in Temperature

- Sudden changes in temperature, such as when entering or leaving a heated building on a cold day, can cause condensation to form inside the device. To prevent condensation, place the device in a carrying case or a plastic bag before exposing it to sudden changes in temperature.
- Do not expose the camera to high temperatures by leaving it on the beach or in direct sunlight before entering the water.

Keep away from Strong Magnetic Fields

Do not use or store this device in the vicinity of equipment that generates strong electromagnetic radiation or magnetic fields. Strong static charge or the magnetic fields produced by equipment such as radio transmitters could interfere with the monitor, damage data saved on the memory card, or affect the product's internal circuitry.

Do Not Point the Lens at Strong Light Sources for Extended Periods

Avoid pointing the lens at the sun or other strong light sources for extended periods when using or storing the camera. Intense light may damage the image sensor or other components, producing a white blur effect in photographs.

Turn the Product off Before Removing or Disconnecting the Power Source

Removing the battery or memory card while the camera is on could damage the camera or memory card. If removed while the camera is saving or deleting data, data may be lost and the camera's memory or the memory card may be damaged.

Notes on the Monitor

- Monitors and electronic viewfinders are constructed with extremely high precision; at least 99.99% of pixels are effective, with no more than 0.01% being missing or defective. Hence while these displays may contain pixels that are always lit (white, red, blue, or green) or always off (black), this is not a malfunction and has no effect on images recorded with the device.
- Scraping or pressing on the surface of the monitor may result in damage or malfunction. Should the monitor break, care should be taken to avoid injury caused by broken glass and to prevent the liquid crystal from the display touching the skin or entering the eyes or mouth.
- Images in the monitor may be difficult to see under bright lighting.
- The monitor is lit by an LED backlight. Should the monitor begin to dim or flicker, contact your Nikon-authorized service representative.

Notes About Smear

White or colored streaks may be visible when bright subjects are framed in the monitor. This phenomenon, known as "smear," occurs when extremely bright light strikes the image sensor; it is characteristic of image sensors and does not indicate a malfunction. Smear may also take the form of partial discoloration in the monitor during shooting. It does not appear in saved still images but may be seen in movies. When recording movies, we recommend that you avoid bright subjects such as the sun, reflected sunlight, and electric lights.

The Battery

- Be sure to read and follow the warnings of “For Your Safety” (📖 ix-xii) thoroughly before using the battery.
- Check the battery level before using the camera and replace or charge the battery if necessary. Do not continue charging once the battery is fully charged as this will result in reduced battery performance. Whenever possible, carry a fully charged spare battery when taking pictures on important occasions.
- Do not use the battery at ambient temperatures below 0°C (32°F) or above 40°C (104°F).
- When the battery temperature is between 0°C and 10°C (32°F–50°F) or 45°C–60°C (113°F–140°F), the chargeable capacity may decrease.
- The battery is not charged at ambient temperatures below 0°C (32°F) or above 60°C (140°F).
- Note that the battery may become hot during use; wait for the battery to cool before charging. Failure to observe these precautions could damage the battery, impair its performance, or prevent it from charging normally.
- On cold days, the capacity of batteries tends to decrease. Be sure that the battery is fully charged before heading outside to take pictures in cold weather. Keep spare batteries in a warm place and exchange as necessary. Once warmed, a cold battery may recover some of its charge.
- Dirt on the battery terminals can prevent the camera from functioning. Should the battery terminals become dirty, wipe them off with a clean, dry cloth before use.
- If the battery will not be used for some time, insert it in the camera and run it flat before removing it for storage. The battery should be stored in a cool location with an ambient temperature of 15°C–25°C (59°F–77°F). Do not store the battery in hot or extremely cold locations.
- Always remove the battery from the camera or battery charger when it is not being used. When inserted, minute amounts of current are drawn from the battery even when not in use. This may result in excessive draining of the battery and complete loss of function. Turning the camera on or off while the battery is exhausted can result in reduced battery life. When the battery level is low, be sure to charge the battery before using it.
- Recharge the battery at least once every six months and completely exhaust it before returning it to storage.
- After removing the battery from the camera or battery charger, attach the included terminal cover to the battery and store it in a cool place.

- A marked drop in the time a fully-charged battery retains its charge, when used at room temperature, indicates that the battery needs to be replaced. Purchase a new EN-EL12 battery.
- Replace the battery when it no longer holds a charge. Used batteries are a valuable resource. Please recycle used batteries in accordance with local regulations.

The Battery Charger

- Be sure to read and follow the warnings of “For Your Safety” (📖 ix-xii) thoroughly before using the battery charger.
- The included Battery Charger is for use only with a Rechargeable Li-ion Battery EN-EL12.

Memory Cards

- Use only Secure Digital memory cards. Approved memory cards → :22
- Observe the precautions noted in the documentation included with your memory card.
- Do not affix labels or stickers to the memory card.
- Do not format the memory card using a computer.
- Before using a memory card with this camera, format the card using this camera if the card has been used with another device. Before using a new memory card, we recommend using this camera to format the card.
- Note that **formatting a memory card permanently deletes all images and other data on the memory card**. If there is data saved on the memory card that you wish to keep, copy that data to a computer before formatting.
- If the message **Card is not formatted. Format card?** is displayed when you insert a memory card, the memory card must be formatted. If there is data on the memory card that you do not want to delete, press flexible button 4 (**X No**). Copy that data to a computer before formatting. To format the memory card, press flexible button 3 (**O Yes**).
- Observe the following precautions while formatting the memory card, saving and deleting images, and copying images to a computer, otherwise data or the memory card itself may be damaged.
 - Do not open the battery-chamber/memory card slot cover to remove the battery or memory card.
 - Do not turn off the camera.
 - Do not disconnect the AC adapter.

Cleaning and Storage

Cleaning

Do not use alcohol, thinner, or other volatile chemicals.

Lens	When cleaning the lens, avoid touching it directly with your fingers. Remove dust or lint with a blower. To remove fingerprints, oil, or other grime that cannot be removed with a blower, wipe the lens with a soft, dry cloth or an eyeglass cleaning cloth, using a gentle spiral motion that starts in the center and moves toward the edges. Do not wipe forcefully or wipe with a rough cloth, otherwise the camera may be damaged or malfunction. If you still cannot remove the grime, wet a soft cloth with a commercial liquid lens cleaner and gently wipe off the grime.
Monitor	Remove dust or lint with a blower. To remove fingerprints, oil, or other grime, wipe the area with a soft, dry cloth or an eyeglass cleaning cloth. Do not wipe forcefully or wipe with a rough cloth, otherwise the camera may be damaged or malfunction.
Body	<ul style="list-style-type: none">• Remove dust or lint with a blower. Wipe with a soft, dry cloth.• After using the camera underwater or at the beach, gently wipe off any sand or salt with a soft cloth lightly dampened with fresh water and dry thoroughly.• If you handle the camera using hands where sunscreen lotion is applied, this could cause deterioration of the camera exterior. <p>Note that foreign matter inside the camera could cause damage not covered by the warranty.</p>



More Information

See "Notes About Waterproof and Dustproof Performances" (📖 xvi) and "Cleaning After Using the Camera Underwater" (📖 xviii) for more information.

Storage

Remove the battery if the camera will not be used for an extended period. To prevent mold or malfunction and to ensure long, trouble-free use of the camera, we recommend you insert the battery and operate the camera approx. once a month. Do not store the camera with naphtha or camphor moth balls, or in any of the following locations:





- Next to equipment that produces strong electromagnetic fields, such as televisions or radios
- Places that are exposed to temperatures below -10°C (14°F) or above 50°C (122°F)
- Places that are poorly ventilated or subject to humidity of over 60%









Be sure to read and follow the warnings given in “The Battery” (🔋:5) of “Caring for the Product” to store the battery.



Troubleshooting

If the camera fails to function as expected, check the list of common problems below before consulting your retailer or Nikon-authorized service representative.







Power, Display, Settings Issues







Problem	Cause/Solution	
The camera is on but does not respond.	<ul style="list-style-type: none">• Wait for recording to end.• If the problem persists, turn the camera off. If the camera does not turn off, remove and reinsert the battery or batteries or, if you are using an AC adapter, disconnect and reconnect the AC adapter. Note that although any data currently being recorded will be lost, data that have already been recorded will not be affected by removing or disconnecting the power source.	– 12, 21,  63
Camera cannot be turned on.	Battery is exhausted.	20
Camera turns off without warning.	<ul style="list-style-type: none">• Battery is exhausted.• Camera has turned off automatically to save power.• The camera turns off if the USB cable connecting it to a computer or printer is disconnected. Reconnect the USB cable.• Inside of the camera has become hot. Leave the camera off until the inside of the camera has cooled.• The camera or battery have become too cold and cannot operate properly.	20 21 68, 73,  53 –  5





Problem	Cause/Solution	
Monitor is blank.	<ul style="list-style-type: none"> • Camera is off. • Battery exhausted. • Standby mode for saving power: Press the power switch, the shutter-release button,  (shooting/playback mode) button, or  movie-record button. • When flash lamp flashes, wait until flash has charged. • Camera and computer are connected via USB cable. • Camera and TV are connected via audio/video cable. 	21 20 2, 21 36 68, 73 68,  50
Monitor is hard to read.	<ul style="list-style-type: none"> • Adjust monitor brightness. • Monitor is dirty. Clean monitor. 	84,  40  8
Date and time of recording are not correct.	<ul style="list-style-type: none"> • If camera clock has not been set,  flashes when shooting images and recording movies. Images and movies saved before clock is set are dated "00/00/0000 00:00" or "01.01.13 00:00" respectively. The shooting date and time of still images is not displayed during playback. Set the correct time and date using Date and time in the camera settings menu. • Check camera clock regularly against more accurate timepieces and reset as required. 	16, 84,  39
Print date not available.	Date and time in the camera settings menu has not been set.	16, 84,  39

Problem	Cause/Solution	
Date not imprinted on images even when Print date is enabled.	The date cannot be imprinted on movies and images captured using Take a series of pictures .	84,  41
Screen for setting time and date is displayed when camera is turned on.	Clock battery is exhausted; all settings were restored to their default values.	16, 19
Camera settings reset.		
Monitor turns off, and the power-on lamp flashes quickly.	Battery temperature is high. Turn off camera and allow battery to cool down before resuming use. After the lamp flashes for three minutes, the camera will turn off automatically. Pressing the power switch also turns off the camera.	21
Camera becomes hot.	The camera may become hot when recording movies for an extended period of time, or when the camera is used in a hot area; this is not a malfunction.	–







Shooting Issues



Problem	Cause/Solution	
Cannot switch to shooting mode.	Disconnect USB cable.	68, 73,  53
No image captured when the shutter-release button is pressed.	<ul style="list-style-type: none"> When camera is in playback mode, press the  (shooting/playback mode) button, the shutter-release button, or the  (movie-record) button. When menus are displayed, press the  (shooting/playback mode) button, shutter-release button, or  (movie-record) button. Battery is exhausted. When flash lamp flashes, flash is charging. 	2, 26 2 20 36

Problem	Cause/Solution	
Camera cannot focus.	<ul style="list-style-type: none"> • Subject is too close. Try moving away from the subject or setting Choose a style to Shoot close-ups. • The intended subject is one with which autofocus does not perform well. • Set AF assist in the camera settings menu to Auto. • Turn camera off and then on again. 	43 62 84,  43 21
Images are blurred.	<ul style="list-style-type: none"> • Use flash. • Use tripod and self-timer. • Enable electronic VR. 	35 37 84,  42
Streaks of light or partial discoloration are visible in the monitor.	Smear occurs when extremely bright light strikes the image sensor. When recording movies, avoiding bright objects, such as the sun, reflections of the sun, and electric lights is recommended.	79,  4
Bright specks appear in images captured with flash.	Flash is reflecting off particles in air. Set the flash mode setting to  Flash off .	35
Flash does not fire.	<ul style="list-style-type: none"> • The flash mode is set to  Flash off. • Choose a style is set to a feature that disables the flash. 	35 43
Optical zoom cannot be used.	Optical zoom cannot be used while recording movies.	79
Digital zoom cannot be used.	When Choose a style is set to Shoot under water , Take soft pictures , or Create a diorama effect , digital zoom cannot be used.	45, 47
No sound when shutter is released.	<ul style="list-style-type: none"> • Change sounds is set to Turn sound off, or Pick a shutter sound is set to  in the shooting menu. • Shutter sound is not heard when Choose a style is set to Take a series of pictures. • Do not block the speaker. 	52 45 2

Problem	Cause/Solution	
AF-assist illuminator does not light.	Off is selected for AF assist in the camera settings menu. Even when Auto is selected, AF-assist illuminator does not light when Photograph fireworks is used. It also may not light depending on the scene automatically selected by the camera when using  Point and shoot.	34, 46
Images appear smeared.	Lens is dirty. Clean lens.	 8
Colors are unnatural.	Hue is not adjusted properly.	43, 49
Randomly spaced bright pixels (“noise”) appear in image.	The subject is dark, so shutter speed is too slow or ISO sensitivity is too high. Noise can be reduced by using flash.	35
Images are too dark (underexposed).	<ul style="list-style-type: none"> • The flash mode is set to  Flash off. • Flash is blocked by finger or other object. • Subject is beyond flash range. • Adjust exposure compensation. 	35 22 36 51
Images are too bright (overexposed).	Adjust exposure compensation.	51
Saving images takes time.	It may take more time to save images in the following situations. <ul style="list-style-type: none"> • When the noise reduction function is in operation, such as when shooting in a dark environment • When the skin softening function is applied while shooting • Choose a style is set to Take a series of pictures. 	– 34, 41 45

Playback Issues

Problem	Cause/Solution	
File cannot be played back.	<ul style="list-style-type: none"> File or folder was overwritten or renamed by computer or other make of camera. This camera cannot play back movies recorded with another make or model of digital camera. 	<p>–</p> <p>82</p>
Cannot zoom in on image.	<ul style="list-style-type: none"> Playback zoom cannot be used with movies, small pictures, or images that have been cropped to a size of 320 × 240 or smaller. This camera may not be able to zoom in on images captured with another make or model of digital camera. 	<p>–</p>
Cannot record messages.	<ul style="list-style-type: none"> Messages cannot be attached to movies. Messages cannot be attached to images captured with other cameras. 	<p>–</p> <p>66, 2</p>
One of these features cannot be used: Soften pictures, Add starbursts, Add a fisheye effect, Add a diorama effect, Toy camera, Change colors, Highlight colors, Decorate, Small picture, or Crop	<ul style="list-style-type: none"> These options cannot be used with movies. Editing functions other than Rotate pictures cannot be added to images created using Make photo albums. Editing functions other than Make photo albums, Small picture, and Rotate pictures cannot be added to images captured using Decorate. Images cannot be edited when played back using View favorites. You cannot apply the same editing feature multiple times to the same image. This camera cannot edit images captured with another make or model of digital camera. 	<p>–</p> <p>66, 17</p> <p>48</p> <p>66, 29</p> <p>66, 8</p> <p>66, 8</p>
Cannot rotate image.	This camera cannot rotate images captured with another make or model of digital camera.	<p>–</p>
Images are not displayed on TV.	<ul style="list-style-type: none"> Video mode is not correctly set in the camera settings menu. Memory card contains no images. Replace the memory card. Remove the memory card to play back images from the internal memory. 	<p>84, 46</p> <p>14</p>

Problem	Cause/Solution	
Images added to favorites cannot be displayed using View favorites	Data saved in the internal memory or on the memory card may not be played back correctly if overwritten by a computer.	–
Nikon Transfer 2 does not start when camera is connected.	<ul style="list-style-type: none"> • Camera is off. • Battery is exhausted. • USB cable is not correctly connected. • Camera is not recognized by the computer. • Confirm system requirements. • Computer is not set to start Nikon Transfer 2 automatically. For more information about Nikon Transfer 2, refer to help information contained in ViewNX 2. 	21 20 68, 73 – 70 73
Images to be printed are not displayed.	<ul style="list-style-type: none"> • Memory card contains no images. Replace the memory card. • Remove the memory card to print images from the internal memory. 	14
Cannot select paper size with camera.	<p>Paper size cannot be selected from the camera in the following situations, even when printing from a PictBridge-compatible printer. Use the printer to select paper size.</p> <ul style="list-style-type: none"> • The printer does not support the paper sizes specified by the camera. • The printer automatically selects the paper size. 	68,  56,  57 –

Specifications

Nikon COOLPIX S31 Digital Camera

Type	Compact digital camera
Number of effective pixels	10.1 million
Image sensor	$1/2.9$ -in. type CCD; approx. 10.34 million total pixels
Lens	NIKKOR lens with 3 \times optical zoom
Focal length	4.1–12.3 mm (angle of view equivalent to that of 29–87 mm lens in 35mm [135] format)
f/-number	f/3.3–5.9
Construction	6 elements in 5 groups
Digital zoom magnification	Up to 4 \times (angle of view equivalent to that of approx. 348 mm lens in 35mm [135] format)
Motion blur reduction	Electronic VR (still pictures), motion detection (still pictures)
Autofocus (AF)	Contrast-detect AF
Focus range	<ul style="list-style-type: none">• [W]: Approx. 30 cm (1 ft)–∞, [T]: Approx. 50 cm (1 ft 8 in.)–∞• Shoot close-ups, Photograph food, Shoot under water, Mirror, Take soft pictures, Create a diorama effect, Highlight colors: Approx. 5 cm (2 in.) (wide-angle position)–∞ (All distances measured from center of front surface of the protective glass)
Focus-area selection	Center, face detection
Monitor	6.7 cm (2.7-in.), approx. 230k-dot, TFT LCD with anti-reflection coating and 5-level brightness adjustment
Frame coverage (shooting mode)	Approx. 97% horizontal and 97% vertical (compared to actual picture)
Frame coverage (playback mode)	Approx. 100% horizontal and 100% vertical (compared to actual picture)

Storage	
Media	Internal memory (approx. 26 MB), SD/SDHC/SDXC memory card
File system	DCF, Exif 2.3, and DPOF compliant
File formats	Still pictures: JPEG Voice messages: WAV Movies: AVI (Motion-JPEG compliant)
Image size (photo size)	<ul style="list-style-type: none"> • 10 megapixels [3648 × 2736] • 4 megapixels [2272 × 1704] • 2 megapixels [1600 × 1200]
ISO sensitivity (Standard output sensitivity)	ISO 80–1600
Exposure	
Metering mode	Matrix, center-weighted (digital zoom less than 2×), spot (digital zoom 2× or more)
Exposure control	Programmed auto exposure and exposure compensation (–2.0 – +2.0 EV in steps of 1 EV)
Shutter	Mechanical and charge-coupled electronic shutter
Speed	<ul style="list-style-type: none"> • $\frac{1}{2000}$–1 s • 4 s (Choose a style is set to Photograph fireworks)
Aperture	Electronically-controlled ND filter (–3 AV) selection
Range	2 steps (f/3.3 and f/9.3 [W])
Self-timer	Approx. 10 s, smile timer
Built-in flash	
Range (approx.) (ISO sensitivity: Auto)	[W]: 0.5–3.5 m (1 ft 8 in.–11 ft) [T]: 0.5–2.0 m (1 ft 8 in.–6 ft 6 in.)
Flash control	TTL auto flash with monitor preflashes
Interface	Hi-Speed USB
Data transfer protocol	MTP, PTP
Video output	Can be selected from NTSC and PAL

I/O terminal	Audio/video (A/V) output; digital I/O (USB)
Supported languages	Arabic, Bengali, Chinese (Simplified and Traditional), Czech, Danish, Dutch, English, Finnish, French, German, Greek, Hindi, Hungarian, Indonesian, Italian, Japanese, Korean, Marathi, Norwegian, Persian, Polish, Portuguese (European and Brazilian), Romanian, Russian, Spanish, Swedish, Tamil, Telugu, Thai, Turkish, Ukrainian, Vietnamese
Power sources	<ul style="list-style-type: none"> • One Rechargeable Li-ion Battery EN-EL12 (included) • AC Adapter EH-62F (available separately)
Battery life¹	
Still pictures	Approx. 260 shots when using EN-EL12
Movies (actual battery life for recording)²	Approx. 2 h when using EN-EL12
Tripod socket	1/4 (ISO 1222)
Dimensions (W × H × D)	Approx. 105.4 × 64.8 × 41.5 mm (4.2 × 2.6 × 1.7 in.) (excluding projections)
Weight	Approx. 185 g (6.6 oz) (including battery and SD memory card)
Operating environment	
Temperature	-10°C – +40°C (14°F–104°F) (for land use) 0°C–40°C (32°F–104°F) (for underwater use)
Humidity	85% or less (no condensation)
Waterproof	JIS/IEC protection class 8 (IPX8) equivalent (under our testing conditions) Capacity to shoot pictures underwater up to a depth of 5 m (16.4 ft) and for 60 minutes
Dustproof	JIS/IEC protection class 6 (IP6X) equivalent (under our testing conditions)
Shockproof	Cleared our testing conditions ³ compliant with MIL-STD 810F Method 516.5-Shock

- Unless otherwise stated, all figures assume a fully-charged battery and an ambient temperature of 23 ±3 °C (73.4 ±5.4 °F) as specified by the Camera and Imaging Products Association (CIPA).

- ¹ Figures based on the Camera and Imaging Products Association (CIPA) standards for measuring the endurance of camera batteries. Performance for still pictures measured under the following test conditions: **Large (10 megapixels)** (3648 × 2736) selected for **Choose a size > Photo size**, zoom adjusted with each shot, and flash fired with every other shot. Movie recording time assumes that **Large (720p)** (1280 × 720) is selected for **Choose a size > Movie frame size**. Figures may vary with use, the interval between shots, and the length of time menus and images are displayed.
- ² Individual movie files can not exceed 4 GB in size or 29 minutes in length. Recording may end before this limit is reached if camera temperature becomes elevated.
- ³ Dropped from a height of 1.2 m (3.9 ft) onto a surface of 5 cm (2 in.) thick plywood (changes in appearance, such as paint peeling off and deformation of the drop shock portion and waterproof performance are not subject to the test). These tests do not guarantee that the camera will be free from damage or trouble under all conditions.

Rechargeable Li-ion Battery EN-EL12

Type	Rechargeable lithium-ion battery
Rated capacity	DC 3.7 V, 1050 mAh
Operating temperature	0°C–40°C (32°F–104°F)
Dimensions (W × H × D)	Approx. 32 × 43.8 × 7.9 mm (1.3 × 1.7 × 0.3 in.)
Weight	Approx. 22.5 g (0.8 oz) (excluding terminal cover)

Battery Charger MH-65

Rated input	AC 100–240 V, 50/60 Hz, 0.08–0.05 A
Rated output	DC 4.2 V, 0.7 A
Supported rechargeable battery	Rechargeable Li-ion Battery EN-EL12
Charging time	Approx. 2 hours and 30 minutes when no charge remains
Operating temperature	0°C–40°C (32°F–104°F)
Dimensions (W × H × D)	Approx. 58 × 27.5 × 80 mm (2.3 × 1.1 × 3.1 in.) (excluding power cable)
Length of power cable	Approx. 1.8 m (6 ft)
Weight	Approx. 70 g (2.5 oz) (excluding power cable)

Specifications

- Nikon will not be held liable for any errors this manual may contain.
- The appearance of this product and its specifications are subject to change without notice.

Approved Memory Cards

The following Secure Digital (SD) memory cards have been tested and approved for use in this camera.

- Memory cards with an SD Speed Class rating of 6 or faster are recommended for recording movies. When using a memory card with a lower Speed Class rating, movie recording may stop unexpectedly.

	SD memory card	SDHC memory card ²	SDXC memory card ³
SanDisk	2 GB ¹	4 GB, 8 GB, 16 GB, 32 GB	64 GB, 128 GB
TOSHIBA	2 GB ¹	4 GB, 8 GB, 16 GB, 32 GB	64 GB
Panasonic	2 GB ¹	4 GB, 8 GB, 16 GB, 32 GB	64 GB
Lexar	–	4 GB, 8 GB, 16 GB, 32 GB	64 GB, 128 GB

¹ If the memory card is used with a card reader or similar device, make sure that the device supports 2 GB cards.

² SDHC compliant. If the memory card is used with a card reader or similar device, make sure that the device supports SDHC.

³ SDXC compliant. If the memory card is used with a card reader or similar device, make sure that the device supports SDXC.

- Contact the manufacturer for details on the above cards. We cannot guarantee camera performance when using memory cards made by other manufacturers.



Supported Standards

- **DCF:** Design Rule for Camera File System is a standard widely used in the digital camera industry to ensure compatibility among different makes of camera.
- **DPOF:** Digital Print Order Format is an industry-wide standard that allows images to be printed from print orders saved on memory cards.
- **Exif version 2.3:** Exchangeable image file format (Exif) version 2.3 for digital still cameras is a standard that allows information saved with photographs to be used for optimal color reproduction when images are output from Exif-compliant printers.
- **PictBridge:** A standard developed cooperatively by the digital camera and printer industries, allowing photographs to be output directly to a printer without connecting the camera to a computer.

Trademark Information

- Microsoft, Windows and Windows Vista are either registered trademarks or trademarks of Microsoft Corporation in the United States and/or other countries.
- Macintosh, Mac OS, and QuickTime are trademarks of Apple Inc., registered in the U.S. and other countries.
- Adobe and Acrobat are registered trademarks of Adobe Systems Inc.
- SDXC, SDHC and SD Logos are trademarks of SD-3C, LLC.
- PictBridge is a trademark.
- All other trade names mentioned in this manual or the other documentation provided with your Nikon product are trademarks or registered trademarks of their respective holders.

FreeType License (FreeType2)







Portions of this software are copyright © 2013 The FreeType Project (["www.freetype.org"](http://www.freetype.org)). All rights reserved.

MIT License (Harfbuzz)













Portions of this software are copyright © 2013 The Harfbuzz Project (["http://www.freedesktop.org/wiki/Software/HarfBuzz"](http://www.freedesktop.org/wiki/Software/HarfBuzz)). All rights reserved.

Index

Symbols

 Point and shoot.....	34
 Playback mode.....	26
 Camera settings menu.....	84
 (shooting/playback mode) button... 3	
.AVI.....	 61
.JPG.....	 61
.WAV.....	 61

A



AC adapter.....	11,  63
Add a diorama effect.....	 7,  12
Add a fisheye effect.....	 7,  11
Add starbursts.....	 7,  10
Adding images to favorites.....	 19
AF-assist illuminator.....	2, 84,  43
Always fire flash.....	35
Aperture value.....	25
Audio/video cable.....	69,  50,  63
Audio/video-in jack.....	69,  50
Auto flash.....	35
Auto off.....	21
Autofocus.....	62



B

Battery.....	10, 12, 19
Battery chamber.....	3
Battery charger.....	10





Battery level.....	20
Battery-chamber/memory card slot cover.....	3
Brightness.....	51
Brush.....	xvi
Button sound.....	52





C

Camera settings.....	33,  38
Camera settings menu.....	84
Change colors (playback mode).....	 7,  14
Change colors (shooting mode) ...	32, 49
Change sounds.....	33, 52
CHARGE lamp.....	11





Choose a size.....	33, 54
Choose a style.....	32, 42
Compression ratio.....	54
Computer.....	69, 73
Copy.....	67,  30
Create a diorama effect 	47
Crop.....	64

D



Date and time.....	16, 84,  39
Date format.....	17,  39
Daylight saving time.....	17,  39
Decorate (playback mode)...  7,  16	





Decorate (shooting mode)	32, 48
Delete	28
Digital zoom	23
Direct print	69,  52
DPOF	 23
DPOF print	 59
DSCN	 61

E



Electronic VR	84,  42
Erase recordings	 5
Exchange messages	66,  2
Exposure compensation	51
Extension	 61
Eyelet for camera strap	2

F

Face detection	60
Favorites	66,  19
Features that cannot be used simultaneously	58
File name	 61
Firmware version	84,  49
Flash	2, 32, 35
Flash lamp	3
Flash mode	35
Flash off	35
Flexible buttons	7
Focus	24, 60
Focus indicator	5

Focus lock	61
Folder name	 61
Format internal memory	84,  44
Format memory cards	15, 84,  44
Formatting	15, 84,  44
FSCN	 61
Full-frame playback mode	26





H

Have fun with pictures	66
Highlight colors (playback mode)	 7,  15
Highlight colors (shooting mode)	51



I





Identifier	 61
Internal memory	15

L

Language	84,  45
Leave a message (recording a message)	 2
Leave a reply (recording a message)	 4
Lens	2,  17

M

Make photo albums	66,  17
Memory capacity	20
Memory card	14,  22
Memory card slot	3, 14
Menu background	18, 84,  46

Microphone.....	2
Mirror 	46
Monitor.....	3, 5,  8
Monitor brightness.....	84,  40
More playback options.....	 27
Movie frame size.....	56
Movie playback.....	81
Movie recording.....	78
Movie recording time.....	57
Multi selector.....	3









N









Nikon Transfer 2.....	72, 73, 74
Number of exposures remaining...	20, 55

O





Optical zoom.....	23
Optional accessories.....	 63

P



Panorama Maker.....	72
Paper size.....	 56,  57
Photo size.....	54
Photograph fireworks 	46
Photograph food 	43
PictBridge.....	69,  52,  23
Picture play.....	66,  7
Play recordings.....	 5
Playback.....	26, 81
Playback menu.....	66
Playback mode.....	26





Playback zoom.....	64
Power.....	20, 21
Power switch/power-on lamp...	2, 20, 21
Pressing halfway.....	25
Print.....	69,  35,  55,  57
Print date.....	19, 84,  41
Print order.....	67,  35
Print order option.....	19,  36,  37
Printer.....	69,  52

R





Rechargeable battery.....	10
Rechargeable Li-ion battery.....	10
Recording movies.....	78
Removing images from favorites...	 20
Reset all.....	84,  47
Rotate pictures.....	67,  33
RSCN.....	 61

S

Saturation.....	51
Self-timer.....	32, 37
Self-timer lamp.....	2, 38
Shoot at intervals 	44
Shoot close-ups 	43
Shoot under water 	45
Shooting.....	22, 24
Shutter sound.....	52
Shutter speed.....	25
Shutter-release button.....	2, 24

Slide show	66, 	21
Small picture	67, 	34
Smile timer		39
Soften pictures.....	 7, 	9
Speaker.....		2
SSCN.....		61
Strap		4







I

Take a series of pictures 		45
Take soft pictures 		47
Thumbnail display.....		65
Toy camera.....		7
Tripod socket	3, 	19
TV	69, 	50

U

USB cable	69, 73, 	54	
USB/audio/video output connector	3, 68, 73, 	50, 	54
Using skin softening.....		41	

V

Video mode	84, 	46
View.....	66, 	26
View by date.....	67, 	27
View favorites	67, 	29
View movie	66, 	26
ViewNX 2.....	70, 71, 72	
Vividness.....		51
Volume	82, 	

W

Welcome screen	84, 	38
----------------------	---	----

Z

Zoom		23
Zoom in.....		23
Zoom out.....		23



A series of ten horizontal dashed lines, evenly spaced, extending across the width of the page. These lines are intended for handwriting practice.

No reproduction in any form of this manual, in whole or in part (except for brief quotation in critical articles or reviews), may be made without written authorization from NIKON CORPORATION.

NIKON CORPORATION

© 2013 Nikon Corporation



CT5F02(11)
6MN13211-02