

# ***Nikon***

DIGITAL CAMERA

# COOLPIX S2800

## User's Manual



For advanced use of the camera, read the Reference Manual (in pdf format) which is available in many languages including Hindi, Bengali, Tamil, Marathi and Telugu. See the reverse side for information to download the file.

**En**



<b>Introduction</b>	
<b>Parts of the Camera</b>	
<b>The Basics of Shooting and Playback</b>	
<b>Shooting Features</b>	
<b>Playback Features</b>	
<b>Recording and Playing Back Movies</b>	
<b>General Camera Setup</b>	
<b>Connecting the Camera to a TV, Computer, or Printer</b>	
<b>Technical Notes and Index</b>	

# Introduction

## Read This First

Thank you for purchasing the Nikon COOLPIX S2800 digital camera. Before using the camera, please read the information in "For Your Safety" (viii-x) and familiarize yourself with the information provided in this manual. After reading, please keep this manual handy and refer to it to enhance your enjoyment of your new camera.

## Confirming the Package Contents

In the event that any items are missing, please contact the store where you purchased the camera.



COOLPIX S2800  
Digital Camera



Camera Strap



Rechargeable Li-ion  
Battery EN-EL19



Charging AC Adapter  
EH-70P<sup>1</sup>

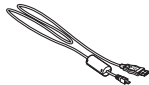

USB Cable UC-E6

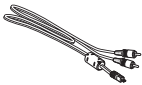

Audio Video Cable  
EG-CP14<sup>2</sup>



ViewNX 2 CD

- *User's Manual* (this manual)
- *Warranty*

<sup>1</sup> A plug adapter is included if the camera was purchased in a country or region that requires a plug adapter. The shape of the plug adapter varies with the country or region of purchase (viii-12).

<sup>2</sup> This item is supplied only if the camera was purchased in India, and is described in this manual as being "optional," "available separately," etc.

**NOTE:** A memory card is not included with the camera.

## About This Manual

If you want to start using the camera right away, see “The Basics of Shooting and Playback” (📖10).

To learn about the parts of the camera and information that is displayed in the monitor, see “Parts of the Camera” (📖1).

### Downloading the “Reference Manual”







Refer to the *Reference Manual* (PDF format) for more detailed information. The *Reference Manual* can be downloaded from the Nikon website.

<http://nikonimglib.com/manual/>

The *Reference Manual* can be viewed using Adobe Reader, available for free download from the Adobe website.

## Other Information

- Symbols and Conventions

Symbol	Description
	This icon marks cautions and information that should be read before using the camera.
	This icon marks notes and information that should be read before using the camera.
 /  / 	These icons indicate other pages containing relevant information;  *: "Reference Section",  : "Technical Notes and Index"

- \* Refer to the *Reference Manual* for pages indicated with .
- SD, SDHC, and SDXC memory cards are referred to as "memory cards" in this manual.
  - The setting at the time of purchase is referred to as the "default setting."
  - The names of menu items displayed in the camera monitor, and the names of buttons or messages displayed on a computer monitor appear in bold.
  - In this manual, images are sometimes omitted from monitor display samples so that monitor indicators can be more clearly shown.
  - Illustrations and monitor content shown in this manual may differ from the actual display.

# Information and Precautions

## Life-Long Learning

As part of Nikon's "Life-Long Learning" commitment to ongoing product support and education, continually updated information is available online at the following sites:

- For users in the U.S.A.: <http://www.nikonusa.com/>
- For users in Europe and Africa: <http://www.europe-nikon.com/support/>
- For users in Asia, Oceania, and the Middle East: <http://www.nikon-asia.com/>

Visit these sites to keep up-to-date with the latest product information, tips, answers to frequently asked questions (FAQs), and general advice on digital imaging and photography. Additional information may be available from the Nikon representative in your area. Visit the site below for contact information.

<http://imaging.nikon.com/>

## Use Only Nikon Brand Electronic Accessories

Nikon COOLPIX cameras are designed to the highest standards and include complex electronic circuitry. Only Nikon brand electronic accessories (including battery chargers, batteries, Charging AC Adapter, and AC adapters) certified by Nikon specifically for use with this Nikon digital camera are engineered and proven to operate within the operational and safety requirements of this electronic circuitry.

THE USE OF NON-NIKON ELECTRONIC ACCESSORIES COULD DAMAGE THE CAMERA AND MAY VOID YOUR NIKON WARRANTY.

The use of third-party rechargeable Li-ion batteries not bearing the Nikon holographic seal could interfere with normal operation of the camera or result in the batteries overheating, igniting, rupturing, or leaking.

For more information about Nikon brand accessories, contact a local authorized Nikon dealer.



### Holographic seal:

Identifies this device as an authentic Nikon product.

## Before Taking Important Images

Before taking images on important occasions (such as at weddings or before taking the camera on a trip), take a test shot to ensure that the camera is functioning normally. Nikon will not be held liable for damages or lost profits that may result from product malfunction.

## About the Manuals

- No part of the documentation included with this product may be reproduced, transmitted, transcribed, stored in a retrieval system, or translated into any language in any form, by any means, without Nikon's prior written permission.
- Nikon reserves the right to change the specifications of the hardware and software described in the documentation at any time and without prior notice.
- Nikon will not be held liable for any damages resulting from the use of this product.
- While every effort was made to ensure that the information in the documentation is accurate and complete, we would appreciate it were you to bring any errors or omissions to the attention of the Nikon representative in your area (address provided separately).

## Notice Concerning Prohibition of Copying or Reproduction

Note that simply being in possession of material that was digitally copied or reproduced by means of a scanner, digital camera or other device may be punishable by law.

### • Items prohibited by law from being copied or reproduced

Do not copy or reproduce paper money, coins, securities, government bonds or local government bonds, even if such copies or reproductions are stamped "Sample." The copying or reproduction of paper money, coins, or securities which are circulated in a foreign country is prohibited. Unless the prior permission of the government was obtained, the copying or reproduction of unused postage stamps or post cards issued by the government is prohibited. The copying or reproduction of stamps issued by the government and of certified documents stipulated by law is prohibited.

### • Cautions on certain copies and reproductions

The government has issued cautions on copies or reproductions of securities issued by private companies (shares, bills, checks, gift certificates, etc.), commuter passes or coupon tickets, except when a minimum of necessary copies are to be provided for business use by a company. Also, do not copy or reproduce passports issued by the government, licenses used by public agencies and private groups, ID cards and tickets, such as passes and meal coupons.

### • Comply with copyright notices

The copying or reproduction of copyrighted creative works such as books, music, paintings, woodcut prints, maps, drawings, movies and photographs is governed by national and international copyright laws. Do not use this product for the purpose of making illegal copies or to infringe copyright laws.

## Disposing of Data Storage Devices

Please note that deleting images or formatting data storage devices such as memory cards or built-in camera memory does not completely erase the original image data. Deleted files can sometimes be recovered from discarded storage devices using commercially available software, potentially resulting in the malicious use of personal image data. Ensuring the privacy of such data is the user's responsibility.

Before discarding a data storage device or transferring ownership to another person, erase all data using commercial deletion software, or format the device and then completely refill it with images containing no private information (for example, images of empty sky). Be sure to also replace any images selected for the **Select an image** option in the **Welcome screen** setting (📷73). Care should be taken to avoid injury or damage to property when physically destroying data storage devices.

## For Your Safety

To prevent damage to your Nikon product or injury to yourself or to others, read the following safety precautions in their entirety before using this equipment. Keep these safety instructions where all those who use the product will read them.

The consequences that could result from failure to observe the precautions listed in this section are indicated by the following symbol:



This icon marks warnings, information that should be read before using this Nikon product, to prevent possible injury.

## WARNINGS

### **Turn off in the event of malfunction**

Should you notice smoke or an unusual smell coming from the camera or Charging AC Adapter, unplug the Charging AC Adapter and remove the battery immediately, taking care to avoid burns. Continued operation could result in injury. After removing or disconnecting the power source, take the equipment to a Nikon-authorized service representative for inspection.

### **Do not disassemble**

Touching the internal parts of the camera or Charging AC Adapter could result in injury. Repairs should be performed only by qualified technicians. Should the camera or Charging AC Adapter break open as the result of a fall or other accident, take the product to a Nikon-authorized service

representative for inspection, after unplugging the product and/or removing the battery.

### **Do not use the camera or Charging AC Adapter in the presence of flammable gas**

Do not use electronic equipment in the presence of flammable gas, as this could result in explosion or fire.

 **Handle the camera strap with care**  
Never place the strap around the neck of an infant or child.

### **Keep out of reach of children**

Particular care should be taken to prevent infants from putting the battery or other small parts into their mouths.

**⚠ Do not remain in contact with the camera, battery charger, or AC adapter for extended periods while the devices are on or in use**

Parts of the devices become hot. Leaving the devices in direct contact with the skin for extended periods may result in low-temperature burns.

**⚠ Do not leave the product where it will be exposed to extremely high temperatures, such as in an enclosed automobile or in direct sunlight**

Failure to observe this precaution could cause damage or fire.

**⚠ Observe caution when handling the battery**

The battery may leak, overheat or explode if improperly handled. Observe the following precautions when handling the battery for use in this product:

- Before replacing the battery, turn the product off. If you are using the Charging AC Adapter/AC adapter, be sure it is unplugged.
- Use only a Rechargeable Li-ion Battery EN-EL19 (included). Charge the battery by using a camera that supports battery charging. To perform this operation, use either Charging AC Adapter EH-70P (included) or the **Charge by computer** function. The Battery Charger MH-66 (available separately) is also available to charge the battery without using a camera.

- When inserting the battery, do not attempt to insert it upside down or backwards.
- Do not short or disassemble the battery or attempt to remove or break the battery insulation or casing.
- Do not expose the battery to flame or to excessive heat.
- Do not immerse in or expose to water.
- Put the battery in a plastic bag, etc. in order to insulate it before transporting. Do not transport or store with metal objects such as necklaces or hairpins.
- The battery is prone to leakage when fully discharged. To avoid damage to the product, be sure to remove the battery when no charge remains.
- Discontinue use immediately should you notice any change in the battery, such as discoloration or deformation.
- If liquid from the damaged battery comes in contact with clothing or skin, rinse immediately with plenty of water.

**⚠ Observe the following precautions when handling the Charging AC Adapter**

- Keep dry. Failure to observe this precaution could result in fire or electric shock.
- Dust on or near the metal parts of the plug should be removed with a dry cloth. Continued use could result in fire.
- Do not handle the plug or go near the Charging AC Adapter during lightning storms. Failure to observe this precaution could result in electric shock.

- Do not damage, modify, forcibly tug or bend the USB cable, place it under heavy objects, or expose it to heat or flames. Should the insulation be damaged and the wires become exposed, take it to a Nikon-authorized service representative for inspection. Failure to observe these precautions could result in fire or electric shock.
- Do not handle the plug or Charging AC Adapter with wet hands. Failure to observe this precaution could result in electric shock.
- Do not use with travel converters or adapters designed to convert from one voltage to another or with DC-to-AC inverters. Failure to observe this precaution could damage the product or cause overheating or fire.

### **Use appropriate cables**

When connecting cables to the input and output jacks, use only the cables provided or sold by Nikon for the purpose, to maintain compliance with product regulations.

### **Handle moving parts with care**

Be careful that your fingers or other objects are not pinched by the lens cover or other moving parts.

### **CD-ROMs**

The CD-ROMs included with this device should not be played back on audio CD equipment. Playing CD-ROMs on an audio

CD player could cause hearing loss or damage the equipment.

### **Using the flash close to your subject's eyes could cause temporary visual impairment**

The flash should be no less than 1 meter (3 ft 4 in.) from the subject.

Particular care should be observed when photographing infants.

### **Do not operate the flash with the flash window touching a person or object**

Failure to observe this precaution could result in burns or fire.

### **Avoid contact with liquid crystal**

Should the monitor break, care should be taken to avoid injury caused by broken glass and to prevent liquid crystal from the monitor touching the skin or entering the eyes or mouth.

### **Turn the power off when using inside an airplane or the hospital**

Turn the power off while inside the airplane during take off or landing. Do not use wireless network functions while in the air. Follow the instructions of the hospital when using while in a hospital. The electromagnetic waves emitted by this camera may disrupt the electronic systems of the airplane or the instruments of the hospital. If you are using an Eye-Fi card, remove it from the camera before boarding an aircraft or entering a hospital.

## Notices

### **Notices for Customers in the U.S.A.**

#### **IMPORTANT SAFETY INSTRUCTIONS— SAVE THESE INSTRUCTIONS.**

#### **DANGER - TO REDUCE THE RISK OF FIRE OR ELECTRIC SHOCK, CAREFULLY FOLLOW THESE INSTRUCTIONS**

For connection to a supply not in the U.S.A., use an attachment plug adapter of the proper configuration for the power outlet if needed.

The power supply unit is intended to be correctly orientated in a vertical or floor mount position.

#### **Federal Communications Commission (FCC) Radio Frequency Interference Statement**

This equipment has been tested and found to comply with the limits for a Class B digital device, pursuant to Part 15 of the FCC rules. These limits are designed to provide reasonable protection against harmful interference in a residential installation. This equipment generates, uses, and can radiate radio frequency energy and, if not installed and used in accordance with the instructions, may cause harmful interference to radio communications. However, there is no guarantee that interference will not occur in a particular installation. If this equipment does cause harmful interference

to radio or television reception, which can be determined by turning the equipment off and on, the user is encouraged to try to correct the interference by one or more of the following measures:

- Reorient or relocate the receiving antenna.
- Increase the separation between the equipment and receiver.
- Connect the equipment into an outlet on a circuit different from that to which the receiver is connected.
- Consult the dealer or an experienced radio/television technician for help.



**Nikon**

**COOLPIX S2800**

#### **CAUTIONS**

##### **Modifications**

The FCC requires the user to be notified that any changes or modifications made to this device that are not expressly approved by Nikon Corporation may void the user's authority to operate the equipment.

##### **Interface Cables**

Use the interface cables sold or provided by Nikon for your equipment. Using other interface cables may exceed the limits of Class B Part 15 of the FCC rules.

## Notice for Customers in the State of California

### WARNING

Handling the cord on this product will expose you to lead, a chemical known to the State of California to cause birth defects or other reproductive harm.

### ***Wash hands after handling.***

Nikon Inc.,  
1300 Walt Whitman Road  
Melville, New York 11747-3064  
USA  
Tel: 631-547-4200

## Notice for Customers in Canada

CAN ICES-3 B / NMB-3 B

## Notices for Customers in Europe

### CAUTIONS

**RISK OF EXPLOSION IF BATTERY IS REPLACED BY AN INCORRECT TYPE.**

**DISPOSE OF USED BATTERIES ACCORDING TO THE INSTRUCTIONS.**

This symbol indicates that electrical and electronic equipment is to be collected separately.



The following apply only to users in European countries:

- This product is designated for separate collection at an appropriate collection point. Do not dispose of as household waste.

- Separate collection and recycling helps conserve natural resources and prevent negative consequences for human health and the environment that might result from incorrect disposal.
- For more information, contact the retailer or the local authorities in charge of waste management.





















This symbol on the battery indicates that the battery is to be collected separately. The following apply only to users in European countries:







- All batteries, whether marked with this symbol or not, are designated for separate collection at an appropriate collection point. Do not dispose of as household waste.
- For more information, contact the retailer or the local authorities in charge of waste management.

# Table of Contents

Introduction .....	ii	Step 3 Frame a Picture .....	24
Read This First .....	ii	Using the Zoom .....	25
Confirming the Package Contents .....	ii	Step 4 Focus and Shoot .....	26
About This Manual .....	iii	The Shutter-release Button .....	27
Information and Precautions .....	v	Step 5 Play Back Images .....	28
For Your Safety .....	viii	Step 6 Delete Images.....	30
WARNINGS .....	viii		
Notices .....	xi		
Parts of the Camera .....	1	Shooting Features .....	32
The Camera Body .....	1	<i>Auto</i> (Scene Auto Selector) Mode .....	32
Attaching the Camera Strap .....	3	Scene Mode (Shooting Suited to Scenes)	
Using Menus (the <b>MENU</b> Button) .....	4	.....	33
The Monitor .....	6	Tips and Notes.....	34
Shooting Mode .....	6	Special Effects Mode (Applying Effects	
Playback Mode .....	8	When Shooting) .....	38
		Smart Portrait Mode (Capturing Images of	
		Smiling Faces) .....	40
		📷 (Auto) Mode .....	42
		Using Quick Effects.....	43
		Functions That Can Be Set Using the Multi	
		Selector.....	44
		Using the Flash .....	45
		Using the Self-timer.....	47
		Using Macro Mode .....	49
		Adjusting Brightness (Exposure	
		Compensation) .....	50
		Default Settings.....	51
		Functions That Can Be Set with the <b>MENU</b>	
		Button (Shooting Menu) .....	53
The Basics of Shooting and Playback	10		
Preparation 1 Insert the Battery .....	10		
Preparation 2 Charge the Battery .....	12		
Preparation 3 Insert a Memory Card .....	14		
Internal Memory and Memory Cards.....	15		
Preparation 4 Setting the Display Language,			
Date, and Time.....	16		
Step 1 Turn the Camera On .....	20		
Step 2 Select a Shooting Mode.....	22		
Available Shooting Modes .....	23		

Options Available in the Shooting Menu .....	54	Installing ViewNX 2.....	77
<b>Functions That Cannot Be Used</b>		Transferring Images to the Computer.....	80
Simultaneously .....	56	Viewing Images .....	82
<b>Focusing</b> .....	58	<b>Reference Section</b> .....	 1
Using Face Detection .....	58	Using Panorama Assist.....	 2
Using Skin Softening.....	59	<b>Favorite Pictures Mode</b> .....	 5
Using Target Finding AF .....	60	Adding Images to Albums.....	 5
Subjects Not Suitable for Autofocus .....	61	Playing Back Images in Albums.....	 6
Focus Lock.....	62	Removing Images from Albums .....	 7
<b>Playback Features</b> .....	63	Changing the Favorites Album Icon ...	 8
Playback Zoom .....	63	<b>Auto Sort Mode</b> .....	 9
Thumbnail Playback/Calendar Display ....	64	<b>List by Date Mode</b> .....	 10
<b>Functions That Can Be Set with the MENU Button (Playback Menu)</b> .....	65	<b>Editing Images (Still Images)</b> .....	 11
<b>Recording and Playing Back Movies</b> ....	67	Before Editing Images .....	 11
Recording Movies .....	67	Quick Effects: Changing Hue or Mood .....	 12
Functions That Can Be Set with the MENU Button (Movie Menu) .....	70	Quick Retouch: Enhancing Contrast and Saturation.....	 13
Playing Back Movies .....	71	D-Lighting: Enhancing Brightness and Contrast .....	 13
<b>General Camera Setup</b> .....	73	Red-eye Correction: Correcting Red-eye When Shooting with the Flash .....	 14
Functions That Can Be Set with the MENU Button (Setup Menu) .....	73	Glamour Retouch: Enhancing Human Faces .....	 15
<b>Connecting the Camera to a TV, Computer, or Printer</b> .....	75	Small Picture: Reducing the Size of an Image.....	 17
Connection Methods.....	75	Crop: Creating a Cropped Copy.....	 18
Using ViewNX 2 .....	77	<b>Connecting the Camera to a TV (Playback on a TV)</b> .....	 19
		<b>Connecting the Camera to a Printer (Direct Print)</b> .....	 20

Connecting the Camera to a Printer .....	21	Welcome Screen.....	58
.....	21	Time Zone and Date.....	59
Printing Images One at a Time .....	23	Monitor Settings .....	61
Printing Multiple Images.....	25	Print Date (Imprinting Date and Time) .....	63
<b>The Shooting Menu (for  (Auto) Mode)</b> .....	28	Electronic VR.....	64
Image Mode (Image Size and Quality) .....	28	Motion Detection.....	65
White Balance (Adjusting Hue) .....	30	AF Assist .....	66
Continuous shooting.....	33	Digital Zoom .....	66
ISO Sensitivity .....	35	Sound Settings.....	67
Color Options .....	36	Auto Off .....	67
AF Area Mode.....	37	Format Memory/Format Card .....	68
Autofocus Mode .....	41	Language.....	69
Quick Effects .....	41	Video Mode.....	69
<b>The Smart Portrait Menu .....</b>	42	Charge by Computer .....	70
Skin Softening .....	42	Blink Warning.....	71
Smile Timer .....	43	Eye-Fi Upload.....	72
Blink Proof.....	44	Reset All .....	73
<b>The Playback Menu .....</b>	45	Firmware Version.....	73
Print Order (Creating a DPOF Print Order) .....	45	<b>Error Messages.....</b>	74
Slide Show .....	49	<b>File Names .....</b>	78
Protect.....	50	<b>Optional Accessories .....</b>	79
Rotate Image.....	52	<b>Technical Notes and Index .....</b>	1
Voice Memo .....	53	<b>Caring for the Product.....</b>	2
Copy (Copy Between Internal Memory and Memory Card) .....	54	The Camera.....	2
<b>The Movie Menu .....</b>	56	The Battery.....	4
Movie Options.....	56	Charging AC Adapter.....	5
Autofocus Mode.....	57	Memory Cards .....	5
Wind Noise Reduction .....	57	<b>Cleaning and Storage.....</b>	6
<b>The Setup Menu .....</b>	58	Cleaning .....	6
		Storage.....	6

Troubleshooting .....		7
Specifications .....		16
Approved Memory Cards.....		20
Index.....		22

# Parts of the Camera

## The Camera Body

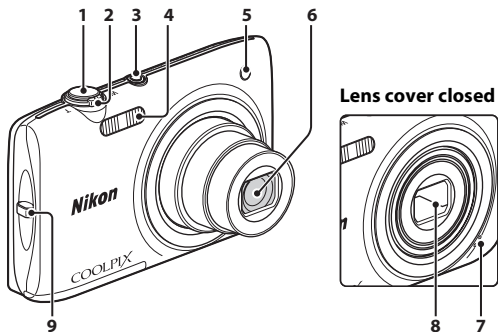

<b>1</b>	Shutter-release button.....	26
<b>2</b>	Zoom control.....	25
	<b>W</b> : Wide-angle.....	25
	<b>T</b> : Telephoto.....	25
	Thumbnail playback.....	64
	Playback zoom.....	63
	Help.....	33
<b>3</b>	Power switch/power-on lamp.....	20
<b>4</b>	Flash.....	45

<b>5</b>	Self-timer lamp.....	48
	AF-assist illuminator.....	74
<b>6</b>	Lens	
<b>7</b>	Built-in microphone.....	53
<b>8</b>	Lens cover.....	2
<b>9</b>	Eyelet for camera strap.....	3

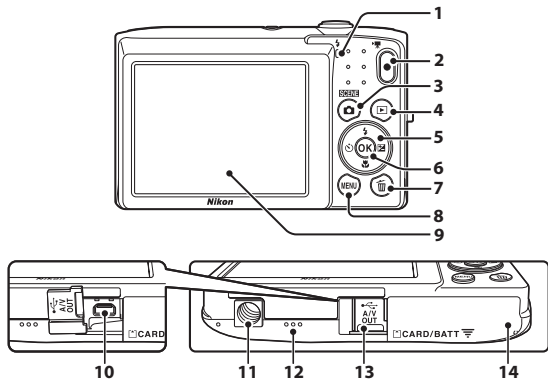

<b>1</b>	Charge lamp.....	13	<b>8</b>	<b>MENU</b> button.....	4, 53, 65, 70, 73
<b>2</b>	Flash lamp.....	45	<b>9</b>	Monitor .....	6
<b>3</b>	● (movie-record) button.....	67	<b>10</b>	USB/audio/video output connector.....	75
<b>4</b>	📷 (shooting mode) button .....	22, 33, 38, 40, 42	<b>11</b>	Tripod socket.....	18
<b>5</b>	▶ (playback) button .....	28	<b>12</b>	Speaker	
<b>6</b>	⊙ (apply selection) button		<b>13</b>	Connector cover .....	75
<b>7</b>	🗑 (delete) button .....	30, 72, 54	<b>14</b>	Battery-chamber/ memory card slot cover.....	10, 14

## Attaching the Camera Strap

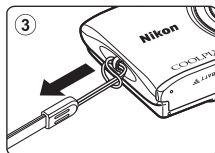
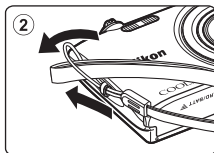
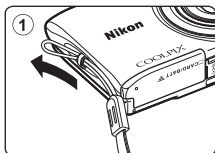

# Using Menu (the MENU Button)

Use the multi selector and the **OK** button to navigate the menus.

## 1 Press the MENU button.

- The menu is displayed.

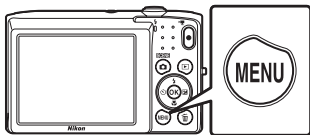

## 2 Press the multi selector ◀.

- The current menu icon is displayed in yellow.

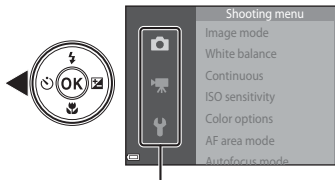

Menu icons

## 3 Select the desired menu icon.

- The menu is changed.

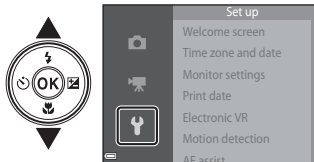

## 4 Press the OK button.

- The menu options become selectable.

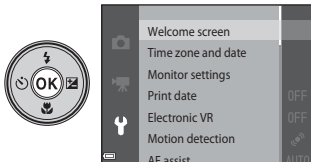

## 5 Select a menu option.

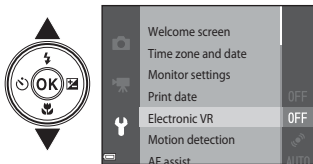

## 6 Press the OK button.

- The settings for the option you selected are displayed.

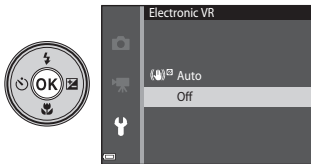

## 7 Select a setting.

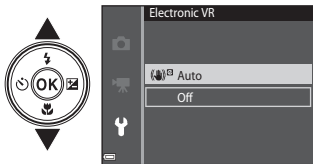



## 8 Press the OK button.

- The setting you selected is applied.
- When you are finished using the menu, press the **MENU** button.



### Setting Menu Options

- Certain menu options cannot be set depending on the current shooting mode or the state of the camera. Unavailable options are displayed in gray and cannot be selected.
- When a menu is displayed, you can switch to shooting mode by pressing the shutter-release button,  (shooting mode) button, or  (movie-record) button.









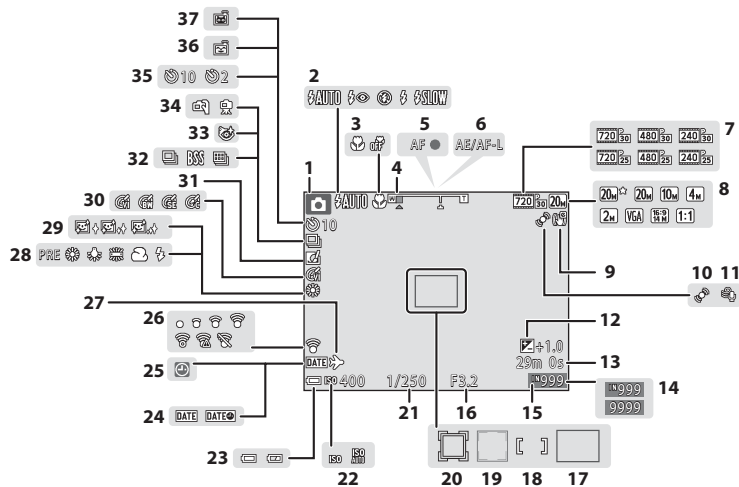













# The Monitor

The information that is displayed in the monitor during shooting and playback changes depending on the camera's settings and state of use.

By default, information is displayed when the camera is turned on and when you operate the camera, and turns off after a few seconds (when **Photo info** is set to **Auto info** in **Monitor settings** (📖73)).

## Shooting Mode







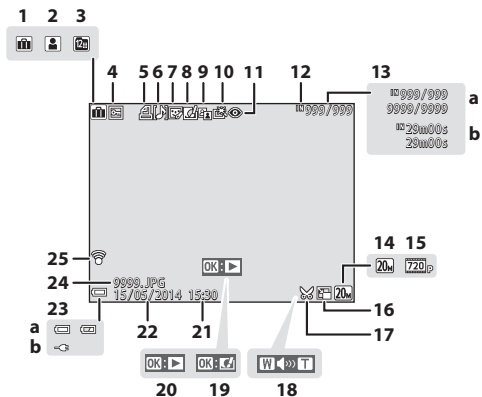











<b>1</b>	Shooting mode .....	22, 33, 38, 40, 42
<b>2</b>	Flash mode.....	45
<b>3</b>	Macro mode .....	49
<b>4</b>	Zoom indicator .....	25, 49
<b>5</b>	Focus indicator .....	26
<b>6</b>	AE/AF-L indicator.....	 4
<b>7</b>	Movie options.....	70,  56
<b>8</b>	Image mode.....	54,  28
<b>9</b>	Electronic VR icon.....	73,  64
<b>10</b>	Motion detection icon.....	73,  65
<b>11</b>	Wind noise reduction .....	70,  57
<b>12</b>	Exposure compensation value .....	50
<b>13</b>	Movie length.....	67
<b>14</b>	Number of exposures remaining (still images) .....	20,  29
<b>15</b>	Internal memory indicator.....	20
<b>16</b>	Aperture value.....	27
<b>17</b>	Focus area (target finding AF) ....	60,  39
<b>18</b>	Focus area (for manual or center) .....	 38
<b>19</b>	Focus area (face detection, pet detection) .....	37, 40, 58,  37
<b>20</b>	Focus area (subject tracking).....	 38
<b>21</b>	Shutter speed.....	27
<b>22</b>	ISO sensitivity .....	54,  35
<b>23</b>	Battery level indicator .....	20
<b>24</b>	Print date.....	73,  63
<b>25</b>	"Date not set" indicator .....	16
<b>26</b>	Eye-Fi communication indicator .....	74,  72
<b>27</b>	Travel destination .....	 59
<b>28</b>	White balance mode.....	54,  30
<b>29</b>	Skin softening .....	55,  42
<b>30</b>	Color options.....	54,  36
<b>31</b>	Quick effects icon .....	43, 54,  41
<b>32</b>	Continuous shooting mode .....	54,  33
<b>33</b>	Blink proof .....	55,  44
<b>34</b>	Hand-held/tripod .....	34
<b>35</b>	Self-timer indicator .....	47
<b>36</b>	Smile timer.....	55,  43
<b>37</b>	Pet portrait auto release .....	37, 47

# Playback Mode



Parts of the Camera

<b>1</b>	Album icon in favorite pictures mode.....		5
<b>2</b>	Category icon in auto sort mode.....		9
<b>3</b>	List by date icon .....		10
<b>4</b>	Protect icon.....		65, 50
<b>5</b>	Print order icon.....		65, 45
<b>6</b>	Voice memo icon .....		65, 53
<b>7</b>	Glamour retouch icon .....		65, 15
<b>8</b>	Quick effects icon.....		29, 12
<b>9</b>	D-Lighting icon.....		65, 13
<b>10</b>	Quick retouch icon.....		65, 13
<b>11</b>	Red-eye correction icon.....		65, 14
<b>12</b>	Internal memory indicator		
<b>13</b>	<b>a</b> Current frame number/ total number of frames		
	<b>b</b> Movie length		

<b>14</b>	Image mode .....		54, 28
<b>15</b>	Movie options.....		70, 56
<b>16</b>	Small picture icon.....		65, 17
<b>17</b>	Crop icon .....		63, 18
<b>18</b>	Volume indicator .....		71
<b>19</b>	Quick effects guide		
<b>20</b>	Movie playback guide		
<b>21</b>	Time of recording		
<b>22</b>	Date of recording		
	<b>a</b> Battery level indicator.....		20
<b>23</b>	<b>b</b> Charging AC Adapter connection indicator		
<b>24</b>	File number and type.....		78
<b>25</b>	Eye-Fi communication indicator .....		74, 72

# The Basics of Shooting and Playback

## Preparation 1 Insert the Battery

- 1 Open the battery-chamber/memory card slot cover.

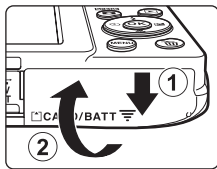

- 2 Insert the battery.

- Push the orange battery latch in the direction indicated by the arrow (①), and fully insert the battery (②).
- The battery locks into place when inserted correctly.

Battery latch

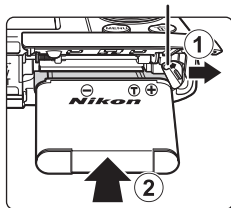

### **✓ Be Careful to Insert the Battery in Correct Direction**

***Inserting the battery upside down or backwards could damage the camera.***



- 3** Close the battery-chamber/memory card slot cover.

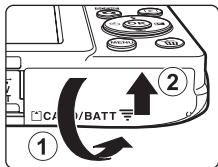

### Removing the Battery

Turn the camera off and make sure that the power-on lamp and monitor have turned off, and then open the battery-chamber/memory card slot cover.

Move the battery latch in the direction indicated by the arrow (①) to eject the battery (②).

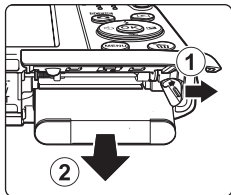

### **✓** High Temperature Caution

The camera, battery, and memory card may be hot immediately after using the camera.

## Preparation 2 Charge the Battery

### 1 Prepare the included Charging AC Adapter.

- If a plug adapter\* is included with your camera, attach the plug adapter to the plug on the Charging AC Adapter. Push the plug adapter firmly until it is securely held in place. Once the two are connected, attempting to forcibly remove the plug adapter could damage the product.
- \* The shape of the plug adapter varies according to the country or region in which the camera was purchased. This step can be omitted if the plug adapter comes permanently bonded to the Charging AC Adapter.

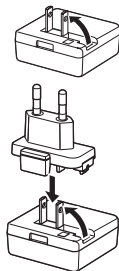

### 2 Make sure the battery is installed in the camera, and then connect the camera to the Charging AC Adapter in order of ① to ③.

- Keep the camera turned off.
- Make sure that the plugs are properly oriented. Do not insert or remove the plugs at an angle when connecting or disconnecting them.

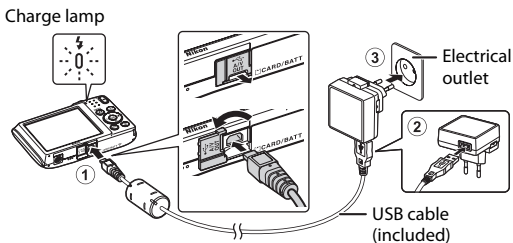



- The charge lamp slowly flashes green to indicate that the battery is charging.
- Shooting is not possible while the camera is connected to the Charging AC Adapter.

Charge lamp	Description
Flashes slowly (green)	The battery is charging.
Off	When charging is complete, the charge lamp stops flashing green and turns off. About 3 hours are required to charge a fully exhausted battery.
Flashes quickly (green)	<ul style="list-style-type: none"><li>The ambient temperature is not suited to charging. Charge the battery indoors with an ambient temperature of 5°C to 35°C (41°F to 95°F).</li><li>The USB cable or Charging AC Adapter is not properly connected, or there is a problem with the battery. Disconnect the USB cable or unplug the Charging AC Adapter and correctly connect it again, or change the battery.</li></ul>

### 3 Disconnect the Charging AC Adapter from the electrical outlet and then disconnect the USB cable.

#### Charging Using a Computer or Battery Charger

- You can also charge the battery by connecting the camera to a computer (74, 70).
- You can use the Battery Charger MH-66 (available separately; 79) to charge the battery without using the camera.

## Preparation 3 Insert a Memory Card

- 1 Turn off the camera and open the battery-chamber/memory card slot cover.

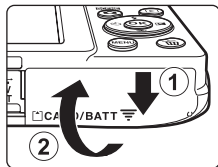

- 2 Insert the memory card.

- Slide the memory card in until it clicks into place.

Memory card slot

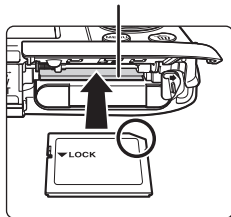

- ✓ Be Careful to Insert the Memory Card in Correct Direction**

*Inserting the memory card upside down or backwards could damage the camera and memory card.*



- 3 Close the battery-chamber/memory card slot cover.

## ✓ Formatting a Memory Card

The first time you insert a memory card that has been used in another device into this camera, make sure to format it with this camera. Insert the memory card into the camera, press the **MENU** button, and select **Format card** in the setup menu.

## Removing the Memory Card

Turn the camera off and make sure that the power-on lamp and monitor have turned off, and then open the battery-chamber/memory card slot cover.

Gently push the memory card into the camera (①) to partially eject the card (②).

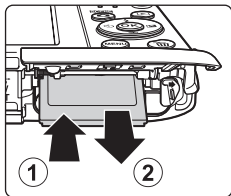

## ✓ High Temperature Caution

The camera, battery, and memory card may be hot immediately after using the camera.

## Internal Memory and Memory Cards

Camera data, including images and movies, can be saved either in the camera's internal memory or on a memory card. To use the camera's internal memory, first remove the memory card.

## Preparation 4 Setting the Display Language, Date, and Time

When the camera is turned on for the first time, the language-selection screen and the date and time setting screen for the camera clock are displayed.

- If you exit without setting the date and time,  will flash when the shooting screen is displayed.

- 1 Press the power switch to turn on the camera.

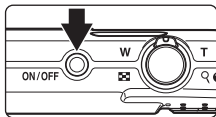

- 2 Use the multi selector ▲▼ to select the desired language and press the  button.

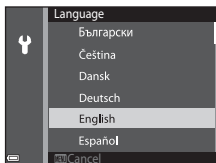

- 3 Select **Yes** and press the  button.

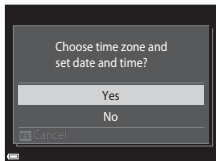

#### 4 Select your home time zone and press the **OK** button.

- To enable daylight saving time, press ▲. When the daylight saving time function is enabled, ☀ is displayed above the map. To disable the daylight saving time function, press ▼.

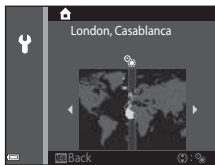

#### 5 Select the date format and press the **OK** button.

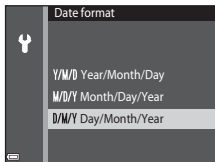

#### 6 Set the date and time, and press the **OK** button.

- Select a field: Press ◀▶ (changes between **D**, **M**, **Y**, hour, and minute).
- Edit the date and time: Press ▲▼.
- Confirm the settings: Select the minute field and press the **OK** button.

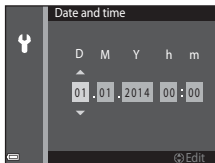

#### 7 Select **Yes** and press the **OK** button.

- When settings are finished, the lens extends and the camera switches to shooting mode.

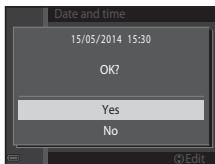

## Changing the Language or the Date and Time Setting

- You can change these settings using the **Language** and **Time zone and date** settings in the **Y** setup menu (📖73).
- You can enable or disable daylight saving time in the **Y** setup menu by selecting **Time zone and date** followed by **Time zone**. Press the multi selector **▶** and then **▲** to enable daylight saving time and move the clock forward one hour, or **▼** to disable daylight saving time and move the clock back one hour.

## The Clock Battery

- The camera's clock is powered by a built-in backup battery.  
The backup battery charges when the main battery is inserted into the camera or when the camera is connected to an optional AC adapter, and it can run the clock for several days after about ten hours of charging.
- If the camera's backup battery becomes exhausted, the date and time setting screen is displayed when the camera is turned on. Set the date and time again. See step 3 (📖16) of "Preparation 4 Setting the Display Language, Date, and Time" for more information.

## Imprinting the Shooting Date on Printed Images

- You can permanently imprint the shooting date on images as they are captured by setting **Print date** in the setup menu (📖73).
- You can use the ViewNX 2 software (📖77) to print the shooting date on images that were captured without using the **Print date** option.



A series of ten horizontal dashed lines spanning the width of the page, intended for handwriting practice.

# Step 1 Turn the Camera On

## 1 Press the power switch.

- The monitor turns on.
- To turn the camera off, press the power switch again.

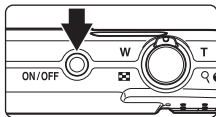

## 2 Check the battery level indicator and the number of exposures remaining.

### Battery Level Indicator

Display	Description
	The battery level is high.
	The battery level is low.
 Battery exhausted.	The camera cannot capture images. Recharge the battery.

### Number of exposures remaining

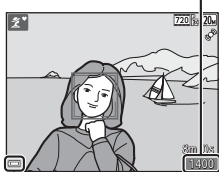

Battery level indicator



### Number of Exposures Remaining

The number of images that can be taken is displayed.

- is displayed when no memory card is inserted in the camera, and images are saved in the internal memory.

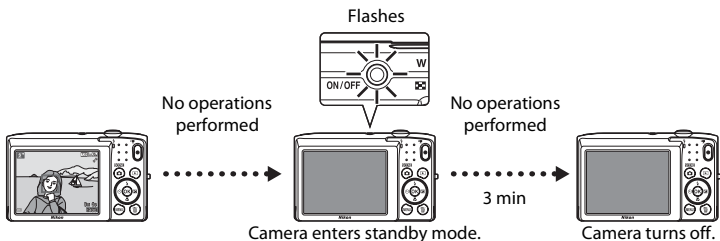
## The Auto Off Function





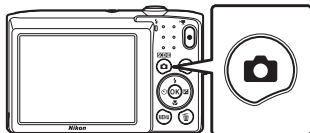

- The time that elapses before the camera enters standby mode is about one minute. The time can be changed using the **Auto off** setting in the setup menu (p.73).
- While the camera is in standby mode, the monitor turns back on if you perform any of the following operations:
  - Press the power switch, shutter-release button,  (shooting mode) button,  (playback) button, or  (movie-record) button.

## Step 2 Select a Shooting Mode

- 1 Press the  button.







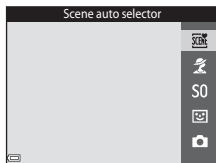



- 2 Use the multi selector   to select a shooting mode and press the  button.

-  (scene auto selector) mode is used in this example.
- The shooting mode setting is saved even after the camera is turned off.



## Available Shooting Modes

	<b>Scene auto selector</b>  32
	The camera automatically selects the optimum scene mode when you frame an image, making it even easier to take images using settings that suit the scene.
	<b>Scene</b>  33
	Camera settings are optimized according to the scene that you select.
<b>S0</b>	<b>Special effects</b>  38
	Effects can be applied to images during shooting.
	<b>Smart portrait</b>  40
	When the camera detects a smiling face, you can take an image automatically without pressing the shutter-release button (smile timer). You can also use the skin softening option to smooth the skin tones of human faces.
	<b>Auto mode</b>  42
	Used for general shooting. Settings can be adjusted to suit the shooting conditions and the type of shot you want to capture.

## Step 3 Frame a Picture

### 1 Hold the camera steady.

- Keep fingers and other objects away from the lens, flash, AF assist-illuminator, microphone, and speaker.
- When taking pictures in portrait (“tall”) orientation, turn the camera so that the flash is above the lens.

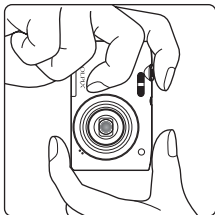
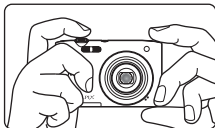



### 2 Frame the picture.

- When the camera automatically determines the scene mode, the shooting mode icon changes (see 32).

Shooting mode icon





## ✓ Notes About (Scene Auto Selector) Mode

- Depending upon shooting conditions, the camera may not select the desired scene mode. In this case, select another shooting mode (32, 38, 40, 42).
- When the digital zoom is in effect, the scene mode changes to .

## When Using a Tripod

We recommend using a tripod to stabilize the camera in the following situations:

- When shooting in dim lighting
- When shooting with the flash mode (46) set to  (off)
- When using the telephoto setting

## Using the Zoom

When you move the zoom control, the zoom lens position changes.



- To zoom in closer to the subject: Move toward **T** (telephoto).
- To zoom out and view a larger area: Move toward **W** (wide-angle).

When you turn the camera on, the zoom moves to the maximum wide-angle position.

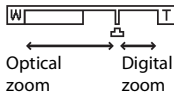
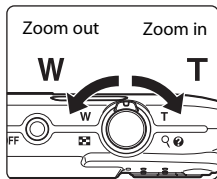
- A zoom indicator is displayed at the top of the monitor when the zoom control is moved.
- Digital zoom, which allows you to further magnify the subject up to approximately 4x the maximum optical zoom ratio, can be activated by moving and holding the zoom control toward **T** when the camera is zoomed in to the maximum optical zoom position.



## Digital Zoom and Interpolation

While using digital zoom, the image quality decreases due to interpolation when the zoom is increased beyond the  position. The position of  moves to the right as the size of an image decreases.



## Step 4 Focus and Shoot

### 1 Press the shutter-release button halfway.

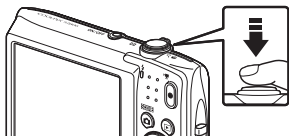

- When the subject is in focus, the focus area glows green (multiple focus areas can glow green).
- When you are using digital zoom, the camera focuses in the center of the frame and the focus area is not displayed. When the camera has focused, the focus indicator (ⓘ) glows green.
- If the focus area or focus indicator flashes, the camera is unable to focus. Modify the composition and try pressing the shutter-release button halfway again.



### 2 Without lifting your finger, press the shutter-release button the rest of the way down.



## The Shutter-release Button

<p>Press halfway</p>		<p>To set focus and exposure (shutter speed and aperture value), press the shutter-release button lightly until you feel a slight resistance. Focus and exposure remain locked while the shutter-release button is pressed halfway.</p>
<p>Press all the way</p>		<p>Press the shutter-release button all the way to release the shutter and take an image. Do not use force when pressing the shutter-release button, as this may result in camera shake and blurred images. Press the button gently.</p>

### Notes About Saving Images and Recording Movies

The indicator showing the number of exposures remaining or the indicator showing the maximum movie length flashes while images are being saved or while a movie is being recorded. **Do not open the battery-chamber/memory card slot cover or remove the battery or memory card** while an indicator is flashing. Doing this could result in loss of data, or in damage to the camera or the memory card.

## Step 5 Play Back Images

### 1 Press the (playback) button.

- If you press and hold down the  (playback) button while the camera is turned off, the camera turns on in playback mode.

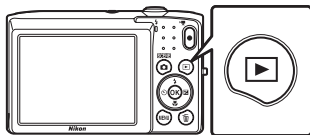

### 2 Use the multi selector to select an image to display.

- Press and hold down  to scroll through the images quickly.

Display the  
previous image





Display the next  
image

- To return to shooting mode, press the  button or  
shutter-release button.



## The Quick Effects Function



- When **OK**:  is displayed in full-frame playback mode, you can press the **OK** button to apply an effect to the image.
- When the effect selection screen is displayed, use the multi selector  to select an effect, press the **OK** button, and then select **Yes** in the confirmation dialog and press the **OK** button to save the image as a separate file.  
See "Quick Effects: Changing Hue or Mood" ( 12) for more information.

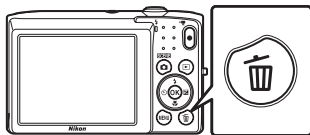

## Step 6 Delete Images

- 1 Press the  button to delete the image currently displayed in the monitor.



- 2 Use the multi selector   to select the desired deletion method and press the  button.

- To exit without deleting, press the **MENU** button.

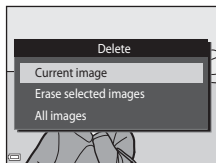

- 3 Select **Yes** and press the  button.

- Deleted images cannot be recovered.
- To cancel, select **No** and press the  button.

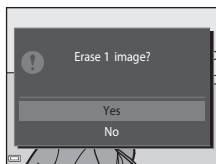

## Operating the Erase Selected Images Screen

**1** Use the multi selector ◀▶ to select an image to be deleted, and then use ▲ to display 🗑️.

- To undo the selection, press ▼ to remove 🗑️.
- Move the zoom control (📐1) toward **T** (🔍) to switch to full-frame playback or **W** (🖼️) to switch to thumbnail playback.



**2** Add 🗑️ to all images that you want to delete and then press the **OK** button to confirm the selection.

- A confirmation dialog is displayed. Follow the on-screen instructions to complete operations.



### **Deleting the Last Image Captured while in Shooting Mode**

When using shooting mode, press the 🗑️ button to delete the last image that was saved.











# Shooting Features

## (Scene Auto Selector) Mode



The camera automatically selects the optimum scene mode when you frame an image, making it even easier to take images using settings that suit the scene.

Enter shooting mode →  (shooting mode) button →  (scene auto selector) →  button

When the camera selects a scene mode, the shooting mode icon displayed in the shooting screen changes to that for the scene mode currently enabled.







	Portrait (for taking close-up portraits of one or two people)
	Portrait (for taking portraits of three or more people, or images in which a large background takes up the frame)
	Landscape
	Night portrait (for taking close-up portraits of one or two people)
	Night portrait (for taking portraits of three or more people, or images in which a large background takes up the frame)
	Night landscape
	Close-up
	Backlighting (for taking images of subjects other than people)
	Backlighting (for taking portrait images)
	Other scenes

## Functions Available in (Scene Auto Selector) Mode





























- Flash mode (45)
- Self-timer (47)
- Exposure compensation (50)

## Scene Mode (Shooting Suited to Scenes)

When a scene is selected, camera settings are automatically optimized for the selected scene.

Enter shooting mode →  (shooting mode) button →  (second icon from the top\*)  
→     → select a scene →  button

\* The icon for the last scene selected is displayed.



 Portrait (default setting)	 Landscape <sup>1</sup>	 Sports <sup>2</sup> (  34)	 Night portrait <sup>3</sup>
 Party/indoor <sup>2</sup> (  34)	 Beach <sup>2</sup>	 Snow <sup>2</sup>	 Sunset <sup>2,3</sup>
 Dusk/dawn <sup>1,3</sup>	 Night landscape <sup>1,3</sup> (  34)	 Close-up (  35)	 Food (  35)
 Museum <sup>2</sup> (  35)	 Fireworks show <sup>1,3</sup> (  35)	 Black and white copy <sup>2</sup> (  35)	 Backlighting <sup>2</sup> (  36)
 Panorama assist (  36)	 Pet portrait (  37)		

<sup>1</sup> The camera focuses at infinity.

<sup>2</sup> The camera focuses on the area in the center of the frame.

<sup>3</sup> Use of a tripod is recommended, because the shutter speed is slow.

## Displaying a Description of Each Scene Mode (Help Display)

Select a scene and move the zoom control (1) toward **T** () to view a description of that scene. To return to the original screen, move the zoom control toward **T** () again.



# Tips and Notes





## Sports

- While the shutter-release button is held all the way down, the camera shoots up to about 6 images continuously at a rate of about 1.1 fps (when image mode is set to **20M**).
- The frame rate for continuous shooting may vary depending on the current image mode setting, the memory card used, or shooting conditions.
- Focus, exposure, and hue are fixed at the values determined with the first image in each series.

## Party/indoor

- To avoid the effects of camera shake, hold the camera steady. In dark surroundings, the use of a tripod is recommended.

## Night landscape

- From the screen displayed after  **Night landscape** is selected, select  **Hand-held** or  **Tripod**.
-  **Hand-held** (default setting): Select this option to produce shots with reduced blurring and noise even when the camera is hand-held.
-  **Tripod**: Select this option when using a tripod or other means to stabilize the camera when shooting.

## Close-up

- Macro mode (📖49) is enabled and the camera automatically zooms to the closest position at which it can focus.
- You can move the focus area. Press the **OK** button, use the multi selector **▲▼◀▶** to move the focus area, and press the **OK** button to apply the setting.

## Food

- Macro mode (📖49) is enabled and the camera automatically zooms to the closest position at which it can focus.
- You can adjust hue by using the multi selector **▲▼**. The hue setting is saved in the camera's memory even after the camera is turned off.
- You can move the focus area. Press the **OK** button, use the multi selector **▲▼◀▶** to move the focus area, and press the **OK** button to apply the setting.

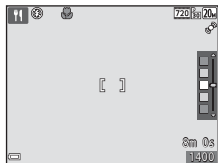

## Museum

- The camera captures a series of up to ten images while the shutter-release button is held all the way down, and the sharpest image in the series is automatically selected and saved (BSS (Best Shot Selector)).
- The flash does not fire.

## Fireworks show

- The shutter speed is fixed at four seconds.





## Black and white copy

- Use with macro mode (📖49) when shooting a subject at close distance.





## Backlighting

- The flash always fires.



## Panorama assist

- You can use this mode when shooting a series of images that can later be joined on a computer to form a single panorama.
- Select the direction in which to add images to the panorama by using the multi selector  and then press the  button.
- After taking the first image, take the additional shots needed while checking how each image will connect to the next. To finish shooting, press the  button.
- Transfer the images to a computer and use Panorama Maker (79) to join them into a single panorama.  
See "Using Panorama Assist" (2) for more information.

## Pet portrait

- When you point the camera at a dog or cat, the camera detects the pet's face and focuses on it. By default, the camera detects a dog or cat face and automatically releases the shutter (pet portrait auto release).
- On the screen displayed when  **Pet portrait** is selected, select  **Single** or  **Continuous**.
  -  **Single**: The camera captures one image when a dog or cat face is detected.
  -  **Continuous**: The camera captures three images continuously when a dog or cat face is detected.

## **Pet Portrait Auto Release**

- Press the multi selector  (C) to change the **Pet portrait auto release** setting.
  - : The camera detects a dog or cat face and automatically releases the shutter.
  - **OFF**: The camera does not release the shutter automatically, even if a dog or cat face is detected. Press the shutter-release button. The camera also detects human faces when **OFF** is selected.
- **Pet portrait auto release** is set to **OFF** after five bursts have been taken.
- Shooting is also possible by pressing the shutter-release button, regardless of the **Pet portrait auto release** setting. When  **Continuous** is selected, you can take images continuously while holding down the shutter-release button all the way.

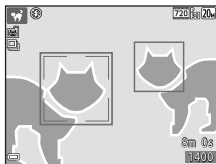

## **Focus Area**

- When the camera detects a face, the face is displayed inside a yellow border. When the camera acquires focus on a face displayed inside a double border (focus area), the double border turns green. If no faces are detected, the camera focuses on the subject in the center of the frame.
- Under some shooting conditions, the pet face may not be detected and other subjects may be displayed inside a border.











## Special Effects Mode (Applying Effects When Shooting)

Effects can be applied to images during shooting.

Enter shooting mode →  (shooting mode) button → **S0** (third icon from the top\*) → **▶▶▶▲▼▶▶▶** → select an effect →  button





\* The icon of the last effect selected is displayed.

Category	Description
<b>S0</b> Soft (default setting)	Softens the image by adding a slight blur to the entire image.
<b>SE</b> Nostalgic sepia	Adds a sepia tone and reduces the contrast to simulate the qualities of an old photograph.
 High-contrast monochrome	Changes the image to black and white and gives it sharp contrast.
 High key	Gives the entire image a bright tone.
 Low key	Gives the entire image a dark tone.
 Selective color	Creates a black and white image in which only the specified color remains.
<b>POP</b> Pop	Increases the color saturation of the entire image to create a bright look.
<b>VI</b> Super vivid	Increases the color saturation of the entire image and sharpens the contrast.
 Painting	Gives the image a painting-like appearance.

Category	Description
 Toy camera effect 1	Gives the entire image a yellowish hue and darkens the image periphery.
 Toy camera effect 2	Decreases the color saturation of the entire image and darkens the image periphery.
 Cross process	Gives the image a mysterious appearance based on a specific color.

- The camera focuses on the area in the center of the frame.
- When **Selective color** or **Cross process** is selected, use the multi selector ▲▼ to select the desired color from the slider.

To change settings for any of the following functions, press the  button to cancel color selection.

- Flash mode ( 45)
- Self-timer ( 47)
- Macro mode ( 49)
- Exposure compensation ( 50)

To return to the color selection screen, press the  button again.

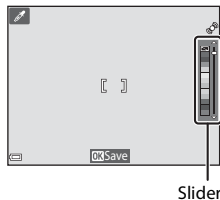

# Smart Portrait Mode (Capturing Images of Smiling Faces)

When the camera detects a smiling face, you can take an image automatically without pressing the shutter-release button (smile timer (📖55)). You can use the skin softening option to smooth the skin tones of human faces.

Enter shooting mode → 📷 (shooting mode) button → 😊 Smart portrait → Ⓞ button

## 1 Frame the picture.

- Point the camera at a human face.

## 2 Without pressing the shutter-release button, wait for the subject to smile.

- If the camera detects that the face framed by the double border is smiling, the shutter is automatically released.
- Whenever the camera detects a smiling face, it automatically releases the shutter.

## 3 End automatic shooting.

- Perform one of the operations listed below to end shooting.
  - Set **Smile timer** to **Off**.
  - Press the 📷 button and select a different shooting mode.





### ✔ Notes About Smart Portrait Mode

Under some shooting conditions, the camera may be unable to detect faces or smiles (📖58). The shutter-release button can also be used for shooting.

## **When the Self-timer Lamp Flashes**

When using smile timer, the self-timer lamp flashes when the camera detects a face and flashes quickly immediately after the shutter is released.



## **Functions Available in Smart Portrait Mode**

- Flash mode (45)
- Self-timer (47)
- Exposure compensation (50)
- Smart portrait menu (53)





## (Auto) Mode

Used for general shooting. Settings can be adjusted to suit the shooting conditions and the type of shot you want to capture.

Enter shooting mode →  (shooting mode) button →  (auto) mode →  button

- You can change how the camera selects the area of the frame to focus on by changing **AF area mode** setting (45). The default setting is **Target finding AF** (60).

### Functions Available in (Auto) Mode

- Flash mode (45)
- Self-timer (47)
- Macro mode (49)
- Exposure compensation (50)
- Shooting menu (54)

## Using Quick Effects

When in  (auto) mode, you can apply effects to images immediately after releasing the shutter.



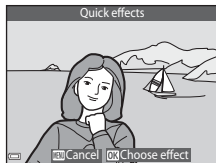

- The edited image is saved as a separate file with a different name.

### 1 Press the button when the image is displayed after it is taken in (auto) mode.

- When you press the **MENU** button or when no operations are performed for about five seconds, the monitor display returns to the shooting screen.
- To not display the screen shown on the right, set **Quick effects** to **Off** in the shooting menu ( 54).



### 2 Use the multi selector to select the desired effect and press the button.

- Move the zoom control ( 1) toward **T** () to switch to full-frame playback or **W** () to switch to thumbnail playback.
- To exit without saving the edited image, press the **MENU** button. When a confirmation dialog is displayed, select **Yes** and press the  button.
- See "Quick Effects: Changing Hue or Mood" ( 12) for information about the effect types.

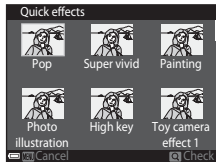





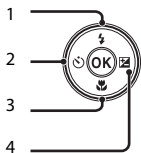

### 3 Select **Yes** and press the button.

## Functions That Can Be Set Using the Multi Selector

The functions that are available vary depending on the shooting mode, as shown below.



		 (scene auto selector)	Scene	Special effects	Smart portrait	 (auto) mode
1	 Flash mode (📖45)	✓	*	✓	✓*	✓
2	 Self-timer (📖47)	✓		✓	✓*	✓
3	 Macro mode (📖49)	—		✓	—	✓
4	 Exposure compensation (📖50)	✓		✓	✓	✓

\* Availability depends on the setting.

# Using the Flash

You can select a flash mode to match the shooting conditions.

- 1 Press the multi selector ▲ (⚡).



- 2 Select the desired flash mode (📖46) and press the (OK) button.

- If a setting is not applied by pressing the (OK) button within a few seconds, the selection will be canceled.

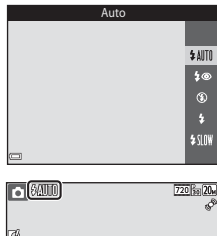

## ✓ The Flash Lamp

- The status of the flash can be confirmed by pressing the shutter-release button halfway.
  - On: The flash fires when you press the shutter-release button all the way down.
  - Flashing: The flash is charging. The camera cannot shoot images.
  - Off: The flash does not fire when an image is taken.
- If the battery level is low, the monitor turns off while the flash is charging.

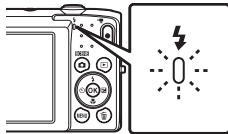

## Available Flash Modes



### Auto

The flash fires when necessary, such as in dim lighting.

- The flash mode icon on the shooting screen is displayed only immediately after the setting is made.



### Auto with red-eye reduction

Reduce “red-eye” in portraits caused by the flash.



### Off

The flash does not fire.

- We recommend using a tripod to stabilize the camera when shooting in dark surroundings.



### Fill flash

The flash fires whenever an image is taken. Use to “fill-in” (illuminate) shadows and backlit subjects.



### Slow sync

Suited to evening and night portraits that include background scenery. The flash fires when necessary to illuminate the main subject; slow shutter speeds are used to capture background at night or under dim lighting.



## The Flash Mode Setting

- The setting may not be available with some shooting modes.
- The setting applied in  (auto) mode is saved in the camera’s memory even after the camera is turned off.



## Red-eye Reduction

If the camera detects red eye while saving an image, the affected area is processed to reduce red-eye before the image is saved.

Note the following when shooting:

- More time than usual is required to save images.
- Red-eye reduction may not produce the desired results in some situations.
- In some rare cases, red-eye reduction may be applied unnecessarily to other areas of the image. In these cases, select another flash mode and take the image again.

## Using the Self-timer

The camera is equipped with a self-timer that releases the shutter about ten seconds or two seconds after you press the shutter-release button.

- 1 Press the multi selector ◀ (⌚).



- 2 Select ⌚10s or ⌚2s, and press the OK button.

- ⌚10s (ten seconds): Use on important occasions, such as weddings.
- ⌚2s (two seconds): Use to prevent camera shake.
- If a setting is not applied by pressing the OK button within a few seconds, the selection will be canceled.
- When the shooting mode is **Pet portrait** scene mode,  (pet portrait auto release) is displayed (📖37). The self-timer cannot be used.

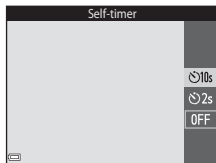

- 3 Frame the picture and press the shutter-release button halfway.

- Focus and exposure are set.



## 4 Press the shutter-release button the rest of the way down.

- Countdown starts. The self-timer lamp flashes and then glows steadily about one second before the shutter is released.
- When the shutter is released, the self-timer is set to **OFF**.
- To stop the countdown, press the shutter-release button again.

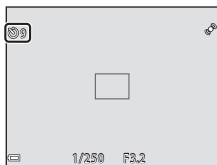

# Using Macro Mode

Use macro mode when taking close-up images.

- 1 Press the multi selector ▼ (👉).



- 2 Select **ON** and press the **OK** button.

- If the setting is not applied by pressing the **OK** button within a few seconds, the selection will be canceled.



- 3 Move the zoom control to set the zoom ratio to a position where 🌿 and the zoom indicator glow green.



- When the zoom ratio is set to a position where the zoom indicator glows green, the camera can focus on subjects as close as approximately 30 cm (1 ft) from the lens. When the zoom is at the position where 🏔️ is displayed, the camera can focus on subjects as close as approximately 10 cm (4 in.) from the lens.

## ✓ Notes About Using the Flash

The flash may be unable to light the entire subject at distances of less than 50 cm (1 ft 8 in.).

## 📌 The Macro Mode Setting

- The setting may not be available with some shooting modes.
- The setting applied in 📷 (auto) mode is saved in the camera's memory even after the camera is turned off.

# Adjusting Brightness (Exposure Compensation)

You can adjust overall image brightness.

**1** Press the multi selector ► (⊕/⊖).



**2** Select a compensation value and press the **OK** button.

- To brighten the image, set a positive (+) value.
- To darken the image, set a negative (-) value.
- The compensation value is applied, even without pressing the **OK** button.



















































## **Exposure Compensation Value**

The setting applied in  (auto) mode is saved in the camera's memory even after the camera is turned off.

## Default Settings

Default settings for each shooting mode are described below.

	Flash mode (  45)	Self-timer (  47)	Macro mode (  49)	Exposure compensation (  50)
 (scene auto selector)	 AUTO <sup>1</sup>	Off	Off <sup>2</sup>	0.0
Scene				
 (portrait)	 	Off	Off <sup>2</sup>	0.0
 (landscape)	  <sup>2</sup>	Off	Off <sup>2</sup>	0.0
 (sports)	  <sup>2</sup>	Off <sup>2</sup>	Off <sup>2</sup>	0.0
 (night portrait)	  <sup>3</sup>	Off	Off <sup>2</sup>	0.0
 (party/indoor)	  <sup>4</sup>	Off	Off <sup>2</sup>	0.0
 (beach)	 AUTO	Off	Off <sup>2</sup>	0.0
 (snow)	 AUTO	Off	Off <sup>2</sup>	0.0
 (sunset)	  <sup>2</sup>	Off	Off <sup>2</sup>	0.0
 (dusk/dawn)	  <sup>2</sup>	Off	Off <sup>2</sup>	0.0
 (night landscape)	  <sup>2</sup>	Off	Off <sup>2</sup>	0.0
 (close-up)	 	Off	On <sup>2</sup>	0.0
 (food)	  <sup>2</sup>	Off	On <sup>2</sup>	0.0
 (museum)	  <sup>2</sup>	Off	Off	0.0
 (fireworks show)	  <sup>2</sup>	Off <sup>2</sup>	Off <sup>2</sup>	0.0 <sup>2</sup>
 (black and white copy)	 	Off	Off	0.0

	Flash mode (45)	Self-timer (47)	Macro mode (49)	Exposure compensation (50)
(backlighting)	<sup>2</sup>	Off	Off <sup>2</sup>	0.0
(panorama assist)	<sup>3</sup>	Off	Off	0.0
(pet portrait)	<sup>2</sup>	<sup>5</sup>	Off	0.0
<b>SO</b> (special effects)	<sup>3</sup>	Off	Off	0.0
(smart portrait)	<b>AUTO</b>	Off	Off <sup>2</sup>	0.0
(auto)	<b>AUTO</b>	Off	Off	0.0

<sup>1</sup> **AUTO** (auto flash) or (off) can be selected. When **AUTO** (auto flash) is selected, the camera automatically selects the flash mode appropriate for the scene it has been selected.

<sup>2</sup> The setting cannot be changed.

<sup>3</sup> The setting cannot be changed. The flash mode setting is fixed at the fill flash with slow sync and red-eye reduction.

<sup>4</sup> Slow sync with red-eye reduction flash mode may be used.

<sup>5</sup> Self-timer cannot be used. Pet portrait auto release can be turned on or off (37).

## Functions That Can Be Set with the MENU Button (Shooting Menu)

The settings listed below can be changed by pressing the **MENU** button during shooting (📖4).

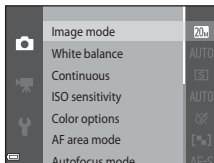
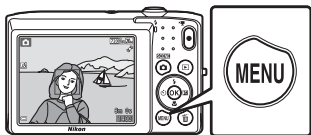













The settings that can be changed vary depending on the shooting mode, as shown below.





	Scene auto selector	Scene <sup>2</sup>	Special effects	Smart portrait	Auto mode
Image mode <sup>1</sup>	✓	✓	✓	✓	✓
White balance	-	-	-	-	✓
Continuous	-	-	-	-	✓
ISO sensitivity	-	-	-	-	✓
Color options	-	-	-	-	✓
AF area mode	-	-	-	-	✓
Autofocus mode	-	-	-	-	✓
Quick effects	-	-	-	-	✓
Skin softening	-	-	-	✓	-
Smile timer	-	-	-	✓	-
Blink proof	-	-	-	✓	-

<sup>1</sup> The setting is also applied to other shooting modes.

<sup>2</sup> Additional settings are available for some scene modes. See "Tips and Notes" (📖34) for more information.

## Options Available in the Shooting Menu

Option	Description	
Image mode	Allows you to set the combination of image size and image quality used when saving images. <ul style="list-style-type: none"><li>• Default setting:  <b>5152x3864</b></li></ul>	 28
White balance	Allows you to adjust white balance to suit the weather conditions or light source in order to make the colors in images match what you see with your eyes. <ul style="list-style-type: none"><li>• Default setting: <b>Auto</b></li></ul>	 30
Continuous	Allows you to select single or continuous shooting. <ul style="list-style-type: none"><li>• Default setting: <b>Single</b></li></ul>	 33
ISO sensitivity	Allows you to control the camera's sensitivity to light. <ul style="list-style-type: none"><li>• Default setting: <b>Auto</b></li></ul> When <b>Auto</b> is selected,  <b>ISO</b> is displayed in the monitor while shooting if ISO sensitivity increases.	 35
Color options	Allows you to change the color tones of images. <ul style="list-style-type: none"><li>• Default setting: <b>Standard color</b></li></ul>	 36
AF area mode	Allows you to determine how the camera selects the focus area that is used for autofocus. <ul style="list-style-type: none"><li>• Default setting: <b>Target finding AF</b> (60)</li></ul>	 37
Autofocus mode	Allows you to select either <b>Single AF</b> , which focuses only when the shutter-release button is pressed halfway, or <b>Full-time AF</b> , which continues focusing even when the shutter-release button is not pressed halfway. <ul style="list-style-type: none"><li>• Default setting: <b>Single AF</b></li></ul>	 41
Quick effects	Allows you to enable or disable the quick effects function (  43). <ul style="list-style-type: none"><li>• Default setting: <b>On</b></li></ul>	 41

Option	Description	
Skin softening	Allows you to select the skin softening level for human faces. <ul style="list-style-type: none"> <li>• Default setting: <b>Normal</b></li> </ul>	 42
Smile timer	Allows you to select whether or not the camera automatically releases the shutter when it detects a human smiling face. <ul style="list-style-type: none"> <li>• Default setting: <b>On</b></li> </ul>	 43
Blink proof	The camera automatically releases the shutter twice with every shot and saves one image in which the subject's eyes are open. <ul style="list-style-type: none"> <li>• Default setting: <b>Off</b></li> </ul>	 44

## Functions That Cannot Be Used Simultaneously

Some functions cannot be used with other menu options.

Restricted function	Option	Description
Flash mode	Continuous (📖54)	When a setting other than <b>Single</b> is selected, the flash cannot be used.
	Blink proof (📖55)	When <b>Blink proof</b> is set to <b>On</b> , the flash cannot be used.
Self-timer	AF area mode (📖54)	When <b>Subject tracking</b> is selected, self-timer cannot be used.
	Smile timer (📖55)	When <b>Smile timer</b> is selected, the self-timer cannot be used.
Macro mode	AF area mode (📖54)	When <b>Subject tracking</b> is selected, macro mode cannot be used.
Image mode	Continuous (📖54)	When <b>Multi-shot 16</b> is selected, the <b>Image mode</b> setting is fixed at <b>5M</b> (image size: 2560 × 1920 pixels).
	ISO sensitivity (📖54)	When <b>3200</b> is selected, the image mode setting of only <b>4M 2272×1704</b> , <b>2M 1600×1200</b> , or <b>VGA 640×480</b> can be selected. If any image mode setting other than above is selected, the image mode setting is automatically changed to <b>4M 2272×1704</b> when <b>ISO sensitivity</b> is set to <b>3200</b> .
White balance	Color options (📖54)	When <b>Black-and-white</b> , <b>Sepia</b> , or <b>Cyanotype</b> is selected, the <b>White balance</b> setting is fixed at <b>Auto</b> .
ISO sensitivity	Continuous (📖54)	When <b>Multi-shot 16</b> is selected, the ISO sensitivity setting is fixed at <b>Auto</b> .
AF area mode	Digital zoom (📖74)	When digital zoom is in effect, the camera focuses in the center of the frame regardless of the <b>AF area mode</b> setting.

Restricted function	Option	Description
Quick effects	Continuous (📖54)	<b>Quick effects</b> cannot be applied to images immediately after they are taken with continuous shooting.
Monitor settings	Quick effects (📖54)	When <b>Quick effects</b> is set to <b>On</b> while shooting still images, the captured image is displayed after shooting, regardless of the <b>Image review</b> setting.
Electronic VR	ISO sensitivity (📖54)	When a setting other than <b>Auto</b> is selected, electronic vibration reduction is disabled.
	Continuous (📖54)	When a setting other than <b>Single</b> is selected, electronic vibration reduction is disabled.
Motion detection	Continuous (📖54)	When <b>Multi-shot 16</b> is selected, <b>Motion detection</b> is disabled.
	ISO sensitivity (📖54)	When a setting other than <b>Auto</b> is selected, <b>Motion detection</b> is disabled.
	AF area mode (📖54)	When <b>Subject tracking</b> is selected, <b>Motion detection</b> is disabled.
Digital zoom	Continuous (📖54)	When <b>Multi-shot 16</b> is selected, digital zoom cannot be used.
	AF area mode (📖54)	When <b>Subject tracking</b> is selected, digital zoom cannot be used.
Shutter sound	Continuous (📖54)	When a setting other than <b>Single</b> is selected, the shutter sound is disabled.
Blink warning	Continuous (📖54)	When a setting other than <b>Single</b> is selected, <b>Blink warning</b> is disabled.

### 📌 Notes About Digital Zoom

- Depending on the shooting mode or the current settings, digital zoom may not be available (📖66).
- When digital zoom is in effect, the camera focuses in the center of the frame.

# Focusing

The focus area varies depending on the shooting mode.

## Using Face Detection

When the camera is pointed at a human face in the shooting modes as shown below, the camera automatically detects the face and focuses on it.

- **Portrait**, **Night portrait**, or **Backlighting** in **SAF** (scene auto selector) mode (📖32)
- **Portrait** or **Night portrait** in scene mode (📖33)
- Smart portrait mode (📖40)
- When **AF area mode** (📖54) is set to **Face priority** in **CA** (auto) mode (📖42)

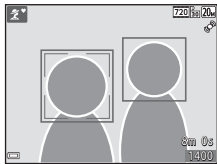

When the camera detects more than one face, the double border (focus area) is displayed around the face that is focused on, and single borders around the others.

If the shutter button is pressed halfway when no faces are detected:





- When **SAF** (scene auto selector) mode is selected, the focus area changes depending on the scene.
- In **Portrait** and **Night portrait** scene modes or in smart portrait mode, the camera focuses in the center of the frame.
- In **CA** (auto) mode, the camera selects the focus area containing the subject closest to the camera.

## ✓ Notes About Face Detection

- The camera's ability to detect faces depends on a variety of factors, including the direction in which the faces are looking.
- The camera may be unable to detect faces in the following situations:
  - When faces are partially hidden by sunglasses or otherwise obstructed
  - When faces take up too much or too little of the frame

## Using Skin Softening

When the shutter is released while using one of the shooting modes listed below, the camera detects human faces and processes the image to soften facial skin tones (up to three faces).

- Smart portrait mode (📖40)
  - The skin softening level can be adjusted.
-  **Portrait**,  **Night portrait**, or  **Backlighting** in  (scene auto selector) mode (📖32)
- **Portrait** or **Night portrait** in scene mode (📖33)

Editing functions such as **Skin softening** can be applied to saved images by using **Glamour retouch** (📖65) even after shooting.

### **Notes About Skin Softening**

- It may take more time than usual to save images after shooting.
- Under some shooting conditions, the desired skin softening results may not be achieved, and skin softening may be applied to areas of the image where there are no faces.

## Using Target Finding AF

When **AF area mode** (📖 54) in 📷 (auto) mode is set to **Target finding AF**, the camera focuses in the manner described below when you press the shutter-release button halfway.

- The camera detects the main subject and focuses on it. When the subject is in focus, the focus area glows green. If a human face is detected, the camera automatically sets focus priority on it.

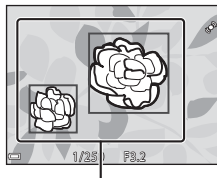

Focus areas

- If no main subject is detected, the camera automatically selects one or more of the nine focus areas containing the subject closest to the camera. When the subject is in focus, the focus areas that are in focus glow green.

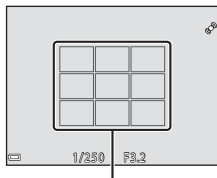

Focus areas

### ✔ Notes About Target Finding AF

- Depending on shooting conditions, the subject that the camera determines to be the main subject may vary.
- The main subject may not be detected when using certain **White balance** settings.
- The camera may not detect the main subject appropriately in the following situations:
  - When the subject is very dark or bright
  - When the main subject lacks clearly defined colors
  - When the shot is framed so that the main subject is at the edge of the monitor
  - When the main subject is composed of a repeating pattern

## Subjects Not Suitable for Autofocus

The camera may not focus as expected in the following situations. In some rare cases, the subject may not be in focus despite the fact that the focus area or the focus indicator glows green:

- Subject is very dark
- Objects of sharply differing brightness are included in the scene (e.g. the sun behind the subject makes that subject appear very dark)
- No contrast between the subject and surroundings (e.g. a portrait subject wearing a white shirt is standing in front of a white wall)
- Several objects are at different distances from the camera (e.g. the subject is inside a cage)
- Subjects with repeating patterns (window blinds, buildings with multiple rows of similarly shaped windows, etc.)
- Subject is moving rapidly

In the situations noted above, try pressing the shutter-release button halfway to refocus several times, or focus on another subject positioned at the same distance from the camera as the actual desired subject, and use focus lock (📖62).

## Focus Lock

Focus lock shooting is recommended when the camera does not activate the focus area that contains the desired subject.

**1** Set **AF area mode** to **Center** in  (auto) mode (54).

**2** Position the subject in the center of the frame and press the shutter-release button halfway.

- The camera focuses on the subject and the focus area glows green.
- Focus and exposure are locked.

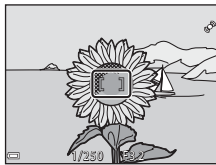

**3** Without lifting your finger, recompose the picture.

- Make sure to maintain the same distance between the camera and the subject.

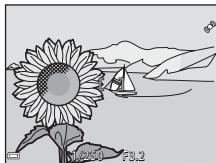

**4** Press the shutter-release button the rest of the way down to take the picture.



# Playback Features

## Playback Zoom

Moving the zoom control toward **T** (Q) in full-frame playback mode (📖28) zooms in on the image.

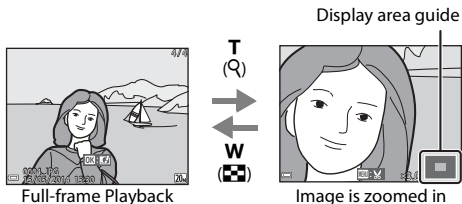

- You can change the zoom ratio by moving the zoom control toward **W** (🔲) or **T** (Q).
- To view a different area of the image, press the multi selector ▲▼◀▶.
- If you are viewing an image that was captured using face detection or pet detection, the camera zooms in on the face detected at the time of shooting, except for images captured with **Continuous**, **BSS**, **Multi-shot 16**, or **Subject tracking**. To zoom in on an area of the image where there are no faces, change the zoom ratio and then, press ▲▼◀▶.
- When a zoomed image is displayed, press the **OK** button to return to full-frame playback mode.

### Cropping Images

When a zoomed image is displayed, you can press the **MENU** button to crop the image to include only the visible portion and save it as a separate file (🔗18).

## Thumbnail Playback/Calendar Display

Moving the zoom control toward **W** (🗪) in full-frame playback mode (📖28) displays images as thumbnails.













- You can change the number of thumbnails displayed by moving the zoom control toward **W** (🗪) or **T** (🔍).
- While using thumbnail playback mode, press the multi selector ▲▼◀▶ to select an image and then press the **OK** button to display that image in full-frame playback mode.
- While using calendar display mode, press ▲▼◀▶ to select a date and then press the **OK** button to display the image captured on that day.



### 🗪 Notes About Calendar Display

Images captured when the camera's date is not set are treated as images captured on January 1, 2014.

## Functions That Can Be Set with the MENU Button (Playback Menu)

When viewing images in full-frame playback mode or thumbnail playback mode, you can configure the menu operations listed below by pressing the **MENU** button (📖4).

Option	Description	 13
Quick retouch*	Allows you to create retouched copies in which contrast and saturation have been enhanced.	 13
D-Lighting*	Allows you to create copies with enhanced brightness and contrast, brightening dark portions of an image.	 14
Red-eye correction*	Corrects "red-eye" that may occur in images when shooting with a flash.	 15
Glamour retouch*	Detects faces in images and retouches the detected faces glamorously.	 45
Print order	Allows you to select which images are printed, and how many copies of each image are printed, prior to printing.	 49
Slide show	Allows you to view images in an automatic slide show.	 50
Protect	Protects selected images from accidental deletion.	 52
Rotate image	Allows you to rotate the displayed image to portrait or landscape orientation.	 17
Small picture*	Creates a small copy of images.	 53
Voice memo	Allows you to use the camera's microphone to record voice memos and attach them to images.	 54
Copy	Allows you to copy images between the internal memory and a memory card.	

Option	Description	
<b>Favorite pictures</b>	Allows you to add images to an album. This option is not displayed in favorite pictures mode.	 5
<b>Remove from favorites</b>	Allows you to remove images from an album. This option is displayed only in favorite pictures mode.	 7

\* Edited images are saved as separate files. Some images may not be edited.

# Recording and Playing Back Movies

## Recording Movies

### 1 Display the shooting screen.

- Check the remaining amount of movie recording time.
- When the **Photo info** option in **Monitor settings** (p.73) in the setup menu is set to **Movie frame+auto info**, the area that will be visible in the movie can be confirmed before movie recording starts.
- When **Electronic VR** (p.73) in the setup menu is set to **Auto**, electronic vibration reduction is enabled and camera shake is reduced.

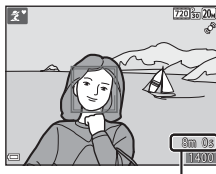

Maximum movie length

### 2 Press the **MOVIE** (movie-record) button to start movie recording.

- The camera focuses in the center of the frame.

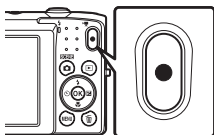

### 3 Press the **MOVIE** (movie-record) button again to end recording.

## Maximum Movie Length

Individual movie files cannot exceed 2 GB in size or 29 minutes in length, even when there is sufficient free space on the memory card for longer recording.

- The maximum movie length for a single movie is displayed on the shooting screen.
- Recording may end before either limit is reached if camera temperature becomes elevated.
- The actual movie length may vary depending on the movie content, subject movement, or type of memory card.

## Notes About Saving Images and Recording Movies

The indicator showing the number of exposures remaining or the indicator showing the maximum movie length flashes while images are being saved or while a movie is being recorded. **Do not open the battery-chamber/memory card slot cover or remove the battery or memory card** while an indicator is flashing. Doing this could result in loss of data, or in damage to the camera or the memory card.

## Notes About Movie Recording

- Memory cards with an SD Speed Class rating of 6 or faster are recommended when recording movies (🔍:20). Movie recording may stop unexpectedly when memory cards with a lower Speed Class ratings are used.
- When recording movies with  $\frac{720}{60p}$  720/30p/ $\frac{720}{60p}$  720/25p selected for **Movie options**, the angle of view (the area captured in the recorded movie) is smaller than when taking still images.
- When **Electronic VR** (📖:73) is set to **Auto** in the setup menu, the angle of view (the area captured in the recorded movie) is smaller than when taking still images.
- Optical zoom cannot be adjusted once movie recording begins.
- There may be some degradation in image quality when digital zoom is used. Subjects can be magnified up to 4× the digital zoom ratio that was applied before movie recording began.
- The sounds of zoom control operation, autofocus lens drive movement, and aperture operation when brightness changes may be recorded.
- Smear (🔍:3) visible in the monitor with movie recording will be recorded with movies. Avoiding bright objects such as the sun, reflections of the sun, and electric lights when recording movies is recommended.

- Depending on the distance to the subject or the amount of zoom applied, subjects with repeating patterns (fabrics, lattice windows, etc.) may have colored stripes (interference patterns, moire, etc.) in them during movie recording and playback. This occurs when the pattern in the subject and the layout of the image sensor interfere with each other; it is not a malfunction.

### ✔ Notes About Camera Temperature

- The camera may become hot when shooting movies for an extended period of time or when the camera is used in a hot area.
- If the inside of the camera becomes extremely hot when recording movies, the camera will automatically stop recording.  
The amount of time remaining until the camera stops recording (🕒10s) is displayed.  
After the camera stops recording, it turns itself off.  
Leave the camera off until the inside of the camera has cooled.

### ✔ Notes About Autofocus for Movie Recording

Autofocus may not perform as expected (📖61). Should this occur, try the following:







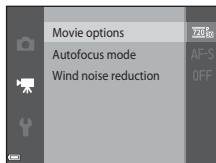

1. Set **Autofocus mode** in the movie menu to **Single AF** (default setting) before starting movie recording.
2. Frame another subject (positioned at the same distance from the camera as the intended subject) in the center of the frame, press the ● (🎬 movie-record) button to start recording, and modify the composition.

## Functions That Can Be Set with the MENU Button (Movie Menu)

Enter shooting mode → MENU button →  menu icon →  button

The settings of the menu options listed below can be configured.



Option	Description	
Movie options	Select the movie type. <ul style="list-style-type: none"> <li>• Default setting:  <b>720/30p</b>/ <b>720/25p</b></li> <li>• The default setting is  <b>480/30p</b>/ <b>480/25p</b> when the internal memory is used.</li> </ul>	 56
Autofocus mode	Select either <b>Single AF</b> , which locks focus when movie recording begins, or <b>Full-time AF</b> , which continues focusing during movie recording. <ul style="list-style-type: none"> <li>• Default setting: <b>Single AF</b></li> </ul>	 57
Wind noise reduction	Set whether or not to reduce wind noise during movie recording. <ul style="list-style-type: none"> <li>• Default setting: <b>Off</b></li> </ul>	 57

## Playing Back Movies

Press the  button to enter playback mode.

Movies are indicated by the movie options icon ()70).

Press the  button to play back movies.

- To adjust the volume, move the zoom control while a movie is playing ()1).

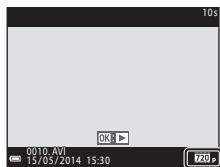

Movie options

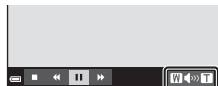

Volume indicator

## Operation During Movie Playback

Playback controls are displayed at the bottom of the monitor. The operations listed below can be performed by using the multi-selector ◀▶ to select a control and then pressing the OK button.



Paused

Function	Icon	Description
Rewind		Hold down the OK button to rewind the movie.
Advance		Hold down the OK button to advance the movie.
Pause		Pause playback. The operations listed below can be performed while paused.
		Rewind the movie one frame. Hold down the OK button for continuous rewinding.
		Advance the movie one frame. Hold down the OK button for continuous advancing.
		Resume playback.
End		Return to full-frame playback mode.

## Deleting Movies

To delete a movie, select the desired movie in full-frame playback mode (📖28) or thumbnail playback mode (📖64) and press the button (📖30).

# General Camera Setup







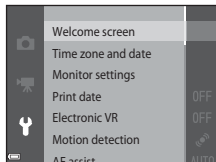





## Functions That Can Be Set with the MENU Button (Setup Menu)

Press the **MENU** button →  (setup) menu icon →  button

The settings of the menu options listed below can be configured.



Option	Description	
Welcome screen	Allows you to select whether or not the welcome screen is displayed when the camera is turned on.	58
Time zone and date	Allows you to set the camera clock.	59
Monitor settings	Allows you to adjust photo information display, post-shooting image review, and monitor brightness settings.	61
Print date	Allows you to imprint the shooting date and time on images.	63
Electronic VR	Allows you to reduce blurring caused by camera shake when shooting.	64
Motion detection	Allows you to set whether or not the camera reduces blurring caused by camera shake if motion is detected when shooting still images.	65

Option	Description	
AF assist	Allows you to enable or disable the AF-assist illuminator.	 66
Digital zoom	Allows you to enable and disable digital zoom.	 66
Sound settings	Allows you to adjust sound settings.	 67
Auto off	Allows you to set the amount of time that passes before the monitor turns off to save power.	 67
Format memory/ Format card	Allows you to format the internal memory or the memory card.	 68
Language	Allows you to change the camera's display language.	 69
Video mode	Allows you to adjust video mode settings for connection to a television. Select from <b>NTSC</b> and <b>PAL</b> .	 69
Charge by computer	Allows you to set whether or not the battery in the camera is charged when the camera is connected to a computer.	 70
Blink warning	Allows you to set whether or not closed eyes are detected when taking images of people using face detection.	 71
Eye-Fi upload	Allows you to set whether or not to enable the function for sending images to a computer using a commercially available Eye-Fi card.	 72
Reset all	Allows you to reset the camera's settings to their default values.	 73
Firmware version	View the current camera firmware version.	 73

# Connecting the Camera to a TV, Computer, or Printer

## Connection Methods

You can enhance your enjoyment of images and movies by connecting the camera to a TV, computer, or printer.

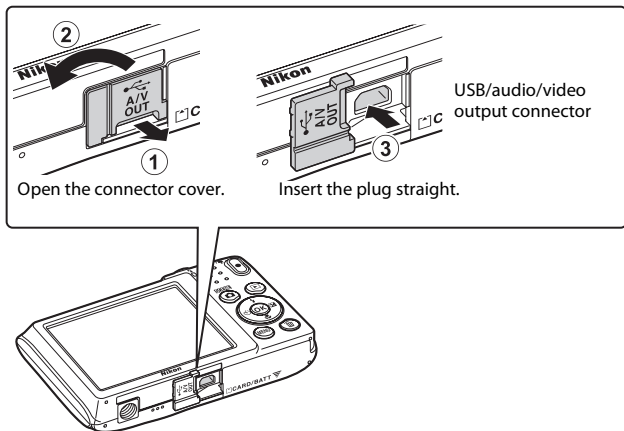

- Before connecting the camera to an external device, make sure the remaining battery level is sufficient and turn the camera off. Before disconnecting, make sure to turn the camera off.
- If the AC Adapter EH-62G (available separately) is used, this camera can be powered from an electrical outlet. Do not use any other make or model of AC adapter as it may cause the camera to heat up or malfunction.
- For information about the connection methods and subsequent operations, refer to the documentation included with the device in addition to this document.

**Viewing images on a TV** 19

Images and movies captured with the camera can be viewed on a TV.  
Connection method: Connect the video and audio plugs of an optional audio video cable to the TV's input jacks.

**Viewing and organizing images on a computer** 77

You can transfer images to a computer to perform simple retouching and manage image data.

Connection method: Connect the camera to the computer's USB port with the USB cable.

- Before connecting to a computer, install ViewNX 2 on the computer ( 77).
- If any USB devices that draw the power from the computer are connected, disconnect them from the computer before you connect the camera to it. Connecting the camera and other USB-powered devices to the same computer simultaneously may cause a camera malfunction or excessive power supply from the computer, which could damage the camera or memory card.

**Printing images without using a computer** 20

If you connect the camera to a PictBridge-compatible printer, you can print images without using a computer.

Connection method: Connect the camera directly to the printer's USB port with the USB cable.

## Using ViewNX 2

ViewNX 2 is an all-in-one software package which enables you to transfer, view, edit and share images. Install ViewNX 2 using the included ViewNX 2 CD-ROM.



## Installing ViewNX 2

- An Internet connection is required.

## Compatible Operating Systems

### Windows

Windows 8.1, Windows 7, Windows Vista, Windows XP

### Mac

OS X 10.9, 10.8, 10.7

Refer to the Nikon website for details on system requirements, including the latest information on operating system compatibility.

# 1 Start the computer and insert the ViewNX 2 CD-ROM into the CD-ROM drive.

- Windows: If instructions for operating the CD-ROM are displayed in the window, follow the instructions to proceed to the installation window.
- Mac: When the **ViewNX 2** window is displayed, double-click the **Welcome** icon.

# 2 Select a language in the language selection dialog to open the installation window.

- If the desired language is not available, click **Region Selection** to choose a different region, and then choose the desired language (the **Region Selection** button is not available in the European release).
- Click **Next** to display the installation window.

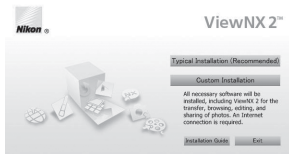
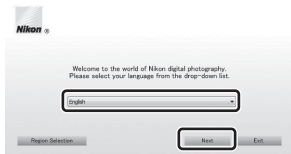

# 3 Start the installer.

- We recommend clicking **Installation Guide** in the installation window to check the installation help information and system requirements before installing ViewNX 2.
- Click **Typical Installation (Recommended)** in the installation window.

# 4 Download the software.

- When the **Software Download** screen is displayed, click **I agree - Begin download**.
- Follow the on-screen instructions to install the software.

---

## 5 Exit the installer when the installation completion screen is displayed.

- Windows: Click **Yes**.
- Mac: Click **OK**.

The following software is installed:

- ViewNX 2 (consisting of the three modules below)
  - Nikon Transfer 2: For transferring images to the computer
  - ViewNX 2: For viewing, editing, and printing transferred images
  - Nikon Movie Editor: For basic editing of transferred movies
- Panorama Maker (for creating a single panorama photo using a series of images shot in panorama assist scene mode)

---

## 6 Remove the ViewNX 2 CD-ROM from the CD-ROM drive.

# Transferring Images to the Computer

## 1 Choose how images will be copied to the computer.

Choose one of the following methods:

- **Direct USB connection:** Turn the camera off and ensure that the memory card is inserted in the camera. Connect the camera to the computer using the USB cable. The camera automatically turns on.  
To transfer images that are saved in the camera's internal memory, remove the memory card from the camera before connecting it to the computer.

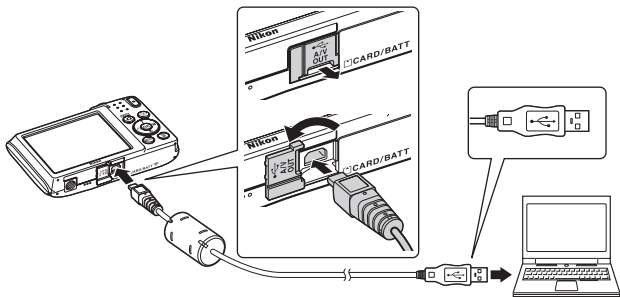

- **SD card slot:** If your computer is equipped with an SD card slot, the card can be inserted directly in the slot.
- **SD card reader:** Connect a card reader (available separately from third-party suppliers) to the computer and insert the memory card.

If a message is displayed prompting you to choose a program, select Nikon Transfer 2.

- **When using Windows 7**

If the dialog shown at right is displayed, follow the steps below to select Nikon Transfer 2.

- 1 Under **Import pictures and videos**, click **Change program**. A program selection dialog will be displayed; select **Import File using Nikon Transfer 2** and click **OK**.
- 2 Double-click **Import File**.



If the memory card contains a large number of images, it may take a while for Nikon Transfer 2 to start. Wait until Nikon Transfer 2 starts.

## ✓ Connecting the USB Cable

The connection may not be recognized if the camera is connected to the computer via a USB hub.

## 2 Transfer images to the computer.

- Click **Start Transfer**.

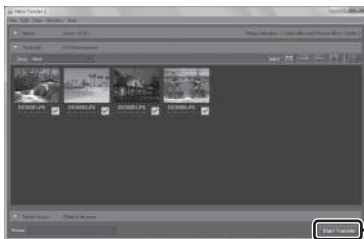

Start Transfer

- At default settings, all the images on the memory card will be copied to the computer.

### 3 Terminate the connection.

- If the camera is connected to the computer, turn the camera off and disconnect the USB cable. If you are using a card reader or card slot, choose the appropriate option in the computer operating system to eject the removable disk corresponding to the memory card, and then remove the card from the card reader or card slot.

## Viewing Images

### Start ViewNX 2.

- Images are displayed in ViewNX 2 when transfer is complete.
- Consult online help for more information on using ViewNX 2.

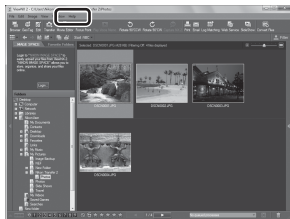

### Starting ViewNX 2 Manually

- **Windows:** Double-click the **ViewNX 2** shortcut on the desktop.
- **Mac:** Click the **ViewNX 2** icon in the Dock.



# Technical Notes and Index

<b>Caring for the Product</b> .....	<b>2</b>
The Camera.....	2
The Battery.....	4
Charging AC Adapter.....	5
Memory Cards.....	5
<b>Cleaning and Storage</b> .....	<b>6</b>
Cleaning.....	6
Storage.....	6
<b>Troubleshooting</b> .....	<b>7</b>
<b>Specifications</b> .....	<b>16</b>
Approved Memory Cards.....	20
<b>Index</b> .....	<b>22</b>

# Caring for the Product

## The Camera

To ensure continued enjoyment of this Nikon product, observe the precautions described below in addition to the warnings in “For Your Safety” (📖viii-x) when using or storing the device.

### **Keep Dry**

The device will be damaged if immersed in water or subjected to high humidity.

### **Do Not Drop**

The product may malfunction if subjected to strong shock or vibration.

### **Handle the Lens and All Moving Parts with Care**

Do not apply force to the lens, lens cover, monitor, memory card slot, or battery chamber. These parts are easily damaged. Applying force to the lens cover could result in camera malfunction or damage to the lens. Should the monitor break, care should be taken to avoid injury caused by broken glass and to prevent the liquid crystal from the display touching the skin or entering the eyes or mouth.

### **Do Not Point the Lens at Strong Light Sources for Extended Periods**

Avoid pointing the lens at the sun or other strong light sources for extended periods when using or storing the camera. Intense light may cause deterioration of the CCD image sensor, producing a white blur effect in photographs.

### **Keep Away from Strong Magnetic Fields**

Do not use or store this device in the vicinity of equipment that generates strong electromagnetic radiation or magnetic fields. Strong static charge or the magnetic fields produced by equipment such as radio transmitters could interfere with the monitor, damage data saved on the memory card, or affect the product's internal circuitry.

## **Avoid Sudden Changes in Temperature**

Sudden changes in temperature, such as when entering or leaving a heated building on a cold day, can cause condensation to form inside the device. To prevent condensation, place the device in a carrying case or a plastic bag before exposing it to sudden changes in temperature.

## **Turn the Product Off Before Removing or Disconnecting the Power Source or Memory Card**

Do not remove the battery while the product is on, or while images are being saved or deleted. Forcibly cutting power in these circumstances could result in loss of data or in damage to product memory or internal circuitry.

## **Notes About the Monitor**

- Monitors and electronic viewfinders are constructed with extremely high precision; at least 99.99% of pixels are effective, with no more than 0.01% being missing or defective. Hence while these displays may contain pixels that are always lit (white, red, blue, or green) or always off (black), this is not a malfunction and has no effect on images recorded with the device.
- White or colored streaks may be visible when bright subjects are framed in the monitor. This phenomenon, known as “smear,” occurs when extremely bright light strikes the image sensor; it is characteristic of image sensors and does not indicate a malfunction. Smear may also take the form of partial discoloration in the monitor during shooting. It does not appear in images saved with the camera except in the cases of movies and of images saved with **Multi-shot 16** selected for **Continuous**. When shooting in these modes, we recommend that you avoid bright subjects such as the sun, reflected sunlight, and electric lights.
- Images in the monitor may be difficult to see under bright lighting.
- The monitor is lit by an LED backlight. Should the monitor begin to dim or flicker, contact your Nikon-authorized service representative.

## The Battery

Be sure to read and follow the warnings in "For Your Safety" (viii-x) before use.

- Check the battery level before using the camera and replace or charge the battery if necessary. Do not continue charging once the battery is fully charged as this will result in reduced battery performance. Whenever possible, carry a fully charged spare battery when taking images on important occasions.
- Do not use the battery at ambient temperatures below 0°C (32°F) or above 40°C (104°F).
- Charge the battery indoors with an ambient temperature of 5°C to 35°C (41°F to 95°F) before use.
- When charging the battery inserted into this camera using the Charging AC Adapter or a computer, the battery is not charged at battery temperatures below 0°C (32°F) or above 45°C (113°F).
- Note that the battery may become hot during use; wait for the battery to cool before charging. Failure to observe these precautions could damage the battery, impair its performance, or prevent it from charging normally.
- On cold days, the capacity of batteries tends to decrease. Be sure that the battery is fully charged before heading outside to take images in cold weather. Keep spare batteries in a warm place and exchange as necessary. Once warmed, a cold battery may recover some of its charge.
- Dirt on the battery terminals can prevent the camera from functioning. Should the battery terminals become dirty, wipe them off with a clean, dry cloth before use.
- If the battery will not be used for some time, insert it in the camera and completely exhaust it before removing it for storage. The battery should be stored in a cool location with an ambient temperature of 15°C to 25°C (59°F to 77°F). Do not store the battery in hot or extremely cold locations.
- Always remove the battery from the camera or optional battery charger when it is not being used. When inserted, minute amounts of current flow even when unused, and the battery may become excessively drained and no longer function. Turning the camera on or off while the battery is exhausted can result in reduced battery life.
- Recharge the battery at least once every six months and completely exhaust it before returning it to storage.
- After removing the battery from the camera or optional battery charger, put the battery in a plastic bag, etc. in order to insulate it and store it in a cool place.
- A marked drop in the time a fully charged battery retains its charge, when used at room temperature, indicates that the battery needs to be replaced. Purchase a new EN-EL19 battery.

- Replace the battery when it no longer holds a charge. Used batteries are a valuable resource. Please recycle used batteries in accordance with local regulations.

## Charging AC Adapter

Be sure to read and follow the warnings in “For Your Safety” (📖viii-x) before use.

- The Charging AC Adapter EH-70P is for use only with compatible devices. Do not use with another make or model of device.
- The EH-70P is compatible with AC 100-240 V, 50/60 Hz electrical outlets. When using in other countries, use a plug adapter (commercially available) as necessary. For more information about plug adapters, consult your travel agency.
- Do not, under any circumstances, use another make or model of AC adapter other than Charging AC Adapter EH-70P or USB-AC adapter. Failure to observe this precaution could result in overheating or in damage to the camera.

## Memory Cards

- Use only Secure Digital memory cards. See “Approved Memory Cards” (🔒20) for recommended memory cards.
- Be sure to follow the precautions described in the documentation included with the memory card.
- Do not put labels or stickers on memory cards.
- The first time you insert a memory card that has been used in another device into this camera, be sure to format it with this camera. We recommend formatting new memory cards with this camera before using them with this camera.
- Note that **formatting a memory card permanently deletes all images and other data on the memory card**. Be sure to make copies of any images you wish to keep before formatting the memory card.
- If the message **Card is not formatted. Format card?** is displayed when the camera is turned on, the memory card must be formatted. If there is data that you do not want to delete, select **No**. Copy the necessary data to a computer, etc. If you want to format the card, select **Yes**. The confirmation dialog will be displayed. To start formatting, press the **Ⓜ** button.
- Do not perform the following during formatting, while data is being written to or deleted from the memory card, or during data transfer to a computer. Failure to observe this precaution could result in the loss of data or in damage to the camera or memory card:
  - Open the battery-chamber/memory card slot cover to remove/insert the battery or memory card.
  - Turn off the camera.
  - Disconnect the AC adapter.
- Do not format the memory card using a computer.

# Cleaning and Storage

## Cleaning

Do not use alcohol, thinner, or other volatile chemicals.

Lens	Avoid touching the lens with your fingers. Remove dust or lint with a blower (typically a small device with a rubber bulb attached to one end that is pumped to produce a stream of air out the other end). To remove fingerprints or other stains that cannot be removed with a blower, wipe the lens with a soft cloth, using a spiral motion that starts at the center of them and working toward the edges. If this fails, clean the lens using a cloth lightly dampened with commercial lens cleaner.
Monitor	Remove dust or lint with a blower. To remove fingerprints and other stains, clean the monitor with a soft, dry cloth, being careful not to apply pressure.
Body	Use a blower to remove dust, dirt, or sand, then wipe gently with a soft, dry cloth. After using the camera at the beach or other sandy or dusty environment, wipe off any sand, dust, or salt with a dry cloth lightly dampened with fresh water and dry thoroughly. <b>Note that foreign matter inside the camera could cause damage not covered by the warranty.</b>

## Storage

Turn the camera off when not in use. Be sure that the power-on lamp is off before putting the camera away. Remove the battery if the camera will not be used for an extended period. Do not store the camera with naphtha or camphor moth balls, or in any of the following locations:

- Next to equipment that produces strong electromagnetic fields, such as televisions or radios
- Exposed to temperatures below  $-10^{\circ}\text{C}$  ( $14^{\circ}\text{F}$ ) or above  $50^{\circ}\text{C}$  ( $122^{\circ}\text{F}$ )
- Places that are poorly ventilated or subject to humidity of over 60%



To prevent mold or mildew, take the camera out of storage at least once a month. Turn the camera on and release the shutter a few times before putting the camera away again.











For storing the battery, follow the precautions in "The Battery" (🔋:4) in "Caring for the Product" (🔧:2).







# Troubleshooting

If the camera fails to function as expected, check the list of common problems below before consulting your retailer or Nikon-authorized service representative.



## Power, Display, Settings Issues









Problem	Cause/Solution	
The camera is on but does not respond.	Wait for recording to end. If the problem persists, turn the camera off. If the camera does not turn off, remove and reinsert the battery or batteries or, if you are using an AC adapter, disconnect and reconnect the AC adapter. Note that although any data currently being recorded will be lost, data that have already been recorded will not be affected by removing or disconnecting the power source.	20,  79
Battery inserted in the camera cannot be charged.	<ul style="list-style-type: none"><li>• Confirm all connections.</li><li>• When connected to a computer, the camera may not charge for any of the reasons described below.<ul style="list-style-type: none"><li>- <b>Off</b> is selected for <b>Charge by computer</b> in the setup menu.</li><li>- Battery charging stops if the camera is turned off.</li><li>- Battery charging is not possible if the camera's display language and date and time have not been set, or the date and time were reset after the camera's clock battery was exhausted. Use the Charging AC Adapter to charge the battery.</li><li>- Battery charging may stop if the computer is in sleep mode.</li><li>- Depending upon the computer specifications, settings, and status, battery charging may not be possible.</li></ul></li></ul>	12 74,  70 – 16, 18 – –
The camera cannot be turned on.	The battery is exhausted.	20











Problem	Cause/Solution	
The camera turns off without warning.	<ul style="list-style-type: none"> <li>The camera automatically turns off to save power (auto off function).</li> <li>The camera and battery may not work properly at low temperatures.</li> <li>The inside of the camera has become hot. Leave the camera off until the inside of the camera has cooled, and then try turning it on again.</li> <li>The camera turns off if the USB cable connecting it to a computer or printer is disconnected. Reconnect the USB cable.</li> </ul>	21  4 – 75, 80,  21
Monitor is blank.	<ul style="list-style-type: none"> <li>The camera is off.</li> <li>The battery is exhausted.</li> <li>The camera has entered standby mode to save power. Press the power switch, shutter-release button,  button,  button, or  (movie-record) button.</li> <li>The flash lamp flashes while the flash is charging. Wait for the flash to charge.</li> <li>The camera and computer are connected via the USB cable.</li> <li>The camera and TV are connected via an audio video cable.</li> </ul>	20 20 21 45 75, 80 75,  19
Monitor is hard to read.	<ul style="list-style-type: none"> <li>Adjust the monitor brightness.</li> <li>The monitor is dirty. Clean the monitor.</li> </ul>	73,  61  6
Date and time of recording are not correct.	<ul style="list-style-type: none"> <li>If the camera clock has not been set, the "Date not set" indicator flashes during shooting and movie recording. Images and movies recorded before the clock is set are dated "00/00/0000 00:00" and "01/01/2014 00:00" respectively. Set the correct time and date for <b>Time zone and date</b> in the setup menu.</li> <li>The camera clock is not as accurate as ordinary watches or clocks. Periodically compare the time of the camera clock with that of a more accurate timepieces, and reset as required.</li> </ul>	16, 73,  59











Problem	Cause/Solution	
No indicators displayed in monitor.	<b>Hide info</b> is selected for <b>Photo info</b> in <b>Monitor settings</b> in the setup menu.	73,  61
<b>Print date</b> not available.	<b>Time zone and date</b> has not been set in the setup menu.	16, 73,  59
Date not imprinted on images even when <b>Print date</b> is enabled.	<ul style="list-style-type: none"> <li>The current shooting mode does not support <b>Print date</b>.</li> <li>The date cannot be imprinted on movies.</li> </ul>	73,  63
Screen for setting time zone and date is displayed when the camera is turned on.	The clock battery is exhausted; all settings were restored to their default values.	16, 18
The camera settings reset.		
The camera becomes hot.	The camera may become hot when used for an extended period of time to shoot movies or send images using an Eye-Fi card, or when used in a hot environment; this is not a malfunction.	–
The camera makes sound.	When <b>Autofocus mode</b> is set to <b>Full-time AF</b> or while in some shooting modes, the camera may produce an audible focusing sound.	54, 70,  41,  57



## Shooting Issues

Problem	Cause/Solution	
Cannot switch to shooting mode.	The camera cannot be switched to shooting mode while connected to a power outlet via the Charging AC Adapter.	12
No image captured when the shutter-release button is pressed.	<ul style="list-style-type: none"> <li>When the camera is in playback mode, press the  button, shutter-release button, or  button.</li> </ul>	28
	<ul style="list-style-type: none"> <li>When menus are displayed, press the <b>MENU</b> button.</li> </ul>	4
	<ul style="list-style-type: none"> <li>The battery is exhausted.</li> </ul>	20
	<ul style="list-style-type: none"> <li>When the flash lamp is flashing, the flash is charging.</li> </ul>	45

Problem	Cause/Solution	
The camera cannot focus.	<ul style="list-style-type: none"> <li>The subject is too close. Try shooting using macro mode or  (scene auto selector) mode, or <b>Close-up</b> scene mode.</li> <li>The subject is hard to focus on.</li> <li>Set <b>AF assist</b> in the setup menu to <b>Auto</b>.</li> <li>Turn the camera off and then on again.</li> </ul>	32, 35, 49  61 74,  66 20
Images are blurred.	<ul style="list-style-type: none"> <li>Use the flash.</li> <li>Increase the ISO sensitivity value.</li> <li>Enable electronic vibration reduction or motion detection.</li> <li>Use <b>BSS</b> (Best Shot Selector).</li> <li>Use a tripod to stabilize the camera when shooting (using the self-timer at the same time is more effective).</li> </ul>	45 54,  35 73,  64,  65 35,  33 47
Streaks of light or partial discoloration are visible in the monitor.	Smear may occur when extremely bright light strikes the image sensor. When shooting with <b>Continuous</b> set to <b>Multi-shot 16</b> and when recording movies, avoiding bright objects, such as the sun, reflections of the sun, and electric lights is recommended.	68,  34,  3





Problem	Cause/Solution	
Bright specks appear in images captured with flash.	The flash is reflecting off particles in the air. Set the flash mode setting to  (off).	46
Flash does not fire.	<ul style="list-style-type: none"> <li>• The flash mode is set to  (off).</li> <li>• A scene mode that restricts the flash is selected.</li> <li>• <b>On</b> is selected for <b>Blink proof</b> in the smart portrait menu.</li> <li>• A function that restricts the flash is enabled.</li> </ul>	46 51 55 56
Optical zoom cannot be used.	Optical zoom cannot be used while recording movies.	68
Digital zoom cannot be used.	<ul style="list-style-type: none"> <li>• <b>Digital zoom</b> is set to <b>Off</b> in the setup menu.</li> <li>• Digital zoom cannot be used in the following situations: <ul style="list-style-type: none"> <li>- When <b>Portrait</b>, <b>Night portrait</b>, or <b>Pet portrait</b> scene mode is selected</li> <li>- When smart portrait mode is selected</li> <li>- When <b>Continuous</b> is set to <b>Multi-shot 16</b> in  (auto) mode</li> <li>- When <b>AF area mode</b> is set to <b>Subject tracking</b> in  (auto) mode</li> </ul> </li> </ul>	74,  66 33 40 54,  33 54,  37
<b>Image mode</b> not available.	A function that restricts <b>Image mode</b> is enabled.	56
No sound when the shutter is released.	<ul style="list-style-type: none"> <li>• <b>Off</b> is selected for <b>Shutter sound</b> in the <b>Sound settings</b> setup menu. No sound is produced with some shooting modes and settings, even when <b>On</b> is selected.</li> <li>• The speaker is blocked. Do not cover the speaker.</li> </ul>	74,  67 2, 24
AF-assist illuminator does not light.	<b>Off</b> is selected for <b>AF assist</b> in the setup menu. AF-assist illuminator may not light depending on the position of the focus area or the current scene mode, even when <b>Auto</b> is selected.	74,  66





Problem	Cause/Solution	
Images appear smeared.	The lens is dirty. Clean the lens.	 6
Colors are unnatural.	White balance is not adjusted properly.	35, 54,  30
Randomly spaced bright pixels (“noise”) appear in image.	The subject is dark and the shutter speed is too slow, or ISO sensitivity is too high. Noise can be reduced by: <ul style="list-style-type: none"> <li>Using flash</li> <li>Specifying a lower ISO sensitivity setting</li> </ul>	45 54,  35
Randomly spaced bright pixels (“noise”) appear in movies.	When recording movies in dim lighting, the image may become somewhat “grainy” in appearance. This occurs when the ISO sensitivity increases, and it does not indicate a malfunction.	–
Images are too dark (underexposed).	<ul style="list-style-type: none"> <li>The flash mode is set to  (off).</li> <li>The flash window is blocked.</li> <li>The subject is beyond the range of the flash.</li> <li>Adjust exposure compensation.</li> <li>Increase ISO sensitivity.</li> <li>The subject is backlit. Select <b>Backlighting</b> scene mode or set the flash mode setting to  (fill flash).</li> </ul>	46 24 45 50 54,  35 36, 46
Images are too bright (overexposed).	Adjust exposure compensation.	50
Unexpected results when flash set to  (auto with red-eye reduction).	When taking images with  (auto with red-eye reduction) or fill flash with slow sync and red-eye reduction in <b>Night portrait</b> scene mode, the In-Camera Red Eye Fix processing may be applied to areas not affected by red-eye in rare cases. Use any scene mode other than <b>Night portrait</b> , and change the flash mode to any setting other than  (auto with red-eye reduction) and try taking an image again.	33, 46

Problem	Cause/Solution	
Skin tones are not softened.	<ul style="list-style-type: none"> <li>• In some shooting conditions, facial skin tones may not be softened.</li> <li>• For images containing four or more faces, try using the <b>Skin softening</b> effect in <b>Glamour retouch</b> in the playback menu.</li> </ul>	59 65,  15
Saving images takes time.	<p>It may take more time to save images in the following situations:</p> <ul style="list-style-type: none"> <li>• When the noise reduction function is in operation</li> <li>• When the flash mode is set to  (auto with red-eye reduction)</li> <li>• When the skin softening function is applied while shooting</li> </ul>	– 46 55, 59,  42
Colored circles or light streaks appear in the monitor or images.	When shooting with backlighting or when a very strong light source (such as sunlight) is in the frame, colored circles or light streaks (ghosting) may occur. Change the position of the light source, or frame the image so that the light source does not enter the frame, and try again.	–

## Playback Issues

Problem	Cause/Solution	
File cannot be played back.	<ul style="list-style-type: none"> <li>• This camera may not be able to play back images saved with another make or model of digital camera.</li> <li>• This camera cannot play back movies recorded with another make or model of digital camera.</li> <li>• This camera may not be able to play back data edited on a computer.</li> </ul>	–

Problem	Cause/Solution	
Cannot zoom in on image.	<ul style="list-style-type: none"> <li>• Playback zoom cannot be used with movies.</li> <li>• For small images, the zoom ratio displayed on the screen may not be compatible with the actual zoom ratio.</li> <li>• This camera may not be able to zoom in on images captured with another make or model of digital camera.</li> </ul>	–
Cannot record or play back voice memos.	<ul style="list-style-type: none"> <li>• Voice memos cannot be attached to movies.</li> <li>• Voice memos cannot be attached to images captured with other cameras. Voice memos attached to images using another camera cannot be played back on this camera.</li> </ul>	– 65,  53
Cannot edit images.	<ul style="list-style-type: none"> <li>• Some images cannot be edited. Images that have already been edited may not be edited again.</li> <li>• There is not enough free space in the internal memory or on the memory card.</li> <li>• This camera is unable to edit images captured with other cameras.</li> <li>• Editing functions used for images are not available for movies.</li> </ul>	 11 – – –
Images are not displayed on TV.	<ul style="list-style-type: none"> <li>• <b>Video mode</b> is not correctly set in the setup menu.</li> <li>• The memory card contains no images. Replace the memory card. Remove the memory card to play back images from the internal memory.</li> </ul>	74,  69 14
Nikon Transfer 2 does not start when the camera is connected to a computer.	<ul style="list-style-type: none"> <li>• The camera is off.</li> <li>• The battery is exhausted.</li> <li>• The USB cable is not correctly connected.</li> <li>• The camera is not recognized by the computer.</li> <li>• The computer is not set to start Nikon Transfer 2 automatically. For more information about Nikon Transfer 2, refer to help information contained in ViewNX 2.</li> </ul>	20 20 75 – 77

Problem	Cause/Solution	
<p>The PictBridge startup screen is not displayed when the camera is connected to a printer.</p>	<p>With some PictBridge-compatible printers, the PictBridge startup screen may not be displayed and it may be impossible to print images when <b>Auto</b> is selected for <b>Charge by computer</b> in the setup menu. Set <b>Charge by computer</b> to <b>Off</b> and reconnect the camera to the printer.</p>	<p>74, 70</p>
<p>Images to be printed are not displayed.</p>	<ul style="list-style-type: none"> <li>• Memory card contains no images. Replace the memory card.</li> <li>• Remove the memory card to print images from the internal memory.</li> </ul>	<p>14</p>
<p>Cannot select paper size with the camera.</p>	<p>The camera cannot be used to select the paper size in the following situations, even when printing from a PictBridge-compatible printer. Use the printer to select the paper size.</p> <ul style="list-style-type: none"> <li>• The printer does not support the paper sizes specified by the camera.</li> <li>• The printer automatically selects the paper size.</li> </ul>	<p>75, 24, 25 –</p>

# Specifications

## Nikon COOLPIX S2800 Digital Camera

Type	Compact digital camera
Number of effective pixels	20.1 million
Image sensor	<sup>1</sup> /2.3-in. type CCD; total pixels: approx. 20.48 million
Lens	NIKKOR lens with 5x optical zoom
Focal length	4.6–23.0mm (angle of view equivalent to that of 26–130 mm lens in 35mm [135] format)
f/-number	f/3.2–6.5
Construction	6 elements in 5 groups
Digital zoom magnification	Up to 4x (angle of view equivalent to that of approx. 520 mm lens in 35mm [135] format)
Vibration reduction	Electronic VR (movies)
Motion blur reduction	Electronic VR (still pictures), Motion detection (still pictures)
Autofocus (AF)	Contrast-detect AF
Focus range	<ul style="list-style-type: none"><li>• [W]: Approx. 50 cm (1 ft 8 in.)–∞</li><li>  [T]: Approx. 80 cm (2 ft 8 in.)–∞</li><li>• Macro mode: Approx. 10 cm (4 in.)–∞ (wide-angle position) (All distances measured from center of front surface of lens)</li></ul>
Focus-area selection	Face priority, center, manual with 99 focus areas, subject tracking, target finding AF
Monitor	6.7 cm (2.7-in.), approx. 230k-dot, TFT LCD, and 5-level brightness adjustment
Frame coverage (shooting mode)	Approx. 98% horizontal and 98% vertical (compared to actual image)
Frame coverage (playback mode)	Approx. 98% horizontal and 98% vertical (compared to actual image)

<b>Storage</b>	
Media	Internal memory (approx. 25 MB), SD/SDHC/SDXC memory card
File system	DCF, Exif 2.3, and DPOF compliant
File formats	Still pictures: JPEG Sound files (Voice Memo): WAV Movies: AVI (Motion-JPEG compliant)
Image size (pixels)	<ul style="list-style-type: none"> <li>• 20M (High) [5152×3864★]</li> <li>• 20M [5152×3864]</li> <li>• 10M [3648×2736]</li> <li>• 4M [2272×1704]</li> <li>• 2M [1600×1200]</li> <li>• VGA [640×480]</li> <li>• 16:9 (14M) [5120×2880]</li> <li>• 1:1 [3864×3864]</li> </ul>
ISO sensitivity (Standard output sensitivity)	<ul style="list-style-type: none"> <li>• ISO 80–1600</li> <li>• ISO 3200 (available when using Auto mode)</li> </ul>
<b>Exposure</b>	
Metering mode	Matrix, center-weighted (digital zoom less than 2×), spot (digital zoom 2× or more)
Exposure control	Programmed auto exposure and exposure compensation (–2.0 – +2.0 EV in steps of $\frac{1}{3}$ EV)
<b>Shutter</b>	
Speed	$\frac{1}{2000}$ –1 s 4 s (when scene mode is set to <b>Fireworks show</b> )
<b>Aperture</b>	
Range	Electronically-controlled ND filter (–2.6 AV) selection 2 steps (f/3.2 and f/8 [W])
Self-timer	Can be selected from 10 s and 2 s

<b>Flash</b>	
Range (approx.) (ISO sensitivity: <b>Auto</b> )	[W]: 0.5–4.0 m (1 ft 8 in.–13 ft) [T]: 0.8–2.0 m (2 ft 8 in.–6 ft 6 in.)
Flash control	TTL auto flash with monitor preflashes
<b>Interface</b>	
Data Transfer Protocol	MTP, PTP
Video output	Can be selected from NTSC and PAL
I/O terminal	Audio/video (A/V) output; digital I/O (USB)
Supported languages	Arabic, Bengali, Bulgarian, Chinese (Simplified and Traditional), Czech, Danish, Dutch, English, Finnish, French, German, Greek, Hindi, Hungarian, Indonesian, Italian, Marathi, Norwegian, Persian, Polish, Portuguese (European and Brazilian), Romanian, Russian, Serbian, Spanish, Swedish, Tamil, Telugu, Thai, Turkish, Ukrainian, Vietnamese
Power sources	One Rechargeable Li-ion Battery EN-EL19 (included) AC Adapter EH-62G (available separately)
Charging time	Approx. 3 h (when using Charging AC Adapter EH-70P and when no charge remains)
<b>Battery life<sup>1</sup></b>	
Still pictures	Approx. 250 shots when using EN-EL19
Movies (actual battery life for recording) <sup>2</sup>	Approx. 1 h 5 min when using EN-EL19
Tripod socket	1/4 (ISO 1222)
Dimensions (W × H × D)	Approx. 93.8 × 58.4 × 19.8 mm (3.7 × 2.3 × 0.8 in.) (excluding projections)
Weight	Approx. 120 g (4.3 oz) (with battery and SD memory card)
<b>Operating environment</b>	
Temperature	0°C–40°C (32°F–104°F)
Humidity	85% or less (no condensation)

- Unless otherwise stated, all figures assume a fully-charged battery and an ambient temperature of 23 ±3°C (73.4 ±5.4°F) as specified by the Camera and Imaging Products Association (CIPA).

- 1 Battery life may vary depending on conditions of use, such as the interval between shots or the length of time that menus and images are displayed.
- 2 Individual movie files cannot exceed 2 GB in size or 29 minutes in length. Recording may end before this limit is reached if camera temperature becomes elevated.

## Rechargeable Li-ion Battery EN-EL19

Type	Rechargeable lithium-ion battery
Rated capacity	DC 3.7 V, 700 mAh
Operating temperature	0°C–40°C (32°F–104°F)
Dimensions (W × H × D)	Approx. 31.5 × 39.5 × 6 mm (1.3 × 1.6 × 0.3 in.)
Weight	Approx. 14.5 g (0.5 oz)

## Charging AC Adapter EH-70P

Rated input	AC 100–240 V, 50/60 Hz, 0.07–0.044 A
Rated output	DC 5.0 V, 550 mA
Operating temperature	0°C–40°C (32°F–104°F)
Dimensions (W × H × D)	Approx. 55 × 22 × 54 mm (2.2 × 0.9 × 2.2 in.) (excluding plug adapter) For Argentina: Approx. 55 × 59 × 63 mm (2.2 × 2.4 × 2.5 in.)
Weight	Approx. 47 g (1.7 oz) (excluding plug adapter) For Argentina: Approx. 72 g (2.6 oz)

### Specifications

- Nikon will not be held liable for any errors this manual may contain.
- The appearance of this product and its specifications are subject to change without notice.

## Approved Memory Cards

The following Secure Digital (SD) memory cards have been tested and approved for use in this camera.

- Memory cards with an SD Speed Class rating of 6 or faster are recommended for recording movies. Movie recording may stop unexpectedly when memory cards with a lower Speed Class rating are used.

	SD memory card	SDHC memory card <sup>2</sup>	SDXC memory card <sup>3</sup>
SanDisk	2 GB <sup>1</sup>	4 GB, 8 GB, 16 GB, 32 GB	64 GB, 128 GB
TOSHIBA	–	4 GB, 8 GB, 16 GB, 32 GB	64 GB
Panasonic	2 GB <sup>1</sup>	4 GB, 8 GB, 16 GB, 32 GB	64 GB
Lexar	–	4 GB, 8 GB, 16 GB, 32 GB	64 GB, 128 GB

<sup>1</sup> If the memory card is used with a card reader or similar device, make sure that the device supports 2 GB cards.

<sup>2</sup> SDHC compliant. If the memory card is used with a card reader or similar device, be sure that the device is compliant with the SDHC standard.

<sup>3</sup> SDXC compliant. If the memory card is used with a card reader or similar device, be sure that the device is compliant with the SDXC standard.

- Contact the manufacturer for details on the above cards. We cannot guarantee camera performance when using memory cards made by other manufacturers.



## Trademark Information

- Microsoft, Windows and Windows Vista are either registered trademarks or trademarks of Microsoft Corporation in the United States and/or other countries.
- Mac and OS X are trademarks or registered trademarks of Apple Inc., in the U.S. and other countries.
- Adobe and Acrobat are registered trademarks of Adobe Systems Inc.
- SDXC, SDHC, and SD Logos are trademarks of SD-3C, LLC.
- PictBridge is a trademark.
- All other trade names mentioned in this manual or the other documentation provided with your Nikon product are the trademarks or registered trademarks of their respective holders.

## FreeType License (FreeType2)













































- Portions of this software are copyright © 2014 The FreeType Project (<http://www.freetype.org>). All rights reserved.

## MIT License (HarfBuzz)





















- Portions of this software are copyright © 2014 The HarfBuzz Project (<http://www.freedesktop.org/wiki/Software/HarfBuzz>). All rights reserved.























# Index

## Symbols



































 Scene auto selector mode .....	32
 Auto mode .....	42
 Scene mode .....	33
<b>SO</b> Special effects mode .....	38
 Smart portrait mode .....	40
 Playback mode .....	28
 Favorite pictures mode .....	 5
 Auto sort mode .....	 9
 List by date mode .....	 10
 Setup menu .....	73,  58
<b>T</b> (Telephoto) .....	1, 25
<b>W</b> (Wide-angle) .....	1, 25
 Playback zoom .....	1, 63
 Thumbnail playback .....	1, 64
 Help .....	1, 33
 (movie-record) button .....	2, 67
 (Shooting mode) button .....	2, 22
 Playback button .....	2, 28
 Apply selection button .....	2
<b>MENU</b> Menu button .....	2, 4, 54, 65, 70, 73
 Delete button .....	2, 30, 72,  54
 Flash mode .....	45
 Self timer .....	47
 Macro mode .....	49
 Exposure compensation .....	50
<b>AE/AF-L</b> .....	 4
<b>A</b>	
AC adapter .....	75,  79
Adding favorite pictures .....	66,  5
AF area mode .....	54,  37
AF assist .....	74,  66
Album .....	 8
Aperture value .....	27
Audio video cable .....	76,  19,  79
Auto flash .....	46
Auto mode .....	42
Auto off .....	21, 74,  67
Auto sort mode .....	 9
Auto with red-eye reduction .....	46
Autofocus .....	54, 70,  41,  57
Autofocus mode .....	54, 70,  41,  57
AVI .....	 78
<b>B</b>	
Backlighting  .....	36
Battery .....	10, 12, 18
Battery chamber .....	 79
Battery charger .....	13,  79
Battery latch .....	10
Battery level .....	20

Refer to the *Reference Manual* for pages indicated with .









































Battery-chamber/memory card slot cover .....	2, 11, 14
Beach 	33
Best Shot Selector.....	35, 
Black and white copy 	35
Black-and-white.....	 36
Blink proof.....	55, 
Blink warning.....	74, 
Brightness.....	 61
BSS.....	35, 
Built-in microphone .....	1
Button sound.....	 67
<b>C</b>	
Calendar Display.....	64
Center.....	62, 
Charge by computer .....	74, 
Charge lamp.....	2, 13, 
Charging AC Adapter.....	12
Close-up 	35
Cloudy.....	 30
Color options.....	54, 
Compression ratio .....	 28
Computer.....	76, 80
Connector cover.....	2
Continuous.....	54, 
Copying images.....	65, 
Crop.....	63, 
Cross process 	39

Cyanotype.....	 36
<b>D</b>	
Date and time .....	17, 
Date format.....	17, 
Daylight.....	 30
Daylight saving time.....	17, 18, 
Delete.....	30, 72, 
Digital zoom.....	25, 74, 
Direct print .....	76, 
D-Lighting.....	65, 
DPOF.....	 45
DPOF printing .....	 27
DSCN.....	 78
Dusk/dawn 	33
<b>E</b>	
Editing images.....	 11
EH-70P.....	 19
Electronic VR .....	 64
EN-EL19.....	 19
Exposure compensation.....	50
Extension.....	 78
Eye-Fi upload.....	74, 
Eyelet for camera strap.....	1
<b>E</b>	
Face detection.....	58
Face priority.....	 37
Favorite pictures mode.....	 5
File names.....	 78



































Refer to the *Reference Manual* for pages indicated with .

Fill flash.....	46
Fireworks show 	35
Firmware version.....	74,  73
Fixed range auto.....	 35
Flash.....	45
Flash lamp.....	2, 45
Flash mode.....	45, 46
Flash off.....	46
Fluorescent.....	 30
Focus.....	26, 54, 58,  37
Focus area.....	26, 58
Focus indicator.....	7, 26
Focus lock.....	62
Food 	35
Format internal memory.....	74,  68
Format memory cards.....	15, 74,  68
Formatting.....	15, 74,  68
FSCN.....	 78
Full-frame playback.....	28, 63, 64
Full-time AF.....	54, 70,  41,  57
Functions that cannot be used simultaneously.....	56
<b>G</b>	
Glamour retouch.....	65,  15
<b>H</b>	
Help.....	33
High key 	38
High-contrast monochrome 	38
<b>I</b>	
Identifier.....	 78
Image mode.....	54,  28,  29
Image review.....	 61
Image size.....	54,  28
Imprinting date and time.....	73,  63
Incandescent.....	 30
Internal memory.....	15
Internal memory indicator.....	7, 20
ISO sensitivity.....	54,  35
<b>J</b>	
JPG.....	 78
<b>L</b>	
Landscape 	33
Language.....	74,  69
Lens.....	1,  16
Lens cover.....	1
List by date mode.....	 10
Low key 	38
<b>M</b>	
Macro mode.....	49
Manual.....	 38
Memory card.....	14,  20
Memory card slot.....	14
Monitor.....	2, 6,  6
Monitor settings.....	73,  61
Motion detection.....	73,  65
Movie length.....	67, 68

Refer to the *Reference Manual* for pages indicated with .





Movie menu .....	70,  56	Playback menu .....	65,  45
Movie options .....	70,  56	Playback mode .....	28
Movie playback .....	71	Playback zoom .....	63
Movie recording .....	67	Pop <b>POP</b> .....	38
Multi selector .....	2	Portrait  .....	33
Multi-shot 16 .....	 33	Power .....	16, 20
Museum  .....	35	Power switch .....	1, 20
<b>N</b>		Power-on lamp .....	1, 20
Night landscape  .....	34	Preset manual .....	 31
Night portrait  .....	33	Pressing halfway .....	27
Nikon Transfer 2 .....	79, 81	Print .....	65, 76,  23,  25,  45
Nostalgic sepia <b>SE</b> .....	38	Print date .....	18, 73,  46,  48,  63
Number of exposures remaining .....	20,  29	Print order .....	65,  45
<b>O</b>		Printer .....	76,  20
Optical zoom .....	25	Protect .....	65,  50
Optional accessories .....	 79	<b>Q</b>	
<b>P</b>		Quick effects .....	43, 54,  12,  41
Painting  .....	38	Quick retouch .....	65,  13
Panorama assist  .....	36,  2	<b>R</b>	
Panorama Maker .....	36,  4	Rechargeable Li-ion battery .....	 : 19
Paper size .....	 24,  25	Red-eye correction .....	 14
Party/indoor  .....	34	Removing favorite pictures .....	66,  7
Pet portrait auto release .....	37	Reset all .....	74,  73
Pet portrait  .....	37	Rotate image .....	65,  52
Photo info .....	 61	RSCN .....	 78
PictBridge .....	76,  20,  45	<b>S</b>	
Playback .....	28, 71,  53	Scene auto selector .....	32

Refer to the *Reference Manual* for pages indicated with .

Scene mode .....	33, 34
Selective color  .....	38
Self-timer .....	47
Self-timer lamp .....	1, 41, 48
Sepia .....	 36
Setup menu .....	73,  58
Shooting .....	22, 24, 26
Shooting menu .....	54,  28
Shooting mode .....	22
Shutter sound .....	 67
Shutter speed .....	27
Shutter-release button .....	1, 26
Single .....	54,  33
Single AF .....	54, 70,  41,  57
Skin softening .....	55, 59,  42
Slide show .....	65,  49
Slow sync .....	46
Small picture .....	65,  17
Smart portrait menu .....	41,  42
Smart portrait mode .....	40
Smile timer .....	55,  43
Snow  .....	33
Soft <b>SO</b> .....	38
Sound settings .....	74,  67
Speaker .....	2
Special effects mode .....	38
Sports  .....	34
SSCN .....	 78
Standard color .....	54,  36
Strap .....	3
Subject tracking .....	 38,  40
Sunset  .....	33
Super vivid <b>VI</b> .....	38
<b>I</b>	
Target finding AF .....	54, 60,  39
Telephoto .....	25
Televisions .....	76,  19
Thumbnail display .....	64
Time difference .....	 59
Time zone .....	17,  59
Time zone and date .....	73,  59
Toy camera effect 1  1 .....	39
Toy camera effect 2  2 .....	39
Tripod socket .....	2,  18
<b>U</b>	
USB cable .....	12, 80,  21
USB/audio/video output connector .....	2, 75
<b>V</b>	
Video mode .....	74,  69
Video-in jack/audio-in jack .....	 19
ViewNX 2 .....	77
Vivid color .....	 36
Voice memo .....	65,  53
Volume .....	71,  53

Refer to the *Reference Manual* for pages indicated with .

## W

WAV .....		78
Welcome screen .....	73, 	58
White balance .....	54, 	30
Wide-angle.....		25
Wind noise reduction.....	7, 70, 	57

## Z

Zoom control .....	1, 25, 71
Zooming in/out .....	25

No reproduction in any form of this manual, in whole or in part (except for brief quotation in critical articles or reviews), may be made without written authorization from NIKON CORPORATION.

Please visit the Nikon website below to download the *Reference Manual* in English.

संदर्भ मैन्युअल को हिंदी में डाउनलोड करने के लिए नीचे दी गई Nikon वेबसाइट पर जाएँ।

अनुग्रह करे वांग्वाय रेफारेन्स पुस्तिका डाउनलोड करतते निचे Nikon वेबसाइट पर यान।

தமிழில் சரிபார்ப்புக் கையேட்டைப் பதிவிறக்குவதற்கு, தயவுசெய்து கீழுள்ள Nikon வலைத்தளத்துக்குச் செல்லவும்.

मराठीत संदर्भ सूचना-पुस्तिका डाउनलोड करण्यासाठी कृपया खालील Nikon वेबसाईटला भेट द्या.

తెలుగులో అన్వయ మార్గదర్శక పుస్తకం డౌన్లోడ్ చేసుకునేందుకు దయచేసి Nikon వెబ్సైట్ సందర్శించండి.

<http://nikonimglib.com/manual/>