

Nikon

DIGITAL CAMERA

COOLPIX P950

Reference Manual



Table of contents

- Read this manual thoroughly before using the camera.
- To ensure proper use of the camera, be sure to read “[➔For your safety \(page 12\)](#)”.
- Be sure to read “[➔Do not point the lens at the sun \(page 286\)](#)” in “[➔Caring for the product \(page 286\)](#)”.
- If this is your first time using the camera, see “[➔Getting started \(page 36\)](#)” and “[➔Basic operations of shooting and playback \(page 47\)](#)”.
- After reading this manual, keep it in a readily accessible place for future reference.

En

Types of manuals

The following manuals are available for this camera.

Manual	Description
Reference Manual (this manual)	Explains details about using the camera.
Online Manual	You can view the Reference Manual content online. https://onlinemanual.nikonimglib.com/p950/en/
SnapBridge Online Help	Explains details about using the app for smart devices, "SnapBridge". https://nikonimglib.com/snbr/onlinehelp/en/index.html
Quick Start Guide	A manual included with the camera. Explains preparation for shooting and basic operations.



Table of contents

Introduction	8
Read this first	9
For your safety	12

Parts of the camera	16
The camera body	17
Principle functions of the controls	20
The monitor/viewfinder	25
Switching the information displayed on the screen (DISP button)	32
Power-on lamp (charge lamp)	34

Getting started	36
Attaching the strap	37
Attaching/removing the lens cap and lens hood	38
Inserting the battery and memory card	39
Charging the battery	41
Opening the monitor	43
Camera setup	44

Basic operations of shooting and playback	47
Shooting still images	48
Recording movies	53
Switching between the monitor and viewfinder	54
Playing back images	55
Deleting images	57

Shooting features	60
Selecting a shooting mode (mode dial)	61
Auto mode (standard shooting)	62
P, S, A, and M modes	63
Shooting with the Bulb setting or Time setting (when in M mode)	69
U (user settings) mode	71
Creative mode (applying effects when shooting)	75
Scene mode (shooting suited to the shooting conditions)	78
Bird-watching	79
Moon	80
Portrait	81



Landscape	81
Sports	82
Night portrait	83
Party/indoor	83
Beach	84
Snow	84
Sunset	84
Dusk/dawn	85
Night landscape	85
Close-up	86
Food	87
Fireworks show	88
Backlighting	88
Easy panorama	89
Pet portrait	92
Selective color	93
Multiple exp. Lighten	94
Setting the flash mode, self-timer, focus mode, and exposure compensation	98
Flash mode	99
Self-timer	102
Smile timer	104
Using autofocus	106
Using manual focus	113
Exposure compensation	117
Default settings (flash, self-timer, and focus mode)	119
Using the FN (function) button	121
Using the zoom	124
Functions that cannot be used simultaneously when shooting	127
<hr/>	
Playback features	131
Playback zoom	132
Crop	134
Thumbnail playback/calendar display	136
Viewing and deleting images in a sequence	138
Playback with easy panorama	140
Editing images (still images)	142
Printing still images	143
<hr/>	
Movies	144
Basic operations of movie recording and movie playback	145
Capturing still images while recording movies	149
Movie manual	150



Time-lapse movie	153
Operations during movie playback	156
Editing movies	158
<hr/>	
Using the menu	161
Menu operations	162
Menu lists	166
The shooting menu (common across shooting modes)	174
Image quality	174
Image size	175
The shooting menu (P , S , A , M , or U mode)	177
Picture Control	177
Custom Picture Control	180
White balance	181
Metering	184
Continuous	185
ISO sensitivity	189
Exposure bracketing	190
AF area mode	191
Autofocus mode	196
Flash exp. comp.	196
Noise reduction filter	197
Long exposure NR	197
Active D-Lighting	197
Multiple exposure	198
Zoom memory	200
Startup zoom position	201
M exposure preview	201
The Movie manual mode menu	203
The movie menu	204
Movie options	204
Autofocus mode	206
Electronic VR	207
Wind noise reduction	208
Zoom microphone	208
Frame rate	209
External mic sensitivity	209
The playback menu	211
Mark for upload	211
Quick retouch	212
D-Lighting	213
Skin softening	213



Filter effects	214
Slide show	216
Protect	218
Rotate image	218
Small picture	220
Sequence display	221
Key picture selection	222
The network menu	223
The setup menu	227
Time zone and date	227
Slot empty release lock	229
Monitor settings	229
EVF auto toggle	232
Date stamp	232
Self-timer: after release	233
Vibration reduction	234
AF assist	235
Digital zoom	235
Assign side zoom control	236
Snap-back zoom	236
Assign side dial	236
AE/AF lock button	237
Sound settings	238
Auto off	238
Format card	239
Language	239
HDMI	239
Charge by computer	241
Image comment	241
Copyright information	242
Location data	243
Toggle Av/Tv selection	244
Reset file numbering	244
Peaking	245
Reset all	245
Conformity marking	246
Firmware version	246

Connecting the camera to a TV or computer	247
Viewing images on a TV	248
Transferring images to a computer	250



Accessories	255
List of accessories	256
EH-5d AC Adapter and EP-5C Power Connector	259
Speedlights (external flash units)	260
ML-L7 Remote Control	262

If there is a problem	267
Troubleshooting	268
Error messages	281

Technical notes	284
Notes about wireless communication functions	285
Caring for the product	286
Cleaning and storage	291
File names	292
Specifications	293
Trademarks	300
Index.....	302



Introduction



Read this first	9
For your safety	12



Read this first

Descriptions in this manual

- Symbols

Symbol	Description
	This icon marks cautions and information that should be read before using the camera.
	This icon marks notes and information that should be read before using the camera.
	This icon marks other pages containing relevant information.

- SD, SDHC, and SDXC memory cards are referred to as “memory cards” in this manual.
- Smartphones and tablets are referred to as “smart devices.”
- The setting at the time of purchase is referred to as the “default setting.”
- The names of menu items displayed on the camera screen, and the names of buttons or messages displayed on a computer screen are enclosed in [] (brackets).
- Images are sometimes omitted from screen display samples so that screen indicators can be more clearly shown.

Information and precautions

Life-long learning

As part of Nikon’s “Life-long learning” commitment to ongoing product support and education, continually updated information is available online at the following websites:

- For users in the U.S.A.: <https://www.nikonusa.com/>
- For users in Europe: <https://www.europe-nikon.com/support/>
- For users in Asia, Oceania, the Middle East, and Africa: <http://www.nikon-asia.com/>

Visit these websites to keep up-to-date with the latest product information, tips, answers to frequently asked questions (FAQs), and general advice on digital imaging and photography. Additional information may be available from the Nikon representative in your area. Visit the website below for contact information. <https://imaging.nikon.com/>



● Before taking important pictures

Before taking pictures on important occasions (such as at weddings or before taking the camera on a trip), take a test shot to ensure that the camera is functioning normally. Nikon will not be held liable for damages or lost profits that may result from product malfunction.

● Use only Nikon brand electronic accessories

Nikon COOLPIX cameras are designed to the highest standards and include complex electronic circuitry. Only Nikon brand electronic accessories (including battery chargers, batteries, AC adapters, and USB cables) certified by Nikon specifically for use with this Nikon digital camera are engineered and proven to operate within the operational and safety requirements of this electronic circuitry.

THE USE OF NON-NIKON ELECTRONIC ACCESSORIES COULD DAMAGE THE CAMERA AND MAY VOID YOUR NIKON WARRANTY.

A holographic seal that indicates an accessory as an authentic Nikon product is affixed to the dedicated rechargeable Li-ion battery.



The use of third-party rechargeable Li-ion batteries not bearing the Nikon holographic seal could interfere with normal operation of the camera or result in the batteries overheating, igniting, rupturing, or leaking.

For more information about Nikon brand accessories, contact a local authorized Nikon dealer.

● About the manuals

- No part of the manuals included with this product may be reproduced, transmitted, transcribed, stored in a retrieval system, or translated into any language in any form, by any means, without Nikon's prior written permission.
- Illustrations and screen content shown in this manual may differ from the actual product.
- Nikon reserves the right to change the specifications of the hardware and software described in these manuals at any time and without prior notice.
- Nikon will not be held liable for any damages resulting from the use of this product.
- While every effort was made to ensure that the information in these manuals is accurate and complete, we would appreciate it were you to bring any errors or omissions to the attention of the Nikon representative in your area (address provided separately).

● Comply with copyright notices

Under copyright law, photographs or recordings of copyrighted works made with the camera can not be used without the permission of the copyright holder. Exceptions apply to personal use, but note that even personal use may be restricted in the case of photographs or recordings of exhibits or live performances.



• Disposing of data storage devices

Please note that deleting images or formatting data storage devices such as memory cards does not completely erase the original image data. Deleted files can sometimes be recovered from discarded storage devices using commercially available software, potentially resulting in the malicious use of personal image data. Ensuring the privacy of such data is the user's responsibility.

Before discarding a data storage device or transferring ownership to another person, make sure to reset all of the camera's settings in the setup menu → **[Reset all]**. After resetting, erase all data in the device using commercial deletion software, or format the device in the setup menu → **[Format card]**, then completely refill it with images containing no private information (for example, images of empty sky). Care should be taken to avoid injury or damage to property when physically destroying memory cards.

• Conformity marking

Follow the procedure below to display the conformity markings that the camera complies with.

Press the **MENU** button → select **Y** (setup) → **OK** button → Conformity marking → **OK** button



For your safety

To prevent damage to property or injury to yourself or to others, read "For your safety" in its entirety before using this product.
Keep these safety instructions where all those who use this product will read them.



DANGER

Failure to observe the precautions marked with this icon carries a high risk of death or severe injury.



WARNING

Failure to observe the precautions marked with this icon could result in death or severe injury.



CAUTION

Failure to observe the precautions marked with this icon could result in injury or property damage.



WARNING

- **Do not use while walking or operating a vehicle.** Failure to observe this precaution could result in accidents or other injury.
- **Do not disassemble or modify this product. Do not touch internal parts that become exposed as the result of a fall or other accident.** Failure to observe these precautions could result in electric shock or other injury.
- **Should you notice any abnormalities such as the product producing smoke, heat, or unusual odors, immediately disconnect the battery or power source.** Continued operation could result in fire, burns or other injury.
- **Keep dry. Do not handle with wet hands. Do not handle the plug with wet hands.** Failure to observe these precautions could result in fire or electric shock.
- **Do not let your skin remain in prolonged contact with this product while it is on or plugged in.** Failure to observe this precaution could result in low-temperature burns.



- **Do not use this product in the presence of flammable dust or gas such as propane, gasoline or aerosols.** Failure to observe this precaution could result in explosion or fire.

- **Do not aim the flash at the operator of a motor vehicle.** Failure to observe this precaution could result in accidents.

- **Keep this product out of reach of children.** Failure to observe this precaution could result in injury or product malfunction. In addition, note that small parts constitute a choking hazard. Should a child swallow any part of this product, seek immediate medical attention.

- **Do not entangle, wrap or twist the straps around your neck.** Failure to observe this precaution could result in accidents.

- **Do not use batteries, chargers, AC adapters, or USB cables not specifically designated for use with this product. When using batteries, chargers, AC adapters, and USB cables designated for use with this product, do not:**
 - **Damage, modify, forcibly tug or bend the cords or cables, place them under heavy objects, or expose them to heat or flame.**
 - **Use travel converters or adapters designed to convert from one voltage to another or with DC-to-AC inverters.**

Failure to observe these precautions could result in fire or electric shock.

- **Do not handle the plug when charging the product or using the AC adapter during thunderstorms.** Failure to observe this precaution could result in electric shock.

- **Do not handle with bare hands in locations exposed to extremely high or low temperatures.** Failure to observe this precaution could result in burns or frostbite.



CAUTION

- **Do not leave the lens pointed at the sun or other strong light sources.** Light focused by the lens could cause fire or damage to product's internal parts. When shooting backlit subjects, keep the sun well out of the frame. Sunlight focused into the camera when the sun is close to the frame could cause fire.



- **Turn this product off when its use is prohibited. Disable wireless features when the use of wireless equipment is prohibited.** The radio-frequency emissions produced by this product could interfere with equipment onboard aircraft or in hospitals or other medical facilities.

- **Remove the battery and disconnect the AC adapter if this product will not be used for an extended period.** Failure to observe this precaution could result in fire or product malfunction.

- **Do not touch moving parts of the lens or other moving parts.** Failure to observe this precaution could result in injury.

- **Do not fire the flash in contact with or in close proximity to the skin or objects.** Failure to observe this precaution could result in burns or fire.

- **Do not raise the built-in flash when using a flash unit mounted on the camera accessory shoe.** Failure to observe this precaution could result in fire or product malfunction.

- **Do not leave the product where it will be exposed to extremely high temperatures, for an extended period such as in an enclosed automobile or in direct sunlight.** Failure to observe this precaution could result in fire or product malfunction.

- **Do not transport the camera with a tripod or similar accessory attached.** Failure to observe this precaution could result in injury or product malfunction.



DANGER for batteries

- **Do not mishandle batteries.** Failure to observe the following precautions could result in the batteries leaking, overheating, rupturing, or catching fire:
 - Use only rechargeable batteries approved for use in this product.
 - Do not expose batteries to flame or excessive heat.
 - Do not disassemble.
 - Do not short-circuit the terminals by touching them to necklaces, hairpins, or other metal objects.
 - Do not expose batteries or the products in which they are inserted to powerful physical shocks.
 - Do not step on batteries, pierce them with nails, or strike them with hammers.

- **Charge only as indicated.** Failure to observe this precaution could result in the batteries leaking, overheating, rupturing, or catching fire.



- **If battery liquid comes into contact with the eyes, rinse with plenty of clean water and seek immediate medical attention.** Delaying action could result in eye injuries.
-



WARNING for batteries

- **Keep batteries out of reach of children.** Should a child swallow a battery, seek immediate medical attention.
 - **Keep batteries out of reach of household pets and other animals.** The batteries could leak, overheat, rupture, or catch fire if bitten, chewed, or otherwise damaged by animals.
 - **Do not immerse batteries in water or expose to rain.** Failure to observe this precaution could result in fire or product malfunction. Immediately dry the product with a towel or similar object should it become wet.
 - **Discontinue use immediately should you notice any changes in the batteries, such as discoloration or deformation. Cease charging EN-EL20a rechargeable batteries if they do not charge in the specified period of time.** Failure to observe these precautions could result in the batteries leaking, overheating, rupturing, or catching fire.
 - **When batteries are no longer needed, insulate the terminals with tape.** Overheating, rupture, or fire may result should metal objects come into contact with the terminals.
 - **If battery liquid comes into contact with a person's skin or clothing, immediately rinse the affected area with plenty of clean water.** Failure to observe this precaution could result in skin irritation.
-





Parts of the camera

The camera body	17
Principle functions of the controls	20
The monitor/viewfinder	25
Switching the information displayed on the screen (DISP button)	32
Power-on lamp (charge lamp)	34

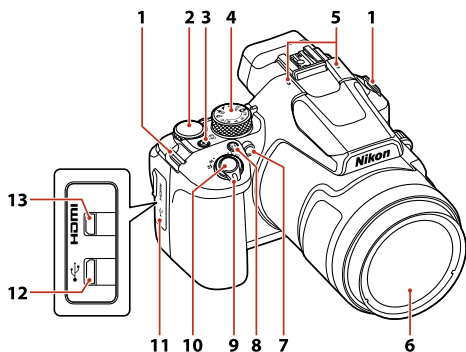

The camera body



<p>1 Eyelet for strap 37</p> <p>2 Command dial</p> <p>3 Power switch/power-on lamp (charge lamp) 34, 41, 44</p> <p>4 Mode dial 61</p> <p>5 Microphone (stereo) 145, 208</p> <p>6 Lens</p> <p>Self-timer lamp 102, 104</p> <p>7 Red-eye reduction lamp 101</p> <p>AF-assist illuminator 235</p> <p>8 Fn (function) button 121</p>	<p>Zoom control</p> <ul style="list-style-type: none"> • W: Wide-angle 124 • T: Telephoto 124 • : Thumbnail playback 136 • Q: Playback zoom 132 <p>9</p> <p>10 Shutter-release button 48, 108</p> <p>11 Connector cover 41, 248, 250</p> <p>12 Micro-USB connector 41, 250</p> <p>13 HDMI micro connector (Type D) 248</p>
--	---



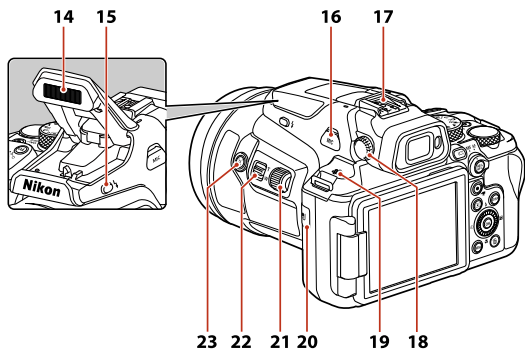

14	Built-in flash	52, 99	20	Accessory terminal	257
15	⚡ (flash pop-up) button	52, 99	21	Side dial	236
16	External microphone connector cover	257	22	Side zoom control • W : Wide-angle • T : Telephoto	125
17	Accessory shoe	256, 260	23	⏪ (snap-back zoom) button	126
18	Diopter adjustment control	54			
19	Speaker	156, 238			



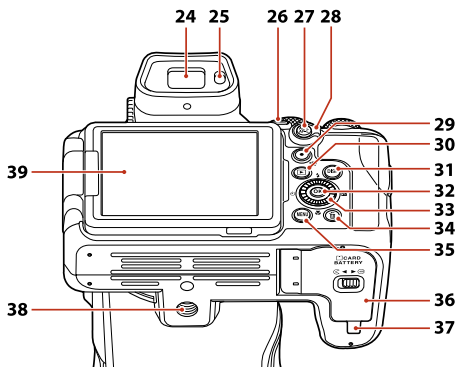









24	Electronic viewfinder	54	34	🗑️ (delete) button	57
25	Eye sensor	54	35	MENU (menu) button	162, 166
26	📺 (monitor) button	54	36	Battery-chamber/memory card slot cover	39
27	AE-L/AF-L (AE-L/AF-L) button	111, 237	37	Power connector cover (for optional AC adapter)	256
28	Focus-mode selector	106, 113	38	Tripod socket	
29	🎬 (movie-record) button	53, 145	39	Monitor	25, 43
30	▶️ (playback) button	55			
31	DISP (display) button	32			
32	Ⓞ (apply selection) button	162			
33	Rotary multi selector (multi selector) Pressing up, down, left, or right on the multi selector is expressed as ▲, ▼, ◀️, or ▶️.	98, 162			



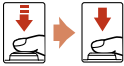

Principle functions of the controls

Control	Main function
 Mode dial	For shooting Select a shooting mode. ➔ Selecting a shooting mode (mode dial) (page 61)
 Focus-mode selector	For shooting Select AF (autofocus) or MF (manual focus). ➔ Using autofocus (page 106) ➔ Using manual focus (page 113)
 AE-L/AF-L button	For shooting Lock the exposure or focus. ➔ Focus lock (page 111) ➔ AE/AF lock button (page 237)
 Zoom control	For shooting Move toward T (🔍) (telephoto) to zoom in closer to the subject, and move toward W (📐) (wide-angle) to zoom out and view a larger area. ➔ Using the zoom control (page 124) For playback <ul style="list-style-type: none">• Move toward T (🔍) to zoom in on the image, and move toward W (📐) to display images as thumbnails or the calendar.➔ Playback zoom (page 132)➔ Thumbnail playback/calendar display (page 136)• Adjust the volume for movie playback.









Control	Main function
 <p>(Snap-back zoom) button</p>	<p>For shooting Widen the angle of view temporarily.</p> <p>➔ Using the snap-back zoom (temporarily widening the visible range) (page 126)</p>
 <p>Side zoom control</p>	<p>For shooting Move toward T (telephoto) to zoom in closer to the subject, and move toward W (wide-angle) to zoom out and view a larger area.</p> <p>➔ Using the side zoom control (page 125)</p>
 <p>Side dial</p>	<p>For shooting</p> <ul style="list-style-type: none"> • When the focus-mode selector is set to AF: Change the setting that is selected in [Assign side dial].* • When the focus-mode selector is set to MF: Adjust the focus manually. <p>* This function is not available with some shooting modes.</p> <p>➔ Assign side dial (page 236)</p>
 <p>Shutter-release button</p>	<p>For shooting When the button is pressed halfway: Set focus and exposure. When the button is pressed all the way: Release the shutter (start and stop movie recording in Movie manual mode).</p> <p>➔ Shooting still images (page 48)</p> <p>➔ The shutter-release button (page 108)</p> <hr/> <p>For playback Return to shooting mode.</p>
 <p>(Movie-record) button</p>	<p>For shooting Start and stop movie recording.</p> <p>➔ Recording movies (page 53)</p> <p>➔ Basic operations of movie recording and movie playback (page 145)</p> <hr/> <p>For playback Return to shooting mode.</p>





Control	Main function
 <p>Multi selector</p>	<p>For shooting</p> <ul style="list-style-type: none"> While the shooting screen is displayed: Display the following setting screens by pressing: <ul style="list-style-type: none"> Up (▲): ⚡ (flash mode) Right (▶): [Exposure Compensation Icon] (exposure compensation) Down (▼): [Focus Mode Icon] (focus mode) (Available only when the focus-mode selector is set to AF.) Left (◀): [Self-timer/Smile timer Icon] (self-timer/smile timer) ➔ Setting the flash mode, self-timer, focus mode, and exposure compensation (page 98) ➔ Menu operations (page 162) When the shooting mode is A, M, or [Movie manual Icon] (Movie manual): Rotate the multi selector to set the f-number. <hr/> <p>For playback</p> <ul style="list-style-type: none"> While the playback screen is displayed: Change the displayed image using up (▲), down (▼), left (◀), right (▶), or by rotating the multi selector. While a zoomed image is displayed: Move the display area. <hr/> <p>For setting</p> <p>Select an item using ▲▼◀▶ or by rotating the multi selector, and then apply the selection by pressing the [OK] button.</p>
 <p>[OK] (apply selection) button</p>	<p>For playback</p> <ul style="list-style-type: none"> Display individual images of a sequence in full-frame playback mode. <ul style="list-style-type: none"> ➔ Viewing and deleting images in a sequence (page 138) Scroll an image shot with easy panorama. Play back movies. Switch from thumbnail playback or zoomed image display to full-frame playback. <hr/> <p>For setting</p> <p>Apply the item that you selected by using the multi selector.</p> <ul style="list-style-type: none"> ➔ Menu operations (page 162)



Control	Main function
 <p>Command dial</p>	<p>For shooting</p> <ul style="list-style-type: none"> • When the shooting mode is P: Set the flexible program. • When the shooting mode is S, M, or [Manual] in  (Movie manual): Set the shutter speed. <p>➔ P, S, A, and M modes (page 63)</p> <hr/> <p>For playback Change the magnification rate of a zoomed image.</p>
 <p>MENU (menu) button</p>	<p>For shooting/playback Display or close the menu.</p> <p>➔ Menu operations (page 162)</p> <p>➔ Menu lists (page 166)</p>
 <p>Fn (function) button</p>	<p>For shooting When the shooting mode is P, S, A, M, or U: Display or close the setting menus such as [Continuous] or [Vibration reduction].</p> <p>➔ Using the Fn (function) button (page 121)</p>
 <p> ◻ (monitor) button</p>	<p>For shooting/playback Switch between the monitor and viewfinder.</p> <p>➔ Switching between the monitor and viewfinder (page 54)</p>
 <p>DISP (display) button</p>	<p>For shooting/playback Switch or hide the information displayed on the screen.</p> <p>➔ Switching the information displayed on the screen (DISP button) (page 32)</p>
 <p>▶ (playback) button</p>	<p>For shooting Play back images.</p> <p>➔ Playing back images (page 55)</p> <hr/> <p>For playback</p> <ul style="list-style-type: none"> • Return to shooting mode. • When the camera is turned off, press and hold down this button to turn the camera on in playback mode. <p>➔ Playing back images (page 55)</p>



Control	Main function
  (delete) button	For shooting Delete the last image that was saved. → Deleting images (page 57)
	For playback Delete images. → Deleting images (page 57)



The monitor/viewfinder

The information that is displayed on the screen changes depending on the camera's settings and state of use.

Shooting screen

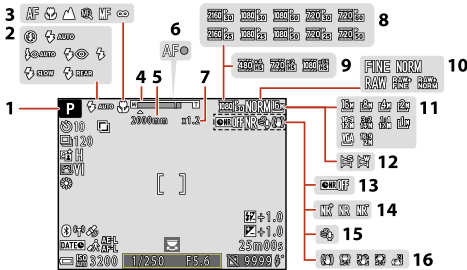

1	Shooting mode	61	10	Image quality	174
2	Flash mode	99	11	Image size	175
3	Focus mode	106, 113	12	Easy panorama	89
4	Zoom	107, 124	13	Long exposure NR (when [Off] is set)	197
5	Focal length (in 35mm [135] format)	124, 200	14	Noise reduction filter	197
6	Focus indicator	48	15	Wind noise reduction (during movie recording)	208
7	Digital zoom magnification	124	16	Vibration reduction	234
8	Movie options (normal speed movies)	204		Electronic VR	207
9	Movie options (HS movies)	205			



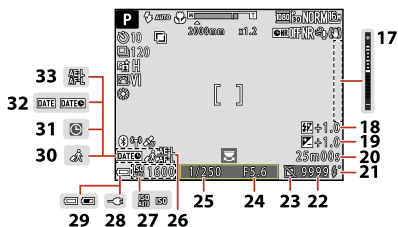

17	Exposure indicator66	25	Shutter speed63
18	Flash exposure compensation196	26	Auto exposure (AE)/Autofocus (AF) lock (still image)111, 237
19	Exposure compensation value117	27	ISO sensitivity189
20	Remaining movie recording time145, 147	28	Charging AC Adapter connection
21	Flash-ready indicator100	29	Battery level48
22	Number of exposures remaining (still images)48, 175	30	Travel destination227
23	Enable release (when no memory card is inserted)229	31	"Date not set"227, 270
24	F-number63	32	Date stamp232
		33	Auto exposure (AE)/Autofocus (AF) lock (during movie recording)146, 237



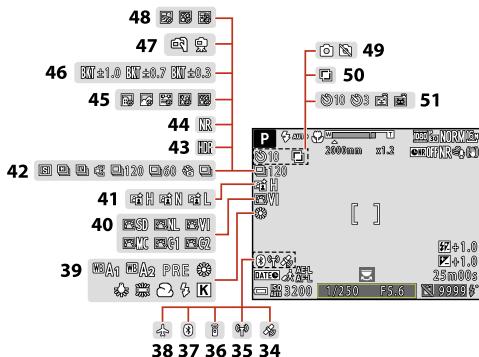

34	Location data	243	44	Noise reduction burst/single shot	81, 86
35	Wi-Fi communication	223	45	Time-lapse movie	153
36	Bluetooth remote control connected	265	46	Exposure bracketing	190
37	Bluetooth communication	223	47	Hand-held/tripod	83, 85
38	Airplane mode	223	48	Multiple exp. Lighten	94
39	White balance	181	49	Still image capture (during movie recording)	149
40	COOLPIX Picture Control	177	50	Multiple exposure	198
41	Active D-Lighting	197	51	Self-timer	102
42	Continuous shooting mode	79, 82, 92, 185		Smile timer	104
43	Backlighting (HDR)	88		Pet portrait auto release	92



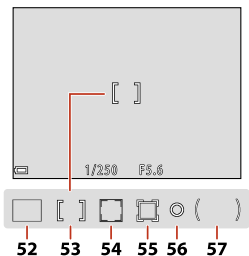

52	Focus area (target finding AF) 108, 191	55	Focus area (subject tracking) 191, 194
53	Focus area (center, manual) 79, 111, 191	56	Spot metering area 184
54	Focus area (face detection, pet detection) 92, 104, 110, 191	57	Center-weighted area 184

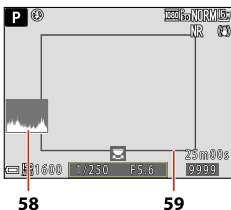

58	Histogram 229
59	Framing border ([Bird-watching] or [Moon] mode, or snap-back zoom) 79, 80, 126



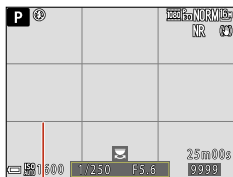

60

60 Framing grid229

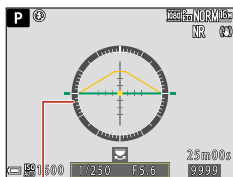

61

61 Virtual horizon229, 231



Playback screen

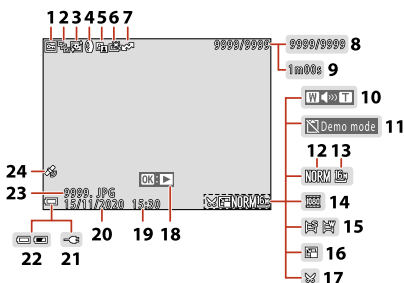

1	Protect	218	13	Image size	175
2	Sequence display (when [Individual pictures] is selected)	221	14	Movie options	204
3	Skin softening	213	15	Easy panorama	89
4	Filter effects	214	16	Small picture	220
5	D-Lighting	213	17	Cropped	134
6	Quick retouch	212		Easy panorama playback guide	140
7	Marked for upload	211	18	Sequence playback guide	138
8	Current image number/total number of images			Movie playback guide	145
9	Movie length or elapsed playback time		19	Time of recording	
10	Volume	156	20	Date of recording	
11	Enable release (when no memory card is inserted)	229	21	Charging AC Adapter connection	
12	Image quality	174	22	Battery level	48
			23	File number and type	292
			24	Recorded location data	243



Tone level information

You can check for loss of contrast detail in highlights and shadows from the histogram that is displayed, or the flashing display for each tone level. These provide guidelines when adjusting the image brightness with functions such as exposure compensation.

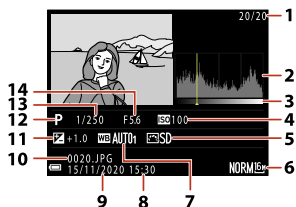

1	Current image number/total number of images	4	ISO sensitivity 189
2	Histogram <ul style="list-style-type: none"> A histogram is a graph showing the distribution of tones in the image. The horizontal axis corresponds to pixel brightness, with dark tones to the left and bright tones to the right. The vertical axis shows the number of pixels. 	5	COOLPIX Picture Control 177
3	Tone level <ul style="list-style-type: none"> The tone level indicates the brightness level. When the tone level to check is selected using the multi selector ◀▶ or rotating it, the area of the image that corresponds to the selected tone level flashes. 	6	Image quality/Image size 174, 175
		7	White balance 181
		8	Time of recording 44, 227
		9	Date of recording 44, 227
		10	File number and type 292
		11	Exposure compensation value 117
		12	Shooting mode 61
		13	Shutter speed 63
		14	F-number 63



Switching the information displayed on the screen (DISP button)

To switch the information displayed on the screen during shooting or playback, press the **DISP** (display) button. You can also hide the information.

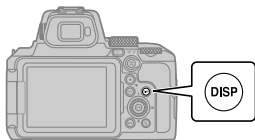

For shooting

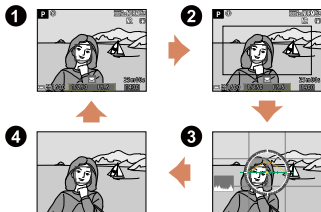

1: Show information¹

2: Movie frame¹

Display the range of a movie in a frame.

3: Display only the framing grid, histogram, and virtual horizon²

4: Hide information

- 1 The framing grid, histogram, and virtual horizon are displayed depending on the settings in the setup menu → **[Monitor settings (page 229)]**.
- 2 If the framing grid, histogram, and virtual horizon are not set to be displayed in the setup menu → **[Monitor settings (page 229)]**, this screen will not be displayed.



For playback

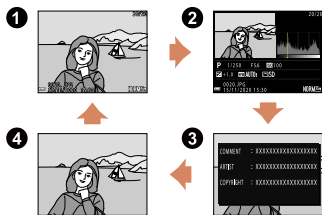

1: Show information

2: Tone level information (except movies)*

Display a histogram, tone level and shooting information.

→ Tone level information (page 31)

3: Image comment, copyright information*

→ Image comment (page 241), → Copyright information (page 242)

4: Hide information

* If images in a sequence are displayed individually and you press the **DISP** button, the information is displayed.

→ Viewing and deleting images in a sequence (page 138)

→ Sequence display (page 221)



Power-on lamp (charge lamp)

The power-on lamp (charge lamp) turns on or flashes in the following situations.

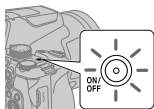

Status	Meaning
On	<ul style="list-style-type: none">• Turns on immediately after the camera is turned on. When the monitor is on, the power-on lamp turns off.• The camera is connected to a computer with the USB cable (when the setup menu → [Charge by computer] → [Off] is set, or when charging is complete with [Auto]).• The camera is connected to an HDMI-compatible device with the HDMI cable.• The electronic viewfinder is being used.• [Multiple exp. Lighten (page 94)] scene mode is set to [Star trails] and shooting is in progress.
Flashing	<ul style="list-style-type: none">• The camera is in standby mode because it has not been operated for about one minute.<ul style="list-style-type: none">→ The auto off function (page 51)• The battery is charging.<ul style="list-style-type: none">→ Charging the battery (page 41)→ Charge by computer (page 241)• [Intvl timer shooting] is in progress.<ul style="list-style-type: none">→ Interval timer shooting (page 188)• Movie recording is in progress while the camera is connected to an HDMI-compatible device (when the setup menu → [HDMI (page 239)] → [Clean HDMI output] → [On] is set).



Status	Meaning
Flashing quickly	<ul style="list-style-type: none"> • The battery cannot be charged. <ul style="list-style-type: none"> ➔ Charging the battery (page 41) ➔ When the power-on lamp (charge lamp) quickly flashes (page 241) ➔ The battery (page 287) • If [Battery exhausted.] is displayed on the screen, charge or replace the battery. • The inside of the camera or the battery has become hot. The camera turns off automatically. Wait until the camera or battery temperature has cooled before resuming use.



Getting started

Attaching the strap	37
Attaching/removing the lens cap and lens hood	38
Inserting the battery and memory card	39
Charging the battery	41
Opening the monitor	43
Camera setup	44



Attaching the strap

Attach the strap to the left and right side of the camera.

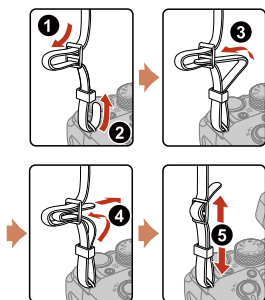

Attaching/removing the lens cap and lens hood

- When you are not shooting images, attach the lens cap to protect the lens.
- When the lens hood is attached, it cuts out light which adversely affects the image, and also helps protect the camera. Remove the lens hood when shooting with a flash or when the AF-assist illuminator is necessary for shooting.
- Turn off the camera before attaching/removing the lens hood. When attaching the lens hood, screw it in sufficiently without excessive force so that it will not fall off.

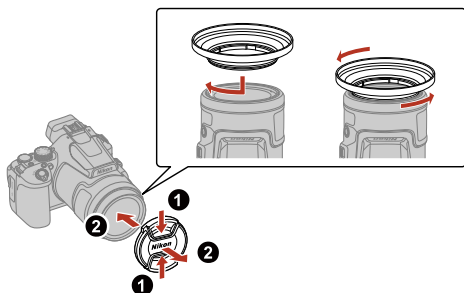

Inserting the battery and memory card

1 Open the battery-chamber/memory card slot cover.

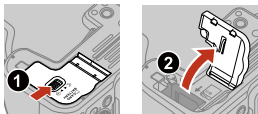

2 Insert the battery and memory card.

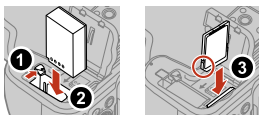

- With the battery's positive and negative terminals oriented correctly, move the orange battery latch (1), and fully insert the battery (2).
- Slide the memory card in until it clicks into place (3).
- Be careful not to insert the battery or memory card upside-down or backward, as this could cause a malfunction.
- If the write-protect switch of the memory card is locked, you cannot shoot, delete images, or format the memory card.

3 Close the battery-chamber/memory card slot cover.



Formatting a memory card

The first time you insert a memory card that has been used in another device into this camera, make sure to format it with this camera.



- **Note that formatting a memory card permanently deletes all images and other data on the memory card.**

Be sure to make copies of any images you wish to keep before formatting the memory card.

- Insert the memory card into the camera, press the **MENU** button, and select the setup menu → **[Format card]**.

Removing the battery or memory card

Turn the camera off and make sure that the power-on lamp and screen have turned off, and then open the battery-chamber/memory card slot cover.

- Move the orange battery latch to eject the battery.
- Gently push the memory card into the camera to partially eject the memory card.
- Be careful when handling the camera, battery, and memory card immediately after using the camera, as they may be hot.

Memory cards that can be used

The camera supports SD, SDHC, and SDXC memory cards.



- The camera supports UHS-I.
- Memory cards with an SD Speed Class rating of 6 (Video Speed Class V6) or faster are recommended for recording movies. When **[Movie options]** is set to **[2160/30p]** (4K UHD) or **[2160/25p]** (4K UHD), memory cards with a UHS Speed Class rating of 3 (Video Speed Class V30) or faster are recommended. Movie recording may stop unexpectedly when a memory card with a lower Speed Class rating is used.
- If you use a card reader, make sure that it is compatible with your memory card.
- Contact the manufacturer for information on features, operation, and limitations on use.



Charging the battery

- 1 Use the USB cable (included) to connect the Charging AC Adapter to the camera with the battery inserted.

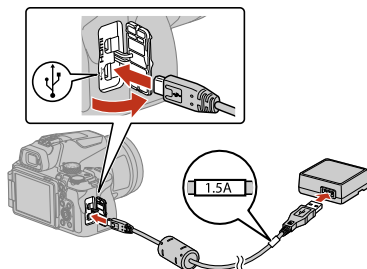

- 2 Insert the plug of the Charging AC Adapter into an electrical outlet.

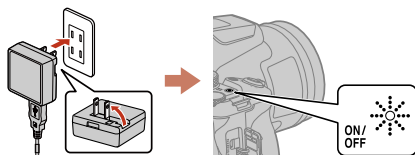

- A plug adapter is attached depending on the country or region of purchase. The shape of the plug adapter varies with the country or region of purchase.
- When charging starts, the power-on lamp (charge lamp) flashes. The charging time for a fully exhausted battery is about 3 hours.
- When charging is complete, the power-on lamp (charge lamp) turns off.
- The battery cannot be charged when the power-on lamp (charge lamp) quickly flashes, possibly due to one of the reasons described below.
 - The ambient temperature is not suited to charging.
 - The USB cable or Charging AC Adapter is not properly connected.
 - The battery is damaged.



3 When charging is complete, unplug the Charging AC Adapter from the electrical outlet, and disconnect the USB cable.

✔ Notes about the USB cable

- Do not use a USB cable other than the UC-E21. Using a USB cable other than the UC-E21 could result in overheating, fire, or electric shock.
- Check the shape and direction of the plugs and do not insert or remove the plugs at an angle.

✔ Notes about charging the battery

- Do not, under any circumstances, use another make or model of AC adapter other than the EH-73P/EH-73PCH Charging AC Adapter, and do not use a commercially available USB-AC adapter or a battery charger for a mobile phone. Failure to observe this precaution could result in overheating or in damage to the camera.
- If the camera is turned on while the battery is charging, charging stops.



Opening the monitor

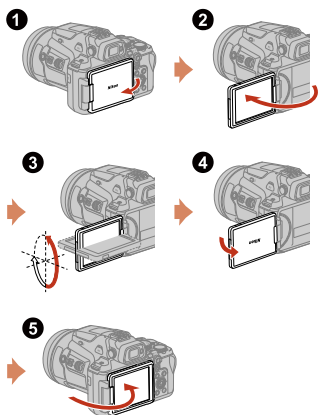

- You can adjust the direction and angle of the monitor. For normal shooting, fold the monitor against the back of the camera, facing out (5).
- When you are not using or carrying the camera, fold the monitor against the camera body with the screen facing in (1).

✓ Notes about the monitor

- The monitor's adjustable range may be limited when a cable or accessories are attached to the camera.
- When moving the monitor, do not apply excessive force and move slowly within the monitor's adjustable range so that the connection will not be damaged.



Camera setup

When the camera is turned on for the first time, screens to set the display language and camera clock are displayed.

Use the multi selector (1) and **OK** (apply selection) button (2) to select and adjust settings.

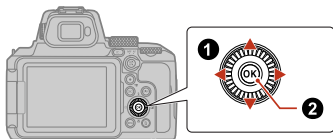

- 1 Press the power switch to turn on the camera.

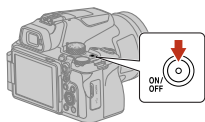

- 2 Press **▲▼** on the multi selector to highlight a language and press the **OK** button to select.

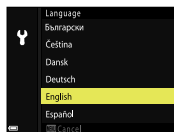

- The displayed languages vary depending on the country or region.



3 Select [Yes] and press the **OK** button.

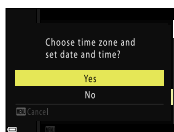

4 Highlight your home time zone and press the **OK** button.

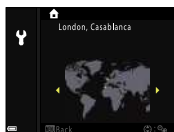

- To turn daylight saving time on, press ▲; ☀ will be displayed above the map. Press ▼ to turn daylight saving time off.

5 Press ▲▼ to select a date format and press the **OK** button.

6 Set the date and time.

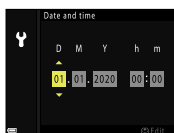

- Press ◀▶ to highlight items and ▲▼ to change them.
- Select the minute field and press the **OK** button to confirm the setting.

7 When prompted, press ▲▼ to highlight [Yes] and press the **OK** button.

- Setup is complete and the camera switches to the shooting screen.

Setting the language

The language can be set at any time in the **Y** setup menu → [Language].



To change the time zone and date setting

Set in the  setup menu → [Time zone and date].

In [Time zone and date] → [Time zone], the time is one hour earlier when daylight saving time is on, and goes back one hour when it is off.



Basic operations of shooting and playback

Shooting still images	48
Recording movies	53
Switching between the monitor and viewfinder	54
Playing back images	55
Deleting images	57



Shooting still images

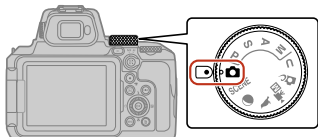

 (auto) mode is used here as an example.  (auto) mode enables you to perform general shooting in a variety of shooting conditions.

1 Rotate the mode dial to .

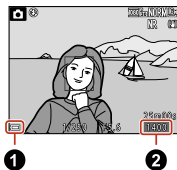

2 Check the battery level and number of exposures remaining on the shooting screen.



- Battery level (1)
 - : The battery level is high.
 - : The battery level is low.
- Number of exposures remaining (2)
- Press the **DISP** (display) button to switch the information displayed on the screen each time.



3 Hold the camera steady.

- Keep fingers and other objects away from the lens, flash, AF-assist illuminator, eye sensor, microphone, and speaker.

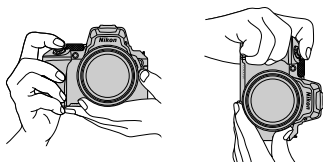

4 Frame the picture.

- Move the zoom control or the side zoom control to change the zoom lens position.
- To zoom in, move toward **T** (1).
- To zoom out, move toward **W** (2).
- If you lose sight of the subject while shooting with the lens in telephoto position, press the  (snap-back zoom) button (3) to temporarily widen the visible area so that you can frame the subject more easily.

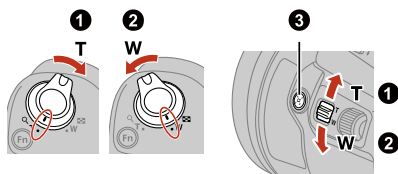

- See [➔ Using a tripod \(page 51\)](#) when using a tripod.



5 Press the shutter-release button halfway.

- To press the shutter-release button "halfway" means to press and hold the button at the point where you feel a slight resistance.

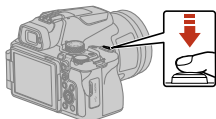

- When the subject is in focus, the focus area or focus indicator is displayed in green.

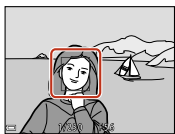

- When you are using digital zoom, the camera focuses in the center of the frame and the focus area is not displayed.
- If the focus area or focus indicator flashes, the camera is unable to focus. Modify the composition and try pressing the shutter-release button halfway again.

6 Without lifting your finger, press the shutter-release button all the way down.



✓ Notes about saving images or movies

The indicator showing the number of exposures remaining or the indicator showing the remaining recording time flashes, or **[Please wait for the camera to finish recording.]** is displayed while images or movies are being saved. **Do not open the battery-chamber/memory card slot cover or remove the battery or memory card while an indicator is flashing.** Doing this could result in loss of data, or in damage to the camera or the memory card.



Using a tripod

- We recommend using a tripod to stabilize the camera in the following situations:
 - When shooting in dim lighting and the flash is  (off)
 - When the zoom is at a telephoto position
- When using a tripod to stabilize the camera during shooting, select the setup menu → **[Vibration reduction]** → **[Off]** to prevent potential errors caused by this function.
- After attaching the camera to a tripod, make sure that the camera does not fall over when zooming the lens in or out.
Extend one leg of the tripod toward the subject and the other two legs toward you at an equal distance.
 - When zoom is at wide-angle position

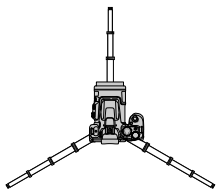

- When zoom is at telephoto position

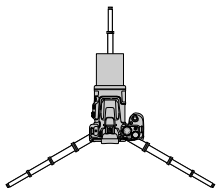

- The camera may move slightly when operated, even if it is attached to a tripod, which may interfere with the autofocus. Wait a few seconds after operating the camera, and then slowly press the shutter-release button.

The auto off function

- When no operations are performed for about one minute, the screen turns off, the camera enters standby mode, and then the power-on lamp flashes. The camera turns off after remaining in standby mode for about three minutes.
- To turn the screen back on while the camera is in standby mode, perform an operation such as pressing the power switch or shutter-release button.



Using the built-in flash

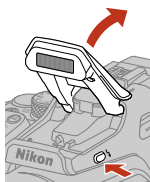

In situations where a flash is needed, such as in dark locations or when the subject is backlit, press the  (flash pop-up) button to raise the built-in flash.





- When not using the built-in flash, gently push to lower the built-in flash until it clicks shut.

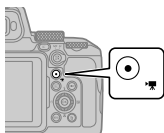

Recording movies

Display the shooting screen and press the **●** (▶ movie-record) button to start recording a movie. Press the **●** (▶) button again to end recording.



- When you rotate the mode dial to  (Movie manual), you can set the shutter speed and f-number for movie recording.
- For information about recording and playing back movies, see “[▶ Movies](#) (page 144)”.



Switching between the monitor and viewfinder

It is recommended that you use the viewfinder (❶) when bright conditions make it difficult to see the monitor, such as when outdoors in sunlight.

- When you bring your face close to the viewfinder, the eye sensor responds to it and the viewfinder turns on, and the monitor turns off (default setting).
- You can also press the  (monitor) button to switch the display between the monitor and viewfinder.

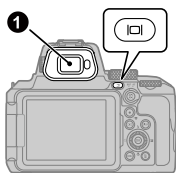

Diopter adjustment of the viewfinder

When the display in the viewfinder is difficult to see, adjust by rotating the diopter adjustment control (❶) while looking through the viewfinder.

- Take care not to scratch your eye with your fingertips or nails.

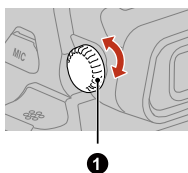

Playing back images



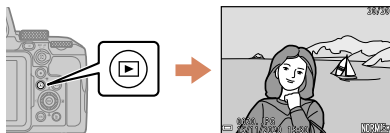







- 1 Press the  (playback) button to enter full-frame playback mode.



- If you press and hold down the  button while the camera is turned off, the camera turns on in playback mode.

- 2 Use the multi selector to select an image to display.



- Use the multi selector   to display the previous image, or   to display the next image.
- Press and hold down   to scroll through the images quickly.
- Images can also be selected by rotating the multi selector.
- Press the **DISP** (display) button to switch the information displayed on the screen each time.
- To play back a recorded movie, press the  button.
- To return to shooting mode, press the  button or shutter-release button.
- Move the zoom control toward **T** () in full-frame playback mode to zoom in on an image.
 - ➔ Playback zoom (page 132)
- In full-frame playback mode, move the zoom control toward **W** () to switch to thumbnail playback mode and display multiple images on the screen.
 - ➔ Thumbnail playback/calendar display (page 136)

Other playback methods

- Easy panorama
 - ➔ Playback with easy panorama (page 140)



- Sequence images
 - ➔ Viewing images in a sequence (page 138)
- Movies
 - ➔ Basic operations of movie recording and movie playback (page 145)
 - ➔ Operations during movie playback (page 156)



Deleting images

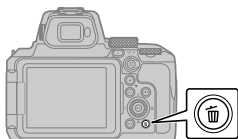

- 1 In playback mode, press the  (delete) button to delete the image currently displayed on the screen.



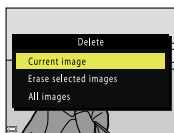

- 2 Use the multi selector   to select the desired deletion method and press the  button.

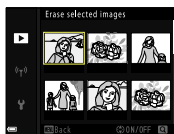

- If you selected [**Current image**] or [**All images**], proceed to step 6.
- To exit without deleting, press the **MENU** button.

- 3 Use the multi selector   or rotate it to select the image that you want to delete.



- Move the zoom control toward **T** () to switch to full-frame playback, or **W** () to switch to thumbnail playback.



4 Use ▲▼ to show or hide .



- Show  under images that you want to delete. Repeat steps 3 and 4 to select additional images.

5 Press the button to apply the image selection.

6 When the confirmation dialog is displayed, select [Yes] and press the button.



- Deleted images cannot be recovered.
- The message in the confirmation dialog varies depending on the selected deletion method.

Notes about deleting images simultaneously saved in RAW and JPEG



When using this camera to delete images captured using [RAW + Fine] or [RAW + Normal] in the [Image quality] setting, both of the simultaneously saved RAW and JPEG images are deleted. You cannot delete only one format.



Deleting images captured continuously (sequence)

- Images captured continuously are saved as a sequence, and only the first image of the sequence (the key picture) is displayed in playback mode (default setting).



- If you press the  button while a key picture is displayed for a sequence of images, all images in the sequence are deleted.
- To delete individual images in a sequence, press the  button to display them one at a time and press the  button.

Deleting the image captured while in shooting mode

When using shooting mode, press the  button to delete the last image that was saved.



Shooting features







Selecting a shooting mode (mode dial)	61
Auto mode (standard shooting)	62
P, S, A, and M modes	63
Shooting with the Bulb setting or Time setting (when in M mode)	69
U (user settings) mode	71
Creative mode (applying effects when shooting)	75
Scene mode (shooting suited to the shooting conditions)	78
Setting the flash mode, self-timer, focus mode, and exposure compensation	98
Flash mode	99
Self-timer	102
Smile timer	104
Using autofocus	106
Using manual focus	113
Exposure compensation	117
Default settings (flash, self-timer, and focus mode)	119
Using the Fn (function) button	121
Using the zoom	124
Functions that cannot be used simultaneously when shooting	127

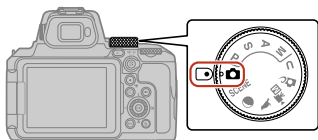

Selecting a shooting mode (mode dial)

You can rotate the mode dial to align the desired shooting mode with the indicator mark on the camera body.



Shooting mode	Description
 (Auto) mode	Select this mode to perform general shooting in a variety of shooting conditions.
P, S, A, and M modes	Select these modes for greater control over shutter speed and f-number.
U (User settings) mode	The frequently used settings in P, S, A, and M modes can be saved. To shoot with the saved settings, rotate the mode dial to U .
 (Creative) mode	Apply effects to images during shooting.
 (Movie manual) mode	You can record movies with the exposure mode set to aperture-priority auto or manual. Still images cannot be captured.
 ,  , and SCENE modes	Select any one of scene modes based on the shooting conditions, and you can take pictures with the appropriate settings for those conditions. <ul style="list-style-type: none"> (bird-watching): Use this mode when capturing images of birds in a telephoto position. (moon): Use this mode when capturing images of the moon in a telephoto position.SCENE (scene): Press the MENU button and select a scene mode.



Auto mode (standard shooting)



Select this mode to perform general shooting in a variety of shooting conditions.

- The camera detects the main subject and focuses on it (target finding AF). If a human face is detected, the camera automatically sets focus priority on it.
 - ➔ Using autofocus (page 106)

Functions available in (auto) mode

- Flash mode
 - ➔ Flash mode (page 99)
- Self-timer
 - ➔ Self-timer (page 102)
- Smile timer
 - ➔ Smile timer (page 104)
- Focus mode
 - ➔ Selecting the focus mode (page 106)
- Exposure compensation
 - ➔ Exposure compensation (page 117)
- Shooting menu
 - ➔ The shooting menu (common across shooting modes) (page 174)



P, S, A, and M modes

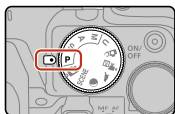

In **P**, **S**, **A**, and **M** modes, you can set exposure (combination of shutter speed and f-number) according to the shooting conditions. Also, you can achieve greater control when shooting images by setting the shooting menu options.

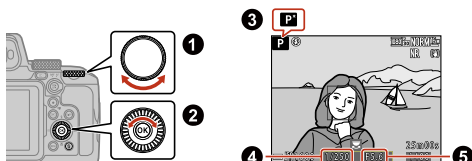

Shooting mode	Description
P Programmed auto	<p>You can let the camera adjust the shutter speed (4) and f-number (5).</p> <ul style="list-style-type: none">• The combination of shutter speed and f-number can be changed by rotating the command dial (1) (flexible program). While the flexible program is in effect, X (flexible program mark) is displayed on the upper left of the screen (3).• To cancel the flexible program, rotate the command dial in the opposite direction than when you set it until X is no longer displayed. It is also canceled if you change the shooting mode, turn off the camera, or raise or lower the built-in flash.
S Shutter-priority auto	<p>Rotate the command dial (1) to set the shutter speed (4). The camera automatically determines the f-number (5).</p>
A Aperture-priority auto	<p>Rotate the multi selector (2) to set the f-number (5). The camera automatically determines the shutter speed (4).</p>



Shooting mode	Description
M Manual	Set both the shutter speed (4) and f-number (5). Rotate the command dial (1) to set the shutter speed. Rotate the multi selector (2) to set the f-number. → Exposure indicator (when in M mode) (page 66) <ul style="list-style-type: none"> You can use the Bulb setting or Time setting to capture images with a long time-exposure.

- The allocations of the controls for setting the exposure can be changed in the setup menu → [Toggle Av/Tv selection (page 244)].

Tips for setting exposure

The sense of dynamism and amount of background defocus in subjects vary by changing the combinations of shutter speed and f-number even if the exposure is the same.

Effect of the shutter speed

The camera can make a fast-moving subject appear static at a fast shutter speed, or highlight the motion of a moving subject at a slow shutter speed.

- Faster
1/1000 s



- Slower
1/30 s



Effect of the f-number



The camera can blur the subject's background intentionally, or bring the subject, foreground, and background into focus.

- Small f-number (larger aperture)
f/2.8



- Large f-number (smaller aperture)
f/8



🔍 Shutter speed and f-number

- The control range of the shutter speed differs depending on the zoom position, f-number, or ISO sensitivity setting.
- The f-number of this camera also changes depending on the zoom position.
- When zooming is performed after the exposure is set, exposure combinations or the f-number may be changed.
- Large apertures (expressed by small f-numbers) let more light into the camera, and small apertures (large f-numbers) let less light. The smallest f-number represents the largest aperture, and the largest f-number represents the smallest aperture.
- The closer the lens is to the telephoto zoom position, the smaller the aperture range becomes.

🎬 Setting exposure when recording movies

When recording movies in **P**, **S**, **A**, **M**, or **U**, the shutter speed and f-number that you set are not applied. When the mode dial is rotated to  (Movie manual), you can set the exposure for movie recording.

📌 Notes about setting exposure

When the subject is too dark or too bright, it may not be possible to obtain the appropriate exposure. In such cases, the shutter speed indicator or f-number indicator flashes when the



shutter-release button is pressed halfway (except when the **M** mode is used). Change the shutter speed setting or f-number.

Exposure indicator (when in M mode)

The degree of deviation between the adjusted exposure value and the optimal exposure value measured by the camera is displayed in the exposure indicator on the screen. The degree of deviation in the exposure indicator is displayed in terms of EV (-2 to +2 EV in increments of 1/3 EV).



Functions available in P, S, A, and M modes

- Flash mode
 - ➔ Flash mode (page 99)
- Self-timer
 - ➔ Self-timer (page 102)
- Smile timer
 - ➔ Smile timer (page 104)
- Focus mode
 - ➔ Selecting the focus mode (page 106)
- Exposure compensation
 - ➔ Exposure compensation (page 117)
- Shooting menu
 - ➔ The shooting menu (common across shooting modes) (page 174), ➔ The shooting menu (**P**, **S**, **A**, **M**, or **U** mode) (page 177)
- Functions that can be set using the **Fn** button
 - ➔ Using the **Fn** (function) button (page 121)

Focus area

The focus area for autofocus varies depending on the setting in the shooting menu ➔ [**AF area mode (page 191)**]. When set to [**Target finding AF**] (default setting), the camera detects the main subject and focuses on it. If a human face is detected, the camera automatically sets focus priority on it.



The control range of the shutter speed (P, S, A, and M modes)

The control range of the shutter speed differs depending on the zoom position, f-number, or ISO sensitivity setting. Additionally, the control range changes in the following continuous shooting settings.

Setting	Control range (second)	
ISO sensitivity ¹	100-400	1/2000 ² -8 s (P or A mode) 1/4000 ^{2,3} -30 s (S mode) 1/4000 ^{2,3} -30 s (M mode) ⁴
	100-800	1/2000 ² -4 s (P or A mode) 1/4000 ^{2,3} -30 s (S mode) 1/4000 ^{2,3} -30 s (M mode) ⁴
	100-1600	1/2000 ² -2 s (P or A mode) 1/4000 ^{2,3} -30 s (S mode) 1/4000 ^{2,3} -30 s (M mode) ⁴
	100-3200	1/2000 ² -1 s (P or A mode) 1/4000 ^{2,3} -30 s (S or M mode)
	100-6400	1/2000 ² -1/2 s (P or A mode) 1/4000 ^{2,3} -15 s (S or M mode)
	100	1/2000 ² -30 s (P or A mode) 1/4000 ^{2,3} -30 s (S mode) 1/4000 ^{2,3} -30 s (M mode) ⁴
	200	1/2000 ² -15 s (P or A mode) 1/4000 ^{2,3} -30 s (S mode) 1/4000 ^{2,3} -30 s (M mode) ⁴
	400	1/2000 ² -8 s (P or A mode) 1/4000 ^{2,3} -30 s (S mode) 1/4000 ^{2,3} -30 s (M mode) ⁴
	800	1/2000 ² -4 s (P or A mode) 1/4000 ^{2,3} -30 s (S mode) 1/4000 ^{2,3} -30 s (M mode) ⁴



Setting		Control range (second)
ISO sensitivity ¹	1600	1/2000 ² –2 s (P or A mode) 1/4000 ^{2,3} –30 s (S mode) 1/4000 ^{2,3} –30 s (M mode) ⁴
	3200	1/2000 ² –1 s (P or A mode) 1/4000 ^{2,3} –30 s (S or M mode)
	6400	1/2000 ² –1/2 s (P or A mode) 1/4000 ^{2,3} –15 s (S or M mode)
Continuous	Continuous H, Continuous L	1/4000 ^{2,3} –1/30 s
	Pre-shooting cache, Continuous H: 120 fps	1/4000–1/125 s
	Continuous H: 60 fps	1/4000–1/60 s
	Intvl timer shooting	Same as when [Single] is set

- The ISO sensitivity setting is restricted depending on the continuous shooting setting.
→ Functions that cannot be used simultaneously when shooting (page 127)
- The maximum shutter speed when the f-number is set to the largest value (smallest aperture) at the maximum wide-angle zoom position. The closer the zoom position is to telephoto, or the smaller the f-number (larger aperture) is, the slower the maximum shutter speed becomes.
- The exposure may vary when the same subject is captured multiple times at a shutter speed in which the indicator is displayed in red (faster than 1/2000 second).



- Bulb setting and Time setting are available.
→ Shooting with the Bulb setting or Time setting (when in **M** mode) (page 69)



Shooting with the Bulb setting or Time setting (when in M mode)

Use the Bulb setting or Time setting to capture images with a long time-exposure, such as when taking pictures of fireworks, night landscapes, the night sky, or car light trails. The maximum exposure time for both the Bulb and Time setting is 60 seconds.

Option	Description
Bulb	The shutter remains open while the shutter-release button is pressed, and it closes when the button is released.
Time	The shutter opens when the shutter-release button is pressed all the way down, and it closes when the button is pressed all the way down again.

1 Stabilize the camera by using a tool such as a tripod.

- Select the setup menu → **[Vibration reduction]** → **[Off]**.
- See “ Using a tripod (page 51)” when using a tripod.

2 Rotate the mode dial to M.

- Set **[ISO sensitivity]** to **[100-400]**, **[100-800]**, **[100-1600]**, **[100]**, **[200]**, **[400]**, **[800]**, or **[1600]**.
- Set **[Continuous]** to **[Single]**.

3 Rotate the command dial to a slower speed until the shutter speed indicator displays **[Bulb]** or **[Time]**.



4 Press the shutter-release button after setting the focus.

- Bulb: Hold down the shutter-release button until the desired exposure time elapses.
- Time: Press the shutter-release button all the way down again when the desired exposure time elapses.
- When the exposure time reaches 60 seconds, the shutter automatically closes and shooting ends.



✔ Notes about shooting with the Bulb or Time setting

- The Bulb or Time setting cannot be used when **[ISO sensitivity]** is set to **[100-3200]**, **[100-6400]**, **[3200]**, or **[6400]**.
- The Bulb or Time setting cannot be used when a setting other than **[Single]** is selected for **[Continuous]**.

✔ Long time-exposures

- It may take longer for the camera to save images if a slow shutter speed is used when shooting.
 - It is recommended that you use a sufficiently charged battery or the EH-5d AC Adapter and the EP-5C Power Connector (both available separately) to prevent the camera from turning off unexpectedly.
- ➔ EH-5d AC Adapter and EP-5C Power Connector (page 259)



U (user settings) mode

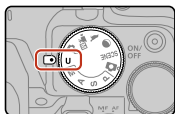

Setting combinations that are frequently used for shooting with **P** (programmed auto), **S** (shutter-priority auto), **A** (aperture-priority auto), or **M** (manual) can be saved in **U**.

Rotate the mode dial to **U** to retrieve the settings saved in [Save user settings].

- Frame the subject and shoot with these settings, or change the settings as required.

Saving settings in U mode (Save user settings)

The frequently used settings in **P**, **S**, **A**, and **M** modes can be saved. At the time of purchase, the default settings of **P** mode are saved.

1 Rotate the mode dial to **P**, **S**, **A**, **M**, or **U**.

- If you want to change the shooting mode, select **P**, **S**, **A**, or **M**.
- If you do not want to change the saved shooting mode, select **U**.

2 Change to a frequently used combination of shooting settings.

- See “ List of setting options that can be saved in **U** mode (page 72)” for details.
- The flexible program (when set to **P**), shutter speed (when set to **S** or **M**), or f-number (when set to **A** or **M**) settings will also be saved.
- The focus area that is selected with the [Manual (spot)], [Manual (normal)], or [Manual (wide)] setting in AF area mode will also be saved.

3 Press the MENU (menu) button to display the shooting menu.

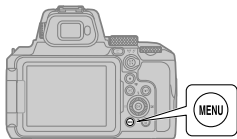

- 4 Use the multi selector ▲▼ to select [**Save user settings**], and press the  button.

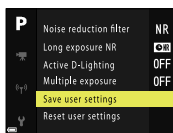

- The previous saved settings are overwritten by the current settings as the **U** mode.

Resetting **U** (user settings) mode

If the shooting menu → [**Reset user settings**] is selected, the settings that are saved in the user settings are restored to their default values.

Notes about the clock battery

If the internal clock battery is exhausted, the settings saved in **U** will be reset. Writing down any important setting is recommended.

List of setting options that can be saved in **U** mode

General settings

- Shooting modes **P**, **S**, **A**, and **M**
 - ➔ **P**, **S**, **A**, and **M** modes (page 63)
- Zoom position
 - ➔ Using the zoom (page 124)
- Flash mode
 - ➔ Flash mode (page 99)
- Self-timer
 - ➔ Self-timer (page 102)
- Focus mode
 - ➔ Selecting the focus mode (page 106)
- Exposure compensation
 - ➔ Exposure compensation (page 117)
- Fn button

You can also save menu options assigned to the **Fn1**/**Fn2** buttons of the ML-L7 Remote Control (available separately).

- ➔ Using the **Fn** (function) button (page 121)

Manual focus settings



- Distance to a subject, magnification rate, and peaking level
 - ➔ Using manual focus (page 113)

Display settings

- Monitor and viewfinder display
 - ➔ Switching between the monitor and viewfinder (page 54)
- Displayed information
 - ➔ The monitor/viewfinder (page 25)

Shooting menu

- Image quality
 - ➔ Image quality (page 174)
- Image size
 - ➔ Image size (page 175)
- Picture Control
 - ➔ Picture Control (page 177)
- Custom Picture Control
 - ➔ Custom Picture Control (page 180)
- White balance
 - ➔ White balance (page 181)
- Metering
 - ➔ Metering (page 184)
- Continuous
 - ➔ Continuous (page 185)
- ISO sensitivity
 - ➔ ISO sensitivity (page 189)
- Exposure bracketing
 - ➔ Exposure bracketing (page 190)
- AF area mode
 - ➔ AF area mode (page 191)
- Autofocus mode
 - ➔ Autofocus mode (page 196)
- Flash exp. comp.
 - ➔ Flash exp. comp. (page 196)
- Noise reduction filter
 - ➔ Noise reduction filter (page 197)
- Long exposure NR
 - ➔ Long exposure NR (page 197)
- Active D-Lighting
 - ➔ Active D-Lighting (page 197)
- Multiple exposure
 - ➔ Multiple exposure (page 198)



- Zoom memory
 - ➔ Zoom memory (page 200)
- Startup zoom position
 - ➔ Startup zoom position (page 201)
- M exposure preview
 - ➔ M exposure preview (page 201)

Setup menu

- Monitor settings
 - ➔ Monitor settings (page 229)



Creative mode (applying effects when shooting)

Apply effects to images during shooting.

- Five effect groups are available: **[Light]** (default setting), **[Depth]**, **[Memories]**, **[Classic]**, and **[Noir]**.

1 Rotate the mode dial to .

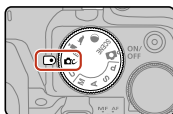



2 Press the  button.

- The effect selection screen is displayed.

3 Use the multi selector  to select an effect (1).



- The effect group (2) can be changed by rotating the command dial.
- To exit without saving the selection, press .

4 To adjust the effect, press .

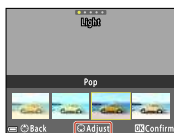

- If you do not want to adjust the effect, press the  button to proceed to step 7.



5 Use ◀▶ to highlight the desired option and then press ▼.

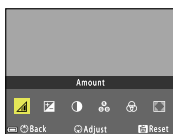

- Select [**Amount**], [**Exposure compensation**], [**Contrast**], [**Hue**], [**Saturation**], [**Filter**], or [**Peripheral illumination**]. The options that can be selected vary depending on the group.

6 Use ◀▶ to adjust the effect level and press the Ⓞ button.

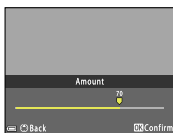

7 Press the shutter-release button or ● (▶ movie-record) button to shoot.

- When the camera detects the main subject, it focuses on the subject.
 - ➔ Using target finding AF (page 108)

🔪 Selecting an effect group and effect

You can also select an effect group and effect by pressing the **MENU** button when the screen in step 2 is displayed.

Functions available in creative mode

- Flash mode
 - ➔ Flash mode (page 99)
- Self-timer
 - ➔ Self-timer (page 102)
- Focus mode
 - ➔ Selecting the focus mode (page 106)
- Exposure compensation
 - ➔ Exposure compensation (page 117)



- Shooting menu
 - ➔ The shooting menu (common across shooting modes) (page 174)





Scene mode (shooting suited to the shooting conditions)

Select any one of scene modes based on the shooting conditions, and you can take pictures with the appropriate settings for those conditions.

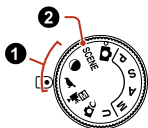
1 Rotate the mode dial to  (bird-watching), , or SCENE.



- If you select  or  (1), the camera switches to the shooting screen.
 - ➔ Bird-watching (page 79)
 - ➔ Moon (page 80)
- If you select SCENE (2), proceed to step 2.

2 Press the MENU button.

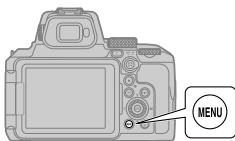

3 Use the multi selector to select a scene mode, and press the  button.

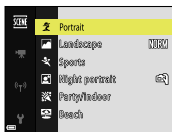

You can select from the following.





- ➔ Portrait (page 81)
- ➔ Landscape (page 81)
- ➔ Sports (page 82)
- ➔ Night portrait (page 83)
- ➔ Party/indoor (page 83)
- ➔ Beach (page 84)
- ➔ Snow (page 84)
- ➔ Sunset (page 84)
- ➔ Dusk/dawn (page 85)
- ➔ Night landscape (page 85)
- ➔ Close-up (page 86)
- ➔ Food (page 87)
- ➔ Fireworks show (page 88)
- ➔ Backlighting (page 88)
- ➔ Easy panorama (page 89)
- ➔ Pet portrait (page 92)
- ➔ Selective color (page 93)
- ➔ Multiple exp. Lighten (page 94)
- ➔ Time-lapse movie (page 153)

Bird-watching

Use when shooting birds staying still at a distance.

1 Rotate the mode dial to .

- To capture images continuously, press the **MENU** button and select **[Continuous]**.
 -  **[Single]** (default setting): One image is shot each time the shutter-release button is pressed.
 -  **[Continuous]**: While the shutter-release button is held all the way down, images are captured continuously. The camera can capture up to about 10 images continuously at a rate of about 7 fps.



2 Frame a bird in the framing border (1).

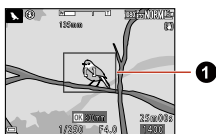

- At the wide-angle zoom position, the framing border is displayed to indicate the angle of view equivalent to that of a 500 mm lens (in 35mm [135] format) (default setting).
- You can change the angle of view for the framing border by pressing the **MENU** button and selecting **Focal length selection**.

3 Press the **OK** button.

- The camera zooms in so that the area inside the framing border takes up the entire angle of view (focal length). Use the zoom control or side zoom control to adjust the angle of view/zoom position according to the shooting conditions.
- The camera focuses on the area in the center of the frame. If you press the **MENU** button, you can set **AF area mode** to **Center (spot)** (default setting), **Center (normal)**, or **Center (wide)**. Set according to the size of the subject and the focus range.



4 Shoot.

The Bird-watching mode setting



The **Focal length selection**, **Continuous**, and **AF area mode** settings are saved in the camera's memory even after the camera is turned off.

Moon

Use this mode to shoot the moon.

- Use of a tripod is recommended ( Using a tripod (page 51)). When using a tripod to stabilize the camera during shooting, select the setup menu  **Vibration reduction**  **Off**.

1 Rotate the mode dial to .

- The default setting of the self-timer is [ **3s**] (3 seconds). To change the setting, press the multi selector  (.



2 Frame the moon in the framing border (1).

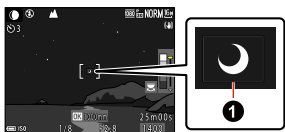

- At the wide-angle zoom position, the framing border is displayed to indicate the angle of view equivalent to that of a 1000 mm lens (in 35mm [135] format) (default setting).
- You can change the angle of view for the framing border by pressing the **MENU** button and selecting **[Focal length selection]**.

3 Press the **OK** button.

- The camera zooms in so that the area inside the framing border takes up the entire angle of view (focal length). Use the zoom control or side zoom control to adjust the angle of view/zoom position according to the shooting conditions.
- You can adjust hue by using the command dial.
- Adjust the brightness with exposure compensation according to shooting conditions such as the waxing and waning of the moon and shooting requirements.
➔ Exposure compensation (page 117)

4 Shoot.

- During autofocus, the camera focuses on the area in the center of the frame. The camera focuses at infinity.

The Moon mode setting

The **[Focal length selection]** and hue settings are saved in the camera's memory even after the camera is turned off.

Portrait

Use this mode to shoot portraits that emphasize human subjects.

Rotate the mode dial to **SCENE** → **MENU** button →  **Portrait** → **OK** button

Landscape

Use this mode to shoot landscapes.



Rotate the mode dial to SCENE → MENU button →  Landscape → 

Option	Description
Noise reduction burst	This enables you to shoot a sharp landscape with a minimum of noise.
Single shot (default setting)	Saves images with emphasized outlines and contrast.

1 Select [**Noise reduction burst**] or [**Single shot**].

2 Frame the subject and take a picture.

- The camera focuses on the area in the center of the frame. The position of the area cannot be moved.
- The camera focuses at infinity.
- For [**Noise reduction burst**]:
 - While the  icon on the shooting screen is displayed in green, press the shutter-release button all the way to capture a series of images which are combined into a single image and saved.
 - Once the shutter-release button is pressed all the way, hold the camera still until a still image is displayed. After taking a picture, do not turn the camera off before the screen switches to the shooting screen.
- For [**Single shot**]:
 - One image is captured when the shutter-release button is pressed all the way.

Notes about [Noise reduction burst]

- The angle of view (i.e., the area visible in the frame) seen in the saved image is narrower than that seen on the shooting screen.
- Continuous shooting may not be possible in certain shooting conditions.

Sports

While the shutter-release button is held all the way down, the camera shoots images continuously.

Rotate the mode dial to SCENE → MENU button →  Sports → 

- The camera can capture up to about 10 images continuously at a rate of about 7 fps.



- The camera focuses on the area in the center of the frame. The position of the area cannot be moved.



✔ Notes about [Sports]



- The frame rate for continuous shooting may become slow depending on the current image quality setting, image size setting, the memory card used, or shooting conditions.
 - ➔ Memory cards that can be used (page 40)
- Focus, exposure, and hue for the second and subsequent images are fixed at the values determined with the first image.

Night portrait

Use this mode to shoot evening and night portraits that include background scenery.

Rotate the mode dial to SCENE → MENU button →  Night portrait → 

Option	Description
 Hand-held (default setting)	Compared to using  [Tripod], the camera sets a slightly faster shutter speed in accordance with the shooting conditions to prevent camera shake.
 Tripod	Select when shooting with the camera stabilized on a tool such as a tripod.

- 1** Select  [Hand-held] or  [Tripod].
- 2** Raise the built-in flash.
- 3** Frame the subject and take a picture.
 - One image is captured at a slow shutter speed.

✔ Notes about [Tripod]

Vibration reduction is disabled regardless of the setup menu → [Vibration reduction] setting. See “➔ Using a tripod (page 51)” when using a tripod.

Party/indoor

Suitable for taking pictures at parties. Captures the effects of candlelight and other indoor background lighting.



Rotate the mode dial to SCENE → MENU button →  Party/indoor →  button

- The camera focuses on the area in the center of the frame. The position of the area cannot be moved.
- To avoid the effects of camera shake, hold the camera steady. When using a tripod to stabilize the camera during shooting, select the setup menu → **[Vibration reduction] → [Off]**. See “ Using a tripod (page 51)” when using a tripod.

Beach

Shoot bright and vivid seas, lakes, and beaches in daylight.

Rotate the mode dial to SCENE → MENU button →  Beach →  button

- The camera focuses on the area in the center of the frame. The position of the area cannot be moved.

Snow

Shoot bright and vivid snowscapes in daylight.

Rotate the mode dial to SCENE → MENU button →  Snow →  button

- The camera focuses on the area in the center of the frame. The position of the area cannot be moved.

Sunset

Use this mode to shoot sunsets and sunrises.

Rotate the mode dial to SCENE → MENU button →  Sunset →  button

- The camera focuses on the area in the center of the frame. The position of the area cannot be moved.
- The camera focuses at infinity.
- Use of a tripod is recommended ( Using a tripod (page 51)). When using a tripod to stabilize the camera during shooting, select the setup menu → **[Vibration reduction] → [Off]**.



Dusk/dawn

Use this mode to shoot landscapes with little natural light, such as before dawn or after sunset.



Rotate the mode dial to **SCENE** → **MENU button** →  **Dusk/dawn** → **OK** button

- The camera focuses on the area in the center of the frame. The position of the area cannot be moved.
- The camera focuses at infinity.
- Use of a tripod is recommended (👉 Using a tripod (page 51)). When using a tripod to stabilize the camera during shooting, select the setup menu → **[Vibration reduction]** → **[Off]**.

Night landscape

Use this mode to shoot night landscapes.

Rotate the mode dial to **SCENE** → **MENU button** →  **Night landscape** → **OK** button

Option	Description
 Hand-held (default setting)	Select when shooting with the camera in your hands instead of stabilizing it on a tool such as a tripod.
 Tripod	Select when shooting with the camera stabilized on a tool such as a tripod.

1 Select  **[Hand-held]** or  **[Tripod]**.



2 Frame the subject and take a picture.

- The camera focuses on the area in the center of the frame. The position of the area cannot be moved.
- The camera focuses at infinity.
- For **[Hand-held]**:
 - While the  icon on the shooting screen is displayed in green, press the shutter-release button all the way to capture a series of images which are combined into a single image and saved.
 - Once the shutter-release button is pressed all the way, hold the camera still until a still image is displayed. After taking a picture, do not turn the camera off before the screen switches to the shooting screen.
- For **[Tripod]**:
 - One image is captured at a slow shutter speed when the shutter-release button is pressed all the way.

✔ Notes about [Hand-held]

- The angle of view (i.e., the area visible in the frame) seen in the saved image is narrower than that seen on the shooting screen.
- Continuous shooting may not be possible in certain shooting conditions.

✔ Notes about [Tripod]

Vibration reduction is disabled regardless of the setup menu → **[Vibration reduction]** setting. See “ Using a tripod (page 51)” when using a tripod.

Close-up

Use when taking close-up pictures of small subjects such as flowers and insects.

Rotate the mode dial to SCENE → MENU button →  Close-up →  button

Option	Description
Noise reduction burst	This enables you to shoot a sharp image with a minimum of noise.
Single shot (default setting)	Saves images with emphasized outlines and contrast.

1 Select **[Noise reduction burst]** or **[Single shot]**.



2 Frame the subject and take a picture.

- The focus mode (Available focus modes (page 107)) setting is changed to **[Macro close-up]** and the camera automatically zooms to the closest position at which it can focus.
- You can move the focus area. Press the **OK** button, use the multi selector **▲▼◀▶** or rotate it to move the focus area, and press the **OK** button to apply the setting.
- For **[Noise reduction burst]**:
 - While the **🌿** icon on the shooting screen is displayed in green, press the shutter-release button all the way to capture a series of images which are combined into a single image and saved.
 - Once the shutter-release button is pressed all the way, hold the camera still until a still image is displayed. After taking a picture, do not turn the camera off before the screen switches to the shooting screen.
- For **[Single shot]**:
One image is captured when the shutter-release button is pressed all the way.

✔ Notes about [Noise reduction burst]

- If the subject moves or there is a significant camera shake during continuous shooting, the image may be distorted, overlapped, or blurred.
- The angle of view (i.e., the area visible in the frame) seen in the saved image is narrower than that seen on the shooting screen.
- Continuous shooting may not be possible in certain shooting conditions.

Food

Use this mode when taking pictures of food. You can also change the hue.

Rotate the mode dial to SCENE → MENU button → 🍴 Food → OK button

1 Adjust hue by using the command dial.



- The hue setting is saved in the camera's memory even after the camera is turned off.



2 Frame the subject and take a picture.

- The focus mode (➔ Available focus modes (page 107)) setting is changed to 🌱 **[Macro close-up]** and the camera automatically zooms to the closest position at which it can focus.
- You can move the focus area. Press the **OK** button, use the multi selector ▲▼◀▶ or rotate it to move the focus area, and press the **OK** button to apply the setting.

Fireworks show

The camera captures fireworks at a slow shutter speed.

Rotate the mode dial to SCENE ➔ MENU button ➔ 🎆 Fireworks show ➔ OK button

- The shutter speed is fixed at 4 seconds.
- It is recommended that you use manual focus.
➔ Using manual focus (page 113)
- Use of a tripod is recommended because the shutter speed is slow (➔ Using a tripod (page 51)). When using a tripod to stabilize the camera during shooting, select the setup menu ➔ **[Vibration reduction]** ➔ **[Off]**.

🗒 Notes about [Fireworks show]

Exposure compensation cannot be used.

Backlighting

Use this mode to shoot backlit subjects. Use when taking pictures with very bright and dark areas in the same frame.

Rotate the mode dial to SCENE ➔ MENU button ➔ 🌃 Backlighting ➔ OK button

Option	Description
On	High dynamic range (HDR) compositing is applied. Use when taking landscapes with very bright and dark areas in the same frame.
Off (default setting)	High dynamic range (HDR) compositing is not applied. The flash fires to prevent the subject from being hidden in shadow. Raise the built-in flash before shooting.

1 Select **[On]** or **[Off]** for high dynamic range (HDR) compositing.



2 Frame the subject and take a picture.

- The camera focuses on the area in the center of the frame. The position of the area cannot be moved.
- If **[On]** is set:
 - When there is a big difference between the bright and dark areas, the HDR icon on the shooting screen changes to green.
 - When the shutter-release button is pressed all the way, the camera shoots images continuously and saves the following two images.
 - A non-HDR composite image
 - An HDR composite image in which the loss of details in highlights or shadows is minimized
- If **[Off]** is set:
One image is captured when the shutter-release button is pressed all the way.

Notes about HDR

- The angle of view (i.e., the area visible in the frame) seen in the saved image is narrower than that seen on the shooting screen.
- After taking a picture, do not turn the camera off before the screen switches to the shooting screen.
- Use of a tripod is recommended (→ Using a tripod (page 51)). When using a tripod to stabilize the camera during shooting, select the setup menu → **[Vibration reduction]** → **[Off]**.
- During hand-held shooting, after pressing the shutter-release button all the way, hold the camera steadily so that it does not shake until the still image is displayed.
- Under some shooting conditions, dark shadows may appear around bright subjects or bright areas may appear around dark subjects.
- If there is only enough memory to save one image, an image processed by D-Lighting at the time of shooting, in which dark areas of the image are corrected, is the only image saved.

Easy panorama

Use this mode to shoot panorama images that can be played back on the camera. The camera captures several images and composites them into a panorama image.

Rotate the mode dial to SCENE → MENU button →  Easy panorama → 



-
- 1** Select **STD** [Normal (180°)] or **WIDE** [Wide (360°)] as the shooting range and press the **OK** button.

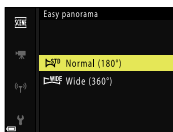

-
- 2** Frame the first edge of the panorama scene, and then press the shutter-release button halfway to focus.



- The zoom position is fixed at wide-angle.
- The camera focuses on the area in the center of the frame. The position of the area cannot be moved.

-
- 3** Press the shutter-release button all the way, and then remove your finger from the shutter-release button.

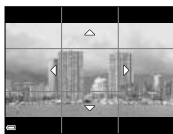

-     are displayed to indicate the direction of camera movement.



- 4 Move the camera in one of the four directions until the guide indicator (1) reaches the end.



- When the camera detects which direction it is moving in, shooting begins.
- Shooting ends when the camera captures the specified shooting range.
- Focus and exposure are locked until shooting ends.

Example of camera movement

- Using your body as the axis of rotation, move the camera slowly in an arc, in the direction of the marking (△▽◀▶).



- Shooting stops if the guide does not reach the edge within about 15 seconds (when **STANDARD [Normal (180°)]** is selected) or within about 30 seconds (when **WIDE [Wide (360°)]** is selected) after shooting starts.

Notes about easy panorama shooting

- The range of the image seen in the saved image is narrower than that seen on the screen at the time of shooting.
- If the camera is moved too quickly or shaken too much, or if the subject is too uniform (e.g. walls or darkness), an error may occur.
- If shooting is stopped before the camera reaches the half-way point in the panorama range, a panorama image is not saved.
- If more than half of the panorama range is captured but shooting ends before reaching the edge of the range, the range not captured is recorded and displayed in gray.

Image size of easy panorama

There are four different image sizes (in pixels), as described below.



- When  [Normal (180°)] is set

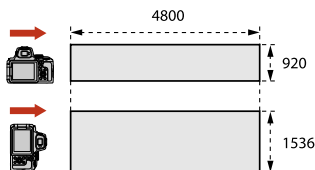

- When  [Wide (360°)] is set

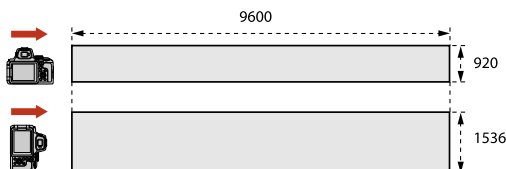



Easy panorama playback

See “ Playback with easy panorama (page 140)” for information about easy panorama playback.

Pet portrait

Use this mode when taking pictures of pets. When you point the camera at a dog or cat, the camera detects the face of a dog or cat and focuses on it. By default, the shutter is automatically released when the face of a dog or cat is detected (pet portrait auto release).

Rotate the mode dial to SCENE → MENU button →  Pet portrait → 

Option	Description
 Single	Whenever the face of a dog or cat is detected, the camera captures one image.
 Continuous (default setting)	Whenever the face of a dog or cat is detected, the camera captures three images continuously.





1 Select  [**Single**] or  [**Continuous**].

2 Point the camera at a dog or cat, and wait for the shutter to release automatically or press the shutter-release button.

 **[Pet portrait auto release]**

The following settings can be set when you press the multi selector  (☺).

-  **[Pet portrait auto release]**: The camera automatically releases the shutter when it detects the face of a dog or cat.
 - Pet portrait auto release is set to **[OFF]** after five bursts have been taken.
 - You can also release the shutter by pressing the shutter-release button. When  **[Continuous]** is selected, images are captured continuously while the shutter-release button is held all the way down.
- **[OFF]**: The camera releases the shutter when the shutter-release button is pressed all the way down.
 - The camera focuses on the face of a dog, cat, or human when detected.
 - When  **[Continuous]** is selected, images are captured continuously while the shutter-release button is held all the way down.

 **Focus area**

- When the camera detects a face, the face is displayed inside a yellow border. When the camera acquires focus on a face displayed inside a double border (focus area), the double border changes to green. If no faces are detected, the camera focuses on the area in the center of the frame.



- Under some shooting conditions, the face of a dog, cat, or human may not be detected and other subjects may be displayed inside a border.

Selective color

Keeps only a selected color and makes other colors black-and-white.



Rotate the mode dial to SCENE → MENU button →  Selective color → 

- 1 Use the command dial to select the desired color, and press the  button to apply the color.



- To change the color selection, press the  button again.



- 2 Frame the subject and take a picture.

- The camera focuses on the area in the center of the frame. The position of the area cannot be moved.

Multiple exp. Lighten

Light trails such as the flow of car lights or motion of stars are captured. The camera automatically captures moving subjects at regular intervals, compares each image and composites only their bright areas, and then saves them as one image.

Rotate the mode dial to SCENE → MENU button →  Multiple exp. Lighten → 

Option	Description
 Nightscape + light trails	Use to capture the flow of car lights against a night landscape background.
 Star trails	Use to capture the motion of stars.
 Fireworks	Use to capture fireworks.



1 Select [Nightscape + light trails], [Star trails], or [Fireworks].

- For [Nightscape + light trails]:
 - You can rotate the command dial to set the desired interval between the shots. The set interval becomes the shutter speed.



- Set the focus on the subject.
 - ➔ Focusing in [Nightscape + light trails] (page 96)
- For [Star trails]:
 - Set the focus on the subject.
 - ➔ Focusing in [Star trails] (page 96)
- For [Fireworks]:
 - You can rotate the command dial to set the desired interval between the shots. The set interval becomes the shutter speed.
 - You can rotate the multi selector to set the aperture.
 - Set the focus on the subject.
 - ➔ Focusing in [Fireworks] (page 96)

2 Press the shutter-release button to start shooting.

- The screen may turn off during the shooting interval. The power-on lamp turns on while the screen is off.





3 After capturing the desired composite image, press the button to end shooting.

- If you continue shooting, details in the composited areas may be lost.
- For **[Nightscape + light trails]**:
 - When 50 shots are taken, the camera automatically stops shooting.
 - For every 10 shots taken, one composite image with trails overlapped from the start of shooting is automatically saved.
- For **[Star trails]**:
 - Shots are taken at a shutter speed of 25 seconds, with an interval of approximately 5 seconds between the shots. When 300 shots are taken, the camera automatically stops shooting.
 - For every 30 shots taken, one composite image with trails overlapped from the start of shooting is automatically saved.
- For **[Fireworks]**:
 - When 30 shots are taken, the camera automatically stops shooting.
 - For every shot taken, one composite image is automatically saved.

Notes about [Multiple exp. Lighten]

- Use a sufficiently charged battery to prevent the camera from turning off unexpectedly.
- Do not rotate the mode dial or remove the memory card until shooting ends.
- Use of a tripod is recommended. When using a tripod to stabilize the camera during shooting, select the setup menu → **[Vibration reduction]** → **[Off]**. See “ Using a tripod (page 51)” when using a tripod.
- The auto off function is disabled during shooting.
- Exposure compensation cannot be used.

Focusing in [Nightscape + light trails]





- During autofocus, the camera focuses on the area in the center of the frame. You can set the focus mode to **AF [Autofocus]** (default setting) or  **[Infinity]**.
- When shooting distant subjects, it is recommended that you select  **[Infinity]** or use manual focus.

Focusing in [Star trails]

During autofocus, the setting is fixed to  **[Infinity]** and the focus area is not displayed. To adjust the focus, switch to manual focus.

 Using manual focus (page 113)

Focusing in [Fireworks]

- You can set the focus mode during autofocus to  **[Infinity]** (default setting) or  **[Infinity]**. The focus area is not displayed during  **[Infinity]**. During  **[Infinity]**, the camera focuses on the area in the center of the frame.



- To adjust the focus, switch to ▲ **[Infinity]** or manual focus.

➔ Available focus modes (page 107)



➔ Using manual focus (page 113)

🔪 **Time remaining**

You can check the time remaining until shooting automatically ends on the screen.



Setting the flash mode, self-timer, focus mode, and exposure compensation

When the shooting screen is displayed, you can press the multi selector  () to set the functions described below.

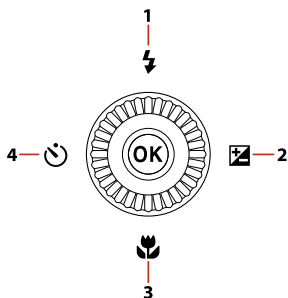

1 Flash mode

The flash mode can be set according to shooting conditions.

→ Flash mode (page 99)

2 Exposure compensation

You can adjust overall image brightness.

→ Exposure compensation (page 117)

3 Focus mode

When the focus-mode selector is set to **AF** (autofocus), you can specify the focus mode according to the distance to the subject.

→ Using autofocus (page 106)

4 Self-timer/Smile timer

The camera releases the shutter when the specified time elapses after you press the shutter-release button. If  **[Smile timer]** is set, the camera automatically releases the shutter whenever a smiling face is detected.

→ Self-timer (page 102)

→ Smile timer (page 104)

The functions that can be set vary depending on the shooting mode.



Flash mode

You can change the flash settings to match the shooting conditions.

- 1 Press the  (flash pop-up) button to raise the built-in flash.

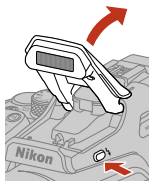

- When the built-in flash is lowered, flash operation is disabled and  is displayed on the shooting screen.
- Make sure that the built-in flash is lowered when using a Speedlight.

- 2 Press the multi selector  ()

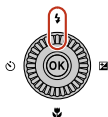



- 3 Select the desired flash mode and press the  button.



- For information about the types of flash modes, see "[Available flash modes](#) (page 100)".
- If the setting is not applied by pressing the  button, the selection will be canceled.









✔ The flash-ready indicator

While the built-in flash is charging,  flashes. The camera cannot shoot images. If charging is complete,  is displayed steadily when you press the shutter-release button halfway.



Available flash modes

Option	Description
 Auto	The flash fires when necessary, such as in dim lighting. <ul style="list-style-type: none">The flash mode indicator is only displayed immediately after setting on the shooting screen.
 Auto with red-eye reduction /  Red-eye reduction	Reduce red-eye in portraits caused by the flash. → [Auto with red-eye reduction]/[Red-eye reduction] (page 101) <ul style="list-style-type: none">When [Red-eye reduction] is selected, the flash fires whenever a picture is taken.
 Fill flash/Standard flash	The flash fires whenever a picture is taken.
 Slow sync	Suited to evening and night portraits that include background scenery. Fill flash fires to illuminate the main subject; slow shutter speeds are used to capture background at night or under dim lighting.
 Rear-curtain sync	Fill flash fires just before the shutter closes, creating the effect of a stream of light following moving subjects.

✔ Notes about shooting with the flash

When you use the flash at the wide-angle zoom position, the edge of the image may be dark depending on the shooting distance. This may be improved by adjusting the zoom slightly to a telephoto position.

✎ The flash mode setting

The available flash modes differ depending on the shooting mode.



Flash mode			SCENE, 		P ¹	S ¹	A ¹	M ¹
	Auto	✓	2	✓	–	–	–	–
	Auto with red-eye reduction	✓		✓	–	–	–	–
	Red-eye reduction	–		–	✓	✓	✓	✓
	Fill flash	✓		✓	–	–	–	–
	Standard flash	–		–	✓	✓	✓	✓
	Slow sync	✓		✓	✓	–	✓	–
	Rear-curtain sync	✓		✓	✓	✓	✓	✓

- 1 When shooting with [Auto with red-eye reduction] in (auto) mode, and when shooting mode **P**, **S**, **A**, or **M** is used, the applied setting is saved in the camera's memory even after the camera is turned off.
- 2 Availability depends on the setting.
 Default settings (flash, self-timer, and focus mode) (page 119)

[Auto with red-eye reduction]/[Red-eye reduction]

The red-eye reduction lamp glows before the main flash to reduce the red-eye effect. Note the following when shooting:

- Because the red-eye reduction lamp glows, more time than usual is required until the shutter is released after you press the shutter-release button.
- Red-eye reduction may not produce the desired results in some situations.

Using a Speedlight (external flash)

- The built-in flash does not fire when a Speedlight is attached. Make sure that the built-in flash is lowered.
- Turn the camera off when attaching and detaching a Speedlight.
- The mode names and function names of Speedlights may differ from those of the built-in flash.
- See " Speedlights (external flash units) (page 260)" and refer to the documentation provided with your Speedlight for more information.



Self-timer

The camera releases the shutter when the set number of seconds elapses after you press the shutter-release button.

1 Press the multi selector ◀ (⏻).

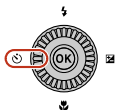

2 Select the number of seconds until the shutter is released, and press the OK button.



- [**10s**] (10 seconds): Use on important occasions such as weddings, or to prevent camera shake. This setting is recommended when shooting in a telephoto position with the camera attached to a tripod.
- [**3s**] (3 seconds): Use to prevent camera shake.
- If the setting is not applied by pressing the **OK** button, the selection will be canceled.

3 Frame the picture and press the shutter-release button halfway.

- Confirm that the subject is in focus.



4 Press the shutter-release button all the way down.

- The focus and exposure are locked, and countdown starts.



- The self-timer lamp flashes and then glows steadily about one second before the shutter is released.



- When the shutter is released, the self-timer is set to **[OFF]**.
When the shooting mode is Moon, the self-timer is not automatically set to **[OFF]**.
To end self-timer, select **[OFF]** in step 2.
- To stop the countdown, press the shutter-release button again.

✔ Notes about using a tripod during shooting

- When using a tripod to stabilize the camera during shooting, select the setup menu → **[Vibration reduction]** → **[Off]**. See “→ Using a tripod (page 51)” when using a tripod.
- The camera may move slightly when operated, even if it is attached to a tripod, which may interfere with the autofocus. Wait a few seconds after operating the camera, and then slowly press the shutter-release button.
- If it is difficult for the camera to focus using autofocus, try using manual focus.
→ Using manual focus (page 113)
- When using a remote control (available separately), you can release the shutter without pressing the shutter-release button on the camera.
→ **Remote control accessories** (page 257)

✔ The self-timer setting

- The setting may not be available with some shooting modes.
→ Default settings (flash, self-timer, and focus mode) (page 119)
- In the setup menu → **[Self-timer: after release]**, you can select whether to cancel the self-timer setting after shooting.



Smile timer

When the camera detects a smiling face, you can take a picture automatically without pressing the shutter-release button.

- This function can be used when the shooting mode is **☑** (auto), **P**, **S**, **A**, **M**, or **U**, or when the scene mode is [**Portrait**] or [**Night portrait**].

1 Press the multi selector ◀ (☺).

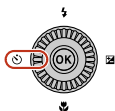

- Change any flash mode, exposure, or shooting menu settings before pressing ◀.

2 Select [Smile timer], and press the OK button.

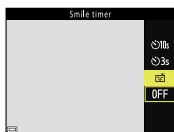

- If the setting is not applied by pressing the OK button, the selection will be canceled.



3 Frame the picture and wait for the subject to smile without pressing the shutter-release button.

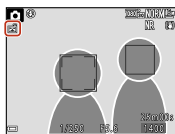

- Point the camera at a human face.
- If the camera detects that the face framed by the double border is smiling, the shutter is automatically released.
- Whenever the camera detects a smiling face, it automatically releases the shutter.
- The shutter-release button can also be used for shooting.

4 End automatic shooting.

- To end automatic shooting with smile timer, return to step 1 and select [**OFF**].

Notes about [Smile timer]

- When the focus-mode selector is set to **MF** (manual focus), [**Smile timer**] cannot be set.
- Under some shooting conditions, the camera may be unable to detect faces or smiles.
→ Notes about face detection (page 110)

When the self-timer lamp flashes

When using [**Smile timer**], the self-timer lamp flashes when the camera detects a face and flashes quickly immediately after the shutter is released.



Using autofocus

Set the focus-mode selector to **AF** (autofocus) to use autofocus.



Selecting the focus mode

You can select the focus mode that is appropriate for the shooting distance.

- 1 Press the multi selector ▼ (👇).

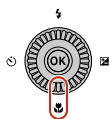



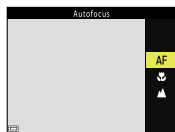

- 2 Select the desired focus mode and press the **OK** button.



- For information about the types of focus modes, see “➔ Available focus modes (page 107)”.
- If the setting is not applied by pressing the **OK** button, the selection will be canceled.



Available focus modes



Option	Description
AF Autofocus	<p>Use when the distance from the subject to the lens is 50 cm (1 ft 8 in.) or more, or 5.0 m (16 ft 5 in.) or more at the maximum telephoto zoom position.</p> <ul style="list-style-type: none">The focus mode icon on the shooting screen is displayed only immediately after the setting is made.
Macro close-up	<p>Set when taking close-up pictures.</p> <p>When the zoom ratio is set to a position where  and the zoom indicator are displayed in green, the camera can focus on subjects as close as approximately 10 cm (4 in.) from the lens. When the zoom is at a position more wide-angled than where  is displayed, the camera can focus on subjects as close as approximately 1 cm (0.4 in.) from the lens.</p> 
▲ Infinity	<p>Use when shooting distant scenes through window glass or when shooting landscapes.</p> <p>The camera automatically adjusts the focus near infinity.</p> <ul style="list-style-type: none">The camera may not be able to focus on nearby objects.
∞ Infinity	<p>Available when the scene mode is set to [Multiple exp. Lighten] → [Fireworks]. Focus is locked to infinity.</p> <ul style="list-style-type: none">Locked to  [Infinity] for some scene modes.

The focus mode setting

- The setting may not be available with some shooting modes.
 - Default settings (flash, self-timer, and focus mode) (page 119)
- For shooting modes **P**, **S**, **A**, and **M**, the setting is saved in the camera's memory even after the camera is turned off.



The shutter-release button

Operation	Description
Press halfway	<p>To press the shutter-release button “halfway” means to press and hold the button at the point where you feel a slight resistance.</p>  <ul style="list-style-type: none">• Focus and exposure (shutter speed and f-number) are set when you press the shutter-release button halfway. Focus and exposure remain locked while the button is pressed halfway.• The focus area varies depending on the shooting mode.
Press all the way	<p>To press the shutter-release button “all the way” means to press the button down completely.</p>  <ul style="list-style-type: none">• The shutter is released when the shutter-release button is pressed all the way.• Do not use force when pressing the shutter-release button, as this may result in camera shake and blurred images. Press the button gently.

Using target finding AF

In  (auto) mode or creative mode, or when **[AF area mode]** in **P, S, A, M,** or **U** mode is set to **[Target finding AF]**, the camera focuses in the manner described below when you press the shutter-release button halfway.



- The camera detects the main subject and focuses on it. When the subject is in focus, the focus area is displayed in green. If a human face is detected, the camera automatically sets focus priority on it.

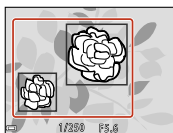

- If no main subject is detected, the camera automatically selects one or more of the nine focus areas containing the subject closest to the camera. When the subject is in focus, the focus areas that are in focus are displayed in green.

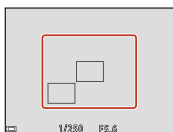

✔ Notes about target finding AF

- Depending on shooting conditions, the subject that the camera determines to be the main subject may vary.
- The main subject may not be detected when using certain settings for **[White balance]**, **[Picture Control]**, or effect group in creative mode.
- The camera may not detect the main subject appropriately in the following situations:
 - When the subject is very dark or bright
 - When the main subject lacks clearly defined colors
 - When the shot is framed so that the main subject is on the edge of the screen
 - When the main subject is composed of a repeating pattern



Using face detection

In the following settings, the camera uses face detection to automatically focus on human faces.

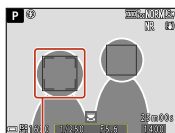



①

- **[Portrait]** or **[Night portrait]** scene mode
-  **[Smile timer]**
- When **[AF area mode]** is set to **[Face priority]**

If the camera detects more than one face, a double border (①) is displayed around the face that the camera focuses on, and single borders are displayed around the other faces.

If the shutter-release button is pressed halfway when no faces are detected:

- In **[Portrait]** and **[Night portrait]**, the camera focuses on the area in the center of the frame.
- When **[AF area mode]** is set to **[Face priority]**, the camera selects the focus area containing the subject closest to the camera.
- When  **[Smile timer]** is selected in  (auto), **P**, **S**, **A**, **M**, or **U** mode, the camera automatically selects one or more of the nine focus areas containing the subject closest to the camera.

Notes about face detection

- The camera's ability to detect faces depends on a variety of factors, including the direction in which the faces are looking.
- The camera cannot detect faces in the following situations:
 - When faces are partially hidden by sunglasses or otherwise obstructed
 - When faces take up too much or too little of the frame

Using skin softening

In **[Portrait]** or **[Night portrait]** scene mode, if human faces are detected, the camera processes the image to soften facial skin tones before saving the image (up to three faces).

[Skin softening (page 213)] can also be applied to saved images in playback mode.



✔ Notes about skin softening

- It may take more time than usual to save images after shooting.
- Under some shooting conditions, the desired results may not be achieved, and effects may be applied to areas of the image where there are no faces.

Subjects not suitable for autofocus

The camera may not focus as expected in the following situations. In rare cases, the subject may not be in focus despite the fact that the focus area or the focus indicator is displayed in green:

- Subject is very dark
- Objects of sharply differing brightness are included in the shooting conditions (e.g. the sun behind the subject makes that subject appear very dark)
- No contrast between the subject and surroundings (e.g. a portrait subject wearing a white shirt is standing in front of a white wall)
- Point sources of light such as illuminations and night views, or subjects in which brightness changes such as neon lights
- Several objects are at different distances from the camera (e.g. the subject is inside a cage)
- Subjects with repeating patterns (window blinds, buildings with multiple rows of similarly shaped windows, etc.)
- Subject is moving rapidly

In the situations noted above, try pressing the shutter-release button halfway to refocus several times, or focus on another subject positioned at the same distance from the camera as the actual desired subject, and use focus lock.

➔ Focus lock (page 111)

The camera can also focus using manual focus.

➔ Using manual focus (page 113)

Focus lock

Use focus lock to capture creative compositions even when the focus area is set to the center of the frame.



-
- 1 Position the subject in the center of the frame and press the shutter-release button halfway.

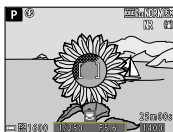

- The camera focuses on the subject and the focus area is displayed in green.
- Exposure is also locked.

-
- 2 Without lifting your finger, recompose the picture.

- Make sure to maintain the same distance between the camera and the subject.



-
- 3 Press the shutter-release button all the way down to take the picture.

Moving the focus area to the desired position

In **P**, **S**, **A**, or **M** shooting mode, the focus area can be moved using the multi selector by setting the shooting menu → **[AF area mode (page 191)]** to one of the manual options.

Using the AE-L/AF-L (AE-L/AF-L) button for focus lock

You can also use the AE-L/AF-L (AE-L/AF-L) button to lock the exposure or focus instead of pressing and holding the shutter-release button halfway.

- ➔ AE/AF lock button (page 237)



Using manual focus

Set the focus-mode selector to **MF** (manual focus) to adjust the focus manually.



1 Use the side dial to adjust the focus.

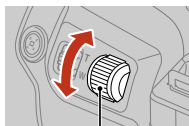

1



- If the screen above is not displayed, press the multi selector ▼ or rotate the side dial (1).
- Press ◀ to switch the view between 1x, 2x, and 4x.
- To adjust the focus in higher detail, rotate the side dial slowly.
- When ▶ is pressed, the camera focuses on the subject in the center of the frame with autofocus. The manual focus can be operated after the camera focuses with autofocus.
- Focusing is assisted by highlighting areas that are in focus in white (peaking) (→ Peaking (page 115)). Rotate the command dial to adjust the peaking level (2).



- Press the shutter-release button halfway to confirm the composition of the picture. Press the shutter-release button all the way to take the picture.



2 Press the multi selector ▼.



- The set focus is locked.
- Press the shutter-release button all the way to take the picture.
- To readjust the focus, press ▼ to display the screen in step 1.

Manual focus

- The digits displayed for the gauge on the right of the screen in step 1 serve as a guideline for the distance to a subject that is in focus when the gauge is near the center.
- The closest distance at which the camera can focus varies depending on the zoom position. At the maximum telephoto zoom position, the camera can focus on subjects as close as approximately 5.0 m (16 ft 5 in.) from the lens. When the zoom ratio is set to a position where  at the bottom right of the screen is green, the camera can focus on subjects as close as approximately 10 cm (4 in.) from the lens. When the zoom is at a position where the focal length (in 35mm [135] format) is equivalent to 30 mm, the camera can focus on subjects as close as approximately 1 cm (0.4 in.) from the lens.
- The actual range at which the subject can be in focus varies depending on the f-number and zoom position. To see whether the subject is in focus, check the image after shooting.

Peaking

- The range of the contrast level considered to be in focus can be changed by adjusting the peaking level. It is effective to set the level low for high contrast subjects, and high for low contrast subjects.
- Peaking highlights high contrast areas of the image in white. Under some shooting conditions, highlighting may not work properly or areas that are not in focus may be highlighted.
- You can disable the peaking display using the setup menu → [Peaking].
- If the setup menu → [HDMI] → [Clean HDMI output] → [On] is selected, the peaking display is disabled when the camera is connected to an HDMI-compatible device.

Manual focus during movie recording

- If you set the focus-mode selector to **MF** and press the  (▶ movie-record) button, you can focus while recording movies by using the side dial.
- The peaking display is disabled.



- ◀▶ operation on the multi selector and the focus-mode selector operation are disabled.



Exposure compensation

You can adjust overall image brightness.

- 1 Press the multi selector ► (⊠).

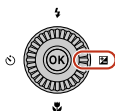

- 2 Select a compensation value and press the (OK) button.

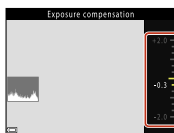

- To brighten the image, set a positive (+) value.
- To darken the image, set a negative (-) value.
- The compensation value is applied, even without pressing the (OK) button.

⚡ The exposure compensation setting

- If the setting is applied in **P**, **S**, or **A** mode, it will remain saved in the camera's memory even after the camera is turned off.
- Exposure compensation cannot be used in the following shooting modes:
 - When scene mode is set to [**Fireworks show**], [**Multiple exp. Lighten**], or [**Night sky (150 minutes)**] or [**Star trails (150 minutes)**] in [**Time-lapse movie**]
 - **M** (manual) mode
 - [**Manual**] in  (Movie manual) mode
- When the exposure compensation is set while using the built-in flash, the compensation is applied to both the background exposure and the flash output.
- You can also set the exposure compensation by using the side dial.
 - ➔ Assign side dial (page 236)



Using the histogram

A histogram is a graph showing the distribution of tones in the image. Use as a guide when using exposure compensation and shooting without the flash.

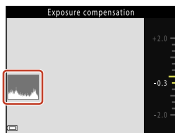

- The horizontal axis corresponds to pixel brightness, with dark tones to the left and bright tones to the right. The vertical axis shows the number of pixels.
- Increasing the exposure compensation value shifts the tone distribution to the right, and decreasing it shifts the tone distribution to the left.



Default settings (flash, self-timer, and focus mode)

The default settings for each shooting mode are listed below.

	Flash mode	Self-timer	Focus mode
(auto)	AUTO	OFF ¹	AF
(portrait)	AUTO	OFF ¹	AF ²
(landscape)	²	OFF	²
(sports)	²	OFF ²	AF ²
(night portrait)	³	OFF ¹	AF ²
(party/indoor)	AUTO ⁴	OFF	AF ²
(beach)	AUTO	OFF	AF ⁵
(snow)	AUTO	OFF	AF ⁵
(sunset)	²	OFF	²
(dusk/dawn)	²	OFF	²
(night landscape)	²	OFF	²
(close-up)	AUTO ⁶	OFF	²
(food)	²	OFF	²
(fireworks show)	²	OFF ²	²
(backlighting)	⁷	OFF	AF ²
(easy panorama)	²	OFF ²	AF ²
(pet portrait)	²	⁸	AF ⁵
(selective color)	AUTO	OFF	AF
(multiple exp. lighten)	²	OFF	AF/ ⁹
(time-lapse movie)	²	OFF	AF// ¹⁰



	Flash mode	Self-timer	Focus mode
(moon)	²	3s	²
(bird-watching)	²	OFF	AF ¹¹
(movie manual)	²	OFF	AF
(creative)	^{AUTO}	OFF	AF ⁵
P, S, A, and M		OFF ¹	AF
U (user settings)		OFF ¹	AF

- [Smile timer] can also be selected.
- Cannot be changed.
- When set to **[Hand-held]**, the flash mode setting is fixed at fill flash with slow sync and red-eye reduction. When set to **[Tripod]**, the flash mode setting is fixed at auto with slow sync and red-eye reduction.
- May switch to slow sync with red-eye reduction flash mode.
- AF [Autofocus]** or **[Macro close-up]** can be selected.
- The flash mode is fixed at (off) when using **[Noise reduction burst]**.
- When **[HDR]** is set to **[Off]**, the flash mode is fixed at **[Fill flash]**. When **[HDR]** is set to **[On]**, the flash mode is fixed at (off).
- [Pet portrait auto release]** can be used. **[10s]** or **[3s]** cannot be used.
- When using **[Nightscape + light trails]**, **AF [Autofocus]** or **[Infinity]** can be selected. When using **[Star trails]**, the focus mode is fixed at **[Infinity]**. When using **[Fireworks]**, **[Infinity]** or **[Infinity]** can be selected.
- The focus is fixed at **AF [Autofocus]** when using **[Cityscape (10 minutes)]**, at **[Infinity]** when using **[Landscape (25 minutes)]** or **[Sunset (50 minutes)]**, or at **[Infinity]** when using **[Night sky (150 minutes)]** or **[Star trails (150 minutes)]**.
- Can be selected from **AF [Autofocus]** or **[Infinity]**.



Using the Fn (function) button

If you press the **Fn** button in **P**, **S**, **A**, **M**, or **U** mode, you can quickly configure the pre-saved menu options.

- 1 Press the **Fn** (function) button when the shooting screen is displayed.

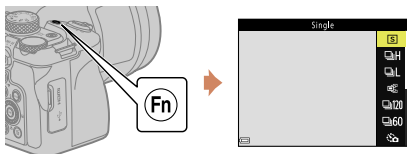

- The setting options of the menu that was set (default setting is [**Continuous**]) and **Fn** [**Fn button**] can be selected.



2 Use the multi selector to select a setting and press the **OK** button.



- If the setting is not applied by pressing the **OK** button, the selection will be canceled.
- To return to the shooting screen without changing the setting, press the **Fn** button or shutter-release button.
- To set a different menu option, select **Fn** [**Fn button**] and press the **OK** button. Select the desired menu option and press the **OK** button to set it.



- The menu options listed below can be saved.

- ➔ Image quality (page 174)
- ➔ Image size (page 175)
- ➔ Picture Control (page 177)
- ➔ White balance (page 181)
- ➔ Metering (page 184)
- ➔ Continuous (page 185)
- ➔ ISO sensitivity (page 189)
- ➔ AF area mode (page 191)
- ➔ Autofocus mode (page 196)
- ➔ Vibration reduction (page 234)
- ➔ Digital zoom (page 235)
- ➔ Toggle Av/Tv selection (page 244)
- ➔ Peaking (page 245)
- ➔ **Virtual horizon** (page 231)
- ➔ Assign side zoom control (page 236)
- ➔ AE/AF lock button (page 237)



Assigning menu options to the Fn buttons of the ML-L7 Remote Control (available separately)

You can also set the **Fn1** or **Fn2** button of the ML-L7 Remote Control (available separately) in the same way as the **Fn** button on COOLPIX P950.

- 1** Establish a Bluetooth connection between the camera and remote control.
→ Pairing the camera and remote control (page 265)
- 2** Rotate the mode dial to **P**, **S**, **A**, **M**, or **U**.
- 3** Press the **Fn1** (function 1) or **Fn2** (function 2) button on the ML-L7 Remote Control when the shooting screen is displayed.
 - The same menu options when the **Fn** button on the camera is pressed are displayed.
- 4** Press the multi selector **▲▼** on the ML-L7 Remote Control, select **Fn** [**Fn button**], and press the **OK** (apply selection) button.



- 5** Select a menu option to save and press the **OK** button on the ML-L7 Remote Control.
 - The selected menu option is saved to the **Fn1** or **Fn2** button.



Using the zoom

Using the zoom control

When you move the zoom control, the zoom lens position changes.

- To zoom in (telephoto position): Move toward **T**

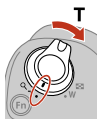

- To zoom out (wide-angle position): Move toward **W**



- Rotating the zoom control all the way in either direction adjusts the zoom quickly.
- The zoom indicator and focal length (in 35mm [135] format) are displayed on the shooting screen when the zoom control is moved.
- Digital zoom (2), which allows you to further magnify the subject up to approximately 4x the maximum optical zoom ratio, can be activated by moving and holding the zoom control toward **T** when the camera is zoomed in to the maximum optical zoom position (1).

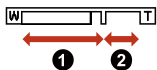

✓ Notes about digital zoom when recording movies

- The zoom indicator is not displayed while recording a movie.
- If you keep zooming while recording a movie, zooming stops at the position where optical zoom switches to digital zoom. To continue zooming, briefly release your finger from the zoom control before resuming operation of the zoom control.



- The zoom ratio of the digital zoom is limited to approximately 3.6x when [**Movie options**] is set to [**2160/30p**] (4K UHD) or [**2160/25p**] (4K UHD) while recording a movie.

Digital zoom and Dynamic Fine Zoom

The zoom indicator changes to blue when the digital zoom is activated, and it changes to yellow when the zoom magnification is increased further.

- Zoom indicator is blue: Image quality is not noticeably reduced by using the Dynamic Fine Zoom.
- Zoom indicator is yellow: There may be cases in which image quality is noticeably reduced.
- The indicator remains blue across a wider area when the image size is smaller.
- The zoom indicator may not change to blue when using certain continuous shooting settings or other settings.

Using the side zoom control

The zoom can also be operated by moving the side zoom control toward **T** or **W** instead of the zoom control.

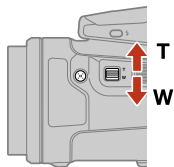

Zoom speed



- Rotating the zoom control all the way in either direction adjusts the zoom faster than the side zoom control.
- The zoom speed of the side zoom control while recording movies or in Movie manual mode can be set in the setup menu → [**Assign side zoom control**].



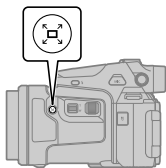

Using the snap-back zoom (temporarily widening the visible range)

If you lose sight of the subject while shooting with the lens in telephoto position, press the  (snap-back zoom) button to temporarily widen the visible area so that you can frame the subject more easily.



- While pressing the  button, frame the subject inside the framing border (1) of the shooting screen. To widen the visible area further, move the zoom control toward **W** while pressing the  button.



- Release the  button to return to the original zoom position.
- You can select the setup menu → **[Snap-back zoom]** to specify the size of the area that is visible when the  button is pressed.
- Snap-back zoom is not available in the following situations.
 - While pressing the shutter-release button halfway
 - During movie recording



Functions that cannot be used simultaneously when shooting

Some functions cannot be used with other menu settings.

Restricted function	Description
Flash mode	<ul style="list-style-type: none"> When the focus mode is set to ▲ [Infinity], the flash cannot be used. When [Continuous] is set to a setting other than [Single] and [Intvl timer shooting], the flash cannot be used. When [Exposure bracketing] is set to a setting other than [Off], the flash cannot be used.
Self-timer/ Smile timer	<ul style="list-style-type: none"> When the focus mode is set to a setting other than AF [Autofocus], [Smile timer] is set to [OFF]. When [AF area mode] is set to [Subject tracking], the self-timer/smile timer cannot be used.
Focus mode	When [Smile timer] is set, the focus mode is fixed at AF [Autofocus].
Image quality	<ul style="list-style-type: none"> When [Continuous] is set to [Pre-shooting cache], [Image quality] is fixed at [Normal]. When [Continuous] is set to [Continuous H: 120 fps] or [Continuous H: 60 fps], [RAW], [RAW + Fine], or [RAW + Normal] in [Image quality] cannot be selected. When [Multiple exposure] → [Multiple exposure mode] → [On] is set, [RAW], [RAW + Fine], or [RAW + Normal] in [Image quality] cannot be selected.
Image size	<ul style="list-style-type: none"> [Image size] is fixed at 16M [4608×3456] when [Image quality] is set to [RAW]. When [Image quality] is set to [RAW + Fine] or [RAW + Normal], the [Image size] of JPEG images can be set. However, 16.9M [4608×2592], 14.8M [4608×3072], or 12.1M [3456×3456] cannot be selected. [Image size] is set as follows depending on the [Continuous] setting: <ul style="list-style-type: none"> [Pre-shooting cache]: 11M (image size: 1280 × 960 pixels) [Continuous H: 120 fps]: 10.8M (image size: 640 × 480 pixels) [Continuous H: 60 fps]: 10.9M (image size: 1920 × 1080 pixels)
Picture Control	<ul style="list-style-type: none"> When [AF area mode] is set to [Subject tracking], [Monochrome] in [Picture Control] cannot be selected. When [Active D-Lighting] is set to a setting other than [Off], [Contrast] in [Picture Control] cannot be adjusted manually.



Restricted function	Description
White balance	When [Picture Control] is set to [Monochrome], [White balance] is fixed at [Auto (normal)].
Metering	When [Active D-Lighting] is set to a setting other than [Off], [Metering] is reset to [Matrix].
Continuous	<ul style="list-style-type: none"> • [Exposure bracketing] and [Multiple exposure] cannot be used at the same time with [Continuous]. • If the self-timer is set to [10s] (10 seconds) or [3s] (3 seconds) and the shutter-release button is released after the self-timer countdown has started, images are not captured continuously even when [Continuous H] or [Continuous L] is set. • If the self-timer is set to [10s] (10 seconds) or [3s] (3 seconds), images are not captured continuously even when [Pre-shooting cache] is set. • If the self-timer is set to [10s] (10 seconds) or [3s] (3 seconds), shooting finishes after one image is shot even when [Intvl timer shooting] is set. • Only one image is shot when shooting with the automatic shutter in [Smile timer]. Interval shooting finishes after one image is shot. • When [Image quality] is set to [RAW], [RAW + Fine], or [RAW + Normal], [Pre-shooting cache], [Continuous H: 120 fps], or [Continuous H: 60 fps] cannot be used.
Exposure bracketing	<ul style="list-style-type: none"> • The following cannot be used at the same time with [Exposure bracketing]. <ul style="list-style-type: none"> - [Continuous] - [Multiple exposure] - Self-timer - [Smile timer] • When [Picture Control] is set to [Monochrome], [Exposure bracketing] cannot be used.
ISO sensitivity	<ul style="list-style-type: none"> • When [Continuous] is set to [Pre-shooting cache], [Continuous H: 120 fps], or [Continuous H: 60 fps], [ISO sensitivity] is fixed at [100-1600]. • When the shooting mode is Movie manual and [Movie options] is set to an HS movie, [ISO sensitivity] is fixed at [100-1600].



Restricted function	Description
AF area mode	<ul style="list-style-type: none"> When [AF area mode] is set to a setting other than [Subject tracking] and the focus mode is set to ▲ [Infinity], the camera focuses near infinity regardless of the applied [AF area mode] option. When [Picture Control] is set to [Monochrome], [Subject tracking] cannot be set. When [Target finding AF] is set and [White balance] is set to a setting other than [Auto (normal)], the camera focuses on a face or selects one or more of the nine focus areas containing the subject closest to the camera.
Autofocus mode	<ul style="list-style-type: none"> When [Smile timer] is set, [Autofocus mode] operates using [Single AF]. When the focus mode is ▲ [Infinity], the autofocus mode operates using [Single AF].
Multiple exposure	<ul style="list-style-type: none"> When [Image quality] is set to [RAW], [RAW + Fine], or [RAW + Normal], [Multiple exposure] cannot be used. [Continuous] and [Exposure bracketing] cannot be used at the same time with [Multiple exposure].
Monitor settings	<ul style="list-style-type: none"> When the focus area is selected with [AF area mode] set to [Manual (spot)], [Manual (normal)], or [Manual (wide)], the histogram is not displayed. When [AF area mode] is set to [Subject tracking] and after the subject has been registered (during subject tracking), the histogram is not displayed. When [AF area mode] is set to [Target finding AF], the histogram is not displayed.
Date stamp	<ul style="list-style-type: none"> When [Image quality] is set to [RAW], [RAW + Fine], or [RAW + Normal], date and time cannot be stamped on images. When [Continuous] is set to [Pre-shooting cache], [Continuous H: 120 fps], or [Continuous H: 60 fps], date and time cannot be stamped on images.
Digital zoom	<ul style="list-style-type: none"> When [Smile timer] is selected, digital zoom cannot be used. When [Image quality] is set to [RAW], [RAW + Fine], or [RAW + Normal], digital zoom cannot be used. When [AF area mode] is set to [Subject tracking], digital zoom cannot be used. When [Zoom memory] is set to [On], digital zoom cannot be used.



Restricted function	Description
Shutter sound	<ul style="list-style-type: none"> • When [Continuous] is set to [Pre-shooting cache], [Continuous H: 120 fps], or [Continuous H: 60 fps], shutter sound is disabled. • When [Exposure bracketing] is set to a setting other than [Off], shutter sound is disabled.

Notes about digital zoom

- Depending on the shooting mode or the current settings, digital zoom may not be available.
 - ➔ Digital zoom (page 235)
- When digital zoom is in effect, selectable options for AF area mode or metering mode are restricted.



Playback features

Playback zoom	132
Crop	134
Thumbnail playback/calendar display	136
Viewing and deleting images in a sequence	138
Playback with easy panorama	140
Editing images (still images)	142
Printing still images	143



Playback zoom

Move the zoom control toward **T** (Q) in full-frame playback mode (1) to zoom in on an image (2).

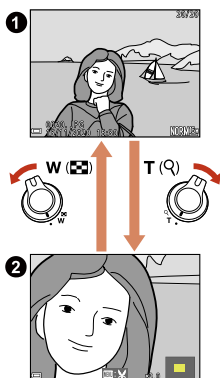

Operations during playback zoom

Function	Operation
Adjust the magnification rate	Move the zoom control (W (checkered flag)/ T (Q)). The zoom can also be adjusted by rotating the command dial.
Move the display position	Press the multi selector ▲▼◀▶ . The display position of the zoomed image is displayed as the yellow area at the bottom right of the screen. <ul style="list-style-type: none">If you are viewing an image that was captured using face detection or pet detection, the camera zooms in on the face detected at the time of shooting (except images captured using [Continuous] or [Exposure bracketing]). To zoom in on an area of the image where there are no faces, adjust the magnification rate and then press ▲▼◀▶.
Crop the image	Press the MENU button. ➔ Crop (page 134)



Function	Operation
Return to full-frame playback mode	Press the  button.



Crop

Trim images down only to the parts you need.

- See “Before editing images (page 142)” for information about restrictions on editing.

- 1** Move the zoom control toward **T** (Q) in full-frame playback mode to zoom in on the image.



- 2** Adjust the magnification rate and display position to display only the part to trim down.

- To change the magnification rate, move the zoom control toward **T** (Q) or **W** (Q). Set a magnification rate at which **MENU** (Q) is displayed.
- To view a different area of the image, press the multi selector **▲▼◀▶**.

- 3** Press the **MENU** button.



4 Check the image and press the **OK** button.



- To change the portion you want to keep, return to step 2 by pressing ◀.
- To exit without saving the cropped image, press the **MENU** button.

5 When the confirmation dialog is displayed, select **[Yes]** and press the **OK** button.

- An edited copy is created.

Notes about cropping

Images captured using easy panorama cannot be edited.

Image size

- The aspect ratio (horizontal to vertical) of the cropped copy is the same as the original.
- When the image size of the cropped copy is 320 × 240 or smaller, the image is displayed at a smaller size during playback.



Thumbnail playback/calendar display

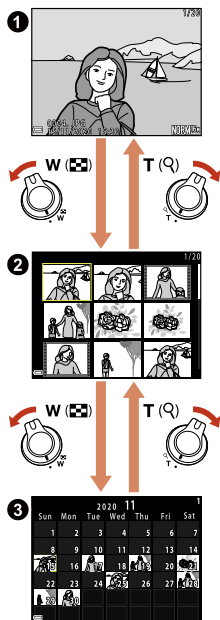

In full-frame playback mode (1), move the zoom control toward **W** (📷) to switch to thumbnail playback mode (2) and display multiple images on the screen, or to switch to calendar display (3) and display images by date.



Operations during thumbnail playback/calendar display

Function	Operation
Change the number of thumbnails displayed	Move the zoom control (W (📷)/ T (📅)).



Function	Operation
Select an image in thumbnail playback mode and display it in full-frame playback mode	Use the multi selector ▲▼◀▶ or rotate it to select an image, and press the  button.
Display images captured on a date selected in calendar display	Use ▲▼◀▶ or rotate the multi selector to select a date, and press the  button.

Notes about calendar display

Images captured when the camera's date is not set are treated as images captured on January 1, 2020.



Viewing and deleting images in a sequence

Viewing images in a sequence

Images captured continuously are saved as a sequence.

The first image of a sequence is used as the key picture to represent the sequence when displayed in full-frame playback mode or thumbnail playback mode (default setting). To display images in a sequence, press the **OK** button.



Operations in full-frame playback mode



Function	Operation
Zoom in on the image	Move the zoom control toward T (Q). ➔ Playback zoom (page 132)
Change the displayed image	Rotate the multi selector or press ◀▶ .
Display images that are not included in the sequence	Press ▲ to return to the key picture display.

☑ Notes about sequence display options

- Images captured with cameras other than this camera cannot be displayed as a sequence.



- If the number of sequences saved on the memory card in the camera exceeds 1,000, the images captured thereafter cannot be displayed as sequences. Delete sequences or insert a new memory card. However, even if you delete sequences, images that were not included in a sequence when they were captured cannot be displayed as a sequence.

Displaying images in a sequence

- To disable sequence display, select the playback menu → **[Sequence display]** → **[Individual pictures]**.
- When the playback menu → **[Sequence display]** is set to **[Key picture only]**, images in a sequence cannot be displayed as thumbnails.

Playback menu options available when using sequence

- When images in a sequence are displayed in full-frame playback mode, press the **MENU** button to select functions in playback menu.
 - ➔ The playback menu (page 170)
- If the playback menu → **[Sequence display]** is set to **[Key picture only]** and you start **[Slide show]** while images in a sequence are displayed, the images in that group will be played back in order. If you start **[Slide show]** while images other than those in a sequence are displayed, only key pictures of sequences will be displayed.
- If you press the **MENU** button when a key picture is displayed, the following settings can be applied to all images in the sequence:
 - Mark for upload, Protect

Deleting images in a sequence

When the  (delete) button is pressed for images in a sequence, the images that are deleted vary depending on how the sequences are displayed.

- When the key picture is displayed:
 - **[Current image]**: All images in the displayed sequence are deleted.
 - **[Erase selected images]**: When a key picture is selected on the erase selected images screen (step 3 in ➔ Deleting images (page 57)), all images in that sequence are deleted.
 - **[All images]**: All images on the memory card are deleted.
- When images in a sequence are displayed:
 - **[Current image]**: The image currently displayed is deleted.
 - **[Erase selected images]**: Images that are selected in the sequence are deleted.
 - **[Entire sequence]**: All images in the displayed sequence are deleted.



Playback with easy panorama

Switch to playback mode (→Playing back images (page 55)), display an image captured using easy panorama in full-frame playback mode, and then press the **OK** button to scroll the image in the direction that was used when shooting.









- Rotate the multi selector to fast-forward or rewind scroll playback.



Playback controls are displayed on the screen during playback.



Use the multi selector ◀▶ to select a control, and then press the **OK** button to perform the operations described below.

Icon	Description
	End playback and return to full-frame playback mode.
	Hold down the OK button to rewind scroll playback. This operation can also be performed by rotating the multi selector.
	Pause playback. The operations listed below can be performed while paused. <ul style="list-style-type: none">• : Scroll one step to the left. Hold down the OK button to scroll continuously. This operation can also be performed by rotating the multi selector.• : Resume automatic scrolling.• : Scroll one step to the right. Hold down the OK button to scroll continuously. This operation can also be performed by rotating the multi selector.



Icon	Description
	Hold down the  button to fast-forward scroll playback. This operation can also be performed by rotating the multi selector.

✔ Notes about easy panorama images

- The images cannot be edited on this camera.
- This camera may not be able to scroll the playback of, or zoom in on, easy panorama images captured with another make or model of digital camera.

✔ Notes about printing panorama images

The entire image may not be able to be printed depending on the printer's settings. Additionally, printing may not be possible depending on the printer.



Editing images (still images)

You can use the following image editing functions with this camera.

- ➔ Quick retouch (page 212)
- ➔ D-Lighting (page 213)
- ➔ Skin softening (page 213)
- ➔ Filter effects (page 214)
- ➔ Small picture (page 220)
- ➔ Crop (page 134)

Before editing images

Images created by editing are saved as files separate from the original images.

- ➔ File names (page 292)

Images created by editing are saved with the same shooting date and time as the original images.

Restrictions on image editing

- RAW images and images captured using easy panorama cannot be edited.
- A JPEG image can be edited up to 10 times. A still image created by editing a movie can be edited up to 9 times.
- You may not be able to edit images of a certain size or with certain editing functions.



Printing still images

You can use one of the following methods to print still images.

- Request at a print service store.
- Insert the memory card into a printer with a memory card slot and print.
- Print from a printer that is connected to a computer.
 - ➔ Transferring images to a computer (page 250)

Printing RAW images

To print RAW images, download them to a computer and use software NX Studio to perform RAW processing. To use the software, see the online help.

Notes about printing images at 1:1 aspect ratio

Change the printer setting to "Border" when printing images at a 1:1 aspect ratio. Some printers may not be able to print images at a 1:1 aspect ratio.

- ➔ Image size (page 175)



Movies

Basic operations of movie recording and movie playback	145
Capturing still images while recording movies	149
Movie manual	150
Time-lapse movie	153
Operations during movie playback	156
Editing movies	158



Basic operations of movie recording and movie playback

1 Display the shooting screen.

- Check the remaining amount of movie recording time (❶) on the screen.
➔ Maximum movie recording time (page 147)
- It is recommended that you display the movie frame (❷) that indicates the area that will be recorded in a movie.
➔ Movie frame (page 146)

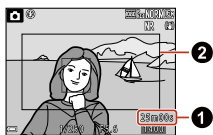

2 Press the ● (▶/⏻ movie-record) button.

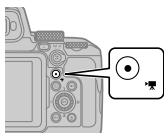

- The camera starts recording a movie. The camera focuses in the center of the frame.



- Press the **OK** button to pause recording, and press the **OK** button again to resume recording (except when an HS movie option is selected in **[Movie options]**). Recording automatically ends if it remains paused for about five minutes.

3 Press the ● (▶/⏻) button to end recording.



4 Select a movie in full-frame playback mode and press the **OK** button to play it back.

- An image with a movie options icon is a movie.

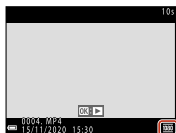

➔ Operations during movie playback (page 156)

Movie frame

- Press the **DISP** button to display the movie frame. Check the range of a movie in a frame before movie recording.
- The area that is recorded in a movie varies depending on the settings of **[Movie options]**, **[Electronic VR]**, etc. in the movie menu.

Focusing

- The focus can be adjusted during movie recording in the following manner in accordance with the movie menu ➔ **[Autofocus mode]** setting.
 - **AF-S [Single AF]** (default setting): The focus is locked when movie recording starts. To perform the autofocus function during movie recording, press the multi selector ◀.
 - **AF-F [Full-time AF]**: The focus is adjusted repeatedly even during movie recording. The button that locks the focus depends on the setting in the setup menu ➔ **[AE/AF lock button]**. When **[AE/AF lock]** or **[AF lock only]** is selected, press the AE-L/AF-L (AE-L/AF-L) button during movie recording to lock the focus. To unlock, press the AE-L/AF-L button again. When **[AE lock only]** or **[AE lock (Hold)]** is selected, press the multi selector ◀ during movie recording to lock the focus. To unlock, press ◀ again.
- When the focus-mode selector is set to **MF** (manual focus), you can adjust the focus manually while recording movies by rotating the side dial.

Exposure

The button that locks the exposure depends on the setting in the setup menu ➔ **[AE/AF lock button]**. When **[AE/AF lock]**, **[AE lock only]**, or **[AE lock (Hold)]** is selected, press the AE-L/AF-L button during movie recording to lock the exposure. To



unlock, press the AE-L/AF-ON button again. When [AF lock only] is selected, press the multi selector \blacktriangleright during movie recording to lock the exposure. To unlock, press \blacktriangleright again.

Maximum movie recording time

The remaining recording time for a single movie is displayed on the shooting screen.

- Individual movie files cannot exceed 29 minutes in length, even when there is sufficient free space on the memory card for longer recording. The maximum size of a single movie file is 4 GB. If a file exceeds 4 GB even when you record for less than 29 minutes, it is split into multiple files and cannot be played back continuously.
 - ➔ Max. recording time per file (page 204)
- Recording may end before the maximum recording time is reached if the camera temperature becomes elevated.
- The actual remaining recording time may vary depending on the movie content, subject movement, or type of memory card.
- Memory cards with an SD Speed Class rating of 6 (Video Speed Class V6) or faster are recommended for recording movies. When [Movie options] is set to [2160/30p] (4K UHD) or [2160/25p] (4K UHD), memory cards with a UHS Speed Class rating of 3 (Video Speed Class V30) or faster are recommended. When using a memory card with a lower Speed Class rating, movie recording may stop unexpectedly.

Notes about camera temperature

- The camera may become hot when recording movies for an extended period of time or when the camera is used in a hot area.
- If the inside of the camera becomes extremely hot when recording movies, the camera will automatically stop recording. The amount of time remaining until the camera stops recording ( 10s) is displayed.

After the camera stops recording, it turns itself off.
Leave the camera off until the inside of the camera has cooled.

Notes about movie recording

Notes about saving images or movies



The indicator showing the number of exposures remaining or the indicator showing the remaining recording time flashes, or [Please wait for the camera to finish recording.] is displayed while images or movies are being saved. **Do not open the battery-chamber/memory card slot cover or remove the battery or memory card while an indicator is flashing.** Doing this could result in loss of data, or in damage to the camera or the memory card.



✔ Notes about recorded movies

- The sounds of zoom control operation, side dial operation, zoom, autofocus lens drive movement, vibration reduction, and aperture operation when brightness changes may be recorded.
- The following phenomena may be seen on the screen while recording movies. These phenomena are saved in the recorded movies.
 - Banding may occur in images under fluorescent, mercury-vapor, or sodium-vapor lighting.
 - Subjects that move quickly from one side of the frame to the other, such as a moving train or car, may appear skewed.
 - The entire movie image may be skewed when the camera is panned.
 - Lighting or other bright areas may leave residual images when the camera is moved.
- Depending on the distance to the subject or the amount of zoom applied, colored stripes may appear on subjects with repeating patterns (fabrics, lattice windows, etc.) during movie recording and playback. This occurs when the pattern in the subject and the layout of the image sensor interfere with each other; it is not a malfunction.

✔ Notes about autofocus for movie recording



For “Subjects not suitable for autofocus (page 111)”, autofocus may not perform as expected. Should this occur, focus using manual focus (Using manual focus (page 113)) or try the following:

- 1 Select the movie menu → **[Autofocus mode]** → **[Single AF]** (default setting) before starting movie recording.
- 2 Frame another subject (positioned at the same distance from the camera as the intended subject) in the center of the frame, press the  button to start recording, and modify the composition.



Capturing still images while recording movies

If the shutter-release button is pressed all the way while recording a movie, one frame is saved as a still image (JPEG image) (except Movie manual mode). Movie recording continues while the still image is being saved.

- A still image can be captured when  is displayed on the screen. When  is displayed, a still image cannot be captured.



- The size of the captured still image is the same as the movie image size.
→ Movie options (page 204)

✓ Notes about capturing still images during movie recording

- Still images cannot be saved during movie recording in the following situations:
 - In Movie manual mode
 - When movie recording is paused
 - When the remaining movie recording time is less than five seconds
 - When **[Movie options]** is set to an HS movie option
- When the shooting menu → **[Image quality]** is set to **[RAW]** or **[RAW + Fine]**, a still image is captured as **[Fine]**. When **[Image quality]** is set to **[RAW + Normal]**, it is captured as **[Normal]**.
- Up to 20 still images can be saved while recording a single movie when **[Movie options]** is set to **[2160/30p]** or **[2160/25p]**. Still images are captured as **[Fine]**.
- It may take some time to save the images after shooting.
- The frames of a movie that were recorded when a still image was being captured may not play back smoothly.
- The sounds of operating the shutter-release button when saving a still image may be heard in the recorded movie.
- If the camera moves when the shutter-release button is pressed, the image may be blurred.



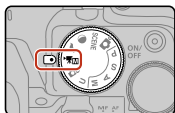

In Movie manual mode, you can use the aperture-priority auto or manual setting to set the exposure (shutter speed and f-number) when recording movies.

Option	Description
Aperture-priority auto (default setting)	When the f-number is set, the camera automatically determines the shutter speed. You can change the f-number to bring the subject, foreground and background into focus, or blur the subject's background intentionally.
Manual	Set both the shutter speed and f-number.

- 1 Press the **MENU** button, select [**Exposure mode**], and press the **OK** button.

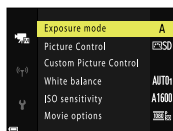

-
- 2** Select [**Aperture-priority auto**] or [**Manual**], and press the **OK** button.

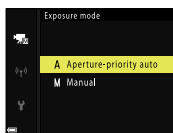

- Set the following options according to your shooting conditions and requirements.
 - [**Picture Control**]
 - [**Custom Picture Control**]
 - [**White balance**]
 - [**ISO sensitivity**]
 - [**Movie options**]
 - [**Autofocus mode**]
 - [**Electronic VR**]
 - [**Wind noise reduction**]
 - [**Zoom microphone**]
 - [**Frame rate**]
 - [**External mic sensitivity**]

-
- 3** Press the **MENU** button to display the shooting screen.

- 4** Set the exposure.

- Rotate the command dial to set the shutter speed. Rotate the multi selector to set the f-number.



5 Press the button to start movie recording.



- In autofocus, the camera focuses in the center of the frame. The focus area is not displayed.
- In autofocus, to check the focus before starting movie recording, press the shutter-release button halfway, or select the Movie manual mode menu → **[Autofocus mode]** → **[Full-time AF]**.
- You can start/end movie recording by pressing the shutter-release button all the way down.
- The shutter speed or f-number can also be set during movie recording (except when an HS movie option is selected in **[Movie options]**).

Notes about Movie manual mode

In Movie manual mode, you cannot capture still images.

Notes about ISO sensitivity

When the shooting mode is Movie manual and **[Movie options]** is set to an HS movie, **[ISO sensitivity]** is fixed at **[100-1600]**.

Shutter speed

When the shutter speed setting is closer to the movie frame rate, the motion appears smoother. The shutter speed cannot be set slower than the frame rate.

Functions available in Movie manual mode



- Self-timer
 - ➔ Self-timer (page 102)
- Focus mode
 - ➔ Selecting the focus mode (page 106)
- Exposure compensation
 - ➔ Exposure compensation (page 117)
- Movie manual mode menu
 - ➔ The Movie manual mode menu (page 203)







Time-lapse movie

The camera can automatically capture still images at a specified interval to create time-lapse movies that are approximately 10 seconds long.

Rotate the mode dial to **SCENE** → **MENU** button →  **Time-lapse movie** → **OK** button

- When the movie menu → **[Frame rate]** setting is set to **[30 fps (30p/60p)]**, 300 images are captured and saved with  **[1080/30p]**. When set to **[25 fps (25p/50p)]**, 250 images are captured and saved with  **[1080/25p]**.

Type (required shooting time)	Interval time	
	30 fps (30p/60p)	25 fps (25p/50p)
 Cityscape (10 minutes)¹ (default setting)	2 s	2.4 s
 Landscape (25 minutes)¹	5 s	6 s
 Sunset (50 minutes)¹	10 s	12 s
 Night sky (150 minutes)²	30 s	36 s
 Star trails (150 minutes)³	30 s	36 s

- The camera focuses on the area in the center of the frame.
- Suited for recording the movement of stars.
- Star movement appears as lines of light due to image processing.

1 Use the multi selector ▲▼ to select a type, and press the **OK** button.

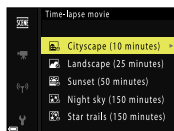

-
- 2 Select whether or not to fix exposure (brightness), and press the **OK** button (except [**Night sky (150 minutes)**] and [**Star trails (150 minutes)**]).

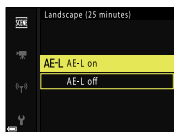

- When [**AE-L on**] is selected, the exposure used for the first image is used for all images. When the brightness changes drastically like at dusk, [**AE-L off**] is recommended.

-
- 3 Stabilize the camera by using a tool such as a tripod.

- See "➔ Using a tripod (page 51)" when using a tripod.

-
- 4 Press the shutter-release button to capture the first image.



- Set exposure compensation (➔ Exposure compensation (page 117)) before releasing the shutter for the first image (when using [**Night sky (150 minutes)**] or [**Star trails (150 minutes)**], exposure compensation cannot be used). Exposure compensation cannot be changed after the first image is captured. Focus and hue are fixed when the first image is captured.
- When capturing images of stars, it is recommended that you use manual focus.
➔ Using manual focus (page 113)
- The shutter is automatically released for the second and subsequent images.
- The screen may turn off during the shooting interval.

-
- 5 End shooting.

- Shooting ends automatically when 300 or 250 images are captured.
- To end shooting before it automatically ends, press the **OK** button.



✔ Notes about [Time-lapse movie]

- Use a sufficiently charged battery to prevent the camera from turning off unexpectedly.
- Do not rotate the mode dial or remove the memory card until shooting ends.
- Time-lapse movies cannot be recorded by pressing the ● (📷) button.
- The auto off function is disabled during shooting.
- Sound and still images cannot be saved.



Operations during movie playback





To adjust the volume (1), move the zoom control.

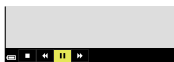

Rotate the multi selector or the command dial to fast-forward or rewind. Playback controls are displayed on the screen during movie playback. Use the multi selector ◀▶ to select a control, and then press the OK button to perform the operations described below.

- During playback









Icon	Description
	End playback and return to full-frame playback mode.
	Hold down the OK button to rewind the movie.
	Pause playback.
	Hold down the OK button to fast-forward the movie.



- When paused



Icon	Description
	End playback and return to full-frame playback mode.
	Rewind the movie one frame. Hold down the OK button for continuous rewinding. The movie can also be rewound by one frame by rotating the multi selector or command dial.
	Resume playback.
	Advance the movie one frame. Hold down the OK button for continuous advancing. The movie can also be advanced by one frame by rotating the multi selector or command dial.
	Extract the desired portion of a movie and save it as a separate file.
	Extract a single frame of a movie and save it as a still image.



Editing movies

When editing movies, use a sufficiently charged battery to prevent the camera from turning off during editing.

Extracting only the desired portion of a movie

The desired portion of a recorded movie can be saved as a separate file.

1 Play back a desired movie and pause at the start point of the portion that you want to extract.

- Operations during movie playback (page 156)

2 Use the multi selector to select the control, and then press the button.

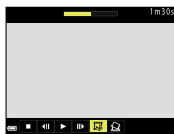

3 Use to select (choose start point).



- Use or rotate the command dial to move the start point.
- To cancel editing, select (back), and press the button.



4 Use ▲▼ to select 7x (choose end point).

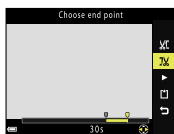

- Use ◀▶ or rotate the command dial to move the end point.
- To preview the specified portion, use ▲▼ to select ▶ and then press the Ⓞ button. Press the Ⓞ button again to stop previewing.

5 Use ▲▼ to select □ (save) and press the Ⓞ button.

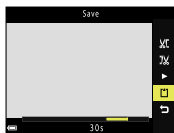

- Follow the instructions on the screen to save the movie.

✔ Notes about movie extracting

- A movie that was created by editing cannot be edited again.
- The actual trimmed portion of a movie may differ slightly from the portion selected using the start and end points.
- Movies cannot be trimmed so that they are less than two seconds long.



Saving a frame from a movie as a still image

The desired frame of a recorded movie can be extracted and saved as a still image.

1 Pause a movie and display the frame to be extracted.

- ➡ Operations during movie playback (page 156)



-
- 2 Use the multi selector ◀▶ to select the  control, and then press the  button.

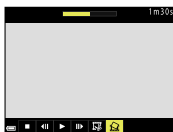

-
- 3 Select [**Yes**] when a confirmation dialog is displayed, and press the  button.



- The still image is saved with [**Normal**] as the image quality. The image size is determined by the original movie image size.
➔ [Movie options \(page 204\)](#)

Restrictions on extracting still images

Still images cannot be extracted from a movie recorded with an HS movie option.



Using the menu









Menu operations	162
Menu lists	166
The shooting menu (common across shooting modes)	174
The shooting menu (P , S , A , M , or U mode)	177
The Movie manual mode menu	203
The movie menu	204
The playback menu	211
The network menu	223
The setup menu	227

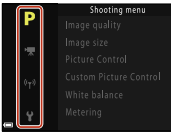



Menu operations

You can press the **MENU** (menu) button to display the menu screen and change the camera's settings.

- The displayed menu varies depending on the status of the camera (during shooting or playback).
- Menu items are categorized by the icons on the left side of the screen.

When shooting	During playback
 <ul style="list-style-type: none">• P Shooting menu^{1, 3}•  Movie manual mode menu²•  Movie menu³•  Network menu•  Setup menu	 <ul style="list-style-type: none">•  Playback menu•  Network menu•  Setup menu

- 1 Menu names and icons vary depending on the shooting mode.
- 2 Displayed when the mode dial is rotated to  (Movie manual).
- 3 Displayed when the mode dial is rotated to a mode other than  (Movie manual).

1 Press the **MENU** (menu) button to display the menu screen.

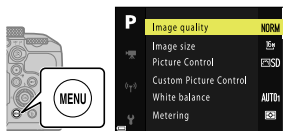

-
- 2 Press the multi selector ◀ to move to the menu category selection area.

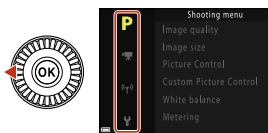

-
- 3 Press ▲▼ or rotate the multi selector to change menu categories.

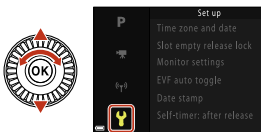

-
- 4 Press the OK button to confirm the menu category.

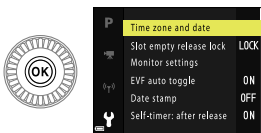

- Menu items corresponding to the selected menu category are displayed.



-
- 5 Press ▲▼ or rotate the multi selector to select a menu option, and press the **OK** button to confirm the selection.

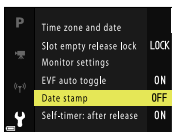

- Certain options cannot be selected depending on the current shooting mode or the state of the camera.

-
- 6 Press ▲▼ or rotate the multi selector to select a setting, and press the **OK** button to confirm the selection.

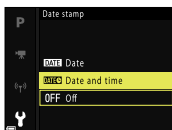

- When you are finished using the menu, press the **MENU** button.
- When a menu is displayed, you can return to shooting mode by pressing the shutter-release button or **MOVIE** (movie-record) button.

🔍 To change the flash mode, self-timer, focus mode, and exposure compensation settings

You can press the multi selector ▲ (flash mode), ◀ (self-timer), ▼ (focus mode), or ▶ (exposure compensation) to configure them on the shooting screen.

- ➔ Setting the flash mode, self-timer, focus mode, and exposure compensation (page 98)



Using the Fn (function) button

If you press the **Fn** button in **P**, **S**, **A**, **M**, or **U** mode, you can quickly configure the pre-saved menu options (default setting is **[Continuous]**). To set a different menu option, select **[Fn [Fn button]]** and select the desired menu option.

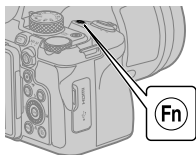

Menu lists

The shooting menu

Shooting mode → MENU button

Common options (except Movie manual mode)

Option	Default setting
Image quality *	[Normal]
Image size *	[6M] [4608x3456]

* Also can be set by pressing the **Fn** (function) button.

→ Using the **Fn** (function) button (page 121)

For P, S, A, M, and U modes

Option	Default setting
Picture Control ¹	[Standard]
Custom Picture Control	–
White balance ¹	[Auto (normal)]
Metering ¹	[Matrix]
Continuous ¹	[Single]
ISO sensitivity ¹	• ISO: [100-1600] • Minimum shutter speed: [None]
Exposure bracketing ²	[Off]
AF area mode ¹	[Target finding AF]
Autofocus mode ¹	[Full-time AF]
Flash exp. comp.	[0.0]
Noise reduction filter	[Normal]
Long exposure NR	[Auto]





Option	Default setting
Active D-Lighting	[Off]
Multiple exposure	<ul style="list-style-type: none"> • Multiple exposure mode: [Off] • Auto gain: [On]
Save user settings	–
Reset user settings	–
Zoom memory	[Off]
Startup zoom position	[24 mm]
M exposure preview	[Off]

- 1 Also can be set by pressing the **Fn** (function) button.
 ➔ Using the **Fn** (function) button (page 121)
- 2 Cannot be set in **M** mode.



The Movie manual mode menu



Rotate the mode dial to  (Movie manual) → MENU button



Option	Default setting
Exposure mode	[Aperture-priority auto]
Picture Control	[Standard]
Custom Picture Control	–
White balance	[Auto (normal)]
ISO sensitivity	[100-1600]
Movie options	 [1080/30p] or  [1080/25p]
Autofocus mode	[Single AF]
Electronic VR	[On]
Wind noise reduction	[Off]
Zoom microphone	[On]
Frame rate	–
External mic sensitivity *	[Auto sensitivity]

* This option can be set only when an external microphone is connected.



The movie menu

Shooting mode → MENU button →  (movie menu) →  button

Option	Default setting
Movie options	 [1080/30p] or  [1080/25p]
Autofocus mode	[Single AF]
Electronic VR	[On]
Wind noise reduction	[Off]
Zoom microphone	[On]
Frame rate	–
External mic sensitivity *	[Auto sensitivity]

* This option can be set only when an external microphone is connected.



The playback menu

 **button (playback mode) → MENU button**

Option

Mark for upload (page 211)

Quick retouch (page 212)*

D-Lighting (page 213)*

Skin softening (page 213)*

Filter effects (page 214)*

Slide show (page 216)

Protect (page 218)

Rotate image (page 218)

Small picture (page 220)*

Sequence display (page 221)

Key picture selection (page 222)

* Edited images are saved as separate files. Some images may not be edited.



The network menu

MENU button →  (network menu) →  button

Option

Airplane mode (page 223)

Choose connection (page 224)

Connect to smart device (page 224)

Connection to remote (page 224)

Send while shooting (page 224)

Wi-Fi (page 224)

Bluetooth (page 225)

Restore default settings (page 225)



The setup menu

MENU button → Y (setup) → OK button

Option

Time zone and date (page 227)

Slot empty release lock (page 229)

Monitor settings (page 229)*

EVF auto toggle (page 232)

Date stamp (page 232)

Self-timer: after release (page 233)

Vibration reduction (page 234)*

AF assist (page 235)

Digital zoom (page 235)*

Assign side zoom control (page 236)*

Snap-back zoom (page 236)

Assign side dial (page 236)

AE/AF lock button (page 237)*

Sound settings (page 238)

Auto off (page 238)

Format card (page 239)

Language (page 239)

HDMI (page 239)

Charge by computer (page 241)

Image comment (page 241)

Copyright information (page 242)

Location data (page 243)

Toggle Av/Tv selection (page 244)*



Reset file numbering (page 244)

Peaking (page 245)*

Reset all (page 245)

Conformity marking (page 246)

Firmware version (page 246)

* Also can be set by pressing the **Fn** (function) button. In **[Monitor settings]**, only **[Virtual horizon]** can be set.

➔ Using the **Fn** (function) button (page 121)



The shooting menu (common across shooting modes)

Image quality

Set the image quality (compression ratio) used when saving images. Lower compression ratios result in higher quality images, but the number of images that can be saved is reduced.

Shooting mode* → MENU button → Image quality →  button

* The image quality can be set in any shooting mode other than Movie manual. The setting is also applied to other shooting modes (except shooting mode **U** and **[Easy panorama]** scene mode).

Option	Description
FINE Fine	Finer image quality than [Normal] . Compression ratio of about 1:4
NORM Normal (default setting)	Normal image quality, suitable for most applications. Compression ratio of about 1:8
RAW RAW	Raw data from the image sensor are saved without additional processing. You can use a computer to change settings that were set during shooting such as white balance and contrast. • File format: RAW (NRW), Nikon's own format
RAW+ RAW + Fine	Two images are recorded at the same time, one RAW image and one fine-quality JPEG image.
RAW-N RAW + Normal	Two images are recorded at the same time, one RAW image and one normal-quality JPEG image.

Notes about [Image quality]

- [Image size] is fixed at  **[4608×3456]** when [Image quality] is set to **[RAW]**.



- RAW images cannot be captured in the following shooting modes:
 - Creative mode
 - Bird-watching mode
 - Moon mode
 - Scene modes

If you change the shooting mode to any of the above shooting modes when a RAW image quality has been selected, the image quality will change to **[Fine]** or **[Normal]**.

- This function may not be available to use in combination with other functions.
 - ➔ Functions that cannot be used simultaneously when shooting (page 127)

RAW images of this camera

- RAW processing and image editing cannot be performed on this camera. If you download RAW images to a computer, you can use the software NX Studio to perform RAW processing and image editing. See “➔ Transferring images to a computer (page 250)” for information about downloading images. To use the software, see the online help.
- To print RAW images, download them to a computer and use NX Studio.

Saving of RAW and JPEG images at the same time

- The RAW image and the JPEG image that are saved at the same time have the same file number but with their own extensions, “.NRW” and “.JPG” respectively.
- When playing back on the camera, only the JPEG image is displayed.
- Note that when the JPEG image is deleted, the RAW image that was saved at the same time is also deleted.

Number of images that can be saved

- The approximate number of images that can be saved can be checked on the screen when shooting.



- Note that due to JPEG compression, the number of images that can be saved may vary greatly depending on the image content, even when using memory cards with the same capacity and the same image quality and image size settings. In addition, the number of images that can be saved may vary depending on the make of the memory card.
- If the number of exposures remaining is 10,000 or more, the number of exposures remaining display shows “9999.”

Image size







Set the image size (number of pixels) used when saving JPEG images.



The larger the image size, the larger the size at which it can be printed, but the number of images that can be saved is reduced.

Shooting mode* → MENU button → Image size →  button

* The image size can be set in any shooting mode other than Movie manual. The setting is also applied to other shooting modes (except shooting mode **U** and [Easy panorama] scene mode).

Option*	Aspect ratio (horizontal to vertical)
 4608×3456 (default setting)	4:3
 3264×2448	4:3
 2272×1704	4:3
 1600×1200	4:3
 4608×2592	16:9
 4608×3072	3:2
 3456×3456	1:1

* The numerical values indicate the number of pixels that are captured.
Example:  4608×3456 = approx. 16 megapixels, 4608 × 3456 pixels

Notes about [Image size]

This function may not be available to use in combination with other functions.

 Functions that cannot be used simultaneously when shooting (page 127)



The shooting menu (P, S, A, M, or U mode)







See “ U (user settings) mode (page 71)” for information about [Save user settings] and [Reset user settings].

Picture Control

You can use Picture Control (COOLPIX Picture Control) to change the settings for image recording according to the shooting conditions or your preferences. Sharpness, contrast and saturation can be adjusted in detail.

Rotate the mode dial to **P, S, A, M, or U*** → MENU button → Picture Control →  button

* The setting can also be configured in  (Movie manual) mode.

Option	Description
 SD Standard (default setting)	Standard processing for balanced results. Recommended for most situations.
 NL Neutral	Minimal processing for natural results. Select for images that will later be processed or retouched.
 VI Vivid	Images are enhanced for a vivid, photoprint effect. Select for images that emphasize primary colors, such as blue, red, and green.
 MC Monochrome	Shoots monochrome photographs such as in black-and-white or sepia.
 C1 Custom 1*	Changes to the setting of [Custom 1] in COOLPIX Custom Picture Control.
 C2 Custom 2*	Changes to the setting of [Custom 2] in COOLPIX Custom Picture Control.

* Only displayed when the setting customized in [Custom Picture Control (page 180)] has been registered.

Notes about COOLPIX Picture Control

- The COOLPIX Picture Control function of this camera cannot be used with other makes of cameras, Picture Control function of software such as NX Studio, Picture Control Utility 2, etc.



- This function may not be available to use in combination with other functions.
 → Functions that cannot be used simultaneously when shooting (page 127)

Customizing existing COOLPIX Picture Controls: quick adjust and manual adjust

COOLPIX Picture Control can be customized using “Quick adjust”, which allows for balanced adjustment of sharpness, contrast, saturation and other image editing components, or using “Manual adjust”, which allows for detailed adjustment of the components individually.

- 1 Use the multi selector ▲▼ to select the desired type of COOLPIX Picture Control and press the OK button.

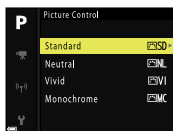

- Items can also be selected by rotating the multi selector.

- 2 Use ▲▼ to highlight the desired option and use ◀▶ to select a value.

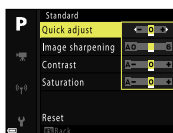

- For adjustment options, see “→ Types of quick adjust and manual adjust (page 179)”.
- Press the OK button to set the value.
- To change the adjusted values to the default setting, select [Reset] and press the OK button.



Types of quick adjust and manual adjust

Option	Description
Quick adjust¹	<p>Adjusts the sharpness, contrast and saturation levels automatically. Setting to the – side reduces the effect of the selected COOLPIX Picture Control, and setting to the + side emphasizes its effect.</p> <ul style="list-style-type: none">• Default setting: [0]
Image sharpening	<p>Controls how much outlines are sharpened during shooting. The higher the number, the sharper the image, and the lower the number, the softer the image.</p> <p>Select [A] (auto) for automatic adjustment.</p> <ul style="list-style-type: none">• Default setting: [3] for [Standard] or [Monochrome], [2] for [Neutral], and [4] for [Vivid]
Contrast	<p>Controls the contrast.</p> <p>Setting to the – side gives the image a softer appearance, and setting to the + side gives it a harder appearance. Select lower values to prevent highlights in portrait subjects from being “washed out” in direct sunlight, higher values to preserve detail in misty landscapes and other low contrast subjects.</p> <p>Select [A] (auto) for automatic adjustment.</p> <ul style="list-style-type: none">• Default setting: [0]
Saturation²	<p>Controls the vividness of colors.</p> <p>Setting to the – side reduces the vividness, and setting to the + side increases the vividness.</p> <p>Select [A] (auto) for automatic adjustment.</p> <ul style="list-style-type: none">• Default setting: [0]
Filter effects³	<p>Simulates the effect of color filters on monochrome photographs.</p> <ul style="list-style-type: none">• [OFF]: Filter effects are not used.• [Y] (yellow), [O] (orange), [R] (red): Enhance contrast. Can be used to tone down the brightness of the sky in landscape photographs. The contrast is strengthened in the order [Y] → [O] → [R].• [G] (green): Softens skin tones and the color of features such as lips. Suitable for portraits.• Default setting: [OFF]



Option	Description
Toning ³	<p>Controls the tint used in monochrome photographs from [B&W] (black-and-white), [Sepia], and [Cyanotype] (blue-tinted monochrome). Pressing the multi selector ▼ when [Sepia] or [Cyanotype] is selected enables you to select a saturation level. Press ◀▶ to adjust the saturation.</p> <ul style="list-style-type: none"> • Default setting: [B&W] (black-and-white)

- 1 Quick adjust is not available in **[Neutral]**, **[Monochrome]**, **[Custom 1]**, and **[Custom 2]**.
The values set manually are disabled if quick adjust is used after manual setting.
- 2 Not displayed for **[Monochrome]**.
- 3 Only displayed for **[Monochrome]**.

✔ Notes about [Image sharpening]

The effects of **[Image sharpening]** cannot be previewed on the screen during shooting. Check the results in playback mode.

✔ Notes about [A] (auto) in [Contrast] and in [Saturation]

Results for contrast and saturation vary with the exposure, and the position and size of the subject in the frame.

Custom Picture Control

In Custom Picture Control (COOLPIX Custom Picture Control), customize the settings of **[Picture Control]** and register them in **[Custom 1]** or **[Custom 2]**.

➔ Customizing existing COOLPIX Picture Controls: quick adjust and manual adjust (page 178)

Rotate the mode dial to P, S, A, M, or U* → MENU button → Custom Picture Control →  button

* The setting can also be configured in  (Movie manual) mode.



- 1 Use the multi selector ▲▼ to select **[Edit and save]**, and press the **OK** button.

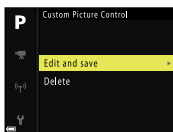

- Select **[Delete]** to delete a registered COOLPIX Custom Picture Control.

- 2 Select the original COOLPIX Picture Control to be edited, and press the **OK** button.

- 3 Use ▲▼ to highlight the desired option and use ◀▶ to select a value.

- The options are the same as those for adjusting the COOLPIX Picture Control.
- Press the **OK** button when you finish adjustment.
- To change the adjusted values to the default setting, select **[Reset]** and press the **OK** button.

- 4 Select the registration destination and press the **OK** button.

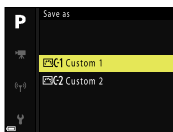

- **[Custom 1]** or **[Custom 2]** becomes selectable in **[Picture Control]**.
- To change the adjusted values, select **[Custom 1]** or **[Custom 2]** in **[Picture Control]**.







White balance

Adjust white balance to suit the light source or weather conditions in order to make the colors in images match what you see with your eyes.

Rotate the mode dial to P, S, A, M, or U* → MENU button → White balance → OK button



* The setting can also be configured in  (Movie manual) mode.

Option	Description
AUTO1 Auto (normal) (default setting)	White balance is automatically adjusted.
AUTO2 Auto (warm lighting)	When set to [Auto (warm lighting)] , the images are preserved with warm colors if they are shot under an incandescent light source. When using the flash, white balance is adjusted according to the flash lighting condition.
PRE Preset manual	Use when the desired result is not achieved with [Auto (normal)] , [Auto (warm lighting)] , [Incandescent] , etc. → Using Preset manual (page 183)
 Daylight*	Use under direct sunlight.
 Incandescent*	Use under incandescent lighting.
 Fluorescent	Use under most types of fluorescent lighting. Choose one of [1] (cool-white fluorescent), [2] (day white fluorescent), and [3] (daylight fluorescent).
 Cloudy*	Use under overcast skies.
 Flash*	Use with the flash.
 Choose color temp.	Use to directly specify color temperature. → Color temperature (page 182)

* Fine adjustments in seven steps are available. Apply positive (+) to increase blue hue and negative (-) to increase red hue.

Notes about [White balance]

- Lower the built-in flash when white balance is set to any setting other than **[Auto (normal)]**, **[Auto (warm lighting)]**, or **[Flash]**.
- This function may not be available to use in combination with other functions.
→ Functions that cannot be used simultaneously when shooting (page 127)

White balance indicator on the shooting screen

 **A1**, which indicates **[Auto (normal)]**, is displayed only immediately after setting using the **Fn** button.

Color temperature

Color temperature is an objective measure of colors of light sources which are expressed in the unit of absolute temperature (K: Kelvin). Light sources with lower color temperature



values appear more reddish, while light sources with higher color temperature values appear more bluish.



- ❶: Sodium-vapor lamps: 2700K
- ❷: Incandescent/Warm-white fluorescent: 3000K
- ❸: White fluorescent: 3700K
- ❹: Cool-white fluorescent: 4200K
- ❺: Day white fluorescent: 5000K
- ❻: Direct sunlight: 5200K
- ❼: Flash: 5400K
- ❽: Cloudy: 6000K
- ❾: Daylight fluorescent: 6500K
- ❿: High temp. mercury-vapor: 7200K
- ⓫: Shade: 8000K

Using Preset manual

Follow the procedures described below to measure the white balance value under the lighting used during shooting.

- 1 Place a white or gray reference object under the lighting that will be used during shooting.
- 2 Use the multi selector ▲▼ to select [**Preset manual**], and press the **OK** button.

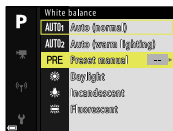

- The lens extends to the zoom position for measurement.



3 Select [Measure].

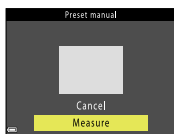

- To apply the last measured value, select [**Cancel**] and press the **OK** button.

4 Frame the white or gray reference object in the measuring window (1), and press the **OK** button to measure the value.

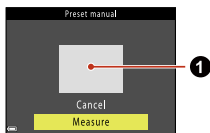

- The shutter is released and measurement is complete (no image is saved).
- If an error message is displayed, perform the procedure again from step 3.

✓ Notes about [Preset manual]

A white balance value for flash lighting cannot be measured with [**Preset manual**]. When shooting using the flash, set [**White balance**] to [**Auto (normal)**], [**Auto (warm lighting)**], or [**Flash**].



Metering

The process of measuring the brightness of the subject to determine the exposure is known as “metering.”

Use this option to set the method of how the camera meters exposure.

Rotate the mode dial to P, S, A, M, or U → MENU button → Metering → **OK button**



Option	Description
 Matrix (default setting)	The camera uses a wide area of the screen for metering. Recommended for typical shooting.
 Center-weighted	The camera meters the entire frame but assigns greatest weight to the subject in the center of the frame. The classic metering for portraits; it preserves background details while letting lighting conditions in the center of the frame determine exposure.*
 Spot	The camera meters the area shown by the circle in the center of the frame. This can be used when the subject is much lighter or darker than the background. Ensure that the subject is within the area shown by the circle when shooting.*

* To set focus and exposure for off-center subjects, change **[AF area mode]** to manual and set the focus area to the center of the frame, and then use focus lock.

→ Focus lock (page 111)

Notes about [Metering]

- When digital zoom is in effect, **[Center-weighted]** or **[Spot]** is selected depending on the zoom ratio.
- This function may not be available to use in combination with other functions.
→ Functions that cannot be used simultaneously when shooting (page 127)

Display on the shooting screen

When **[Center-weighted]** or **[Spot]** is selected, the metering range guide is displayed (except when digital zoom is used).







Continuous

Set single or continuous shooting.

Rotate the mode dial to P, S, A, M, or U → MENU button → Continuous →  button

Option	Description
 Single (default setting)	One image is captured each time the shutter-release button is pressed.



Option	Description
 Continuous H	While the shutter-release button is held all the way down, images are captured continuously. <ul style="list-style-type: none"> The camera can capture up to about 10 images continuously at a rate of about 7 fps.
 Continuous L	While the shutter-release button is held all the way down, images are captured continuously. <ul style="list-style-type: none"> The camera can capture up to about 200 images continuously at a rate of about 1 fps.
 Pre-shooting cache	Pre-shooting cache shooting begins when the shutter-release button is pressed halfway. When the shutter-release button is pressed all the way down, the camera saves the current image as well as the images captured immediately before the button is pressed. Pre-shooting cache makes it easy to capture perfect moments. <ul style="list-style-type: none"> ➔ Pre-shooting cache (page 187) The camera can capture up to about 40 images continuously at a rate of about 15 fps (including a maximum of 10 images captured in the pre-shooting cache). The image quality is fixed at [Normal] and the image size is fixed at  (1280 × 960 pixels).
 Continuous H: 120 fps	Each time the shutter-release button is pressed all the way down, images are captured continuously at a high speed rate. <ul style="list-style-type: none"> The camera can capture up to about 60 images continuously at a rate of about 120 fps. Image size is fixed at VGA (640 × 480 pixels).
 Continuous H: 60 fps	Each time the shutter-release button is pressed all the way down, images are captured continuously at a high speed rate. <ul style="list-style-type: none"> The camera can capture up to about 60 images continuously at a rate of about 60 fps. Image size is fixed at 1080M (1920 × 1080 pixels).
 Intvl timer shooting	The camera automatically captures still images continuously at the specified interval. <ul style="list-style-type: none"> ➔ Interval timer shooting (page 188)

✓ Notes about [Continuous]

- Focus and exposure are fixed at the values determined with the first shot in each series. White balance is also fixed at the value determined with the first shot in each series, except when using **[Continuous L]** or **[Intvl timer shooting]**.



- It may take some time to save the images after shooting or to perform the next operation.
- When ISO sensitivity increases, noise may appear in captured images.
- The frame rate may become slower depending on the image quality, image size, memory card type or shooting conditions (such as when saving RAW images).
- When using [**Continuous H: 120 fps**] or [**Continuous H: 60 fps**], banding or variance in brightness or hue may occur in images that were captured under lighting that flashes quickly at high speeds, such as fluorescent, mercury-vapor, or sodium-vapor lighting.
- This function may not be available to use in combination with other functions.
 - ➔ Functions that cannot be used simultaneously when shooting (page 127)

Pre-shooting cache

When the shutter-release button is pressed halfway or all the way down, images are saved as described below.

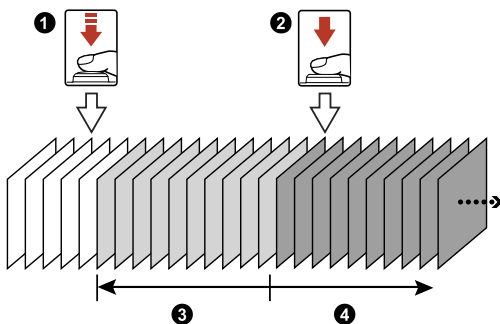

- 1: Press down halfway
 - 2: Press down all the way
 - 3: Images saved before pressing all the way
 - 4: Images saved by pressing all the way
- The pre-shooting cache icon () on the shooting screen changes to green while the shutter-release button is pressed halfway.



Interval timer shooting

Rotate the mode dial to **P, S, A, M, or U** → MENU button → Continuous → OK button → Intvl timer shooting → OK button

- 1 Set the desired interval between each shot.



- Use ◀▶ to select an item, and use ▲▼ to set the time.
- Press the OK button when setting is complete.

- 2 Press the MENU (menu) button to display the shooting screen.

- 3 Press the shutter-release button to shoot the first image.



- The shutter is automatically released at the specified interval to shoot second and subsequent images.
- The screen turns off and the power-on lamp flashes during the intervals between shots.

- 4 When the desired number of images have been captured, press the shutter-release button.

- Shooting ends.
- Shooting ends automatically in the following situations:
 - When the memory card becomes full
 - When 9999 shots are taken in sequence



✔ Notes about [Intvl timer shooting]

- To prevent the camera from turning off unexpectedly during shooting, use a sufficiently charged battery.
- If the EH-5d AC Adapter and the EP-5C Power Connector (both available separately) are used, this camera can be powered from an electrical outlet. Do not, under any circumstances, use an AC adapter other than the EH-5d. Failure to observe this precaution could result in overheating or damage to the camera.
➔ EH-5d AC Adapter and EP-5C Power Connector (page 259)
- Do not rotate the mode dial to a different setting while interval timer shooting is in progress. Doing so causes the camera to stop shooting.
- If the shutter speed is slow and saving an image takes time compared to the specified interval, some of the shots during Interval timer shooting may be canceled.

ISO sensitivity

A higher ISO sensitivity allows darker subjects to be captured. Additionally, even with subjects of similar brightness, pictures can be taken at faster shutter speeds, and blurring caused by camera shake and subject movement can be reduced.

- When a higher ISO sensitivity is set, images may contain noise.

Rotate the mode dial to P, S, A, M, or U* ➔ MENU button ➔ ISO sensitivity ➔ OK button

* The setting can also be configured in  (Movie manual) mode.

Option	Description
ISO sensitivity	<ul style="list-style-type: none">• [100-400]: Sensitivity is automatically selected from the range of 100 to 400.• [100-800]: Sensitivity is automatically selected from the range of 100 to 800.• [100-1600] (default setting): Sensitivity is automatically selected from the range of 100 to 1600.• [100-3200]: Sensitivity is automatically selected from the range of 100 to 3200.• [100-6400]: Sensitivity is automatically selected from the range of 100 to 6400.• [100] to [6400]: ISO sensitivity is fixed at the specified value.







Option	Description
Minimum shutter speed	<p>Set the shutter speed at which ISO sensitivity starts to be automatically adjusted when the shooting mode is P or A. If the exposure is insufficient with the shutter speed that is set here, the ISO sensitivity is increased automatically to obtain the optimal exposure.</p> <ul style="list-style-type: none"> • The setting is enabled when [ISO sensitivity] is set to [100-400], [100-800], [100-1600], [100-3200], or [100-6400]. • If the exposure is still insufficient even after ISO sensitivity is increased, the shutter speed slows down. • Default setting: [None] • Not displayed in  (Movie manual) mode.

Notes about [ISO sensitivity]

This function may not be available to use in combination with other functions.

 Functions that cannot be used simultaneously when shooting (page 127)

ISO sensitivity display on the shooting screen

- In **P**, **S**, **A**, **M**, **U**, and Movie manual modes,  and the maximum value for ISO sensitivity are displayed when **[100-400]**, **[100-800]**, **[100-1600]**, **[100-3200]**, or **[100-6400]** is selected. If the ISO sensitivity is fixed,  and the setting value are displayed.
- If the shooting mode is not **P**, **S**, **A**, **M**, or **U**, and  is displayed, the ISO sensitivity is automatically set and the maximum value for ISO sensitivity is displayed.
- In all other shooting modes,  is displayed only when the sensitivity increases.

Exposure bracketing

The exposure (brightness) can be changed automatically during continuous shooting. This is effective for shooting when it is difficult to adjust the picture brightness.

Rotate the mode dial to P, S, or A → MENU button → Exposure bracketing →  button

Option	Description
Off (default setting)	Exposure bracketing is not performed.



Option	Description
±0.3	When the shutter-release button is pressed all the way, 3 shots are taken in sequence and the camera varies exposure by 0, -0.3, and +0.3 over the shots.
±0.7	When the shutter-release button is pressed all the way, 3 shots are taken in sequence and the camera varies exposure by 0, -0.7, and +0.7 over the shots.
±1.0	When the shutter-release button is pressed all the way, 3 shots are taken in sequence and the camera varies exposure by 0, -1.0, and +1.0 over the shots.

☑ Notes about [Exposure bracketing]

- [Exposure bracketing] is not available in **M** (manual) mode.
- When exposure compensation and [±0.3], [±0.7], or [±1.0] in [Exposure bracketing] are set simultaneously, the combined exposure compensation values are applied.
- This function may not be available to use in combination with other functions.
 - ➔ Functions that cannot be used simultaneously when shooting (page 127)

AF area mode







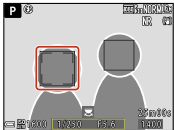
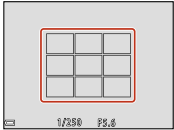

Set how the camera selects the focus area for autofocus.

Rotate the mode dial to P, S, A, M, or U → MENU button → AF area mode →  button

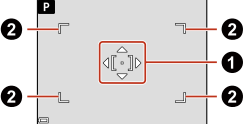
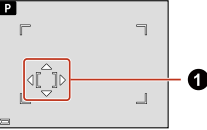

Option	Description
<p>Face priority</p>	<p>When the camera detects a human face, it focuses on that face. ➔ Using face detection (page 110)</p>  <p>When framing a composition with no human subjects or detected faces, the camera automatically selects one or more of the nine focus areas containing the subject closest to the camera when the shutter-release button is pressed halfway.</p> 

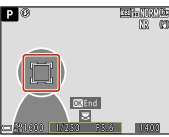

Option	Description
<p>[] Manual (spot) [] Manual (normal) [] Manual (wide)</p>	<p>Use the multi selector  or rotate it to move the focus area (1) to where you want to focus.</p> <p>You can move it within the range of the movable area guide (2).</p> <ul style="list-style-type: none"> When at the center  <ul style="list-style-type: none"> When moving  <p>To use the multi selector to configure the flash mode or other settings, press the  button. To return to moving the focus area, press the  button again.</p>
<p> Subject tracking</p>	<p>Use this function to take pictures of moving subjects. Register the subject on which the camera focuses. The focus area automatically moves to track the subject.</p> <p> Using subject tracking (page 194)</p> 

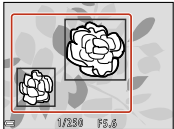

Option	Description
[] Target finding AF (default setting)	When the camera detects the main subject, it focuses on that subject. → Using target finding AF (page 108) <div data-bbox="249 213 474 379" style="border: 1px solid gray; padding: 5px; margin-top: 10px;">  </div>



Notes about [AF area mode]

- When digital zoom is in effect, the camera focuses on the area in the center of the frame regardless of the **[AF area mode]** setting.
- When the focus-mode selector is set to **MF** (manual focus), **[AF area mode]** cannot be set.
- This function may not be available to use in combination with other functions.
 → Functions that cannot be used simultaneously when shooting (page 127)

[AF area mode] in Bird-watching mode

If you press the **MENU** button in Bird-watching mode, you can set **[AF area mode]** to **[Center (spot)]** (default setting), **[Center (normal)]**, or **[Center (wide)]**. Set according to the size of the subject and the focus range.

Using subject tracking

Rotate the mode dial to **P, S, A, M, or U** → **MENU** button → **AF area mode**
 →  button →  **Subject tracking** →  button → **MENU** button



1 Register a subject.

- Align the subject that you want to track with the border in the center of the frame and press the **OK** button.



- When the subject is registered, a yellow border (focus area) is displayed around it and the camera begins tracking the subject.



- If the subject cannot be registered, the border is displayed in red. Change the composition and try registering the subject again.
- To cancel subject registration, press the **OK** button.
- If the camera can no longer track the registered subject, the focus area disappears. Register the subject again.

2 Press the shutter-release button all the way to take the picture.

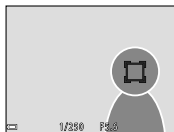

- If the shutter-release button is pressed while the focus area is not displayed, the camera focuses on the subject in the center of the frame.

Notes about [Subject tracking]

- If you perform operations such as zooming while the camera is tracking the subject, the registration is canceled.
- Subject tracking may not be possible in certain shooting conditions.



Autofocus mode

Set how the camera focuses when shooting still images.

Rotate the mode dial to **P, S, A, M, or U** → MENU button → **Autofocus mode** → **OK** button

Option	Description
AF-S Single AF	The camera focuses only when the shutter-release button is pressed halfway.
AF-F Full-time AF (default setting)	The camera always focuses even if the shutter-release button is not pressed halfway. The sound of lens drive movement is heard while the camera focuses.

✓ Notes about [Autofocus mode]

- When the focus-mode selector is set to **MF** (manual focus), [Autofocus mode] cannot be set.
- This function may not be available to use in combination with other functions.
→ Functions that cannot be used simultaneously when shooting (page 127)

✓ Autofocus mode for movie recording

Autofocus mode for movie recording can be set in the movie menu → [Autofocus mode (page 206)].

Flash exp. comp.

Adjust the flash output.

Use this option when the flash is too bright or too dark.

- If the compensation value you want to set is not displayed on the setting screen, press the multi selector ▲▼ until it is displayed.

Rotate the mode dial to **P, S, A, M, or U** → MENU button → **Flash exp. comp.** → **OK** button

Option	Description
+0.3 to +2.0	The flash output is increased from +0.3 to +2.0 EV, in increments of 1/3 EV, to make the main subject of the frame appear brighter.
0.0 (default setting)	The flash output is not adjusted.



Option	Description
-0.3 to -2.0	The flash output is reduced from -0.3 to -2.0 EV, in increments of 1/3 EV, to prevent unwanted highlights or reflections.

Noise reduction filter

Set the strength of the noise reduction function that is normally performed when saving images.

Rotate the mode dial to P, S, A, M, or U → MENU button → Noise reduction filter →  button

Option	Description
NR⁺ High	Performs noise reduction at a level higher than the standard strength.
NR Normal (default setting)	Performs noise reduction at the standard strength.
NR⁻ Low	Performs noise reduction at a level lower than the standard strength.

Long exposure NR

Reduce “noise” (bright spots or fog) in photos taken at slow shutter speeds.

Rotate the mode dial to P, S, A, M, or U → MENU button → Long exposure NR →  button

Option	Description
 Auto (default setting)	Reduce noise if the shutter speed is 1/4 of a second or slower.
OFF Off	Do not reduce noise.



Active D-Lighting

Details in highlights and shadows are preserved, and the natural contrast that is seen with the naked eye is well reproduced in the image captured. This is particularly



effective for shooting conditions with high contrast, such as brightly lit outdoor scenery from a dark room or shaded subjects at a sunny seaside.

Rotate the mode dial to P, S, A, M, or U → MENU button → Active D-Lighting →  button

Option	Description
 H High  N Normal  L Low	Set the effect level.
OFF Off (default setting)	Active D-Lighting is not applied.

Notes about [Active D-Lighting]

- Additional time is required to save images after shooting.
- When using [**Active D-Lighting**], noise (randomly-spaced bright pixels, fog, lines) may be emphasized, dark shadows may appear around bright subjects, or bright areas may appear around dark subjects under some shooting conditions.
- When using [**Active D-Lighting**], gradation skipping may occur depending on the subject.
- This function may not be available to use in combination with other functions.
 - ➔ Functions that cannot be used simultaneously when shooting (page 127)

[Active D-Lighting] versus [D-Lighting]

- The [**Active D-Lighting**] option captures images while reducing loss of details in highlights, and adjusts the tone when saving images.
- The playback menu → [**D-Lighting (page 213)**] option adjusts the tone of saved images.

Multiple exposure

The camera combines two to three images and saves them as a single image.

Rotate the mode dial to P, S, A, M, or U → MENU button → Multiple exposure →  button



Option	Description
Multiple exposure mode	Shoots images in multiple exposure mode when set to [On] . <ul style="list-style-type: none"> Individual images are also saved. Default setting: [Off]
Auto gain	Set whether or not to automatically adjust the brightness of the image when combining images. <ul style="list-style-type: none"> Default setting: [On]

☑ Notes about [Multiple exposure]

- It may take some time to combine images.
- Multiple exposure is terminated if the **[Auto off (page 238)]** function triggers the standby mode during shooting. When shooting with a long interval between shots, setting a longer time for the auto off function is recommended.
- This function may not be available to use in combination with other functions.
 - ➔ Functions that cannot be used simultaneously when shooting (page 127)
- When shooting at a slow shutter speed in multiple exposure mode, noise (bright spots) may appear in saved images.

Multiple exposure shooting

- 1 In **[Multiple exposure mode]**, select **[On]**, and press the **OK** button.

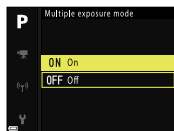

- After setting, press the **MENU** (menu) button to return to the shooting screen.



2 Press the shutter-release button to shoot the first image.



3 Press the shutter-release button to shoot the second image.



- Frame the picture while looking at the first image displayed translucently.
- When shooting the second image, the combined image of the first and second images is saved, and displayed translucently.
- To end multiple exposure at the second image, set [**Multiple exposure mode**] to [**Off**] or change the mode dial to any mode other than **P**, **S**, **A**, **M**, or **U**.

4 Press the shutter-release button to shoot the third image.

- The combined image of the first to third images is saved and multiple exposure ends.
- It may take some time until the third image is shot.

Zoom memory

When the zoom control is moved, the zoom position (equivalent to focal length/angle of view in 35mm [135] format) is switched to the positions that have been selected by setting the check box to on in this menu option.

Rotate the mode dial to **P**, **S**, **A**, **M**, or **U** → MENU button → Zoom memory → OK button



Option	Description
On	<ul style="list-style-type: none"> Choose the focal length with the multi selector ▲▼, and then press the  button to set the check box to on [✔] or off. The following settings are available: [24 mm], [28 mm], [35 mm], [50 mm], [85 mm], [105 mm], [135 mm], [200 mm], [300 mm], [400 mm], [500 mm], [600 mm], [800 mm], [1000 mm], [1200 mm], [1400 mm], [1600 mm], [1800 mm], and [2000 mm]. Default setting: On [✔] for all the check boxes To finish setting, press the multi selector ►. The zoom position set in the [Startup zoom position] is automatically set to on [✔]. The zoom memory function cannot be used with the side zoom control.
Off (default setting)	The zoom position can be moved to any position, including the positions that can be set with [On].

Notes about zoom operation

- When more than one focal length has been set, move the zoom control to switch to the focal length closest to that before the operation. To switch to a different focal length, release the zoom control and then move it again.
- Set [Zoom memory] to [Off] when using the digital zoom.

Startup zoom position

Set the zoom position (equivalent to focal length/angle of view in 35mm [135] format) for when the camera is turned on.

Rotate the mode dial to P, S, A, M, or U → MENU button → Startup zoom position → 

The following settings are available: [24 mm] (default setting), [28 mm], [35 mm], [50 mm], [85 mm], [105 mm], and [135 mm].

M exposure preview

Set whether or not to reflect the brightness to the shooting screen when the exposure is changed in **M** (manual) mode.

Rotate the mode dial to P, S, A, M, or U → MENU button → M exposure preview → 



Option	Description
On	Reflects the brightness to the shooting screen.
Off (default setting)	Does not reflect the brightness to the shooting screen.



The Movie manual mode menu

You can set the following menu options. See each page for more information.

- ➔ Exposure mode (page 150)
- ➔ Picture Control (page 177)
- ➔ Custom Picture Control (page 180)
- ➔ White balance (page 181)
- ➔ ISO sensitivity (page 189)
- ➔ Movie options (page 204)
- ➔ Autofocus mode (page 206)
- ➔ Electronic VR (page 207)
- ➔ Wind noise reduction (page 208)
- ➔ Zoom microphone (page 208)
- ➔ Frame rate (page 209)
- ➔ External mic sensitivity (page 209)



The movie menu

Movie options











Select the desired movie option to record. Select normal speed movie options to record at normal speed, or HS movie options to record in slow or fast motion. The options that can be selected vary depending on **[Frame rate (page 209)]**.

- Memory cards with an SD Speed Class rating of 6 (Video Speed Class V6) or faster are recommended for recording movies. When **[Movie options]** is set to **[2160/30p]** (4K UHD) or **[2160/25p]** (4K UHD), memory cards with a UHS Speed Class rating of 3 (Video Speed Class V30) or faster are recommended.

Shooting mode → **MENU button** → **🎬 (movie menu)** → **OK button** → **Movie options*** → **OK button**

* You can also select by pressing the **MENU** button in **🎬📖 (Movie manual)** mode.

Normal speed movie options

Option (Image size/ Frame rate, File format)	Image size	Aspect ratio (horizontal to vertical)	Max. recording time per file (approx.)
 2160/30p (4K UHD)	3840 × 2160	16:9	7 min
 2160/25p (4K UHD)			8 min
 1080/30p (default setting)	1920 × 1080	16:9	26 min
 1080/25p (default setting)			29 min
 1080/60p	1920 × 1080	16:9	13 min
 1080/50p			16 min
 720/30p	1280 × 720	16:9	29 min
 720/25p			
 720/60p	1280 × 720	16:9	27 min
 720/50p			29 min





- Individual movie files cannot exceed 29 minutes in length, even when there is sufficient free space on the memory card for longer recording. The maximum size of a single movie file is 4 GB. If a file exceeds 4 GB even when you record for less than 29 minutes, it is split into multiple files and cannot be played back continuously.
Recording may end before the maximum recording time is reached if the camera temperature becomes elevated.
- The actual remaining recording time may vary depending on the movie content, subject movement, or type of memory card.

HS movie options

Recorded movies are played back in fast or slow motion.

➔ Playing back in slow motion and fast motion (page 206)

Option	Image size Aspect ratio (horizontal to vertical)	Description
 HS 480/4x	640×480 4:3	1/4-speed slow motion movies <ul style="list-style-type: none"> Max. recording time: 7 minutes 15 seconds (playback time: 29 minutes)
 HS 720/2x	1280×720 16:9	1/2-speed slow motion movies <ul style="list-style-type: none"> Max. recording time: 14 minutes 30 seconds (playback time: 29 minutes)
 HS 1080/0.5x	1920×1080 16:9	2x speed fast motion movies <ul style="list-style-type: none"> Max. recording time: 29 minutes (playback time: 14 minutes 30 seconds)

Notes about HS movie

- Sound is not recorded.
- Still images cannot be saved during movie recording.
- Movie recording cannot be paused.
- Zoom position, focus, exposure, and white balance are locked when movie recording starts.



Playing back in slow motion and fast motion

- When recording at normal speed

Example:

Recording time of 10 s (1)

Playback time of 10 s (2)

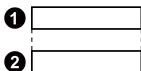

- When recording at $\frac{480}{125}$ [HS 480/4x]

Movies are recorded at 4x normal speed. They are played back in slow motion at 4x slower speed.

Example:

Recording time of 10 s (1)

Playback time of 40 s (2)

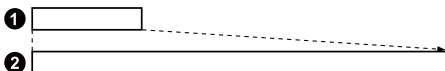

- When recording at $\frac{1080}{125}$ [HS 1080/0.5x]

Movies are recorded at 1/2 normal speed. They are played back in fast motion at 2x faster speed.

Example:

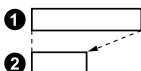

Recording time of 10 s (1)

Playback time of 5 s (2)



Autofocus mode

Set how the camera focuses when recording movies.

Shooting mode → MENU button →  (movie menu) →  button → **Autofocus mode*** →  button

* You can also select by pressing the MENU button in  (Movie manual) mode.



Option	Description
AF-S Single AF (default setting)	Focus is locked when movie recording starts. Select this option when the distance between the camera and the subject will remain fairly consistent.
AF-F Full-time AF	The camera focuses continuously. Select this option when the distance between the camera and subject will change significantly during recording. The sound of the camera focusing may be heard in the recorded movie. Use of [Single AF] is recommended to prevent the sound of the camera focusing from interfering with recording.

☑ Notes about [Autofocus mode]

- When an HS movie option is selected in **[Movie options]**, the setting is fixed at **[Single AF]**.
- When the focus-mode selector is set to **MF** (manual focus), **[Autofocus mode]** cannot be set.
- This function may not be available to use in combination with other functions.
 → Functions that cannot be used simultaneously when shooting (page 127)

Electronic VR

Select the vibration reduction setting used when recording movies.

Shooting mode → MENU button →  (movie menu) → OK button → Electronic VR* → OK button

* You can also select by pressing the **MENU** button in  (Movie manual) mode.

Option	Description
On (default setting)	Performs electronic VR. <ul style="list-style-type: none"> • The angle of view (i.e., the area seen in the frame) becomes narrower. • When the setup menu → [Vibration reduction] is set to [Normal], [Active], [Normal (framing first)], or [Active (framing first)], optical vibration reduction is performed simultaneously.
Off	Does not perform electronic VR.





✔ Notes about [Electronic VR]

When [2160/30p], [2160/25p], or an HS movie option is selected in [Movie options], the setting is fixed at [Off].

Wind noise reduction

Reduces the sound that is produced when wind passes over the microphone during movie recording.

Shooting mode → MENU button →  (movie menu) →  button → Wind noise reduction* →  button

* You can also select by pressing the MENU button in  (Movie manual) mode.



Option	Description
On	Wind noise reduction is enabled.
Off (default setting)	Wind noise reduction is disabled.

✔ Notes about [Wind noise reduction]

- When [On] is selected, other sounds may become difficult to hear during playback.
- When an HS movie option is selected in [Movie options], the setting is fixed at [Off].

Zoom microphone

In accordance with the angle of view, the camera records sounds over a wide area at the wide-angle zoom position, and records sounds in the limited area at the telephoto zoom position.

Shooting mode → MENU button →  (movie menu) →  button → Zoom microphone* →  button

* You can also select by pressing the MENU button in  (Movie manual) mode.

Option	Description
On (default setting)	Zoom microphone is enabled.
Off	Zoom microphone is disabled.





✔ Notes about [Zoom microphone]

The setting is fixed at [Off] in the following situations:

- When an HS movie option is selected in [Movie options]
- When an external microphone is connected

Frame rate

Select the frame rate used when recording movies. When the frame rate setting is switched, options that can be set in [Movie options] change.

Shooting mode → MENU button →  (movie menu) →  button → Frame rate* →  button

* You can also select by pressing the MENU button in  (Movie manual) mode.

Option	Description
30 fps (30p/60p)	Suited for playback on a TV using the NTSC standard.
25 fps (25p/50p)	Suited for playback on a TV using the PAL standard.



External mic sensitivity

Set the sensitivity of the microphone that is connected to the camera's external microphone connector.

This option can be set only when an external microphone is connected.

Shooting mode → MENU button →  (movie menu) →  button → External mic sensitivity* →  button

* You can also select by pressing the MENU button in  (Movie manual) mode.

Option	Description
 A Auto sensitivity (default setting)	The sensitivity of the external microphone is set automatically.
 M Manual sensitivity	The sensitivity of the external microphone is set manually.



Using the manual sensitivity screen

- The input level from the external microphone is displayed in the indicator (1).

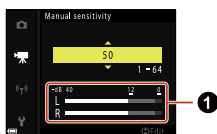

- Use the multi selector to adjust the value and press the **OK** button to apply the setting.



The playback menu

Mark for upload

Select individual still images on the camera's playback screen to upload to a paired smart device.

Use this function when the network menu → [Send while shooting] → [Still images] is set to [No], or when uploading images that are not selected using [Upload (photos)].

To upload images, the SnapBridge app must be configured. SnapBridge app → 📷 tab → [Auto link] → enable [Auto download].

For use of the SnapBridge app, see the online help of the SnapBridge app (<https://nikonimglib.com/snbr/onlinehelp/en/index.html>).

Playback mode → MENU button → Mark for upload → Ⓞ button

- 1 Use the multi selector ◀▶ or rotate it to select the image you want to upload to a smart device.

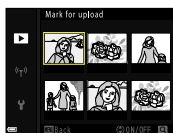

- Move the zoom control toward **T** (🔍) to switch to full-frame playback, or **W** (🖼️) to switch to thumbnail playback.

- 2 Use ▲▼ to select ON or OFF.

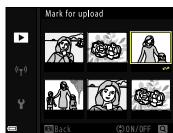

- When ON is selected, 📶 is displayed under the selected image. Repeat steps 1 and 2 to select additional images.



3 Press the **OK** button to apply the image selection.

- The selected still images are uploaded to the smart device.

✓ Notes about [Mark for upload]

- Still images are uploaded at an image size of up to 2 megapixels.
- RAW images and movies cannot be selected for upload.
- To upload original files (image size set in the camera) of still images or to upload movies, use **[Download pictures]** in the SnapBridge app.
- Note that when you select the setup menu → **[Reset all]** or the network menu → **[Restore default settings]**, the Mark for upload settings that you made are canceled and the camera settings are also reset to default.
- To cancel the Mark for upload settings, go to step 2 and hide .

✍ [Send while shooting]

When you use the network menu → **[Send while shooting (page 224)]**, still images can be sent automatically to a smart device every time they are captured with the camera.

Quick retouch

Easily create images with high contrast and vivid colors.

Playback mode → **select an image** → **MENU button** → **Quick retouch** → **OK button**

- See “ Before editing images (page 142)” for information about restrictions on editing.

1 Use the multi selector to select the desired effect level and press the **OK** button.

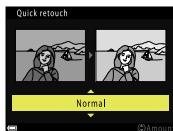

- The edited version is displayed on the right.
- To exit without saving the selection, press .



D-Lighting

Correct areas that are dark due to backlighting or insufficient light from the flash.

Playback mode → select an image → MENU button → D-Lighting → OK button

- See “Before editing images (page 142)” for information about restrictions on editing.

- 1 Use the multi selector ▲▼ to select the desired effect level and press the OK button.

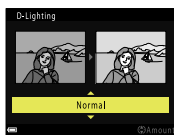

- The edited version is displayed on the right.
- To exit without saving the selection, press ◀.

Skin softening

Softens skin tones.

Playback mode → select an image → MENU button → Skin softening → OK button

- See “Before editing images (page 142)” for information about restrictions on editing.



- 1 Use the multi selector ▲▼ to select the desired effect level and press the **OK** button.

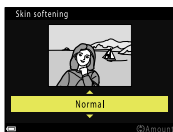

- To exit without saving the copy, press ◀.

- 2 Preview the result and press the **OK** button.



- The edited face is zoomed in.
- When more than one face has been edited, press ◀▶ to switch the face that is displayed.
- To change the effect level, press the **MENU** button and return to step 1.

✔ Notes about [Skin softening]

- The skin tones can be enhanced for up to 12 faces, starting with the one closest to the center of the frame and moving outward.
- Depending on the direction in which faces are looking, or the brightness of faces, the camera may be unable to accurately detect faces, or the skin softening function may not perform as expected.
- If no faces are detected, a warning is displayed and the screen returns to the playback menu.

Filter effects

Use digital filters to apply various effects.

Playback mode → select an image → MENU button → Filter effects → **OK button**



- See “Before editing images (page 142)” for information about restrictions on editing.

Option	Description
Soft portrait	Blurs the background of human subjects. When no human subjects are detected, keeps the area in the center of the frame in focus and blurs the surrounding area.
Selective color	Keeps only a selected color and makes other colors black-and-white.
Cross screen	Produces star-like rays of light that radiate outward from bright objects such as sunlight reflections and city lights. Suitable for night scenes.
Fisheye	Creates images that look like they were shot with a fisheye lens. Suitable for images shot in macro mode.
Miniature effect	Creates images that look like close-up photos of a diorama. Suitable for images shot while looking down from a high location, with the main subject near the center of the frame.
Painting	Creates images with the ambience of paintings.
Vignette	Lowers the peripheral light intensity from the center to the edges of an image.
Photo illustration	Emphasizes outlines and reduces the number of colors to create images with the ambience of illustrations.
Portrait (color + B&W)	Makes colors of the background of human subjects black-and-white. When no human subjects are detected, keeps colors of the area in the center of the frame and makes the surrounding area black-and-white.

- 1 Use the multi selector ▲▼ to select the desired filter effect and press the **OK** button.

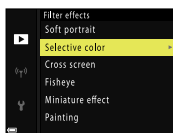

- If you selected an effect other than **[Selective color]**, proceed to step 3.



2 Use ▲▼ to select the color to keep and press the OK button.



3 Preview the result and press the OK button.



- An edited copy is created.
- To exit without saving the copy, press ◀.

Slide show

Allows you to view images in an automated slide show. When movie files are played back in the slide show, only the first frame of each movie is displayed.

Playback mode → MENU button → Slide show → OK button



- 1 Use the multi selector ▲▼ to select **[Start]** and press the **OK** button.

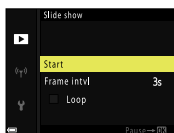

- The slide show begins.
- To change the interval between images, select **[Frame intvl]**, press the **OK** button, and specify the desired interval time before selecting **[Start]**.
- To repeat the slide show automatically, select **[Loop]** and press the **OK** button before selecting **[Start]**.
- The maximum playback time is up to about 30 minutes even if **[Loop]** is enabled.

2 End or restart the slide show.

- The following screen is displayed after the slide show ends or is paused. To exit the show, select **■** and then press the **OK** button. To resume the slide show, select **▶** and then press the **OK** button.



Operations during slide show playback

Function	Operation
Display the previous/next image	Press the multi selector ▲▼◀▶. Press and hold them down to change images quickly.
Pause or end the slide show	Press the OK button.



Protect

The camera protects selected images from accidental deletion.

Playback mode → **MENU button** → **Protect** → **OK button**

- 1 Use the multi selector ◀▶ or rotate it to select the desired image.



- Move the zoom control toward **T** (🔍) to switch to full-frame playback, or **W** (🖼️) to switch to thumbnail playback.

- 2 Use ▲▼ to select ON or OFF.



- When ON is selected, **ON** is displayed under the selected image. Repeat steps 1 and 2 to set **[Protect]** on additional images.

- 3 Press the **OK** button to apply the setting.

✓ Notes about [Protect]

Formatting the memory card permanently deletes all data including protected files.

Rotate image

Specify the orientation in which saved images are displayed during playback. Still images can be rotated 90 degrees clockwise or 90 degrees counterclockwise. Images that were saved in the “tall” orientation can be rotated up to 180 degrees in either direction.



Playback mode → MENU button → Rotate image → OK button

- 1 Use the multi selector ◀▶ or rotate it to select the image you want to rotate, and press the OK button.



- Move the zoom control toward **T** (🔍) to switch to full-frame playback, or **W** (🖼️) to switch to thumbnail playback.



-
- 2 Use ► or rotate the multi selector to rotate 90 degrees clockwise (1), and use ◀ or rotate the multi selector to rotate 90 degrees counterclockwise (2).





-
- 3 Press the  button to apply the orientation.

- The orientation information is saved with the image.

Small picture

Create a small copy of images.

Playback mode → select an image → MENU button → Small picture →  button

- See “ Before editing images (page 142)” for information about restrictions on editing.



- 1 Use the multi selector ▲▼ to select the desired copy size and press the **OK** button.

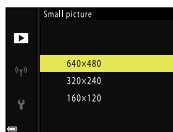

- When the aspect ratio of the image is 16:9, the image size is fixed at 640 × 360. Press the **OK** button to proceed to step 2.

- 2 Select **[Yes]** and press the **OK** button.

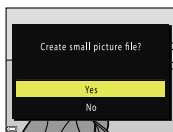

- An edited copy is created (compression ratio of approximately 1:8).

✓ Notes about [Small picture]

When the aspect ratio of the image is 3:2 or 1:1, the image cannot be edited.

Sequence display

Select the method used to display images in the sequence.

- Settings are applied to all sequences, and the settings are saved in the camera's memory even after the camera is turned off.

Playback mode → MENU button → Sequence display → **OK button**

Option	Description
Individual pictures	Displays each image in a sequence individually.  is displayed on the playback screen.



Option	Description
Key picture only (default setting)	Displays only the key picture for images in a sequence. Press the OK button on the playback screen to display images in a sequence. → Viewing images in a sequence (page 138)

Key picture selection

Specify a different image in the sequence as the key picture.

Playback mode → **display a sequence for which you want to change the key picture** → **MENU button** → **Key picture selection** → **OK button**

- 1 Use the multi selector ◀▶ or rotate it to select the image you want to set as the key picture, and press the **OK** button.

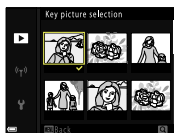

- Move the zoom control toward **T** (🔍) to switch to full-frame playback, or **W** (🖼️) to switch to thumbnail playback.



The network menu

Configure settings when establishing a wireless connection between the camera and a smart device, or the camera and ML-L7 Remote Control (available separately).

MENU button →  (network menu) →  button

Connecting to a smart device

When you connect to a smart device, you can upload images captured with the camera to the smart device or operate the camera remotely with the smart device. Install the SnapBridge app on the smart device.

Select the network menu → **[Choose connection]** → **[Smart device]** (default setting) in advance.

- The connection methods are as follows.
 - Bluetooth connection: You can automatically upload still images (uploaded at an image size of up to 2 megapixels). When establishing a Bluetooth connection for the first time, use the network menu → **[Connect to smart device]** to pair the camera and smart device using the SnapBridge app. You can also switch to a Wi-Fi connection after establishing a Bluetooth connection.
 - Wi-Fi connection: You can download still images (2 megapixels or original file) and movies to the smart device or perform remote photography.
- For connections or use of the SnapBridge app, see the online help of the SnapBridge app (<https://nikonimglib.com/snbr/onlinehelp/en/index.html>).

Connecting to the remote control

Select the network menu → **[Choose connection]** → **[Remote control]** in advance. The camera and remote control are connected through Bluetooth. When connecting to the remote control for the first time, pair the camera and remote control.

➔ ML-L7 Remote Control (page 262)

Network menu list

Some options cannot be set while a wireless connection is established. To set them, disconnect the wireless connection.

Option	Description
Airplane mode	Select [On] to turn off all wireless connections.







Option	Description	
Choose connection	Select whether to connect the camera to [Smart device] (default setting) or [Remote control] .	
Connect to smart device	Pair when connecting to a smart device through Bluetooth for the first time. For details, see the online help for the SnapBridge app (https://nikonimglib.com/snbr/onlinehelp/en/index.html).	
Connection to remote	Pair when connecting to the ML-L7 Remote Control (available separately) for the first time. ➔ Pairing the camera and remote control (page 265)	
Send while shooting	Still images	When set to [Yes] , still images can be sent automatically to a smart device connected through Bluetooth every time they are captured. <ul style="list-style-type: none"> • To send automatically, the SnapBridge app must also be configured. SnapBridge app ➔  tab ➔ [Auto link] ➔ enable [Auto download]. • Still images are uploaded at an image size of up to 2 megapixels. To upload original files (image size set in the camera), use the SnapBridge app ➔ [Download pictures]. • If you use the playback menu ➔ [Mark for upload (page 211)], you can select still images on the camera's playback screen to automatically upload them to a smart device.
	Upload (photos)	Set the conditions for automatically sending still images.
Wi-Fi	Network settings	[SSID]: Set a 1- to 32-character alphanumeric SSID. ➔ Inputting characters (page 226)
		[Auth./encrypt.]: Select whether to encrypt communications. Communications are not encrypted when [Open] is selected.
		[Password]: Set an 8- to 36-character alphanumeric password. ➔ Inputting characters (page 226) <ul style="list-style-type: none"> • To protect your privacy, we recommend that you change the password regularly.



Option	Description
Wi-Fi	Network settings [Channel]: Select the channel used for the Wi-Fi connection. If the communication quality is poor or the image upload speed is extremely slow when using a Wi-Fi connection, try changing the channel.
	[Subnet mask]: Use the default setting ([255.255.255.0]) under normal conditions.
	[DHCP server IP address]: Use the default setting ([192.168.0.10]) under normal conditions.
	Current settings Confirm the current [Network settings] in a list.
Bluetooth	Connection Select [Enable] or [Disable] for Bluetooth communication.
	Paired devices Display smart devices that have been paired. You can change the smart device to connect with, or delete paired smart devices. <ul style="list-style-type: none"> • This camera can be paired with up to five smart devices (only one device can be connected at a time).
	Send while off Select [On] or [Off] to set whether the camera communicates with the smart device when the camera is off or in standby mode.
Restore default settings	Restore all network menu settings to their default values.

Bluetooth communication indicator and Wi-Fi communication indicator on the shooting screen

- About the Bluetooth communication indicator
 - When the camera is connected to a smart device via Bluetooth,  is displayed.
 - When the camera is waiting for the connection to a smart device to be reestablished,  flashes. It also flashes when Bluetooth communication is disconnected while uploading images.
- About the Wi-Fi communication indicator
 - When the camera is preparing to connect to a smart device via Wi-Fi,  flashes.
 - When the camera is connected to a smart device via Wi-Fi,  is displayed.



Inputting characters



- Use the multi selector ▲▼◀▶ to select alphanumeric characters on the keyboard (1). Press the OK button to enter the selected character in the text field (2) and move the cursor to the next space.
- To move the cursor in the text field, select ← or → on the keyboard, and press the OK button.
- To delete one character, press the  button.
- To apply the setting, select ↵ on the keyboard and press the OK button.



The setup menu

Time zone and date

Set the camera clock.

MENU button → Y (setup) → OK button → Time zone and date → OK button

Option	Description
Date and time	<p>Set the date and time.</p>  <ul style="list-style-type: none">• Select a field: Press the multi selector ◀▶.• Edit the date and time: Press ▲▼. Date and time can also be changed by rotating the multi selector or command dial.• Apply the setting: Select the minute field setting and press the OK button or ▶.
Date format	<p>Select [Year/Month/Day], [Month/Day/Year], or [Day/Month/Year].</p>
Time zone	<p>Set time zone and daylight saving time.</p> <ul style="list-style-type: none">• When [Travel destination] (🚶) is set after having set the home time zone (🏠), the time difference between the travel destination and the home time zone is automatically calculated, and the date and time are saved for the selected region.

✓ Notes about [Date and time]

If the time and location information are set to sync with the auto link feature in the SnapBridge app, the date and time cannot be set in the camera.

To manually set this option, disable the sync setting in the SnapBridge app.



Setting the time zone

- 1 Use the multi selector ▲▼ to select **[Time zone]** and press the **OK** button.

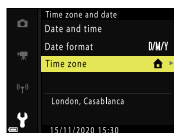

- 2 Select **Home time zone** or **Travel destination** and press the **OK** button.

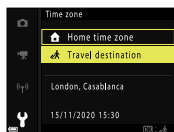

- The date and time displayed on the screen changes depending on whether the home time zone or travel destination is selected.

- 3 Press ►.

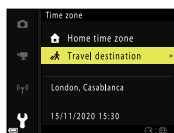

4 Use ◀▶ to select the time zone.

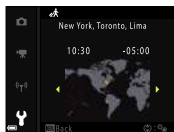

- Press ▲ to enable daylight saving time function, and ☀ is displayed. Press ▼ to disable the daylight saving time function.
- Press the Ⓞ button to apply the time zone.
- If the correct time is not displayed for the home or travel destination time zone setting, set the appropriate time in **[Date and time]**.

Slot empty release lock

Set whether or not the shutter can be released when no memory card is inserted in the camera.

MENU button → Y (setup) → Ⓞ button → Slot empty release lock → Ⓞ button

Option	Description
Release locked (default setting)	Unless a memory card is inserted in the camera, the shutter cannot be released.
Enable release	Even when no memory card is inserted in the camera, the shutter can be released. However, [Demo mode] is displayed on the image captured when no memory card is inserted and the image cannot be saved on a memory card, although the image is displayed on the screen. Also, the image cannot be transferred to a smart device.

Monitor settings

Configure settings such as image review and monitor brightness.

MENU button → Y (setup) → Ⓞ button → Monitor settings → Ⓞ button



Option	Description
Image review	Set whether or not to display the captured image immediately after shooting. <ul style="list-style-type: none"> • Default setting: [On]
Monitor options	Adjust the monitor brightness and hue. <ul style="list-style-type: none"> • Use the multi selector ▲▼ to adjust brightness, ◀▶ to adjust hue and then press the OK button. • Default setting: Brightness [3], Hue [0] • Cannot be set when the viewfinder is used.
EVF options	Adjust the viewfinder brightness and hue. <ul style="list-style-type: none"> • Use the multi selector ▲▼ to adjust brightness, ◀▶ to adjust hue and then press the OK button. • Default setting: Brightness [3], Hue [0] • Cannot be set when the monitor is used.
View/hide framing grid*	Set whether or not to display a boxed guide for framing on the shooting screen. <ul style="list-style-type: none"> • Default setting: [Off] • The framing grid is not displayed when the enlarged center of the image is displayed on the screen while using manual focus.
View/hide histograms*	Set whether or not to display a graph that shows the brightness distribution in the image on the shooting screen. <ul style="list-style-type: none"> ➔ Using the histogram (page 118) • Default setting: [Off] • In Auto mode and Creative mode, the histogram is displayed only when the focus-mode selector is set to MF. • When in P, S, A, M, or U mode and the focus-mode selector is set to AF, the histogram is displayed if the shooting menu → [AF area mode] is set to a setting other than [Target finding AF] (default setting). When [Subject tracking] is selected, the histogram is not displayed during subject tracking. • The histogram is not displayed in Movie manual mode. • The histogram is not displayed in [Easy panorama] scene mode. • When the focus-mode selector is set to MF, the histogram is not displayed while the focus is being set. It is displayed when you press the multi selector ▼ and lock the focus.



Option	Description
Virtual horizon*	Set whether or not to display a virtual horizon on the shooting screen. → Virtual horizon (page 231) • Default setting: [Off]

* To display or hide these indicators, press the **DISP** (display) button when [**On**] is selected.

They are not displayed while recording a movie.

Virtual horizon

You can check the degree of camera tilt in two directions.

- Rolling direction

When the reference line is displayed in yellow, the camera is tilted in the left or right direction. The reference line changes to green when the camera is level. Each scale mark represents 5 degrees.



- Pitching direction
When the ● in the center is displayed in yellow, the camera is tilted in the forward or backward direction. The ● changes to green when the camera is level. Each scale mark represents 10 degrees.

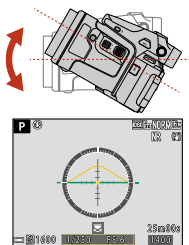

Precision of the virtual horizon

Note that an error becomes large if the camera is tilted forward or backward greatly. If the camera is tilted to the unmeasurable extent, the graduations of the virtual horizon turns off.

EVF auto toggle

Toggle the EVF (electronic viewfinder) automatically.

MENU button → **Y (setup)** → **OK button** → **EVF auto toggle** → **OK button**

Option	Description
On (default setting)	When you bring your face close to the viewfinder, the eye sensor responds to it and the display is automatically switched from the monitor to viewfinder.
Off	Even when you bring your face close to the viewfinder, the display is not switched to the viewfinder.

Date stamp

The shooting date and time can be stamped on images when shooting.



MENU button →  (setup) →  button → Date stamp →  button



Option	Description
DATE Date	Date is stamped on images.
DATE  Date and time	Date and time are stamped on images.
Off (default setting)	Date and time are not stamped on images.

Notes about [Date stamp]

- Stamped date and time form a permanent part of image data and cannot be deleted. The date and time cannot be stamped on images after they have been captured.
- The date and time cannot be stamped in the following situations:
 - When in **[Bird-watching]** mode (when set to **[Continuous]**)
 - When the scene mode is set to **[Sports]**, **[Night landscape]** (when set to **[Hand-held]**), **[Backlighting]** (when **[HDR]** is set to **[On]**), **[Easy panorama]**, **[Pet portrait]** (when set to **[Continuous]**), **[Multiple exp. Lighten]**, or **[Time-lapse movie]**
 - When **[Image quality]** is set to **[RAW]**, **[RAW + Fine]**, or **[RAW + Normal]**
 - When **[Pre-shooting cache]**, **[Continuous H: 120 fps]**, or **[Continuous H: 60 fps]** is selected for **[Continuous]**
 - When recording movies
 - When saving still images during movie recording
 - When extracting still images from a movie during movie playback
- The stamped date and time may be difficult to read when using a small image size.

Self-timer: after release

Select whether or not to cancel the self-timer setting after shooting with self-timer.

MENU button →  (setup) →  button → Self-timer: after release →  button



Option	Description
Exit self-timer mode (default setting)	The self-timer is canceled after shooting. <ul style="list-style-type: none"> After shooting with self-timer in Moon mode, the self-timer setting is [🕒 3s] (3 seconds). To end self-timer, manually set the self-timer setting to OFF. [Pet portrait auto release] and [Smile timer] are not canceled.
Stay in self-timer mode	The self-timer photography continues after shooting. <ul style="list-style-type: none"> When the camera is turned off, self-timer is canceled.

Vibration reduction

Select the vibration reduction setting used when shooting.

Select [**Off**] when using a tripod to stabilize the camera during shooting.

MENU button → **Y** (setup) → **OK** button → **Vibration reduction** → **OK** button

Option	Description
📷 Normal (default setting)	Suited to capturing images of subjects that are not moving.
📷 ACT Active	Suited to capturing images if a relatively large camera shake is likely to occur, such as when shooting from a car or under poor foothold conditions.
📷 Normal (framing first)	Compared to the [Normal] setting, you can reduce the amount of difference between your intended composition and the captured image.
📷 ACT Active (framing first)	Compared to the [Active] setting, you can reduce the amount of difference between your intended composition and the captured image.
Off	Compensation is not performed.

👍 Notes about [Vibration reduction]

- After turning on the camera or after switching from playback mode to shooting mode, wait until the shooting screen is ready before taking pictures.



- **[Normal]** or **[Active]** is recommended if you are not concerned about the slight variations in image composition that may occur. The amount of camera shake compensation is higher than that of **[Normal (framing first)]** or **[Active (framing first)]**.
- **[Normal (framing first)]** is recommended when you intend to significantly change the direction of the camera while shooting, such as when panning. The camera automatically detects the panning direction and only compensates for vibration caused by camera shake.
- Images on the screen may be displayed blurry immediately after shooting.
- Vibration reduction may be unable to completely eliminate the effects of camera shake in some situations.

AF assist

Allows you to enable or disable the AF-assist illuminator.

MENU button → **Y (setup)** → **OK button** → **AF assist** → **OK button**

Option	Description
Auto (default setting)	The AF-assist illuminator automatically lights up when you press the shutter-release button under dim lighting. The illuminator has a range of about 5.0 m (16 ft) at the maximum wide-angle position and about 5.0 m (16 ft) at the maximum telephoto position. <ul style="list-style-type: none"> • Note that for some scene modes or focus areas, the AF-assist illuminator may not light.
Off	The AF-assist illuminator does not light.

Digital zoom

Set whether to use the digital zoom.

MENU button → **Y (setup)** → **OK button** → **Digital zoom** → **OK button**

Option	Description
On (default setting)	Digital zoom is enabled.
Off	Digital zoom is disabled.



✔ Notes about [Digital zoom]

- Digital zoom cannot be used in the following scene modes:
 - [Portrait], [Night portrait], [Backlighting] (when [HDR] is set to [On]), [Easy panorama], [Pet portrait], [Time-lapse movie]
- Digital zoom cannot be used in other shooting modes when using certain settings.
 - ➔ Functions that cannot be used simultaneously when shooting (page 127)

Assign side zoom control

Choose the zoom speed while recording a movie when the side zoom control is moved.

MENU button → Y (setup) → OK button → Assign side zoom control → OK button

- You can select [High-speed movie zoom] (default setting), [Mid-speed movie zoom], or [Low-speed movie zoom].
In Movie manual mode, this setting is applied even before movie recording starts.

Snap-back zoom

Select the size of the area that is temporarily visible when the  (snap-back zoom) button is pressed.

MENU button → Y (setup) → OK button → Snap-back zoom → OK button

- You can select [Snap back: long] (default setting), [Snap back: medium], or [Snap back: short].

Assign side dial

Select the option for the side dial when the focus-mode selector is set to **AF** (autofocus).

MENU button → Y (setup) → OK button → Assign side dial → OK button

Option	Description
Exposure compensation (default setting)	You can set the exposure compensation by using the side dial.



Option	Description
ISO sensitivity	ISO sensitivity can be set with the side dial when the shooting mode is P, S, A, M , or Movie manual (except when an HS movie option is selected in [Movie options]). <ul style="list-style-type: none"> Rotate the side dial in shooting mode, rotate the multi selector or the side dial to select a setting in the displayed screen, and press the OK button or ▶ to apply it.
White balance	White balance can be set with the side dial when the shooting mode is P, S, A, M , or Movie manual. <ul style="list-style-type: none"> Rotate the side dial in shooting mode, rotate the multi selector or the side dial to select a setting in the displayed screen, and press the OK button or ▶ to apply it.
Shutter speed	Shutter speed can be selected by rotating the side dial when the shooting mode is S, M , or Movie manual.
Aperture	Aperture can be selected by rotating the side dial when the shooting mode is A, M , or Movie manual.
None	Disable side dial operation when the focus-mode selector is set to AF (autofocus).

AE/AF lock button

Set the function to be performed when the **AE-L/AF-L** (AE-L/AF-L) button is pressed while shooting.

MENU button → **Y (setup)** → **OK button** → **AE/AF lock button** → **OK button**

Option	Description
AE/AF lock (default setting)	Hold down the AE-L/AF-L button to lock both the focus and exposure. When recording movies, the focus and exposure remain locked after you press the AE-L/AF-L button. To unlock, press the button again.
AE lock only	Hold down the AE-L/AF-L button to lock the exposure. When recording movies, the exposure remains locked after you press the AE-L/AF-L button. To unlock, press the button again.
AE lock (Hold)	Press the AE-L/AF-L button to lock the exposure. To unlock, press the button again.



Option	Description
AF lock only	Hold down the AE/AF-L button to lock the focus. When recording movies, the focus remains locked after you press the AE/AF-L button. To unlock, press the button again.

Sound settings

Set operation sounds.

MENU button → **Y (setup)** → **OK button** → **Sound settings** → **OK button**

Option	Description
Button sound	When [On] (default setting) is selected, the camera produces one beep when operations are performed, two beeps when focus is acquired on the subject, and three beeps when an error occurs. <ul style="list-style-type: none"> • Sounds are disabled when using Bird-watching mode or [Pet portrait] scene mode.
Shutter sound	When [On] (default setting) is selected, the shutter sound is produced when the shutter is released. <ul style="list-style-type: none"> • The shutter sound is not produced when using continuous shooting mode (except [Continuous H] and [Continuous L]), when using exposure bracketing, when recording movies, when using Bird-watching mode, or when using [Easy panorama] or [Pet portrait] scene mode.

Auto off

Set the amount of time that elapses before the camera enters standby mode.

MENU button → **Y (setup)** → **OK button** → **Auto off** → **OK button**

- You can select **[30 s]**, **[1 min]** (default setting), **[5 min]**, or **[30 min]**.

Setting the auto off function

The time that passes before the camera enters standby mode is fixed in the following situations:

- When a menu is displayed: 3 minutes (when auto off is set to **[30 s]** or **[1 min]**)
- When the AC adapter is connected: 30 minutes



Format card

Use this option to format a memory card.

MENU button → Y (setup) → OK button → Format card → OK button

Formatting the memory cards permanently deletes all data. Data that has been deleted cannot be recovered. Make sure to save important images to a computer before formatting.

- To start formatting, select **[Format]** on the screen that is displayed and press the **OK** button.
- Do not turn the camera off or open the battery-chamber/memory card slot cover during formatting.
- You may not be able to select this setting while a wireless connection is established.

Language

Select a language for display of camera menus and messages.

MENU button → Y (setup) → OK button → Language → OK button

HDMI

Set the HDMI output of the camera.

You can output the live view image to HDMI-compatible devices without the information display, or set the output resolution.

- The camera screen does not turn on while the camera is connected to an HDMI-compatible device.

MENU button → Y (setup) → OK button → HDMI → OK button



Option	Description
Clean HDMI output	<p data-bbox="199 118 236 142">On</p> <p data-bbox="329 118 943 225">Output the live view image without the information display to an HDMI-compatible device. Use this option when you want to record images from the camera to a commercially available external recorder.</p> <ul data-bbox="329 245 943 783" style="list-style-type: none"> <li data-bbox="329 245 912 300">• Rotate the mode dial to Movie manual. In addition, set the focus-mode selector to MF. <li data-bbox="329 304 884 359">• Turn on the camera by using the power switch after connecting the camera to an HDMI-compatible device. <li data-bbox="329 363 930 418">• The sound that is picked up by the microphone is output to the HDMI-compatible device. <li data-bbox="329 422 943 497">• When an information display appears on an external recorder monitor, press the DISP button of the camera several times to turn off the information display. <li data-bbox="329 502 743 526">• 4K UHD image quality cannot be output. <li data-bbox="329 531 899 638">• Peaking display, as well as the movie menu → [Movie options] and [Frame rate], are not available while the camera is connected to an HDMI-compatible device. Still images cannot be captured with the camera. <li data-bbox="329 643 943 783">• While the camera is connected to an HDMI-compatible device, you can press the ● (▶ movie-record) button on the camera to record a movie and save it on the memory card in the camera. The power-on lamp flashes while the camera is recording movies.
	<p data-bbox="199 807 291 882">Off (default setting)</p> <p data-bbox="329 807 943 882">Use this option to view captured images. You can also capture still images or record movies with the camera while viewing the subject on a TV monitor.</p>
HDMI output	<p data-bbox="329 909 938 963">Select the image resolution when [Clean HDMI output] is set to [On].</p> <ul data-bbox="329 978 930 1032" style="list-style-type: none"> <li data-bbox="329 978 930 1032">• The image resolution setting is fixed at [Auto] when [Clean HDMI output] is set to [Off].

Notes about connection via HDMI

Wireless communication is not available when the camera and an HDMI-compatible device are connected. You also cannot use the ML-L7 Remote Control (available separately).

Notes about HDMI output resolution

When **[Clean HDMI output]** is set to **[Off]**, or when it is set to **[On]** while **[Auto]** (default setting) is selected for **[HDMI output]**, the camera detects the resolution of the output device and automatically sets the HDMI output resolution.



Charge by computer

Allows you to set whether or not the battery in the camera is charged when the camera is connected to a computer.

MENU button → Y (setup) → OK button → Charge by computer → OK button

Option	Description
AUTO Auto (default setting)	<p>When the camera is connected to a computer that is running (→ Copying pictures to a computer using NX Studio (page 250)), the battery inserted into the camera is automatically charged using power supplied by the computer.</p> <ul style="list-style-type: none">• The power-on lamp (charge lamp) flashes while the battery is charging. When charging is complete, the power-on lamp (charge lamp) changes from flashing to on.
Off	<p>The battery inserted into the camera is not charged when the camera is connected to a computer.</p>

Notes about charging with a computer

- When connected to a computer, the camera turns on and starts charging. If the camera is turned off, charging stops.
- About 7 hours and 30 minutes are required to charge a fully exhausted battery. Charging time increases when images are transferred while the battery is charging.
- The camera turns off automatically if there is no communication with the computer for 30 minutes after the battery has finished charging.

When the power-on lamp (charge lamp) quickly flashes

Charging cannot be performed, possibly due to one of the reasons described below.

- The ambient temperature is not suited to charging. Charge the battery indoors with an ambient temperature of 5°C to 35°C (41°F to 95°F).
- The USB cable is not connected correctly, or the battery is faulty. Make sure that the USB cable is connected correctly or replace the battery if necessary.
- The computer is in sleep mode and is not supplying power. Wake up the computer.
- The battery cannot be charged because the computer cannot supply power to the camera due to the computer's settings or its specifications.

Image comment

Allows you to attach a comment that was previously registered to images that will be captured.



MENU button → Y (setup) → OK button → Image comment → OK button

- You can imprint the attached comment to images that will be sent to a smart device using the SnapBridge app. You must configure the SnapBridge app in advance. For details, see the online help for the SnapBridge app (<https://nikonimglib.com/snbr/onlinehelp/en/index.html>).

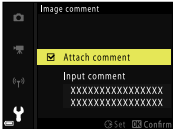
Option	Description
Attach comment	<p>A comment registered with [Input comment] is attached to images.</p>  <ul style="list-style-type: none">• Select [Attach comment], press ►, and set the check box to on (✓). When the OK button is pressed, the comment will be attached to the images captured afterwards.
Input comment	<p>You can register a comment of up to 36 alphanumeric characters.</p> <ul style="list-style-type: none">• Select [Input comment], press ►, and the input screen is displayed. ➔ Inputting characters (page 226)

✓ Notes about [Image comment]

Image comments cannot be attached to movies.

Copyright information

Allows you to attach the copyright information that was previously registered to images that will be captured.

MENU button → Y (setup) → OK button → Copyright information → OK button

- You can imprint the attached copyright information to images that will be sent to a smart device using the SnapBridge app. You must configure the SnapBridge app in advance. For details, see the online help for the SnapBridge app (<https://nikonimglib.com/snbr/onlinehelp/en/index.html>).

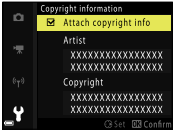

Option	Description
Attach copyright info	<p>Copyright information registered with [Artist] and [Copyright] is attached to images.</p>  <ul style="list-style-type: none"> • Select [Attach copyright info], press ▶, and set the check box to on (✓). When the OK button is pressed, the copyright information will be attached to the images captured afterwards.
Artist	<p>You can register an artist name of up to 36 alphanumeric characters.</p> <ul style="list-style-type: none"> • Select [Artist], press ▶, and the input screen is displayed. ➔ Inputting characters (page 226)
Copyright	<p>You can register a copyright owner name of up to 54 alphanumeric characters.</p> <ul style="list-style-type: none"> • Select [Copyright], press ▶, and the input screen is displayed. ➔ Inputting characters (page 226)

✓ Notes about [Copyright information]

- To prevent illegal use of artist names and copyright owner names when lending or transferring ownership of the camera, make sure to disable the **[Attach copyright info]** setting. Also, make sure that the artist name and copyright owner name are blank.
- Nikon is not responsible for any kind of trouble or damage resulting from the use of **[Copyright information]**.
- Copyright information cannot be attached to movies.

📝 Copyright information display

When copyright information is entered for both **[Artist]** and **[Copyright]**, only the Copyright entry is imprinted to the images in the SnapBridge app.

Location data

Set whether or not to add shooting location information to the images that you take.

MENU button → **Y** (setup) → **OK** button → Location data → **OK** button



Option	Description
Record location data	Select [Yes] to add location information from a smart device to the images that you take. Enable the location information function of the SnapBridge app.
Position	Display the obtained location information.

Toggle Av/Tv selection

Change which controls to use for setting the exposure in the following shooting modes.

- **P, S, A, M, U, ** (Movie manual) mode
- **[Multiple exp. Lighten]** scene mode (when **[Nightscape + light trails]** or **[Fireworks]** is set)

MENU button →  (setup) →  button → Toggle Av/Tv selection →  button

Option	Description
Do not toggle selection (default setting)	Use the command dial to set the flexible program or shutter speed (Tv), and the multi selector to set the f-number (Av).
Toggle selection	Use the multi selector to set the flexible program or shutter speed (Tv), and the command dial to set the f-number (Av).

Reset file numbering

Reset file numbering.

MENU button →  (setup) →  button → Reset file numbering →  button

- When **[Yes]** is selected, a new folder is created and the file number for the next image captured starts with "0001."

Notes about [Reset file numbering]

[Reset file numbering] cannot be applied when the folder number reaches 999 and there are images in the folder. Change the memory card, or use **[Format card (page 239)]** to format the memory card.



- **[Reset file numbering]** cannot be performed when the write-protect switch on the memory card is in the “lock” position. Slide the write-protect switch to the “write” position.
 ➔ Inserting the battery and memory card (page 39), ➔ Memory cards (page 289)

Folders for storing files

Still images and movies shot or recorded with this camera are saved in folders of the memory card.

- Sequential numbers are added to folder names in ascending order, starting with “100” and ending with “999” (the folder names are not displayed on the camera).
- A new folder is created in the following situations:
 - When the number of files in a folder reaches 999
 - When a file in a folder is numbered “9999”
 - When **[Reset file numbering]** is performed
- A new folder is created each time a series of images are captured using interval timer shooting, and the images are saved in that folder with file numbers starting with “0001.”

Peaking

When operating manual focus, focusing is assisted by highlighting areas that are in focus in white on the image displayed on the screen.

MENU button ➔ **Y (setup)** ➔ **OK button** ➔ **Peaking** ➔ **OK button**

Option	Description
On (default setting)	Peaking is enabled.
Off	Peaking is disabled.

Notes about peaking

After turning on the camera or after switching from playback mode to shooting mode, peaking display is disabled.

Rotate the side dial or press the multi selector ▼.

- ➔ Using manual focus (page 113)
- ➔ Peaking (page 115)

Reset all

Allows you to reset the camera’s settings to their default values.



MENU button → **Y** (setup) → **OK** button → **Reset all** → **OK** button

When **[Reset]** is selected, the camera's settings are restored to their default values.

- The network menu settings are also restored to their default values.
To use the SnapBridge app, unpair in SnapBridge and then pair again.
→ Connecting to a smart device (page 223)
To use the ML-L7 Remote Control, pair it again.
→ Pairing the camera and remote control (page 265)
- Some settings, such as **[Time zone and date]** or **[Language]**, are not reset. User settings that were saved in **U** of the mode dial are not reset. To reset these settings, use **[Reset user settings]**.
→ Resetting **U** (user settings) mode (page 72)
- You may not be able to select this setting while a wireless connection is established.

Resetting file numbering

To reset file numbering to "0001", delete all images saved on the memory card before selecting **[Reset all]**. **[Reset file numbering (page 244)]** can also be used to reset to "0001".

Conformity marking

View the conformity markings that the camera complies with.

MENU button → **Y** (setup) → **OK** button → **Conformity marking** → **OK** button

Firmware version

View the current camera firmware version.

MENU button → **Y** (setup) → **OK** button → **Firmware version** → **OK** button

- You may not be able to select this setting while a wireless connection is established.



Connecting the camera to a TV or computer

Viewing images on a TV	248
Transferring images to a computer	250



Viewing images on a TV

You can connect the camera to a TV with a commercially available HDMI cable to view images and movies captured with the camera on the TV.

✔ Notes about connecting the camera to a TV

- Make sure that the camera battery is sufficiently charged. If the EH-5d AC Adapter and the EP-5C Power Connector (both available separately) are used, this camera can be powered from an electrical outlet. Do not, under any circumstances, use an AC adapter other than the EH-5d. Failure to observe this precaution could result in overheating or damage to the camera.
- For information about the connection methods and subsequent operations, refer to the documentation included with the TV in addition to this document.

1 Turn off the camera.

2 Use a commercially available HDMI cable to connect the camera's HDMI micro connector (Type D) and the TV's HDMI input port.

- Check the shape and direction of the plugs and do not insert or remove the plugs at an angle.

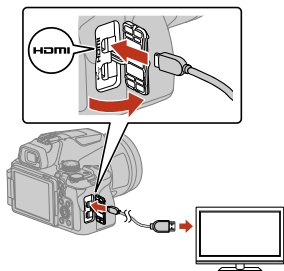



3 Set the TV's input to external input.

- See the documentation provided with your TV for details.

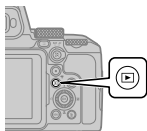

4 Press and hold down the (playback) button to turn on the camera.



- Images are displayed on the TV.
- The camera screen does not turn on.
- When you turn on the camera using the power switch, the shooting screen is displayed on the TV. To show the captured images and movies on the TV, press the  button to enter playback mode.

Notes about connecting the HDMI cable

When using a USB cable, the camera cannot perform HDMI output to the TV.

Playing back 4K movies

To play back movies that are recorded with **[2160/30p]** (4K UHD) or **[2160/25p]** (4K UHD) in 4K UHD image quality, use a television and HDMI cable that are compatible with 4K. Also, select the setup menu **→ [HDMI] → [Clean HDMI output] → [Off]**.

- When playing back 4K movies on certain TVs, the first few seconds may not be displayed because it takes some time for the TV to adjust the display to match the output from the camera.



Transferring images to a computer

Connect the camera using the supplied USB cable. You can then use Nikon NX Studio software to copy pictures to the computer for viewing and editing.

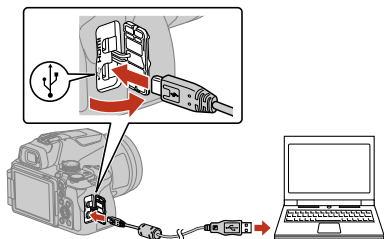

Installing NX Studio

You will need an Internet connection when installing NX Studio. Visit the Nikon website for system requirements and other information.

- Download the latest NX Studio installer from the website below and follow the on-screen instructions to complete installation.
<https://downloadcenter.nikonimglib.com/>
- Note that you may be unable to download pictures from the camera using earlier versions of NX Studio.

Copying pictures to a computer using NX Studio

See online help for detailed instructions.



1 Connect the camera to the computer.

- After turning the camera off and ensuring that a memory card is inserted, connect the supplied USB cable as shown.

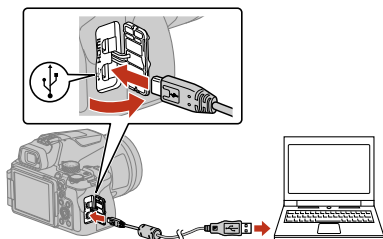

2 Turn the camera on.

- The Nikon Transfer 2 component of NX Studio will start. Nikon Transfer 2 image transfer software is installed with NX Studio.
- If a message is displayed prompting you to choose a program, select Nikon Transfer 2.
- If Nikon Transfer 2 does not start automatically, launch NX Studio and click the "Import" icon.



3 Click [Start Transfer].

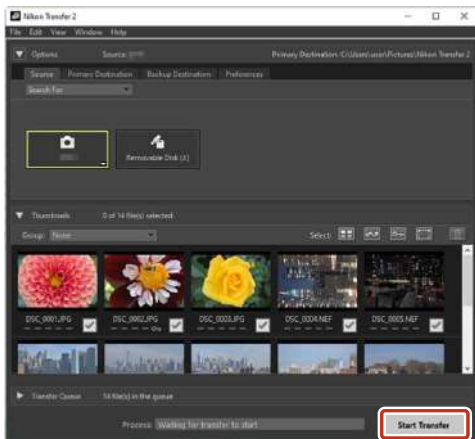

- Pictures on the memory card will be copied to the computer.

4 Turn the camera off.

- Disconnect the USB cable when transfer is complete.

☑ Windows 10 and Windows 8.1

Windows 10 and Windows 8.1 may display an AutoPlay prompt when the camera is connected.

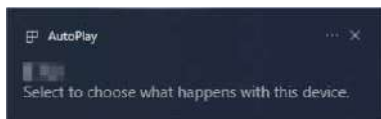

Click the dialog and then click **[Nikon Transfer 2]** to select Nikon Transfer 2.

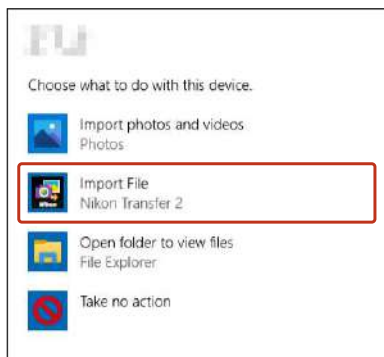

✔ macOS

If Nikon Transfer 2 does not start automatically, confirm that the camera is connected and then launch Image Capture (an application that comes with macOS) and select Nikon Transfer 2 as the application that opens when the camera is detected.

✔ Transferring videos

Do not attempt to transfer videos from the memory card while it is inserted in a camera of a different make or model. Doing so could result in the videos being deleted without being transferred.

✔ Connecting to computers

- Do not turn the camera off or disconnect the USB cable while transfer is in progress.
- Do not use force or attempt to insert the connectors at an angle. Be sure also to keep the connectors straight when disconnecting the cable.
- Always turn the camera off before connecting or disconnecting a cable.
- Disconnect all other USB-powered devices from the computer. Connecting the camera and other USB-powered devices to the same computer simultaneously may cause a camera malfunction or excessive power supply from the computer, which could damage the camera or memory card.
- Make sure that the camera battery is sufficiently charged. If the EH-5d AC Adapter and the EP-5C Power Connector (both available separately) are used, this camera can be powered from an electrical outlet. Do not, under any circumstances, use an AC adapter other than the EH-5d. Failure to observe this precaution could result in overheating or damage to the camera.



USB hubs

Connect the camera directly to the computer; do not connect the cable via a USB hub or keyboard. Connect the camera to a pre-installed USB port.

Using a card reader

Pictures can also be copied from a memory card inserted in a third-party card reader. You should however check that the card is compatible with the card reader.





Accessories

List of accessories	256
EH-5d AC Adapter and EP-5C Power Connector	259
Speedlights (external flash units)	260
ML-L7 Remote Control	262

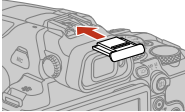

List of accessories

Aside from the included accessories, you can use the following available accessories.

Type	Product name
Battery charger	MH-29 Battery Charger Charging time is about 3 hours for a fully exhausted battery.
AC adapter	EH-5d AC Adapter and EP-5C Power Connector → EH-5d AC Adapter and EP-5C Power Connector (page 259)
Accessory shoe cover	BS-1 Accessory Shoe Cover Protects the accessory shoe. 1  2 
Speedlight (external flash unit)	See “→ Speedlights (external flash units) (page 260)” for information on compatible Speedlights and how to use them.
Filter	67mm screw-on filter (Nikon product) Protects the lens. When you use the built-in flash with the filter attached, the image periphery may appear dark.

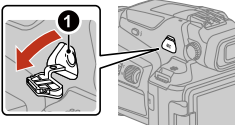

Type	Product name
External microphone	<ul style="list-style-type: none"> • ME-1 Stereo Microphone • ME-W1 Wireless Microphone: Connect the audio cable (included with the wireless microphone) to the headphone jack of the receiver and the external microphone connector (1) of the camera. See the documentation provided with the ME-W1 for more information. <div style="text-align: center; margin-top: 10px;">  </div>
Remote control accessories	<p>MC-DC2 Remote Cord You can use the MC-DC2 to release the shutter when it is connected to the accessory terminal.</p> <hr/> <p>WR-R10, WR-1 Wireless Remote Controller: When the WR-R10 or WR-1 is connected to the accessory terminal on COOLPIX P950 as a receiver, the shutter can be released wirelessly. Use the WR-T10 Wireless Remote Controller or another WR-1 as a transmitter.</p> <ul style="list-style-type: none"> • The WR-T10 or WR-1 cannot be used to change the settings of COOLPIX P950. The Fn button on the WR-T10 or WR-1 cannot be used. • If a WR-1 is connected to COOLPIX P950, the LED on the WR-1 that indicates exposure does not light up. • A WR-R10 or WR-1 connected to COOLPIX P950 cannot be used as a transmitter. The shutter-release button on COOLPIX P950 cannot be used to release the shutter of multiple cameras. • A WR-R10 connected to COOLPIX P950 cannot be used to remotely operate SB-5000 Speedlight and fire the flash. <hr/> <p>ML-L7 Remote Control ➔ ML-L7 Remote Control (page 262)</p>
Sight	<p>DF-M1 Dot Sight Sight that assists with framing when shooting in a telephoto position, where it is easy to lose sight of the subject.</p>



Accessories

- Availability may vary with country or region.
- See our website or brochures for the latest information.



EH-5d AC Adapter and EP-5C Power Connector

When the power connector is inserted into the camera and the AC adapter is connected, the camera can be powered from an electrical outlet. The AC adapter and the power connector are available separately.

Attaching the EH-5d AC Adapter and EP-5C Power Connector

- 1 Open the battery-chamber/memory card slot cover, and remove the battery.
- 2 Open the power connector cover (1), and insert the power connector with the positive and negative terminals oriented correctly (3).

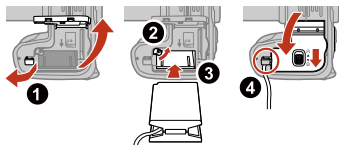

- Fully insert the power connector cable into the slot in the battery chamber (4), and close the battery-chamber/memory card slot cover. If part of the cable protrudes from the slots, the cover or cable may be damaged when the cover is closed.

- 3 Insert the DC plug of the AC Adapter into the DC plug connector of the Power Connector.

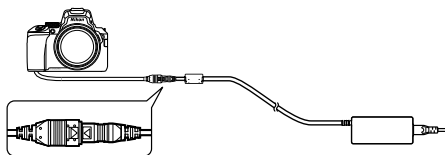

Speedlights (external flash units)

The following Speedlights can be used with the camera. The standard i-TTL flash function is available.

- SB-5000, SB-700, SB-500

Attaching the Speedlight

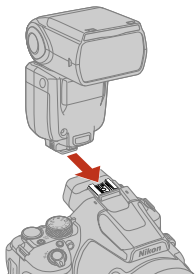

- Do not raise the built-in flash.
- Refer to the manual provided with your Speedlight for information about attaching the Speedlight.
- Attempting to attach an accessory that does not support this camera may damage the camera and the accessory.

Notes about the built-in flash

The built-in flash of this camera cannot be used when a Speedlight is attached. Do not raise the built-in flash when a Speedlight is attached. Doing so may cause it to hit the Speedlight, resulting in product damage.

Use only Nikon flash accessories

Use only Nikon Speedlights. Flash units of other manufacturers (with voltages over 250 V applied to the camera's X sync contact, or causing short circuit at the accessory shoe contact) could not only prevent normal operation, but damage the sync circuitry of the camera or flash.

Notes about using Speedlights (external flash units)

If vignetting appears in the captured image, try to put some distance between the camera and the subject or remove the lens hood.



Functions that can be used in combination with the Speedlight

		SB-5000	SB-700	SB-500
i-TTL	i-TTL balanced fill-flash	–	–	–
	Standard i-TTL flash	✓	✓	✓
AA	Auto aperture flash	✓	–	–
A	Non-TTL auto flash	–	–	–
M	Manual flash	✓	✓	–
GN	Distance-priority manual flash	✓	✓	–
RPT	Repeating flash	✓	–	–
Red-eye reduction		✓	✓	✓

🔍 Notes about i-TTL flash

- The monitor preflashes are fired to measure the reflecting light from a subject in order to adjust the flash output of the Speedlight.
 - Standard i-TTL flash: The flash output is adjusted to achieve proper exposure according to the brightness of the main subject without consideration of the background light. This setting is optimal for taking images with emphasis on the main subjects.
- When shooting using i-TTL flash, set the flash control mode of the Speedlight to i-TTL before taking pictures.

🔍 Notes about Speedlights

- This camera does not support flash color information communication, Auto FP High-Speed Sync, FV lock, AF-assist illumination for multi-point AF, or the wireless lighting function when using Speedlights.
- When using the power zoom function with the SB-5000 or SB-700, the zoom head position is automatically set depending on the focal length of the lens.
- When using a Speedlight, the image periphery may appear dark if the zoom is at the wide-angle position. In such cases, use the wide panel of the SB-5000 or SB-700.
- When set to STBY (standby), the Speedlight turns on and off at the same time as the camera. Confirm on the Speedlight that the flash-ready indicators are on.
- Refer to the documentation provided with your Speedlight for more information.



ML-L7 Remote Control

You can pair (➡Pairing the camera and remote control (page 265)) the separately available ML-L7 Remote Control with the camera, and use it to operate the camera. The operations described in “➡Parts and functions of the remote control (for COOLPIX P950) (page 263)” can be performed when shooting with this camera.

- The camera can only be paired with one remote control at a time. When the camera is paired with a different remote control, only the most recent paired remote control is enabled.
- Refer to the User's Manual provided with the ML-L7 Remote Control.

☑ Notes about connection via HDMI

The remote control cannot be used when the camera and an HDMI-compatible device are connected. Disconnect the connection with the HDMI-compatible device.



Parts and functions of the remote control (for COOLPIX P950)

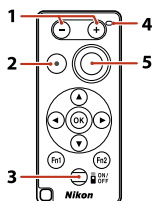

	Parts	Function
1	- button/+ button	Zooms out when the - button is pressed and zooms in when the + button is pressed, while the shooting screen is displayed.
2	Movie recording button	Starts recording a movie when the button is pressed, and stops recording when pressed again.
3	Power button	Press the button to turn on the remote control and search for a camera that has already been paired. Press and hold the button (for at least 3 seconds) to search for a new pairing camera. To turn off the remote control, press the button again.
4	Status lamp	Indicates the remote control status or shooting session status, based on the color and behavior of the lamp. ➔ Status lamp on the remote control (for COOLPIX P950) (page 264)
5	Shutter-release button	Functions similarly to the shutter-release button on the camera. <ul style="list-style-type: none">• Half-press and press-and-hold operations are not available.• When using the self-timer, you can press the button during the countdown to cancel shooting.



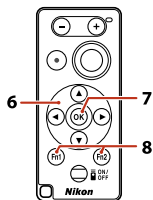

	Parts	Function
6	Multi selector	<ul style="list-style-type: none"> • Functions similarly to the multi selector on the camera, enabling you to configure settings on the shooting screen, such as the flash mode, self-timer, focus mode, and exposure compensation. <ul style="list-style-type: none"> ➔ Flash mode (page 99), ➔ Self-timer (page 102), ➔ Available focus modes (page 107), ➔ Exposure compensation (page 117) With some shooting modes and menu settings, it is possible to adjust the effect or move the focus area. <ul style="list-style-type: none"> ➔ AF area mode (page 191) • When using manual focus, the focus can be adjusted with ▲▼. <ul style="list-style-type: none"> ➔ Using manual focus (page 113)
7	OK (apply selection) button	<p>Applies the selected item. When adjusting manual focus, press this button to stop focusing.</p>
8	Fn1 (Function 1) /Fn2 (Function 2) buttons	<ul style="list-style-type: none"> • If you press the Fn1 or Fn2 button in P, S, A, M, or U mode, you can quickly configure the pre-saved menu options. <ul style="list-style-type: none"> ➔ Using the Fn (function) button (page 121)

Status lamp on the remote control (for COOLPIX P950)

Color	Status	Description
Green	Flashing about every second	Remote control is searching for a camera that has already been paired.
Green	Flashing quickly (about every 0.5 seconds)	Pairing process is being performed.



Color	Status	Description
Green	Flashing about every 3 seconds	Connection is established between remote control and camera.
Orange	Flashes once	Still image shooting starts.
Orange	Flashes twice	End still image shooting (e.g. shooting with the Time setting).
Red	Flashes once	Movie recording starts.
Red	Flashes twice	Movie recording ends.

Pairing the camera and remote control

Before using the remote control for the first time, it must be paired with the camera.

- 1 Press the **MENU** button on the camera.
- 2 Press the multi selector ◀, use ▲▼ to select  (network menu), and press the **OK** button.
- 3 Select [**Choose connection**], and press the **OK** button.

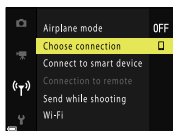

- 4 Select [**Remote control**], and press the **OK** button.

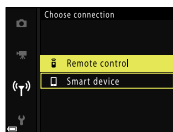

5 Select [**Connection to remote**], and press the **OK** button.

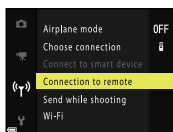

- Pairing is enabled and the camera waits for the connection to be established.
- If you cannot select [**Connection to remote**], set the following in the network menu.
 - [**Airplane mode**]: [**Off**]
 - [**Bluetooth**] → [**Connection**] → [**Enable**]

6 Press and hold (for at least 3 seconds) the power button on the remote control.

- Pairing starts for the camera and remote control. During the process, the status lamp on the remote control flashes about every 0.5 seconds.
- When pairing is complete, a connection is established between the camera and the remote control. When you enter shooting mode,  is displayed on the shooting screen.



- If a pairing failure message is displayed, perform the procedure again from step 5.

Switching the connection to a smart device

- In the Network menu of the camera → [**Choose connection (page 224)**], switch the connection from [**Remote control**] to [**Smart device**].
- When the SnapBridge app is launched on your smart device, and a connection is reestablished between the camera and smart device,  on the shooting screen flashes and then turns on again (if a smart device is paired).
- For connections or use of the SnapBridge app, see the online help of the SnapBridge app (<https://nikonimglib.com/snbr/onlinehelp/en/index.html>).



If there is a problem

Troubleshooting	268
Error messages	281



Troubleshooting

If the camera fails to function as expected, check the following before consulting your retailer or Nikon-authorized service representative.

- Turning off the camera once may solve the issue.
- If you cannot find a relevant entry, also check “➔Error messages (page 281)” or the Nikon website for your region.

Power, display, settings

The camera is on but does not respond.

- Wait for recording to end.
- If the problem persists, turn the camera off.
If the camera does not turn off, remove and reinsert the battery or batteries or, if you are using an AC adapter, disconnect and reconnect the AC adapter. Note that although any data currently being recorded will be lost, data that have already been recorded will not be affected by removing or disconnecting the power source.

The camera cannot be turned on.

The battery is exhausted.

- ➔Charging the battery (page 41), ➔The battery (page 287)

The camera turns off without warning.

- The camera automatically turns off to save power (auto off function).
➔The auto off function (page 51)
- The camera and battery may not work properly at low temperatures.
➔The battery (page 287)
- The inside of the camera has become hot. Leave the camera off until the inside of the camera has cooled, and then try turning it on again.

The monitor or viewfinder is blank.

- The camera is off.
➔Camera setup (page 44)
- The battery is exhausted.
➔Charging the battery (page 41), ➔The battery (page 287)
- The camera automatically turns off to save power (auto off function).
➔The auto off function (page 51)



- You cannot turn on both the monitor and viewfinder at the same time. It may take a while to switch between the monitor and viewfinder.
- The camera is connected to a TV or computer.
- Interval timer shooting, **[Multiple exp. Lighten]** scene mode (when **[Star trails]** is set) shooting, or time-lapse movie shooting is in progress, or the camera is capturing images with a long time-exposure using the Bulb setting or Time setting.

The camera becomes hot.

The camera may become hot when used for an extended period of time such as to shoot movies, or when used in a hot environment; this is not a malfunction.

The battery inserted in the camera cannot be charged.

- Confirm all connections.
 - ➔ Charging the battery (page 41)
- The camera may not charge when connected to a computer for any of the reasons described below.
 - The setup menu ➔ **[Charge by computer (page 241)]** is set to **[Off]**.
 - If the camera is turned off, charging stops.
 - Battery charging is not possible if the camera's display language and date and time have not been set, or the date and time were reset after the camera's clock battery was exhausted. Use the Charging AC Adapter to charge the battery.
 - Battery charging may stop when the computer enters sleep mode.
 - Depending on the computer specifications, settings, and status, battery charging may not be possible.

The monitor is hard to see.

- Adjust the screen brightness.
 - ➔ **Monitor options** (page 230)
- The surrounding area is too bright.
 - Move to a darker place.
 - Use the viewfinder.
 - ➔ Switching between the monitor and viewfinder (page 54)

The viewfinder is hard to see.

- Adjust the diopter of the viewfinder.
 - ➔ Diopter adjustment of the viewfinder (page 54)
- Adjust the viewfinder brightness.
 - ➔ **EVF options** (page 230)



🕒 flashes on the screen.

- The camera clock has not been set. Set the date and time in the setup menu → **[Time zone and date (page 227)]**.
- If the camera clock has not been set, images and movies saved before the clock is set are dated "00/00/0000 00:00" and "01/01/2020 00:00" respectively.

Date and time of recording are not correct.

Set the date and time in the setup menu → **[Time zone and date (page 227)]**. The camera clock is not as accurate as ordinary watches or clocks. Periodically compare the time of the camera clock with that of a more accurate timepiece and reset as required.

No information displayed on the screen.

Shooting and photo information may be hidden. Press the **DISP** button until information is displayed.

- ➔ Switching the information displayed on the screen (**DISP** button) (page 32)

[Date stamp] not available.

The camera clock has not been set. Set the date and time in the setup menu → **[Time zone and date (page 227)]**.

Date not stamped on images even when [Date stamp] is enabled.

- The current shooting mode does not support **[Date stamp]**.
 - ➔ Notes about [Date stamp] (page 233)
- A function that restricts the **[Date stamp]** function is enabled.
 - ➔ Functions that cannot be used simultaneously when shooting (page 127)
- The date cannot be stamped on movies.

Screen for setting time zone and date is displayed when the camera is turned on.

The camera settings reset.

The clock battery is exhausted; all settings were restored to their default values. Configure the camera settings again.

The internal clock battery is used to power the camera clock and to retain certain settings. Charging time of the clock battery takes about 10 hours when you insert the battery into the camera or connect the AC adapter (available separately) to the camera, and the clock battery operates for several days even after the camera battery is removed.



[Reset file numbering] cannot be done.

- Although a new folder is created on the memory card by resetting file numbering, etc., if the sequential number of a folder name (which is not displayed on the camera) reaches the upper limit ("999"), reset is not possible. Change the memory card, or use the setup menu → **[Format card (page 239)]** to format the memory card.
- The write-protect switch is locked. Slide the write-protect switch to the "write" position.
 - ➔ Inserting the battery and memory card (page 39), ➔ Memory cards (page 289)

The camera makes sound.

When **[Autofocus mode]** is set to **[Full-time AF]** or while in some shooting modes, the camera may produce an audible focusing sound.

- ➔ Autofocus mode (still images) (page 196), ➔ Autofocus mode (movies) (page 206)

The EN-EL20 Rechargeable Li-ion Battery cannot be used.



You cannot use the EN-EL20 Rechargeable Li-ion Battery. Use EN-EL20a.

Shooting

Cannot switch to shooting mode.

Disconnect the USB cable.

Cannot take pictures or record movies.

- When the camera is in playback mode, press the  button, shutter-release button, or  button.
 - ➔ The camera body (page 17)
- When menus are displayed, press the **MENU** button.
 - ➔ The camera body (page 17)
- When shooting in **[Night portrait]** or **[Backlighting]** (with **[HDR]** set to **[Off]**) scene mode, raise the built-in flash.
 - ➔ Using the built-in flash (page 52)
- The built-in flash is charging while  is flashing. Wait until charging is complete.
 - ➔ The flash-ready indicator (page 100)
- Insert a memory card with sufficient free space into the camera.
- The battery is exhausted.
 - ➔ Charging the battery (page 41), ➔ The battery (page 287)



The camera cannot focus.

- The subject is too close. Try shooting using the following.
 - [**Close-up (page 86)**] scene mode
 - [**Macro close-up**] focus mode
 - ➔ Selecting the focus mode (page 106)
- Incorrect focus mode setting. Check or change the setting.
 - ➔ Selecting the focus mode (page 106)
- The subject is hard to focus on.
 - ➔ Subjects not suitable for autofocus (page 111)
- Select the setup menu ➔ [**AF assist (page 235)**] ➔ [**Auto**].
- Subject is not in focus area when the shutter-release button is pressed halfway.
- The focus-mode selector is set to **MF** (manual focus).
 - To shoot using autofocus, set the focus-mode selector to **AF** (autofocus).
 - To shoot using manual focus, focus manually.
 - ➔ Using manual focus (page 113)
- Turn the camera off and then on again.
- The camera may move slightly when operated, even if it is attached to a tripod, which may interfere with the autofocus.

Colored stripes appear on the screen when shooting.

Colored stripes may appear when shooting subjects with repeating patterns (such as window blinds); this is not a malfunction.

The colored stripes will not appear in captured images or recorded movies. However, when using [**Continuous H: 120 fps**] or [**HS 480/4x**], the colored stripes may be seen in the captured images and recorded movies.

Images are blurred.

- Use the flash.
 - ➔ Flash mode (page 99)
- Use the vibration reduction feature. You can also use [**Electronic VR**] when recording movies.
 - ➔ Electronic VR (page 207), ➔ Vibration reduction (page 234)
- Use a tripod to stabilize the camera (using the self-timer setting of [**10s**] (10 seconds) at the same time is more effective).
 - ➔ Using a tripod (page 51), ➔ Self-timer (page 102)

Bright specks appear in images captured with flash.

The flash is reflecting off particles in the air. Lower the built-in flash.

- ➔ Using the built-in flash (page 52)



Flash does not fire.

- The built-in flash is lowered.
 - ➔ Using the built-in flash (page 52)
- A shooting mode where the flash cannot fire is selected.
 - ➔ Default settings (flash, self-timer, and focus mode) (page 119), ➔ Functions that cannot be used simultaneously when shooting (page 127)
- A function that restricts the flash is enabled.
 - ➔ Functions that cannot be used simultaneously when shooting (page 127)

Digital zoom cannot be used.

- The setup menu ➔ **[Digital zoom (page 235)]** ➔ **[Off]** is selected.
- Digital zoom cannot be used with certain shooting modes or when using certain settings in other functions.
 - ➔ Functions that cannot be used simultaneously when shooting (page 127), ➔ Digital zoom (page 235)

[Image size] not available.

- A function that restricts the **[Image size]** option is enabled.
 - ➔ Functions that cannot be used simultaneously when shooting (page 127)
- When the scene mode is set to **[Easy panorama (page 89)]**, the image size is fixed.

No sound when the shutter is released.

- The setup menu ➔ **[Sound settings (page 238)]** ➔ **[Shutter sound]** ➔ **[Off]** is selected. No sound is produced with some shooting modes or settings, even when **[On]** is selected.
 - ➔ Functions that cannot be used simultaneously when shooting (page 127)

AF-assist illuminator does not light.

The setup menu ➔ **[AF assist (page 235)]** ➔ **[Off]** is selected. AF-assist illuminator may not light depending on the position of the focus area or the current scene mode, even when **[Auto]** is selected.

Images appear smeared.

The lens is dirty. Clean the lens.

- ➔ Cleaning and storage (page 291)



Colors are unnatural.

White balance or hue is not adjusted properly.

- ➔ Food (page 87), ➔ White balance (page 181)
-

Randomly spaced bright pixels (“noise”) appear in image.

The subject is dark and the shutter speed is too slow, or ISO sensitivity is too high. Noise can be reduced by:

- Using the flash
 - ➔ Flash mode (page 99)
 - Specifying a lower ISO sensitivity setting
 - ➔ ISO sensitivity (page 189)
-

Bright spots appear in image.

When shooting at a slow shutter speed in multiple exposure mode, noise (bright spots) may appear in saved images.

Images are too dark (underexposed).

- The flash window is blocked.
 - ➔ The camera body (page 17)
 - The subject is beyond the range of the flash. Check the range of the flash.
 - ➔ Specifications (page 293)
 - Adjust exposure compensation.
 - ➔ Exposure compensation (page 117)
 - Increase ISO sensitivity.
 - ➔ ISO sensitivity (page 189)
 - The subject is backlit.
 - Use the flash.
 - ➔ Flash mode (page 99)
 - Try the **[Backlighting (page 88)]** scene mode.
-

Images are too bright (overexposed).

Adjust exposure compensation.

- ➔ Exposure compensation (page 117)
-

Skin tones are not softened.

- In some shooting conditions, facial skin tones may not be softened.
 - For images containing four or more faces, try using the playback menu ➔ **[Skin softening (page 213)]** after shooting.
-



Saving images takes time.

It may take more time to save images in the following situations:

- When the noise reduction function is in operation
- When capturing images in the following scene modes:
 - **[Noise reduction burst]** in **[Landscape]** or **[Close-up]**
 - **[Hand-held]** in **[Night landscape]**
 - **[HDR]** is set to **[On]** in **[Backlighting]**
 - **[Easy panorama]**
- When using the Bulb setting or Time setting to capture images with a long time-exposure
- When the shooting menu → **[Continuous]** is set to **[Continuous H]**, **[Pre-shooting cache]**, **[Continuous H: 120 fps]**, or **[Continuous H: 60 fps]**
- When using **[Smile timer]** while shooting
- When using Active D-Lighting while shooting
- When using multiple exposure while shooting
- When **[Image quality]** is set to **[RAW]**, **[RAW + Fine]**, or **[RAW + Normal]**
- When capturing still images while recording a movie with **[Movie options]** set to **[2160/30p]** or **[2160/25p]**

A ring-shaped belt or rainbow-colored stripe appears on the screen or images.

When shooting with backlighting or when a very strong light source (such as sunlight) is in the frame, a ring-shaped belt or rainbow-colored stripe (ghosting) may occur. Change the position of the light source, or frame the picture so that the light source does not enter the frame, and try again.

Menu items cannot be selected (displayed in gray).

Set features do not work.

- Some menus are not available while a wireless connection is established. Stop the wireless connection.
- Some functions cannot be used with other menu settings.
 - ➔ Functions that cannot be used simultaneously when shooting (page 127)

Playback, editing

File cannot be played back.

- This camera may not be able to play back images saved with another make or model of digital camera.



- This camera cannot play back RAW images or movies saved with another make or model of digital camera.
- This camera may not be able to play back data edited on a computer.
- Files cannot be played back during interval timer shooting.
- The memory card contains no images.

Cannot zoom in on image.

- Playback zoom cannot be used with movies.
- This camera may not be able to zoom in on images captured with another make or model of digital camera.
- When zooming in on a small-sized image, the magnification rate shown on the screen may differ from the actual magnification rate of the image.

Cannot edit images.

- Some images cannot be edited. Images that have already been edited may not be edited again.
 - ➔ Before editing images (page 142)
- There is not enough free space on the memory card.
- This camera is unable to edit images captured with other cameras.
- Editing functions used for images are not available for movies.

Cannot rotate image.

This camera cannot rotate images captured with another make or model of digital camera.

TVs, computers, printers

Images are not displayed on the TV.

- A computer is connected to the camera.
- The memory card contains no images.

Nikon Transfer 2 does not start when the camera is connected to a computer.

- The camera is off.
- The battery is exhausted.
 - ➔ Charge by computer (page 241)
- The USB cable is not correctly connected.
 - ➔ Copying pictures to a computer using NX Studio (page 250)



- The camera is not recognized by the computer.
- The computer is not set to start Nikon Transfer 2 automatically. For more information about Nikon Transfer 2, refer to Nikon Transfer 2's online help.

Images saved in the camera are not displayed on a connected smart device or computer.

If the number of images saved on a memory card in the camera exceeds 10,000, images captured thereafter may not be displayed in a connected device.

- Reduce the number of images saved on the memory card. Copy the necessary images to a computer, etc.

Cannot connect to a printer.

This camera does not support printer connections.

- ➔ [Printing still images \(page 143\)](#)

Smart devices, SnapBridge app, ML-L7 Remote Control

- For more information about the SnapBridge app, see also the online help for the SnapBridge app (<https://nikonimglib.com/snbr/onlinehelp/en/index.html>).
- For more information about the ML-L7 Remote Control (available separately), see the User's Manual provided with the remote control.

Cannot select [Connect to smart device].

Cannot pair with a smart device using [Connect to smart device].

- When establishing a wireless connection for the first time, refer to the online help for the SnapBridge app (<https://nikonimglib.com/snbr/onlinehelp/en/index.html>).
- Use a sufficiently charged battery.
- Insert a memory card with sufficient free space into the camera.
- Disconnect the HDMI cable or USB cable.
- Set the following in the **[Network menu (page 223)]** in the camera.
[Airplane mode]: [Off]
[Choose connection]: [Smart device]
[Bluetooth] → [Connection]: [Enable]
- Enable Bluetooth and the location data functions on the smart device.



Paired smart devices are not connected through Bluetooth automatically.

- Set the following in the **[Network menu (page 223)]** in the camera.
[Airplane mode]: [Off]
[Choose connection]: [Smart device]
[Bluetooth] → [Connection]: [Enable]
- If the camera is paired with multiple smart devices, select the smart device you want to connect in the **[Network menu (page 223)] → [Bluetooth] → [Paired devices]** in the camera.
- After performing the setup menu → **[Reset all]** or **[Network menu (page 223)] → [Restore default settings]** in the camera, unpair in SnapBridge and then pair again.
- If multiple cameras are registered in the SnapBridge app, switch to the camera you want to connect using the SnapBridge app.

Cannot upload images to a smart device that is connected with the SnapBridge app.

- You can upload automatically through the auto link feature only when connected through Bluetooth. To upload automatically, set the following.
In the camera, **[Network menu (page 223)] → [Send while shooting] → [Still images]: [Yes]**
SnapBridge app →  tab → **[Auto link] → [Auto download]: Enable**
If the **[Network menu (page 223)] → [Bluetooth] → [Send while off] → [Off]** is selected in the camera, change the setting to **[On]** or turn on the camera.
- When there is a large number of images to upload during Bluetooth communication, communication may be disconnected while uploading. Image upload resumes after a while if the camera's **[Network menu (page 223)] → [Bluetooth] → [Send while off]** is set to **[On]**. To resume quickly, turn the camera off and then on again.
- Insert a memory card into the camera.
- You may not be able to upload images or uploading may be canceled while the camera is being operated.

Cannot download the original files of still images on the smart device that is connected with the SnapBridge app.

For **[Send while shooting]** and **[Mark for upload]** in the camera, still images are uploaded at an image size of up to 2 megapixels. To upload original files, use **[Download pictures]** in the SnapBridge app.



Cannot perform remote photography from a smart device that is connected with the SnapBridge app.

- You cannot perform remote photography without a memory card inserted into the camera. Insert the memory card.
- You may not be able to perform remote photography while the camera is being operated.

Communication quality is poor or image upload speed is extremely slow when using a Wi-Fi connection with the SnapBridge app.

On the camera, try changing the channel in the [Network menu (page 223)] → [Wi-Fi] → [Network settings].

Images saved in the camera are not displayed on a connected smart device or computer.

If the number of images saved on a memory card in the camera exceeds 10,000, images captured thereafter may not be displayed in a connected device.

- Reduce the number of images saved on the memory card. Copy the necessary images to a computer, etc.

Cannot select [Connection to remote].

Cannot use [Connection to remote] to pair with the ML-L7 Remote Control.

- Use a sufficiently charged battery.
- Set the following in the [Network menu (page 223)] in the camera.
[Choose connection]: [Remote control]
[Airplane mode]: [Off]
[Bluetooth] → [Connection]: [Enable]

The camera does not respond when operating the ML-L7 Remote Control.

- The camera is not connected to the ML-L7 Remote Control (available separately). Press the power button on the remote control to establish the connection. If  is not displayed on the shooting screen, perform pairing again.
→ Pairing the camera and remote control (page 265)
- The remote control can be used only for shooting operations or Fn button operations.
→ ML-L7 Remote Control (page 262)



- The remote control cannot be used when the camera and an HDMI-compatible device are connected. Disconnect the connection with the HDMI-compatible device.
-



Error messages

Check the following if an error message is displayed.

- If you cannot find a relevant entry, also check “➔ Troubleshooting (page 268)”.

Battery temperature is elevated. The camera will turn off.

The camera will turn off to prevent overheating.

The camera turns off automatically. Wait until the camera or battery temperature has cooled before resuming use.

Memory card is write protected.

The write-protect switch is locked. Unlock it.

- ➔ Memory cards (page 289)

This card cannot be used.

This card cannot be read.

An error occurred while accessing the memory card.

- Use an approved memory card.
 - ➔ Memory cards that can be used (page 40)
- Check that the terminals are clean.
- Confirm that the memory card is correctly inserted.
 - ➔ Inserting the battery and memory card (page 39)

Card is not formatted. Format card?

The memory card has not been formatted for use in the camera.

Formatting deletes all data saved on the memory card. If you need to keep copies of any images, make sure to select **[No]** and save the copies to a computer or other medium before formatting the memory card. Select **[Yes]** and press the **[OK]** button to format the memory card.

- ➔ Memory cards (page 289)

Out of memory.

Delete images or insert a new memory card.

Image cannot be saved.

- An error occurred while saving the image. Change the memory card, or use **[Format card (page 239)]** to format the memory card.



- The camera has run out of file numbers. Change the memory card, or use [**Format card (page 239)**] to format the memory card.

Image cannot be modified.

Check that the images can be edited.

- ➔ Restrictions on image editing (page 142), ➔ Cannot edit images. (page 276)

Cannot record movie.

A time-out error occurred while saving the movie on the memory card. Select a memory card with a faster write speed.

- ➔ Memory cards that can be used (page 40), ➔ Maximum movie recording time (page 147)

Cannot reset file numbering.

File numbering cannot be reset because the sequential number of a folder has reached the upper limit.

Change the memory card, or use [**Format card (page 239)**] to format the memory card.

Set the focus-mode selector to MF.

When [**Clean HDMI output (page 240)**] is set to [**On**] and the camera is connected to an HDMI-compatible device, set the focus-mode selector to **MF**.

- ➔ The camera body (page 17)

Memory contains no images.

Insert a memory card that contains images.

File contains no image data.

The file was not created or edited with this camera. The file cannot be viewed on this camera.

View the file using a computer or the device used to create or edit this file.

All images are hidden.

- There are no images available for a slide show, etc.
- There are no images that can be displayed on the image selection screen for deletion.

This image cannot be deleted.

The image is protected.

Disable protection.



Raise the flash.

When shooting in [**Night portrait**] or [**Backlighting**] (with [**HDR**] set to [**Off**]) scene mode, raise the built-in flash before shooting.

Turn the camera off and then on again.

An error occurred in lens operation.

Do not apply excessive force on the lens.

If you turn the camera off and then on again, lens operation will return to normal.

→ The camera is on but does not respond. (page 268)

If the error persists even after turning the camera off and then on again, contact your retailer or Nikon-authorized service representative.

Speedlight setting error

A Speedlight function that cannot be used with the camera is set. Change the Speedlight setting.

→ Speedlights (external flash units) (page 260)

System error

An error occurred in the camera's internal circuitry. Turn the camera off, remove and reinsert the battery, and turn the camera on.

→ The camera is on but does not respond. (page 268)

If the error persists, contact your retailer or Nikon-authorized service representative.

Clean HDMI output enabled. Select "Movie manual" mode.

When [**Clean HDMI output**] is set to [**On**] and the camera is connected to an HDMI-compatible device, rotate the mode dial to Movie manual.

→ Movie manual (page 150)



Technical notes

Notes about wireless communication functions	285
Caring for the product	286
Cleaning and storage	291
File names	292
Specifications	293
Trademarks	300
Index	302



Notes about wireless communication functions

For precautions about wireless communications in your country of purchase, please refer to the manual included with the camera.



Caring for the product

Observe the precautions described below in addition to the warnings in “➔For your safety (page 12)” when using or storing the device.

The camera

- **Do not apply strong impact to the camera**

The product may malfunction if subjected to strong shock or vibration. In addition, do not touch or apply force to the lens.

- **Keep dry**

The device will be damaged if immersed in water or subjected to high humidity.

- **Do not disassemble**

Do not, under any circumstances, disassemble the camera because it is composed of many precise circuits.

- **Avoid sudden changes in temperature**

Sudden changes in temperature, such as when entering or leaving a heated building on a cold day, can cause condensation to form inside the device. To prevent condensation, place the device in a carrying case or a plastic bag before exposing it to sudden changes in temperature.

- **Keep away from strong magnetic fields**

Do not use or store this device in the vicinity of equipment that generates strong electromagnetic radiation or magnetic fields. Doing so could result in loss of data or camera malfunction.

- **Do not point the lens at the sun**

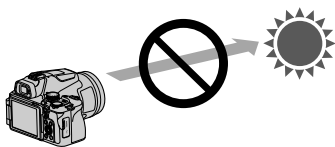

Avoid pointing the lens at the sun or other strong light sources when shooting or when leaving the camera unattended without a lens cap. Strong light sources such as sunlight are concentrated through the lens, which may cause deformation of the internal parts of the lens or discoloration or burn-in on the image sensor. The camera



may be damaged even when the lens is pointed toward the sun for a few seconds, particularly when the lens is in a telephoto position. The camera may not be able to perform exposure control when the internal parts of the lens are deformed. Unevenness may appear in images when discoloration or burn-in occurs on the image sensor. It is recommended that you attach the lens cap when you are not using the camera.

● **Lasers and other bright light sources**

Do not direct lasers or other extremely bright light sources toward the lens, as this could damage the camera's image sensor.

● **Turn the product off before removing or disconnecting the power source or memory card**

Do not remove the battery while the product is on, or while images are being saved or deleted. Forcibly cutting power in these circumstances could result in loss of data or in damage to the memory card or internal circuitry.

● **Notes about the monitor**

- Monitors (including electronic viewfinders) are constructed with extremely high precision; at least 99.99% of pixels are effective, with no more than 0.01% being missing or defective. Hence while these displays may contain pixels that are always lit (white, red, blue, or green) or always off (black), this is not a malfunction and has no effect on images recorded with the device.
- Images in the monitor may be difficult to see under bright lighting.
- Do not apply pressure to the monitor, as this could cause damage or malfunction. Should the monitor break, care should be taken to avoid injury caused by broken glass and to prevent the liquid crystal from the display touching the skin or entering the eyes or mouth.

The battery

● **Precautions for use**

- Note that the battery may become hot after use.
- Do not use the battery at ambient temperatures below 0°C (32°F) or above 40°C (104°F) as this could cause damage or malfunction.
- If you notice any abnormalities such as excessive heat, smoke, or an unusual smell coming from the battery, immediately discontinue use and consult your retailer or Nikon-authorized service representative.
- After removing the battery from the camera or optional battery charger, put the battery in a plastic bag, etc. in order to insulate it.



● Charging the battery

Check the battery level before using the camera and replace or charge the battery if necessary.

- Charge the battery indoors with an ambient temperature of 5°C to 35°C (41°F to 95°F) before use.
- A high battery temperature may prevent the battery from charging properly or completely, and may reduce battery performance. Note that the battery may become hot after use; wait for the battery to cool before charging. When charging the battery inserted into this camera using the Charging AC Adapter or a computer, the battery is not charged at battery temperatures below 0°C (32°F) or above 50°C (122°F).
- Do not continue charging once the battery is fully charged as this will result in reduced battery performance.
- The battery temperature may increase during charging. However, this is not a malfunction.

● Carrying spare batteries

Whenever possible, carry fully charged spare batteries when taking pictures on important occasions.

● Using the battery when cold

On cold days, the capacity of batteries tends to decrease. If an exhausted battery is used at a low temperature, the camera may not turn on. Keep spare batteries in a warm place and exchange as necessary. Once warmed, a cold battery may recover some of its charge.

● Battery terminals

Dirt on the battery terminals may prevent the camera from functioning. Should the battery terminals become dirty, wipe them off with a clean, dry cloth before use.

● Charging an exhausted battery

Turning the camera on or off while an exhausted battery is inserted in the camera may result in reduced battery life. Charge the exhausted battery before use.

● Storing the battery

- Always remove the battery from the camera or optional battery charger when it is not being used. Minute amounts of current are drawn from the battery while it is in the camera, even when not in use. This may result in excessive battery drain and complete loss of function.
- Charging a used battery within six months is recommended. When storing the battery for long periods, recharge it at least once every six months and use the camera until the battery level indicator is  before returning it to storage.



- Put the battery in a plastic bag, etc. in order to insulate it and store it in a cool place. The battery should be stored in a dry location with an ambient temperature of 15°C to 25°C (59°F to 77°F). Do not store the battery in hot or extremely cold locations.

● Battery life

A marked drop in the time a fully charged battery retains its charge, when used at room temperature, indicates that the battery needs to be replaced. Purchase a new battery.

● Recycling used batteries

Recycle rechargeable batteries in accord with local regulations, being sure to first insulate the terminals with tape.

The Charging AC Adapter

- The EH-73P/EH-73PCH Charging AC Adapter is for use only with compatible devices. Do not use with another make or model of device.
- Do not use any USB cable other than the UC-E21. Using a USB cable other than the UC-E21 could result in overheating, fire or electric shock.
- Do not, under any circumstances, use another make or model of AC adapter other than the EH-73P/EH-73PCH Charging AC Adapter, and do not use a commercially available USB-AC adapter or a battery charger for a mobile phone. Failure to observe this precaution could result in overheating or in damage to the camera.
- The EH-73P/EH-73PCH is compatible with AC 100–240 V, 50/60 Hz electrical outlets. When using in other countries, use a plug adapter (commercially available) as necessary. For more information about plug adapters, consult your travel agency.

Memory cards

● Precautions for use

- Use only Secure Digital memory cards.
 - ➔ Memory cards that can be used (page 40)
- Be sure to follow the precautions described in the documentation included with the memory card.
- If the write-protect switch of the memory card is locked, you cannot shoot, delete images, or format the memory card.

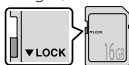

- Do not put labels or stickers on memory cards.

● Formatting

- Do not format the memory card using a computer.



- The first time you insert a memory card that has been used in another device into this camera, be sure to format it with this camera.
We recommend formatting new memory cards with this camera before using them with this camera.
- **Note that formatting a memory card permanently deletes all images and other data on the memory card.**
Be sure to make copies of any images you wish to keep before formatting the memory card.
- If the message [**Card is not formatted. Format card?**] is displayed when the camera is turned on, the memory card must be formatted. If there is data that you do not want to delete, select [**No**]. Copy the necessary data to a computer, etc. If you want to format the memory card, select [**Yes**]. The confirmation dialog will be displayed. To start formatting, press the  button.
- Do not perform the following during formatting, while data is being written to or deleted from the memory card, or during data transfer to a computer. Failure to observe this precaution could result in the loss of data or in damage to the camera or memory card:
 - Open the battery-chamber/memory card slot cover to remove/insert the battery or memory card.
 - Turn off the camera.
 - Disconnect the AC adapter.



Cleaning and storage

Cleaning

Do not use alcohol, thinner, or other volatile chemicals.

- **Lens/viewfinder:**

Avoid touching glass parts with your fingers. Remove dust or lint with a blower (typically a small device with a rubber bulb attached to one end that is pumped to produce a stream of air out the other end). To remove fingerprints or other stains that cannot be removed with a blower, wipe the lens with a soft cloth, using a spiral motion that starts at the center of the lens and working toward the edges. If this fails, clean the lens using a cloth lightly dampened with commercial lens cleaner.

- **Monitor:**

Remove dust or lint with a blower. To remove fingerprints and other stains, clean the monitor with a soft, dry cloth, being careful not to apply pressure.

- **Body:**

- Use a blower to remove dust, dirt, or sand, then wipe gently with a soft, dry cloth.
- After using the camera at the beach or other sandy or dusty environment, wipe off any sand, dust, or salt with a dry cloth lightly dampened with fresh water and dry thoroughly.

Note that foreign matter inside the camera could cause damage not covered by the warranty.

Storage

Remove the battery if the camera will not be used for an extended period.

To prevent mold or mildew, take the camera out of storage at least once a month.

Turn the camera on and release the shutter a few times before putting the camera away again.

Do not store the camera in any of the following locations:

- Places that are poorly ventilated or subject to humidity of over 60%
- Places exposed to temperatures above 50°C (122°F) or below -10°C (14°F)
- Places next to equipment that produces strong electromagnetic fields, such as televisions or radios

For storing the battery, follow the precautions in "➔ Storing the battery (page 288)".



File names

Files saved with this camera are assigned file names as follows.

DSCN0001.JPG

① ② ③

Item	Description
① Identifier	<p>Not shown on the screen of the camera.</p> <ul style="list-style-type: none">• DSCN: Original still images, movies, still images created by the movie editing function• RSCN: Cropped copies• SSCN: Small picture copies• FSCN: Images created by an image editing function other than crop and small picture, movies created by the movie editing function
② File number	<p>Assigned in ascending order, starting with "0001" and ending with "9999."</p> <ul style="list-style-type: none">• A new folder is created each time a series of images are captured using interval timer shooting, and the images are saved in that folder with file numbers starting with "0001."
③ Extension	<p>Indicates file format.</p> <ul style="list-style-type: none">• .JPG: JPEG still images• .NRW: RAW still images• .MP4: Movies

Notes

When images are captured with the [Image quality] setting set to [RAW + Fine] or [RAW + Normal], the RAW and JPEG images that are saved at the same time are assigned the same identifier and file number. The pair of images is saved in the same folder, and is counted as one file.



Specifications

Nikon COOLPIX P950 Digital Camera

Type	Compact digital camera
Number of effective pixels	16.0 million (Image processing may reduce the number of effective pixels.)
Image sensor	6.2 × 4.6 mm (1/2.3-in. type) CMOS; approx. 16.79 million total pixels
Lens	NIKKOR lens with 83× optical zoom
Focal length	4.3-357 mm (angle of view equivalent to that of 24-2000 mm lens in 35mm [135] format)
f/-number	f/2.8-6.5
Construction	16 elements in 12 groups (5 ED lens elements and 1 super ED lens element)
Digital zoom magnification	Up to 4× (angle of view equivalent to that of approx. 8000 mm lens in 35mm [135] format) Up to 3.6× when recording movies with [2160/30p] (4K UHD) or [2160/25p] (4K UHD)
Vibration reduction	Lens shift (still images) Combination of lens shift and electronic VR (movies)
Autofocus (AF)	Contrast-detect AF
Focus range	<ul style="list-style-type: none">• [W]: Approx. 50 cm (1 ft 8 in.)–∞,• [T]: Approx. 5.0 m (16 ft 5 in.)–∞• Macro close-up: [W]: Approx. 1 cm (0.4 in.)–∞, [T]: Approx. 5.0 m (16 ft 5 in.)–∞ (All distances measured from center of front surface of lens)
Focus-area selection	Target finding AF, face priority, manual (spot), manual (normal), manual (wide), subject tracking, center (spot), center (normal), center (wide)



Viewfinder	Electronic viewfinder, 1 cm (0.39-in.), approx. 2359k-dot OLED with the diopter adjustment function (-3 – +3 m ⁻¹)
Frame coverage (shooting mode)	Approx. 99% horizontal and vertical (compared to actual picture)
Frame coverage (playback mode)	Approx. 100% horizontal and vertical (compared to actual picture)
Monitor	8.1 cm (3.2-in.), approx. 921k-dot (RGB), wide viewing angle TFT LCD with anti-reflection coating and 5-level brightness adjustment, vari-angle TFT LCD
Frame coverage (shooting mode)	Approx. 99% horizontal and vertical (compared to actual picture)
Frame coverage (playback mode)	Approx. 100% horizontal and vertical (compared to actual picture)
Storage	
Media¹	SD/SDHC/SDXC memory card
File system	DCF and Exif 2.31 compliant
File formats	Still images: JPEG, RAW (NRW) (Nikon's own format) Movies: MP4 (Video: H.264/MPEG-4 AVC, Audio: AAC stereo)
Image size	
Still image	16 M [4608×3456], 8 M [3264×2448], 4 M [2272×1704], 2 M [1600×1200], 16:9 12 M [4608×2592], 3:2 14 M [4608×3072], 1:1 12 M [3456×3456]
Movie	2160/30p (4K UHD), 2160/25p (4K UHD), 1080/30p, 1080/25p, 1080/60p, 1080/50p, 720/30p, 720/25p, 720/60p, 720/50p, HS 480/4x, HS 720/2x, HS 1080/0.5x
ISO sensitivity (Standard output sensitivity)	<ul style="list-style-type: none"> • ISO 100–1600 • [100-400], [100-800], [100-1600] (default setting), [100-3200], [100-6400], [100], [200], [400], [800], [1600], [3200], and [6400] are available when using P, S, A, M, U, or Movie manual mode
Exposure	
Metering mode	Matrix, center-weighted, spot



Exposure control	Programmed auto exposure with flexible program, shutter-priority auto, aperture-priority auto, manual, exposure bracketing, exposure compensation (-2.0 – +2.0 EV in steps of 1/3 EV)
Shutter	Mechanical and CMOS electronic shutter
Speed	<ul style="list-style-type: none"> • 1/2000–1 s • In P, A mode, 1/2000–2 s (at ISO sensitivity [100-1600]) or 1/2000–30 s (when ISO sensitivity is fixed at [100]) • In S, M mode, 1/4000 (at wide-angle position, with largest f-number setting (smallest aperture))–30 s (can be set at ISO sensitivity 3200 or lower) • Bulb and Time setting (can be set when ISO sensitivity is 1600 or lower in M mode): Up to 60 seconds • When recording movies, 1/8000–1/30 s (at Frame rate [30 fps (30p/60p)]) or 1/8000–1/25 s (at Frame rate [25 fps (25p/50p)])
Flash sync speed	Synchronizes with all shutter speeds
Aperture	Electronically-controlled 6-blade iris diaphragm
Range	10 steps of 1/3 EV (W) (A , M mode)
Self-timer	Can be selected from 10 s and 3 s
Flash	
Range of built-in flash (approx.) (ISO sensitivity: [100-1600])	[W]: 0.5–11.5 m (1 ft 8 in.–37 ft) [T]: 5.0–7.0 m (16 ft 5 in.–22 ft)
Flash control	TTL auto flash with monitor preflashes
Flash exposure compensation	In steps of 1/3 EV in the range: between -2 and +2 EV
Accessory shoe	ISO 518 hot-shoe with sync and data contacts and safety lock
Interface	
USB connector	Micro-USB connector (Do not use any USB cable other than the included UC-E21 USB Cable.), Hi-Speed USB
HDMI output connector	HDMI micro connector (Type D)



Accessory terminal	Compatible with the following accessories (available separately): <ul style="list-style-type: none"> • MC-DC2 Remote Cord • WR-R10/WR-1 Wireless Remote Controller
External microphone connector	Stereo mini-pin jack (3.5 mm diameter; plug-in power supported)
Wi-Fi (Wireless LAN)	
Standards	IEEE 802.11b/g (standard wireless LAN protocol)
Operating frequency	2412–2462 MHz (1-11 channels)
Maximum output power	9.2 dBm (EIRP)
Authentication	Open system, WPA2-PSK
Bluetooth	
Communication protocols	Bluetooth Specification Version 4.1
Operating frequency	Bluetooth: 2402–2480 MHz Bluetooth Low Energy: 2402–2480 MHz
Maximum output power	Bluetooth: 7.2 dBm (EIRP) Bluetooth Low Energy: 7.2 dBm (EIRP)
Power sources	One EN-EL20a Rechargeable Li-ion Battery (included) EH-5d AC Adapter; requires EP-5C Power Connector (available separately)
Charging time	Approx. 3 h (when using EH-73P/EH-73PCH Charging AC Adapter and when no charge remains)
Battery life²	
Still images	Approx. 290 shots when using EN-EL20a
Movie recording (actual battery life for recording)³	Approx. 1 h 20 min when using EN-EL20a



Tripod socket	0.635 cm (1/4 in., ISO 1222)
Dimensions (W × H × D)	Approx. 140.2 × 109.6 × 149.8 mm (5.6 × 4.4 × 5.9 in.) (excluding projections)
Weight	Approx. 1005 g (2 lb 3.5 oz) (including battery and memory card)
Operating environment	
Temperature	0°C–40°C (32°F–104°F)
Humidity	85% or less (no condensation)

- All measurements are performed in conformity with Camera and Imaging Products Association (CIPA) standards or guidelines.
- 1 See “➔Memory cards that can be used (page 40)” for more information about memory cards.
 - 2 Battery life does not reflect the use of SnapBridge and may vary with the conditions of use, including temperature, the interval between shots, and the length of time that menus and images are displayed.
 - 3 Individual movie files cannot exceed 29 minutes in length, even when there is sufficient free space on the memory card for longer recording. The maximum size of a single movie file is 4 GB. If a file exceeds 4 GB even when you record for less than 29 minutes, it is split into multiple files and cannot be played back continuously. Recording may end before the maximum recording time is reached if the camera temperature becomes elevated.

EN-EL20a Rechargeable Li-ion Battery

Type	Rechargeable lithium-ion battery
Rated capacity	DC 7.2 V, 1110 mAh
Operating temperature	0°C–40°C (32°F–104°F)
Dimensions (W × H × D)	Approx. 30.7 × 50.0 × 14.0 mm (1.2 × 2.0 × 0.6 in.)
Weight	Approx. 42 g (1.5 oz)



EH-73P/EH-73PCH Charging AC Adapter

Rated input	AC 100–240 V, 50/60 Hz, MAX 0.14 A
Rated output	DC 5.0 V, 1.0 A, 5.0 W
Operating temperature	0°C–40°C (32°F–104°F)
Average active efficiency	73.77%
No-load power consumption	0.075 W
Dimensions (W × H × D)	Approx. 55 × 22 × 54 mm (2.2 × 0.9 × 2.2 in.) (excluding plug adapter) For Argentina: Approx. 55 × 63 × 59 mm (2.2 × 2.5 × 2.4 in.) For India: Approx. 55 × 63.5 × 59 mm For Korea: Approx. 55 × 67 × 59 mm
Weight	Approx. 51 g (1.8 oz) (excluding plug adapter) For Argentina: Approx. 76 g (2.7 oz) For India: Approx. 81 g For Korea: Approx. 73 g

The symbols on this product represent the following:

~ AC, — DC, □ Class II equipment (The construction of the product is double-insulated.)

- Nikon will not be held liable for any errors this manual may contain.
- The appearance of this product and its specifications are subject to change without notice.
- The sample images displayed on the camera and the images and illustrations in the manual are for illustrative purposes only.

Notices for customers in Europe

Distributor (importer for EU countries)

Nikon Europe B.V.

The Garden, Stroombaan 14,
1181 VX Amstelveen, The Netherlands
+31-20-7099-000



Commercial registration number: 34036589



Trademark information

- Windows is either a registered trademark or trademark of Microsoft Corporation in the United States and/or other countries.
- The *Bluetooth*® word mark and logos are registered trademarks owned by Bluetooth SIG, Inc. and any use of such marks by Nikon Corporation is under license.
- Apple®, App Store®, the Apple logos, Mac, OS X, macOS, iPhone®, iPad®, iPod touch® and iBooks are trademarks or registered trademarks of Apple Inc., in the U.S. and other countries.
- Android, Google Play and the Google Play logo are trademarks of Google LLC. The Android robot is reproduced or modified from work created and shared by Google and used according to terms described in the Creative Commons 3.0 Attribution License.
- iOS is a trademark or registered trademark of Cisco Systems, Inc., in the United States and/or other countries and is used under license.
- Adobe, the Adobe logo, Acrobat, and Reader are either trademarks or registered trademarks of Adobe Systems Incorporated in the United States and/or other countries.
- SDXC, SDHC, and SD Logos are trademarks of SD-3C, LLC.



- HDMI, HDMI logo and High-Definition Multimedia Interface are trademarks or registered trademarks of HDMI Licensing, LLC.

HDMI

- Wi-Fi and the Wi-Fi logo are trademarks or registered trademarks of the Wi-Fi Alliance.
- All other trade names mentioned in this manual or the other documentation provided with your Nikon product are the trademarks or registered trademarks of their respective holders.

AVC Patent Portfolio License

This product is licensed under the AVC Patent Portfolio License for the personal and non-commercial use of a consumer to (i) encode video in compliance with the AVC standard ("AVC video") and/or (ii) decode AVC video that was encoded by a consumer engaged in a personal and non-commercial activity and/or was obtained from a video provider licensed to provide AVC video. No license is granted or shall be implied for any other use. Additional information may be obtained from MPEG LA, L.L.C.

See <https://www.mpegla.com>.



FreeType License (FreeType2)

Portions of this software are copyright © 2012 The FreeType Project (<https://www.freetype.org>). All rights reserved.

MIT License (HarfBuzz)

Portions of this software are copyright © 2020 The HarfBuzz Project (<https://www.freedesktop.org/wiki/Software/HarfBuzz>). All rights reserved.



Index

- A**
AC adapter.....256
Accessories.....256
Active D-Lighting.....197
AE-L/AF-L button.....19, 20, 112, 237
AE/AF lock button.....121, 237
AF area mode.....121, 191
AF assist.....235
AF-assist illuminator.....17
Airplane mode.....223
Aperture-priority auto mode.....61, 63
App.....224
Apply selection button.....19, 22
Assign side dial.....236
Assign side zoom control.....121, 236
Auto flash.....100
Auto mode.....61, 62
Auto off.....51, 238
Auto with red-eye reduction.....100, 101
Autofocus.....106, 107, 111
Autofocus mode.....121, 196, 206
- B**
Backlighting.....78, 88
Battery.....12, 39, 41, 287, 296, 297
Battery charger.....256
Battery level.....48
Battery-chamber/memory card slot cover.....19, 39
Beach.....78, 84
Bird-watching mode.....61, 78, 79
Bluetooth.....225
Brightness.....229
Built-in flash.....18, 99
Bulb setting (long time-exposure).....69
Button sound.....238
- C**
Calendar display.....136
Charge by Computer.....241
Charge lamp.....17, 41
Charging.....41
Charging AC Adapter.....12, 41, 289, 298
Choose connection.....224
Clean HDMI output.....240, 248
Cleaning.....291
Clock.....44, 227
Close-up.....78, 86
Color temperature.....182
Command dial.....23, 63
Computer.....250
Conformity marking.....246
Connect to smart device.....224
Connection to remote.....224
Connector cover.....17, 41
Continuous.....121, 185
Contrast.....179
COOLPIX Custom Picture Control.....180
COOLPIX Picture Control.....121, 177
Copyright information.....242
Creative mode.....61, 75
Crop.....134
Custom Picture Control.....180
- D**
Date and time.....44, 227
Date format.....45, 227
Date stamp.....232
Daylight saving time.....45, 227
Delete.....57, 139
Delete button.....19, 24, 57, 139
Digital zoom.....121, 124, 235
Diopter adjustment control.....18, 54



Display button.....	19, 23	Focal length selection.....	79, 80
Dusk/dawn.....	78, 85	Focus.....	50, 146, 191, 196, 206
Dynamic Fine Zoom.....	125	Focus area.....	28, 50, 92, 191
D-Lighting.....	213	Focus indicator.....	25
E		Focus lock.....	111
Easy panorama.....	78, 89	Focus mode.....	98, 106
Editing movies.....	158	Focus-mode selector.....	20
Editing still images.....	142	Food.....	78, 87
EH-73P/EH-73PCH.....	298	Format card.....	39, 239
Electronic VR.....	207	Format memory cards.....	39, 239
EN-EL20a.....	297	Formatting.....	39, 239
Erase.....	57, 139	Frame rate.....	209
EVF auto toggle.....	232	Full-frame playback.....	30, 55, 132, 136
EVF options.....	230	Full-time AF.....	196, 206
Exposure bracketing.....	190	Function button.....	17, 23, 121
Exposure compensation.....	98, 117	Functions that cannot be used simultaneously.....	127
Exposure mode.....	150	F-number.....	63
Extension.....	292	H	
External mic sensitivity.....	209	HDMI.....	239
Extracting still images.....	159	HDMI cable.....	248
Eye sensor.....	19, 54	HDMI micro connector.....	17, 248
Eyellet for strap.....	17	HDR.....	88
F		High-speed continuous.....	186
Face detection.....	110	Histogram.....	31, 118, 230
Face priority.....	192	HS movie.....	205, 206
Fast motion movies.....	205, 206	I	
File name.....	292	Identifier.....	292
Fill flash.....	100	Image comment.....	241
Filter effects.....	179, 214	Image quality.....	121, 174
Fireworks show.....	78, 88	Image review.....	230
Firmware version.....	246	Image sharpening.....	179
Flash exp. comp.....	196	Image size.....	121, 175
Flash mode.....	98, 99	Infinity.....	107
Flash pop-up button.....	18, 52, 99	Inputting characters.....	226
Flash-ready indicator.....	100	Interval timer shooting.....	186, 188
Fn button setting.....	121	ISO sensitivity.....	121, 189
Focal length.....	200, 201, 293		



K		Movie recording time remaining.....	
Key picture selection.....	222	145, 147
L		Movie-record button.....	19, 21, 53, 145
Landscape.....	78, 81	Multi selector.....	19, 22, 98
Language.....	239	Multiple exposure.....	198
Lens.....	17, 293	Multiple exp. Lighten.....	78, 94
Lens cap.....	38	N	
Lens hood.....	38	Network menu.....	171, 223
Li-ion rechargeable battery.....	297	Night landscape.....	78, 85
Location data.....	243	Night portrait.....	78, 83
Long exposure NR.....	197	Noise reduction filter.....	197
M		Number of exposures remaining.....	
M exposure preview.....	201	48, 175
Macro close-up.....	107	NX Studio.....	250
Manual focus.....	113	P	
Manual mode.....	61, 64	Pairing the remote control.....	265
Mark for upload.....	211	Party/indoor.....	78, 83
Memory capacity.....	48, 145	Peaking.....	121, 245
Memory card.....	39, 40, 289	Pet portrait.....	78, 92
Memory card slot.....	39	Pet portrait auto release.....	92
Menu button.....	19, 23, 162	Picture Control.....	121, 177
Metering.....	121, 184	Playback.....	55, 145
Microphone (stereo).....	17	Playback button.....	19, 23, 55
Micro-USB connector.....	17, 41, 250	Playback menu.....	170, 211
Minimum shutter speed.....	190	Playback mode.....	55
Mode dial.....	17, 20, 48, 61	Playback zoom.....	55, 132
Monitor.....	19, 25, 43, 287, 291	Portrait.....	78, 81
Monitor button.....	19, 23, 54	Power.....	44
Monitor options.....	230	Power connector.....	259
Monitor settings.....	229	Power connector cover.....	19
Moon mode.....	61, 78, 80	Power switch.....	17, 44
Movie manual mode.....	61, 150	Power-on lamp.....	17, 34
Movie manual mode menu.....	168, 203	Preset manual.....	183
Movie menu.....	169, 204	Pressing halfway.....	21, 50, 108
Movie options.....	204	Pre-shooting cache.....	186, 187
Movie playback.....	55, 145	Print.....	143
Movie recording.....	53, 145	Printer.....	143



Programmed auto mode.....	61, 63	Shutter speed.....	63
Protect.....	218	Shutter-priority auto mode.....	61, 63
Q			
Quick adjust.....	179	Shutter-release button.....	17, 21, 50, 108
Quick retouch.....	212	Side dial.....	21, 236
R			
Rear-curtain sync.....	100	Side zoom control.....	18, 21, 124
Rechargeable battery.....	41	Single.....	185
Red-eye reduction.....	100, 101	Single AF.....	196, 206
Red-eye reduction lamp.....	17, 101	Skin softening.....	110, 213
Remote control.....	262	Slide show.....	216
Reset all.....	245	Slot empty release lock.....	229
Reset file numbering.....	244	Slow motion movies.....	205, 206
Reset user settings.....	72	Slow sync.....	100
Restore default settings.....	225	Small picture.....	220
Rotary multi selector.....	19, 22, 98	Smile timer.....	98, 104
Rotate image.....	218	SnapBridge app.....	224
S			
Saturation.....	179	Snap-back zoom.....	236
Save user settings.....	71	Snap-back zoom button.....	18, 21, 126
Scene mode.....	61, 78	Snow.....	78, 84
Screen indicators.....	25	Sound settings.....	238
SD memory card.....	39, 40, 289	Speaker.....	18
Selective color.....	78, 93	Sports.....	78, 82
Self-timer.....	98, 102	Standard flash.....	100
Self-timer lamp.....	17, 102, 105	Startup zoom position.....	201
Self-timer: after release.....	233	Strap.....	37
Send while shooting.....	224	Subject tracking.....	193, 194
Sequence.....	138	Sunset.....	78, 84
Sequence display.....	221	T	
Setup menu.....	172, 227	Target finding AF.....	108, 194
Shooting.....	48, 61, 145	Telephoto.....	124
Shooting information.....	25	Thumbnail playback.....	55, 136
Shooting menu.....	166, 174, 177	Time difference.....	227
Shooting mode.....	61	Time setting (long time-exposure).....	69
Shutter sound.....	238	Time zone.....	44, 228
		Time zone and date.....	44, 227
		Time-lapse movie.....	78, 153
		Toggle Av/Tv selection.....	121, 244
		Tone level.....	31



Tone level information.....	31, 33
Toning.....	180
Tripod socket.....	19, 297
TV.....	248

U

USB cable.....	41, 250
User settings mode.....	61, 71

V

Vibration reduction.....	121, 234
Viewfinder.....	19, 25, 54, 291
View/hide framing grid.....	29, 230
Virtual horizon.....	29, 121, 231
Volume.....	156

W

White balance.....	121, 181
Wide-angle.....	124
Wind noise reduction.....	208
Wi-Fi.....	224

Z

Zoom.....	124
Zoom control.....	17, 20, 124
Zoom memory.....	200
Zoom microphone.....	208





A series of horizontal dashed lines spanning the width of the page, intended for handwriting practice. There are 15 dashed lines in total, evenly spaced from top to bottom.

No reproduction in any form of this manual, in whole or in part (except for brief quotation in critical articles or reviews), may be made without written authorization from NIKON CORPORATION.

NIKON CORPORATION

© 2020 Nikon Corporation

CT2E05(11)
6MQ04811-05