

Nikon

DIGITAL CAMERA

COOLPIX P600

User's Manual



For advanced use of the camera, read the Reference Manual (in pdf format) which is available in many languages including Hindi, Bengali, Tamil, Marathi and Telugu.

See the reverse side for information to download the file.

En

Introduction	
Parts of the Camera and Main Functions	
The Basics of Shooting and Playback	
Shooting Features	
Playback Features	
Recording and Playing Back Movies	
General Camera Setup	
Using the Wi-Fi (Wireless LAN) Function	
Connecting the Camera to a TV, Computer, or Printer	
Technical Notes and Index	

Introduction

Read This First

Thank you for purchasing the Nikon COOLPIX P600 digital camera. Before using the camera, please read the information in "For Your Safety" (vii-ix) and familiarize yourself with the information provided in this manual. After reading, please keep this manual handy and refer to it to enhance your enjoyment of your new camera.

Confirming the Package Contents

In the event that any items are missing, please contact the store where you purchased the camera.



COOLPIX P600
Digital Camera



Camera Strap



Lens Cap LC-CP29
(with cord)



Rechargeable Li-ion
Battery EN-EL23



Charging AC Adapter
EH-71P*

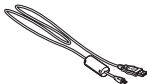

USB Cable UC-E21

- *User's Manual* (this manual)
- Warranty

* A plug adapter is included if the camera was purchased in a country or region that requires a plug adapter. The shape of the plug adapter varies with the country or region of purchase (vii-22).

NOTE: A memory card is not included with the camera.

About This Manual

If you want to start using the camera right away, see “The Basics of Shooting and Playback” (📖20).

To learn about the parts of the camera and information that is displayed in the monitor, see “Parts of the Camera and Main Functions” (📖1).

Downloading the “Reference Manual”

Refer to the *Reference Manual* (PDF format) for more detailed information.

The *Reference Manual* can be downloaded from the Nikon website.





<http://nikonimglib.com/manual/>

The *Reference Manual* can be viewed using Adobe Reader, available for free download from the Adobe website.

Other Information

- Symbols and Conventions

To make it easier to find the information you need, the following symbols and conventions are used in this manual:

Symbol	Description
	This icon indicates cautions and information that should be read before using the camera.
	This icon indicates notes and information that should be read before using the camera.
	These icons indicate other pages containing relevant information;  *: “Reference Section”,  : “Technical Notes and Index.”

* Refer to the *Reference Manual* for pages indicated with .

- SD and SDHC/SDXC memory cards are referred to as “memory cards” in this manual.
- The setting at the time of purchase is referred to as the “default setting.”
- The names of menu items displayed in the camera monitor, and the names of buttons or messages displayed on a computer monitor appear in bold.
- In this manual, images are sometimes omitted from monitor display samples so that monitor indicators can be more clearly shown.
- Illustrations and monitor content shown in this manual may differ from the actual product.

Information and Precautions

Life-Long Learning

As part of Nikon's "Life-Long Learning" commitment to ongoing product support and education, continually updated information is available online at the following sites:

- For users in the U.S.A.: <http://www.nikonusa.com/>
- For users in Europe and Africa: <http://www.europe-nikon.com/support/>
- For users in Asia, Oceania, and the Middle East: <http://www.nikon-asia.com/>

Visit these sites to keep up-to-date with the latest product information, tips, answers to frequently asked questions (FAQs), and general advice on digital imaging and photography. Additional information may be available from the Nikon representative in your area. Visit the site below for contact information:

<http://imaging.nikon.com/>

Use Only Nikon Brand Electronic Accessories

Nikon COOLPIX cameras are designed to the highest standards and include complex electronic circuitry. Only Nikon brand electronic accessories (including battery chargers, batteries, charging AC adapter, AC adapters and cables) certified by Nikon specifically for use with this Nikon digital camera are engineered and proven to operate within the operational and safety requirements of this electronic circuitry.

THE USE OF NON-NIKON ELECTRONIC ACCESSORIES COULD DAMAGE THE CAMERA AND MAY VOID YOUR NIKON WARRANTY.

The use of third-party rechargeable Li-ion batteries not bearing the Nikon holographic seal could interfere with normal operation of the camera or result in the batteries overheating, igniting, rupturing, or leaking.

For more information about Nikon brand accessories, contact a local authorized Nikon dealer.

Holographic seal: Identifies this device as an authentic Nikon product.



Before Taking Important Pictures

Before taking pictures on important occasions (such as at weddings or before taking the camera on a trip), take a test shot to ensure that the camera is functioning normally. Nikon will not be held liable for damages or lost profits that may result from product malfunction.

About the Manuals

- No part of the manuals included with this product may be reproduced, transmitted, transcribed, stored in a retrieval system, or translated into any language in any form, by any means, without Nikon's prior written permission.
- Nikon reserves the right to change the specifications of the hardware and software described in these manuals at any time and without prior notice.
- Nikon will not be held liable for any damages resulting from the use of this product.
- While every effort was made to ensure that the information in these manuals is accurate and complete, we would appreciate it were you to bring any errors or omissions to the attention of the Nikon representative in your area (address provided separately).

Notice Concerning Prohibition of Copying or Reproduction

Note that simply being in possession of material that was digitally copied or reproduced by means of a scanner, digital camera or other device may be punishable by law.

• Items prohibited by law from being copied or reproduced

Do not copy or reproduce paper money, coins, securities, government bonds or local government bonds, even if such copies or reproductions are stamped "Sample." The copying or reproduction of paper money, coins, or securities which are circulated in a foreign country is prohibited. Unless the prior permission of the government was obtained, the copying or reproduction of unused postage stamps or post cards issued by the government is prohibited.

The copying or reproduction of stamps issued by the government and of certified documents stipulated by law is prohibited.

• Cautions on certain copies and reproductions

The government has issued cautions on copies or reproductions of securities issued by private companies (shares, bills, checks, gift certificates, etc.), commuter passes, or coupon tickets, except when a minimum of necessary copies are to be provided for business use by a company. Also, do not copy or reproduce passports issued by the government, licenses issued by public agencies and private groups, ID cards and tickets, such as passes and meal coupons.

• Comply with copyright notices

The copying or reproduction of copyrighted creative works such as books, music, paintings, woodcut prints, maps, drawings, movies, and photographs is governed by national and international copyright laws. Do not use this product for the purpose of making illegal copies or to infringe copyright laws.

Disposing of Data Storage Devices

Please note that deleting images or formatting data storage devices such as memory cards or built-in camera memory does not completely erase the original image data. Deleted files can sometimes be recovered from discarded storage devices using commercially available software, potentially resulting in the malicious use of personal image data. Ensuring the privacy of such data is the user's responsibility.

Before discarding a data storage device or transferring ownership to another person, erase all data using commercial deletion software, or format the device and then completely refill it with images containing no private information (for example, pictures of empty sky). Be sure to also replace any pictures selected for the **Select an image** option in the **Welcome screen** setting (📖95). Care should be taken to avoid injury or damage to property when physically destroying data storage devices. You can clear the Wi-Fi settings using **Restore default settings** in the Wi-Fi options menu (🔌58).

For Your Safety

To prevent damage to your Nikon product or injury to yourself or to others, read the following safety precautions in their entirety before using this equipment. Keep these safety instructions where all those who use the product will read them.

The consequences that could result from failure to observe the precautions listed in this section are indicated by the following symbol:



This icon marks warnings, information that should be read before using this Nikon product, to prevent possible injury.

WARNINGS

Turn off in the event of malfunction

Should you notice smoke or an unusual smell coming from the camera or charging AC adapter, unplug the charging AC adapter and remove the battery immediately, taking care to avoid burns. Continued operation could result in injury. After removing or disconnecting the power source, take the equipment to a Nikon-authorized service representative for inspection.

Do not disassemble

Touching the internal parts of the camera or charging AC adapter could result in injury. Repairs should be performed only by qualified technicians. Should the camera or charging AC adapter break open as the result of a fall or other accident, take the product to a Nikon-authorized service representative for inspection, after unplugging the product and/or removing the battery.

Do not use the camera or charging AC adapter in the presence of flammable gas

Do not use electronic equipment in the presence of flammable gas, as this could result in explosion or fire.

Handle the camera strap with care

Never place the strap around the neck of an infant or child.

Keep out of reach of children

Particular care should be taken to prevent infants from putting the battery or other small parts into their mouths.

Do not remain in contact with the camera, charging AC adapter, or AC adapter for extended periods while the devices are on or in use

Parts of the devices become hot. Leaving the devices in direct contact with the skin for extended periods may result in low-temperature burns.

⚠ Do not leave the product where it will be exposed to extremely high temperatures, such as in an enclosed automobile or in direct sunlight

Failure to observe this precaution could cause damage or fire.

⚠ Use the appropriate power supply (battery, charging AC adapter, AC adapter, USB cable)

Using a power supply other than those provided or sold by Nikon could result in damage or malfunction.

⚠ Observe caution when handling the battery

The battery may leak, overheat, or explode if improperly handled. Observe the following precautions when handling the battery for use in this product:

- Before replacing the battery, turn the product off. If you are using the charging AC adapter/AC adapter, be sure it is unplugged.
- Use only a Rechargeable Li-ion Battery EN-EL23 (included). Charge the battery by using a camera that supports battery charging. To perform this operation, use the Charging AC Adapter EH-71P (included) and USB Cable UC-E21 (included). The Battery Charger MH-67P (available separately) is also available to charge the battery without using a camera.
- When inserting the battery, do not attempt to insert it upside down or backwards.
- Do not short or disassemble the battery or attempt to remove or

break the battery insulation or casing.

- Do not expose the battery to flame or to excessive heat.
- Do not immerse in or expose to water.
- Put the battery in a plastic bag, etc. to insulate the terminal before transporting it. Do not transport or store with metal objects such as necklaces or hairpins.
- The battery is prone to leakage when fully discharged. To avoid damage to the product, be sure to remove the battery when no charge remains.
- Discontinue use immediately should you notice any change in the battery, such as discoloration or deformation.
- If liquid from the damaged battery comes in contact with clothing or skin, rinse immediately with plenty of water.

⚠ Observe the following precautions when handling the charging AC adapter

- Keep dry. Failure to observe this precaution could result in fire or electric shock.
- Dust on or near the metal parts of the plug should be removed with a dry cloth. Continued use could result in fire.
- Do not handle the plug or go near the charging AC adapter during lightning storms. Failure to observe this precaution could result in electric shock.
- Do not damage, modify, forcibly tug or bend the USB cable, place it under heavy objects, or expose it to heat or flames. Should the insulation be damaged and the

wires become exposed, take it to a Nikon-authorized service representative for inspection.

Failure to observe these precautions could result in fire or electric shock.

- Do not handle the plug or charging AC adapter with wet hands. Failure to observe this precaution could result in electric shock.
- Do not use with travel converters or adapters designed to convert from one voltage to another or with DC-to-AC inverters. Failure to observe this precaution could damage the product or cause overheating or fire.

Use appropriate cables

When connecting cables to the input and output jacks, use only the cables provided or sold by Nikon for the purpose, to maintain compliance with product regulations.

Handle moving parts with care

Be careful that your fingers or other objects are not pinched by the lens cover or other moving parts.

Using the flash close to your subject's eyes could cause temporary visual impairment

The flash should be no less than 1 m (3 ft 4 in.) from the subject.

Particular care should be observed when photographing infants.

Do not operate the flash with the flash window touching a person or object

Failure to observe this precaution could result in burns or fire.

Avoid contact with liquid crystal

Should the monitor break, care should be taken to avoid injury caused by broken glass and to prevent liquid crystal from the monitor touching the skin or entering the eyes or mouth.

Turn the power off when using inside an airplane or the hospital

Turn the power off while inside the airplane during take off or landing. Do not use wireless network functions while in the air.

Follow the instructions of the hospital when using while in a hospital.

The electromagnetic waves emitted by this camera may disrupt the electronic systems of the airplane or the instruments of the hospital.

If you are using an Eye-Fi card, remove it from the camera before boarding an aircraft or entering a hospital.

Notices

Notices for Customers in the U.S.A.

IMPORTANT SAFETY INSTRUCTIONS -

SAVE THESE INSTRUCTIONS.

DANGER - TO REDUCE THE RISK OF FIRE OR ELECTRIC SHOCK, CAREFULLY FOLLOW THESE INSTRUCTIONS

For connection to a supply not in the U.S.A., use an attachment plug adapter of the proper configuration for the power outlet if needed.

The power supply unit is intended to be correctly orientated in a vertical or floor mount position.

Federal Communications Commission (FCC) Radio Frequency Interference Statement

This equipment has been tested and found to comply with the limits for a Class B digital device, pursuant to Part 15 of the FCC Rules. These limits are designed to provide reasonable protection against harmful interference in a residential installation. This equipment generates, uses, and can radiate radio frequency energy and, if not installed and used in accordance with the instructions, may cause harmful interference to radio communications. However, there is no guarantee that interference will

not occur in a particular installation. If this equipment does cause harmful interference to radio or television reception, which can be determined by turning the equipment off and on, the user is encouraged to try to correct the interference by one or more of the following measures:

- Reorient or relocate the receiving antenna.
- Increase the separation between the equipment and receiver.
- Connect the equipment into an outlet on a circuit different from that to which the receiver is connected.
- Consult the dealer or an experienced radio/TV technician for help.



Nikon

COOLPIX P600

CAUTIONS

Modifications

The FCC requires the user to be notified that any changes or modifications made to this device that are not expressly approved by Nikon Corporation may void the user's authority to operate the equipment.

Interface Cables

Use the interface cables sold or provided by Nikon for your equipment. Using other interface cables may exceed the limits of Class B Part 15 of the FCC Rules.

Notice for Customers in the State of California

WARNING

Handling the cord on this product will expose you to lead, a chemical known to the State of California to cause birth defects or other reproductive harm.

Wash hands after handling.

Nikon Inc.,
1300 Walt Whitman Road,
Melville, New York 11747-3064
USA
Tel: 631-547-4200

Notice for Customers in Canada

CAN ICES-3 B / NMB-3 B

Notices for Customers in Europe

CAUTIONS

RISK OF EXPLOSION IF BATTERY IS REPLACED BY AN INCORRECT TYPE.

DISPOSE OF USED BATTERIES ACCORDING TO THE INSTRUCTIONS.

This symbol indicates that electrical and electronic equipment is to be collected separately.



The following apply only to users in European countries:

- This product is designated for separate collection at an appropriate collection point. Do not dispose of as household waste.
- Separate collection and recycling helps conserve natural resources and prevent negative consequences for human health and the environment that might result from incorrect disposal.
- For more information, contact the retailer or the local authorities in charge of waste management.

This symbol on the battery indicates that the battery is to be collected separately.



The following apply only to users in European countries:

- All batteries, whether marked with this symbol or not, are designated for separate collection at an appropriate collection point. Do not dispose of as household waste.
- For more information, contact the retailer or the local authorities in charge of waste management.

Wi-Fi (Wireless LAN Network)

This product is controlled by the United States Export Administration Regulations, and you are required to obtain permission from the United States government if you export or re-export this product to any country to which the United States embargoes goods. The following countries were subject to embargo: Cuba, Iran, North Korea, Sudan, and Syria. Since the target countries are subject to change, please contact the United States Department of Commerce for the latest information.

Restrictions on Wireless Devices

The wireless transceiver included in this product conforms to wireless regulations in the country of sale and is not for use in other countries (products purchased in the EU or EFTA can be used anywhere within the EU and EFTA). Nikon does not accept liability for use in other countries. Users who are unsure as to the original country of sale should consult with their local Nikon service center or Nikon-authorized service representative. This restriction applies to wireless operation only and not to any other use of the product.

Notice for Customers in the U.S.A. and Canada

Federal Communications Commission (FCC) and Industry of Canada (IC)

Declaration of Conformity

This device complies with Part 15 of FCC Rules and Industry Canada licence-exempt RSS standard(s). Operation is subject to the following two conditions: (1) this device may not cause interference, and (2) this device must accept any interference, including interference that may cause undesired operation of this device.

FCC/IC RF Exposure Statement

This transmitter must not be co-located or operated in conjunction with any other antenna or transmitter.

The available scientific evidence does not show that any health problems are associated with using low power wireless devices. There is no proof, however, that these low power wireless devices are absolutely safe. Low power wireless devices emit low levels of radio frequency energy (RF) in the microwave range while being used. Whereas high levels of RF can produce health effects (by heating tissue), exposure to low-level RF that does not produce heating effects causes no known adverse health effects. Many studies of low-level RF exposures have not found any biological effects. Some studies have suggested that some biological effects might occur, but such findings have not been confirmed by additional research.

COOLPIX P600, which is equipped with a LBWA1ZZYM6 (FCC ID:VPYLBYM / IC ID:772C-LBYM) Wireless LAN Module, has been tested and found to comply with FCC/IC radiation exposure limits set forth for an uncontrolled environment

and meets the FCC radio frequency (RF) Exposure Guidelines in Supplement C to OET65 and RSS-102 of the IC radio frequency (RF) Exposure rules. Please refer to the SAR test report that was uploaded to FCC website.

Declaration of Conformity (Europe)

Hereby, Nikon Corporation, declares that COOLPIX P600 is in compliance with the essential requirements and other relevant provisions of Directive 1999/5/EC. The declaration of conformity may be consulted at

http://imaging.nikon.com/support/pdf/DoC_P600.pdf.

הודעה ללקוחות במדינת ישראל

ההתקן תואם לתקנות תדרי רדיו.

יש לנהוג באמצעי זהירות בעת השימוש באפשרויות התקשורת

א. נקודות הגישה תהיה מיועדת אך ורק לחיבור משתמש תמצוי בחצרים מתוחמים (דוגמת בית, בית עסק, מתחם שדה תעופה, קמפוס אוניברסיטאי וכ'י

ב. לצורך גישה לאינטרנט, נקודת הגישה תקושר מחוץ לחצרים אך ורק אל בעל רשיון למתן שירות גישה לאינטרנט (ISP, להלן-ספק אינטרנט). הקישור לספק אינטרנט יהיה אך ורק באמצעות קו תקשורת נתונים המסופק בידי בעל רשיון למתן שירותי תקשורת נתונים;

ג. קישור נקודת הגישה מחוץ לחצרים לצורך תקשורת נתונים ייעשה באמצעות תשתיות של בעל רשיון מתאים ובלבד שלא ייעשה שימוש בקישור כאמור לצורך העברת קול (VOICE)

ד. לצורך שרות לצד ג' נדרש רשיון נוסף מאגף הנדסה ורישוי (משרד התקשורת).

Precautions when Using Radio Transmissions

Always keep in mind that radio transmission or reception of data is subject to interception by third parties. Note that Nikon is not responsible for data or information leaks that may occur during data transfer.

Personal Information Management and Disclaimer

- User information registered and configured on the product, including wireless LAN connection settings and other personal information, is susceptible to alteration and loss resulting from operational error, static electricity, accident, malfunction, repair or other handling. Always keep separate copies of important information. Nikon is not responsible for any direct or indirect damages or lost profits resulting from alteration or loss of content that is not attributable to Nikon.
- Before discarding this product or transferring it to another owner, perform **Reset all** in the setup menu (📖96) to delete all user information registered and configured with the product, including Wi-Fi options and other personal information.



























Table of Contents

Introduction	ii
Read This First	ii
Confirming the Package Contents	ii
About This Manual	iii
Information and Precautions	iv
For Your Safety	vii
WARNINGS	vii
Notices	x
Wi-Fi (Wireless LAN Network)	xii
<hr/>	
Parts of the Camera and Main Functions	1
The Camera Body	1
Principle Functions of the Controls	3
Attaching the Camera Strap and Lens Cap	7
Opening and Adjusting the Angle of the Monitor	8
Switching Between the Monitor and Viewfinder (□ Button)	9
Switching the Monitor Display (DISP Button)	10
Using Menus (the MENU Button)	12
The Monitor	14
<hr/>	
The Basics of Shooting and Playback	20
Preparation 1 Insert the Battery	20
Preparation 2 Charge the Battery	22
Preparation 3 Insert a Memory Card	24
Internal Memory and Memory Cards	25
Approved Memory Cards	25
Step 1 Turn the Camera On	26
Setting the Display Language, Date, and Time	28
Step 2 Select a Shooting Mode	30
Available Shooting Modes	31
Step 3 Frame a Picture	32
Using the Zoom	33
Step 4 Focus and Shoot	34
Step 5 Play Back Images	36
Step 6 Delete Images	37















































Refer to the *Reference Manual* for pages indicated with .

Shooting Features.....	39
📷 (Auto) Mode	39
Scene Mode (Shooting Suited to Scenes).....	40
Tips and Notes.....	41
Special Effects Mode (Applying Effects When Shooting).....	50
P, S, A, M Modes (Setting the Exposure for Shooting)	52
The Control Range of the Shutter Speed.....	56
U (User Settings) Mode.....	57
Saving Settings in U Mode (Save User Settings).....	58
Functions That Can Be Set Using the Multi Selector.....	59
Using the Flash.....	60
Using the Self-timer.....	63
Shooting Smiling Faces Automatically (Smile Timer).....	64
Using Focus Mode.....	65
Taking Images with Manual Focus.....	67
Adjusting Brightness (Exposure Compensation)	69
Default Settings.....	70
Functions That Can Be Set with the MENU Button (Shooting Menu)	72
Common Options.....	72
For P, S, A, M, U modes	72
Functions That Can Be Set with the Fn (Function) Button.....	75
Functions That Cannot Be Used Simultaneously	76
Focusing.....	80
Using the Target Finding AF.....	80
Using Face Detection.....	81
Using Skin Softening.....	82
Subjects Not Suitable for Autofocus.....	82
Focus Lock.....	83
Playback Features.....	84
Playback Zoom	84
Thumbnail Display, Calendar Display.....	85
Functions That Can Be Set with the MENU Button (Playback Menu)	86
Using the Screen for Selecting Images	88
Recording and Playing Back Movies.....	89
Recording Movies	89
Functions That Can Be Set with the MENU Button (Movie Menu)	93
Playing Back Movies	93

























Refer to the *Reference Manual* for pages indicated with 📖.

General Camera Setup	95
Functions That Can Be Set with the MENU Button (Setup Menu)	95
Using the Wi-Fi (Wireless LAN) Function	97
Functions That Can Be Performed Using Wi-Fi	97
Take Photos	97
View Photos.....	97
Installing the Software on the Smart Device	97
Connecting the Smart Device to the Camera	98
Connecting the Camera to a TV, Computer, or Printer	100
Connection Methods	100
Using ViewNX 2	102
Installing ViewNX 2	102
Transferring Images to the Computer	103
Viewing Images.....	104
<hr/>	
Reference Section	 1
<hr/>	
Using Easy Panorama (Shooting and Playback)	 2
Shooting with Easy Panorama.....	 2
Viewing Images Captured with Easy Panorama.....	 4
Viewing and Deleting Images Captured Continuously (Sequence)	 5
Viewing Images in a Sequence	 5
Deleting Images in a Sequence	 6
Editing Still Images	 7
Before Editing Images	 7
 Quick Retouch: Enhancing Contrast and Saturation	 8
 D-Lighting: Enhancing Brightness and Contrast	 8
 Skin Softening: Softening Skin Tones.....	 9
 Filter Effects: Applying Digital Filter Effects	 10
 Small Picture: Reducing the Size of an Image	 11
 Crop: Creating a Cropped Copy	 12
Connecting the Camera to a TV (Viewing Images on a TV)	 13
Connecting the Camera to a Printer (Direct Print)	 14
Connecting the Camera to a Printer	 14
Printing Individual Images.....	 15
Printing Multiple Images.....	 17











Refer to the *Reference Manual* for pages indicated with .

Editing Movies	 19
Extracting Only the Desired Portion of a Movie.....	 19
Saving a Frame from a Movie as a Still Image	 20
The Shooting Menu (P, S, A or M Mode)	 21
Image Quality	 21
Image Size	 22
Picture Control (COOLPIX Picture Control)	
(Changing the Settings for Image Recording).....	 23
Custom Picture Control (COOLPIX Custom Picture Control).....	 27
White Balance (Adjusting Hue)	 28
Metering	 31
Continuous Shooting.....	 32
ISO Sensitivity	 36
Exposure Bracketing.....	 37
AF Area Mode.....	 38
Autofocus Mode.....	 41
Flash Exp. Comp.	 41
Noise Reduction Filter	 42
Active D-Lighting	 42
Multiple Exposure	 43
Zoom Memory.....	 45
Startup Zoom Position.....	 46
M Exposure Preview	 46
The Playback Menu	 47
 Print Order (Creating a DPOF Print Order)	 47
 Slide Show	 49
 Protect.....	 50
 Rotate Image	 50
 Voice Memo.....	 51
 Copy (Copy Between Internal Memory and Memory Card).....	 52
 Sequence Display Options	 53
 Choose Key Picture	 53
The Movie Menu	 54
Movie Options.....	 54
Autofocus Mode.....	 57
Frame Rate	 57
The Wi-Fi Options Menu	 58
Operating the Text Input Keyboard	 59
The Setup Menu	 60
Welcome Screen.....	 60

Refer to the *Reference Manual* for pages indicated with .

Time Zone and Date	 61
Monitor Settings.....	 63
Print Date (Imprinting Date and Time on Images).....	 64
Vibration Reduction.....	 65
Motion Detection.....	 66
AF Assist	 66
Digital Zoom.....	 67
Assign Side Zoom Control.....	 68
Sound Settings.....	 69
Auto Off	 69
Format Memory/Format Card.....	 70
Language	 70
TV Settings.....	 71
Charge by Computer.....	 72
Toggle Av/Tv Selection	 73
Reset File Numbering	 73
Blink Warning.....	 74
Eye-Fi Upload.....	 75
Peaking.....	 76
Reset All	 76
Firmware Version	 76
Error Messages.....	 77
File Names	 81
Optional Accessories	 82

Technical Notes and Index..... 1

Caring for the Products.....	 2
The Camera.....	 2
The Battery	 3
Charging AC Adapter	 4
Memory Cards.....	 5
Caring for the Camera	 6
Cleaning.....	 6
Storage	 7
Troubleshooting	 8
Specifications	 16
Index.....	 23

Refer to the *Reference Manual* for pages indicated with .



A series of horizontal dashed lines spanning the width of the page, intended for handwriting practice.

Parts of the Camera and Main Functions

The Camera Body

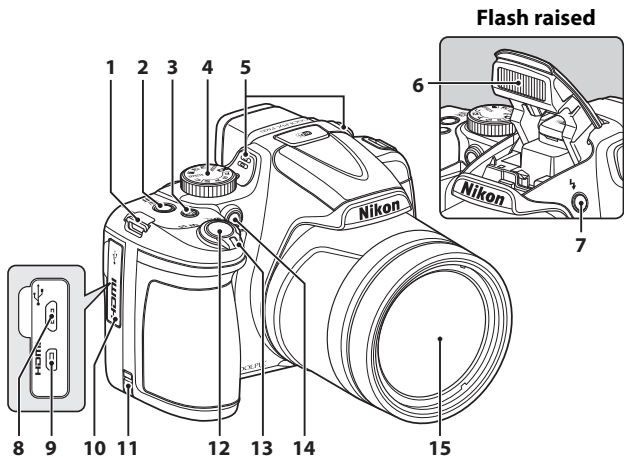



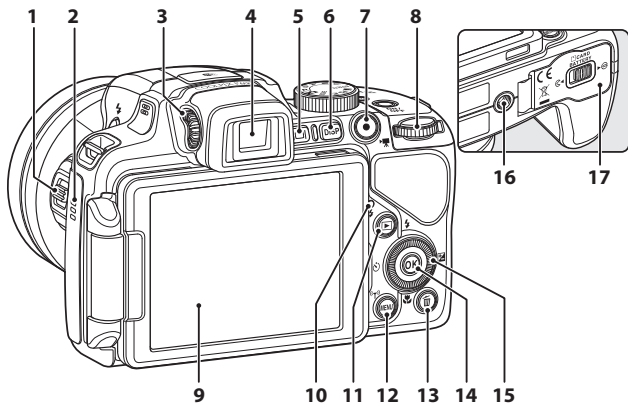





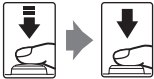

1	Eyelet for camera strap.....	7	10	Connector cover.....	100
2	Power switch/power-on lamp ...	26	11	Power connector cover (for optional AC adapter).....	82
3	F n (function) button	4	12	Shutter-release button	4, 34
4	Mode dial.....	30		Zoom control.....	33
5	Microphone (stereo).....	86, 89		W : wide-angle.....	33
6	Flash.....	60		T : telephoto	33
7	(flash pop-up) button.....	60	13	: thumbnail playback.....	85
8	Micro-USB connector.....	100		: playback zoom	84
9	HDMI micro connector (Type D).....	100		: help.....	41
			14	Self-timer lamp	63
				AF-assist illuminator.....	95
			15	Lens	



















1	Side zoom control 33 W : wide-angle 33 T : telephoto 33	10	Charge lamp 22 Flash lamp 61
2	Speaker 86, 93, 95	11	(playback) button 36
3	Diopter adjustment control 9	12	MENU (menu) button 12, 72, 86, 93, 95
4	Electronic viewfinder 9	13	(delete) button 37, 94
5	(monitor) button 9	14	(apply selection) button 3, 5, 12
6	DISP (display) button 10	15	Rotary multi selector (multi selector)* 3, 5, 59
7	(movie-record) button 89	16	Tripod socket
8	Command dial 3, 5, 52, 54	17	Battery-chamber/memory card slot cover 20, 24
9	Monitor 8, 14		

* Also referred to as the "multi selector" in this manual.

Control	Main Function	
 <p>Shutter-release button</p>	<p>When pressed halfway (i.e., if you stop pressing when you feel resistance slightly): Set focus and exposure. When pressed all the way (i.e., if you press the button all the way down): Release the shutter.</p>	34, 35
 <p>● (movie-record) button</p>	Start and stop movie recording.	89
 <p>Fn (function) button</p>	<p>When the shooting mode is P, S, A, M or U: Display or close the setting menus such as Continuous or Vibration reduction.</p>	75
 <p>Side zoom control</p>	Use the function assigned in Assign side zoom control .	33, 95
 <p> (monitor) button</p>	Switch between the monitor and viewfinder.	9
 <p>DISP (display) button</p>	Switch the information displayed in the monitor.	10
 <p> (playback) button</p>	Play back images.	36
 <p> (delete) button</p>	Delete the last image that was saved.	37

For Playback

Control	Main Function	
 (playback) button	<ul style="list-style-type: none"> When the camera is turned off, press and hold this button to turn the camera on in playback mode. Return to shooting mode. 	36 36
 Zoom control	<ul style="list-style-type: none"> Move toward T (Q) to zoom in on the image, and move toward W (W) to display images as thumbnails or the calendar. Adjust the volume for voice memo and movie playback. 	84, 85 86, 93
 Multi selector	<ul style="list-style-type: none"> While the playback screen is displayed: Change the displayed image using up (▲), left (◀), down (▼), right (▶), or by rotating the multi selector. While the setting screen is displayed: Select an item using ▲▼◀▶ or by rotating the multi selector. While an enlarged image is displayed: Move the display area. 	36 12 84
 (apply selection) button	<ul style="list-style-type: none"> Display individual images of a sequence in full-frame playback mode. Scroll an image shot with Easy panorama. Play back movies. Switch from thumbnail playback or zoomed image display to full-frame playback. While the setting screen is displayed, apply the selection. 	87, 85 47, 84 93, 84, 85 12
 Command dial	Switch the magnification of an enlarged image.	84
 MENU (menu) button	Display and hide the menu.	12, 86

Control	Main Function	
  (delete) button	Delete images.	37
  (monitor) button	Switch between the monitor and viewfinder.	9
 DISP (display) button	Switch the information displayed in the monitor.	10
 Shutter-release button	Return to shooting mode.	-
  (movie-record) button		

Attaching the Camera Strap and Lens Cap

Attach the Lens Cap LC-CP29 to the strap, and then attach the strap to the camera.

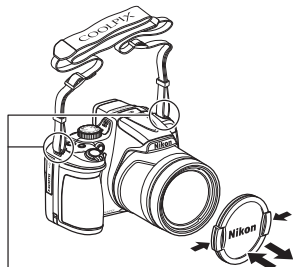
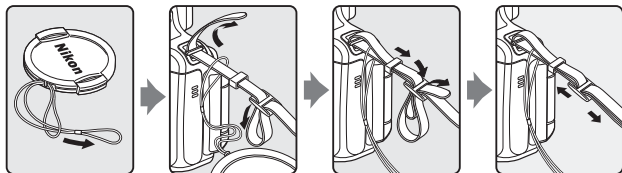

Attach the strap at two places.

✓ Lens Cap

- At times when you are not shooting images, attach the lens cap to the lens to protect it.
- Do not attach anything other than the lens cap to the lens.

Opening and Adjusting the Angle of the Monitor

The orientation and tilt of the monitor can be changed. This is useful when shooting with the camera in a high or a low position, or when taking self-portraits.

For normal shooting, fold the monitor against the camera body with the screen facing out (③).

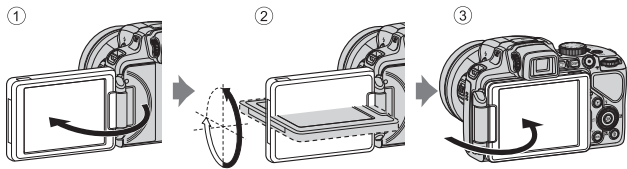

When you are not using or carrying the camera, fold the monitor against the camera body with the screen facing inward to prevent scratches or contamination.



Notes About the Monitor

When moving the monitor, do not apply excessive force and turn slowly within the monitor's adjustable range so that the connection will not be damaged.

Switching Between the Monitor and Viewfinder (|□| Button)

You can use the viewfinder when bright light under the open sky makes it difficult to see the monitor.

Each press of the |□| button switches the display between the monitor and viewfinder.

- When you fold the monitor against the camera body with the screen facing inward, the display in the monitor is switched to the viewfinder.

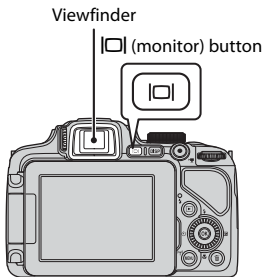

Diopter Adjustment of the Viewfinder

When the image in the viewfinder is difficult to see, adjust by rotating the diopter adjustment control while looking through the viewfinder.

- Take care not to scratch your eye with your fingertips or nails.

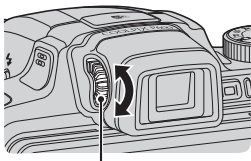

Diopter adjustment control

✓ Notes About Checking and Adjusting Image Colors

Use the monitor on the back of the camera because the monitor has higher color reproducibility than the viewfinder.

Switching the Monitor Display (DISP Button)

To switch the information displayed in the monitor during shooting and playback, press the **DISP** (display) button.

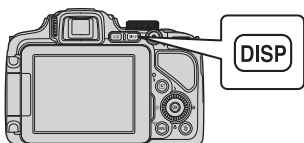

For Shooting



Show information

Display the image and the shooting information.



Movie frame

Display the range of a movie in a frame.



Hide information

Display the image only.



Histogram and Framing Grid Displays for Shooting

A histogram or framing grid can be displayed (📖16) using **Monitor settings** in the setup menu (📖95).

For Playback



Show information
Display the image and photo information.

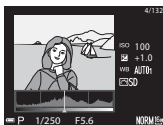

Tone level information*
(except movies)
Display a histogram, tone level and shooting information (📖18).



Hide information
Display the image only.

Using Menus (the MENU Button)

Use the multi selector and **OK** button to navigate the menus.

1 Press the MENU button.

- The menu that matches the status of the camera, such as shooting or playback menu, is displayed. Unavailable menu items are displayed in gray and cannot be selected.

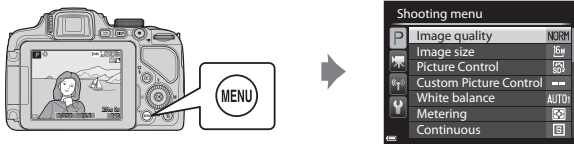

2 Use the multi selector to select a menu item.

- ▲▼ or rotation: Select an item above or below.
- ◀▶: Select an item on the left or right, or move between menu levels.
- **OK**: Apply a selection. Pressing ▶ also applies a selection.
- See [13](#) for more information on how to switch tabs.



3 After completing the settings, press the MENU button or shutter-release button.

- Press the shutter-release button to display the shooting screen.

Notes About the Command Dial Operation When a Menu is Displayed

Rotating the command dial when a menu is displayed allows you to select an item.

Switching Among Menu Tabs

To display a different menu, such as the setup menu (📖95), use the multi selector to switch to another tab.

Tabs

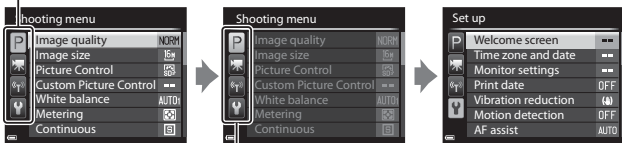



Use ◀ to move to the tabs.

Use ▲▼ to select a tab, and press the Ⓚ button or ▶ to apply the selection.

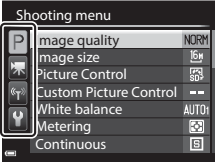
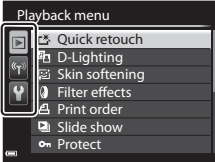
Tab Types

For Shooting	For Playback
 <p>Shooting menu</p> <ul style="list-style-type: none"> Image quality NORM Image size 16M Picture Control SD3 Custom Picture Control -- White balance AUTO Metering Continuous 	 <p>Playback menu</p> <ul style="list-style-type: none"> Quick retouch D-Lighting Skin softening Filter effects Print order Slide show Protect
<p>P tab: Displays the settings available for the current shooting mode (📖31). Depending on the current shooting mode, the tab icon that is displayed will be different.</p> <p>📽 tab: Displays movie recording settings.</p> <p>📶 tab: Displays the settings for Wi-Fi options.</p> <p>🔑 tab: Displays the setup menu, where you can change general settings.</p>	<p>▶ tab: Displays the settings available for the playback mode.</p>

1	Shooting mode.....	30, 31	27	Travel destination icon.....	95
2	Flash mode.....	60	28	Eye-Fi communication indicator.....	96,  75
3	Focus mode.....	65	29	White balance.....	72
4	Zoom indicator.....	33, 66	30	COOLPIX Picture Control.....	72
5	Focus indicator.....	34	31	Active D-Lighting.....	73
6	Zoom memory.....	74	32	Continuous shooting mode.....	48, 73
7	Movie options (normal speed movies).....	93	33	Backlighting (HDR).....	46
8	Movie options (HS movies).....	93	34	Exposure bracketing.....	73
9	Image quality.....	72	35	Hand-held/tripod.....	41
10	Image size.....	72	36	Multiple exposure.....	73
11	Easy panorama.....	47		Self-timer indicator.....	63
12	Noise reduction filter.....	73	37	Smile timer.....	64
13	Motion detection icon.....	95		Pet portrait auto release.....	48
14	Vibration reduction icon.....	95			
15	Exposure indicator.....	54			
16	Flash exp. comp.....	73			
17	Exposure compensation value.....	69			
18	Movie recording time remaining.....	89, 90			
19	Number of exposures remaining (still images).....	26,  21			
20	Internal memory indicator.....	26			
21	Aperture value.....	52			
22	Shutter speed.....	52			
23	ISO sensitivity.....	73			
24	Battery level indicator.....	26			
25	"Date not set" indicator.....	28, 95			
26	Print date.....	95			

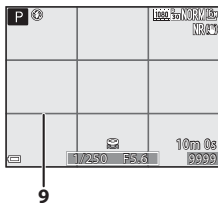
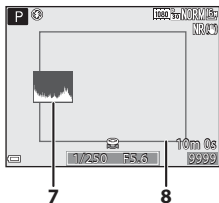
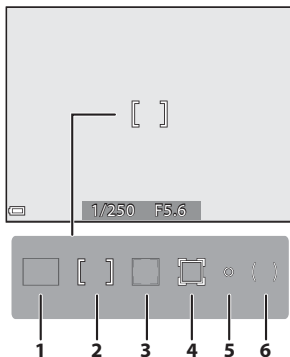

- 1** Focus area (target finding AF)73, 75, 80
- 2** Focus area (center/manual)40, 50, 73, 75, 83
- 3** Focus area (face detection, pet detection)48, 64, 73, 75, 81
- 4** Focus area (subject tracking)73, 75, 40

- 5** Spot metering area.....73
- 6** Center-weighted area.....73
- 7** View/hide histograms 10, 95, 63
- 8** Framing border (**Moon** or **Bird-watching** scene mode, or snap-back zoom) 49, 68
- 9** View/hide framing grid 10, 95, 63

For Playback

Full-frame playback (📖36)

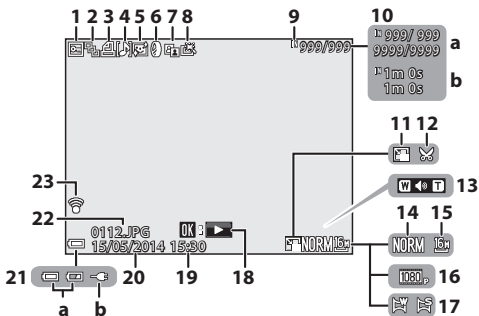

1	Protect icon.....	86
2	Sequence display (when Individual pictures is selected).....	87, 📖53
3	Print order icon.....	86
4	Voice memo indicator.....	86
5	Skin softening icon.....	86
6	Filter effects icon.....	86
7	D-Lighting icon.....	86
8	Quick retouch icon.....	86
9	Internal memory indicator.....	25
10	(a) Current image number/ total number of images (b) Movie length	
11	Small picture icon.....	86
12	Crop icon.....	84

13	Volume indicator.....	86, 93
14	Image quality.....	72
15	Image size.....	72
16	Movie options.....	93
17	Easy panorama indicator.....	47
	Easy panorama playback guide	5, 47, 📖4
18	Sequence playback guide	5, 📖5
	Movie playback guide.....	93
19	Time of recording.....	28
20	Date of recording.....	28
	(a) Battery level indicator.....	26
21	(b) Charging AC adapter connection indicator	
22	File number and type.....	📖81
23	Eye-Fi communication indicator.....	96, 📖75

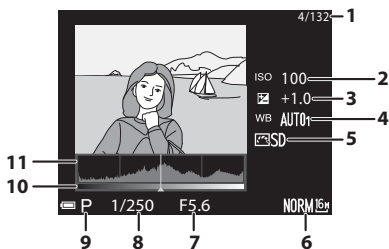
Tone level information display¹ (📖11)

1	Current image number/ total number of images	6	Image quality/Image size 72
2	ISO sensitivity 73	7	Aperture value 52
3	Exposure compensation value... 69	8	Shutter speed 52
4	White balance 72	9	Shooting mode 31
5	COOLPIX Picture Control 72	10	Tone level ²
		11	Histogram ³

¹ You can check for loss of contrast detail in highlights and shadows from the histogram that is displayed, or the flashing display for each tone level. These provide guidelines when adjusting the image brightness with functions such as exposure compensation.

² The tone level indicates the brightness level. When the tone level to check is selected using the multi selector ◀▶, the area of the image that corresponds to the selected tone level flashes.

³ A histogram is a graph showing the distribution of tones in the image. The horizontal axis corresponds to pixel brightness, with dark tones to the left and bright tones to the right. The vertical axis shows the number of pixels.



A series of horizontal dashed lines spanning the width of the page, intended for handwriting practice.

The Basics of Shooting and Playback

Preparation 1 Insert the Battery

- 1** Open the battery-chamber/
memory card slot cover.

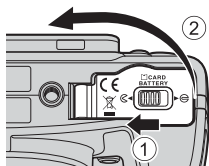

- 2** Insert the battery.

- Push the orange battery latch in the direction indicated by the arrow (1), and fully insert the battery (2).
- The battery locks into place when inserted correctly.

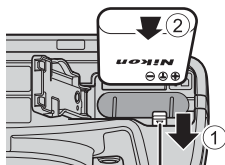

Battery latch

- ✓ Be Careful to Insert the Battery in Correct Direction**

Inserting the battery upside down or backwards could damage the camera.



- 3** Close the battery-chamber/
memory card slot cover.

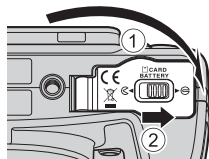

Removing the Battery

Turn the camera off and make sure that the power-on lamp and the monitor have turned off, and then open the battery-chamber/memory card slot cover.

Move the battery latch in the direction indicated by the arrow (①) to eject the battery (②).

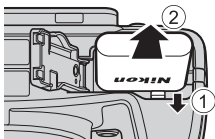

High Temperature Caution

The camera, battery, and memory card may be hot immediately after using the camera.

Preparation 2 Charge the Battery

1 Prepare the included charging AC adapter.

If a plug adapter* is included with your camera, attach the plug adapter to the plug on the charging AC adapter. Push the plug adapter firmly until it is securely held in place. Once the two are connected, attempting to forcibly remove the plug adapter could damage the product.

* The shape of the plug adapter varies according to the country or region in which the camera was purchased.

This step can be omitted if the plug adapter comes permanently bonded to the charging AC adapter.

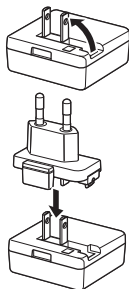

2 Make sure the battery is inserted in the camera, and then connect the camera to the charging AC adapter in order of ① to ③.

- Keep the camera turned off.
- Make sure that the plugs are properly oriented. Do not insert or remove the plugs at an angle when connecting or disconnecting them.

✓ Notes

Do not use a USB cable other than the UC-E21. Using a USB cable other than the UC-E21 could result in overheating, fire or electric shock.

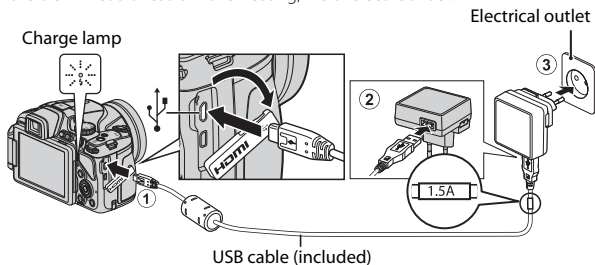

- The charge lamp slowly flashes green to indicate that the battery is charging.

The charge lamp	Description
Flashes slowly (green)	The battery is charging.
Off	When charging is complete, the charge lamp stops flashing green and turns off. About 3 hours are required to charge a fully exhausted battery.
Flashes quickly (green)	<ul style="list-style-type: none"> The ambient temperature is not suited to charging. Charge the battery indoors with an ambient temperature of 5°C to 35°C (41°F to 95°F). The USB cable or charging AC adapter is not properly connected, or there is a problem with the battery. Disconnect the USB cable or unplug the charging AC adapter and correctly connect it again, or change the battery.

3 Disconnect the charging AC adapter from the electrical outlet and then disconnect the USB cable.



Notes About Charging

Do not, under any circumstances, use another make or model of AC adapter other than Charging AC Adapter EH-71P, and do not use a commercially available USB-AC adapter or a battery charger for a mobile phone. Failure to observe this precaution could result in overheating or in damage to the camera.

Turning On the Camera While the Battery is Charging

The camera does not turn on while the charging AC adapter is connected to it even when you press the power switch. Press and hold the  (playback) button to turn on the camera in playback mode and play back images. Shooting is not possible.

Charging Using a Computer or Battery Charger

- You can also charge the battery by connecting the camera to a computer ( 96, 100).
- You can use the Battery Charger MH-67P (available separately;  82) to charge the battery without using the camera.

Preparation 3 Insert a Memory Card

- 1 Turn off the camera and open the battery-chamber/memory card slot cover.

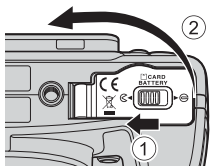

- 2 Insert the memory card.

- Slide the memory card in until it clicks into place.

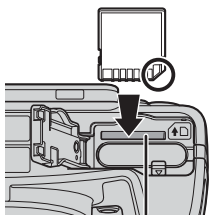

Memory card slot

- Be Careful to Insert the Memory Card in Correct Direction**

Inserting the memory card upside down or backwards could damage the camera and the memory card.



- 3 Close the battery-chamber/memory card slot cover.

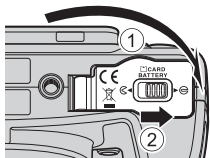

- Formatting Memory Cards**

The first time you insert a memory card that has been used in another device into this camera, make sure to format it with this camera. Insert the card into the camera, press the **MENU** button, and select **Format card** in the setup menu.

Removing Memory Cards

Turn the camera off and make sure that the power-on lamp and the monitor have turned off, and then open the battery-chamber/memory card slot cover.

Gently push the memory card into the camera (①) to partially eject the card (②).

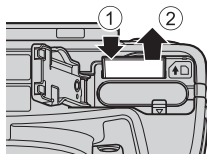

High Temperature Caution

The camera, battery, and memory card may be hot immediately after using the camera.

Internal Memory and Memory Cards

Camera data, including images and movies, can be saved either in the camera's internal memory or on a memory card. To use the camera's internal memory, first remove the memory card.

Approved Memory Cards

The following Secure Digital (SD) memory cards have been tested and approved for use in this camera.

- Memory cards with an SD Speed Class rating of 6 or faster are recommended for recording movies. When using a memory card with a lower Speed Class rating, movie recording may stop unexpectedly.

	SD memory cards	SDHC memory cards ²	SDXC memory cards ³
SanDisk	2 GB ¹	4 GB, 8 GB, 16 GB, 32 GB	64 GB, 128 GB
TOSHIBA	-	4 GB, 8 GB, 16 GB, 32 GB	64 GB
Panasonic	2 GB ¹	4 GB, 8 GB, 16 GB, 32 GB	64 GB
Lexar	-	4 GB, 8 GB, 16 GB, 32 GB	64 GB, 128 GB

¹ If the memory card will be used with a card reader or similar device, make sure that the device supports 2 GB cards.

² SDHC-compliant. If the memory card will be used with a card reader or similar device, make sure that the device supports SDHC.

³ SDXC-compliant. If the memory card will be used with a card reader or similar device, make sure that the device supports SDXC.



- Contact the manufacturer for details on the above cards. We cannot guarantee camera performance when using memory cards made by other manufacturers.

Step 1 Turn the Camera On

1 Open the monitor and remove the lens cap.

- See “Opening and Adjusting the Angle of the Monitor” (📖8) for more information.
- See “Attaching the Camera Strap and Lens Cap” (📖7) for more information.

2 Press the power switch.

- **If you are turning the camera on for the first time, see “Setting the Display Language, Date, and Time” (📖28).**
- The monitor turns on.
- To turn the camera off, press the power switch again.

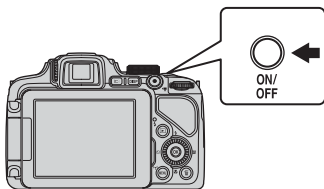

3 Check the battery level indicator and the number of exposures remaining.

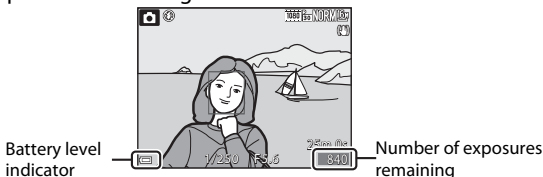

Battery level indicator

Display	Description
	The battery level is high.
	The battery level is low.
Battery exhausted.	The camera cannot capture images. Recharge the battery.



Number of Exposures Remaining

The number of images that can be taken is displayed.

- is displayed when no memory card is inserted in the camera, and images are saved in the internal memory.

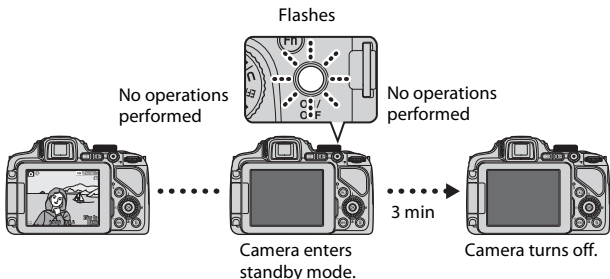
The Auto Off Function



- The time that elapses before the camera enters standby mode is about 1 minute. The time can be changed using the **Auto off** setting in the setup menu ( 95).
- While the camera is in standby mode, the monitor turns back on if you perform any of the following operations:
 - Press the power switch, shutter-release button,  button, or  (movie-record) button.
 - Rotate the mode dial.



Monitor Display

Press the **DISP** button to switch between showing and hiding the photo information or shooting information that is displayed in the monitor ( 10).

Setting the Display Language, Date, and Time

When the camera is turned on for the first time, the language-selection screen and the date and time setting screen for the camera clock are displayed.

- If you exit without setting the date and time,  will flash when the shooting screen is displayed.

- 1** Use the multi selector   to select the desired language and press the  button.

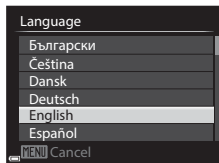

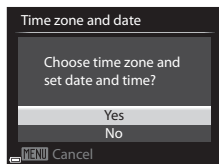

- 2** Select **Yes** and press the  button.

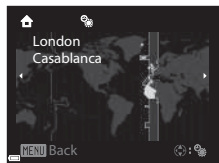

- 3** Select your home time zone and press the  button.



- To enable daylight saving time, press . When the daylight saving time function is enabled,  is displayed above the map.

To turn off the daylight saving time function, press .

- 4** Select the date format and press the  button.

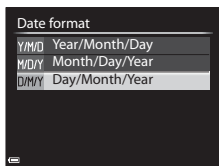

5 Set the date and time, and press the **OK** button.

- Select a field: Press **◀▶** (changes between **D**, **M**, **Y**, **h**, and **m**).
- Edit the date and time: Press **▲▼**.
Date and time can also be changed by rotating the multi selector or command dial.
- Confirm the setting: Select the **m** field and press the **OK** button.

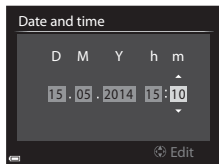

6 Select **Yes** and press the **OK** button.

- When settings are finished, the lens extends and the camera switches to shooting mode.

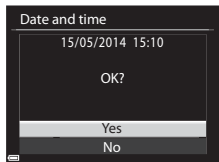

Changing the Language Setting and the Date and Time Setting

- You can change these settings using the **Language** and **Time zone and date** settings in the **Y** setup menu (📖95).
- You can enable or disable daylight saving time in the **Y** setup menu by selecting **Time zone and date** followed by **Time zone**. Enabling day light saving time moves the clock forward one hour, and disabling it moves the clock back one hour.

The Clock Battery

- The camera's clock is powered by a built-in backup battery. The backup battery charges when the main battery is inserted into the camera or when the camera is connected to an optional AC adapter, and it can run the clock for several days after about 10 hours of charging.
- If the camera's backup battery becomes exhausted, the date and time setting screen is displayed when the camera is turned on. Set the date and time again. See step 2 of "Setting the Display Language, Date, and Time" (📖28) for more information.

Imprinting the Shooting Date on Printed Images

- You can permanently imprint the shooting date on images as they are captured by setting **Print date** in the setup menu.
- If you want the shooting date to be printed without using the **Print date** setting, print using the ViewNX 2 software (📖102).

Step 2 Select a Shooting Mode

Rotate the mode dial to select a shooting mode.

-  (auto) mode is used in this example. Rotate the mode dial to .

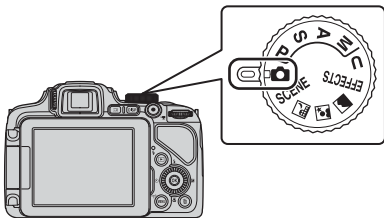

Notes About the Flash

In situations where a flash is needed, such as in dark locations or when the subject is backlit, make sure to raise the flash (60).



Available Shooting Modes

Auto mode (📖39)

Used for general shooting.

SCENE, , , (Scene) modes (📖40)

Camera settings are optimized according to the scene that you select.

- **SCENE**: Press the **MENU** button and select a scene. When using **Scene auto selector**, the camera automatically selects the optimum scene mode when you frame an image, making it even easier to take images using settings that suit the scene.
-  (night landscape): Use this mode to shoot night landscapes.
-  (night portrait): Use this mode to shoot evening and night portraits that include background scenery.
-  (landscape): Use this mode to shoot landscapes.

EFFECTS (Special effects) mode (📖50)

Effects can be applied to images during shooting.

P, S, A, M modes (📖52)

Select these modes for greater control over shutter speed and aperture value.

U (User settings) mode (📖57)

Setting combinations that are frequently used for shooting can be saved. The saved settings can be immediately retrieved for shooting simply by rotating the mode dial to **U**.

Step 3 Frame a Picture

1 Hold the camera steady.

- Keep fingers and other objects away from the lens, flash, AF-assist illuminator, microphone, and speaker.

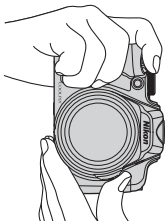

2 Frame the picture.

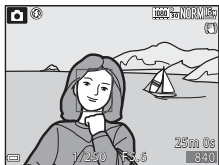

Viewfinder

By pressing the  button, you can shoot while looking through the viewfinder (9).

When Using a Tripod

- We recommend using a tripod to stabilize the camera in the following situations.
 - When shooting in dim lighting with the flash lowered, or in a shooting mode in which the flash is disabled
 - When using the telephoto setting
- When using a tripod to stabilize the camera during shooting, set **Vibration reduction** (95) to **Off** in the setup menu to prevent potential errors caused by this function.

Using the Zoom

When you move the zoom control, the zoom lens position changes.

- To zoom in closer to the subject: Move toward **T** (telephoto)
- To zoom out and view a larger area: Move toward **W** (wide-angle)
- Rotating the zoom control all the way in either direction adjusts the zoom quickly.
- The zoom can also be operated by moving the side zoom control (📖2) toward **T** or **W**.

The function of the side zoom control can be set in the **Assign side zoom control** in the setup menu (📖95).

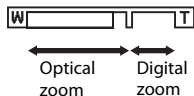
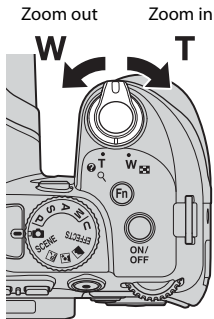

- A zoom indicator is displayed at the top of the monitor when the zoom control is moved.
- Digital zoom, which allows you to further magnify the subject up to approximately 4× the maximum optical zoom ratio, can be activated by moving and holding the zoom control toward **T** when the camera is zoomed in to the maximum optical zoom position.

Notes About Digital Zoom

The zoom indicator turns blue when the digital zoom is activated, and it turns yellow when the zoom magnification is increased further.

- Zoom indicator is blue: Image quality is not noticeably reduced by using the Dynamic Fine Zoom.
- Zoom indicator is yellow: Image quality is noticeably reduced.
- The indicator remains blue across a wider area when the image size is smaller.
- The zoom indicator may not turn blue depending on the continuous shooting setting, etc.

Step 4 Focus and Shoot

1 Press the shutter-release button halfway.

- When the subject is in focus, the focus area that includes the subject or focus indicator (📖 14) glows green (multiple focus areas can glow green).
- When you are using digital zoom, the camera focuses on the subject in the center of the frame and the focus area is not displayed. When the camera has focused, the focus indicator glows green.
- If the focus area or focus indicator flashes red, the camera is unable to focus. Modify the composition and try pressing the shutter-release button halfway again.

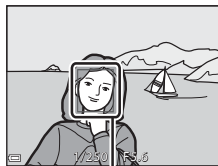
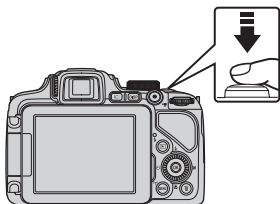



Focus area

2 Without lifting your finger, press the shutter-release button the rest of the way down.



The Shutter-release Button

<p>Press halfway</p>		<p>To set focus and exposure (shutter speed and aperture value), press the shutter-release button lightly until you feel a slight resistance. Focus and exposure remain locked while the shutter-release button is pressed halfway.</p>
<p>Press all the way</p>		<p>Press the shutter-release button all the way to release the shutter and take an image. Do not use force when pressing the shutter-release button, as this may result in camera shake and blurred images. Press the button gently.</p>

Notes About Saving Images and Recording Movies

The indicator showing the number of exposures remaining or the indicator showing the maximum movie length flashes while images are being saved or while a movie is being recorded. **Do not open the battery-chamber/memory card slot cover or remove the battery or memory card** while an indicator is flashing. Doing this could result in loss of data, or in damage to the camera or the memory card.



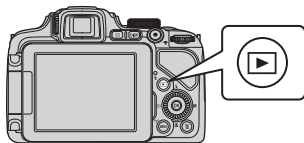

Step 5 Play Back Images

1 Press the (playback) button.

- If you press and hold down the  (playback) button while the camera is turned off, the camera turns on in playback mode.



2 Use the multi selector to select an image to display.

- Press and hold down     to scroll through the images quickly.
- Images can also be selected by rotating the multi selector.
- To return to shooting mode, press the  button or shutter-release button.

Display the previous image

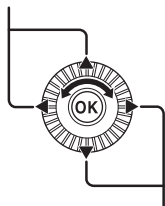

Display the next image



Current image number/
Total number of images



Switching the Monitor Display

Press the **DISP** button to switch between showing and hiding the photo information or shooting information that is displayed in the monitor (10).

Step 6 Delete Images

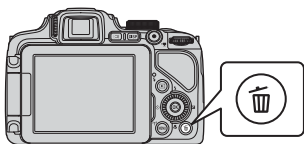
- 1 Press the  button to delete the image currently displayed in the monitor.



- 2 Use the multi selector  to select the desired deletion method and press the  button.

- See "Operating the Erase Selected Images Screen" (p.38) for more information.
- To exit without deleting, press the **MENU** button.

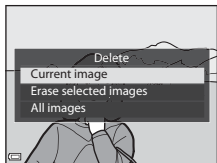

- 3 Select **Yes** and press the  button.

- Deleted images cannot be recovered.
- To cancel, select **No** and press the  button.

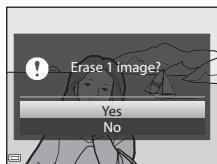

Operating the Erase Selected Images Screen

- 1** Use the multi selector ◀▶ to select an image to be deleted, and then use ▲ to display ✓.

- To undo the selection, press ▼ to remove ✓.
- Move the zoom control (📖33) toward T (Q) to switch to full-frame playback or W (📄) to switch to thumbnail playback.



- 2** Add ✓ to all images that you want to delete and then press the OK button to confirm the selection.

- A confirmation dialog is displayed. Follow the instructions displayed in the monitor.

✓ Deleting Images in a Sequence

- If you press the 🗑️ button and delete a key picture while only key pictures are displayed for sequences of images (📖87), all images in the sequence, including the key picture, are deleted.
- To delete individual images in a sequence, press the OK button to display them one at a time and press the 🗑️ button.

📄 Deleting the Last Image Captured While in Shooting Mode

When using shooting mode, press the 🗑️ button to delete the last image that was saved.

Shooting Features

(Auto) Mode

Used for general shooting.

- The camera detects the main subject and focuses on it. If a human face is detected, the camera automatically sets focus priority on it.
- See "Focusing" (📖80) for more information.

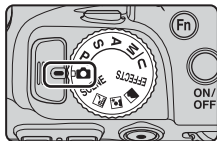

Functions Available in (Auto) Mode

- Flash mode (📖60)
- Self-timer (📖63)
- Smile timer (📖64)
- Focus mode (📖65)
- Exposure compensation (📖69)
- Shooting menu (📖72)

Scene Mode (Shooting Suited to Scenes)

When a scene is selected, camera settings are automatically optimized for the selected scene.

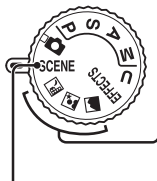

Night landscape (📖41)^{1,2}, Night portrait (📖42), Landscape (📖42)^{1,2}

Rotate the mode dial to , , or and take images.

SCENE (Scene)

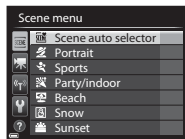
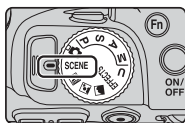

Press the **MENU** button to display the scene menu and select one of the following scenes using the multi selector.

Scene auto selector (default setting) (📖43)	Food (📖45)
Portrait	Museum (📖45) ¹
Sports (📖43) ¹	Fireworks show (📖45) ^{2,3}
Party/indoor (📖44) ¹	Black and white copy (📖45) ¹
Beach ¹	Backlighting (📖46) ¹
Snow ¹	Easy panorama (📖47) ¹
Sunset ^{1,2,3}	Pet portrait (📖48)
Dusk/dawn ^{1,2,3}	Moon (📖49) ^{1,2}
Close-up (📖44)	Bird-watching (📖49) ¹

¹ The camera focuses on the area in the center of the frame. The position of the area cannot be moved.

² The camera focuses at infinity.





³ Use of a tripod is recommended, because the shutter speed is slow. Set **Vibration reduction** (📖95) to **Off** in the setup menu when using a tripod to stabilize the camera during shooting.

To View a Description (Help Display) of Each Scene





Select a scene and move the zoom control (📖1) toward **T** (🔍) to view a description of that scene. To return to the original screen, move the zoom control toward **T** (🔍) again.

Tips and Notes

Night landscape

- Press the **MENU** button to select  **Hand-held** or  **Tripod** in **Night landscape**.
-  **Hand-held** (default setting):
 - Press the shutter-release button all the way to capture a series of images which are combined into a single image and saved.
 - Once the shutter-release button is pressed all the way, hold the camera still until a still image is displayed. After taking an image, do not turn the camera off before the monitor switches to the shooting screen.
 - The angle of view (i.e., the area visible in the frame) seen in the saved image is narrower than that seen in the monitor at the time of shooting.
-  **Tripod**:
 - One image is captured at a slow shutter speed when the shutter-release button is pressed all the way.
 - Vibration reduction is disabled regardless of the **Vibration reduction** (📖95) setting in the setup menu.

 **Night portrait**













- Press the **MENU** button to select  **Hand-held** or  **Tripod** in **Night portrait**.
- One image is captured at a slow shutter speed. Compared to using  **Tripod**, when  **Hand-held** is selected, the camera sets a slightly faster shutter speed in accordance with the shooting conditions to prevent camera shake.
- Vibration reduction is disabled regardless of the **Vibration reduction** ( 95) setting in the setup menu.
- The flash always fires. Raise the flash before shooting.

 **Landscape**

- Press the **MENU** button to select **Noise reduction burst** or **Single shot** in **Landscape**.
- **Noise reduction burst**: This enables you to shoot a sharp landscape with a minimum of noise.
 - Press the shutter-release button all the way to capture a series of images which are combined into a single image and saved.
 - Once the shutter-release button is pressed all the way, hold the camera still until a still image is displayed. After taking an image, do not turn the camera off before the monitor switches to the shooting screen.
 - The angle of view (i.e., the area visible in the frame) seen in the saved image is narrower than that seen in the monitor at the time of shooting.
- **Single shot** (default setting): Saves images with emphasized outlines and contrast.
 - One image is captured when the shutter-release button is pressed all the way.

SCENE → Scene auto selector

- When you point the camera at the subject, the camera automatically selects the optimum scene mode from the list below and adjusts the shooting settings accordingly.

	Portrait (close-up image of one to two persons)
	Portrait (shooting an image of three or more persons or shooting a composition with a large background area)
	Landscape
	Night portrait (close-up image of one to two persons)
	Night portrait (shooting an image of three or more persons or shooting a composition with a large background area)
	Night landscape <ul style="list-style-type: none"> The camera shoots images continuously and combines and saves them as one image in the same way as when Hand-held in  (night landscape) (41) is selected.
	Close-up
	Backlighting (shooting non-human subjects)
	Backlighting (shooting human subjects)
	Other shooting scenes

- Depending upon shooting conditions, the camera may not select the desired scene mode. Should this occur, switch to  (auto) mode (30) or select the optimum scene mode for the subject manually.

SCENE → Sports

- While the shutter-release button is held all the way down, the camera shoots up to about 7 images continuously at a rate of about 7 fps (when image quality is set to **Normal** and image size is set to  **4608x3456**).
- The frame rate for continuous shooting may become slow depending upon the current image quality setting, image size setting, the memory card used, or shooting condition.
- Focus, exposure, and hue are fixed at the values determined with the first image in each series.

SCENE → Party/indoor

- To avoid the effects of camera shake, hold the camera steady. Set **Vibration reduction** (📖95) to **Off** in the setup menu when using a tripod to stabilize the camera during shooting.

SCENE → Close-up

From the screen displayed after **Close-up** is selected, select **Noise reduction burst** or **Single shot**.

- **Noise reduction burst:** This enables you to shoot a sharp image with a minimum of noise.
 - Press the shutter-release button all the way to capture a series of images which are combined into a single image and saved.
 - Once the shutter-release button is pressed all the way, hold the camera still until a still image is displayed. After taking an image, do not turn the camera off before the monitor switches to the shooting screen.
 - If the subject moves or there is a significant camera shake during continuous shooting, the image may be distorted, overlapped, or blurred.
 - The angle of view (i.e., the area visible in the frame) seen in the saved image is narrower than that seen in the monitor at the time of shooting.
- **Single shot** (default setting): Saves images with emphasized outlines and contrast.
 - One image is captured when the shutter-release button is pressed all the way.
- The focus mode (📖65) setting is changed to **Close-up** (macro close-up) and the camera automatically zooms to the closest position at which it can focus.
- You can move the focus area. Press the **OK** button, use the multi selector **▲▼◀▶** or rotate it to move the focus area, and press the **OK** button to apply the setting.

SCENE → 🍴 Food

- The focus mode (📖65) setting is changed to 🍷 (macro close-up) and the camera automatically zooms to the closest position at which it can focus.
- You can adjust hue by using the command dial. The hue setting is saved in the camera's memory even after the camera is turned off.
- You can move the focus area. Press the Ⓞ button, use the multi selector ▲▼◀▶ or rotate it to move the focus area, and press the Ⓞ button to apply the setting.



SCENE → 🏛️ Museum

- The camera captures a series of up to 10 images while the shutter-release button is held all the way down, and the sharpest image in the series is automatically selected and saved (BSS (Best Shot Selector)).
- The flash does not fire.

SCENE → 🎆 Fireworks show

- The shutter speed is fixed at about 4 seconds.
- The telephoto zoom position is restricted to the angle of view equivalent to that of approx. 500 mm lens (in 35mm [135] format).



SCENE → 🖼️ Black and white copy

- Use together with 🍷 (macro close-up) focus mode (📖65) when shooting subjects that are close to the camera.



SCENE → Backlighting

- From the screen displayed after  **Backlighting** is selected, HDR (high dynamic range) composition can be set.
- **Off** (default setting): The flash fires to prevent the subject from being hidden in shadow. Shoot images with the flash raised.
- **Level 1-Level 3**: Use when taking images with very bright and dark areas in the same frame. Select **Level 1** when there is less difference between bright and dark areas, and **Level 3** when there is more difference between bright and dark areas.

Notes About HDR

- Use of a tripod is recommended. Set **Vibration reduction** (95) in the setup menu to **Off** when using a tripod to stabilize the camera.
- The angle of view (i.e., the area visible in the frame) seen in the saved image is narrower than that seen in the monitor at the time of shooting.
- When the shutter-release button is pressed all the way, the camera shoots images continuously and saves the following two images.
 - A non-HDR composite image
 - An HDR composite image in which the loss of details in highlights or shadows is minimized
- If there is only enough memory to save one image, an image processed by D-Lighting (86) at the time of shooting, in which dark areas of the image are corrected, is the only image saved.
- Once the shutter-release button is pressed all the way, hold the camera still until a still image is displayed. After taking an image, do not turn the camera off before the monitor switches to the shooting screen.
- Depending on the shooting conditions, dark shadows may appear around bright subjects and bright areas may appear around dark subjects. You can compensate by lowering the level setting.

SCENE → Easy panorama

- From the screen displayed after  **Easy panorama** is selected, select the shooting range from **Normal (180°)** (default setting) or **Wide (360°)**.
 - The zoom position is fixed at wide-angle.
 - Press the shutter-release button all the way down, remove your finger from the button, and then slowly pan the camera horizontally. Shooting ends when the camera captures the specified shooting range.
 - Focus and exposure are locked when shooting starts.
 - If you press the  button when a captured image is displayed in full-frame playback mode, the image scrolls automatically.
 - The images cannot be edited on this camera.
- See "Using Easy Panorama (Shooting and Playback)" (2) for more information.

Notes About Printing Panorama Images

The entire image may not be able to be printed depending on the printer's settings. Additionally, printing may not be possible depending on the printer.

SCENE → 🐾 Pet portrait

- When you point the camera at a dog or cat, the camera detects the pet's face and focuses on it. By default, the shutter is automatically released when a dog or cat face is detected (pet portrait auto release).
- From the screen displayed after 🐾 **Pet portrait** is selected, select **Single** or **Continuous**.
 - **Single**: Whenever a dog or cat face is detected, the camera captures 1 image.
 - **Continuous**: Whenever a dog or cat face is detected, the camera captures 3 images continuously.

✔ **Pet Portrait Auto Release**

- Press the multi selector ◀ (🔍) to change the **Pet portrait auto release** settings.
 - : The camera automatically releases the shutter when it detects a dog or cat face.
 - **Off**: The camera does not release the shutter automatically, even if a dog or cat face is detected. Press the shutter-release button. The camera also detects human faces when **Off** is selected.
- **Pet portrait auto release** is set to **Off** after 5 bursts have been taken.
- Shooting is also possible by pressing the shutter-release button, regardless of the **Pet portrait auto release** setting. When **Continuous** is selected, you can take images continuously while holding down the shutter-release button all the way.

✔ **Focus Area**

- When the camera detects a face, the face is displayed inside a yellow border. When the camera acquires focus on a face displayed inside a double border (focus area), the double border turns green. If no faces are detected, the camera focuses on the area in the center of the frame.
- In some shooting conditions, the pet face may not be detected and other subjects may be displayed inside a border.

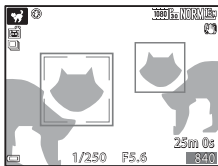

SCENE → 🌕 Moon

- You can adjust hue by using the command dial. The hue setting is saved in the camera's memory even after the camera is turned off.
- Adjust the brightness with exposure compensation (📖69) according to shooting conditions such as the waxing and waning of the moon and shooting requirements.
- At the wide-angle zoom position, the framing border is displayed to indicate the angle of view equivalent to that of 1440 mm lens (in 35mm [135] format). The angle of view becomes equivalent to that of 1440 mm lens by pressing the **OK** button.

SCENE → 🐦 Bird-watching

- From the screen displayed after **Bird-watching** is selected, select **Single** or **Continuous**.
- **Single** (default setting): One image is shot each time the shutter-release button is pressed.
- **Continuous**: While the shutter-release button is held all the way down, images are captured continuously.
 - The frame rate for continuous shooting is about 7 fps and the maximum number of continuous shots is about 7 (when image quality is set to **Normal** and image size is set to **16M 4608x3456**).
- At the wide-angle zoom position, the framing border is displayed to indicate the angle of view equivalent to that of 800 mm lens (in 35mm [135] format). The angle of view becomes equivalent to that of 800 mm lens by pressing the **OK** button.

Special Effects Mode (Applying Effects When Shooting)

Effects can be applied to images during shooting.

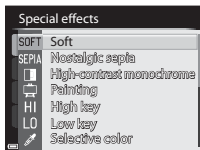
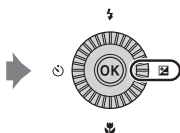
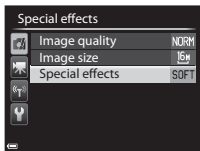

Press the **MENU** button to display the special effects menu and select an effect using the multi selector.

- The camera focuses on the area in the center of the frame. The position of the area cannot be moved.

Option	Description
Soft (default setting)*	Softens the image by adding a slight blur to the entire image.
Nostalgic sepia*	Adds a sepia tone and reduces the contrast to simulate the qualities of an old photograph.
High-contrast monochrome	Creates a black-and-white photograph with a clear contrast.
Painting*	Gives the image a painting-like appearance.
High key	Gives the entire image a bright tone.
Low key	Gives the entire image a dark tone.

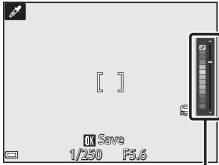
Option	Description
Selective color	<p>Keeps only a selected color and makes other colors black-and-white.</p> <ul style="list-style-type: none"> • Rotate the command dial to select a color that you want to retain from the slider. • Press the OK button to hide the slider and end color selection. To display the slider again, press the OK button again.  <p style="text-align: right;">Slider</p>
High ISO monochrome	<p>Creates monotone (black-and-white) images by intentionally taking images with high ISO sensitivity. This setting is effective when shooting subjects in low lighting conditions.</p> <ul style="list-style-type: none"> • The images taken may contain noise (randomly-spaced bright pixels, spots or lines).
Cross process	<p>Creates images with an unusual hue by converting a positive color image into negative or negative color image into positive.</p> <ul style="list-style-type: none"> • Rotate the command dial to select hue.

* Some effects cannot be selected depending on the setting of **Movie options** (📖93).

Functions Available in Special Effects Mode

- Flash mode (📖60)
- Self-timer (📖63)
- Focus mode (📖65)
- Exposure compensation (📖69)
- Shooting menu (📖72)

P, S, A, M Modes (Setting the Exposure for Shooting)

Images can be shot with greater control by setting the shooting menu (📖72) items in addition to setting the shutter speed or aperture value manually according to shooting conditions and requirements.

- The focus area for autofocus differs depending on the setting of **AF area mode** (📖73).
- When **AF area mode** is set to **Target finding AF** (default setting), the camera detects the main subject and focuses on it.

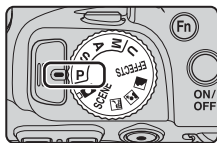

Rotate the command dial or multi selector to set the shutter speed and aperture value.

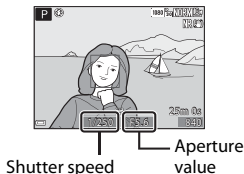
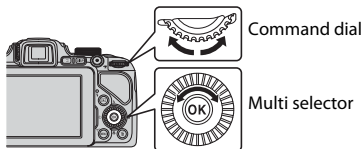

Exposure mode	Shutter speed (📖56)	Aperture value (📖53)
P Programmed auto (📖54)	Automatically adjusted (flexible program is enabled by the command dial).	
S Shutter-priority auto (📖54)	Adjusted by the command dial.	Automatically adjusted.
A Aperture-priority auto (📖54)	Automatically adjusted.	Adjusted by the multi selector.
M Manual (📖54)	Adjusted by the command dial.	Adjusted by the multi selector.



More Information

See "Toggle Av/Tv selection" (📖96) for more information.

Exposure

The procedure for shooting images at the desired brightness (exposure) by adjusting the shutter speed or aperture value is called “determine exposure.” The sense of dynamism and amount of background defocus in images to be shot vary depending on the combinations of shutter speed and aperture value even if the exposure is the same.

Adjusting the Shutter Speed

In **S** mode, the range is from a maximum of 1/4000 to 8 seconds.

In **M** mode, the range is from a maximum of 1/4000 to 15 seconds.

See “The Control Range of the Shutter Speed” (p.56) for more information.



Faster 1/1000 s



Slower 1/30 s

Adjusting the Aperture Value

In **A** and **M** modes, the range is from f/3.3 to 7.6 (wide-angle position) and from f/6.5 to 8.2 (telephoto zoom position).



Larger aperture (Small f-number)
f/3.3



Smaller aperture (Large f-number)
f/7.6

Aperture Value (F-number) and Zoom

Large apertures (expressed by small f-numbers) let more light into the camera, and small apertures (large f-numbers) let less light.

The aperture value of the zoom lens of this camera changes depending on the zoom position. When zooming to the wide-angle position and telephoto zoom position, the aperture values are f/3.3 and f/6.5, respectively.

P (Programmed auto)

Use for automatic control of the exposure by the camera.

- Different combinations of shutter speed and aperture value can be selected without changing the exposure by rotating the command dial ("flexible program"). While flexible program is in effect, a flexible program mark (**⌘**) is displayed next to the mode indicator (**P**) in the upper left of the monitor.
- To cancel flexible program, rotate the command dial until the flexible program mark (**⌘**) is no longer displayed. Selecting another shooting mode, or turning off the camera, also cancels flexible program.

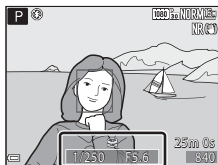

S (Shutter-priority auto)

Use to shoot fast-moving subjects at a fast shutter speed, or use to emphasize the movements of a moving subject at a slow shutter speed.

- The shutter speed can be adjusted by rotating the command dial.

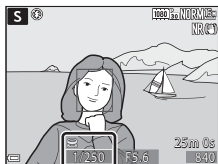

A (Aperture-priority auto)

Use to bring subjects including both the foreground and background into focus or blur the subject's background intentionally.

- The aperture value can be adjusted by rotating the multi selector.

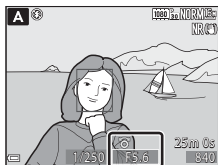

M (Manual)

Use to control the exposure according to shooting requirements.

- When adjusting the aperture value or shutter speed, the degree of deviation from the exposure value measured by the camera is displayed in the exposure indicator of the monitor. The degree of deviation in the exposure indicator is displayed in EVs (-2 to +2 EV in increments of 1/3 EV).
- The shutter speed can be adjusted by rotating the command dial and the aperture value can be adjusted by rotating the multi selector.

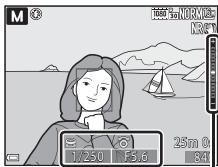

Exposure indicator

✓ Notes About Shooting

- When zooming is performed after the exposure is set, exposure combinations or aperture value may be changed.
- When the subject is too dark or too bright, it may not be possible to obtain the appropriate exposure. In such cases, the shutter speed indicator or aperture value indicator flashes when the shutter-release button is pressed halfway (except when the **M** mode is used). Change the shutter speed setting or aperture value.

✓ Notes About ISO Sensitivity



When **ISO sensitivity** (📖73) is set to **Auto** (default setting) or **Fixed range auto**, the ISO sensitivity in **M** mode is fixed at ISO 100.

Functions Available in P, S, A, M Modes

- Flash mode (📖60)
- Self-timer (📖63)
- Smile timer (📖64)
- Focus mode (📖65)
- Exposure compensation (📖69)
- Shooting menu (📖72)
- Functions That Can Be Set Using the **Fn** (Function) Button (📖75)
- Setup menu (📖95)

The Control Range of the Shutter Speed

The control range of the shutter speed differs depending on the zoom position, aperture, or ISO sensitivity setting. Additionally, the control range changes in the following continuous shooting settings.

Setting		Control range
ISO sensitivity ( 73) ¹	Auto ² , Fixed range auto ²	1/4000 ³ - 1 s (P, S, A modes) 1/4000 ³ - 15 s (M mode)
	ISO 100	1/4000 ³ - 8 s (P, S, A modes) 1/4000 ³ - 15 s (M mode)
	ISO 200	1/4000 ³ - 4 s (P, S, A modes) 1/4000 ³ - 8 s (M mode)
	ISO 400	1/4000 ³ - 4 s
	ISO 800	1/4000 ³ - 2 s
	ISO 1600	1/4000 ³ - 1 s
	ISO 3200, 6400	1/4000 ³ - 1/2 s
Continuous ( 73)	Continuous H, Continuous L, BSS	1/4000 ³ - 1/30 s
	Pre-shooting cache, Multi-shot 16	1/4000 - 1/30 s
	Continuous H: 120 fps	1/4000 - 1/125 s
	Continuous H: 60 fps	1/4000 - 1/60 s
	Intvl timer shooting	Same as when Single is set

¹ The ISO sensitivity setting is restricted depending on the continuous shooting setting (76).

² In **M** mode, the ISO sensitivity is fixed at ISO 100.

³ The maximum shutter speed value is 1/4000 second when the aperture value is set to f/7.6 at the maximum wide-angle position. The shutter speed becomes slower when the zoom position moves to the telephoto zoom position and the aperture is larger. The shutter speed is 1/2500 second when the aperture value is set to maximum f/8.2 at the maximum telephoto zoom position.

U (User Settings) Mode

Setting combinations that are frequently used for shooting (User settings) can be saved in **U**. Shooting is possible in **P** (programmed auto), **S** (shutter-priority auto), **A** (aperture-priority auto) or **M** (manual).

Rotate the mode dial to **U** to retrieve the settings saved in **Save user settings**.

- Frame the subject and shoot with these settings, or change the settings as required.
- The setting combinations that are retrieved when the mode dial is rotated to **U** can be changed as many times as you want in **Save user settings**.

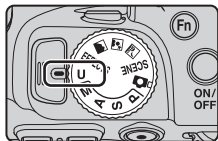

The following settings can be saved.

General Settings

- Shooting modes **P, S, A, M** (📖52)
- Zoom position (📖33)
- Flash mode (📖60)
- Self-timer (📖63)
- Focus mode (📖65)
- Exposure compensation (📖69)
- Fn button (📖75)

Shooting menu

- Image quality (📖72)
- Image size (📖72)
- Picture Control (📖72)
- Custom Picture Control (📖72)
- White balance (📖72)
- Metering (📖73)
- Continuous (📖73)
- ISO sensitivity (📖73)
- Exposure bracketing (📖73)
- AF area mode (📖73)
- Autofocus mode (📖73)
- Flash exp. comp. (📖73)
- Noise reduction filter (📖73)
- Active D-Lighting (📖73)
- Multiple exposure (📖73)
- Zoom memory (📖74)
- Startup zoom position (📖74)
- M exposure preview (📖74)

Saving Settings in U Mode (Save User Settings)

The frequently used settings for shooting can be changed and saved in **U**.

1 Rotate the mode dial to the original shooting mode.

- Rotate the mode dial to **P**, **S**, **A** or **M** (📖52). The flexible program (when set to **P**), shutter speed (when set to **S** or **M**) or aperture value (when set to **A** or **M**) will also be saved.
- Settings can also be saved by rotating the mode dial to **U** (the default settings for the shooting mode **P** are saved at the time of purchase).

2 Change to a frequently used combination of shooting settings.

- See 📖57 for settings details.

3 Press the MENU button to display the shooting menu.

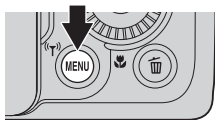

4 Use the multi selector ▲▼ to select **Save user settings**, and press the **OK** button.

- The current settings are saved.

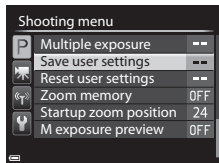

✓ The Clock Battery

If the internal clock battery (📖29) is exhausted, the settings saved in **U** will be reset. Writing down any important setting is recommended.

📎 Resetting U (User Settings) Mode

If **Reset user settings** is selected in the shooting menu, the settings that are saved in the user settings are restored to their default values. The shooting mode is set to **P**.

Functions That Can Be Set Using the Multi Selector

The functions that are available vary with the shooting mode, as shown below.

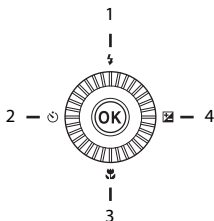

Function		SCENE, 	EFFECTS	P, S, A, M, U
1 Flash mode (📖60)	✓	1	1	✓
2 Self-timer (📖63)	✓		✓	✓
Smile timer (📖64)	✓		-	✓
3 Focus mode (📖65)	✓		✓	✓
4 Exposure compensation (📖69)	✓		✓	✓ ²

¹ Availability depends on the setting. See "Default Settings" (📖70) for more information.

² When the shooting mode is **M**, exposure compensation cannot be used.

Using the Flash

You can shoot images with a flash by raising the built-in flash. You can set the flash mode to match the shooting conditions.

1 Press the (flash pop-up) button to raise the flash.

- When the flash is lowered, flash operation is disabled and  is displayed.

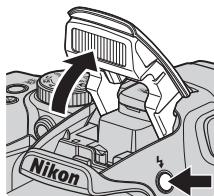

2 Press the multi selector (.

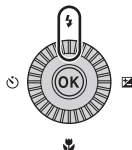

3 Select the desired flash mode (61) and press the button.

- If a setting is not applied by pressing the  button within a few seconds, the selection will be canceled.

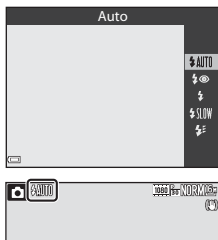

✓ The Flash Lamp

The status of the flash can be confirmed by pressing the shutter-release button halfway.

- On: The flash fires when you press the shutter-release button all the way down.
- Flashing: The flash is charging. The camera cannot shoot images.
- Off: The flash does not fire when an image is taken.

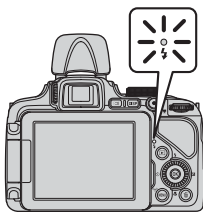

Available Flash Modes

⚡AUTO Auto

The flash fires when necessary, such as in dim lighting.

- The flash mode indicator is only displayed immediately after setting in the shooting screen.

👁️ Auto with red-eye reduction/Red-eye reduction

Reduce red-eye in portraits caused by the flash (📖62).

- When **Red-eye reduction** is selected, the flash fires whenever an image is taken.

⚡ Fill flash/Standard flash

The flash fires whenever an image is taken.

⚡SLOW Slow sync



























Suited to evening and night portraits that include background scenery. Fill flash fires to illuminate the main subject; slow shutter speeds are used to capture background at night or under dim lighting.

⚡R Rear-curtain sync



Fill flash fires just before the shutter closes, creating the effect of a stream of light behind moving subjects.

The Flash Mode Setting

- The available flash modes differ depending on the shooting mode.

Flash mode		SCENE 	EFFECTS	P	S	A	M
 AUTO Auto				-	-	-	-
 Auto with red-eye reduction				-	-	-	-
Red-eye reduction	-	*	*				
 Fill flash				-	-	-	-
Standard flash	-						
 Slow sync					-		-
 Rear-curtain sync							

* Availability depends on the setting. See "Default Settings" (70) for more information.

- The setting applied in the following situations is saved in the camera's memory even after the camera is turned off.
 - When shooting mode **P**, **S**, **A** or **M** is used
 - When  (auto with red-eye reduction) is selected in  (auto) mode

Lowering the Flash

When not using the flash, gently push to lower the flash until it clicks shut.

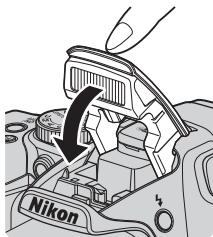

Auto with Red-eye Reduction/Red-eye Reduction

If the camera detects red-eye while saving an image, the affected area is processed to reduce red-eye before the image is saved.

Note the following when shooting:

- More time than usual is required to save images.
- Red-eye reduction may not produce the desired results in all situations.
- In some cases, red-eye reduction may be applied to areas of an image unnecessarily. In these cases, select another flash mode and take the image again.

Using the Self-timer

The camera is equipped with a self-timer that releases the shutter about 10 seconds or 2 seconds after you press the shutter-release button. Set **Vibration reduction** (📖95) to **Off** in the setup menu when using a tripod to stabilize the camera during shooting.

- 1** Press the multi selector ◀ (📷).

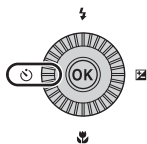

- 2** Select 📷10s (or 📷2s), and press the OK button.

- 📷10s (10 seconds): Use on important occasions, such as weddings.
- 📷2s (2 seconds): Use to prevent camera shake.
- If a setting is not applied by pressing the OK button within a few seconds, the selection will be canceled.
- When the shooting mode is **Pet portrait** scene mode, 📷 (pet portrait auto release) is displayed (📖48). The self-timer cannot be used.

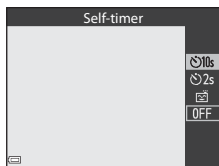

- 3** Frame the picture and press the shutter-release button halfway.

- Focus and exposure are set.

- 4** Press the shutter-release button the rest of the way down.

- Countdown starts. The self-timer lamp flashes and then glows steadily about one second before the shutter is released.
- When the shutter is released, the self-timer is set to **OFF**.
- To stop the countdown, press the shutter-release button again.

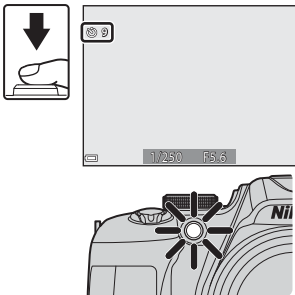

Shooting Smiling Faces Automatically (Smile Timer)

When the camera detects a smiling face, you can take an image automatically without pressing the shutter-release button.

- This function can be used when the shooting mode is (auto), **P**, **S**, **A**, **M** or **U**, or **Portrait** or **Night portrait** scene mode.

1 Press the multi selector (☺).

- Change any flash mode, exposure, or shooting menu settings before pressing .

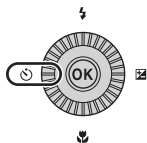

2 Select (smile timer), and press the button.

- If a setting is not applied by pressing the button within a few seconds, the selection will be canceled.

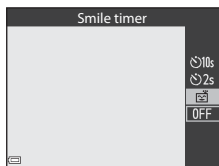

3 Frame the picture and wait for the subject to smile without pressing the shutter-release button.

- Point the camera at a human face.
- If the camera detects that the face framed by the double border is smiling, the shutter is automatically released.
- Whenever the camera detects a smiling face, it automatically releases the shutter.

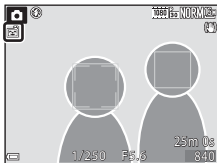

4 End automatic shooting.

- To end automatic shooting with smile timer, return to step 1 and select **OFF**.

Notes About Smile Timer

Under some shooting conditions, the camera may be unable to detect faces or detect smiles (81). The shutter-release button can also be used for shooting.

When the Self-timer Lamp Flashes

When using smile timer, the self-timer lamp flashes when the camera detects a face and flashes quickly immediately after the shutter is released.

Using Focus Mode

Set the focus mode according to the distance to the subject.

- 1 Press the multi selector ▼ (🌸).

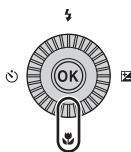

- 2 Select the desired focus mode and press the OK button.

- If a setting is not applied by pressing the OK button within a few seconds, the selection will be canceled.

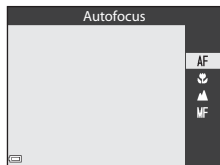

Available Focus Modes

AF

Autofocus



The camera automatically adjusts the focus according to the distance to the subject. Use when the distance from the subject to the lens is 50 cm (1 ft 8 in.) or more, or 2.0 m (6 ft 7 in.) or more at the maximum telephoto zoom position.

- The focus mode icon on the shooting screen is displayed only immediately after the setting is made.



Macro close-up

Set when taking close-up images.

When the zoom ratio is set to a position where  and the zoom indicator glow green, the camera can focus on subjects as close as approximately 10 cm (4 in.) from the lens. When the zoom is at the position where  is displayed, the camera can focus on subjects as close as approximately 1 cm (0.4 in.) from the lens.



Infinity

Use when shooting distant scenes through window glass or when shooting landscapes.

The camera automatically adjusts the focus near infinity.

- The camera may not be able to focus on nearby objects.
- The flash mode is set to  (off).

MF

Manual focus

The focus can be adjusted on any subject at a distance from approximately 1 cm (0.4 in.) to infinity from the lens (67). The closest distance at which the camera can focus varies depending on the zoom position.



Notes About Shooting with the Flash

The flash may be unable to light the entire subject at distances of less than 50 cm (1 ft 8 in.).



Focus Mode Setting

- The setting may not be available with some shooting modes.
- For shooting modes **P**, **S**, **A** and **M**, the setting is saved in the camera's memory even after the camera is turned off.



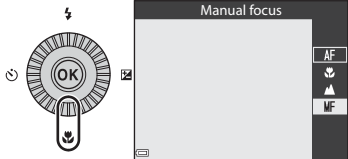

Taking Images with Manual Focus

Available when the shooting mode is **P**, **S**, **A**, **M** or **U**, special effects mode, or **Sports** or **Bird-watching** scene mode.

- 1 Press the multi selector , select **MF** (manual focus), and then press the **OK** button.



- 2 Use the multi selector to adjust the focus while checking the enlarged view.

- An enlarged view of the center area of the image is displayed. Press  to switch the view between 2x and 4x.
- Rotate the multi selector clockwise to focus on near subjects, or counterclockwise to focus on far subjects. The focus can be adjusted in higher detail by rotating the multi selector slowly or rotating the command dial.
- When  is pressed, the camera focuses on the subject in the center of the frame with autofocus. First the camera focuses with autofocus, and then the manual focus can be operated.
- Focusing is assisted by highlighting areas that are in focus in white (peaking) (68). Press   to adjust the peaking level.
- Press the shutter-release button halfway to frame the picture. Press the shutter-release button all the way to take the image.

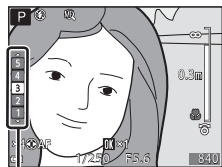

Peaking level

- 3 Press the **OK** button.

- The set focus is locked.
- Press the shutter-release button all the way to take the image.
- To readjust the focus, press the **OK** button to display the screen in step 2.

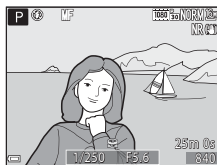

MF (Manual Focus)

- The digits displayed for the gauge on the right of the monitor in step 2 serve as a guideline for the distance to a subject that is in focus when the gauge is near the center.
- The actual range at which the subject can be in focus varies depending on the aperture value and zoom position. To see whether the subject is in focus, check the image after shooting.
- Set **Assign side zoom control** (95) in the setup menu to **Manual focus** to focus by using the side zoom control instead of the multi selector in step 2.

Notes About Peaking

- The range of the contrast level considered to be in focus can be changed by adjusting the peaking level. It is effective to set the level low for high contrast subjects, and high for low contrast subjects.
- Peaking highlights high contrast areas of the image in white. Depending on the shooting conditions, highlighting may not work properly or areas that are not in focus may be highlighted.
- You can disable the peaking display using **Peaking** in the setup menu (96).

Adjusting Brightness (Exposure Compensation)

You can adjust overall image brightness.

- 1 Press the multi selector ► (⊞).

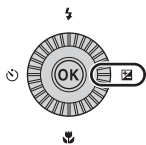

- 2 Select a compensation value and press the **OK** button.

- To brighten the image, set a positive (+) value.
- To darken the image, set a negative (-) value.
- The compensation value is applied, even without pressing the **OK** button.

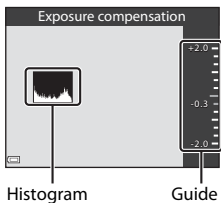

Exposure Compensation Value

- The value applied in **P**, **S** or **A** mode is saved in the camera's memory even after the camera is turned off.
- When the shooting mode is **Fireworks show** scene mode (📖45) or **M** (manual) (📖54), exposure compensation cannot be used.
- When the exposure compensation is set while using a flash, the compensation is applied to both the background exposure and to the flash output.

































Using the Histogram















A histogram is a graph showing the distribution of tones in the image. Use as a guide when using exposure compensation and shooting without the flash.

- The horizontal axis corresponds to pixel brightness, with dark tones to the left and bright tones to the right. The vertical axis shows the number of pixels.
- Increasing exposure compensation value shifts tone distribution to the right, and decreasing it shifts tone distribution to the left.

Default Settings

The default settings for each shooting mode are described below.

Shooting mode	Flash mode ()60)	Self-timer ()63)	Focus mode ()65)	Exposure compensation ()69)
 (auto)	 AUTO	OFF ¹	AF ²	0.0
EFFECTS (special effects)	 ³	OFF	AF	0.0
P, S, A, M		OFF ¹	AF	0.0
U (user settings)		OFF ¹	AF	0.0
Scene				
 (night landscape)	 ⁴	OFF	 ⁴	0.0
 (night portrait)	  ⁵	OFF ¹	AF ⁴	0.0
 (landscape)	 ⁴	OFF	 ⁴	0.0
 (scene auto selector)	 AUTO ⁶	OFF	AF ⁴	0.0
 (portrait)	 	OFF ¹	AF ⁴	0.0
 (sports)	 ⁴	OFF ⁴	AF ⁷	0.0
 (party/indoor)	  ⁸	OFF	AF ⁴	0.0
 (beach)	 AUTO	OFF	AF ⁹	0.0
 (snow)	 AUTO	OFF	AF ⁹	0.0
 (sunset)	 ⁴	OFF	 ⁴	0.0
 (dusk/dawn)	 ⁴	OFF	 ⁴	0.0
 (close-up)	 ¹⁰	OFF	 ⁴	0.0
 (food)	 ⁴	OFF	 ⁴	0.0
 (museum)	 ⁴	OFF	AF ⁹	0.0
 (fireworks show)	 ⁴	OFF ⁴	 ⁴	0.0 ⁴
 (black and white copy)		OFF	AF ⁹	0.0
 (backlighting)	  ¹¹	OFF	AF ⁴	0.0

Shooting mode	Flash mode ( 60)	Self-timer ( 63)	Focus mode ( 65)	Exposure compensation ( 69)
 (easy panorama)	 ⁴	OFF ⁴	AF ⁴	0.0
 (pet portrait)	 ⁴	 ¹²	AF ⁹	0.0
 (moon)	 ⁴	 2s	 ⁴	0.0
 (bird-watching)	 ⁴	OFF	AF ¹³	0.0

¹ Smile timer can also be selected.

² MF (manual focus) cannot be selected.

³ The flash is fixed at  (off) when High ISO monochrome is selected.

⁴ The setting cannot be changed.

⁵ The setting cannot be changed. The flash mode setting is fixed at fill flash with slow sync and red-eye reduction.



⁶ The setting cannot be changed. The camera automatically selects the flash mode appropriate for the scene it has selected.

⁷ AF (autofocus) or MF (manual focus) can be selected.

⁸ May switch to slow sync with red-eye reduction flash mode.

⁹ AF (autofocus) or  (macro close-up) can be selected.

¹⁰ The flash is fixed at  (off) when using **Noise reduction burst**.

¹¹ When **HDR** is set to **Off**, the flash mode is fixed at  (fill flash). When **HDR** is set to any setting other than **Off**, the flash mode is fixed at  (off).

¹² Pet portrait auto release (48) can be set to on or off. Self-timer cannot be used.

¹³  (macro close-up) cannot be selected.

Functions That Can Be Set with the MENU Button (Shooting Menu)

The settings listed below can be changed by pressing the **MENU** button during shooting.

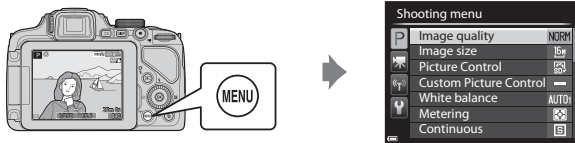

















Common Options

Option	Description	
Image quality	Allows you to set the image quality (compression ratio) of images to be saved. • Default setting: Normal	21
Image size	Allows you to set the image size of images to be saved. • Default setting: 4608x3456	22

For P, S, A, M, U modes

Option	Description	
Picture Control (COOLPIX Picture Control)	Allows you to change the settings for image recording according to the shooting scene or your preferences. • Default setting: Standard	23
Custom Picture Control (COOLPIX Custom Picture Control)	Allows you to customize the settings of COOLPIX Picture Control and register them in Custom 1 or Custom 2 of Picture Control .	27
White balance	Allows you to adjust white balance to suit the weather conditions or light source in order to make the colors in images match what you see with your eyes. • Default setting: Auto (normal)	28

Option	Description	
Metering	Allows you to set the method that the camera uses to measure the brightness of the subject. • Default setting: Matrix	 31
Continuous	Allows you to select single or continuous shooting. • Default setting: Single	 32
ISO sensitivity	Allows you to control the camera's sensitivity to light. • Default setting: Auto When Auto is selected, ISO is displayed in the monitor while shooting if ISO sensitivity increases. • In M (manual) mode, when set to Auto or Fixed range auto , the ISO sensitivity is fixed at ISO 100.	 36
Exposure bracketing	The exposure (brightness) can be changed automatically during continuous shooting. • Default setting: Off	 37
AF area mode	Allows you to change the method of how the camera selects the focus area for autofocus. • Default setting: Target finding AF	 38
Autofocus mode	Allows you to select either Single AF , which focuses only when the shutter-release button is pressed halfway, or Full-time AF , which continues focusing even when the shutter-release button is not pressed halfway. • Default setting: Single AF	 41
Flash exp. comp.	Allows you to adjust the flash output. • Default setting: 0.0	 41
Noise reduction filter	Allows you to set the strength of the noise reduction function that is normally performed when saving images. • Default setting: Normal	 42
Active D-Lighting	Allows you to prevent loss of contrast details in highlights and shadows and well reproduce the natural contrast that is seen with the naked eye when shooting images. • Default setting: Off	 42
Multiple exposure	Allows you to combine two to three images and save them as a single image. • Default setting: - Multiple exposure mode: Off - Auto gain: On	 43
Save user settings	Allows you to save the current settings in mode dial U ( 57).	58

Option	Description	
Reset user settings	Allows you to reset the settings saved to mode dial U .	58
Zoom memory	When the zoom control is moved, the zoom position (equivalent to focal length/angle of view in 35mm [135] format) is switched to the positions that have been selected by setting the check box to on in this menu option. • Default setting: Off	 45
Startup zoom position	Allows you to set the zoom position (equivalent to focal length/angle of view in 35mm [135] format) for when the camera is turned on. • Default setting: 24 mm	 46
M exposure preview	Allows you to set whether or not to reflect the brightness to the shooting screen when the exposure is changed in M (manual) mode. • Default setting: Off	 46

Functions That Can Be Set with the Fn (Function) Button

The following functions can be also set by pressing the **Fn** (function) button instead of displaying the corresponding menu by pressing the **MENU** button.

- This function can be used when the shooting mode is **P**, **S**, **A**, **M** or **U**.

Image quality (📖72)	Continuous (📖73)
Image size (📖72)	ISO sensitivity (📖73)
Picture Control (📖72)	AF area mode (📖73)
White balance (📖72)	Vibration reduction (📖95)
Metering (📖73)	

1 Press the **Fn** (function) button when the shooting screen is displayed.

- The **Fn** button function menu or the setting items of the function (default setting is **Continuous**) that was last assigned to the **Fn** (function) button can be selected.

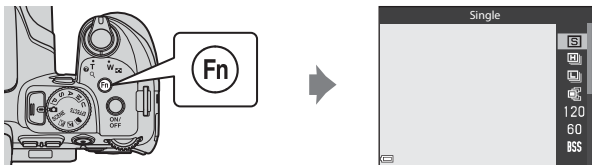

2 Use the multi selector to select a menu item.

- To assign another function, select the **Fn** button function menu and press the **OK** button. Then, select the desired function from the displayed menu.



3 After you finish assigning the function, press the **OK** button or **Fn** (function) button.

- The camera returns to the shooting screen.











Functions That Cannot Be Used Simultaneously

Some functions cannot be used with other menu settings.

Restricted function	Setting	Description
Flash mode	Focus mode (📖65)	When ▲ (infinity) is selected, the flash is not available.
	Continuous (📖73)	The flash is not available (except for interval timer shooting).
	Exposure bracketing (📖73)	The flash is not available.
Self-timer/ Smile timer	AF area mode (📖73)	When Subject tracking is selected, the self-timer/smile timer is not available.
Focus mode	Smile timer (📖64)	When smile timer is selected, the focus mode is fixed at AF (autofocus).
	AF area mode (📖73)	When Subject tracking is selected, MF (manual focus) is not available.
Image quality	Continuous (📖73)	When Pre-shooting cache is selected, Image quality is fixed at Normal .
Image size	Continuous (📖73)	<ul style="list-style-type: none"> When Pre-shooting cache is selected, Image size is fixed at L (2048 × 1536 pixels). When Continuous H: 120 fps is selected, Image size is fixed at VGA 640×480 and when Continuous H: 60 fps is selected, Image size is fixed at FHD 1920×1080. When Multi-shot 16 is selected, Image size is fixed at L (2560 × 1920 pixels).
Picture Control	Active D-Lighting (📖73)	When using Active D-Lighting , Contrast in manual adjustment cannot be adjusted.
White balance	Picture Control (📖72)	When Monochrome is selected, White balance is fixed at Auto (normal) .
Metering	Active D-Lighting (📖73)	When Active D-Lighting is set to any mode other than Off , Metering is reset to Matrix .

Restricted function	Setting	Description
Continuous/ Exposure bracketing	Continuous (📖73)/ Exposure bracketing (📖73)	Continuous and Exposure bracketing are not available simultaneously.
	Self-timer (📖63)	When self-timer is used, a single image is shot even if Continuous H , Continuous L , Pre-shooting cache , or BSS has been set.
	Smile timer (📖64)	When the camera detects smiling faces and the shutter is released, only one image is shot. If Intvl timer shooting is set, shooting finishes automatically after one image is shot.
	Picture Control (📖72)	When Monochrome is selected, Exposure bracketing is not available.
	Multiple exposure (📖73)	Not available simultaneously.
ISO sensitivity	Continuous (📖73)	When Pre-shooting cache , Multi-shot 16 , Continuous H: 120 fps or Continuous H: 60 fps is selected, ISO sensitivity is fixed at Auto .

Restricted function	Setting	Description
AF area mode	Smile timer (📖64)	The camera captures images using face detection regardless of the applied AF area mode option.
	Focus mode (📖65)	<ul style="list-style-type: none"> When a setting other than Subject tracking is selected and ▲ (infinity) is selected as the focus mode for shooting, the camera focuses at infinity regardless of the applied AF area mode option. When set to MF (manual focus), the AF area mode cannot be set.
	Picture Control (📖72)	When Target finding AF is selected and Picture Control is set to Monochrome , the camera focuses on a face or selects one or more of the 9 focus areas containing the subject closest to the camera.
	White balance (📖72)	When Target finding AF is selected, and if the white balance is set to Preset manual , Incandescent , Fluorescent or Choose color temp. , or fine adjustment of white balance is performed, the camera focuses on a face or selects one or more of the 9 focus areas containing the subject closest to the camera.
Autofocus mode	Smile timer (📖64)	Autofocus mode option cannot be changed when the smile timer is selected.
	Focus mode (📖65)	When the focus mode is set to ▲ (infinity), the autofocus mode operates using the Single AF setting.
	AF area mode (📖73)	When AF area mode is set to Face priority , Subject tracking or Target finding AF , Single AF is automatically selected.
Multiple exposure	Continuous (📖73)	Not available simultaneously.
	Exposure bracketing (📖73)	Not available simultaneously.
Print date	Continuous (📖73)	When Pre-shooting cache , Continuous H: 120 fps or Continuous H: 60 fps is selected, date cannot be imprinted on images.

Restricted function	Setting	Description
Digital zoom	Smile timer ( 64)	When the smile timer is selected, digital zoom is not available.
	Continuous ( 73)	When Multi-shot 16 is selected, digital zoom is not available.
	AF area mode ( 73)	When Subject tracking is selected, digital zoom is not available.
	Zoom memory ( 74)	When Zoom memory is set to On , digital zoom is not available.
Sound settings	Continuous ( 73)	When Continuous H, Continuous L, Pre-shooting cache, Continuous H: 120 fps, Continuous H: 60 fps, BSS, or Multi-shot 16 is selected, shutter sound is disabled.
	Exposure bracketing ( 73)	Shutter sound is disabled.
Blink warning	Smile timer ( 64)	When the smile timer is selected, blink warning is not available.
	Continuous ( 73)	When an option other than Single is selected, blink warning is not available.
	Exposure bracketing ( 73)	When an option other than Off is selected, blink warning is not available.
	Multiple exposure ( 73)	When Multiple exposure mode is set to On , blink warning is not available.

Notes About Digital Zoom

- Depending on the shooting mode or the current settings, digital zoom may not be available (67).
- When digital zoom is in effect, selectable options for AF area mode or metering mode are restricted.

Focusing

The focus area varies depending on the shooting mode.

Using the Target Finding AF

In  (auto) mode, or when **AF area mode** (📖73) in **P, S, A, M** or **U** mode is set to **Target finding AF**, the camera focuses in the manner described below when you press the shutter-release button halfway.

- The camera detects the main subject and focuses on it. When the subject is in focus, the focus area glows green. If a human face is detected, the camera automatically sets focus priority on it.

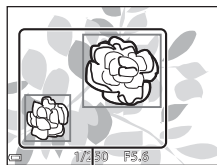

Focus areas

- If no main subject is detected, the camera automatically selects one or more of the 9 focus areas containing the subject closest to the camera. When the subject is in focus, the focus areas that are in focus glow green.

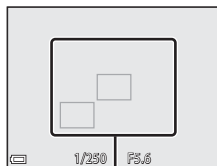



Focus areas

✓ Notes About Target Finding AF

- Depending on shooting conditions, the subject that the camera determines to be the main subject may vary.
- The main subject may not be detected when using certain **White balance** or **Picture Control** settings.
- The camera may not detect the main subject appropriately in the following situations:
 - When the subject is very dark or bright
 - When the main subject lacks clearly defined colors
 - When the shot is framed so that the main subject is on the edge of the monitor
 - When the main subject is composed of a repeating pattern

Using Face Detection

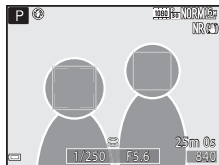

In the following settings, the camera uses face detection to automatically focus on human faces.

-  (night portrait), **Scene auto selector** or **Portrait** scene mode (📖40)
-  (smile timer) (📖64)
- When **AF area mode** (📖73) is set to **Face priority**



If the camera detects more than one face, a double border is displayed around the face that the camera focuses on, and single borders are displayed around the other faces.

If the shutter-release button is pressed halfway when no faces are detected:

- When **Scene auto selector** is selected, the focus area changes depending on the scene.
- In  (night portrait) and **Portrait**, the camera focuses on the area in the center of the frame.
- When  (smile timer) is selected, the camera focuses on the subject in the center of the frame.
- When **AF area mode** is set to **Face priority**, the camera selects the focus area containing the subject closest to the camera.

Notes About Face Detection

- The camera's ability to detect faces depends on a variety of factors, including the direction in which the faces are looking.
- The camera may be unable to detect faces in the following situations:
 - When faces are partially hidden by sunglasses or otherwise obstructed
 - When faces take up too much or too little of the frame

Viewing Images Taken Using Face Detection

During playback, the camera automatically rotates images according to the orientation of the faces that were detected at the time of shooting (except for images taken using **Continuous** (📖73) or **Exposure bracketing** (📖73)).

Using Skin Softening

When the shutter is released while using one of the shooting modes listed below, the camera detects human faces and processes the image to soften facial skin tones (up to 3 faces).

-  (night portrait), **Scene auto selector** or **Portrait** scene mode (40)
- Skin softening can also be applied to saved images (86).

Notes About Skin Softening

- It may take more time than usual to save images after shooting.
- Under some shooting conditions, the desired skin softening results may not be achieved, and skin softening may be applied to areas of the image where there are no faces.

Subjects Not Suitable for Autofocus

The camera may not focus as expected in the following situations. In some rare cases, the subject may not be in focus despite the fact that the focus area or focus indicator glows green:

- Subject is very dark
- Objects of sharply differing brightness are included in the scene (e.g. the sun behind the subject makes that subject appear very dark)
- No contrast between the subject and surroundings (e.g. a portrait subject wearing a white shirt is standing in front of a white wall)
- Several objects are at different distances from the camera (e.g. the subject is inside a cage)
- Subjects with repeating patterns (window blinds, buildings with multiple rows of similarly shaped windows, etc.)
- Subject is moving rapidly

In the situations noted above, try pressing the shutter-release button halfway to refocus several times, or focus on another subject positioned at the same distance from the camera as the actual desired subject, and use focus lock (83).

The camera can also focus using manual focus (66, 67).

Focus Lock

Use focus lock to capture creative compositions even when the focus area is set to the center of the frame.

- 1 Position the subject in the center of the frame and press the shutter-release button halfway.

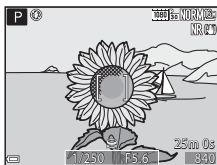

- Confirm that the focus area glows green.
- Focus and exposure are locked.

- 2 Without lifting your finger, recompose the picture.

- Make sure to maintain the same distance between the camera and the subject.

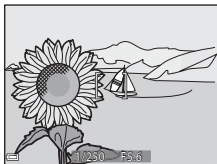

- 3 Press the shutter-release button the rest of the way down to take the picture.



Moving the Focus Area to the Desired Position

In **P**, **S**, **A** or **M** shooting mode, the focus area can be moved using the multi-selector by setting **AF area mode** in the shooting menu (72) to one of the manual options.

Playback Features

Playback Zoom

Moving the zoom control toward **T** (Q) in full-frame playback mode (📖36) zooms in on the image.

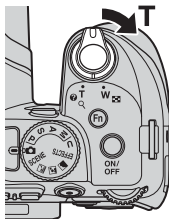

Image is displayed full-frame.

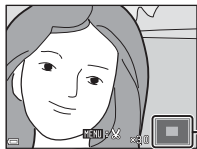



Image is zoomed in.

- You can change the zoom ratio by moving the zoom control toward **W** (📐) or **T** (Q). The zoom can also be adjusted by rotating the command dial.
- To view a different area of the image, press the multi selector ▲▼◀▶.
- If you are viewing an image that was captured using face detection or pet detection, the camera zooms in on the face detected at the time of shooting (except images captured using **Continuous** or **Exposure bracketing**). To zoom in on an area of the image where there are no faces, adjust the zoom ratio and then press ▲▼◀▶.
- When a zoomed image is displayed, press the **OK** button to return to full-frame playback mode.





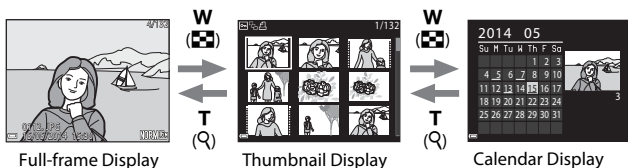
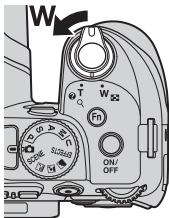

Cropping Images

When a zoomed image is displayed, you can press the **MENU** button to crop the image to include only the visible portion and save it as a separate file (📖12).

Thumbnail Display, Calendar Display

Moving the zoom control toward **W** () in full-frame playback mode ( 36) displays images as thumbnails.



- You can change the number of thumbnails displayed by moving the zoom control toward **W** () or **T** ().
- While using thumbnail playback mode, use the multi selector  or rotate it to select an image, and then press the  button to display that image full-frame.
- While using calendar display mode, use the multi selector  or rotate it to select a date, and then press the  button to display the images captured on that day.

Calendar Display







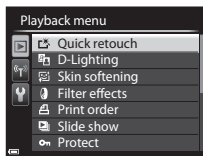
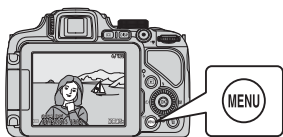

Images captured when the camera's date is not set are treated as images captured on January 1, 2014.

Functions That Can Be Set with the MENU Button (Playback Menu)

When viewing images in full-frame playback mode or thumbnail playback mode, you can configure the playback menu settings listed below by pressing the **MENU** button (📖12).



Option	Description	📖
🔍 Quick retouch ¹	Allows you to create retouched copies in which contrast and saturation have been enhanced.	📖8
📷 D-Lighting ¹	Allows you to create copies with enhanced brightness and contrast, brightening dark portions of an image.	📖8
👤 Skin softening ¹	Detects faces in images and creates a copy with softer facial skin tones.	📖9
🌀 Filter effects ¹	Allows you to apply a variety of effects using digital filters. The available effects are Soft portrait , Selective color , Cross screen , Fisheye , Miniature effect , Painting , Vignette , Photo illustration and Portrait (color + B&W) .	📖10
🖨️ Print order ²	Allows you to select which images are printed, and how many copies of each image are printed, prior to printing.	📖47
📺 Slide show	Allows you to view images in an automatic slide show.	📖49
🔒 Protect ²	Protects selected images and movies from accidental deletion.	📖50
🔄 Rotate image ²	Allows you to rotate the displayed image to portrait or landscape orientation.	📖50
🖼️ Small picture ¹	Creates a small copy of images.	📖11
🗣️ Voice memo	Allows you to use the camera's microphone to record voice memos and attach them to images.	📖51

Option	Description	
 Copy ²	Allows you to copy images between the internal memory and a memory card. This function can also be used to copy movies.	 52
 Sequence display options	Allows you to select whether to display only the key picture for a sequence of images captured continuously or to display the sequence as individual images. <ul style="list-style-type: none"> When only the key picture is displayed for a sequence, press the  button to display each image in the sequence. Press the multi selector  to return to the key picture display. 	 53
 Choose key picture ²	Allows you to change the key picture for images captured in sequence.	 53

¹ Edited images are saved as separate files. Some images may not be edited.

² Select an image on the image selection screen. See “Using the Screen for Selecting Images” (88) for more information.

Using the Screen for Selecting Images

When an image selection screen such as the one shown on the right is displayed while operating the camera, follow the procedures described below to select the images.



1 Use the multi selector ◀▶ or rotate it to select the desired image.

- Move the zoom control (1) toward **T** (Q) to switch to full-frame playback, or **W** (R) to switch to thumbnail playback.
- Only one image can be selected for **Rotate image**, **Choose key picture**, and **Welcome screen**. Proceed to step 3.



2 Use ▲▼ to select **ON** or **OFF** (or the number of copies).

- When **ON** is selected, a check mark (✓) is displayed with the image. Repeat steps 1 and 2 to select additional images.



3 Press the **OK** button to apply the image selection.

- When a confirmation dialog is displayed, follow the on-screen instructions.

Recording and Playing Back Movies

Recording Movies

1 Display the shooting screen.

- Check the remaining amount of movie recording time.
- Press the **DISP** (display) button and display the movie frame (10) to check the range of a movie in a frame before recording.

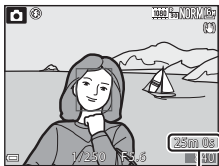

Movie recording time remaining

2 Press the **●** (movie-record) button to start movie recording.

- The camera focuses on the subject in the center of the frame.
- Press the multi selector **OK** to pause recording, and press **OK** again to resume recording (except when **iFrame 720/30p** or **iFrame 720/25p**, or an HS movie option is selected in **Movie options**). Recording automatically ends if it remains paused for about five minutes.

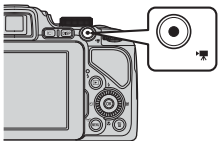

3 Press the **●** (movie-record) button again to end recording.

✓ Maximum Movie Length

Individual movie files cannot exceed 4 GB in size or 29 minutes in length, even when there is sufficient free space on the memory card for longer recording.

- The maximum movie length for a single movie is displayed on the shooting screen.
- Recording may end before either limit is reached if camera temperature becomes elevated.
- The actual movie length may vary depending on the movie content, subject movement, or type of memory card.

✓ Notes About Saving Images and Recording Movies

The indicator showing the number of exposures remaining or the indicator showing the maximum movie length flashes while images are being saved or while a movie is being recorded. **Do not open the battery-chamber/memory card slot cover or remove the battery or memory card** while an indicator is flashing. Doing this could result in loss of data, or in damage to the camera or the memory card.

✓ Notes About Movie Recording

- Memory cards with an SD Speed Class rating of 6 or faster are recommended when recording movies (□25). Movie recording may stop unexpectedly when a memory card with a lower Speed Class rating is used.
- When using the camera's internal memory, saving movies may take some time.
- Depending on the file size of a movie, it may not be possible to save the movie in the internal memory or copy it from a memory card to the internal memory.
- The sounds of zoom control operation, zoom, autofocus lens drive movement, vibration reduction, and aperture operation when brightness changes may be recorded.
- The following phenomena may be seen in the monitor while recording movies. These phenomena are saved in the recorded movies.
 - Banding may occur in images under fluorescent, mercury-vapor, or sodium-vapor lighting.
 - Subjects that move quickly from one side of the frame to the other, such as a moving train or car, may appear skewed.
 - The entire movie image may be skewed when the camera is panned.
 - Lighting or other bright areas may leave residual images when the camera is moved.
- Depending on the distance to the subject or the amount of zoom applied, subjects with repeating patterns (fabrics, lattice windows, etc.) may have colored stripes (interference patterns, moire, etc.) in them during movie recording and playback. This occurs when the pattern in the subject and the layout of the image sensor interfere with each other; it is not a malfunction.

✓ Notes About Using Zoom During Movie Recording

- The zoom indicator is not displayed during movie recording.
- There may be some degradation in image quality when digital zoom is used. If you zoom in on the subject while recording a movie, the zoom motion temporarily stops at the position where optical zoom is changed to digital zoom.

✓ Camera Temperature



- The camera may become warm when recording movies for an extended period of time or when the camera is used in a hot area.
- If the inside of the camera becomes extremely hot when recording movies, the camera will automatically stop recording. The amount of time remaining until the camera stops recording (🔒10s) is displayed. After the camera stops recording, it turns itself off.
Leave the camera off until the inside of the camera has cooled.

Focusing and Exposure Locking During Movie Recording

- The focus can be adjusted during movie recording in the following manner in accordance with the **Autofocus mode** (📖93) setting of the movie menu.
 - **AF-S Single AF** (default setting): The focus is locked when movie recording starts. To perform the autofocus function during movie recording, press the multi selector ◀.
 - **AF-F Full-time AF**: The focus is adjusted repeatedly even during movie recording.
- When the multi selector ▶ is pressed during movie recording, the exposure is locked. To unlock, press ▶ again.
- When the focus mode (📖65) is **MF** (manual focus), adjust the focus manually. The focus can be adjusted while recording movies by rotating the multi selector counterclockwise to focus on far subjects or clockwise to focus on near subjects.
- Autofocus may not perform as expected (📖82). Should this occur, try **MF** (manual focus) (📖66, 67) or set **Autofocus mode** in the movie menu to **AF-S Single AF** (default setting) and then use focus lock (📖83) to record.



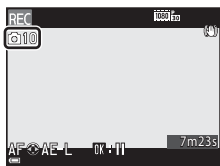

Saving Still Images While Recording Movies

If the shutter-release button is pressed all the way while recording a movie, one frame is saved as a still image (JPEG image). Movie recording continues while the still image is being saved.

- The maximum number of still images that can be saved during a movie recording (10 images) and  are displayed at the top left of the monitor. When  is displayed, a still image cannot be saved.
- The image size of the still images to be saved is set to  (1920 × 1080 pixels).



✓ Notes About Saving Still Images During Movie Recording





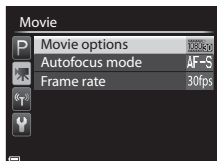

- Still images cannot be saved during movie recording in the following situations.
 - When movie recording is paused
 - When a movie is recorded to the internal memory
 - When the remaining movie length is less than 10 seconds
 - When **Movie options** (📖93) is set to  **1080/60i**,  **1080/50i**,  **480/30p**,  **480/25p** or HS movie
- Frames of a movie that were recorded when a still image was being taken may not be played back in a seamless manner.
- The sounds of operating the shutter-release button when saving a still image may be heard in the recorded movie.
- If the camera moves when the shutter-release button is pressed, the image may be blurred.

Functions That Can Be Set with the MENU Button (Movie Menu)

Enter shooting mode → Press the **MENU** button →  (movie) tab  13)

The settings of the menu options listed below can be configured.



Option	Description	
Movie options	Select the movie type. Select normal speed to record movies at normal speed, or HS (high speed) to record movies that play in slow or fast motion. • Default setting:  1080/30p or  1080/25p	 54
Autofocus mode	Select either Single AF , which locks focus when movie recording begins, or Full-time AF , which continues focusing during movie recording. • Default setting: Single AF	 57
Frame rate	Select the frame rate used when recording movies.	 57

Playing Back Movies

Press the  button to enter playback mode.

Movies are indicated by the movie options icon ( 54).

Press the  button to play back movies.

- To adjust the volume, move the zoom control ( 1).



Volume indicator

Functions Available During Playback

Rotate the multi selector or the command dial to advance or rewind.

Playback controls are displayed at the bottom of the monitor.

The operations listed below can be performed by using the multi selector ◀▶ to select a control and then pressing the OK button.

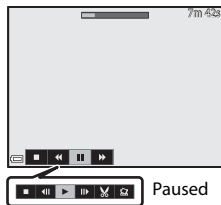

Function	Icon	Description
Rewind	◀◀	Hold down the OK button to rewind the movie.
Advance	▶▶	Hold down the OK button to advance the movie.
Pause	⏸	Pause playback. The operations listed below can be performed while paused.
		◀◀◀ Rewind the movie one frame. Hold down the OK button for continuous rewinding.*
		▶▶▶ Advance the movie one frame. Hold down the OK button for continuous advancing.*
		▶ Resume playback.
		✂ Extract the desired portion of a movie and save it as a separate file.
	🖼 Extract a single frame of a movie and save it as a still image.	
End	■	Return to full-frame playback mode.



* The movie can also be advanced or rewound by one frame by rotating the multi selector or command dial.

Deleting Movies

To delete a movie, select the desired movie in full-frame playback mode (📖36) or thumbnail playback mode (📖85) and press the 🗑 button (📖37).









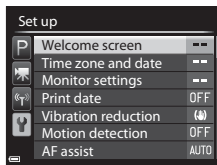

General Camera Setup













Functions That Can Be Set with the MENU Button (Setup Menu)

Press the MENU button →  (setup) tab (13)

The settings of the menu options listed below can be configured.



Option	Description	
Welcome screen	Allows you to select whether or not the welcome screen is displayed when the camera is turned on.	 60
Time zone and date	Allows you to set the camera clock.	 61
Monitor settings	Allows you to adjust post-shooting image review, monitor brightness, and photo information display settings.	 63
Print date	Allows you to imprint the shooting date and time on images.	 64
Vibration reduction	Allows you to select the vibration reduction setting used when shooting.	 65
Motion detection	Allows you to set whether or not the camera automatically increases the shutter speed to reduce blurring caused by camera shake if motion is detected when shooting still images.	 66
AF assist	Allows you to enable or disable the AF-assist illuminator.	 66
Digital zoom	Allows you to set the operation of digital zoom.	 67
Assign side zoom control	Allows you to select the function to be performed during shooting when the side zoom control is moved.	 68
Sound settings	Allows you to adjust sound settings.	 69

Option	Description	
Auto off	Allows you to set the amount of time that passes before the monitor turns off to save power.	 69
Format memory/ Format card	Allows you to format the internal memory or the memory card.	 70
Language	Allows you to change the camera's display language.	 70
TV settings	Allows you to adjust TV-connection settings.	 71
Charge by computer	Allows you to set whether or not the battery in the camera is charged when the camera is connected to a computer.	 72
Toggle Av/Tv selection	Allows you to switch the method for setting the flexible program, shutter speed or aperture value.	 73
Reset file numbering	Allows you to reset the sequential numbering of file numbers when Yes is selected.	 73
Blink warning	Allows you to set whether or not closed eyes are detected when taking images of people using face detection.	 74
Eye-Fi upload	Allows you to set whether or not to enable the function for sending images to a computer using a commercially available Eye-Fi card.	 75
Peaking	Allows you to set whether or not to highlight areas that are in focus in white on the image displayed in the monitor when operating manual focus.	 76
Reset all	Allows you to reset the camera's settings to their default values.	 76
Firmware version	View the current camera firmware version.	 76

Using the Wi-Fi (Wireless LAN) Function

Functions That Can Be Performed Using Wi-Fi

You can perform the following functions if you install the dedicated software “Wireless Mobile Utility” on your smart device that runs on Android OS or iOS, and connect it to the camera.

Take Photos

You can use a smart device to remotely release the camera shutter and save images to the smart device.

- Operations cannot be performed on the camera during remote control operation.
- The shooting mode is set to  (auto) mode and the focus area is set to the center of the frame, regardless of the camera's settings.



View Photos

You can copy the images saved in the camera's memory card and display them on your smart device.

Installing the Software on the Smart Device

- 1** Use your smart device to connect to Google Play Store, App Store or other online apps marketplace and search for “Wireless Mobile Utility.”
 - Check the user's manual provided with your smart device for further details.
- 2** Check the description and other information and install the software.
 - For more information about how to operate the software, download the user's manual from the website below.
 - Android OS: <http://nikonimglib.com/ManDL/WMAU/>
 - iOS: <http://nikonimglib.com/ManDL/WMAU-ios/>

Connecting the Smart Device to the Camera

Press the MENU button →  (Wi-Fi options) tab →  button

1 Use the multi selector ▲▼ to select **Connect to smart device** and press the button.

- See “Notes About Wi-Fi Connection” (99) when **Connect to smart device** cannot be selected.
- When the Wi-Fi function is turned on, SSID and password are displayed.
- If no connection confirmation is received from the smart device within 3 minutes, the message “No access.” is displayed and the camera returns to the Wi-Fi options screen.

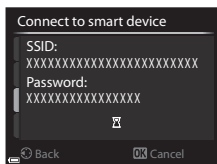
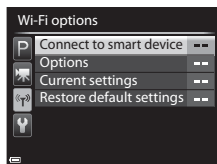

2 Set the Wi-Fi setting on the smart device to On.

- Check the user’s manual provided with your smart device for further details.
- After the network name (SSID) that can be used for the smart device is displayed, select the SSID displayed on the camera.
- When the message for entering a password is displayed, enter the password that is displayed on the camera.
- When the camera is successfully connected to a Wi-Fi network, the camera monitor turns off and the power-on lamp turns on.

3 Start the “Wireless Mobile Utility” installed on the smart device.

- The screen for selecting “Take photos” or “View photos” is displayed.
- When the message “Cannot connect to camera.” is displayed, return to step 1 and retry the procedure.

To Terminate the Wi-Fi Connection

- Turn off the camera.
- Set the Wi-Fi setting on the smart device to Off.

Notes About Wi-Fi Connection

- **Connect to smart device** cannot be selected in the following situations:
 - When no memory card is inserted in the camera.
 - When an Eye-Fi card (E75) is inserted in the camera.
 - When the camera is connected to a TV, computer, or printer.
 - When the battery level indicator in the monitor indicates . In addition, if the battery level indicator becomes low when Wi-Fi is connected, the connection is terminated.
- Terminate the Wi-Fi connection in a place where the use of radio waves is prohibited.
- When Wi-Fi is connected, **Auto off** is disabled.
- When Wi-Fi is connected, the battery drains faster than normal.
- It may take some time until the SSID is displayed on the smart device after **Connect to smart device** is performed.

Notes About Security Settings

If the camera is installed with the Wi-Fi function without proper security settings (encryption and password), unauthorized third parties may access the network and cause harm. We strongly recommend performing the required security settings before using the Wi-Fi function.

Use **Options** of **Wi-Fi options** to perform the security settings (E58).

Connecting the Camera to a TV, Computer, or Printer

Connection Methods

You can enhance your enjoyment of images and movies by connecting the camera to a TV, computer, or printer.

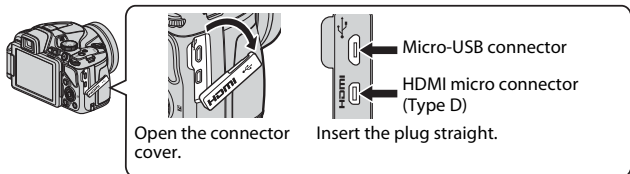

- Before connecting the camera to an external device, make sure the remaining battery level is sufficient and turn the camera off. Before disconnecting, make sure to turn the camera off.
- If the AC Adapter EH-67A (available separately) is used, this camera can be powered from an electrical outlet. Do not use any other make or model of AC adapter as it may cause the camera to heat up or malfunction.
- For information about the connection methods and subsequent operations, refer to the documentation included with the device in addition to this document.



Images and movies captured with the camera can be viewed on a TV.

Connection method: Connect a commercially available HDMI cable to the TV's HDMI input jack.



You can transfer images to a computer to perform simple retouching and manage image data.

Connection method: Connect the camera to the computer's USB port with the included USB cable.

- Before connecting to a computer, install ViewNX 2 on the computer ( 102).
- If any USB devices that draw power from the computer are connected, disconnect them from the computer before you connect the camera to it. Connecting the camera and other USB-powered devices to the same computer simultaneously may cause a camera malfunction or excessive power supply from the computer, which could damage the camera or memory card.



If you connect the camera to a PictBridge-compatible printer, you can print images without using a computer.

Connection method: Connect the camera directly to the printer's USB port with the included USB cable.

Using ViewNX 2

Install ViewNX 2 to upload, view, edit, and share photos and movies.

Your Imaging Toolbox

ViewNX 2™



Installing ViewNX 2

An Internet connection is required. For system requirements and other information, see the Nikon website for your region.

1 Download the ViewNX 2 installer.

Start the computer and download the installer from:

<http://nikonimglib.com/nvnx/>

2 Double-click the downloaded file.

3 Follow the on-screen instructions.

4 Exit the installer.

Click **Yes** (Windows) or **OK** (Mac).

Transferring Images to the Computer

1 Choose how images will be copied to the computer.

Choose one of the following methods:

- **Direct USB connection:** Turn the camera off and ensure that the memory card is inserted in the camera. Connect the camera to the computer using the USB cable. The camera automatically turns on.
To transfer images that are saved in the camera's internal memory, remove the memory card from the camera before connecting it to the computer.

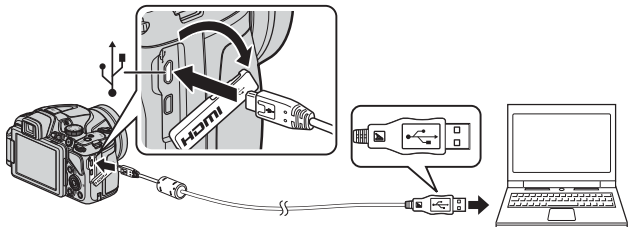

- **SD card slot:** If your computer is equipped with an SD card slot, the card can be inserted directly in the slot.
- **SD card reader:** Connect a card reader (available separately from third-party suppliers) to the computer and insert the memory card.

If a message is displayed prompting you to choose a program, select Nikon Transfer 2.

• When using Windows 7

If the dialog shown at right is displayed, follow the steps below to select Nikon Transfer 2.

- 1 Under **Import pictures and videos**, click **Change program**. A program selection dialog will be displayed; select **Import File using Nikon Transfer 2** and click **OK**.
- 2 Double-click **Import File**.



If the memory card contains a large number of images, it may take a while for Nikon Transfer 2 to start. Wait until Nikon Transfer 2 starts.

✓ Connecting the USB Cable

The connection may not be recognized if the camera is connected to the computer via a USB hub.

2 Transfer images to the computer.

- Click **Start Transfer**.

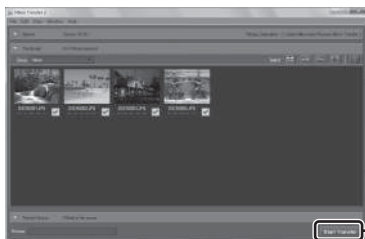

Start Transfer

- At default settings, all the images on the memory card will be copied to the computer.

3 Terminate the connection.

- If the camera is connected to the computer, turn the camera off and disconnect the USB cable.
- If you are using a card reader or card slot, choose the appropriate option in the computer operating system to eject the removable disk corresponding to the memory card and then remove the card from the card reader or card slot.

Viewing Images

Start ViewNX 2.

- Images are displayed in ViewNX 2 when transfer is complete.
- Consult online help for more information on using ViewNX 2.

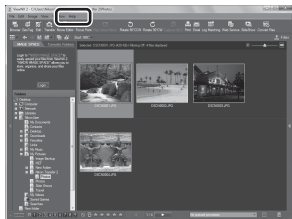

Starting ViewNX 2 Manually

- **Windows:** Double-click the **ViewNX 2** shortcut on the desktop.
- **Mac:** Click the **ViewNX 2** icon in the Dock.



Technical Notes and Index

Caring for the Products	2
The Camera.....	2
The Battery.....	3
Charging AC Adapter.....	4
Memory Cards.....	5
Caring for the Camera	6
Cleaning.....	6
Storage	7
Troubleshooting	8
Specifications.....	16
Index.....	23

Caring for the Products

The Camera

To ensure continued enjoyment of this Nikon product, observe the precautions described below in addition to the warnings in "For Your Safety" (📖vii-ix) when using or storing the device.

✔ **Do Not Drop**

The product may malfunction if subjected to strong shock or vibration.

✔ **Handle the Lens and All Moving Parts with Care**

Do not apply force to the lens, lens cover, monitor, memory card slot, or battery chamber. These parts are easily damaged. Applying force to the lens cover could result in camera malfunction or damage to the lens. Should the monitor break, care should be taken to avoid injury caused by broken glass and to prevent the liquid crystal from the display touching the skin or entering the eyes or mouth.

✔ **Keep Dry**

The device will be damaged if immersed in water or subjected to high humidity.

✔ **Avoid Sudden Changes in Temperature**

Sudden changes in temperature, such as when entering or leaving a heated building on a cold day, can cause condensation to form inside the device. To prevent condensation, place the device in a carrying case or a plastic bag before exposing it to sudden changes in temperature.

✔ **Keep away from Strong Magnetic Fields**

Do not use or store this device in the vicinity of equipment that generates strong electromagnetic radiation or magnetic fields. Strong static charge or the magnetic fields produced by equipment such as radio transmitters could interfere with the monitor, damage data saved on the memory card, or affect the product's internal circuitry.

✔ **Do Not Point the Lens at Strong Light Sources for Extended Periods**

Avoid pointing the lens at the sun or other strong light sources for extended periods when using or storing the camera. Intense light may cause deterioration of the image sensor, producing a white blur effect in photographs.

Turn the Product off Before Removing or Disconnecting the Power Source or the Memory Card

Do not remove the battery while the product is on, or while images are being saved or deleted. Forcibly cutting power in these circumstances could result in loss of data or in damage to product memory or internal circuitry.

Notes About the Monitor

- Monitors and electronic viewfinders are constructed with extremely high precision; at least 99.99% of pixels are effective, with no more than 0.01% being missing or defective. Hence while these displays may contain pixels that are always lit (white, red, blue, or green) or always off (black), this is not a malfunction and has no effect on images recorded with the device.
- Images in the monitor may be difficult to see under bright lighting.
- The monitor is lit by an LED backlight. Should the monitor begin to dim or flicker, contact your Nikon-authorized service representative.

The Battery

- Be sure to read and follow the warnings in “For Your Safety” (📖vii-ix) before use.
- Check the battery level before using the camera and replace or charge the battery if necessary. Do not continue charging once the battery is fully charged as this will result in reduced battery performance. Whenever possible, carry a fully charged spare battery when taking images on important occasions.
- Do not use the battery at ambient temperatures below 0°C (32°F) or above 40°C (104°F).
- Charge the battery indoors with an ambient temperature of 5°C to 35°C (41°F to 95°F) before use.
- When the battery temperature is between 0°C and 10°C (32°F to 50°F) or 45°C to 60°C (113°F to 140°F), the chargeable capacity may decrease.
- The battery is not charged at ambient temperatures below 0°C (32°F) or above 60°C (140°F).
- Note that the battery may become hot during use; wait for the battery to cool before charging. Failure to observe these precautions could damage the battery, impair its performance, or prevent it from charging normally.
- On cold days, the capacity of batteries tends to decrease. If an exhausted battery is used at a low temperature, the camera will not turn on. Be sure that the battery is fully charged before heading outside to take images in cold weather. Keep spare batteries in a warm place and exchange as necessary. Once warmed, a cold battery may recover some of its charge.
- Dirt on the battery terminals can prevent the camera from functioning. Should the battery terminals become dirty, wipe them off with a clean, dry cloth before use.

- If the battery will not be used for some time, insert it in the camera and completely exhaust it before removing it for storage. The battery should be stored in a cool location with an ambient temperature of 15°C to 25°C (59°F to 77°F). Do not store the battery in hot or extremely cold locations.
- Always remove the battery from the camera or optional battery charger when it is not being used. When inserted, minute amounts of current are drawn from the battery even when not in use. This may result in excessive draining of the battery and complete loss of function. Turning the camera on or off while the battery is exhausted can result in reduced battery life.
- Recharge the battery at least once every six months and completely exhaust it before returning it to storage.
- After removing the battery from the camera or optional battery charger, put the battery in a plastic bag, etc. to insulate it and store it in a cool place.
- A marked drop in the time a fully-charged battery retains its charge, when used at room temperature, indicates that the battery needs to be replaced. Purchase a new EN-EL23 battery.
- Replace the battery when it no longer holds a charge. Used batteries are a valuable resource. Please recycle used batteries in accordance with local regulations.

Charging AC Adapter

Be sure to read and follow the warnings in “For Your Safety” (📖vii-ix) before use.

- The Charging AC Adapter EH-71P is for use only with compatible devices. Do not use with another make or model of device.
- Do not use a USB cable other than the UC-E21. Using a USB cable other than the UC-E21 could result in overheating, fire or electric shock.
- Do not, under any circumstances, use another make or model of AC adapter other than Charging AC Adapter EH-71P, and do not use a commercially available USB-AC adapter or a battery charger for a mobile phone. Failure to observe this precaution could result in overheating or in damage to the camera.
- The EH-71P is compatible with AC 100 V–240 V, 50/60 Hz electrical outlets. When using in other countries, use a plug adapter (available commercially) as necessary. For more information about plug adapters, consult your travel agency.

Memory Cards

- Use only Secure Digital memory cards. See “Approved Memory Cards” (📖25) for recommended memory cards.
- Observe the precautions noted in the documentation included with your memory card.
- Do not affix labels or stickers to the memory card.
- Do not format the memory card using a computer.
- The first time you insert a memory card that has been used in another device into this camera, be sure to format it with this camera. We recommend formatting new memory cards with this camera before using them with this camera.
- Note that **formatting a memory card permanently deletes all images and other data on the memory card.** If there is data saved on the memory card that you wish to keep, copy that data to a computer before formatting.
- If the message **Card is not formatted. Format card?** is displayed when the camera is turned on, the memory card must be formatted. If there is data on the memory card that you do not want to delete, select **No** and press the  button. Copy that data to a computer before formatting. To format the memory card, select **Yes**.
- Observe the following precautions while formatting the memory card, saving and deleting images, and copying images to a computer, otherwise data or the memory card itself may be damaged.
 - Do not open the battery-chamber/memory card slot cover or remove the memory card or battery.
 - Do not turn off the camera.
 - Do not disconnect the AC adapter.

Caring for the Camera

Cleaning

Lens/ viewfinder	Avoid touching glass parts with your fingers. Remove dust or lint with a blower (typically a small device with a rubber bulb attached to one end that is pumped to produce a stream of air out the other end). To remove fingerprints or other stains that cannot be removed with a blower, wipe the lens with a soft cloth, using a spiral motion that starts at the center of them and working toward the edges. If this fails, clean the lens using a cloth lightly dampened with commercial lens cleaner.
Monitor	Remove dust or lint with a blower. To remove fingerprints and other stains, clean the monitor with a soft, dry cloth, being careful not to apply pressure.
Body	Use a blower to remove dust, dirt, or sand, then wipe gently with a soft, dry cloth. After using the camera at the beach or other sandy or dusty environment, wipe off any sand, dust, or salt with a dry cloth lightly dampened with fresh water and dry thoroughly. Note that foreign matter inside the camera could cause damage not covered by the warranty.

Do not use volatile organic solvents such as alcohol or thinner, chemical detergents, anticorrosive agents, or anti-fogging agents.

Storage

Turn the camera off when not in use. Be sure that the power-on lamp is off before putting the camera away. Remove the battery if the camera will not be used for an extended period. Do not store the camera with naphtha or camphor moth balls, or in any of the following locations:

- Next to equipment that produces strong electromagnetic fields, such as televisions or radios
- Exposed to temperatures below -10°C (14°F) or above 50°C (122°F)
- Places that are poorly ventilated or subject to humidity of over 60%





To prevent mold or mildew, take the camera out of storage at least once a month. Turn the camera on and release the shutter a few times before putting the camera away again.











For storing the battery, follow the precautions in "The Battery" (🔋:3) in "Caring for the Products" (🔋:2).





Troubleshooting

If the camera fails to function as expected, check the list of common problems below before consulting your retailer or Nikon-authorized service representative.



Power, Display, Settings Issues







Problem	Cause/Solution	
The camera is on but does not respond.	<ul style="list-style-type: none"> • Wait for recording to end. • If the problem persists, turn the camera off. If the camera does not turn off, remove and reinsert the battery or batteries or, if you are using an AC adapter, disconnect and reconnect the AC adapter. Note that although any data currently being recorded will be lost, data that have already been recorded will not be affected by removing or disconnecting the power source. 	- 26,  82
Battery inserted in the camera cannot be charged.	<ul style="list-style-type: none"> • Confirm all connections. • When connected to a computer, the camera may not charge for any of the reasons described below. <ul style="list-style-type: none"> - Off is selected for Charge by computer in the setup menu. - Battery charging stops if the camera is turned off. - Battery charging is not possible if the camera's display language and date and time have not been set, or the date and time were reset after the camera's clock battery was exhausted. Use the charging AC adapter to charge the battery. - Battery charging may stop if the computer is in sleep mode. - Depending upon the computer specifications, settings, and status, battery charging may not be possible. 	22  72 - 28, 29 - -
Camera cannot be turned on.	<ul style="list-style-type: none"> • The battery is exhausted. • When the charging AC adapter is connected, the camera cannot be turned on even if the power switch is pressed. The camera turns on in playback mode by pressing and holding down the  (playback) button, but shooting is not possible. 	26 22









Problem	Cause/Solution	
Camera turns off without warning.	<ul style="list-style-type: none"> The camera automatically turns off to save power (auto off function). The camera or battery has become too cold and cannot operate properly. The inside of the camera has become hot. Leave the camera off until the inside of the camera has cooled, and then try turning it on again. 	27  3 -
The monitor or viewfinder is blank.	<ul style="list-style-type: none"> The camera is off. The battery is exhausted. The camera has entered standby mode to save power. Press the power switch, shutter-release button,  button or  (movie-record) button, or rotate the mode dial. You cannot turn on both the monitor and viewfinder at the same time. It may take a while to switch between the monitor and viewfinder. The camera and computer are connected via a USB cable. The camera and TV are connected via an HDMI cable. Interval timer shooting in progress. Wi-Fi is connected. 	26 26 27 - 100, 103 100,  13  34 98,  58
Monitor is hard to see.	<ul style="list-style-type: none"> The ambient light is too bright. Move to a darker place or use the viewfinder. Adjust the monitor brightness. The monitor is dirty. Clean the monitor. 	9 95,  63  6
Image in the viewfinder is difficult to see.	Adjust the viewfinder using the diopter adjustment control.	9
Date and time of recording are not correct.	<ul style="list-style-type: none"> If the camera clock has not been set, the "Date not set" indicator flashes during shooting and movie recording. Images and movies saved before the clock is set are dated "00/00/0000 00:00" or "01/01/2014 00:00" respectively. Set the correct time and date from the Time zone and date option in the setup menu. The camera clock is not as accurate as ordinary watches or clocks. Periodically compare the time of the camera clock with that of a more accurate timepiece and reset as required. 	28, 95,  61 95,  61









Problem	Cause/Solution	
No information displayed in monitor.	Shooting and photo information may be hidden. Press the DISP button until information is displayed.	10
Print date not available.	Time zone and date has not been set in the setup menu.	28, 95,  61
Date not imprinted on images even when Print date is enabled.	<ul style="list-style-type: none"> The current shooting mode does not support Print date. A function that restricts the Print date function is enabled. The date cannot be imprinted on movies. 	95,  64 76 –
Screen for setting time zone and date is displayed when camera is turned on.	The clock battery is exhausted; all settings were restored to their default values.	28, 29
Camera settings reset.		
Reset file numbering cannot be done.	Although a new folder is created in the internal memory or on the memory card by resetting file numbering, etc., if the sequential number of a folder name (which is not displayed on the camera) reaches the upper limit ("999"), reset is not possible. Change the memory card, or format the internal memory/memory card.	96,  73
Camera becomes hot.	The camera may become hot when used for an extended period of time to shoot movies or send images using an Eye-Fi card, or when used in a hot environment; this is not a malfunction.	–
Camera makes sound.	When Autofocus mode is set to Full-time AF or while in some shooting modes, the camera may produce an audible focusing sound.	73, 93

Shooting Issues

Problem	Cause/Solution	
Cannot switch to shooting mode.	<ul style="list-style-type: none"> Disconnect the HDMI cable or USB cable. When the camera is connected to the electrical outlet using the charging AC adapter, the camera cannot switch to shooting mode. 	100, 103,  13,  14 22







Problem	Cause/Solution	
No image captured when the shutter-release button is pressed.	<ul style="list-style-type: none"> • When the camera is in playback mode, press the  button, shutter-release button or  (movie-record) button. • When menus are displayed, press the MENU button. • The battery is exhausted. • When the scene mode is Night portrait or Backlighting with HDR set to Off, raise the flash. • If the flash mode icon flashes when the shutter-release button is pressed halfway, the flash is charging. 	36 12 26 42, 46, 60 60
Camera cannot focus.	<ul style="list-style-type: none"> • The subject is too close. Try shooting using the Scene auto selector or Close-up scene mode, or the macro close-up focus mode. • Incorrect focus mode setting. Check or change the setting. • The subject is hard to focus on. • Set AF assist in the setup menu to Auto. • Subject is not in focus area when the shutter-release button is pressed halfway. • The focus mode is set to MF (manual focus). • Turn the camera off and then on again. 	43, 44, 65, 66 65, 66 82 95,  66 34, 73 65, 67 26
Colored stripes appear in the monitor when shooting.	Colored stripes may appear when shooting subjects with repeating patterns (such as window blinds); this is not a malfunction. The colored stripes will not appear in captured images or recorded movies. However, when using Continuous H: 120 fps or HS 480/4x , the colored stripes may be seen in the captured images and recorded movies.	–
Images are blurred.	<ul style="list-style-type: none"> • Use the flash. • Enable vibration reduction or motion detection. • Use BSS (Best Shot Selector) of Continuous in the shooting menu. • Use a tripod to stabilize the camera when shooting (using the self-timer at the same time is more effective). 	60 95,  65,  66 73 63
Bright specks appear in images captured with flash.	Flash is reflecting off particles in air. Lower the flash, and set the flash mode to  (off).	60





Problem	Cause/Solution	
Flash does not fire.	• A shooting mode where the flash cannot fire is selected.	70
	• A function that restricts the flash is enabled.	76
Digital zoom cannot be used.	• A function that restricts digital zoom is enabled.	76
	• Digital zoom is set to Off in the setup menu.	95,  67
	• Digital zoom cannot be used in the following scene modes.	76
	- Scene auto selector, Portrait, Night portrait, Easy panorama, Pet portrait	40
Image size not available.	• A function that restricts the Image size option is enabled.	76
	• When the scene mode is set to Easy panorama , the image size is fixed.	47
No sound when shutter is released.	Off is selected for Sound settings > Shutter sound in the setup menu. No sound is produced with some shooting modes and settings, even when On is selected.	76, 95,  69
AF-assist illuminator does not light.	Off is selected for the AF assist option in the setup menu. AF-assist illuminator may not light depending on the position of the focus area or the current scene mode, even when Auto is selected.	95,  66
Images appear smeared.	The lens is dirty. Clean the lens.	 6
Colors are unnatural.	White balance is not adjusted properly.	45, 72,  28
Randomly spaced bright pixels ("noise") appear in image.	The subject is dark, and the shutter speed is too slow or ISO sensitivity is too high. Noise can be reduced by: <ul style="list-style-type: none"> • Using the flash. • Specifying a lower ISO sensitivity setting. 	60 73,  36
Bright spots appear in image.	When shooting at a slow shutter speed in multiple exposure mode, noise (bright spots) may appear in saved images.	–
Images are too dark (underexposed).	• The flash window is blocked.	32
	• The subject is beyond the range of the flash.	 18
	• Adjust exposure compensation.	69
	• Increase ISO sensitivity.	73,  36
	• The subject is backlit. Raise the flash or select the scene mode Backlighting and try taking an image again.	46, 60

Problem	Cause/Solution	
Images are too bright (overexposed).	Adjust exposure compensation.	69
Unexpected results when flash set to  (auto with red-eye reduction).	When taking images with  (auto with red-eye reduction) or fill flash with red-eye reduction in Night portrait scene mode, In-Camera Red-Eye Fix may be applied to areas not affected by red-eye in rare cases. Use any scene mode other than Night portrait , and change the flash mode to any setting other than  (auto with red-eye reduction) and try taking an image again.	42, 60
Skin tones are not softened.	<ul style="list-style-type: none"> • In some shooting conditions, facial skin tones may not be softened. • For images containing 4 or more faces, try using Skin softening in the playback menu. 	82 86,  9
Saving images takes time.	It may take more time to save images in the following situations. <ul style="list-style-type: none"> • When the noise reduction function is in operation • When the flash mode is set to  (auto with red-eye reduction) • When taking images in the following scene modes. <ul style="list-style-type: none"> - Hand-held in Night landscape - Noise reduction burst in Landscape or Close-up - HDR is set to any setting other than Off in Backlighting - Easy panorama • Continuous in the shooting menu is set to Continuous H: 120 fps or Continuous H: 60 fps • When using smile timer while shooting • When using Active D-Lighting while shooting • When using multiple exposure while shooting 	- 61 41 42, 44 46 47 73,  32 64 73,  42 73,  43
A ring-shaped belt or rainbow-colored stripe appears in the monitor or images.	When shooting with backlighting or when a very strong light source (such as sunlight) is in the frame, a ring-shaped belt or rainbow-colored stripe (ghosting) may occur. Change the position of the light source, or frame the image so that the light source does not enter the frame, and try again.	-

Problem	Cause/Solution	
Cannot select a setting/Selected setting is disabled.	<ul style="list-style-type: none"> • Certain menu items are unavailable depending on the shooting mode. Menu items that cannot be selected are displayed in gray. • A function that restricts the selected function is enabled. 	12 –

Playback Issues

Problem	Cause/Solution	
File cannot be played back.	<ul style="list-style-type: none"> • This camera may not be able to play back images saved with another make or model of digital camera. • This camera may not be able to play back data edited on a computer. • Files cannot be played back during interval timer shooting. 	– – 73,  34
Cannot zoom in on image.	<ul style="list-style-type: none"> • Playback zoom cannot be used with movies. • This camera may not be able to zoom in on images captured with another make or model of digital camera. • When zooming in on a small-sized image, the zoom ratio shown on the screen may differ from the actual zoom ratio of the image. 	– – –
Cannot record voice memo.	<ul style="list-style-type: none"> • Voice memos cannot be attached to movies. • Voice memos cannot be attached to images captured with other cameras. Voice memos attached to images using another camera cannot be played back on this camera. 	– 86,  51
Cannot edit image.	<ul style="list-style-type: none"> • Some images cannot be edited. Images that have already been edited may not be edited again. • There is not enough free space in the internal memory or on the memory card. • This camera is unable to edit images captured with other cameras. • Editing functions used for images are not available for movies. 	47,  7 – 88,  7 –
Images are not displayed on TV.	<ul style="list-style-type: none"> • HDMI is not correctly set in the TV settings setup menu. • A computer or printer is connected to the camera. • The memory card contains no images. Replace the memory card. Remove the memory card to play back images from the internal memory. 	96,  71 100, 103,  14 24

Problem	Cause/Solution	
Nikon Transfer 2 does not start when camera is connected to a computer.	<ul style="list-style-type: none"> The camera is off. The battery is exhausted. The USB cable is not correctly connected. The camera is not recognized by the computer. The computer is not set to start Nikon Transfer 2 automatically. For more information about Nikon Transfer 2, refer to help information contained in ViewNX 2. 	26 26 100, 103 – 103
The PictBridge screen is not displayed when the camera is connected to a printer.	With some PictBridge-compatible printers, the PictBridge screen may not be displayed and it may be impossible to print images when Auto is selected for the Charge by computer option. Set the Charge by computer option to Off and reconnect the camera to the printer.	96,  72
Images to be printed are not displayed.	<ul style="list-style-type: none"> The memory card contains no images. Replace the memory card. Remove the memory card to print images from the internal memory. 	24 25
Cannot select paper size with camera.	<p>The camera cannot be used to select the paper size in the following situations, even when printing from a PictBridge-compatible printer. Use the printer to select the paper size.</p> <ul style="list-style-type: none"> The printer does not support the paper sizes specified by the camera. The printer automatically selects the paper size. 	 15,  17 –

Wi-Fi

Problem	Cause/Solution	
SSID (network name) is not displayed on the smart device.	<p>Select Connect to smart device in the Wi-Fi options menu on the camera to enter connection standby mode.</p> <p>Turn off the Wi-Fi function of the smart device and then turn it on again.</p>	98

Specifications

Nikon COOLPIX P600 Digital Camera

Type	Compact digital camera
Number of effective pixels	16.1 million
Image sensor	1/2.3-in. type CMOS; approx. 16.76 million total pixels
Lens	NIKKOR lens with 60x optical zoom
Focal length	4.3-258 mm (angle of view equivalent to that of 24-1440 mm lens in 35mm [135] format)
f/-number	f/3.3-6.5
Construction	16 elements in 11 groups (4 ED lens elements and 1 super ED lens element)
Digital zoom magnification	Up to 4x (angle of view equivalent to that of approx. 5760 mm lens in 35mm [135] format)
Vibration reduction	Lens shift
Motion blur reduction	Motion detection (still pictures)
Autofocus (AF)	Contrast-detect AF
Focus range	<ul style="list-style-type: none">• [W]: Approx. 50 cm (1 ft 8 in.) - ∞, [T]: Approx. 2.0 m (6 ft 7 in.) - ∞• Macro close-up mode: Approx. 1 cm (0.4 in.) (at a wide-angle zoom position) - ∞ (All distances measured from center of front surface of lens)
Focus-area selection	Target finding AF, face priority, manual (spot), manual (normal), manual (wide), subject tracking
Viewfinder	Electronic viewfinder, 0.5 cm (0.2-in.) approx. 201k-dot equivalent LCD with the diopter adjustment function (-4 - +4 m ⁻¹)
Frame coverage (shooting mode)	Approx. 100% horizontal and 100% vertical (compared to actual picture)
Frame coverage (playback mode)	Approx. 100% horizontal and 100% vertical (compared to actual picture)
Monitor	7.5 cm (3-in.), approx. 921k-dot (RGBW), wide viewing angle TFT LCD with anti-reflection coating and 6-level brightness adjustment, vari-angle TFT LCD
Frame coverage (shooting mode)	Approx. 100% horizontal and 100% vertical (compared to actual picture)
Frame coverage (playback mode)	Approx. 100% horizontal and 100% vertical (compared to actual picture)

Storage		
Media		Internal memory (approx. 56 MB) SD/SDHC/SDXC memory card
File system		DCF, Exif 2.3 and DPOF compliant
File formats		Still pictures: JPEG Sound files (voice memo): WAV Movies: MOV (Video: H.264/MPEG-4 AVC, Audio: LPCM stereo)
Image size (pixels)		<ul style="list-style-type: none"> • 16 M 4608×3456 • 8 M 3264×2448 • 4 M 2272×1704 • 2 M 1600×1200 • VGA 640×480 • 16:9 12M 4608×2592 • 16:9 2M 1920×1080 • 3:2 4608×3072 • 1:1 3456×3456
ISO sensitivity (Standard output sensitivity)		<ul style="list-style-type: none"> • ISO 100 - 1600 • ISO 3200, 6400 (available when using P, S, A or M mode) • Hi 1 (equivalent to ISO 12800) (available when using High ISO monochrome in special effects mode)
Exposure		
Metering mode		Matrix, center-weighted, or spot
Exposure control		Programmed auto exposure with flexible program, shutter-priority auto, aperture-priority auto, manual, exposure bracketing enabled, exposure compensation (-2.0 EV - +2.0 EV in steps of 1/3 EV) enabled
Shutter		
Speed		Mechanical and CMOS electronic shutter <ul style="list-style-type: none"> • 1/4000 * - 1 s • 1/4000 * - 15 s (when ISO sensitivity is 100 in M mode) * When the aperture value is set to f/7.6 (wide-angle end)
Aperture		
Range		Electronically-controlled 6-blade iris diaphragm 8 steps of 1/3 EV (W) (A, M mode)
Self-timer		Can be selected from 10 s and 2 s

Built-in flash	
Range (approx.) (ISO sensitivity: Auto)	[W]: 0.5 - 7.5 m (1 ft 8 in. - 24 ft) [T]: 1.5 - 4.0 m (5 - 13 ft)
Flash control	TTL auto flash with monitor preflashes
Flash exposure compensation	In steps of 1/3 EV in the range between -2 and +2 EV
Interface	Hi-Speed USB equivalent
Data transfer protocol	MTP, PTP
HDMI output	Can be selected from Auto, 480p, 720p, and 1080i
I/O terminal	<ul style="list-style-type: none"> • Micro-USB connector • HDMI micro connector (Type D) (HDMI output)
Wireless LAN	
Standards	IEEE 802.11b/g (standard wireless LAN protocol) ARIB STD-T66 (standard for low power data communication systems)
Communications protocols	IEEE 802.11b: DBPSK/DQPSK/CCK IEEE 802.11g: OFDM
Range (line of sight)	Approx. 10 m (11 yd)
Operating frequency	2412-2462 MHz (1-11 channels)
Security	OPEN/WPA2
Access protocols	CSMA/CA
Supported languages	Arabic, Bengali, Bulgarian, Chinese (Simplified and Traditional), Czech, Danish, Dutch, English, Finnish, French, German, Greek, Hindi, Hungarian, Indonesian, Italian, Japanese, Korean, Marathi, Norwegian, Persian, Polish, Portuguese (European and Brazilian), Romanian, Russian, Serbian, Spanish, Swedish, Tamil, Telugu, Thai, Turkish, Ukrainian, Vietnamese
Power sources	<ul style="list-style-type: none"> • One Rechargeable Li-ion Battery EN-EL23 (included) • AC Adapter EH-67A (available separately)
Charging time	Approx. 3 h (when using Charging AC Adapter EH-71P and when no charge remains)
Battery life¹	
Still pictures	Approx. 330 shots when using EN-EL23
Movie recording (actual battery life for recording) ²	Approx. 1 h 20 min when using EN-EL23

Tripod socket	1/4 (ISO 1222)
Dimensions (W × H × D)	Approx. 125.0 × 85.0 × 106.5 mm (5.0 × 3.4 × 4.2 in.) (excluding projections)
Weight	Approx. 565 g (1 lb 4 oz) (including battery and SD memory card)
Operating environment	
Temperature	0°C - 40°C (32°F - 104°F)
Humidity	85% or less (no condensation)

- Unless otherwise stated, all figures assume a fully-charged battery and an ambient temperature of 23 ±3°C (73.4 ±5.4°F) as specified by the Camera and Imaging Products Association (CIPA).
- ¹ Battery life may vary depending on conditions of use, such as the interval between shots or the length of time that menus and images are displayed.
 - ² Individual movie files cannot exceed 4 GB in size or 29 minutes in length. Recording may end before this limit is reached if camera temperature becomes elevated.

Rechargeable Li-ion Battery EN-EL23

Type	Rechargeable lithium-ion battery
Rated capacity	DC 3.8 V, 1850 mAh
Operating temperature	0°C - 40°C (32°F - 104°F)
Dimensions (W × H × D)	Approx. 34.9 × 47 × 10.5 mm (1.4 × 1.9 × 0.5 in.)
Weight	Approx. 34 g (1.2 oz)

Charging AC Adapter EH-71P

Rated input	AC 100 - 240 V, 50/60 Hz, MAX 0.2 A
Rated output	DC 5.0 V, 1.0 A
Operating temperature	0°C - 40°C (32°F - 104°F)
Dimensions (W × H × D)	Approx. 55 × 22 × 54 mm (2.2 × 0.9 × 2.2 in.) (excluding plug adapter) For Argentina: Approx. 55 × 63 × 59 mm (2.2 × 2.5 × 2.4 in.) For Brazil and Korea: Approx. 55 × 67 × 59 mm (2.2 × 2.7 × 2.4 in.)
Weight	Approx. 48 g (1.7 oz) (excluding plug adapter) For Argentina: Approx. 73 g (2.6 oz) For Brazil and Korea: Approx. 70 g (2.5 oz)

Specifications

- Nikon will not be held liable for any errors this manual may contain.
- The appearance of this product and its specifications are subject to change without notice.

AVC Patent Portfolio License

This product is licensed under the AVC Patent Portfolio License for the personal and non-commercial use of a consumer to (i) encode video in compliance with the AVC standard ("AVC video") and/or (ii) decode AVC video that was encoded by a consumer engaged in a personal and non-commercial activity and/or was obtained from a video provider licensed to provide AVC video. No license is granted or shall be implied for any other use. Additional information may be obtained from MPEG LA, L.L.C.

See <http://www.mpegla.com>.

FreeType License (FreeType2)

Portions of this software are copyright © 2012 The FreeType Project (<http://www.freetype.org>). All rights reserved.

MIT License (HarfBuzz)

Portions of this software are copyright © 2014 The HarfBuzz Project (<http://www.freedesktop.org/wiki/Software/HarfBuzz>). All rights reserved.

Trademark Information

















- Microsoft, Windows and Windows Vista are either registered trademarks or trademarks of Microsoft Corporation in the United States and/or other countries.
- Mac, OS X, the iFrame logo and the iFrame symbol are trademarks or registered trademarks of Apple Inc., in the U.S. and other countries.
- Adobe and Acrobat are registered trademarks of Adobe Systems Inc.
- SDXC, SDHC and SD Logos are trademarks of SD-3C, LLC.
- PictBridge is a trademark.
- HDMI, HDMI logo and High-Definition Multimedia Interface are trademarks or registered trademarks of HDMI Licensing LLC.

HDMI

- Wi-Fi and the Wi-Fi logo are trademarks or registered trademarks of the Wi-Fi Alliance.
- Android and Google Play are trademarks or registered trademarks of Google, Inc.
- All other trade names mentioned in this manual or the other documentation provided with your Nikon product are trademarks or registered trademarks of their respective holders.











Index

Symbols







- A** Aperture-priority auto mode 52, 54
-  Apply selection button 5
-  Auto mode 30, 39
-  Delete button 37, 94, 6, 51
- DISP** Display button 10
-  Flash mode 59, 60
-  Flash pop-up button 60
-  Focus mode 59, 65
- Fn** Function button 4
-  Landscape mode 42
- M** Manual mode 52, 54
- MENU** Menu button 12, 72, 86, 93, 95
-  Monitor button 9
-  Movie mode 89
-  Night landscape mode 41
-  Night portrait mode 42
-  Playback button 4, 5, 36, 93
-  Playback zoom 84
- P** Programmed auto mode 52, 54
- SCENE** Scene mode 40
-  Self-timer/Smile timer 59, 63, 64
- S** Shutter-priority auto mode 52, 54
- EFFECTS** Special effects mode 50
- T** (Telephoto) 33
-  Thumbnail display 85
- U** (User settings) mode 57

- W** (Wide-angle) 33
- .JPG 81
- .MOV 81
- .WAV 81

A

- AC adapter 100, 82
- Active D-Lighting 73, 42
- AF area mode 73, 75, 38
- AF assist 95, 66
- Aperture value 52
- Aperture-priority auto mode 52, 54
- Assign side zoom control 95, 68
- Auto 61
- Auto off 27, 96, 69
- Auto with red-eye reduction 61, 62
- Autofocus 66, 73, 82, 93, 41, 57
- Autofocus mode 66, 73, 93, 41, 57

B

- Backlighting  46
- Battery 20, 18
- Battery charger 82
- Battery level indicator 26
- Battery-chamber/memory card slot cover 20, 24
- Best Shot Selector 45, 33
- Bird-watching  49
- Black and white copy  45
- Blink warning 96, 74

Brightness..... 95, 63
 BSS..... 45, 33
 Button sound..... 69

C

Calendar display 85
 Charge by computer 96, 72
 Charging AC adapter 22, 20
 Choose key picture 87, 53
 Close-up 44
 Color temperature..... 29
 Command dial..... 3, 5, 52
 Computer..... 101, 103
 Continuous 73, 75, 32
 Contrast..... 25
 COOLPIX Custom Picture Control
 72, 27
 COOLPIX Picture Control
 72, 75, 23
 Copy 87, 52
 Crop..... 84, 12
 Cross process..... 51
 Custom Picture Control
 72, 27

D

Date and time 28, 95, 61
 Daylight saving time 28, 62
 Delete..... 37, 94, 6, 51
 Digital zoom..... 33, 95, 67
 Diopter adjustment control 9
 Direct Print 101, 14
 D-Lighting 86, 8
 DPOF printing 18
 DSCN..... 81
 Dynamic Fine Zoom..... 33































E

Easy panorama 47, 2
 Editing movies..... 19
 Editing still images..... 7
 Exposure bracketing..... 73, 37
 Exposure compensation..... 59, 69
 Exposure mode 52
 Extension 81
 Extracting still images..... 20
 Eye-Fi upload 96, 75
 Eyelet for camera strap 7

































F

Face detection 81
 Face priority 38
 Fast motion movies
 55, 56
 File name..... 81
 Fill flash 61
 Filter effects..... 86, 10, 25
 Fireworks show 45
 Firmware version 96, 76
 Flash..... 59, 60
 Flash exp. comp. 73, 41
 Flash mode..... 59, 60
 Fn button setting 75
 Focal length..... 74, 45, 16
 Focus..... 34, 80, 91,
38, 41, 57
 Focus area
 16, 34, 48, 80, 38
 Focus indicator 15, 34
 Focus lock 83
 Focus mode..... 59, 65
 Food 45
 Format 24, 96, 70

- Format memory cards
 24, 96, 70
- Format the internal memory
 96, 70
- Frame rate..... 93, 57
- FSCN..... 81
- Full-frame playback
 17, 36, 84, 85
- Full-time AF
 73, 93, 41, 57
- Functions that cannot be used
 simultaneously..... 76
- H**
- Hand strap..... 82
- HDMI..... 71
- HDMI device control..... 71
- HDMI micro connector..... 13
- HDR..... 46
- High ISO monochrome..... 51
- High key..... 50
- High-contrast monochrome..... 50
- High-speed continuous..... 32
- Histogram..... 18, 69, 95, 63
- HS movie..... 55, 56
- I**
- Identifier..... 81
- Image copy..... 87, 52
- Image quality..... 72, 75, 21
- Image selection screen..... 88
- Image sharpening..... 25
- Image size..... 72, 75, 22
- Infinity..... 66
- Internal memory indicator..... 26
- Interval timer shooting
 33, 34
- ISO sensitivity..... 73, 75, 36
- L**
- Language..... 96, 70
- Lens..... 6, 16
- Lens cap..... 7
- Li-ion rechargeable battery
 20, 20
- Low key..... 50
- M**
- M exposure preview..... 74, 46
- Macro close-up..... 66
- Manual focus..... 66, 67
- Manual mode..... 52, 54
- Memory capacity..... 26, 89
- Memory card..... 24, 25
- Memory card slot..... 24
- Metering..... 73, 75, 31
- Microphone..... 89, 51
- Micro-USB connector
 100, 103, 14
- Minimum shutter speed..... 36
- Mode dial..... 30
- Monitor..... 8, 10, 14, 6
- Monitor settings..... 95, 63
- Moon 49
- Motion detection..... 95, 66
- Movie length..... 90
- Movie menu..... 93, 54
- Movie mode..... 89
- Movie options..... 93, 54
- Movie playback..... 93
- Movie recording..... 89
- Movie recording time remaining
 89, 90
- Multi selector..... 3, 5, 59
- Multiple exposure..... 73, 43
- Multi-shot 16..... 33

Museum 	45	Quick retouch	86, 
N		R	
Noise reduction filter	73, 	Rear-curtain sync	61
Nostalgic sepia	50	Rechargeable battery	22
Number of exposures remaining	26, 	Red-eye reduction	61, 62
O		Reset all	96, 
Optical zoom	33	Reset file numbering	96, 
Optional accessories		Reset user settings	58
P		Rotary multi selector	3, 5, 59
Painting	50	Rotate image	86, 
Party/indoor 	44	RSCN	
Peaking	96, 	S	
Pet portrait 	48	Saturation	
PictBridge	101, 	Save user settings	58
Picture Control	72, 75, 	Scene auto selector 	43
Playback	36, 93, 	Scene mode	40
Playback menu	86	Selecting images	88
Playback mode	36	Selective color	51
Playback zoom	84	Self-timer	59, 63
Power	26, 28	Self-timer lamp	63, 64
Power switch/power-on lamp	1	Sequence	38, 
Preset manual		Sequence display options	
Pre-shooting cache			87, 
		Setup menu	95, 
Pressing halfway	4, 34, 35	Shooting	30, 89
Print		Shooting information	10, 14
Print date	95, 	Shooting menu	72, 
Print order	86, 	Shooting mode	31, 93
Print order date option		Shutter sound	
Printer	100, 	Shutter speed	52, 56
Programmed auto mode	52, 54	Shutter-priority auto mode	52, 54
Protect	86, 	Shutter-release button	4, 6, 34, 35
Q		Side zoom control	4
Quick adjust		Single	73, 

Refer to the *Reference Manual* for pages indicated with .

- Single AF... 73, 93, 41, 57
 Skin softening..... 82, 86, 
 Slide show 86, 
 Slow motion movies
 55, 56
 Slow sync 61
 Small picture 86, 
 Smile timer 59, 64
 Soft 50
 Sound settings..... 95, 
 Special effects mode..... 50
 Specialized menu for **U** 57
 Sports  43
 SSCN..... 
 Standard flash..... 61
 Startup zoom position
 74, 
 Subject tracking..... 39, 
 Switching among tabs 13
- I**
- Target finding AF..... 80, 
 Telephoto 33
 Thumbnail display 85
 Time difference 
 Time zone 28, 
 Time zone and date
 28, 95, 
 Toggle Av/Tv selection
 96, 
 Tone level..... 18
 Tone level information 11, 18
 Toning..... 
 TV 100, 
 TV settings 96, 
- U**
- USB cable 101, 103, 
- User settings mode 57
- V**
- Vibration reduction
 75, 95, 
 View grid 
 View/hide framing grid
 16, 
 Viewfinder 9, 32, 
 ViewNX 2..... 102
 Voice memo 86, 
 Volume 93, 
- W**
- Welcome screen 95, 
 White balance..... 72, 75, 
 Wide-angle 33
 Wi-Fi options 97, 
 Wi-Fi options menu 98, 
 Wireless LAN..... 97
- Z**
- Zoom..... 33
 Zoom control..... 5, 33
 Zoom memory 74, 



A series of horizontal dashed lines spanning the width of the page, intended for handwriting practice.



A series of horizontal dashed lines spanning the width of the page, intended for handwriting practice.

No reproduction in any form of this manual, in whole or in part (except for brief quotation in critical articles or reviews), may be made without written authorization from NIKON CORPORATION.

Please visit the Nikon website below to download the *Reference Manual* in English.

संदर्भ मैनुअल को हिंदी में डाउनलोड करने के लिए नीचे दी गई Nikon वेबसाइट पर जाएँ।

অনুগ্রহ করে বাংলায় রেফারেন্স পুস্তিকা ডাউনলোড করতে নিচে Nikon ওয়েবসাইটে যান।

தமிழில் சரிபார்ப்புக் கையேட்டைப் பதிவிறக்குவதற்கு, தயவுசெய்து கீழுள்ள Nikon வலைத்தளத்துக்குச் செல்லவும்.

मराठीत संदर्भ सूचना-पुस्तिका डाउनलोड करण्यासाठी कृपया खालील Nikon वेबसाईटला भेट द्या.

తెలుగులో అన్వయ మార్గదర్శక పుస్తకం డౌన్లోడ్ చేసుకునేందుకు దయచేసి Nikon వెబ్సైట్ సందర్శించండి.

<http://nikonimglib.com/manual/>