

Nikon

DIGITAL CAMERA

COOLPIX P1000

Reference Manual



Quick Topic Search

- Read this manual thoroughly before using the camera.
- To ensure proper use of the camera, be sure to read "For Your Safety" (page vi).
- Be sure to read "Do Not Point the Lens at the Sun" (page 190) in "Caring for the Product."
- After reading this manual, keep it in a readily accessible place for future reference.

En

Quick Topic Search

You can return to this page by tapping or clicking  in the lower right of any page.

Main Topics

Introduction	iii
Table of Contents	x
Parts of the Camera	1
Getting Started.....	14
Basic Shooting and Playback Operations	21
Shooting Features.....	30
Playback Features.....	79
Movies	89
Connecting the Camera to a TV, Printer, or Computer	102
Using the Menu.....	112
Technical Notes.....	185

Common Topics



For Your Safety



Manual Focus



Tips for Setting Exposure



Remote Control



Functions of the Controls



Functions That Cannot Be Used Simultaneously



Troubleshooting



Index



Introduction

Read This First

Thank you for purchasing the Nikon COOLPIX P1000 digital camera.

Symbols and Conventions Used in This Manual

- Tap or click  in the lower right of each page to display “Quick Topic Search” (ii).
- Symbols

Symbol	Description
	This icon marks cautions and information that should be read before using the camera.
	This icon marks notes and information that should be read before using the camera.
	This icon marks other pages containing relevant information.

- SD, SDHC, and SDXC memory cards are referred to as “memory cards” in this manual.
- Smartphones and tablets are referred to as “smart devices.”
- The setting at the time of purchase is referred to as the “default setting.”
- The names of menu items displayed on the camera screen, and the names of buttons or messages displayed on a computer screen appear in bold.
- In this manual, images are sometimes omitted from screen display samples so that screen indicators can be more clearly shown.



Information and Precautions

Life-Long Learning

As part of Nikon's "Life-Long Learning" commitment to ongoing product support and education, continually updated information is available online at the following websites:

- For users in the U.S.A.: <http://www.nikonusa.com/>
- For users in Europe: <http://www.europe-nikon.com/support/>
- For users in Asia, Oceania, the Middle East, and Africa: <http://www.nikon-asia.com/>

Visit these websites to keep up-to-date with the latest product information, tips, answers to frequently asked questions (FAQs), and general advice on digital imaging and photography. Additional information may be available from the Nikon representative in your area. Visit the website below for contact information.

<http://imaging.nikon.com/>

Use Only Nikon Brand Electronic Accessories

Nikon COOLPIX cameras are designed to the highest standards and include complex electronic circuitry. Only Nikon brand electronic accessories (including battery chargers, batteries, AC adapters, and USB cables) certified by Nikon specifically for use with this Nikon digital camera are engineered and proven to operate within the operational and safety requirements of this electronic circuitry.

THE USE OF NON-NIKON ELECTRONIC ACCESSORIES COULD DAMAGE THE CAMERA AND MAY VOID YOUR NIKON WARRANTY.

The use of third-party rechargeable Li-ion batteries not bearing the Nikon holographic seal could interfere with normal operation of the camera or result in the batteries overheating, igniting, rupturing, or leaking.

Holographic seal: Identifies this device as an authentic Nikon product.



For more information about Nikon brand accessories, contact a local authorized Nikon dealer.

Before Taking Important Pictures

Before taking pictures on important occasions (such as at weddings or before taking the camera on a trip), take a test shot to ensure that the camera is functioning normally. Nikon will not be held liable for damages or lost profits that may result from product malfunction.



About the Manuals

- No part of the manuals included with this product may be reproduced, transmitted, transcribed, stored in a retrieval system, or translated into any language in any form, by any means, without Nikon's prior written permission.
- Illustrations and screen content shown in this manual may differ from the actual product.
- Nikon reserves the right to change the specifications of the hardware and software described in these manuals at any time and without prior notice.
- Nikon will not be held liable for any damages resulting from the use of this product.
- While every effort was made to ensure that the information in these manuals is accurate and complete, we would appreciate it were you to bring any errors or omissions to the attention of the Nikon representative in your area (address provided separately).

Comply with Copyright Notices

Under copyright law, photographs or recordings of copyrighted works made with the camera can not be used without the permission of the copyright holder. Exceptions apply to personal use, but note that even personal use may be restricted in the case of photographs or recordings of exhibits or live performances.

Disposing of Data Storage Devices

Please note that deleting images or formatting data storage devices such as memory cards does not completely erase the original image data. Deleted files can sometimes be recovered from discarded storage devices using commercially available software, potentially resulting in the malicious use of personal image data. Ensuring the privacy of such data is the user's responsibility.

Before discarding a data storage device or transferring ownership to another person, make sure to reset all of the camera's settings in **Reset all** in the setup menu (📖113) or **Restore default settings** in the network menu (📖113). After resetting, erase all data in the device using commercial deletion software, or format the device in **Format card** in the setup menu (📖113), then completely refill it with images containing no private information (for example, images of empty sky).

Care should be taken to avoid injury or damage to property when physically destroying memory cards.



For Your Safety

To prevent damage to property or injury to yourself or to others, read "For Your Safety" in its entirety before using this product.

Keep these safety instructions where all those who use this product will read them.



DANGER

Failure to observe the precautions marked with this icon carries a high risk of death or severe injury.



WARNING

Failure to observe the precautions marked with this icon could result in death or severe injury.



CAUTION

Failure to observe the precautions marked with this icon could result in injury or property damage.



WARNING

- **Do not use while walking or operating a vehicle.** Failure to observe this precaution could result in accidents or other injury.
- **Do not disassemble or modify this product. Do not touch internal parts that become exposed as the result of a fall or other accident.** Failure to observe these precautions could result in electric shock or other injury.
- **Should you notice any abnormalities such as the product producing smoke, heat, or unusual odors, immediately disconnect the battery or power source.** Continued operation could result in fire, burns or other injury.
- **Keep dry. Do not handle with wet hands. Do not handle the plug with wet hands.** Failure to observe these precautions could result in fire or electric shock.
- **Do not let your skin remain in prolonged contact with this product while it is on or plugged in.** Failure to observe this precaution could result in low-temperature burns.
- **Do not use this product in the presence of flammable dust or gas such as propane, gasoline or aerosols.** Failure to observe this precaution could result in explosion or fire.
- **Do not aim the flash at the operator of a motor vehicle.** Failure to observe this precaution could result in accidents.



- **Keep this product out of reach of children.** Failure to observe this precaution could result in injury or product malfunction. In addition, note that small parts constitute a choking hazard. Should a child swallow any part of this product, seek immediate medical attention.

- **Do not entangle, wrap or twist the straps around your neck.** Failure to observe this precaution could result in accidents.

- **Do not use batteries, chargers, AC adapters, or USB cables not specifically designated for use with this product. When using batteries, chargers, AC adapters, and USB cables designated for use with this product, do not:**
 - **Damage, modify, forcibly tug or bend the cords or cables, place them under heavy objects, or expose them to heat or flame.**
 - **Use travel converters or adapters designed to convert from one voltage to another or with DC-to-AC inverters.**

Failure to observe these precautions could result in fire or electric shock.

- **Do not handle the plug when charging the product or using the AC adapter during thunderstorms.** Failure to observe this precaution could result in electric shock.
- **Do not handle with bare hands in locations exposed to extremely high or low temperatures.** Failure to observe this precaution could result in burns, or frostbite.



CAUTION

- **Do not leave the lens pointed at the sun or other strong light sources.** Light focused by the lens could cause fire or damage to product's internal parts. When shooting backlit subjects, keep the sun well out of the frame. Sunlight focused into the camera when the sun is close to the frame could cause fire.
- **Turn this product off when its use is prohibited. Disable wireless features when the use of wireless equipment is prohibited.** The radio-frequency emissions produced by this product could interfere with equipment onboard aircraft or in hospitals or other medical facilities.
- **Remove the battery and disconnect the AC adapter if this product will not be used for an extended period.** Failure to observe this precaution could result in fire or product malfunction.



- **Do not touch moving parts of the lens or other moving parts.** Failure to observe this precaution could result in injury.
- **Do not fire the flash in contact with or in close proximity to the skin or objects.** Failure to observe this precaution could result in burns or fire.
- **Do not raise the built-in flash when using a flash unit mounted on the camera accessory shoe.** Failure to observe this precaution could result in fire or damage to the product.
- **Do not leave the product where it will be exposed to extremely high temperatures, for an extended period such as in an enclosed automobile or in direct sunlight.** Failure to observe this precaution could result in fire or product malfunction.
- **Do not transport the camera with a tripod or similar accessory attached.** Failure to observe this precaution could result in injury or product malfunction.



DANGER for Batteries

- **Do not mishandle batteries.** Failure to observe the following precautions could result in the batteries leaking, overheating, rupturing, or catching fire:
 - Use only rechargeable batteries approved for use in this product.
 - Do not expose batteries to flame or excessive heat.
 - Do not disassemble.
 - Do not short-circuit the terminals by touching them to necklaces, hairpins, or other metal objects.
 - Do not expose batteries or the products in which they are inserted to powerful physical shocks.
- **Charge only as indicated.** Failure to observe this precaution could result in the batteries leaking, overheating, rupturing, or catching fire.
- **If battery liquid comes into contact with the eyes, rinse with plenty of clean water and seek immediate medical attention.** Delaying action could result in eye injuries.





WARNING for Batteries

- **Keep batteries out of reach of children.** Should a child swallow a battery, seek immediate medical attention.
- **Do not immerse batteries in water or expose to rain.** Failure to observe this precaution could result in fire or product malfunction. Immediately dry the product with a towel or similar object should it become wet.
- **Discontinue use immediately should you notice any changes in the batteries, such as discoloration or deformation. Cease charging if they do not charge in the specified period of time.** Failure to observe these precautions could result in the batteries leaking, overheating, rupturing, or catching fire.
- **When batteries are no longer needed, insulate the terminals with tape.** Overheating, rupture, or fire may result should metal objects come into contact with the terminals.
- **If battery liquid comes into contact with a person's skin or clothing, immediately rinse the affected area with plenty of clean water.** Failure to observe this precaution could result in skin irritation.



Table of Contents

Quick Topic Search	ii
Main Topics.....	ii
Common Topics	ii
Introduction	iii
Read This First	iii
Symbols and Conventions Used in This Manual	iii
Information and Precautions.....	iv
For Your Safety	vi
Parts of the Camera	1
The Camera Body.....	2
Principle Functions of the Controls.....	5
The Monitor/Viewfinder	8
Switching the Information Displayed on the Screen (DISP Button).....	8
For Shooting.....	9
For Playback.....	12
Getting Started.....	14
How to Attach the Camera Strap	15
How to Attach the Lens Cap and Lens Hood.....	15
Inserting the Battery and Memory Card.....	16
Removing the Battery or Memory Card.....	16
Charging the Battery	17
Opening the Monitor	18
Camera Setup.....	19
Basic Shooting and Playback Operations	21
Shooting Images.....	22
Using the Built-in Flash	25
How to Attach the BS-1 Accessory Shoe Cover (Available Separately)	25
Recording Movies	25
Switching Between the Monitor and Viewfinder.....	26
Playing Back Images	27
Deleting Images	28
The Image Selection Screen for Deletion	29



Shooting Features.....	30
Selecting a Shooting Mode.....	31
📷 (Auto) Mode.....	32
Scene Mode (Shooting Suited to the Shooting Conditions)	33
Tips and Notes About Scene Mode.....	34
Shooting with Easy Panorama.....	41
Playback with Easy Panorama.....	43
Creative Mode (Applying Effects When Shooting).....	44
P, S, A, and M Modes (Setting the Exposure for Shooting)	46
Tips for Setting Exposure.....	47
The Control Range of the Shutter Speed (P, S, A, and M Modes).....	49
Shooting with the Bulb Setting or Time Setting (When in M Mode)	50
U (User Settings) Mode.....	52
Saving Settings in U Mode (Save User Settings).....	53
Setting Shooting Functions with the Multi Selector	54
Flash Mode.....	55
Self-timer	58
Smile Timer (Shooting Smiling Faces Automatically).....	60
Using Autofocus.....	61
Selecting the Focus Mode.....	61
The Shutter-release Button.....	62
Using Target Finding AF	63
Using Face Detection.....	64
Using Skin Softening.....	65
Subjects Not Suitable for Autofocus.....	65
Focus Lock.....	66
Using Manual Focus.....	67
Exposure Compensation (Adjusting Brightness).....	69
Using the Fn (Function) Button	70
Using the Zoom.....	71
Default Settings (Flash, Self-timer, and Focus Mode).....	73
Functions That Cannot Be Used Simultaneously When Shooting.....	75
Playback Features.....	79
Playback Zoom.....	80
Thumbnail Playback/Calendar Display.....	81
Viewing and Deleting Images Captured Continuously (Sequence).....	82
Viewing Images in a Sequence.....	82
Deleting Images in a Sequence	83
Editing Images (Still Images).....	83
Before Editing Images.....	83



Quick Retouch: Enhancing Contrast and Saturation	84
D-Lighting: Enhancing Brightness and Contrast	84
Skin Softening: Softening Skin Tones	85
Filter Effects: Applying Digital Filter Effects.....	86
Small Picture: Reducing the Size of an Image	87
Crop: Creating a Cropped Copy.....	88
Movies	89
Basic Operations of Movie Recording and Movie Playback.....	90
Capturing Still Images While Recording Movies	93
Movie Manual (Setting the Exposure for Movie Recording)	94
Shooting Time-lapse Movies.....	96
Recording Superlapse Movies.....	98
Operations During Movie Playback	99
Editing Movies	100
Extracting Only the Desired Portion of a Movie	100
Saving a Frame from a Movie as a Still Image	101
Connecting the Camera to a TV, Printer, or Computer	102
Utilizing Images.....	103
Viewing Images on a TV	104
Printing Images Without a Computer	105
Connecting the Camera to a Printer	105
Printing Images One at a Time	106
Printing Multiple Images	107
Transferring Images to a Computer (NX Studio)	109
Installing NX Studio	109
Copying pictures to a computer using NX Studio	109
Using the Menu.....	112
Menu Operations.....	113
The Image Selection Screen.....	115
Menu Lists	116
The Shooting Menu.....	116
The Movie Manual Mode Menu.....	117
The Movie Menu.....	117
The Playback Menu	118
The Network Menu	118
The Setup Menu	119
The Shooting Menu (The Common Shooting Options).....	121
Image Quality	121
Image Size.....	123



The Shooting Menu (P, S, A, or M Mode)	124
Picture Control (COOLPIX Picture Control)	124
Custom Picture Control (COOLPIX Custom Picture Control)	128
White Balance (Adjusting Hue)	129
Metering	132
Continuous Shooting	133
ISO Sensitivity	137
Exposure Bracketing	139
AF Area Mode	140
Autofocus Mode	143
Flash Exp. Comp.	143
Noise Reduction Filter	144
Active D-Lighting	144
Multiple Exposure	145
Zoom Memory	147
Startup Zoom Position	148
M Exposure Preview	148
The Movie Manual Mode Menu	149
The Movie Menu	150
Movie Options	150
Autofocus Mode	153
Electronic VR	154
Wind Noise Reduction	154
Zoom Microphone	155
Frame Rate	155
External Mic Sensitivity	156
The Playback Menu	157
Mark for Upload	157
Slide Show	158
Protect	159
Rotate Image	159
Sequence Display Options	160
Choose Key Picture	160
The Network Menu	161
Operating the Text Input Keyboard	163
The Setup Menu	164
Time Zone and Date	164
Slot Empty Release Lock	166
Monitor Settings	167
EVF Auto Toggle (Automatically Switching the Display to the Viewfinder)	169
Date Stamp	169
Self-timer: After Release	170



Vibration Reduction.....	171
AF Assist.....	172
Digital Zoom.....	172
Assign Side Zoom Control.....	173
Snap-back Zoom.....	173
Control Ring Options.....	174
AE/AF Lock Button.....	175
Sound Settings.....	175
Auto Off.....	176
Format Card.....	176
Language.....	176
HDMI.....	177
Charge by Computer.....	179
Image Comment.....	180
Copyright Information.....	181
Location Data.....	182
Toggle Av/Tv Selection.....	182
Reset File Numbering.....	183
Peaking.....	184
Reset All.....	184
Firmware Version.....	184
<hr/>	
Technical Notes.....	185
Notices.....	186
Notes About Wireless Communication Functions.....	188
Caring for the Product.....	190
The Camera.....	190
The Battery.....	191
The Charging AC Adapter.....	193
Memory Cards.....	193
Cleaning and Storage.....	195
Cleaning.....	195
Storage.....	195
Error Messages.....	196
Troubleshooting.....	199
File Names.....	208
Optional Accessories.....	209
Speedlights (External Flash Units).....	211
ML-L7 Remote Control.....	213
Specifications.....	218
Memory Cards That Can Be Used.....	223
Index.....	225



Parts of the Camera

The Camera Body	2
Principle Functions of the Controls	5
The Monitor/Viewfinder.....	8



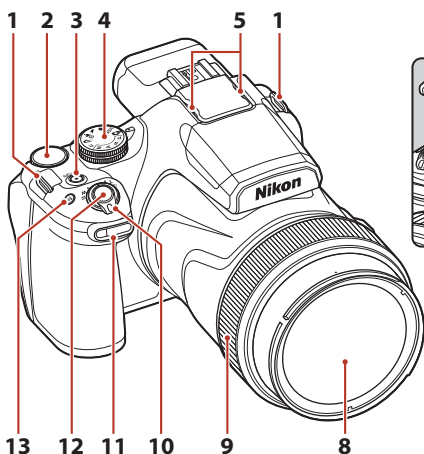

The Camera Body

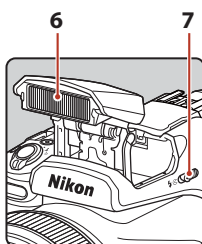

Built-in Flash raised



1	Eyelet for camera strap.....	15	9	Control ring.....	67, 174
2	Command dial.....	46		Zoom control.....	71
3	Power switch/power-on lamp (charge lamp)	17, 19, 24		W : Wide-angle.....	71
4	Mode dial.....	22, 31	10	T : Telephoto	71
5	Microphone (stereo)	90, 155		 : Thumbnail playback	81
6	Built-in flash	25, 55		 : Playback zoom	80
7	 (flash pop-up) control.....	55		Self-timer lamp.....	58
8	Lens		11	Red-eye reduction lamp.....	57
				AF-assist illuminator.....	172
			12	Shutter-release button	24, 62
			13	Fn (function) button.....	70



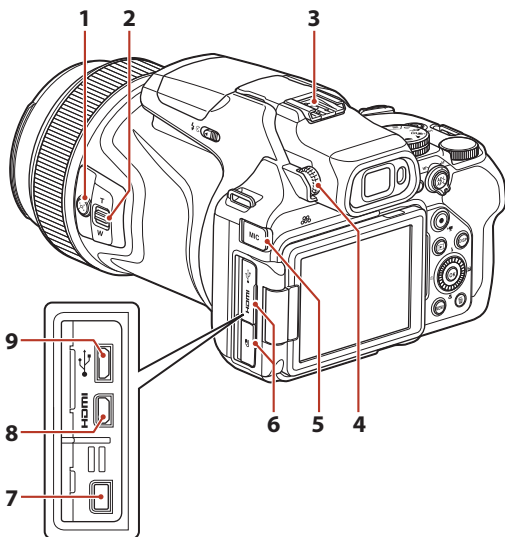

1	☑ (snap-back zoom) button 72	5	External microphone connector cover 210
2	Side zoom control 71	6	Connector cover 17, 103
	W : Wide-angle 71	7	Accessory terminal 210
	T : Telephoto 71	8	HDMI micro connector (Type D) 103
3	Accessory shoe 25, 211	9	Micro-USB connector 17, 103
4	Diopter adjustment control 26		



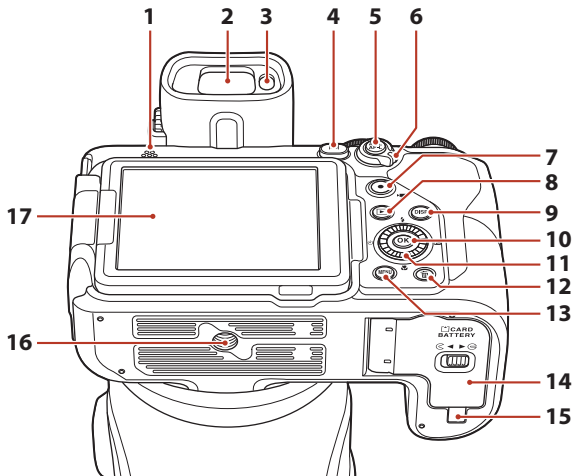







1	Speaker	99, 175	10	OK (apply selection) button	113
2	Electronic viewfinder.....	26	11	Rotary multi selector (multi selector)*	54, 113
3	Eye sensor	26	12	DEL (delete) button	28
4	MON (monitor) button	26	13	MENU (menu) button	113, 116
5	AE-L/AF-L button.....	66, 175	14	Battery-chamber/memory card slot cover.....	16
6	Focus-mode selector.....	61, 67	15	Power connector cover (for optional AC adapter).....	209
7	MOVIE (movie-record) button	25, 90	16	Tripod socket	
8	RECALL (playback) button.....	27	17	Monitor.....	8, 18
9	DISP (display) button.....	8			





* In this manual, the operation of pressing the upper, lower, left, or right part of the multi selector is indicated as ▲, ▼, ◀, or ▶.





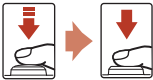





Principle Functions of the Controls

Control	Main Function	
 <p>Mode dial</p>	For shooting	Select a shooting mode (📖31).
 <p>Focus-mode selector</p>	For shooting	Select AF (autofocus) or MF (manual focus).
 <p>AE-L (AE-L/AF-L) button</p>	For shooting	Lock the exposure or focus.
 <p>Zoom control</p>	For shooting	Move toward T (📷) (telephoto) to zoom in closer to the subject, and move toward W (📷) (wide-angle) to zoom out and view a larger area.
	For playback	<ul style="list-style-type: none"> • Move toward T (📷) to zoom in on the image, and move toward W (📷) to display images as thumbnails or the calendar. • Adjust the volume for movie playback.
 <p>📷 (Snap-back zoom) button</p>	For shooting	Widen the angle of view temporarily.
 <p>Side zoom control</p>	For shooting	Use the function assigned in Assign side zoom control . <ul style="list-style-type: none"> • Zoom (default setting): Move toward T (telephoto) to zoom in closer to the subject, and move toward W (wide-angle) to zoom out and view a larger area. • Manual focus: When the focus-mode selector is set to MF, adjust the focus manually.



Control	Main Function	
 <p>Shutter-release button</p>	For shooting	When the button is pressed halfway: Set focus and exposure. When the button is pressed all the way: Release the shutter.
	For playback	Return to shooting mode.
 <p>● (▶) movie-record button</p>	For shooting	Start and stop movie recording.
	For playback	Return to shooting mode.
 <p>Multi selector</p>	For shooting	<ul style="list-style-type: none"> While the shooting screen is displayed: Display the following setting screens by pressing: <ul style="list-style-type: none"> Up (▲): ⚡ (flash mode) Left (◀): ⌚ (self-timer/smiley timer) Down (▼): 🎯 (focus mode)* Right (▶): 📐 (exposure compensation) When the shooting mode is A, M, or M/ (Movie manual): Rotate the multi selector to set the f-number. <p>* Available only when the focus-mode selector is set to AF.</p>
	For playback	<ul style="list-style-type: none"> While the playback screen is displayed: Change the displayed image using up (▲), left (◀), down (▼), right (▶), or by rotating the multi selector. While a zoomed image is displayed: Move the display area.
	For setting	<ul style="list-style-type: none"> Select an item using ▲▼◀▶ or by rotating the multi selector, and then apply the selection by pressing the OK button.
 <p>Ⓞ (apply selection) button</p>	For playback	<ul style="list-style-type: none"> Display individual images of a sequence in full-frame playback mode (📖28). Scroll an image shot with Easy panorama. Play back movies. Switch from thumbnail playback or zoomed image display to full-frame playback.
	For setting	Apply the item that you selected by using the multi selector.



Control	Main Function	
 Command dial	For shooting	<ul style="list-style-type: none"> When the shooting mode is P (📖46): Set the flexible program. When the shooting mode is S, M (📖46), or Manual in *M (Movie manual): Set the shutter speed.
	For playback	Change the magnification rate of a zoomed image.
 Control ring	For shooting	<ul style="list-style-type: none"> When the focus-mode selector is set to AF: Display the setting screen that is selected in Control ring options (📖119).* When the focus-mode selector is set to MF: Adjust the focus manually. * This function is not available with some shooting modes.
 MENU (menu) button	For shooting/ playback	Display or close the menu (📖113).
 Fn (function) button	For shooting	When the shooting mode is P, S, A, M, or U : Display or close the setting menus such as Continuous or Vibration reduction .
 [M] (monitor) button	For shooting/ playback	Switch between the monitor and viewfinder (📖26).
 DISP (display) button	For shooting/ playback	Switch the information displayed on the screen.
 [▶] (playback) button	For shooting	Play back images (📖27).
	For playback	<ul style="list-style-type: none"> When the camera is turned off, press and hold down this button to turn the camera on in playback mode (📖27). Return to shooting mode.
 [🗑️] (delete) button	For shooting	Delete the last image that was saved (📖28).
	For playback	Delete images (📖28).



The Monitor/Viewfinder

The information that is displayed on the shooting or playback screen changes depending on the camera's settings and state of use.

Switching the Information Displayed on the Screen (DISP Button)

To switch the information displayed on the screen during shooting or playback, press the **DISP** (display) button.

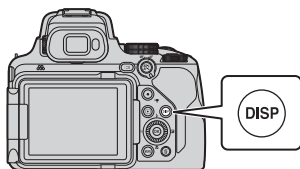

For Shooting

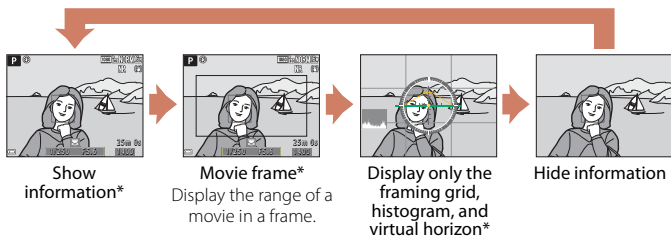

* The framing grid, histogram, and virtual horizon are displayed depending on the settings in **Monitor settings** (167) in the setup menu.

For Playback

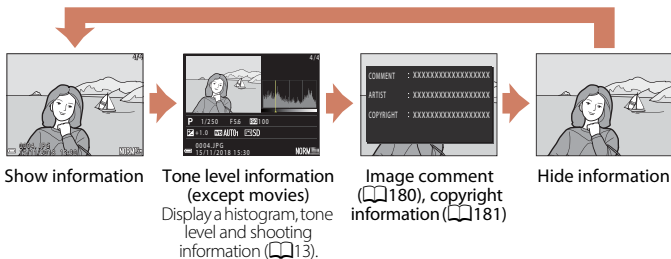

For Shooting

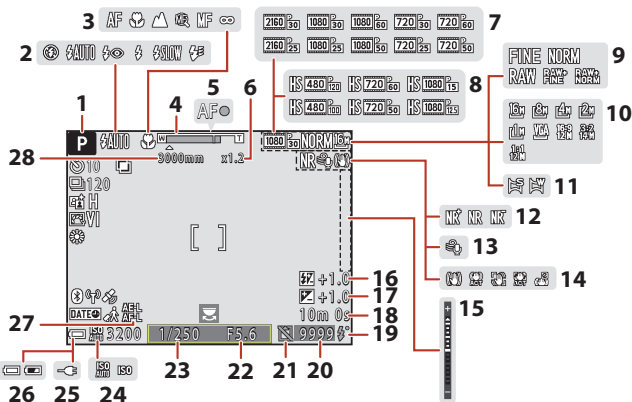

1	Shooting mode	31	16	Flash exposure compensation	143
2	Flash mode	55	17	Exposure compensation value	69
3	Focus mode	61, 67	18	Remaining movie recording time	90, 91
4	Zoom indicator	62, 71	19	Flash-ready indicator	55
5	Focus indicator	24	20	Number of exposures remaining (still images)	22, 122
6	Digital zoom ratio	71	21	Enable release icon (when no memory card is inserted)	166, 201
7	Movie options (normal speed movies)	150	22	F-number	46
8	Movie options (HS movies)	151	23	Shutter speed	46
9	Image quality	121	24	ISO sensitivity	137
10	Image size	123	25	Charging AC Adapter connection indicator	
11	Easy panorama	41	26	Battery level indicator	22
12	Noise reduction filter	144	27	Auto exposure (AE)/Autofocus (AF) lock indicator (still image)	66, 175
13	Wind noise reduction	154	28	Focal length (in 35mm [135] format)	71, 147
14	Vibration reduction icon	171			
15	Exposure indicator	48			



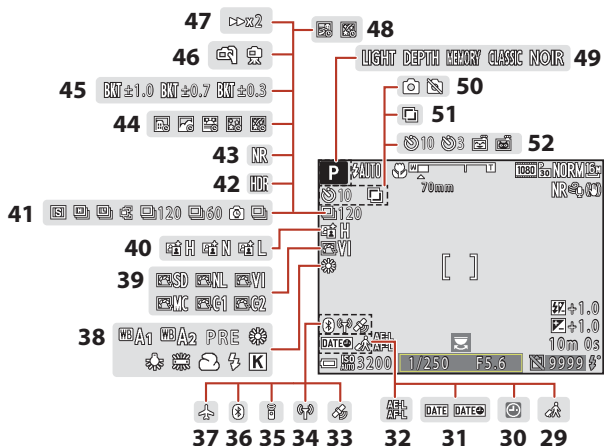

29	Travel destination icon	164	41	Continuous shooting mode	38, 40, 133
30	"Date not set" indicator	164, 200	42	Backlighting (HDR)	37
31	Date stamp	169	43	Noise reduction burst/single shot	34, 36
32	Auto exposure (AE)/Autofocus (AF) lock indicator (movie)	91, 175	44	Time-lapse movie	96
33	Location data	182	45	Exposure bracketing	139
34	Wi-Fi communication indicator	162	46	Hand-held/tripod	35, 36
35	Bluetooth remote control connection indicator	216	47	Playback speed	98
36	Bluetooth communication indicator	162	48	Multiple exp. Lighten	39
37	Airplane mode	161	49	Effect group (creative mode)	44
38	White balance	129	50	Still image capture (during movie recording)	93
39	COOLPIX Picture Control	124	51	Multiple exposure	145
40	Active D-Lighting	144	52	Self-timer indicator	58
				Smile timer	60
				Pet portrait auto release	38



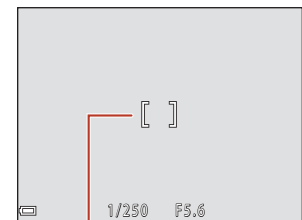

53 54 55 56 57 58

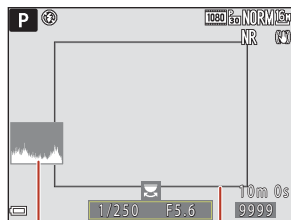

59 60

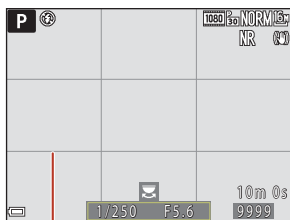

61

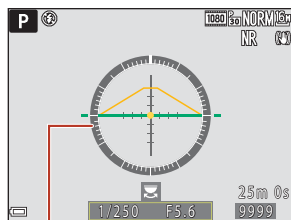

62

- 53** Focus area (target finding AF) 63, 141
- 54** Focus area (center/manual) 33, 66, 140
- 55** Focus area (face detection, pet detection) 38, 60, 64, 140
- 56** Focus area (subject tracking) 141, 142

- 57** Spot metering area 132
- 58** Center-weighted area 132
- 59** View/hide histograms 167
- 60** Framing border (**Moon** or **Bird-watching** mode, or snap-back zoom) 40, 72
- 61** View/hide framing grid 167
- 62** Virtual horizon 167, 168



For Playback

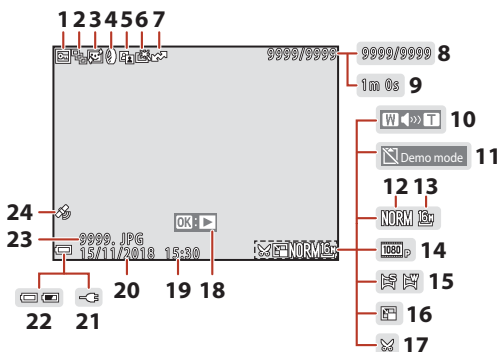

1	Protect icon.....	159	14	Movie options.....	150
2	Sequence display (when Individual pictures is selected).....	160	15	Easy panorama indicator.....	43
3	Skin softening icon.....	85	16	Small picture icon.....	87
4	Filter effects icon.....	86	17	Crop icon.....	88
5	D-Lighting icon.....	84		Easy panorama playback guide.....	43
6	Quick retouch icon.....	84	18	Sequence playback guide.....	82
7	Upload reservation icon.....	157		Movie playback guide.....	90
8	Current image number/total number of images		19	Time of recording	
9	Movie length or elapsed playback time		20	Date of recording	
10	Volume indicator.....	99	21	Charging AC Adapter connection indicator	
11	Enable release icon (when no memory card is inserted).....	166	22	Battery level indicator.....	22
12	Image quality.....	121	23	File number and type.....	208
13	Image size.....	123	24	Recorded location data indicator...	182



Tone Level Information Display

You can check for loss of contrast detail in highlights and shadows from the histogram that is displayed, or the flashing display for each tone level. These provide guidelines when adjusting the image brightness with functions such as exposure compensation.

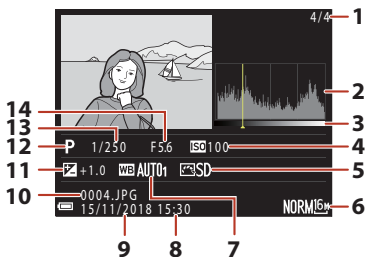

1	Current image number/ total number of images	8	Time of recording 19, 164
2	Histogram ¹	9	Date of recording 19, 164
3	Tone level ²	10	File number and type 208
4	ISO sensitivity 137	11	Exposure compensation value 69
5	COOLPIX Picture Control 124	12	Shooting mode 31
6	Image quality/Image size 121, 123	13	Shutter speed 46
7	White balance 129	14	F-number 46

¹ A histogram is a graph showing the distribution of tones in the image. The horizontal axis corresponds to pixel brightness, with dark tones to the left and bright tones to the right. The vertical axis shows the number of pixels.

² The tone level indicates the brightness level. When the tone level to check is selected using the multi selector ◀▶ or rotating it, the area of the image that corresponds to the selected tone level flashes.



Getting Started

How to Attach the Camera Strap.....	15
How to Attach the Lens Cap and Lens Hood	15
Inserting the Battery and Memory Card.....	16
Charging the Battery	17
Opening the Monitor	18
Camera Setup	19



How to Attach the Camera Strap

Attach the strap to the left and right side of the camera.

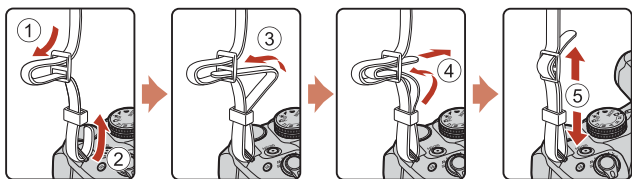

How to Attach the Lens Cap and Lens Hood

- When you are not shooting images, attach the lens cap to protect the lens.
- The lens hood cuts out light which adversely affects the image, and it also helps to protect the camera. Do not use the lens hood when shooting with a flash or when the AF-assist illuminator is necessary for shooting.

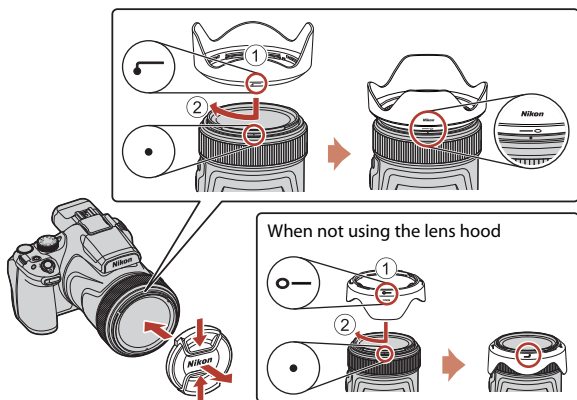

Inserting the Battery and Memory Card

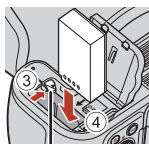
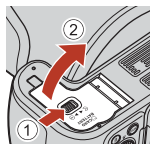

Battery latch

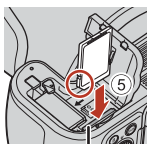

Memory card slot



- With the battery's positive and negative terminals oriented correctly, move the orange battery latch (3), and fully insert the battery (4).
- Slide the memory card in until it clicks into place (5).
- Be careful not to insert the battery or memory card upside-down or backward, as this could cause a malfunction.
- When the write-protect switch on the memory card is in the "lock" position, images cannot be captured or deleted, and the card cannot be formatted.

Formatting a Memory Card

The first time you insert a memory card that has been used in another device into this camera, make sure to format it with this camera.

- **Note that formatting a memory card permanently deletes all images and other data on the memory card.** Be sure to make copies of any images you wish to keep before formatting the memory card.
- Insert the memory card into the camera, press the **MENU** button, and select **Format card** in the setup menu (📖113).

Removing the Battery or Memory Card

Turn the camera off and make sure that the power-on lamp and screen have turned off, and then open the battery-chamber/memory card slot cover.

- Move the battery latch to eject the battery.
- Gently push the memory card into the camera to partially eject the memory card.
- Be careful when handling the camera, battery, and memory card immediately after using the camera, as they may be hot.



Charging the Battery

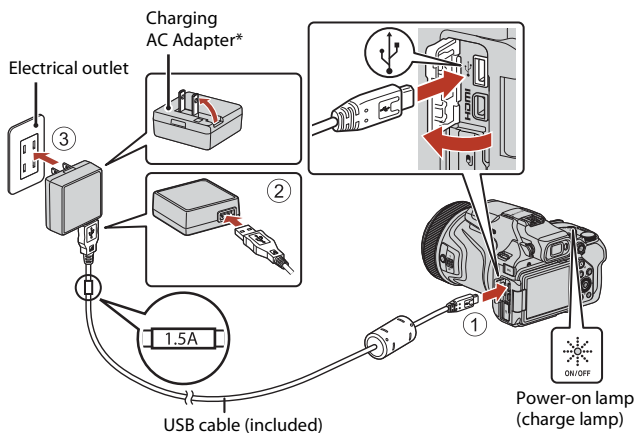

* A plug adapter is attached depending on the country or region of purchase. The shape of the plug adapter varies with the country or region of purchase.

- Charging starts when the camera is connected to an electrical outlet while the battery is inserted, as shown in the illustration. The power-on lamp (charge lamp) slowly flashes while the battery is charging.
- When charging is complete, the power-on lamp turns off. Unplug the Charging AC Adapter from the electrical outlet, and disconnect the USB cable. Charging time is about 3 hours for a fully exhausted battery.
- The battery cannot be charged when the power-on lamp quickly flashes, possibly due to one of the reasons described below.
 - The ambient temperature is not suited to charging.
 - The USB cable or Charging AC Adapter is not properly connected.
 - The battery is damaged.



✓ Notes About the USB Cable

- Do not use a USB cable other than the UC-E21. Using a USB cable other than the UC-E21 could result in overheating, fire or electric shock.
- Check the shape and direction of the plugs and do not insert or remove the plugs at an angle.

✓ Notes About Charging the Battery

- The camera can be operated while the battery is charging, but the charging time increases. The power-on lamp (charge lamp) turns off while the camera is being operated.
- Do not, under any circumstances, use another make or model of AC adapter other than the EH-73P/EH-73PCH Charging AC Adapter, and do not use a commercially available USB-AC adapter or a battery charger for a mobile phone. Failure to observe this precaution could result in overheating or in damage to the camera.

Opening the Monitor

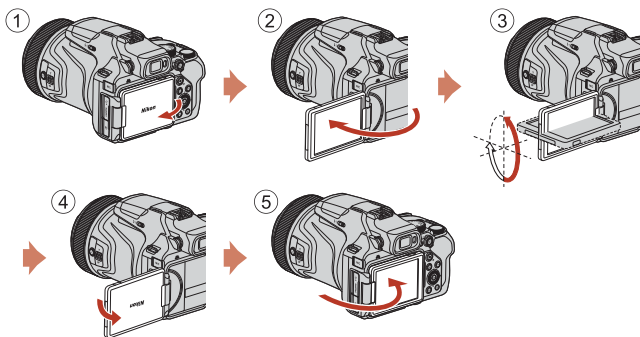

- You can adjust the direction and angle of the monitor. For normal shooting, fold the monitor against the back of the camera, facing out (5).
- When you are not using or carrying the camera, fold the monitor against the camera body with the screen facing in (1).

✓ Notes About the Monitor

- The monitor's adjustable range may be limited when a cable or accessories are attached to the camera.
- When moving the monitor, do not apply excessive force and move slowly within the monitor's adjustable range so that the connection will not be damaged.



Camera Setup

1 Turn the camera on.

- Use the multi selector to select and adjust settings.

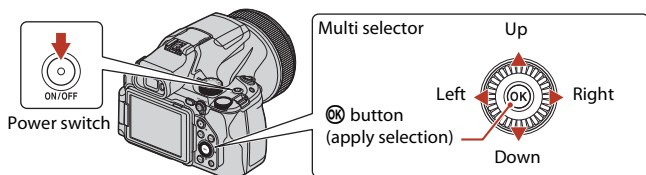

- A language selection dialog will be displayed. Press ▲ or ▼ on the multi selector to highlight a language and press OK to select.
- The language can be changed at any time using the **Language** option in the setup menu (📖113).

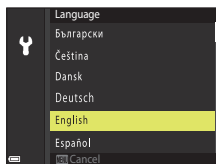

2 Select **Yes** and press OK.

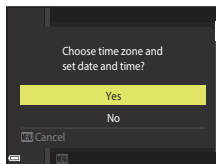

3 Highlight your home time zone and press OK.

- To turn daylight saving time on press ▲; ☀ will be displayed at the top of the map. Press ▼ to turn daylight saving time off.

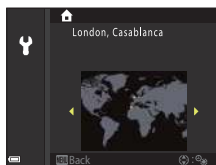

4 Press ▲ or ▼ to choose a date format and press OK.



5 Enter the current date and time and press **OK**.

- Press ◀ or ▶ to highlight items and press ▲ or ▼ to change.
- Select the minute field and press **OK** to confirm the setting.

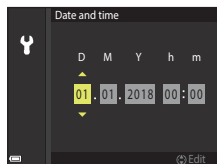

6 When prompted, press ▲ or ▼ to highlight **Yes** and press **OK**.

- The camera exits to the shooting display when setup is complete.

Resetting the Clock

The **Time zone and date** option in the setup menu can be used to choose the time zone and set the camera clock.

Daylight saving time can be turned on or off in the **Time zone** menu.

Using the SnapBridge App

When you establish a wireless connection between the camera and a smart device using the SnapBridge app, you can upload images captured with the camera to the smart device or perform remote photography. See the included "SnapBridge Connection Guide" for the connection procedure.





Basic Shooting and Playback Operations

Shooting Images.....	22
Playing Back Images.....	27
Deleting Images.....	28





Shooting Images

 (auto) mode is used here as an example.  (auto) mode enables you to perform general shooting in a variety of shooting conditions.

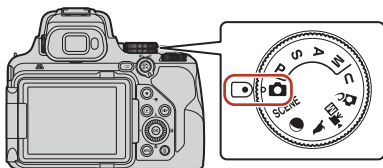
1 Rotate the mode dial to .



Number of exposures remaining

- Battery level indicator
: The battery level is high.
: The battery level is low.
- Press the **DISP** (display) button to switch the information displayed on the screen each time.

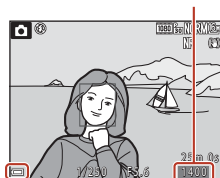

Battery level indicator

2 Hold the camera steady.

- Keep fingers and other objects away from the lens, flash, AF-assist illuminator, microphone, and speaker.

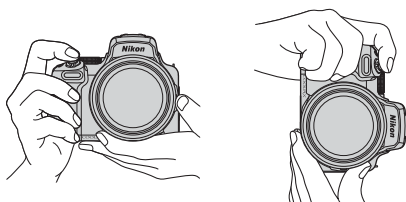

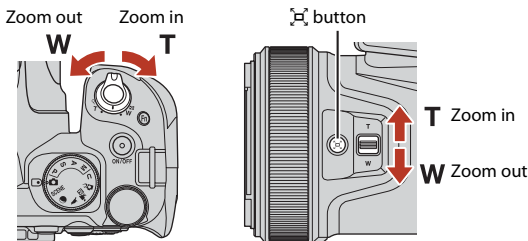

3 Frame the picture.

- Move the zoom control or the side zoom control to change the zoom lens position.
- If you lose sight of the subject while shooting with the lens in telephoto position, press the  (snap-back zoom) button to temporarily widen the visible area so that you can frame the subject more easily.



Using a Tripod

- We recommend using a tripod to stabilize the camera in the following situations:
 - When shooting in dim lighting with the flash mode set to  (off)
 - When the zoom is at a telephoto position
- When using a tripod to stabilize the camera during shooting, set **Vibration reduction to Off** in the setup menu ( 113) to prevent potential errors caused by this function.
- After attaching the camera to a tripod, make sure that the camera does not fall over when zooming the lens in or out. Extend one leg of the tripod toward the subject and the other two legs toward you at an equal distance.
- The camera may move slightly when operated, even if it is attached to a tripod, which may interfere with the autofocus. Wait a few seconds after operating the camera, and then slowly press the shutter-release button.

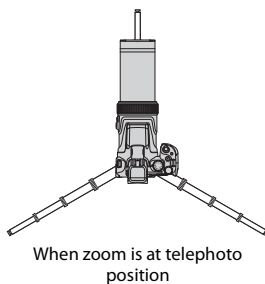
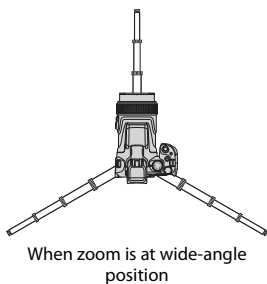

4 Press the shutter-release button halfway.

- To press the shutter-release button “halfway” means to press and hold the button at the point where you feel a slight resistance.
- When the subject is in focus, the focus area or focus indicator is displayed in green.
- When you are using digital zoom, the camera focuses in the center of the frame and the focus area is not displayed.
- If the focus area or focus indicator flashes, the camera is unable to focus. Modify the composition and try pressing the shutter-release button halfway again.

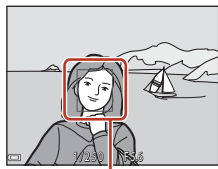
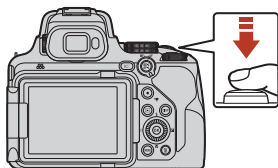

Focus area

5 Without lifting your finger, press the shutter-release button all the way down.



✓ Notes About Saving Images or Movies

The indicator showing the number of exposures remaining or the indicator showing the remaining recording time flashes while images or movies are being saved. **Do not open the battery-chamber/memory card slot cover or remove the battery or memory card** while an indicator is flashing. Doing this could result in loss of data, or in damage to the camera or the memory card.

📎 The Auto Off Function

- When no operations are performed for about one minute, the screen turns off, the camera enters standby mode, and then the power-on lamp flashes. The camera turns off after remaining in standby mode for about three minutes.
- To turn the screen back on while the camera is in standby mode, perform an operation such as pressing the power switch or shutter-release button.



Using the Built-in Flash

In situations where a flash is needed, such as in dark locations or when the subject is backlit, move the  (flash pop-up) control to raise the built-in flash.

- When not using the built-in flash, gently push to lower the built-in flash until it clicks shut.

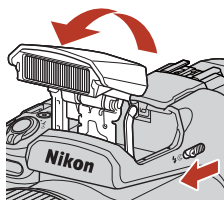

How to Attach the BS-1 Accessory Shoe Cover (Available Separately)

①

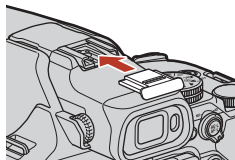

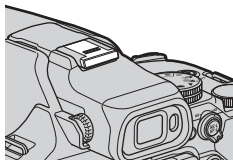

②



Recording Movies

Display the shooting screen and press the  (movie-record) button to start recording a movie.

- Press the  button again to end recording. When you rotate the mode dial to  (Movie manual), you can set the shutter speed and f-number for movie recording.

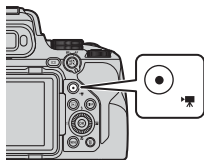

Switching Between the Monitor and Viewfinder

It is recommended that you use the viewfinder when bright conditions make it difficult to see the monitor, such as when outdoors in sunlight.

- When you bring your face close to the viewfinder, the eye sensor responds to it and the viewfinder turns on, and the monitor turns off (default setting).
- You can also press the  (monitor) button to switch the display between the monitor and viewfinder.

Viewfinder

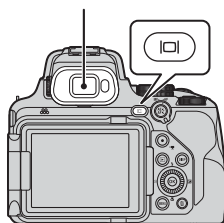

Diopter Adjustment of the Viewfinder

When the image in the viewfinder is difficult to see, adjust by rotating the diopter adjustment control while looking through the viewfinder.

- Take care not to scratch your eye with your fingertips or nails.

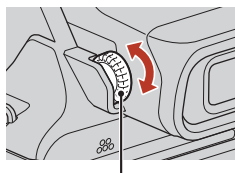

Diopter adjustment control





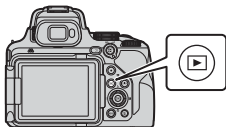

Playing Back Images

1 Press the (playback) button to enter playback mode.

- If you press and hold down the  button while the camera is turned off, the camera turns on in playback mode.



2 Use the multi selector to select an image to display.

- Press and hold down  to scroll through the images quickly.
- Images can also be selected by rotating the multi selector.
- Press the **DISP** (display) button to switch the information displayed on the screen each time.
- To play back a recorded movie, press the  button.
- To return to shooting mode, press the  button or shutter-release button.
- Move the zoom control toward **T** () in full-frame playback mode to zoom in on an image.

Display the previous image

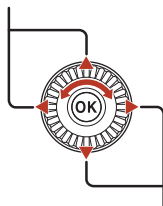

Display the next image



- In full-frame playback mode, move the zoom control toward **W** () to switch to thumbnail playback mode and display multiple images on the screen.

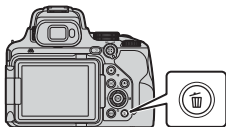

Deleting Images

- 1 Press the  (delete) button to delete the image currently displayed on the screen.



- 2 Use the multi selector   to select the desired deletion method and press the  button.

- To exit without deleting, press the **MENU** button.

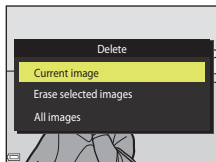

- 3 Select **Yes** and press the  button.

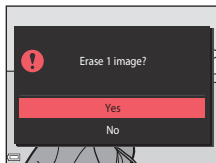

- Deleted images cannot be recovered.



Notes About Deleting Images Simultaneously Saved in RAW and JPEG

When using this camera to delete images captured using **RAW + Fine** or **RAW + Normal** in the **Image quality** (📖116) setting, both of the simultaneously saved RAW and JPEG images are deleted. You cannot delete only one format.

Deleting Images Captured Continuously (Sequence)

- Images captured continuously are saved as a sequence, and only the first image of the sequence (the key picture) is displayed in playback mode (default setting).
- If you press the  button while a key picture is displayed for a sequence of images, all images in the sequence are deleted.
- To delete individual images in a sequence, press the  button to display them one at a time and press the  button.



Deleting the Image Captured While in Shooting Mode

When using shooting mode, press the  button to delete the last image that was saved.



The Image Selection Screen for Deletion

1 Use the multi selector ◀▶ or rotate it to select the image that you want to delete.

- Move the zoom control (📖) toward **T** (🔍) to switch to full-frame playback, or **W** (📐) to switch to thumbnail playback.

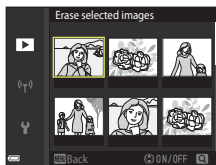

2 Use ▲▼ to select **ON** or **OFF**.

- When **ON** is selected, an icon is displayed under the selected image. Repeat steps 1 and 2 to select additional images.

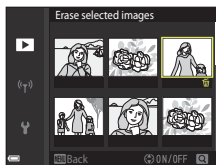

3 Press the **OK** button to apply the image selection.

- A confirmation dialog is displayed. Follow the on-screen instructions to operate.



Shooting Features

Selecting a Shooting Mode	31
 (Auto) Mode	32
Scene Mode (Shooting Suited to the Shooting Conditions)	33
Creative Mode (Applying Effects When Shooting)	44
P , S , A , and M Modes (Setting the Exposure for Shooting)	46
U (User Settings) Mode	52
Setting Shooting Functions with the Multi Selector	54
Flash Mode	55
Self-timer	58
Smile Timer (Shooting Smiling Faces Automatically)	60
Using Autofocus	61
Using Manual Focus	67
Exposure Compensation (Adjusting Brightness)	69
Using the Fn (Function) Button	70
Using the Zoom	71
Default Settings (Flash, Self-timer, and Focus Mode)	73
Functions That Cannot Be Used Simultaneously When Shooting	75



Selecting a Shooting Mode

You can rotate the mode dial to align the desired shooting mode with the indicator mark on the camera body.

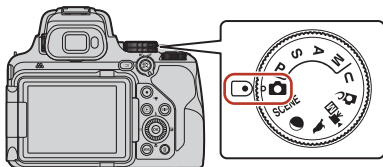

- **📷 (Auto) mode**
Select this mode to perform general shooting in a variety of shooting conditions.
- **SCENE, 🌕, and 🐦 (Scene) modes**
When you select any one of the scene modes based on the shooting conditions, you can take pictures with the appropriate settings for those conditions.
 - **SCENE**: Press the **MENU** button and select a scene mode. When using **Scene auto selector**, the camera recognizes the shooting conditions when you frame a picture, and you can take pictures in accordance with the conditions.
 - **🌕 (moon)**: Use this mode when capturing images of the moon in a telephoto position.
 - **🐦 (bird-watching)**: Use this mode when capturing images of birds in a telephoto position.
- **🎨 (Creative) mode**
Apply effects to images during shooting.
- **P, S, A, and M modes**
Select these modes for greater control over shutter speed and f-number.
- **U (User settings) mode**
The frequently used settings in **P, S, A,** and **M** modes can be saved. To shoot with the saved settings, rotate the mode dial to **U**.
- **🎥 (Movie manual) mode**
You can record movies with the exposure mode set to aperture-auto priority or manual.







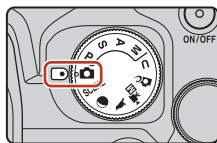

(Auto) Mode

Select this mode to perform general shooting in a variety of shooting conditions.

- The camera detects the main subject and focuses on it (target finding AF). If a human face is detected, the camera automatically sets focus priority on it.
- See "Using Autofocus" ( 61) for more information.



Functions Available in (Auto) Mode

- Flash mode ( 55)
- Self-timer ( 58)
- Smile timer ( 60)
- Focus mode ( 61)
- Exposure compensation ( 69)
- Shooting menu ( 121)



Scene Mode (Shooting Suited to the Shooting Conditions)

When you select any one of the scene modes based on the shooting conditions, you can take pictures with the appropriate settings for those conditions.

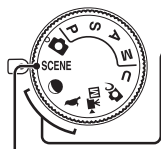

☾ Moon (📖40)^{1,2,3}, 🐦 Bird-watching (📖40)¹
 Rotate the mode dial to ☾ or 🐦 and take pictures.

SCENE

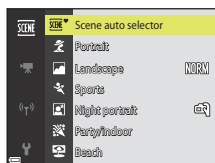
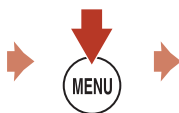
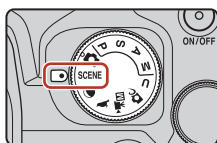

Press the **MENU** button to display the scene menu and select one of the following scene modes using the multi selector.

Scene auto selector (default setting) (📖34)	Close-up (📖36)
Portrait	Food (📖37)
Landscape (📖34) ^{1,2}	Fireworks show (📖37) ³
Sports (📖35) ¹	Backlighting (📖37) ¹
Night portrait (📖35)	Easy panorama (📖41) ¹
Party/indoor (📖35) ¹	Pet portrait (📖38)
Beach ¹	SOFT Soft ¹
Snow ¹	Selective color (📖38) ¹
Sunset ^{1,2,3}	Multiple exp. Lighten (📖39) ³
Dusk/dawn ^{1,2,3}	Time-lapse movie (📖96) ³
Night landscape (📖36) ^{1,2}	Superlapse movie (📖98) ¹

¹ The camera focuses on the area in the center of the frame. The position of the area cannot be moved.

² The camera focuses at infinity.











³ Use of a tripod is recommended (📖23). Set **Vibration reduction** (📖171) to **Off** in the setup menu when using a tripod to stabilize the camera during shooting.



Tips and Notes About Scene Mode

SCENE → Scene auto selector

- When you point the camera at the subject, the camera automatically recognizes the shooting conditions and adjusts the shooting settings accordingly.

	Portrait (for taking close-up portraits of one or two people)
	Portrait (for taking portraits of large numbers of people, or images in which the background takes up a large portion of the frame)
	Landscape
	Night portrait (for taking close-up portraits of one or two people)
	Night portrait (for taking portraits of large numbers of people, or images in which the background takes up a large portion of the frame)
	Night landscape
	Close-up
	Backlighting (for taking pictures of subjects other than people)
	Backlighting (for taking portrait pictures)
	Other shooting conditions

- Under some shooting conditions, the camera may not select the desired settings. In this case, select another shooting mode (31).

SCENE → Landscape









- On the screen displayed when  **Landscape** is selected, select **Noise reduction burst** or **Single shot**.
- **Noise reduction burst**: This enables you to shoot a sharp landscape with a minimum of noise.
 - Press the shutter-release button all the way to capture a series of images which are combined into a single image and saved.
 - Once the shutter-release button is pressed all the way, hold the camera still until a still image is displayed. After taking a picture, do not turn the camera off before the screen switches to the shooting screen.
 - The angle of view (i.e., the area visible in the frame) seen in the saved image is narrower than that seen on the shooting screen.
 - Continuous shooting may not be possible in certain shooting conditions.
- **Single shot** (default setting): Saves images with emphasized outlines and contrast.
 - One image is captured when the shutter-release button is pressed all the way.





SCENE → Sports

- While the shutter-release button is held all the way down, images are captured continuously.
- The camera can capture about 7 images continuously at a rate of about 7 fps.
- The frame rate for continuous shooting may become slow depending on the current image quality setting, image size setting, the memory card used, or shooting conditions.
- Focus, exposure, and hue for the second and subsequent images are fixed at the values determined with the first image.

SCENE → Night portrait







- On the screen displayed when  **Night portrait** is selected, select  **Hand-held** (default setting) or  **Tripod**.
- One image is captured at a slow shutter speed. Compared to using  **Tripod**, when  **Hand-held** is selected, the camera sets a slightly faster shutter speed in accordance with the shooting conditions to prevent camera shake.
- When  **Tripod** is selected, vibration reduction is disabled regardless of the **Vibration reduction** setting ( 171) in the setup menu. See “Using a Tripod” ( 23) when using a tripod.
- Raise the built-in flash before shooting.

SCENE → Party/indoor

- To avoid the effects of camera shake, hold the camera steady. Set **Vibration reduction** ( 171) to **Off** in the setup menu when using a tripod to stabilize the camera during shooting. See “Using a Tripod” ( 23) when using a tripod.







SCENE → Night landscape

- On the screen displayed when  **Night landscape** is selected, select  **Hand-held** (default setting) or  **Tripod**.
-  **Hand-held** (default setting):
 - Press the shutter-release button all the way to capture a series of images which are combined into a single image and saved.
 - Once the shutter-release button is pressed all the way, hold the camera still until a still image is displayed. After taking a picture, do not turn the camera off before the screen switches to the shooting screen.
 - The angle of view (i.e., the area visible in the frame) seen in the saved image is narrower than that seen on the shooting screen.
 - Continuous shooting may not be possible in certain shooting conditions.
-  **Tripod**:
 - One image is captured at a slow shutter speed when the shutter-release button is pressed all the way.
 - Vibration reduction is disabled regardless of the **Vibration reduction** setting ( 171) in the setup menu.
 - See "Using a Tripod" ( 23) when using a tripod.

SCENE → Close-up

On the screen displayed when  **Close-up** is selected, select **Noise reduction burst** or **Single shot**.

- **Noise reduction burst**: This enables you to shoot a sharp image with a minimum of noise.
 - Press the shutter-release button all the way to capture a series of images which are combined into a single image and saved.
 - Once the shutter-release button is pressed all the way, hold the camera still until a still image is displayed. After taking a picture, do not turn the camera off before the screen switches to the shooting screen.
 - If the subject moves or there is a significant camera shake during continuous shooting, the image may be distorted, overlapped, or blurred.
 - The angle of view (i.e., the area visible in the frame) seen in the saved image is narrower than that seen on the shooting screen.
 - Continuous shooting may not be possible in certain shooting conditions.
- **Single shot** (default setting): Saves images with emphasized outlines and contrast.
 - One image is captured when the shutter-release button is pressed all the way.
- The focus mode ( 61) setting is changed to  (macro close-up) and the camera automatically zooms to the closest position at which it can focus.
- You can move the focus area. Press the  button, use the multi selector  or rotate it to move the focus area, and press the  button to apply the setting.



SCENE → 🍴 Food

- The focus mode (📖61) setting is changed to 🍷 (macro close-up) and the camera automatically zooms to the closest position at which it can focus.
- You can adjust hue by using the command dial. The hue setting is saved in the camera's memory even after the camera is turned off.
- You can move the focus area. Press the **OK** button, use the multi selector ▲▼◀▶ or rotate it to move the focus area, and press the **OK** button to apply the setting.



SCENE → 🎆 Fireworks show

- The shutter speed is fixed at about four seconds.
- Exposure compensation cannot be used (📖69).
- It is recommended that you use manual focus (📖67).

SCENE → 📷 Backlighting

- On the screen displayed when **Backlighting** is selected, select **On** or **Off** to enable or disable the high dynamic range (HDR) function based on the shooting conditions.
- **Off** (default setting): The flash fires to prevent the subject from being hidden in shadow. Shoot images with the built-in flash raised.
 - Press the shutter-release button all the way to capture one image.
- **On**: Use when taking pictures with very bright and dark areas in the same frame.
 - When the shutter-release button is pressed all the way, the camera shoots images continuously and saves the following two images.
 - A non-HDR composite image
 - An HDR composite image in which the loss of details in highlights or shadows is minimized
 - If there is only enough memory to save one image, an image processed by D-Lighting (📖84) at the time of shooting, in which dark areas of the image are corrected, is the only image saved.
 - Once the shutter-release button is pressed all the way, hold the camera still until a still image is displayed. After taking a picture, do not turn the camera off before the screen switches to the shooting screen.
 - The angle of view (i.e., the area visible in the frame) seen in the saved image is narrower than that seen on the shooting screen.
 - Under some shooting conditions, dark shadows may appear around bright subjects or bright areas may appear around dark subjects.

✔ Notes About HDR

Use of a tripod is recommended (📖23). Set **Vibration reduction** (📖171) in the setup menu to **Off** when using a tripod to stabilize the camera.



SCENE → 🐾 Pet portrait

- When you point the camera at a dog or cat, the camera detects the pet's face and focuses on it. By default, the shutter is automatically released when a dog or cat face is detected (pet portrait auto release).
- On the screen displayed when 🐾 **Pet portrait** is selected, select **[S] Single** or **[C] Continuous**.
 - **[S] Single**: Whenever a dog or cat face is detected, the camera captures one image.
 - **[C] Continuous** (default setting): Whenever a dog or cat face is detected, the camera captures three images continuously.

✔ **Pet Portrait Auto Release**

- Press the multi selector ◀ (🔊) to change the **Pet portrait auto release** setting.
 - **[ON]**: The camera automatically releases the shutter when it detects a dog or cat face.
 - **OFF**: The camera does not release the shutter automatically, even if a dog or cat face is detected. Press the shutter-release button. The camera also detects human faces when **OFF** is selected.
- **Pet portrait auto release** is set to **OFF** after five bursts have been taken.
- Shooting is also possible by pressing the shutter-release button, regardless of the **Pet portrait auto release** setting.

✔ **Focus Area**

- When the camera detects a face, the face is displayed inside a yellow border. When the camera acquires focus on a face displayed inside a double border (focus area), the double border changes to green. If no faces are detected, the camera focuses on the area in the center of the frame.
- Under some shooting conditions, the pet face may not be detected and other subjects may be displayed inside a border.

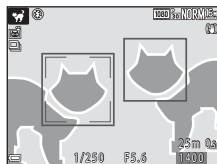





SCENE → 🎨 Selective color

- Keeps only a selected image color and makes other colors black-and-white.
- Rotate the command dial to select the desired color, and press the **[OK]** button to apply the color. To change the color selection, press the **[OK]** button again.





SCENE → Multiple exp. Lighten

- The camera automatically captures moving subjects at regular intervals, compares each image and composites only their bright areas, and then saves them as one image. Light trails such as the flow of car lights or motion of stars are captured.
- On the screen displayed when  **Multiple exp. Lighten** is selected, select  **Nightscape + light trails** or  **Star trails**.

Option	Description
 Nightscape + light trails	<p>Use to capture the flow of car lights against a night landscape background.</p> <ul style="list-style-type: none">• You can rotate the command dial to set the desired interval between the shots. The set interval becomes the shutter speed. When 50 shots are taken, the camera automatically stops shooting.• For every 10 shots taken, one composite image with trails overlapped from the start of shooting is automatically saved.• The camera focuses on the area in the center of the frame.
 Star trails	<p>Use to capture the motion of stars.</p> <ul style="list-style-type: none">• Shots are taken at a shutter speed of 25 seconds, with an interval of approximately 5 seconds between the shots. When 300 shots are taken, the camera automatically stops shooting.• For every 30 shots taken, one composite image with trails overlapped from the start of shooting is automatically saved.



- The screen may turn off during the shooting interval. The power-on lamp lights up while the screen is off.
- The auto off function is disabled during shooting (📖176).
- To end shooting before it automatically ends, press the  button.
- When you have obtained the desired trails, end shooting. If you continue shooting, details in the composited areas may be lost.
- When shooting distant subjects such as airplanes or fireworks, it is recommended that you set the focus mode (📖61) to  (infinity) or use manual focus (📖67).
- When capturing images of stars, it is recommended that you use manual focus.
- Exposure compensation cannot be used (📖69).

Notes About Multiple Exp. Lighten

- Do not rotate the mode dial or insert a new memory card until shooting ends.
- Use batteries with a sufficient amount of charge remaining to prevent the camera from turning off during shooting.







Time Remaining



You can check the time remaining until shooting automatically ends on the screen.



Moon

- At the wide-angle zoom position, the framing border is displayed to indicate the angle of view equivalent to that of a 1000 mm lens (in 35mm [135] format) (default setting). When you frame the moon inside the framing border and press the **OK** button, the camera zooms in so that the area inside the framing border takes up the entire angle of view (focal length). You can change the angle of view for the framing border by pressing the **MENU** button and selecting **Focal length selection** in the **Moon** menu.
- You can adjust hue by using the command dial. The hue setting is saved in the camera's memory even after the camera is turned off.
- Adjust the brightness with exposure compensation (69) according to shooting conditions such as the waxing and waning of the moon and shooting requirements.
- The default setting of the self-timer (58) is 3s (3 seconds). To change the setting, press the multi selector .



Bird-watching

- At the wide-angle zoom position, the framing border is displayed to indicate the angle of view equivalent to that of a 500 mm lens (in 35mm [135] format) (default setting). When you frame a bird inside the framing border and press the **OK** button, the camera zooms in so that the area inside the framing border takes up the entire angle of view (focal length). You can change the angle of view for the framing border by pressing the **MENU** button and selecting **Focal length selection** in the **Bird-watching** menu.
- To capture images continuously, press the **MENU** button and select **Continuous** in the **Bird-watching** menu.
 -  **Single** (default setting): One image is shot each time the shutter-release button is pressed.
 -  **Continuous**: While the shutter-release button is held all the way down, images are captured continuously.
The camera can capture about 7 images continuously at a rate of about 7 fps.



Shooting with Easy Panorama

Rotate the mode dial to **SCENE** → **MENU** button →  Easy panorama →  button

- 1 Select  **Normal (180°)** or  **Wide (360°)** as the shooting range and press the  button.

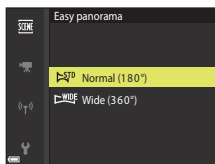



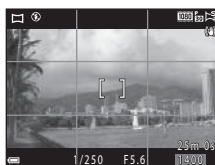

- 2 Frame the first edge of the panorama scene, and then press the shutter-release button halfway to focus.

- The zoom position is fixed at wide-angle.
- The camera focuses in the center of the frame.



- 3 Press the shutter-release button all the way, and then remove your finger from the shutter-release button.

-     are displayed to indicate the direction of camera movement.



- 4 Move the camera in one of the four directions until the guide indicator reaches the end.

- When the camera detects which direction it is moving in, shooting begins.
- Shooting ends when the camera captures the specified shooting range.
- Focus and exposure are locked until shooting ends.

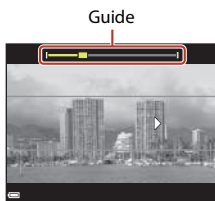

Example of Camera Movement

- Using your body as the axis of rotation, move the camera slowly in an arc, in the direction of the marking ($\triangle \nabla \langle \rangle$).
- Shooting stops if the guide does not reach the edge within about 15 seconds (when $\triangle \nabla \langle \rangle$ **Normal (180°)** is selected) or within about 30 seconds (when $\triangle \nabla \langle \rangle$ **Wide (360°)** is selected) after shooting starts.



✓ Notes About Easy Panorama Shooting

- The range of the image seen in the saved image is narrower than that seen on the screen at the time of shooting.
- If the camera is moved too quickly or shaken too much, or if the subject is too uniform (e.g. walls or darkness), an error may occur.
- If shooting is stopped before the camera reaches the half-way point in the panorama range, a panorama image is not saved.
- If more than half of the panorama range is captured but shooting ends before reaching the edge of the range, the range not captured is recorded and displayed in gray.

📎 Image Size of Easy Panorama

There are four different image sizes (in pixels), as described below.

When $\triangle \nabla \langle \rangle$ **Normal (180°)** is set

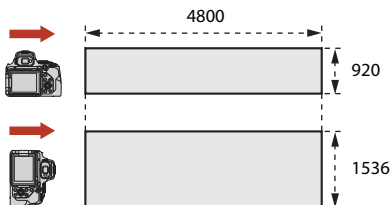

When $\triangle \nabla \langle \rangle$ **Wide (360°)** is set

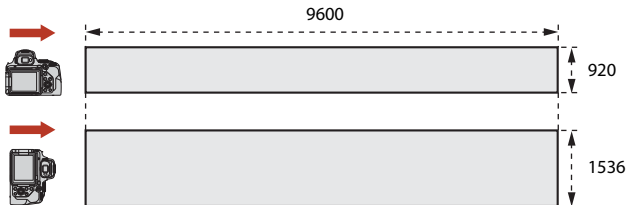

Playback with Easy Panorama

Switch to playback mode (📖27), display an image captured using easy panorama in full-frame playback mode, and then press the **OK** button to scroll the image in the direction that was used when shooting.

- Rotate the multi selector to fast-forward or rewind scroll playback.

Playback controls are displayed on the screen during playback.

Use the multi selector **◀▶** to select a control, and then press the **OK** button to perform the operations described below.



Function	Icon	Description
Rewind		Hold down the OK button to rewind scroll playback.*
Fast-forward		Hold down the OK button to fast-forward scroll playback.*
Pause		Pause playback. The operations listed below can be performed while paused.
		Scroll one step to the left. Hold down the OK button to scroll continuously.*
		Scroll one step to the right. Hold down the OK button to scroll continuously.*
		Resume automatic scrolling.
End		Return to full-frame playback mode.

* These operations can also be performed by rotating the multi selector.

Notes About Easy Panorama Images

- The images cannot be edited on this camera.
- This camera may not be able to scroll the playback of, or zoom in on, easy panorama images captured with another make or model of digital camera.

Notes About Printing Panorama Images

The entire image may not be able to be printed depending on the printer's settings. Additionally, printing may not be possible depending on the printer.



Creative Mode (Applying Effects When Shooting)

Apply effects to images during shooting.

- Five effect groups are available: **Light** (default setting), **Depth**, **Memories**, **Classic**, and **Noir**.

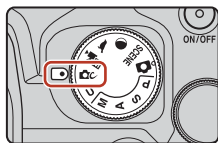

1 Press the **OK** button.

- The effect selection screen is displayed.

2 Use the multi selector ◀▶ to select an effect.

- The effect group can be changed by rotating the command dial.
- To exit without saving the selection, press ▲.

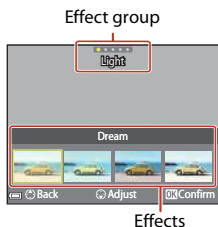

3 To adjust the effect, press ▼.

- If you do not want to adjust the effect, press the **OK** button to proceed to step 6.

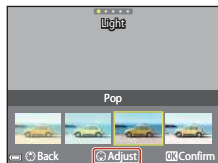

- 4** Use ◀▶ to highlight the desired option and then press ▼.
- Select **Amount**, **Exposure compensation**, **Contrast**, **Hue**, **Saturation**, **Filter**, or **Peripheral illumination**. The options that can be selected vary depending on the group.

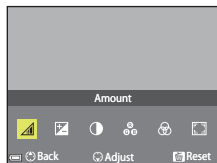

- 5** Use ◀▶ to adjust the effect level and press the Ⓚ button.

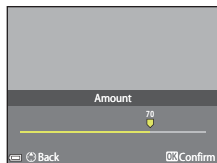

- 6** Press the shutter-release button or the ● (▶ movie-record) button to shoot.
- When the camera detects the main subject, it focuses on the subject (📖63).

Selecting an Effect Group and Effect

You can also select an effect group and effect by pressing the **MENU** button when the screen in step 1 is displayed.

Functions Available in Creative Mode

- Flash mode (📖55)
- Self-timer (📖58)
- Focus mode (📖61)
- Exposure compensation (📖69)
- Shooting menu (📖121)



P, S, A, and M Modes (Setting the Exposure for Shooting)

In **P**, **S**, **A**, and **M** modes, you can set exposure (combination of shutter speed and f-number) according to the shooting conditions. Also, you can achieve greater control when shooting images by setting the shooting menu options (📖116).

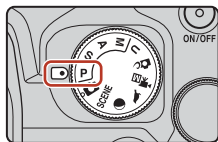

Shooting mode	Description
P Programmed auto	<p>You can let the camera adjust the shutter speed and f-number.</p> <ul style="list-style-type: none"> The combination of shutter speed and f-number can be changed by rotating the command dial (flexible program). While the flexible program is in effect, the X (flexible program mark) is displayed on the upper left of the screen. To cancel the flexible program, rotate the command dial in the opposite direction than when you set it until the X is no longer displayed, change the shooting mode, or turn off the camera.
S Shutter-priority auto	Rotate the command dial to set the shutter speed. The camera automatically determines the f-number.
A Aperture-priority auto	Rotate the multi selector to set the f-number. The camera automatically determines the shutter speed.
M Manual	<p>Set both the shutter speed and f-number. Rotate the command dial to set the shutter speed. Rotate the multi selector to set the f-number.</p> <ul style="list-style-type: none"> You can use the Bulb setting or Time setting to capture images with a long time-exposure.

- The allocations of the controls for setting the exposure can be changed using **Toggle Av/Tv selection** in the setup menu (📖113).

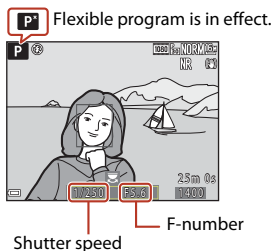
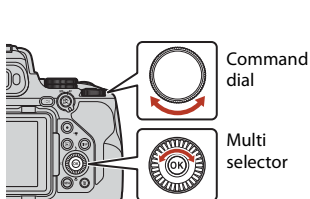

Tips for Setting Exposure

The sense of dynamism and amount of background defocus in subjects vary by changing the combinations of shutter speed and f-number even if the exposure is the same.

Effect of the Shutter Speed

The camera can make a fast-moving subject appear static at a fast shutter speed, or highlight the motion of a moving subject at a slow shutter speed.



Faster
1/1000 s



Slower
1/30 s

Effect of the F-number

The camera can bring the subject, foreground and background into focus, or blur the subject's background intentionally.



Small f-number
(larger aperture)
f/2.8



Large f-number
(smaller aperture)
f/8

Shutter Speed and F-number

- The control range of the shutter speed differs depending on the zoom position, f-number, or ISO sensitivity setting.
- The f-number of this camera also changes depending on the zoom position.
- When zooming is performed after the exposure is set, exposure combinations or the f-number may be changed.
- Large apertures (expressed by small f-numbers) let more light into the camera, and small apertures (large f-numbers) let less light. The smallest f-number represents the largest aperture, and the largest f-number represents the smallest aperture.



- The closer the lens is to the telephoto zoom position, the smaller the aperture range becomes. The f-number is fixed at f/8.0 when the zoom is in a telephoto position beyond the focal length equivalent to that of a 2800 mm lens (in 35mm [135] format).

Setting Exposure When Recording Movies

When recording movies in **P**, **S**, **A**, **M**, or **U**, the shutter speed and f-number that you set are not applied. When the mode dial is rotated to  (Movie manual), you can set the exposure for movie recording.

Notes About Setting Exposure

When the subject is too dark or too bright, it may not be possible to obtain the appropriate exposure. In such cases, the shutter speed indicator or f-number indicator flashes when the shutter-release button is pressed halfway (except when the **M** mode is used). Change the shutter speed setting or f-number.

Exposure Indicator (When in **M** Mode)

The degree of deviation between the adjusted exposure value and the optimal exposure value measured by the camera is displayed in the exposure indicator on the screen. The degree of deviation in the exposure indicator is displayed in terms of EV (-3 to +3 EV in increments of 1/3 EV).

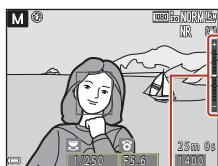







Exposure indicator

Notes About ISO Sensitivity

When **ISO sensitivity** () is set to **Auto** (default setting) or **Fixed range auto**, the ISO sensitivity in **M** mode is fixed at ISO 100.

Functions Available in **P**, **S**, **A**, and **M** Modes

- Flash mode ()
- Self-timer ()
- Smile timer ()
- Focus mode ()
- Exposure compensation ()
- Shooting menu ()
- Functions that can be set using the **Fn** (function) button ()



Focus Area

The focus area for autofocus varies depending on the setting of **AF area mode** () in the shooting menu. When set to **Target finding AF** (default setting), the camera detects the main subject and focuses on it. If a human face is detected, the camera automatically sets focus priority on it.



The Control Range of the Shutter Speed (**P**, **S**, **A**, and **M** Modes)

The control range of the shutter speed differs depending on the zoom position, f-number, or ISO sensitivity setting. Additionally, the control range changes in the following continuous shooting settings.

Setting		Control range
ISO sensitivity ( 137) ¹	Auto ² , Fixed range auto ²	1/4000 ^{3,4} –1 s (P , S , and A modes) 1/4000 ^{3,4} –30 s (M mode) ⁵
	ISO 100	1/4000 ^{3,4} –8 s (P , S , and A modes) 1/4000 ^{3,4} –30 s (M mode) ⁵
	ISO 200	1/4000 ^{3,4} –4 s (P , S , and A modes) 1/4000 ^{3,4} –8 s (M mode)
	ISO 400	1/4000 ^{3,4} –4 s
	ISO 800	1/4000 ^{3,4} –2 s
	ISO 1600	1/4000 ^{3,4} –1 s
	ISO 3200	1/4000 ^{3,4} –1/2 s
	ISO 6400	1/4000 ^{3,4} –1/2 s
Continuous ( 133)	Continuous H, Continuous L	1/4000 ^{3,4} –1/30 s
	Pre-shooting cache, Continuous H: 120 fps	1/4000–1/125 s
	Continuous H: 60 fps	1/4000–1/60 s
	Intvl timer shooting	Same as when Single is set

¹ The ISO sensitivity setting is restricted depending on the continuous shooting setting (76).

² In **M** mode, the ISO sensitivity is fixed at ISO 100.

³ The maximum shutter speed when the f-number is set to the largest value (smallest aperture) at the maximum wide-angle zoom position. The closer the zoom position is to telephoto, or the smaller the f-number (larger aperture) is, the slower the maximum shutter speed becomes. For example, the maximum shutter speed is 1/2500 second when the f-number is set to the largest value (smallest aperture) at the maximum telephoto zoom position.

⁴ The exposure may vary when capturing the same subject multiple times with a shutter speed faster than 1/2000 second.

⁵ Bulb setting and Time setting (50) are available.



Shooting with the Bulb Setting or Time Setting (When in M Mode)

Use the Bulb setting or Time setting to capture images with a long time-exposure, such as when taking pictures of fireworks, night landscapes, the night sky, or car light trails. The maximum exposure time for both the Bulb and Time setting is 60 seconds.

Bulb	The shutter remains open while the shutter-release button is pressed, and it closes when the button is released.
Time	The shutter opens when the shutter-release button is pressed all the way down, and it closes when the button is pressed all the way down again. <ul style="list-style-type: none">You can use the shutter-release button on the ML-L7 Remote Control (available separately) to shoot with the Time setting.

1 Stabilize the camera by using a tool such as a tripod.

- Select **Off** for **Vibration reduction** (📖171) in the setup menu.
- See "Using a Tripod" (📖23) when using a tripod.

2 Rotate the mode dial to **M**.

- Set **ISO sensitivity** to **Auto**, **Fixed range auto**, or **100**.
- Set **Continuous** (📖133) to **Single**.

3 Rotate the command dial to a slower speed until the shutter speed indicator displays **Bulb** or **Time**.

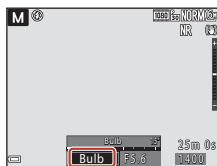

4 Press the shutter-release button after setting the focus.

- Bulb: Hold down the shutter-release button until the desired exposure time elapses.
- Time: Press the shutter-release button all the way down again when the desired exposure time elapses.
- When the exposure time reaches 60 seconds, the shutter automatically closes and shooting ends.



✓ Notes About Shooting with the Bulb or Time Setting

The Bulb or Time setting cannot be used when a setting other than **Single** is selected for **Continuous** (📖133).



Long Time-Exposures

- It may take longer for the camera to save images if a slow shutter speed is used when shooting.
- It is recommended that you use a sufficiently charged battery or the EH-5b/EH-5c AC Adapter and the EP-5C Power Connector (both available separately) (📖209) to prevent the camera from turning off unexpectedly.



Saving Settings in U Mode (Save User Settings)

The frequently used settings in **P**, **S**, **A**, and **M** modes can be saved. At the time of purchase, the default settings of **P** mode are saved.

1 Rotate the mode dial to **P**, **S**, **A**, **M**, or **U**.

- If you want to change the shooting mode, select **P**, **S**, **A**, or **M**.
- If you do not want to change the saved shooting mode, select **U**.

2 Change to a frequently used combination of shooting settings.

- See  52 for settings details.
- The flexible program (when set to **P**), shutter speed (when set to **S** or **M**), or f-number (when set to **A** or **M**) settings will also be saved.
- The focus area that is selected with the **Manual (spot)**, **Manual (normal)**, or **Manual (wide)** setting in AF area mode will also be saved.

3 Press the **MENU** (menu) button to display the shooting menu.



4 Use the multi selector **▲▼** to select **Save user settings**, and press the **OK** button.

- The previous saved settings are overwritten by the current settings as the **U** mode.

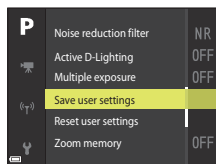

Resetting U (User Settings) Mode

If **Reset user settings** is selected in the shooting menu, the settings that are saved in the user settings are restored to their default values.

Notes About the Clock Battery

If the internal clock battery is exhausted, the settings saved in **U** will be reset. Writing down any important setting is recommended.



Setting Shooting Functions with the Multi Selector

When the shooting screen is displayed, you can press the multi selector ▲ (⚡) ◀ (⌚) ▼ (🌸) ▶ (⊞) to set the functions described below.

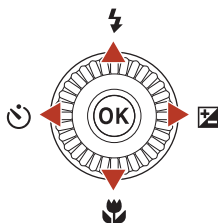

- **⚡ Flash mode**
The flash mode can be set according to shooting conditions.
- **⌚ Self-timer/Smile timer**
The camera releases the shutter when the specified time elapses after you press the shutter-release button. If smile timer is set, the camera automatically releases the shutter whenever a smiling face is detected.
- **🌸 Focus mode**
You can specify **AF** (autofocus), 🌸 (macro close-up), or ▲ (infinity) according to the distance to the subject (when the focus-mode selector is set to **AF** (autofocus)).
- **⊞ Exposure compensation**
You can adjust overall image brightness.

The functions that can be set vary depending on the shooting mode.



Flash Mode

The flash mode can be set according to shooting conditions.

1 Move the (flash pop-up) control to raise the built-in flash.

- When the built-in flash is lowered, flash operation is disabled and  is displayed.
- Make sure that the built-in flash is lowered when using a Speedlight.
- See "Speedlights (External Flash Units)" (📖211) for more information.

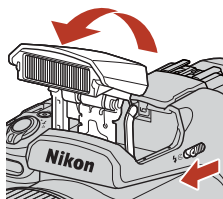

2 Press the multi selector (⚡).

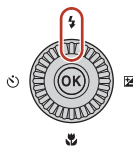

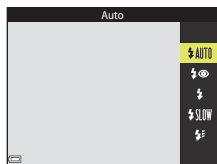

3 Select the desired flash mode (📖56) and press the button.

- If the setting is not applied by pressing the  button, the selection will be canceled.



The Flash-ready Indicator

While the built-in flash is charging,  flashes. The camera cannot shoot images.

If charging is complete,  is displayed steadily when you press the shutter-release button halfway.

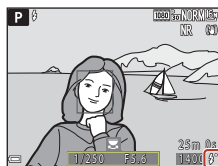

Flash-ready indicator



Available Flash Modes

AUTO Auto

The flash fires when necessary, such as in dim lighting.

- The flash mode indicator is only displayed immediately after setting on the shooting screen.

Auto with red-eye reduction/Red-eye reduction

Reduce red-eye in portraits caused by the flash ( 57).

- When **Red-eye reduction** is selected, the flash fires whenever a picture is taken.

Fill flash/Standard flash

The flash fires whenever a picture is taken.

SLOW Slow sync

Suited to evening and night portraits that include background scenery. Fill flash fires to illuminate the main subject; slow shutter speeds are used to capture background at night or under dim lighting.

Rear-curtain sync

Fill flash fires just before the shutter closes, creating the effect of a stream of light following moving subjects.

Notes About Shooting with the Flash









When using the flash at the wide-angle zoom position, the area around the image may be dark depending on the distance to the subject.



This may be improved if you move the zoom control slightly toward the telephoto position.



The Flash Mode Setting

The available flash modes differ depending on the shooting mode.

Flash mode	 ¹	SCENE, 		P ¹	S ¹	A ¹	M ¹
 AUTO Auto	✓	2	✓	–	–	–	–
 Auto with red-eye reduction	✓		✓	–	–	–	–
Red-eye reduction	–		–	✓	✓	✓	✓
 Fill flash	✓		✓	–	–	–	–
Standard flash	–		–	✓	✓	✓	✓
 SLOW Slow sync	✓		✓	✓	–	✓	–
 Rear-curtain sync	✓		✓	✓	✓	✓	✓

¹ When shooting with  (auto with red-eye reduction) in  (auto) mode, and when shooting mode **P**, **S**, **A**, or **M** is used, the applied setting is saved in the camera's memory even after the camera is turned off.

² Availability depends on the setting. See "Default Settings (Flash, Self-timer, and Focus Mode)" (73) for more information.

Auto with Red-eye Reduction/Red-eye Reduction

The red-eye reduction lamp glows before the main flash to reduce the red-eye effect.

Note the following when shooting:

- Because the red-eye reduction lamp glows, more time than usual is required until the shutter is released after you press the shutter-release button.
- Red-eye reduction may not produce the desired results in some situations.

Using a Speedlight (External Flash)

- The built-in flash does not fire when a Speedlight is attached. Make sure that the built-in flash is lowered.
- Turn the camera off when attaching and detaching a Speedlight.
- The mode names and function names of Speedlights may differ from those of the built-in flash.
- See "Speedlights (External Flash Units)" (211) and refer to the documentation provided with your Speedlight for more information.



Self-timer

The camera releases the shutter when the specified time elapses after you press the shutter-release button. Set **Vibration reduction** (📖171) to **Off** in the setup menu when using a tripod to stabilize the camera during shooting. See “Using a Tripod” (📖23) when using a tripod.

- 1 Press the multi selector ◀ (🕒).

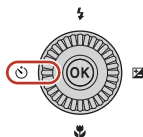

- 2 Select the time that elapses before the camera releases the shutter, and press the **OK** button.

- 🕒10s (10 seconds): Use on important occasions such as weddings, or to prevent camera shake. This setting is recommended when shooting in a telephoto position with the camera attached to a tripod.
- 🕒3s (3 seconds): Use to prevent camera shake.
- If the setting is not applied by pressing the **OK** button, the selection will be canceled.

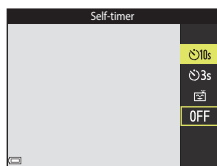

- 3 Frame the picture and press the shutter-release button halfway.
 - Make sure that the subject is in focus.



4 Press the shutter-release button all the way down.

- The focus and exposure are locked, and countdown starts. The self-timer lamp flashes and then glows steadily about one second before the shutter is released.
- When the shutter is released, the self-timer is set to **OFF**.*
- To stop the countdown, press the shutter-release button again.

* When the shooting mode is Moon, the self-timer is not automatically set to **OFF**. To end self-timer, select **OFF** in step 2.

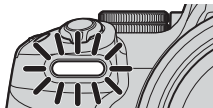
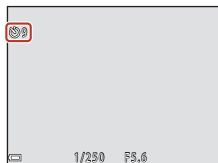

✓ Notes About Using a Tripod During Shooting

- The camera may move slightly when operated, even if it is attached to a tripod, which may interfere with the autofocus. Wait a few seconds after operating the camera, and then slowly press the shutter-release button (📖23).
- If it is difficult for the camera to focus using autofocus, try using manual focus (📖67).
- When using a remote control (available separately) (📖210), you can release the shutter without pressing the shutter-release button on the camera.

📎 Self-timer Setting

- The self-timer setting may not be available with some shooting modes (📖73).
- In **Self-timer: after release** (📖170) in the setup menu, you can select whether or not to cancel the self-timer setting after shooting.



Smile Timer (Shooting Smiling Faces Automatically)

When the camera detects a smiling face, you can take a picture automatically without pressing the shutter-release button.

- This function can be used when the shooting mode is **☑** (auto), **P**, **S**, **A**, **M**, or **U**, or when the scene mode is **Portrait** or **Night portrait**.

1 Press the multi selector ◀ (☺).

- Change any flash mode, exposure, or shooting menu settings before pressing ◀.

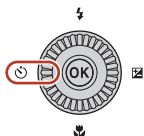

2 Select ☺ (smile timer), and press the OK button.

- If the setting is not applied by pressing the OK button, the selection will be canceled.

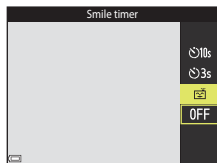

3 Frame the picture and wait for the subject to smile without pressing the shutter-release button.

- Point the camera at a human face.
- If the camera detects that the face framed by the double border is smiling, the shutter is automatically released.
- Whenever the camera detects a smiling face, it automatically releases the shutter.

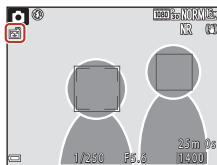

4 End automatic shooting.

- To end automatic shooting with smile timer, return to step 1 and select **OFF**.

✓ Notes About Smile Timer

- When the focus-mode selector is set to **MF** (manual focus), smile timer cannot be set.
- Under some shooting conditions, the camera may be unable to detect faces or detect smiles (64). The shutter-release button can also be used for shooting.

✍ When the Self-timer Lamp Flashes

When using smile timer, the self-timer lamp flashes when the camera detects a face and flashes quickly immediately after the shutter is released.



Using Autofocus

Set the focus-mode selector to **AF** (autofocus) to use autofocus.

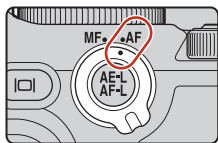

Selecting the Focus Mode

You can select the focus mode that is appropriate for the shooting distance.

- 1 Press the multi selector ▼ (🌸).

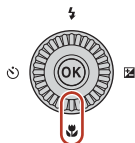

- 2 Select the desired focus mode (📖62) and press the **OK** button.

- If the setting is not applied by pressing the **OK** button, the selection will be canceled.

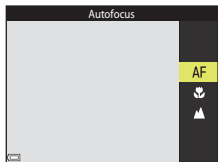

Available Focus Modes



AF Autofocus

Use when the distance from the subject to the lens is 30 cm (1 ft) or more, or 7.0 m (23 ft) or more at the maximum telephoto zoom position.

- The focus mode icon on the shooting screen is displayed only immediately after the setting is made.

Macro close-up

Set when taking close-up pictures.

When the zoom ratio is set to a position where  and the zoom indicator are displayed in green, the camera can focus on subjects as close as approximately 10 cm (4 in.) from the lens. When the zoom is at a position more wide-angled than where  is displayed, the camera can focus on subjects as close as approximately 1 cm (0.4 in.) from the lens.

Infinity

Use when shooting distant scenes through window glass or when shooting landscapes.

The camera automatically adjusts the focus near infinity.

- The camera may not be able to focus on nearby objects.

Focus Mode Setting

- The setting may not be available with some shooting modes.
- For shooting modes **P**, **S**, **A**, and **M**, the setting is saved in the camera's memory even after the camera is turned off.

The Shutter-release Button

Press halfway



To press the shutter-release button "halfway" means to press and hold the button at the point where you feel a slight resistance.

- Focus and exposure (shutter speed and f-number) are set when you press the shutter-release button halfway. Focus and exposure remain locked while the button is pressed halfway.
- The focus area varies depending on the shooting mode.

Press all the way



To press the shutter-release button "all the way" means to press the button down completely.

- The shutter is released when the shutter-release button is pressed all the way.
- Do not use force when pressing the shutter-release button, as this may result in camera shake and blurred images. Press the button gently.



Using Target Finding AF

In  (auto) mode or creative mode, or when **AF area mode** ( 140) in **P, S, A, M,** or **U** mode is set to **Target finding AF**, the camera focuses in the manner described below when you press the shutter-release button halfway.

- The camera detects the main subject and focuses on it. When the subject is in focus, the focus area is displayed in green. If a human face is detected, the camera automatically sets focus priority on it.

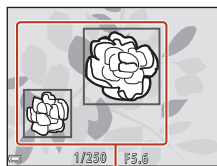

Focus areas

- If no main subject is detected, the camera automatically selects one or more of the nine focus areas containing the subject closest to the camera. When the subject is in focus, the focus areas that are in focus are displayed in green.

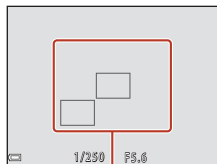

Focus areas

Notes About Target Finding AF

- Depending on shooting conditions, the subject that the camera determines to be the main subject may vary.
- The main subject may not be detected when using certain settings for **White balance**, **Picture Control**, or effect group in creative mode.
- The camera may not detect the main subject appropriately in the following situations:
 - When the subject is very dark or bright
 - When the main subject lacks clearly defined colors
 - When the shot is framed so that the main subject is on the edge of the screen
 - When the main subject is composed of a repeating pattern



Using Face Detection

In the following settings, the camera uses face detection to automatically focus on human faces.

- **Scene auto selector**, **Portrait**, or **Night portrait** scene mode (📖33)
- 📷 (smile timer) (📖60)
- When **AF area mode** (📖140) is set to **Face priority**

If the camera detects more than one face, a double border is displayed around the face that the camera focuses on, and single borders are displayed around the other faces.

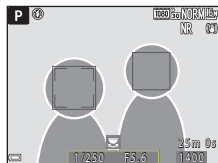

If the shutter-release button is pressed halfway when no faces are detected:

- When **Scene auto selector** is selected, the focus area changes depending on the shooting conditions that the camera recognizes.
- In **Portrait** and **Night portrait**, the camera focuses on the area in the center of the frame.
- When **AF area mode** is set to **Face priority**, the camera selects the focus area containing the subject closest to the camera.
- When 📷 (smile timer) is selected in 📷 (auto), **P**, **S**, **A**, **M**, or **U** mode, the camera automatically selects one or more of the nine focus areas containing the subject closest to the camera.

✔ Notes About Face Detection

- The camera's ability to detect faces depends on a variety of factors, including the direction in which the faces are looking.
- The camera cannot detect faces in the following situations:
 - When faces are partially hidden by sunglasses or otherwise obstructed
 - When faces take up too much or too little of the frame



Using Skin Softening

In **Scene auto selector**, **Portrait**, or **Night portrait** scene mode, if human faces are detected, the camera processes the image to soften facial skin tones before saving the image (up to three faces).

Skin softening can also be applied to saved images in playback mode (📖85).

✔ Notes About Skin Softening

- It may take more time than usual to save images after shooting.
- Under some shooting conditions, the desired skin softening results may not be achieved, and skin softening may be applied to areas of the image where there are no faces.

Subjects Not Suitable for Autofocus

The camera may not focus as expected in the following situations. In rare cases, the subject may not be in focus despite the fact that the focus area or the focus indicator is displayed in green:

- Subject is very dark
- Objects of sharply differing brightness are included in the shooting conditions (e.g. the sun behind the subject makes that subject appear very dark)
- No contrast between the subject and surroundings (e.g. a portrait subject wearing a white shirt is standing in front of a white wall)
- Several objects are at different distances from the camera (e.g. the subject is inside a cage)
- Subjects with repeating patterns (window blinds, buildings with multiple rows of similarly shaped windows, etc.)
- Subject is moving rapidly

In the situations noted above, try pressing the shutter-release button halfway to refocus several times, or focus on another subject positioned at the same distance from the camera as the actual desired subject, and use focus lock (📖66).

The camera can also focus using manual focus (📖67).



Focus Lock

Use focus lock to capture creative compositions even when the focus area is set to the center of the frame.

- 1 Position the subject in the center of the frame and press the shutter-release button halfway.

- The camera focuses on the subject and the focus area is displayed in green.
- Exposure is also locked.

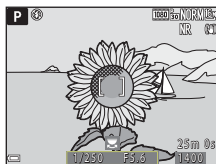

- 2 Without lifting your finger, recompose the picture.

- Make sure to maintain the same distance between the camera and the subject.



- 3 Press the shutter-release button all the way down to capture the image.



Moving the Focus Area to the Desired Position

In **P**, **S**, **A**, or **M** shooting mode, the focus area can be moved using the multi selector by setting **AF area mode** (📖140) in the shooting menu to one of the manual options.

Using the AE-L/AF-L (AE-L/AF-L) Button for Focus Lock

The exposure and focus can be locked using the selected **AE/AF lock button** setting (📖175), by pressing the AE-L/AF-L (AE-L/AF-L) button while the shutter-release button is pressed halfway.



Using Manual Focus

Set the focus-mode selector to **MF** (manual focus) to adjust the focus manually.

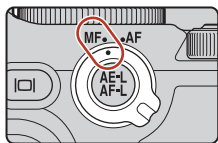

1 Use the multi selector or control ring to adjust the focus.

- Press **◀** to switch the view between 1x, 2x, and 4x.
- To adjust the focus in higher detail, rotate the multi selector or control ring slowly.
- When **▶** is pressed, the camera focuses on the subject in the center of the frame with autofocus. The manual focus can be operated after the camera focuses with autofocus.
- Focusing is assisted by highlighting areas that are in focus in white (peaking) (68). Rotate the command dial to adjust the peaking level.
- Press the shutter-release button halfway to confirm the composition of the picture. Press the shutter-release button all the way to take the picture.

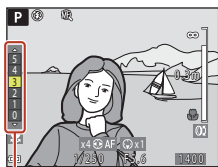

Peaking level

2 Press the multi selector **▼**.

- The set focus is locked.
- Press the shutter-release button all the way to take the picture.
- To readjust the focus, press **▼** to display the screen in step 1.

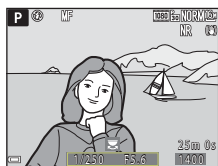



Manual Focus

- The digits displayed for the gauge on the right of the screen in step 1 serve as a guideline for the distance to a subject that is in focus when the gauge is near the center.
- The closest position at which the camera can focus varies depending on the zoom position. When the zoom is at the maximum wide-angle position, the camera can focus on subjects as close as approximately 1 cm (0.4 in.) from the lens. When the zoom is at the maximum telephoto position, the camera can focus on subjects as close as approximately 7.0 m (23 ft) from the lens.
- The actual range at which the subject can be in focus varies depending on the f-number and zoom position. To see whether the subject is in focus, check the image after shooting.
- Set **Assign side zoom control** (📖119) in the setup menu to **Manual focus** to focus by using the side zoom control instead of the multi selector or control ring in step 1.



Peaking

- The range of the contrast level considered to be in focus can be changed by adjusting the peaking level. It is effective to set the level low for high contrast subjects, and high for low contrast subjects.
- Peaking highlights high contrast areas of the image in white. Under some shooting conditions, highlighting may not work properly or areas that are not in focus may be highlighted.
- You can disable the peaking display using **Peaking** (📖120) in the setup menu.
- The peaking display is disabled when **On** is selected for **Clean HDMI output** in **HDMI** (📖119) in the setup menu, and the camera is connected to an HDMI-compatible device.

Manual Focus When Recording Movies

- When the focus-mode selector is set to **MF** and the  (movie-record) button is pressed, you can adjust the focus while recording movies by rotating the multi selector or control ring.
- The peaking display is disabled.
-  operation on the multi selector and the focus-mode selector operation are disabled.

Adjusting the Focus with the ML-L7 Remote Control (Available Separately)

- You can adjust the manual focus with the ML-L7 Remote Control by pressing the multi selector  on the remote control.
- You can lock the set focus by pressing the  (apply selection) button on the remote control.



Exposure Compensation (Adjusting Brightness)

You can adjust overall image brightness.

- 1 Press the multi selector ► (Z).

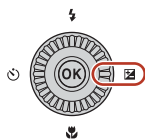

- 2 Select a compensation value and press the OK button.

- To brighten the image, set a positive (+) value.
- To darken the image, set a negative (-) value.
- The compensation value is applied, even without pressing the OK button.

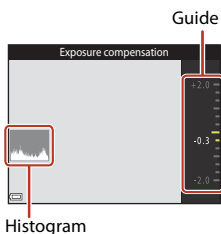

Exposure Compensation Value

- If the setting is applied in **P**, **S**, or **A** mode, it will remain saved in the camera's memory even after the camera is turned off.
- Exposure compensation cannot be used in the following shooting modes:
 - When scene mode (📖33) is set to **Fireworks show**, **Multiple exp. Lighten**, or **Night sky (150 minutes)** or **Star trails (150 minutes)** in **Time-lapse movie**
 - **M** (manual) mode (📖46)
 - **Manual** in **Movie manual** mode
- When the exposure compensation is set while using the built-in flash, the compensation is applied to both the background exposure and the flash output.
- Exposure compensation can also be set with the control ring (📖174).

Using the Histogram

A histogram is a graph showing the distribution of tones in the image. Use as a guide when using exposure compensation and shooting without the flash.

- The horizontal axis corresponds to pixel brightness, with dark tones to the left and bright tones to the right. The vertical axis shows the number of pixels.
- Increasing exposure compensation value shifts tone distribution to the right, and decreasing it shifts tone distribution to the left.



Using the Fn (Function) Button

If you press the **Fn** button in **P**, **S**, **A**, **M**, or **U** mode, you can quickly configure the pre-saved menu options.

- The menu options listed below can be saved.

Image quality (📖121)	Continuous (📖133)
Image size (📖123)	ISO sensitivity (📖137)
Picture Control (📖124)	AF area mode (📖140)
White balance (📖129)	Vibration reduction (📖171)
Metering (📖132)	

1 Press the Fn (function) button when the shooting screen is displayed.

- The setting options of the menu that was set (default setting is **Continuous**) and **Fn Fn button** can be selected.

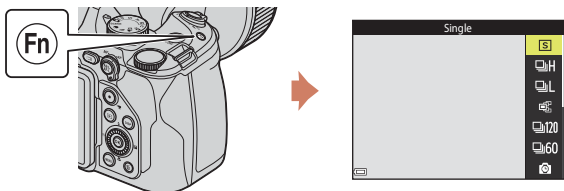

2 Use the multi selector to select a setting and press the OK button.

- If the setting is not applied by pressing the **OK** button, the selection will be canceled.
- To return to the shooting screen without changing the setting, press the **Fn** button or shutter-release button.
- To set a different menu option, select **Fn Fn button** and press the **OK** button. Select the desired menu option and press the **OK** button to set it.



Using the Zoom

When you move the zoom control, the zoom lens position changes.

- To zoom in: Move toward **T**
- To zoom out: Move toward **W**
- Rotating the zoom control all the way in either direction adjusts the zoom quickly (except during movie recording).
- The zoom can also be operated by moving the side zoom control toward **T** or **W**.
The function of the side zoom control can be set in the **Assign side zoom control** (📖173) in the setup menu.
- The zoom indicator and focal length (in 35mm [135] format) are displayed on the shooting screen when the zoom control is moved.
- Digital zoom, which allows you to further magnify the subject up to approximately 4x the maximum optical zoom ratio, can be activated by moving and holding the zoom control toward **T** when the camera is zoomed in to the maximum optical zoom position.
- When using the ML-L7 Remote Control (available separately), the camera zooms in when you press the + button on the remote control, and zooms out when you press the – button.

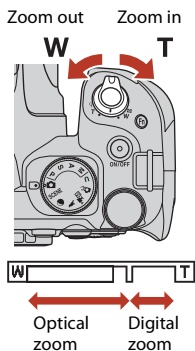

✓ Notes About Digital Zoom When Recording Movies

- The zoom indicator is not displayed while recording a movie.
- If you keep zooming while recording a movie, zooming stops at the position where optical zoom switches to digital zoom. To continue zooming, briefly release your finger from the zoom control before resuming operation of the zoom control.
- The zoom ratio of the digital zoom is limited to approximately 3.6x when **Movie options** (📖150) is set to **2160/30p** (4K UHD) or **2160/25p** (4K UHD) while recording a movie.

📎 Digital Zoom

The zoom indicator changes to blue when the digital zoom is activated, and it changes to yellow when the zoom magnification is increased further.

- Zoom indicator is blue: Image quality is not noticeably reduced by using the Dynamic Fine Zoom.
- Zoom indicator is yellow: There may be cases in which image quality is noticeably reduced.
- The indicator remains blue across a wider area when the image size is smaller.
- The zoom indicator may not change to blue when using certain continuous shooting settings or other settings.







Zoom Speed When Recording Movies

The zoom speed when using the side zoom control is slower than when using the zoom control. Use the zoom control for a faster zoom speed when recording a movie.

Using the Snap-back Zoom

If you lose sight of the subject while shooting with the lens in telephoto position, press the  (snap-back zoom) button to temporarily widen the visible area so that you can frame the subject more easily.

- While pressing the  button, frame the subject inside the framing border of the shooting screen. To widen the visible area further, move the zoom control toward **W** while pressing the  button.
- Release the  button to return to the original zoom position.
- You can select the **Snap-back zoom** ( 173) setting in the setup menu to specify the size of the area that is visible when the  button is pressed.
- Snap-back zoom is not available during movie recording.

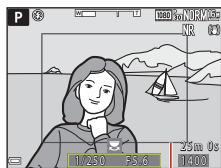
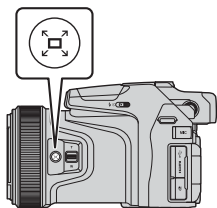

Framing border



Default Settings (Flash, Self-timer, and Focus Mode)

The default settings for each shooting mode are listed below.

	Flash mode (📖54)	Self-timer (📖54)	Focus mode (📖54)
📷 (auto)	⚡ AUTO	OFF ¹	AF
SCENE			
📷 [♥] (scene auto selector)	⚡ AUTO ²	OFF	AF ²
👤 (portrait)	⚡ 👁	OFF ¹	AF ²
🏞 (landscape)	🌞 ²	OFF	▲ ²
🏊 (sports)	🌞 ²	OFF ²	AF ²
🌃 (night portrait)	⚡ 👁 ³	OFF ¹	AF ²
🎉 (party/indoor)	⚡ 👁 ⁴	OFF	AF ²
🏖 (beach)	⚡ AUTO	OFF	AF ⁵
🌨 (snow)	⚡ AUTO	OFF	AF ⁵
🌅 (sunset)	🌞 ²	OFF	▲ ²
🌄 (dusk/dawn)	🌞 ²	OFF	▲ ²
🌃 (night landscape)	🌞 ²	OFF	▲ ²
🌿 (close-up)	⚡ AUTO ⁶	OFF	🌸 ²
🍴 (food)	🌞 ²	OFF	🌸 ²
🎆 (fireworks show)	🌞 ²	OFF ²	👁 ²
📷 (backlighting)	⚡/🌞 ⁷	OFF	AF ²
🖼 (easy panorama)	🌞 ²	OFF ²	AF ²
🐾 (pet portrait)	🌞 ²	📷 ⁸	AF ⁵
SOFT (soft)	⚡ AUTO	OFF	AF
🖌 (selective color)	⚡ AUTO	OFF	AF
📷 (multiple exp. lighten)	🌞 ²	OFF	AF/👁 ⁹
📷 (time-lapse movie)	🌞 ²	OFF	AF/▲/ 👁 ¹⁰
📷 (superlapse movie)	🌞 ²	OFF	AF



	Flash mode (📖54)	Self-timer (📖54)	Focus mode (📖54)
🌕 (moon)	📷 ²	🕒3s	▲ ²
🐦 (bird-watching)	📷 ²	OFF	AF ¹¹
🎬 (movie manual)	📷 ²	OFF	AF
📷 (creative)	⚡AUTO	OFF	AF ⁵
P, S, A, and M	⚡	OFF ¹	AF
U (user settings)	⚡	OFF ¹	AF

¹ **Smile timer** can also be selected.

² Cannot be changed.

³ Cannot be changed. When set to **Hand-held**, the flash mode setting is fixed at fill flash with slow sync and red-eye reduction. When set to **Tripod**, the flash mode setting is fixed at auto with slow sync and red-eye reduction.

⁴ May switch to slow sync with red-eye reduction flash mode.

⁵ **AF** (autofocus) or 📷 (macro close-up) can be selected.

⁶ The flash mode is fixed at 📷 (off) when using **Noise reduction burst**.

⁷ When **HDR** is set to **Off**, the flash mode is fixed at ⚡ (fill flash). When **HDR** is set to **On**, the flash mode is fixed at 📷 (off).

⁸ Pet portrait auto release can be set to on or off. Self-timer cannot be used.

⁹ When using **Nightscape + light trails**, **AF** (autofocus) or ▲ (infinity) can be selected.

When using **Star trails**, the focus mode is fixed at 📷 (infinity).



¹⁰ The focus is fixed at **AF** (autofocus) when using **Cityscape (10 minutes)**, at ▲ (infinity) when using **Landscape (25 minutes)** or **Sunset (50 minutes)**, or at 📷 (infinity) when using **Night sky (150 minutes)** or **Star trails (150 minutes)**.

¹¹ Can be selected from **AF** (autofocus) or ▲ (infinity).



Functions That Cannot Be Used Simultaneously When Shooting

Some functions cannot be used with other menu settings.

Restricted function	Setting	Description
Flash mode	Focus mode (📖61)	When ▲ (infinity) is selected, the flash cannot be used.
	Continuous (📖133)	The flash cannot be used (except for Intvl timer shooting).
	Exposure bracketing (📖139)	The flash cannot be used.
Self-timer/ Smile timer	Focus mode (📖61)	When a setting other than AF (autofocus) is selected, smile timer is set to OFF .
	AF area mode (📖140)	When Subject tracking is selected, the self-timer/ smile timer cannot be used.
Focus mode	Smile timer (📖60)	When smile timer is selected, the focus mode is fixed at AF (autofocus).
Image quality	Continuous (📖133)	<ul style="list-style-type: none"> When Pre-shooting cache is selected, Image quality is fixed at Normal. When Continuous H: 120 fps or Continuous H: 60 fps is selected, RAW, RAW + Fine, or RAW + Normal cannot be used.
	Multiple exposure (📖145)	When Multiple exposure mode is set to On , RAW , RAW + Fine , or RAW + Normal cannot be used.
Image size	Image quality (📖121)	<ul style="list-style-type: none"> When RAW is selected, Image size is fixed at 4608×3456. When RAW + Fine or RAW + Normal is selected, Image size of JPEG images can be set. However, 16:9 4608×2592, 3:2 4608×3072, or 1:1 3456×3456 cannot be selected.
	Continuous (📖133)	Image size is set as follows depending on the continuous shooting setting: <ul style="list-style-type: none"> Pre-shooting cache:  (image size: 1280 × 960 pixels) Continuous H: 120 fps:  (image size: 640 × 480 pixels) Continuous H: 60 fps:  (image size: 1920 × 1080 pixels)



Restricted function	Setting	Description
Picture Control	AF area mode (📖140)	When Subject tracking is selected, Monochrome cannot be set.
	Active D-Lighting (📖144)	When using Active D-Lighting , Contrast in manual adjustment cannot be adjusted.
White balance	Picture Control (📖124)	When Monochrome is selected, White balance is fixed at Auto (normal) .
Metering	Active D-Lighting (📖144)	When using Active D-Lighting , Metering is reset to Matrix .
Continuous Exposure bracketing	Continuous (📖133)/Exposure bracketing (📖139)/Multiple exposure (📖145)	Continuous , Exposure bracketing , and Multiple exposure can only be used one at a time.
	Self-timer (📖58)	<ul style="list-style-type: none"> • Even when Continuous H or Continuous L has been set, images are not captured continuously when the shutter-release button is released after the self-timer countdown has started. • Images are not captured continuously even when Pre-shooting cache has been set. • If Intvl timer shooting is set, shooting finishes automatically after one image is shot. • Exposure bracketing cannot be used.
	Smile timer (📖60)	<ul style="list-style-type: none"> • When the camera detects smiling faces and the shutter is released, only one image is shot. If Intvl timer shooting is set, shooting finishes automatically after one image is shot. • Exposure bracketing cannot be used.
	Image quality (📖121)	When RAW , RAW + Fine , or RAW + Normal is selected, Pre-shooting cache , Continuous H: 120 fps , or Continuous H: 60 fps cannot be used.
	Picture Control (📖124)	When Monochrome is selected, Exposure bracketing cannot be used.
ISO sensitivity	Continuous (📖133)	When Pre-shooting cache , Continuous H: 120 fps , or Continuous H: 60 fps is selected, ISO sensitivity is fixed at Auto .
	Movie options (📖150)	When the shooting mode is Movie manual and an HS movie option is selected in Movie options , ISO sensitivity is fixed at Auto .



Restricted function	Setting	Description
AF area mode	Smile timer (📖60)	The camera captures images using face detection regardless of the applied AF area mode option.
	Focus mode (📖61)	When a setting other than Subject tracking is selected and ▲ (infinity) is selected as the focus mode for shooting, the camera focuses at infinity regardless of the applied AF area mode option.
	Picture Control (📖124)	When Monochrome is selected, Subject tracking cannot be set.
	White balance (📖129)	When Target finding AF is selected and a white balance setting other than Auto (normal) is selected, the camera focuses on a face or selects one or more of the nine focus areas containing the subject closest to the camera.
Autofocus mode	Smile timer (📖60)	When smile timer is selected, the autofocus mode operates using the Single AF setting.
	Focus mode (📖61)	When ▲ (infinity) is selected in the focus mode, the autofocus mode operates using the Single AF setting.
Multiple exposure	Image quality (📖121)	When RAW , RAW + Fine , or RAW + Normal is selected, Multiple exposure cannot be used.
	Continuous (📖133)/Exposure bracketing (📖139)	Continuous , Exposure bracketing , and Multiple exposure can only be used one at a time.
Monitor settings	AF area mode (📖140)	<ul style="list-style-type: none"> • When the focus area is selected with the Manual (spot), Manual (normal), or Manual (wide) setting, the histogram is not displayed. • When Subject tracking is selected and after the subject has been registered (during subject tracking), the histogram is not displayed. • The histogram is not displayed when Target finding AF is selected.
Date stamp	Image quality (📖121)	When RAW , RAW + Fine , or RAW + Normal is selected, date and time cannot be stamped on images.
	Continuous (📖133)	When Pre-shooting cache , Continuous H: 120 fps , or Continuous H: 60 fps is selected, date and time cannot be stamped on images.



Restricted function	Setting	Description
Digital zoom	Smile timer (📖60)	When smile timer is selected, digital zoom cannot be used.
	Image quality (📖121)	When RAW , RAW + Fine , or RAW + Normal is selected, digital zoom cannot be used.
	AF area mode (📖140)	When Subject tracking is selected, digital zoom cannot be used.
	Zoom memory (📖147)	When Zoom memory is set to On , digital zoom cannot be used.
Shutter sound	Continuous (📖133)	When Pre-shooting cache , Continuous H: 120 fps , or Continuous H: 60 fps is selected, shutter sound is disabled.
	Exposure bracketing (📖139)	Shutter sound is disabled.

🗒️ Notes About Digital Zoom

- Depending on the shooting mode or the current settings, digital zoom may not be available (📖172).
- When digital zoom is in effect, selectable options for AF area mode or metering mode are restricted.



Playback Features

Playback Zoom.....	80
Thumbnail Playback/Calendar Display.....	81
Viewing and Deleting Images Captured Continuously (Sequence)	82
Editing Images (Still Images).....	83



Playback Zoom

Moving the zoom control toward **T** (📷 playback zoom) in full-frame playback mode (📖27) zooms in on the image.

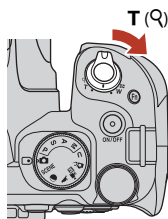

Full-frame Playback

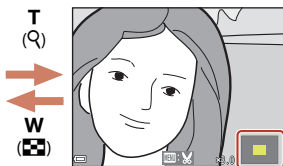

Image is zoomed in.

Displayed area guide

- You can change the magnification rate by moving the zoom control toward **W** (📐) or **T** (📷). The zoom can also be adjusted by rotating the command dial.
- To view a different area of the image, press the multi selector ▲▼◀▶.
- If you are viewing an image that was captured using face detection or pet detection, the camera zooms in on the face detected at the time of shooting (except images captured using **Continuous** or **Exposure bracketing**). To zoom in on an area of the image where there are no faces, adjust the magnification rate and then press ▲▼◀▶.
- When a zoomed image is displayed, press the **OK** button to return to full-frame playback mode.

Cropping Images

When a zoomed image is displayed, you can press the **MENU** button to crop the image to include only the visible portion and save it as a separate file (📖88).



Thumbnail Playback/Calendar Display

Moving the zoom control toward **W** (📷 thumbnail playback) in full-frame playback mode (📖27) displays images as thumbnails.

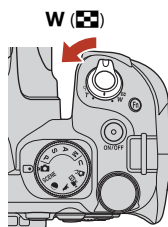

- You can change the number of thumbnails displayed by moving the zoom control toward **W** (📷) or **T** (📅).
- While using thumbnail playback mode, use the multi selector ▲▼◀▶ or rotate it to select an image, and then press the **OK** button to display that image in full-frame playback mode.
- While using calendar display mode, use ▲▼◀▶ or rotate it to select a date, and then press the **OK** button to display the images captured on that day.

✓ Notes About Calendar Display

Images captured when the camera's date is not set are treated as images captured on January 1, 2018.



Viewing and Deleting Images Captured Continuously (Sequence)

Viewing Images in a Sequence

Images captured continuously are saved as a sequence. The first image of a sequence is used as the key picture to represent the sequence when displayed in full-frame playback mode or thumbnail playback mode (default setting).

To display each image in the sequence individually, press the **OK** button.

After pressing the **OK** button, the operations listed below are available.

- To display the previous or next image, rotate the multi selector or press **◀▶**.
- To display images that are not included in the sequence, press **▲** to return to the key picture display.
- To display images in a sequence as thumbnails, or to play them back in a slide show, set **Sequence display options** (📖160) to **Individual pictures** in the playback menu.



✓ Sequence Display Options

- Images captured continuously with cameras other than this camera cannot be displayed as a sequence.
- If the number of sequences saved on the memory card in the camera exceeds 1,000, the images captured thereafter cannot be displayed as sequences. To continue capturing images in sequences, either delete sequences that you do not need to keep, or replace the memory card. However, even if you delete sequences, images that were not included in a sequence when they were captured cannot be displayed as a sequence.

📎 Playback Menu Options Available When Using Sequence

- When images in a sequence are displayed in full-frame playback mode, press the **MENU** button to select functions in playback menu (📖118).
- If you press the **MENU** button when a key picture is displayed, the following settings can be applied to all images in the sequence:
 - Mark for upload, Protect



Deleting Images in a Sequence

When the  (delete) button is pressed for images in a sequence, the images that are deleted vary depending on how the sequences are displayed.

- When the key picture is displayed:
 - **Current image:** All images in the displayed sequence are deleted.
 - **Erase selected images:** When a key picture is selected on the erase selected images screen (115), all images in that sequence are deleted.
 - **All images:** All images on the memory card are deleted.
- When images in a sequence are displayed in full-frame playback mode:
 - **Current image:** The image currently displayed is deleted.
 - **Erase selected images:** Images that are selected in the sequence are deleted.
 - **Entire sequence:** All images in the displayed sequence are deleted.

Editing Images (Still Images)

Before Editing Images



You can easily edit images on this camera. Edited copies are saved as separate files. Edited copies are saved with the same shooting date and time as the original.

Restrictions on Image Editing

- RAW images and images captured using easy panorama cannot be edited.
- A JPEG image can be edited up to 10 times. A still image created by editing a movie can be edited up to 9 times.
- You may not be able to edit images of a certain size or with certain editing functions.



Quick Retouch: Enhancing Contrast and Saturation



Press the  button (playback mode) → Select an image → MENU button → Quick retouch →  button

Use the multi selector ▲▼ to select the desired effect level and press the  button.

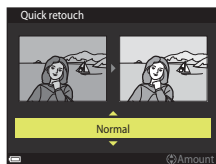
- The edited version is displayed on the right.
- To exit without saving the copy, press .



D-Lighting: Enhancing Brightness and Contrast



Press the  button (playback mode) → Select an image → MENU button → D-Lighting →  button

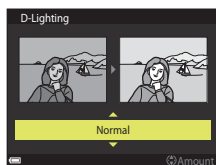

Use the multi selector ▲▼ to select the desired effect level and press the  button.

- The edited version is displayed on the right.
- To exit without saving the copy, press .





Skin Softening: Softening Skin Tones

Press the  button (playback mode) → Select an image → **MENU** button → Skin softening →  button

- 1 Use the multi selector   to select the desired effect level and press the  button.

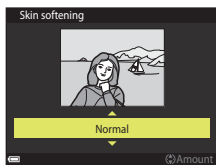
- To exit without saving the copy, press .



- 2 Preview the result and press the  button.

- The edited face is zoomed in.
- When more than one face has been edited, press  to switch the face that is displayed.
- To change the effect level, press the **MENU** button and return to step 1.
- An edited copy is created.





Notes About Skin Softening



- The skin tones can be enhanced for up to 12 faces, starting with the one closest to the center of the frame and moving outward.
- Depending on the direction in which faces are looking, or the brightness of faces, the camera may be unable to accurately detect faces, or the skin softening function may not perform as expected.
- If no faces are detected, a warning is displayed and the screen returns to the playback menu.



Filter Effects: Applying Digital Filter Effects

Press the  button (playback mode) → Select an image → MENU button → Filter effects →  button

Option	Description
Soft portrait	Blurs the background of human subjects. When no human subjects are detected, keeps the area in the center of the frame in focus and blurs the surrounding area.
Selective color	Keeps only a selected image color and makes other colors black-and-white.
Cross screen	Produces star-like rays of light that radiate outward from bright objects such as sunlight reflections and city lights. Suitable for night scenes.
Fisheye	Creates images that look like they were shot with a fisheye lens. Suitable for images shot in macro mode.
Miniature effect	Creates images that look like close-up photos of a diorama. Suitable for images shot while looking down from a high location, with the main subject near the center of the frame.
Painting	Creates images with the ambience of paintings.
Vignette	Lowers the peripheral light intensity from the center to the edges of an image.
Photo illustration	Emphasizes outlines and reduces the number of colors to create images with the ambience of illustrations.
Portrait (color + B&W)	Makes colors of the background of human subjects black-and-white. When no human subjects are detected, keeps colors of the area in the center of the frame and makes the surrounding area black-and-white.

1 Use the multi selector   to select the desired filter effect and press the  button.

- When effects other than **Selective color** are selected, proceed to step 3.

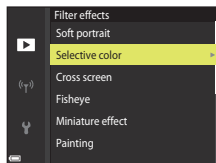

- 2 Use ▲▼ to select the color to keep and press the **OK** button.



- 3 Preview the result and press the **OK** button.

- An edited copy is created.
- To exit without saving the copy, press ◀.



Small Picture: Reducing the Size of an Image

Press the  button (playback mode) → Select an image → MENU button → Small picture → **OK** button

- 1 Use the multi selector ▲▼ to select the desired copy size and press the **OK** button.

- When the aspect ratio of the image is 16:9, the image size is fixed at **640 × 360**. Press the **OK** button to proceed to step 2.

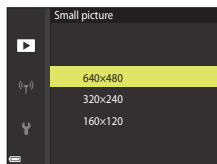

- 2 Select **Yes** and press the **OK** button.

- An edited copy is created (compression ratio of approximately 1:8).

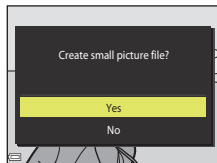

Notes About Small Picture

When the aspect ratio of the image is 3:2 or 1:1, the image cannot be edited.



Crop: Creating a Cropped Copy

1 Move the zoom control to enlarge the image (📖80).

2 Adjust the image so that only the portion that you want to keep is displayed, and then press the **MENU** (menu) button.

- Move the zoom control toward **T** (🔍) or **W** (📐) to adjust the magnification rate. Set a magnification rate at which **100%** is displayed.
- Use the multi selector **▲▼◀▶** to scroll to the portion of the image that you want to display.



3 Check the image and press the **OK** button.

- To change the portion you want to keep, return to step 2 by pressing **◀**.
- To exit without saving the cropped image, press the **MENU** button.

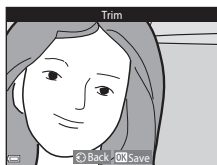

4 Select **Yes** and press the **OK** button.

- An edited copy is created.



✓ **Notes About Cropping**

Images captured using easy panorama cannot be edited.

📐 **Image Size**

- The aspect ratio (horizontal to vertical) of the cropped copy is the same as the original.
- When the image size of the cropped copy is 320 × 240 or smaller, the image is displayed at a smaller size during playback.



Movies

Basic Operations of Movie Recording and Movie Playback	90
Capturing Still Images While Recording Movies	93
Movie Manual (Setting the Exposure for Movie Recording)	94
Shooting Time-lapse Movies	96
Recording Superlapse Movies	98
Operations During Movie Playback	99
Editing Movies	100



Basic Operations of Movie Recording and Movie Playback

1 Display the shooting screen.

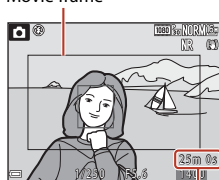

- Check the remaining amount of movie recording time (📖91, 150).
- It is recommended that you display the movie frame that indicates the area that will be recorded in a movie (📖91).

Movie frame



Remaining movie recording time

2 Press the (movie-record) button to start movie recording.

- The camera focuses on the subject in the center of the frame.
- Press the  button to pause recording, and press the  button again to resume recording (except when an HS movie option is selected in **Movie options**). Recording automatically ends if it remains paused for about five minutes.
- You can capture a still image by pressing the shutter-release button while recording a movie (📖93).

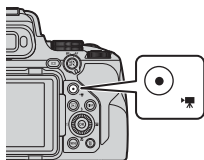

3 Press the (movie-record) button again to end recording.

4 Select a movie in full-frame playback mode and press the button to play it back.

- An image with a movie options icon is a movie.

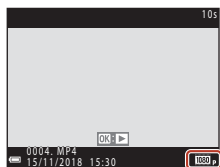

Movie options



Movie Frame

- Press the **DISP** button to display the movie frame (📖8). Check the range of a movie in the frame before movie recording.
- The area that is recorded in a movie varies depending on the settings of **Movie options**, **Electronic VR**, etc. in the movie menu.

Focusing

- The focus can be adjusted during movie recording in the following manner in accordance with the **Autofocus mode** (📖153) setting of the movie menu.
 - **AF-S Single AF** (default setting): The focus is locked when movie recording starts. To perform the autofocus function during movie recording, press the multi selector ◀.
 - **AF-F Full-time AF**: The focus is adjusted repeatedly even during movie recording. The button that locks the focus depends on the setting for **AE/AF lock button** (📖175) in the setup menu. When **AE/AF lock** or **AF lock only** is selected, press the $\overline{\text{AE-L/AF-L}}$ (AE-L/AF-L) button (📖5) during movie recording to lock the focus. To unlock, press the $\overline{\text{AE-L/AF-L}}$ button again. When **AE lock only** or **AE lock (Hold)** is selected, press the multi selector ◀ during movie recording to lock the focus. To unlock, press ◀ again.
- When the focus-mode selector is set to **MF** (manual focus), you can adjust the focus manually while recording movies by rotating the multi selector or control ring.

Exposure

The button that locks the exposure depends on the setting for **AE/AF lock button** (📖175) in the setup menu. When **AE/AF lock**, **AE lock only**, or **AE lock (Hold)** is selected, press the $\overline{\text{AE-L/AF-L}}$ (AE-L/AF-L) button (📖5) during movie recording to lock the exposure. To unlock, press the $\overline{\text{AE-L/AF-L}}$ button again. When **AF lock only** is selected, press the multi selector ▶ during movie recording to lock the exposure. To unlock, press ▶ again.

Maximum Movie Recording Time

Individual movie files cannot exceed 29 minutes in length, even when there is sufficient free space on the memory card for longer recording. The maximum file size for individual movie files is 4 GB. When recording a movie longer than approximately six minutes at an image size/frame rate of **2160/30p** (4K UHD) or longer than approximately seven minutes at an image size/frame rate of **2160/25p** (4K UHD), multiple files are created when the file size of the recorded movie exceeds 4 GB, and the files cannot be played back continuously (📖150).

- The remaining recording time for a single movie is displayed on the shooting screen.
- Recording may end before either limit is reached if camera temperature becomes elevated.
- The actual remaining recording time may vary depending on the movie content, subject movement, or type of memory card.



- Memory cards with an SD Speed Class rating of 6 or faster are recommended for recording movies (when recording 4K UHD movies at an image size/frame rate of **2160/30p** or **2160/25p**, cards rated UHS Speed Class 3 or faster are recommended). When using a memory card with a lower Speed Class rating, movie recording may stop unexpectedly.

Camera Temperature

- The camera may become hot when recording movies for an extended period of time or when the camera is used in a hot area.
- If the inside of the camera becomes extremely hot when recording movies, the camera will automatically stop recording. The amount of time remaining until the camera stops recording (🕒10s) is displayed.
After the camera stops recording, it turns itself off.
Leave the camera off until the inside of the camera has cooled.

Notes About Movie Recording

Notes About Saving Images or Movies

The indicator showing the number of exposures remaining or the indicator showing the remaining recording time flashes while images or movies are being saved. **Do not open the battery-chamber/memory card slot cover or remove the battery or memory card** while an indicator is flashing. Doing this could result in loss of data, or in damage to the camera or the memory card.

Notes About Recorded Movies

- The sounds of control ring operation, zoom control operation, zoom, autofocus lens drive movement, vibration reduction, and aperture operation when brightness changes may be recorded.
- The following phenomena may be seen on the screen while recording movies. These phenomena are saved in the recorded movies.
 - Banding may occur in images under fluorescent, mercury-vapor, or sodium-vapor lighting.
 - Subjects that move quickly from one side of the frame to the other, such as a moving train or car, may appear skewed.
 - The entire movie image may be skewed when the camera is panned.
 - Lighting or other bright areas may leave residual images when the camera is moved.
- Depending on the distance to the subject or the amount of zoom applied, colored stripes may appear on subjects with repeating patterns (fabrics, lattice windows, etc.) during movie recording and playback. This occurs when the pattern in the subject and the layout of the image sensor interfere with each other; it is not a malfunction.

Notes About Autofocus for Movie Recording



Autofocus may not perform as expected (📖65). Should this occur, focus using manual focus (📖67) or try the following:

1. Set **Autofocus mode** in the movie menu to **Single AF** (default setting) before starting movie recording.
2. Frame another subject (positioned at the same distance from the camera as the intended subject) in the center of the frame, press the  button to start recording, and modify the composition.







Capturing Still Images While Recording Movies

If the shutter-release button is pressed all the way while recording a movie, one frame is saved as a still image (JPEG image). Movie recording continues while the still image is being saved.

- A still image can be captured when  is displayed on the screen. When  is displayed, a still image cannot be captured.
- The size of the captured still image is determined by the movie image size (150).



Notes About Capturing Still Images During Movie Recording

- Still images cannot be saved during movie recording in the following situations:
 - When movie recording is paused
 - When the remaining movie recording time is less than five seconds
 - When **Movie options** (150) is set to HS movie
- When **Image quality** (121) in the shooting menu is set to **RAW** or **RAW + Fine**, a still image is captured as **Fine**. When **Image quality** is set to **RAW + Normal**, it is captured as **Normal**.
- Up to 20 still images can be saved while recording a single movie when **Movie options** is set to  **2160p** **2160/30p** or  **2160p** **2160/25p**. Still images are captured as **Fine**.
- It may take some time to save the images after shooting.
- The frames of a movie that were recorded when a still image was being captured may not play back smoothly.
- The sounds of operating the shutter-release button when saving a still image may be heard in the recorded movie.
- If the camera moves when the shutter-release button is pressed, the image may be blurred.



Movie Manual (Setting the Exposure for Movie Recording)

In Movie manual mode, you can use the aperture-priority auto or manual setting to set the exposure (shutter speed and f-number) when recording movies.

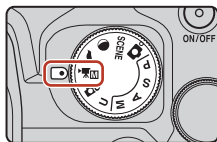

Aperture-priority auto (default setting)	When the f-number is set, the camera automatically determines the shutter speed. You can change the f-number to bring the subject, foreground and background into focus, or to blur the subject's background intentionally.
Manual	Set both the shutter speed and f-number.

- 1 Press the **MENU** button, select **Exposure mode** in the Movie manual mode menu, and press the **OK** button.

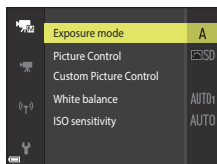

- 2 Select **Aperture-priority auto** or **Manual**, and press the **OK** button.
 - Configure settings for **Picture Control**, **Custom Picture Control**, **White balance**, or **ISO sensitivity** according to the shooting conditions and shooting requirements.

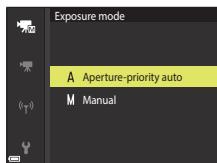

- 3 Press the **MENU** button to display the shooting screen.
- 4 Set the exposure.
 - Rotate the command dial to set the shutter speed. Rotate the multi selector to set the f-number.





5 Press the (movie-record) button to start recording the movie.



- The shutter speed or f-number can also be set during movie recording (except when an HS movie option is selected in **Movie options**).
- To capture a still image during movie recording, press the shutter-release button all the way (93).



Notes About Movie Manual Mode

- In Movie manual mode, you cannot capture a still image if you press the shutter-release button before pressing the  button.
- In Movie manual mode, you cannot adjust the focus even when you press the shutter-release button halfway before starting movie recording. To adjust the focus before starting movie recording, set **Autofocus mode** (153) in the movie menu to **Full-time AF** or use manual focus (67).





Notes About ISO Sensitivity

- In Movie manual mode, the lowest ISO sensitivity is ISO 125.
- When **Manual** is selected for **Exposure mode** in Movie manual mode and **ISO sensitivity** (137) is set to **Auto**, **ISO 125-400**, or **ISO 125-800**, the ISO sensitivity is fixed at ISO 125.
- When an HS movie option is selected in **Movie options** (150), the ISO sensitivity is fixed at **Auto**.

Shutter Speed

When the shutter speed setting is closer to the movie frame rate, the motion appears smoother.

Functions That Can Be Set in Movie Manual Mode

- Self-timer (58)
- Focus mode (61)
- Exposure compensation (69)
- Movie manual mode menu (149)
- Movie menu (150)







Shooting Time-lapse Movies

The camera can automatically capture still images at a specified interval to create time-lapse movies that are approximately 10 seconds long.

- When the **Frame rate** setting of the movie menu is set to **30 fps (30p/60p)**, 300 images are captured and saved with **1080 P/60 1080/30p**. When set to **25 fps (25p/50p)**, 250 images are captured and saved with **1080 P/25 1080/25p**.



Rotate the mode dial to **SCENE** → **MENU** button →  Time-lapse movie →  button

Type (required shooting time)	Interval time	
	30 fps (30p/60p)	25 fps (25p/50p)
 Cityscape (10 minutes) ¹ (default setting)	2 s	2.4 s
 Landscape (25 minutes) ¹	5 s	6 s
 Sunset (50 minutes) ¹	10 s	12 s
 Night sky (150 minutes) ²	30 s	36 s
 Star trails (150 minutes) ³	30 s	36 s

¹ The camera focuses on the area in the center of the frame.

² Suited for recording the movement of stars.

³ Star movement appears as lines of light due to image processing.

- 1 Use the multi selector  to select a type, and press the  button.

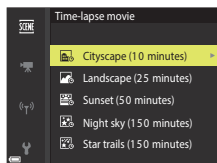

- 2 Select whether or not to fix exposure (brightness), and press the  button (except Night sky and Star trails).

- When **AE-L on** is selected, the exposure used for the first image is used for all images. When the brightness changes drastically like at dusk, **AE-L off** is recommended.

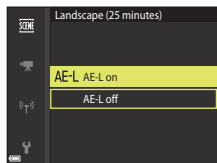

3 Stabilize the camera by using a tool such as a tripod.

- See “Using a Tripod” (📖23) when using a tripod.

4 Press the shutter-release button to capture the first image.

- Set exposure compensation (📖69) before releasing the shutter for the first image (when using **Night sky (150 minutes)** or **Star trails (150 minutes)**, exposure compensation cannot be used). Exposure compensation cannot be changed after the first image is captured. Focus and hue are fixed when the first image is captured.
- When capturing images of stars, it is recommended that you use manual focus (📖67).
- The auto off function is disabled during shooting (📖176).
- The shutter is automatically released for the second and subsequent images.
- The screen may turn off while the camera is not capturing images.
- Shooting ends automatically when 300 or 250 images are captured.
- Press the **OK** button to end shooting before the required shooting time elapses and create a time-lapse movie.
- Sound and still images cannot be saved.

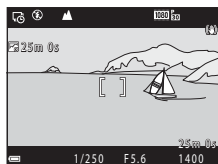

✓ Notes About Time-lapse Movie

- Do not exchange the memory card until shooting is complete.
- Use a sufficiently charged battery to prevent the camera from turning off unexpectedly.
- Time-lapse movies cannot be recorded by pressing the **●** (📷) button.
- Do not rotate the mode dial to a different setting until shooting is complete.



Recording Superlapse Movies

The camera records movies and saves them in fast motion (**1080 P 1080/30p** or **1080 P 1080/25p**). Use to record a movie while moving the camera. The camera compresses the time of changes in the subject and saves the movie.

Rotate the mode dial to **SCENE** → **MENU** button → Superlapse movie → **OK** button

1 Use the multi selector ▲▼ to select a playback speed, and press the **OK** button.

- At the default setting of **2x**, a movie recorded for two minutes is played back as a one-minute movie.
- If the recording time of an individual movie file exceeds 29 minutes, recording ends automatically.

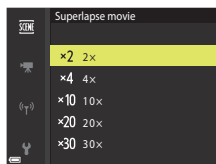

2 Press the **REC** (movie-record) button to start recording.

- You can check the recording time and playback time on the screen.
- It is recommended that you display the movie frame that indicates the area that will be recorded in a movie (91).
- Sound is not recorded.



Recording time

Playback time

Shooting Still Images

- A still image (**25M** (1920 × 1080 pixels)) can be captured if you press the shutter-release button before pressing the **REC** (movie-record) button.
- You can shoot still images while recording movies (93).



Operations During Movie Playback

To adjust the volume, move the zoom control while a movie is playing (📖2).

Rotate the multi selector or the command dial to fast-forward or rewind.



Playback controls are displayed on the screen.

The operations described below can be performed by using the multi selector ◀▶ to select a control and then pressing the Ⓞ button.



Function	Icon	Description	
Rewind	◀◀	Hold down the Ⓞ button to rewind the movie.	
Fast-forward	▶▶	Hold down the Ⓞ button to fast-forward the movie.	
Pause	⏸	Pause playback. The operations listed below can be performed while paused.	
		◀⏮	Rewind the movie one frame. Hold down the Ⓞ button for continuous rewinding.*
		▶⏭	Advance the movie one frame. Hold down the Ⓞ button for continuous advancing.*
		▶	Resume playback.
		📄	Extract the desired portion of a movie and save it as a separate file.
End	■	Extract a single frame of a movie and save it as a still image.	
		Return to full-frame playback mode.	

* The movie can also be advanced or rewound by one frame by rotating the multi selector or command dial.



Editing Movies

When editing movies, use a sufficiently charged battery to prevent the camera from turning off during editing.

Extracting Only the Desired Portion of a Movie

The desired portion of a recorded movie can be saved as a separate file.

1 Play back a desired movie and pause at the start point of the portion that you want to extract (📖99).

2 Use the multi selector ◀▶ to select the 📺 control, and then press the ⓄK button.

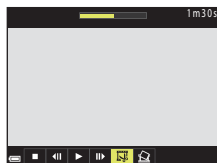

3 Use ▲▼ to select 📺 (choose start point).

- Use ◀▶ or rotate the command dial to move the start point.
- To cancel editing, select ↶ (back), and press the ⓄK button.

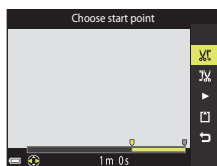

4 Use ▲▼ to select 📺 (choose end point).

- Use ◀▶ or rotate the command dial to move the end point.
- To preview the specified portion, use ▲▼ to select ▶ and then press the ⓄK button. Press the ⓄK button again to stop previewing.

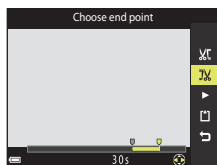

5 Use ▲▼ to select (save) and press the button.

- Follow the instructions on the screen to save the movie.

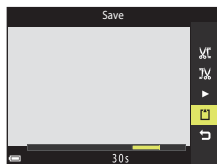





Notes About Movie Extracting



- A movie that was created by editing cannot be edited again.
- The actual trimmed portion of a movie may differ slightly from the portion selected using the start and end points.
- Movies cannot be trimmed so that they are less than two seconds long.

Saving a Frame from a Movie as a Still Image

The desired frame of a recorded movie can be extracted and saved as a still image.

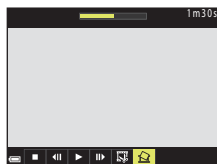
- Pause a movie and display the frame to be extracted (99).
- Use the multi selector  to select the  control and press the  button.



- Select **Yes** when a confirmation dialog is displayed, and press the  button to save the image.
- The still image is saved with **Normal** as the image quality. The image size is determined by the original movie image size (150).

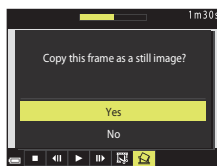

Restrictions on Extracting Still Images

Still images cannot be extracted from a movie recorded with an HS movie option.



Connecting the Camera to a TV, Printer, or Computer

Utilizing Images	103
Viewing Images on a TV	104
Printing Images Without a Computer	105
Transferring Images to a Computer (NX Studio)	109



Utilizing Images

In addition to using the SnapBridge app to enjoy the captured images, you can also utilize the images in various ways by connecting the camera to the devices described below.

Viewing Images on a TV



Images and movies captured with the camera can be viewed on a TV. Connection method: Connect a commercially available HDMI cable to the TV's HDMI input jack.

Printing Images Without a Computer



If you connect the camera to a PictBridge-compatible printer, you can print images without using a computer. Connection method: Connect the camera directly to the printer's USB port with the USB cable.

Transferring Images to a Computer (NX Studio)



You can transfer images and movies to a computer for viewing and editing. Connection method: Connect the camera to the computer's USB port with the USB cable.

- Before connecting to a computer, install NX Studio on the computer.

✓ Notes About Connecting Cables to the Camera

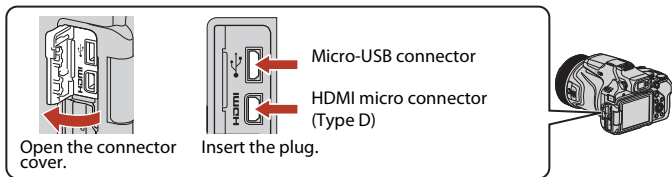

- Make sure to turn the camera off before connecting or disconnecting cables. Check the shape and direction of the plugs and do not insert or remove the plugs at an angle.
- Make sure that the camera battery is sufficiently charged. If the EH-5b/EH-5c AC Adapter and the EP-5C Power Connector (both available separately) are used, this camera can be powered from an electrical outlet. Do not, under any circumstances, use an AC adapter other than the EH-5b/EH-5c. Failure to observe this precaution could result in overheating or damage to the camera.
- For information about the connection methods and subsequent operations, refer to the documentation included with the device in addition to this document.



Viewing Images on a TV

1 Turn off the camera and connect it to the TV.

- Check the shape and direction of the plugs and do not insert or remove the plugs at an angle.

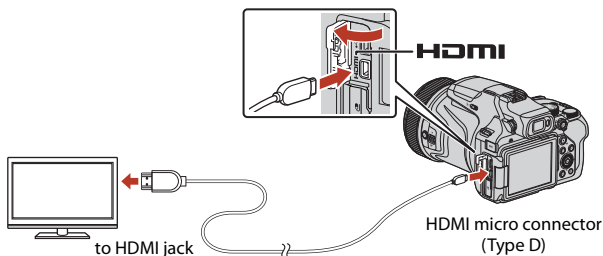

2 Set the TV's input to external input.

- See the documentation provided with your TV for details.

3 Press and hold down the (playback) button to turn on the camera.

- Images are displayed on the TV.
- The camera screen does not turn on.
- When you turn on the camera using the power switch, the shooting screen is displayed on the TV.

To show the captured images and movies on the TV, press the  (playback) button to enter playback mode.

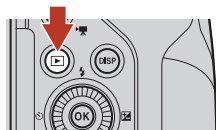

Notes About Connecting the HDMI Cable

When using a USB cable, the camera cannot perform HDMI output to the TV.

Playing Back 4K Movies

To play back movies that are recorded with **2160/30p** (4K UHD) or **2160/25p** (4K UHD) in 4K UHD image quality, use a television and HDMI cable that are compatible with 4K. Also, set **Clean HDMI output** ( 177) in **HDMI** in the setup menu to **Off**.

- When playing back 4K movies on certain TVs, the first few seconds may not be displayed because it takes some time for the TV to adjust the display to match the output from the camera.



Printing Images Without a Computer

Users of PictBridge-compatible printers can connect the camera directly to the printer and print images without using a computer.

Connecting the Camera to a Printer

- 1 Turn on the printer.
- 2 Turn off the camera and connect it to the printer using the USB cable.
 - Check the shape and direction of the plugs and do not insert or remove the plugs at an angle.

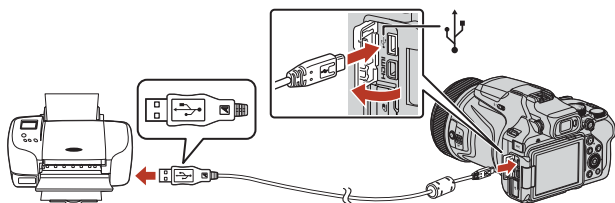

- 3 The camera is automatically turned on.
 - The **PictBridge** startup screen (①) is displayed on the camera screen, followed by the **Print selection** screen (②).

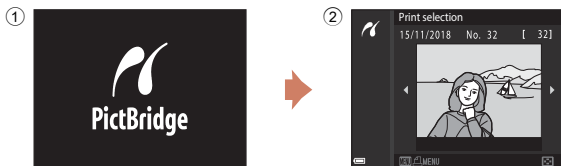

✓ If the PictBridge Startup Screen Is Not Displayed

When **Auto** is selected for **Charge by computer** (179), it may be impossible to print images with direct connection of the camera to some printers.

If the PictBridge startup screen is not displayed after the camera is turned on, turn the camera off and disconnect the USB cable. Set **Charge by computer** to **Off** and reconnect the camera to the printer.



Printing Images One at a Time

1 Use the multi selector ◀▶ to select the desired image and press the **OK** button.

- Move the zoom control toward **W** (📐) to switch to thumbnail playback or **T** (📺) to switch to full-frame playback.

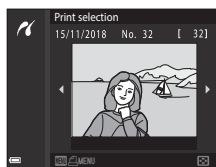

2 Use ▲▼ to select **Copies** and press the **OK** button.

- Use ▲▼ to set the desired number of copies (up to nine) and press the **OK** button.

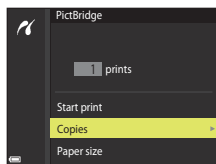

3 Select **Paper size** and press the **OK** button.

- Select the desired paper size and press the **OK** button.
- To print with the paper size setting configured on the printer, select **Default**.
- The paper size options available on the camera vary depending on the printer that you use.

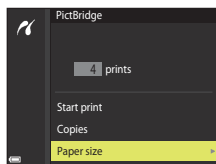

4 Select **Start print** and press the **OK** button.

- Printing starts.

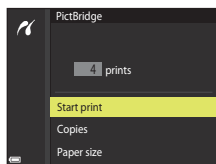

Printing Multiple Images

- 1 When the **Print selection** screen is displayed, press the **MENU** (menu) button.

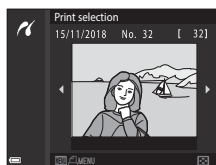

- 2 Use the multi selector ▲▼ to select **Paper size** and press the **OK** button.
 - Select the desired paper size and press the **OK** button.
 - To print with the paper size setting configured on the printer, select **Default**.
 - The paper size options available on the camera vary depending on the printer that you use.
 - To exit the print menu, press the **MENU** button.

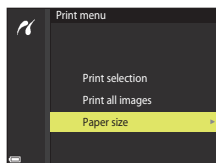

- 3 Select **Print selection** or **Print all images** and press the **OK** button.

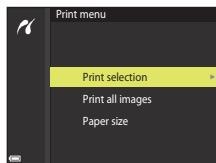

Print selection

Select images (up to 99) and the number of copies (up to 9) of each.

- Use the multi selector ◀▶ to select images, and use ▲▼ to specify the number of copies to be printed.
- Images selected for printing are indicated by 📄 and the number of copies to be printed. To cancel the print selection, set the number of copies to 0.
- Move the zoom control toward **T** (🔍) to switch to full-frame playback or **W** (🖼️) to switch to thumbnail playback.
- Press the **OK** button when setting is complete. When the screen for confirming the number of print copies is displayed, select **Start print** and press the **OK** button to start printing.



Print all images

One copy each of all images saved on the memory card is printed.

- When the screen for confirming the number of print copies is displayed, select **Start print** and press the **OK** button to start printing.



Transferring Images to a Computer (NX Studio)

Connect the camera using the supplied USB cable. You can then use Nikon NX Studio software to copy pictures to the computer for viewing and editing.

Installing NX Studio

You will need an Internet connection when installing NX Studio. Visit the Nikon website for system requirements and other information.

- Download the latest NX Studio installer from the website below and follow the onscreen instructions to complete installation.
<https://downloadcenter.nikonimglib.com/>
- Note that you may be unable to download pictures from the camera using earlier versions of NX Studio.

Copying pictures to a computer using NX Studio

See online help for detailed instructions.

1 Connect the camera to the computer.

- After turning the camera off and ensuring that a memory card is inserted, connect the supplied USB cable as shown.

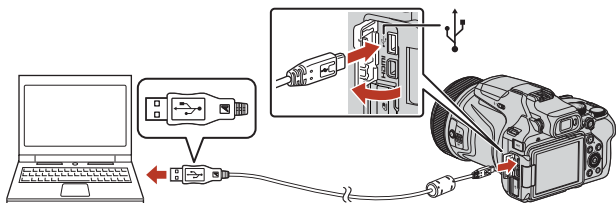

2 Turn the camera on.

- The Nikon Transfer 2 component of NX Studio will start. Nikon Transfer 2 image transfer software is installed with NX Studio.
- If a message is displayed prompting you to choose a program, select Nikon Transfer 2.
- If Nikon Transfer 2 does not start automatically, launch NX Studio and click the "Import" icon.



3 Click **Start Transfer**.

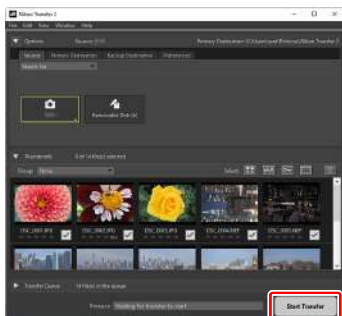

- Pictures on the memory card will be copied to the computer.

4 Turn the camera off.

- Disconnect the USB cable when transfer is complete.

✔ **Windows 10 and Windows 8.1**

Windows 10 and Windows 8.1 may display an AutoPlay prompt when the camera is connected.



Click the dialog and then click **Nikon Transfer 2** to select Nikon Transfer 2.

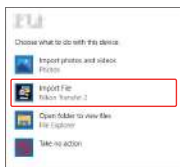

macOS

If Nikon Transfer 2 does not start automatically, confirm that the camera is connected and then launch Image Capture (an application that comes with macOS) and select Nikon Transfer 2 as the application that opens when the camera is detected.

Transferring videos

Do not attempt to transfer videos from the memory card while it is inserted in a camera of a different make or model. Doing so could result in the videos being deleted without being transferred.

Connecting to computers

- Do not turn the camera off or disconnect the USB cable while transfer is in progress.
- Do not use force or attempt to insert the connectors at an angle. Be sure also to keep the connectors straight when disconnecting the cable.
- Always turn the camera off before connecting or disconnecting a cable.
- Disconnect all other USB-powered devices from the computer. Connecting the camera and other USB-powered devices to the same computer simultaneously may cause a camera malfunction or excessive power supply from the computer, which could damage the camera or memory card.
- Make sure that the camera battery is sufficiently charged. If the EH-5b/EH-5c AC Adapter and the EP-5C Power Connector (both available separately) are used, this camera can be powered from an electrical outlet. Do not, under any circumstances, use an AC adapter other than the EH-5b/EH-5c. Failure to observe this precaution could result in overheating or damage to the camera.

USB hubs

Connect the camera directly to the computer; do not connect the cable via a USB hub or keyboard. Connect the camera to a pre-installed USB port.

Using a card reader

Pictures can also be copied from a memory card inserted in a third-party card reader. You should however check that the card is compatible with the card reader.









Using the Menu

Menu Operations.....	113
Menu Lists	116
The Shooting Menu (The Common Shooting Options)	121
The Shooting Menu (P , S , A , or M Mode).....	124
The Movie Manual Mode Menu	149
The Movie Menu	150
The Playback Menu.....	157
The Network Menu	161
The Setup Menu.....	164



Menu Operations

You can set the menus listed below by pressing the **MENU** (menu) button.

-  **Shooting menu**^{1, 2}
-  **Movie manual mode menu**³
-  **Movie menu**¹
-  **Playback menu**⁴
-  **Network menu**
-  **Setup menu**

¹ Press the **MENU** button when the shooting screen is displayed.

² Menu icons and available setting options vary depending on the shooting mode.

³ Rotate the mode dial to  (Movie manual), and press the **MENU** button when the shooting screen is displayed.

⁴ Press the **MENU** button when the playback screen is displayed.

1 Press the **MENU** (menu) button.

- The menu is displayed.

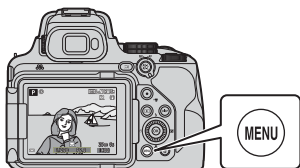

2 Press the multi selector .

- The current menu icon is displayed in yellow.

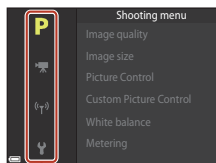

Menu icons

3 Select a menu icon and press the button.

- The menu options become selectable.

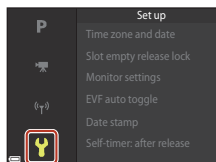

4 Select a menu option and press the **OK** button.

- Certain menu options cannot be set depending on the current shooting mode or the state of the camera.
- Items can also be selected by rotating the multi selector.

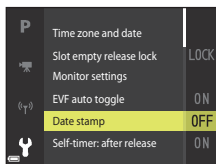

5 Select a setting and press the **OK** button.

- The setting you selected is applied.
- When you are finished using the menu, press the **MENU** button.
- When a menu is displayed, you can switch to shooting mode by pressing the shutter-release button or **Q** button.

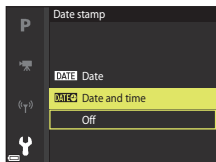

Using the **Fn (Function) Button**

If you press the **Fn** button in **P**, **S**, **A**, **M**, or **U** mode, you can quickly configure the pre-saved menu options (default setting is **Continuous**). To set a different menu option, select **Fn Fn** button and select the desired menu option.

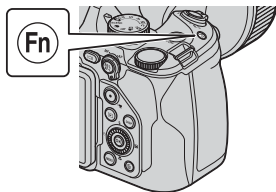

The Image Selection Screen

When an image selection screen such as the one shown on the right is displayed while operating the camera menu, follow the procedures described below to select the images.

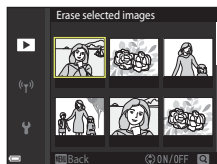

1 Use the multi selector ◀▶ or rotate it to select the desired image.

- Move the zoom control (📖2) toward **T** (📺) to switch to full-frame playback, or **W** (📷) to switch to thumbnail playback.
- Only one image can be selected for **Rotate image** and **Choose key picture**. Proceed to step 3.

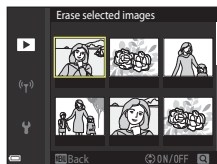

2 Use ▲▼ to select **ON** or **OFF**.

- When **ON** is selected, an icon is displayed under the selected image. Repeat steps 1 and 2 to select additional images.

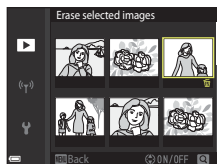

3 Press the **OK** button to apply the image selection.

- When a confirmation dialog is displayed, follow the on-screen instructions to operate.





Menu Lists

The Shooting Menu

Enter shooting mode → MENU button

Common Options (Except Movie Manual Mode)

Option	Default setting	
Image quality*	Normal	121
Image size*	 4608×3456	123

* Also can be set by pressing the Fn button ( 114).

For P, S, A, M, and U Modes



Option	Default setting	
Picture Control*	Standard	124
Custom Picture Control	–	128
White balance*	Auto (normal)	129
Metering*	Matrix	132
Continuous*	Single	133
ISO sensitivity*	<ul style="list-style-type: none">• ISO sensitivity: Auto• Minimum shutter speed: None	137
Exposure bracketing	Off	139
AF area mode*	Target finding AF	140
Autofocus mode	Full-time AF	143
Flash exp. comp.	0.0	143
Noise reduction filter	Normal	144
Active D-Lighting	Off	144
Multiple exposure	<ul style="list-style-type: none">• Multiple exposure mode: Off• Auto gain: On	145
Save user settings	–	53
Reset user settings	–	53



Option	Default setting	
Zoom memory	Off	147
Startup zoom position	24 mm	148
M exposure preview	Off	148

* Also can be set by pressing the **Fn** button ( 114).



The Movie Manual Mode Menu

Rotate the mode dial to  (Movie manual) → MENU button →  menu icon →  button

Option	Default setting	
Exposure mode	Aperture-priority auto	94
Picture Control	Standard	124
Custom Picture Control	–	128
White balance	Auto (normal)	129
ISO sensitivity	<ul style="list-style-type: none"> • ISO sensitivity: Auto • Minimum shutter speed: None 	137

The Movie Menu

Enter shooting mode → MENU button →  menu icon →  button

Option	Default setting	
Movie options	 1080/30p or  1080/25p	150
Autofocus mode	Single AF	153
Electronic VR	On	154
Wind noise reduction	Off	154
Zoom microphone	On	155
Frame rate	–	155
External mic sensitivity	Auto sensitivity	156



The Playback Menu

Press the  button (playback mode) → MENU button

Option	
Mark for upload ¹	157
Quick retouch ²	84
D-Lighting ²	84
Skin softening ²	85
Filter effects ²	86
Slide show	158
Protect ¹	159
Rotate image ¹	159
Small picture ²	87
Sequence display options	160
Choose key picture ¹	160

¹ Select an image on the image selection screen. See “The Image Selection Screen” (📖 115) for more information.

² Edited images are saved as separate files. Some images may not be edited.

The Network Menu

Press the MENU button →  menu icon →  button

Option	
Airplane mode	161
Choose connection	161
Connect to smart device	161
Connection to remote	161
Send while shooting	161
Wi-Fi	162
Bluetooth	162



Option	
Restore default settings	162

The Setup Menu

Press the MENU button →  menu icon →  button

Option	
Time zone and date	164
Slot empty release lock	166
Monitor settings	167
EVF auto toggle	169
Date stamp	169
Self-timer: after release	170
Vibration reduction*	171
AF assist	172
Digital zoom	172
Assign side zoom control	173
Snap-back zoom	173
Control ring options	174
AE/AF lock button	175
Sound settings	175
Auto off	176
Format card	176
Language	176
HDMI	177
Charge by computer	179
Image comment	180
Copyright information	181
Location data	182
Toggle Av/Tv selection	182



Option	
Reset file numbering	183
Peaking	184
Reset all	184
Firmware version	184

* Also can be set by pressing the **Fn** button (114).



The Shooting Menu (The Common Shooting Options)

Image Quality

Enter shooting mode* → MENU button → shooting mode menu icon → Image quality →  button



* The image quality can be set in any shooting mode other than Movie manual. The setting is also applied to other shooting modes (except shooting mode **U** and **Easy panorama** scene mode).

Set the image quality (compression ratio) used when saving images.

Lower compression ratios result in higher quality images, but the number of images that can be saved is reduced.



Option	Description
FINE Fine	Finer image quality than Normal . Compression ratio of about 1:4
NORM Normal (default setting)	Normal image quality, suitable for most applications. Compression ratio of about 1:8
RAW RAW	Raw data from the image sensor are saved without additional processing. You can use a computer to change settings that were set during shooting such as white balance and contrast. <ul style="list-style-type: none">• File format: RAW (NRW) (Nikon's own format)
RAW-F RAW + Fine	Two images are recorded, one RAW image and one fine-quality JPEG image.
RAW-N RAW + Normal	Two images are recorded, one RAW image and one normal-quality JPEG image.

Notes About Image Quality

- **Image size** is fixed at  **4608×3456** when **Image quality** is set to **RAW**.
- RAW images cannot be captured in the following shooting modes:
 - Scene modes
 - Moon mode
 - Bird-watching mode
 - Creative modeIf you change the shooting mode to any of the above shooting modes when a RAW image quality has been selected, the image quality will change to **Fine** or **Normal**.
- This function may not be available to use in combination with other functions (75).



RAW Images of This Camera

- RAW images cannot be processed on this camera.
- NX Studio ( 109) needs to be installed on the computer to be able to view RAW images on the computer.
- RAW images cannot be edited or printed directly. You can adjust images or process RAW images if you transfer RAW images to a computer, and then use software such as NX Studio ( 109).

Saving of RAW and JPEG Images at the Same Time

- The RAW image and the JPEG image that are saved at the same time have the same file number but with their own extensions, “.NRW” and “.JPG” ( 208).
- When playing back on the camera, only the JPEG image is displayed.
- Note that when the JPEG image is deleted, the RAW image that was saved at the same time is also deleted.

Number of Images That Can Be Saved



- The approximate number of images that can be saved can be checked on the screen when shooting ( 22).
- Note that due to JPEG compression, the number of images that can be saved may vary greatly depending on the image content, even when using memory cards with the same capacity and the same image quality and image size settings. In addition, the number of images that can be saved may vary depending on the make of the memory card.
- If the number of exposures remaining is 10,000 or more, the number of exposures remaining display shows “9999.”









Image Size

Enter shooting mode* → MENU button → shooting mode menu icon → Image size →  button

* The image size can be set in any shooting mode other than Movie manual. The setting is also applied to other shooting modes (except shooting mode **U**, **Easy panorama** scene mode, and **Superlapse movie**).

Set the image size (number of pixels) used when saving JPEG images.

The larger the image size, the larger the size at which it can be printed, but the number of images that can be saved is reduced.

Option*	Aspect ratio (horizontal to vertical)
 4608×3456 (default setting)	4:3
 3264×2448	4:3
 2272×1704	4:3
 1600×1200	4:3
 4608×2592	16:9
 4608×3072	3:2
 3456×3456	1:1

* The numerical values indicate the number of pixels that are captured.
Example:  **4608×3456** = approx. 16 megapixels, 4608 × 3456 pixels

Notes About Printing Images at 1:1 Aspect Ratio

Change the printer setting to “Border” when printing images at a 1:1 aspect ratio. Some printers may not be able to print images at a 1:1 aspect ratio.

Notes About Image Size

This function may not be available to use in combination with other functions (75).





The Shooting Menu (P, S, A, or M Mode)

- See "U (User Settings) Mode" (📖52) for information about **Save user settings** and **Reset user settings**.







Picture Control (COOLPIX Picture Control)

Rotate the mode dial to **P, S, A, M**, or **U**¹ → MENU button → **P, S, A, M**, or **U** menu icon² → Picture Control →  button

¹ The setting can also be configured in  (Movie manual) mode.

² In  (Movie manual) mode, the  menu icon is displayed.

Change the settings for image recording according to the shooting conditions or your preferences. Sharpness, contrast and saturation can be adjusted in detail.

Option	Description
 SD Standard (default setting)	Standard processing for balanced results. Recommended for most situations.
 NL Neutral	Minimal processing for natural results. Select for images that will later be processed or retouched.
 VI Vivid	Images are enhanced for a vivid, photoprint effect. Select for images that emphasize primary colors, such as blue, red, and green.
 MC Monochrome	Shoots monochrome photographs such as in black-and-white or sepia.
 C-1 Custom 1 [*]	Changes to the setting of Custom 1 in COOLPIX Custom Picture Control.
 C-2 Custom 2 [*]	Changes to the setting of Custom 2 in COOLPIX Custom Picture Control.

^{*} Only displayed when the setting customized in **Custom Picture Control** (📖128) has been registered.

Notes About COOLPIX Picture Control

- The COOLPIX Picture Control function of this camera cannot be used with other makes of cameras, Picture Control function of software such as NX Studio, Picture Control Utility 2, etc.
- This function may not be available to use in combination with other functions (📖75).



Customizing Existing COOLPIX Picture Controls: Quick Adjust and Manual Adjust

COOLPIX Picture Control can be customized using “Quick adjust”, which allows for balanced adjustment of sharpness, contrast, saturation and other image editing components, or using “Manual adjust”, which allows for detailed adjustment of the components individually.

1 Use the multi selector ▲▼ to select the desired type of COOLPIX Picture Control and press the **OK** button.

- Items can also be selected by rotating the multi selector.

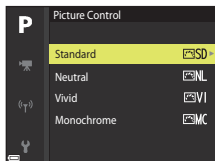

2 Use ▲▼ to highlight the desired option (📖126) and use ◀▶ to select a value.

- Press the **OK** button to set the value.
- To change the adjusted values to the default setting, select **Reset** and press the **OK** button.

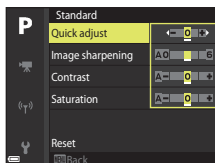

Types of Quick Adjust and Manual Adjust

Option	Description
Quick adjust ¹	Adjusts the sharpness, contrast and saturation levels automatically. Setting to the – side reduces the effect of the selected COOLPIX Picture Control, and setting to the + side emphasizes its effect. <ul style="list-style-type: none">• Default setting: 0
Image sharpening	Controls how much outlines are sharpened during shooting. The higher the number, the sharper the image, and the lower the number, the softer the image. Select A (auto) for automatic adjustment. <ul style="list-style-type: none">• Default setting: 3 for Standard or Monochrome, 2 for Neutral, and 4 for Vivid
Contrast	Controls the contrast. Setting to the – side gives the image a softer appearance, and setting to the + side gives it a harder appearance. Select lower values to prevent highlights in portrait subjects from being “washed out” in direct sunlight, higher values to preserve detail in misty landscapes and other low contrast subjects. Select A (auto) for automatic adjustment. <ul style="list-style-type: none">• Default setting: 0
Saturation ²	Controls the vividness of colors. Setting to the – side reduces the vividness, and setting to the + side increases the vividness. Select A (auto) for automatic adjustment. <ul style="list-style-type: none">• Default setting: 0
Filter effects ³	Simulates the effect of color filters on monochrome photographs. <ul style="list-style-type: none">• OFF: Filter effects are not used.• Y (yellow), O (orange), R (red): Enhance contrast. Can be used to tone down the brightness of the sky in landscape photographs. The contrast is strengthened in the order Y → O → R.• G (green): Softens skin tones and the color of features such as lips. Suitable for portraits.• Default setting: OFF



Option	Description
Toning ³	<p>Controls the tint used in monochrome photographs from B&W (black-and-white), Sepia, and Cyanotype (blue-tinted monochrome).</p> <p>Pressing the multi selector ▼ when Sepia or Cyanotype is selected enables you to select a saturation level. Press ◀▶ to adjust the saturation.</p> <ul style="list-style-type: none"> • Default setting: B&W (black-and-white)

¹ Quick adjust is not available in **Neutral**, **Monochrome**, **Custom 1**, and **Custom 2**. The values set manually are disabled if quick adjust is used after manual setting.

² Not displayed for **Monochrome**.

³ Only displayed for **Monochrome**.

Notes About Image Sharpening

The effects of **Image sharpening** cannot be previewed on the screen during shooting. Check the results in playback mode.

Notes About Contrast, Saturation, and A (Auto)



Results for contrast and saturation vary with the exposure, and the position and size of the subject in the frame.





Custom Picture Control (COOLPIX Custom Picture Control)

Rotate the mode dial to **P**, **S**, **A**, **M**, or **U**¹ → MENU button → **P**, **S**, **A**, **M**, or **U** menu icon² → Custom Picture Control →  button

¹ The setting can also be configured in  (Movie manual) mode.

² In  (Movie manual) mode, the  menu icon is displayed.

Customize the settings of COOLPIX Picture Control (125) and register them in **Custom 1** or **Custom 2** of **Picture Control**.

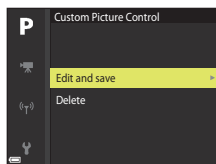

1 Use the multi selector   to select **Edit and save**, and press the  button.

- Select **Delete** to delete a registered COOLPIX Custom Picture Control.



2 Select the original COOLPIX Picture Control (124) to be edited, and press the  button.

3 Use   to highlight the desired option and use   to select a value (125).

- The options are the same as those for adjusting the COOLPIX Picture Control.
- Press the  button when you finish adjustment.
- To change the adjusted values to the default setting, select **Reset** and press the  button.

4 Select the registration destination and press the  button.

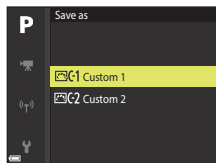

- **Custom 1** or **Custom 2** becomes selectable in **Picture Control** or **Custom Picture Control**.
- To change the adjusted values, select **Custom 1** or **Custom 2** in **Picture Control** or **Custom Picture Control**.









White Balance (Adjusting Hue)

Rotate the mode dial to **P, S, A, M,** or **U**¹ → MENU button → **P, S, A, M,** or **U** menu icon² → White balance → **OK** button

¹ The setting can also be configured in  (Movie manual) mode.

² In  (Movie manual) mode, the  menu icon is displayed.

Adjust white balance to suit the light source or weather conditions in order to make the colors in images match what you see with your eyes.

Option	Description
AUTO1 Auto (normal) (default setting)	White balance is automatically adjusted.
AUTO2 Auto (warm lighting)	When set to Auto (warm lighting) , the images are preserved with warm colors if they are shot under an incandescent light source. When using the flash, white balance is adjusted according to the flash lighting condition.
PRE Preset manual	Use when the desired result is not achieved with Auto (normal), Auto (warm lighting), Incandescent, etc. (📖131).
 Daylight*	Use under direct sunlight.
 Incandescent*	Use under incandescent lighting.
 Fluorescent	Use under most types of fluorescent lighting. Choose one of 1 (cool-white fluorescent), 2 (day white fluorescent), and 3 (daylight fluorescent).
 Cloudy*	Use under overcast skies.
 Flash*	Use with the flash.
 Choose color temp.	Use to directly specify color temperature (📖130).

* Fine adjustments in seven steps are available. Apply positive (+) to increase blue hue and negative (-) to increase red hue.

Notes About White Balance

- Lower the built-in flash when white balance is set to any setting other than **Auto (normal), Auto (warm lighting),** or **Flash** (📖25).
- This function may not be available to use in combination with other functions (📖75).



Color Temperature

Color temperature is an objective measure of colors of light sources which are expressed in the unit of absolute temperature (K: Kelvin). Light sources with lower color temperatures appear more reddish, while light sources with higher color temperatures appear more bluish.

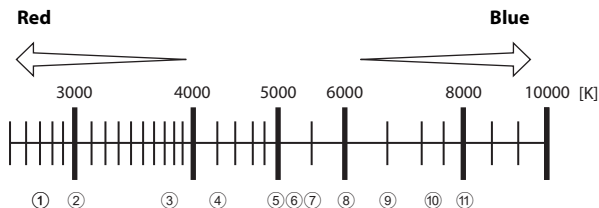

- | | |
|--|-----------------------------------|
| ① Sodium-vapor lamps: 2700K | ⑦ Flash: 5400K |
| ② Incandescent/
Warm-white fluorescent: 3000K | ⑧ Cloudy: 6000K |
| ③ White fluorescent: 3700K | ⑨ Daylight fluorescent: 6500K |
| ④ Cool-white fluorescent: 4200K | ⑩ High temp. mercury-vapor: 7200K |
| ⑤ Day white fluorescent: 5000K | ⑪ Shade: 8000K |
| ⑥ Direct sunlight: 5200K | |



Using Preset Manual

Follow the procedures described below to measure the white balance value under the lighting used during shooting.

1 Place a white or gray reference object under the lighting that will be used during shooting.

2 Use the multi selector ▲▼ to select **Preset manual**, and press the **OK** button.

- The lens extends to the zoom position for measurement.

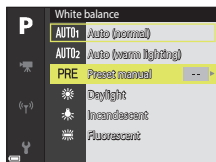

3 Select **Measure**.

- To apply the last measured value, select **Cancel**.



4 Frame the white or gray reference object in the measuring window, and press the **OK** button to measure the value.

- The shutter is released and measurement is complete (no image is saved).

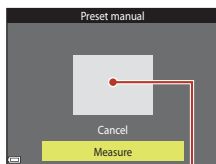

Measuring window

✓ Notes About Preset Manual

A white balance value for flash lighting cannot be measured with **Preset manual**. When shooting using the flash, set **White balance** to **Auto (normal)**, **Auto (warm lighting)**, or **Flash**.





Metering

Rotate the mode dial to **P, S, A, M,** or **U** → MENU button → **P, S, A, M,** or **U** menu icon → Metering → **OK** button

The process of measuring the brightness of the subject to determine the exposure is known as "metering."

Use this option to set the method of how the camera meters exposure.

Option	Description
 Matrix (default setting)	The camera uses a wide area of the screen for metering. Recommended for typical shooting.
 Center-weighted	The camera meters the entire frame but assigns greatest weight to the subject in the center of the frame. The classic metering for portraits; it preserves background details while letting lighting conditions in the center of the frame determine exposure.*
 Spot	The camera meters the area shown by the circle in the center of the frame. This can be used when the subject is much lighter or darker than the background. Ensure that the subject is within the area shown by the circle when shooting.*

* To set focus and exposure for off-center subjects, change **AF area mode** to manual and set the focus area to the center of the frame, and then use focus lock (📖66).

Notes About Metering

- When digital zoom is in effect, **Center-weighted** or **Spot** is selected depending on the zoom ratio.
- This function may not be available to use in combination with other functions (📖75).













Display on the Shooting Screen

When **Center-weighted** or **Spot** is selected, the metering range guide (📖11) is displayed (except when digital zoom is used).



Continuous Shooting

Rotate the mode dial to **P, S, A, M**, or **U** → MENU button → **P, S, A, M**, or **U** menu icon → Continuous →  button

Option	Description
 Single (default setting)	One image is captured each time the shutter-release button is pressed.
 Continuous H	While the shutter-release button is held all the way down, images are captured continuously. <ul style="list-style-type: none"> The camera can capture up to about 7 images continuously at a rate of about 7 fps.
 Continuous L	While the shutter-release button is held all the way down, images are captured continuously. <ul style="list-style-type: none"> The camera can capture up to about 200 images continuously at a rate of about 1 fps.
 Pre-shooting cache	Pre-shooting cache shooting begins when the shutter-release button is pressed halfway. When the shutter-release button is pressed all the way down, the camera saves the current image as well as the images captured immediately before the button is pressed ( 134). Pre-shooting cache makes it easy to capture perfect moments. <ul style="list-style-type: none"> The camera can capture up to about 20 images continuously at a rate of about 15 fps (including a maximum of 5 images captured in the pre-shooting cache). The image quality is fixed at Normal and the image size is fixed at  (1280 × 960 pixels).
 Continuous H: 120 fps	Each time the shutter-release button is pressed all the way down, images are captured continuously at a high speed rate. <ul style="list-style-type: none"> The camera can capture up to about 60 images continuously at a rate of about 120 fps. Image size is fixed at  (640 × 480 pixels).
 Continuous H: 60 fps	Each time the shutter-release button is pressed all the way down, images are captured continuously at a high speed rate. <ul style="list-style-type: none"> The camera can capture up to about 60 images continuously at a rate of about 60 fps. Image size is fixed at  (1920 × 1080 pixels).
 Intvl timer shooting	The camera automatically captures still images continuously at the specified interval ( 135).



✓ Notes About Continuous Shooting

- Focus and exposure are fixed at the values determined with the first shot in each series. White balance is also fixed at the value determined with the first shot in each series, except when using **Continuous L** or **Intvl timer shooting**.
- It may take some time to save the images after shooting.
- When ISO sensitivity increases, noise may appear in captured images.
- The frame rate may become slower depending on the image quality, image size, memory card type or shooting conditions (such as when saving RAW images).
- When using **Continuous H: 120 fps** or **Continuous H: 60 fps**, banding or variance in brightness or hue may occur in images that were captured under lighting that flashes quickly at high speeds, such as fluorescent, mercury-vapor, or sodium-vapor lighting.
- This function may not be available to use in combination with other functions (📖75).

📎 Pre-shooting Cache

When the shutter-release button is pressed halfway or all the way down, images are saved as described below.

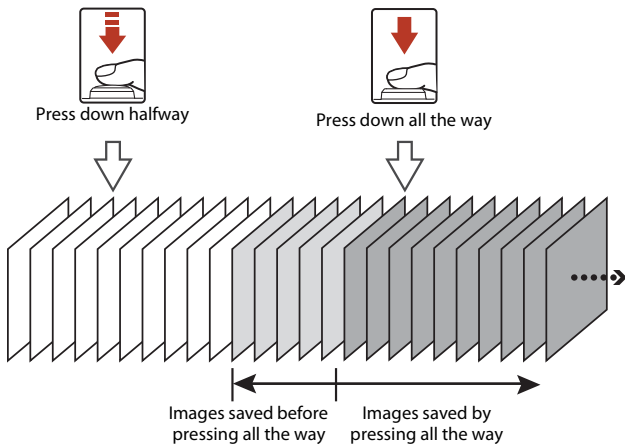

- The pre-shooting cache icon (📎) on the shooting screen changes to green while the shutter-release button is pressed halfway.



Interval Timer Shooting

Rotate the mode dial to **P, S, A, M**, or **U** → MENU button → **P, S, A, M**, or **U** menu icon → Continuous → **OK** button

- 1 Use the multi selector ▲▼ to select **Intvl timer shooting**, and then press the **OK** button.

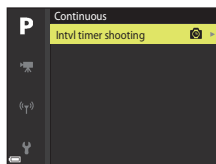

- 2 Set the desired interval between each shot.
 - Use ◀▶ to select an item, and use ▲▼ to set the time.
 - Press the **OK** button when setting is complete.

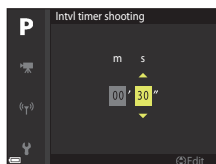

- 3 Press the **MENU** (menu) button to display the shooting screen.

- 4 Press the shutter-release button to shoot the first image.
 - The shutter is automatically released at the specified interval to shoot second and subsequent images.
 - The screen turns off and the power-on lamp flashes during the intervals between shots.

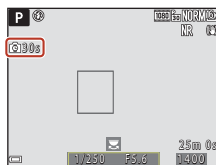

- 5 When the desired number of images have been captured, press the shutter-release button.
 - Shooting ends.
 - Shooting ends automatically in the following situations:
 - When the memory card becomes full
 - When 9999 shots are taken in sequence



Notes About Interval Timer Shooting



- To prevent the camera from turning off unexpectedly during shooting, use a sufficiently charged battery.
- If the EH-5b/EH-5c AC Adapter and the EP-5C Power Connector (both available separately) (209) are used, this camera can be powered from an electrical outlet. Do not, under any circumstances, use an AC adapter other than the EH-5b/EH-5c. Failure to observe this precaution could result in overheating or damage to the camera.
- Do not rotate the mode dial to a different setting while performing interval timer shooting. Doing so causes the camera to stop shooting.
- If the shutter speed is slow and saving an image takes time compared to the specified interval, some of the shots during Interval timer shooting may be canceled.



ISO Sensitivity





Rotate the mode dial to **P**, **S**, **A**, **M**, or **U**¹ → MENU button → **P**, **S**, **A**, **M**, or **U** menu icon² → ISO sensitivity → OK button

¹ The setting can also be configured in  (Movie manual) mode.

² In  (Movie manual) mode, the  menu icon is displayed.

A higher ISO sensitivity allows darker subjects to be captured. Additionally, even with subjects of similar brightness, pictures can be taken at faster shutter speeds, and blurring caused by camera shake and subject movement can be reduced.

- When a higher ISO sensitivity is set, images may contain noise.

Option	Description
ISO sensitivity	<ul style="list-style-type: none">• Auto (default setting): Sensitivity is automatically set within the range of ISO 100 to 1600. In Movie manual mode, it is set within the range of ISO 125 to 1600.• Fixed range auto: The range in which the camera automatically adjusts ISO sensitivity can be set to  ISO 100-400 or  ISO 100-800. In Movie manual mode, it can be set to  ISO 125-400 or  ISO 125-800.• 100 to 6400 (125 to 6400 in Movie manual mode): ISO sensitivity is fixed at the specified value.
Minimum shutter speed	<p>Set the shutter speed at which ISO sensitivity starts to be automatically adjusted when the shooting mode is P or A. If the exposure is insufficient with the shutter speed that is set here, the ISO sensitivity is increased automatically to obtain the optimal exposure.</p> <ul style="list-style-type: none">• The setting is enabled when ISO sensitivity is set to Auto or Fixed range auto.• If the exposure is still insufficient even after ISO sensitivity is increased, the shutter speed slows down.• Default setting: None

Notes About ISO Sensitivity

- When **ISO sensitivity** is set to **Auto** or **Fixed range auto** in **M** (manual) mode, the ISO sensitivity is fixed at ISO 100.
- When **Manual** is selected for **Exposure mode** in Movie manual mode and **ISO sensitivity** is set to **Auto** or **Fixed range auto**, the ISO sensitivity is fixed at ISO 125.
- This function may not be available to use in combination with other functions (75).



ISO Sensitivity Display on the Shooting Screen

- When **Auto** is selected, **ISO** is displayed when the ISO sensitivity increases.
- When **Fixed range auto** is selected, the maximum value for ISO sensitivity is displayed.





Exposure Bracketing

Rotate the mode dial to **P**, **S**, or **A** → MENU button → **P**, **S**, or **A** menu icon → Exposure bracketing →  button

The exposure (brightness) can be changed automatically during continuous shooting. This is effective for shooting when it is difficult to adjust the picture brightness.

Option	Description
Off (default setting)	Exposure bracketing is not performed.
± 0.3	When the shutter-release button is pressed all the way, 3 shots are taken in sequence and the camera varies exposure by 0, -0.3 , and $+0.3$ over the shots.
± 0.7	When the shutter-release button is pressed all the way, 3 shots are taken in sequence and the camera varies exposure by 0, -0.7 , and $+0.7$ over the shots.
± 1.0	When the shutter-release button is pressed all the way, 3 shots are taken in sequence and the camera varies exposure by 0, -1.0 , and $+1.0$ over the shots.

Notes About Exposure Bracketing





- **Exposure bracketing** is not available in **M** (manual) mode.
- When exposure compensation (69) and ± 0.3 , ± 0.7 , or ± 1.0 in **Exposure bracketing** are set simultaneously, the combined exposure compensation values are applied.
- This function may not be available to use in combination with other functions (75).



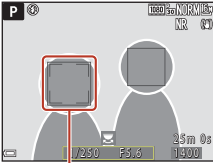

AF Area Mode

Rotate the mode dial to **P**, **S**, **A**, **M**, or **U** → MENU button → **P**, **S**, **A**, **M**, or **U** menu icon → AF area mode → **OK** button

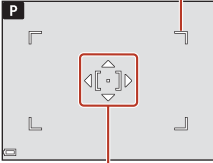
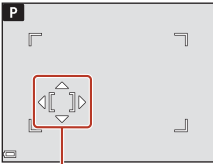
Set how the camera selects the focus area for autofocus.

Option	Description
<p> Face priority</p>	<p>When the camera detects a human face, it focuses on that face. See “Using Face Detection” (164) for more information.</p> <p>When framing a composition with no human subjects or detected faces, the camera automatically selects one or more of the nine focus areas containing the subject closest to the camera.</p>  <p style="text-align: center;">Focus area</p>
<p> Manual (spot)</p> <p> Manual (normal)</p> <p> Manual (wide)</p>	<p>Use the multi selector  or rotate it to move the focus area to where you want to focus. To use the multi selector to configure the flash mode or other settings, press the OK button. To return to moving the focus area, press the OK button again.</p> <p>Scope of movable focus area</p>  <p style="text-align: center;">Focus area (center)</p>  <p style="text-align: center;">Focus area (moved)</p>

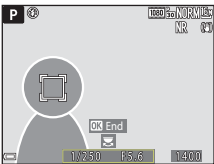

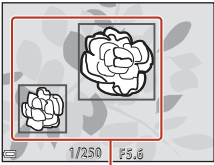
Option	Description
 Subject tracking	<p>Use this function to take pictures of moving subjects. Register the subject on which the camera focuses. The focus area automatically moves to track the subject. See "Using Subject Tracking" (📖142) for more information.</p> 
 Target finding AF (default setting)	<p>When the camera detects the main subject, it focuses on that subject. See "Using Target Finding AF" (📖63).</p>  <p style="text-align: center;">Focus areas</p>

Notes About AF Area Mode

- When digital zoom is in effect, the camera focuses on the area in the center of the frame regardless of the **AF area mode** setting.
- When the focus-mode selector is set to **MF** (manual focus), **AF area mode** cannot be set.
- This function may not be available to use in combination with other functions (📖75).



Using Subject Tracking

Rotate the mode dial to **P**, **S**, **A**, **M**, or **U** → MENU button → **P**, **S**, **A**, **M**, or **U** menu icon → AF area mode → **OK** button →  Subject tracking → **OK** button → MENU button

1 Register a subject.

- Align the subject that you want to track with the border in the center of the frame and press the **OK** button.
- When the subject is registered, a yellow border (focus area) is displayed around it and the camera begins tracking the subject.
- If the subject cannot be registered, the border is displayed in red. Change the composition and try registering the subject again.
- To cancel subject registration, press the **OK** button.
- If the camera can no longer track the registered subject, the focus area disappears. Register the subject again.

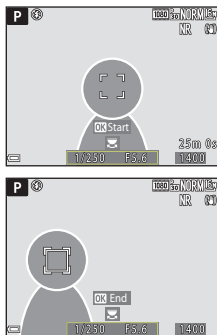

2 Press the shutter-release button all the way to take the picture.

- If the shutter-release button is pressed while the focus area is not displayed, the camera focuses on the subject in the center of the frame.

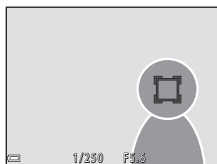

✓ Notes About Subject Tracking

- If you perform operations such as zooming while the camera is tracking the subject, the registration is canceled.
- Subject tracking may not be possible in certain shooting conditions.



Autofocus Mode

Rotate the mode dial to **P, S, A, M,** or **U** → MENU button → **P, S, A, M,** or **U** menu icon → Autofocus mode →  button

Set how the camera focuses when shooting still images.

Option	Description
AF-S Single AF	The camera focuses only when the shutter-release button is pressed halfway.
AF-F Full-time AF (default setting)	The camera always focuses even if the shutter-release button is not pressed halfway. The sound of lens drive movement is heard while the camera focuses.

Notes About Autofocus Mode

- When the focus-mode selector is set to **MF** (manual focus), **Autofocus mode** cannot be set.
- This function may not be available to use in combination with other functions (75).



Autofocus Mode for Movie Recording

Autofocus mode for movie recording can be set with **Autofocus mode** (153) in the movie menu.

Flash Exp. Comp.

Rotate the mode dial to **P, S, A, M,** or **U** → MENU button → **P, S, A, M,** or **U** menu icon → Flash exp. comp. →  button

Adjust the flash output. Use this option when the flash is too bright or too dark.

- If the compensation value you want to set is not displayed on the setting screen, press the multi selector   until it is displayed.

Option	Description
+0.3 to +2.0	The flash output is increased from +0.3 to +2.0 EV, in increments of 1/3 EV, to make the main subject of the frame appear brighter.
0.0 (default setting)	The flash output is not adjusted.
-0.3 to -2.0	The flash output is reduced from -0.3 to -2.0 EV, in increments of 1/3 EV, to prevent unwanted highlights or reflections.



Noise Reduction Filter

Rotate the mode dial to **P, S, A, M,** or **U** → MENU button → **P, S, A, M,** or **U** menu icon → Noise reduction filter → **OK** button

Set the strength of the noise reduction function that is normally performed when saving images.

Option	Description
NR⁺ High	Performs noise reduction at a level higher than the standard strength.
NR Normal (default setting)	Performs noise reduction at the standard strength.
NR⁻ Low	Performs noise reduction at a level lower than the standard strength.

Active D-Lighting

Rotate the mode dial to **P, S, A, M,** or **U** → MENU button → **P, S, A, M,** or **U** menu icon → Active D-Lighting → **OK** button

Details in highlights and shadows are preserved, and the natural contrast that is seen with the naked eye is well reproduced in the image captured. This is particularly effective for shooting conditions with high contrast, such as brightly lit outdoor scenery from a dark room or shaded subjects at a sunny seaside.

Option	Description
暗H High 暗N Normal 暗L Low	Set the effect level.
OFF Off (default setting)	Active D-Lighting is not applied.

✓ Notes About Active D-Lighting

- Additional time is required to save images after shooting.
- This function may not be available to use in combination with other functions (📖75).

📎 Active D-Lighting Versus D-Lighting

- The **Active D-Lighting** captures images while reducing loss of details in highlights, and adjusts the tone when saving images.
- The **D-Lighting** (📖84) option in the playback menu adjusts the tone of saved images.



Multiple Exposure

Rotate the mode dial to **P, S, A, M,** or **U** → MENU button → **P, S, A, M,** or **U** menu icon → Multiple exposure → **OK** button

The camera combines two to three images and saves them as a single image.

Option	Description
Multiple exposure mode	Shoots images in multiple exposure mode when set to On . <ul style="list-style-type: none">• Individual images are also saved.• Default setting: Off
Auto gain	Set whether or not to automatically adjust the brightness of the image when combining images. <ul style="list-style-type: none">• Default setting: On

✓ Notes About Multiple Exposure

- It may take some time to combine images.
- Multiple exposure is terminated if the auto off function (📖176) triggers the standby mode during shooting. When shooting with a long interval between shots, setting a longer time for the auto off function is recommended.
- This function may not be available to use in combination with other functions (📖75).
- When shooting at a slow shutter speed in multiple exposure mode, noise (bright spots) may appear in saved images.

Multiple Exposure Shooting

Rotate the mode dial to **P, S, A, M,** or **U** → MENU button → **P, S, A, M,** or **U** menu icon → Multiple exposure → **OK** button

- 1 Use the multi selector ▲▼ to select **Multiple exposure mode**, and then press the **OK** button.

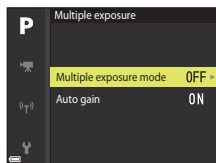

- 2 Select **On**, and then press the **OK** button.

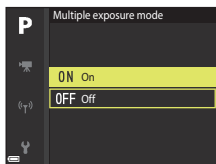

- 3 Press the **MENU** (menu) button to display the shooting screen.

- 4 Press the shutter-release button to shoot the first image.



- 5 Press the shutter-release button to shoot the second image.

- Frame the picture while looking at the first image displayed translucently.
- When shooting the second image, the combined image of the first and second images is saved, and displayed translucently.
- To end multiple exposure at the second image, set **Multiple exposure mode** to **Off** or change the mode dial to any mode other than **P**, **S**, **A**, **M**, or **U**.



- 6 Press the shutter-release button to shoot the third image.

- The combined image of the first to third images is saved and multiple exposure ends.
- It may take some time until the third image is shot.



Zoom Memory

Rotate the mode dial to **P, S, A, M,** or **U** → MENU button → **P, S, A, M,** or **U** menu icon → Zoom memory → **OK** button

Option	Description
On	<p>When the zoom control is moved, the zoom position (equivalent to focal length/angle of view in 35mm [135] format) is switched to the positions that have been selected by setting the check box to on in this menu option.</p> <ul style="list-style-type: none">Choose the focal length with the multi selector ▲▼, and then press the OK button to set the check box to on [✓] or off. The following settings are available: 24 mm, 28 mm, 35 mm, 50 mm, 70 mm, 85 mm, 105 mm, 135 mm, 200 mm, 300 mm, 400 mm, 500 mm, 600 mm, 800 mm, 1000 mm, 1200 mm, 1400 mm, 1600 mm, 1800 mm, 2000 mm, 2200 mm, 2400 mm, 2600 mm, 2800 mm, and 3000 mm.Default setting: On [✓] for all the check boxesTo finish setting, press the multi selector ►.The zoom position set in the Startup zoom position is automatically set to on [✓].The zoom memory function cannot be used with the side zoom control.
Off (default setting)	<p>The zoom position can be moved to any position, including the positions that can be set with On.</p>

Notes About Zoom Operation

- When more than one focal length has been set, move the zoom control to switch to the focal length closest to that before the operation. To switch to a different focal length, release the zoom control and then move it again.
- Set **Zoom memory** to **Off** when using the digital zoom.



Startup Zoom Position

Rotate the mode dial to **P, S, A, M,** or **U** → MENU button → **P, S, A, M,** or **U** menu icon → Startup zoom position →  button

Set the zoom position (equivalent to focal length/angle of view in 35mm [135] format) for when the camera is turned on.

The following settings are available: **24 mm** (default setting), **28 mm, 35 mm, 50 mm, 70 mm, 85 mm, 105 mm,** and **135 mm.**

M Exposure Preview

Rotate the mode dial to **P, S, A, M,** or **U** → MENU button → **P, S, A, M,** or **U** menu icon → M exposure preview →  button

Set whether or not to reflect the brightness to the shooting screen when the exposure is changed in **M** (manual) mode.

Option	Description
On	Reflects the brightness to the shooting screen.
Off (default setting)	Does not reflect the brightness to the shooting screen.



The Movie Manual Mode Menu



See the menu options listed below.



- **Exposure mode** (📖94)
- **Picture Control** (📖124)
- **Custom Picture Control** (📖128)
- **White balance** (📖129)
- **ISO sensitivity** (📖137)



The Movie Menu











Movie Options

Enter shooting mode → MENU button →  menu icon → Movie options →  button

Select the desired movie option to record. Select normal speed movie options to record at normal speed, or HS movie options (151) to record in slow or fast motion. The movie options that can be selected vary depending on the **Frame rate** setting (155).

- Memory cards with an SD Speed Class rating of 6 or faster are recommended for recording movies (223).

Normal Speed Movie Options

Option (Image size/ Frame rate, File format)	Image size	Aspect ratio (horizontal to vertical)
 2160/30p (4K UHD)  2160/25p (4K UHD)	3840 × 2160	16:9
 1080/30p  1080/25p (default setting)	1920 × 1080	16:9
 1080/60p  1080/50p	1920 × 1080	16:9
 720/30p  720/25p	1280 × 720	16:9
 720/60p  720/50p	1280 × 720	16:9

- The maximum file size for individual movie files is 4 GB. When recording a movie longer than approximately six minutes at an image size/frame rate of **2160/30p** (4K UHD) or longer than approximately seven minutes at an image size/frame rate of **2160/25p** (4K UHD), multiple files are created when the file size of the recorded movie exceeds 4 GB, and the files cannot be played back continuously. The actual remaining recording time may vary depending on the movie content, subject movement, or type of memory card.



HS Movie Options

Recorded movies are played back in fast or slow motion.

See "Playing Back in Slow Motion and Fast Motion" (📖152).

Option	Image size Aspect ratio (horizontal to vertical)	Description
120fps 100fps HS 480/4×	640 × 480 4:3	1/4-speed slow motion movies • Max. recording time: 7 minutes 15 seconds (playback time: 29 minutes)
60fps 50fps HS 720/2×	1280 × 720 16:9	1/2-speed slow motion movies • Max. recording time: 14 minutes 30 seconds (playback time: 29 minutes)
15fps 12.5fps HS 1080/ 0.5×	1920 × 1080 16:9	2× speed fast motion movies • Max. recording time: 29 minutes (playback time: 14 minutes 30 seconds)

✔ Notes About HS Movie

- Sound is not recorded.
- Still images cannot be saved during movie recording.
- Movie recording cannot be paused.
- Zoom position, focus, exposure, and white balance are locked when movie recording starts.



Playing Back in Slow Motion and Fast Motion

When recording at normal speed:

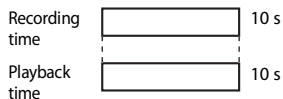

When recording at 120fps HS 480/4x, or 100fps HS 480/4x:

Movies are recorded at 4x normal speed.

They are played back in slow motion at 4x slower speed.

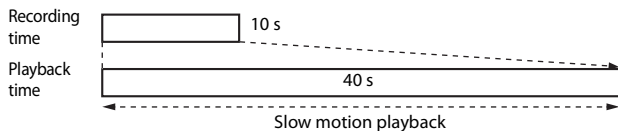



When recording at 15fps HS 1080/0.5x, or 12.5fps HS 1080/0.5x:

Movies are recorded at 1/2 normal speed.

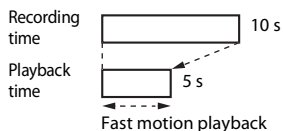
They are played back in fast motion at 2x faster speed.



Autofocus Mode

Enter shooting mode → MENU button →  menu icon → Autofocus mode →  button

Set how the camera focuses when recording movies.



Option	Description
AF-S Single AF (default setting)	Focus is locked when movie recording starts. Select this option when the distance between the camera and the subject will remain fairly consistent.
AF-F Full-time AF	The camera focuses continuously. Select this option when the distance between the camera and subject will change significantly during recording. The sound of the camera focusing may be heard in the recorded movie. Use of Single AF is recommended to prevent the sound of the camera focusing from interfering with recording.

Notes About Autofocus Mode

- In superlapse movie mode, the setting is fixed at **Single AF**.
- When an HS movie option is selected in **Movie options**, the setting is fixed at **Single AF**.
- When the focus-mode selector is set to **MF** (manual focus), **Autofocus mode** cannot be set.
- This function may not be available to use in combination with other functions (75).



Electronic VR

Enter shooting mode → MENU button →  menu icon → Electronic VR →  button



Set whether or not to perform electronic VR when recording movies.

Option	Description
On (default setting)	Performs electronic VR. <ul style="list-style-type: none">• The angle of view (i.e., the area seen in the frame) becomes narrower.• When Vibration reduction ( 171) is set to Normal, Active, Normal (framing first), or Active (framing first) in the setup menu, optical vibration reduction is performed simultaneously.
Off	Does not perform electronic VR.

Notes About Electronic VR

- In superlapse movie mode, the setting is fixed at **On**.
- When **2160/30p, 2160/25p**, or an HS movie option is selected in **Movie options**, the setting is fixed at **Off**.

Wind Noise Reduction

Enter shooting mode → MENU button →  menu icon → Wind noise reduction →  button



Option	Description
On	Reduces the sound that is produced when wind passes over the microphone during movie recording. Other sounds may become difficult to hear during playback.
Off (default setting)	Wind noise reduction is disabled.

Notes About Wind Noise Reduction

In superlapse movie mode or when an HS movie option is selected in **Movie options**, the setting is fixed at **Off**.



Zoom Microphone

Enter shooting mode → MENU button →  menu icon → Zoom microphone →  button

Option	Description
On (default setting)	In accordance with the angle of view, the camera records sounds over a wide area at the wide-angle zoom position, and records sounds in the limited area at the telephoto zoom position.
Off	Zoom microphone is disabled.

Notes About Zoom Microphone

The setting is fixed at **Off** in the following situations:

- In superlapse movie mode
- When an HS movie option is selected in **Movie options**
- When an external microphone is connected

Frame Rate

Enter shooting mode → MENU button →  menu icon → Frame rate →  button

Select the frame rate used when recording movies. When the frame rate setting is switched, options that can be set in **Movie options** (📖150) change.



Option	Description
30 fps (30p/60p)	Suited for playback on a TV using the NTSC standard.
25 fps (25p/50p)	Suited for playback on a TV using the PAL standard.



External Mic Sensitivity

Enter shooting mode → MENU button →  menu icon → External mic sensitivity →  button

Set the sensitivity of the microphone that is connected to the camera's external microphone connector. This option can be set only when an external microphone is connected.

Option	Description
 A Auto sensitivity (default setting)	The sensitivity of the external microphone is set automatically.
 M Manual sensitivity	The sensitivity of the external microphone is set manually.

Using the Manual Sensitivity Screen

- The input level from the external microphone is displayed in the indicator.
- Use the multi selector to adjust the value and press the  button to apply the setting.

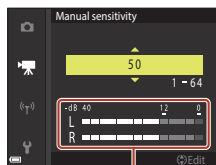



Indicator



The Playback Menu

See “Editing Images (Still Images)” (📖83) for information about image editing functions.

Mark for Upload

Press the  button (playback mode) → MENU button → Mark for upload →  button



Select still images in the camera and upload them to a smart device that has a wireless connection established with the SnapBridge app.

On the image selection screen (📖115), select or deselect images for the Mark for upload function.

- The size of images that are uploaded is restricted to 2 megapixels. To upload still images at their original size, use **Download pictures** in the SnapBridge app.
- RAW images and movies cannot be selected. To upload movies to a smart device, use **Download pictures** in the SnapBridge app.
- Note that when you select **Reset all** (📖184) in the setup menu or **Restore default settings** (📖162) in the network menu, the Mark for upload settings that you made are canceled.





Slide Show

Press the  button (playback mode) → MENU button → Slide show →  button



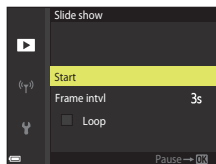

Play back images one by one in an automated “slide show.” When movie files are played back in the slide show, only the first frame of each movie is displayed.

1 Use the multi selector to select **Start** and press the button.

- The slide show begins.
- To change the interval between images, select **Frame intvl**, press the  button, and specify the desired interval time before selecting **Start**.
- To repeat the slide show automatically, select **Loop** and press the  button before selecting **Start**.
- The maximum playback time is up to about 30 minutes even if **Loop** is enabled.







2 End or restart the slide show.

- The screen shown on the right is displayed after the slide show ends or is paused. To exit the show, select  and then press the  button. To resume the slide show, select  and then press the  button.





Operations During Playback

- Use the multi selector     to display the previous/next image. Press and hold down to rewind/fast-forward images.
- Press the  button to pause or end the slide show.



Protect



Press the  button (playback mode) → MENU button → Protect →  button

The camera protects selected images from accidental deletion.

Select images to protect or cancel protection from the image selection screen (115).

Note that formatting the memory card permanently deletes all data including protected files (176).

Rotate Image

Press the  button (playback mode) → MENU button → Rotate image →  button

Specify the orientation in which saved images are displayed during playback. Still images can be rotated 90 degrees clockwise or 90 degrees counterclockwise. Images that were saved in the “tall” orientation can be rotated up to 180 degrees in either direction.

Select an image from the image selection screen (115). When the Rotate image screen is displayed, use the multi selector  or rotate it to rotate the image 90 degrees.

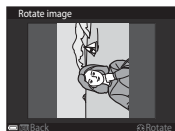

Rotate 90 degrees
counterclockwise

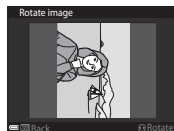



Rotate 90 degrees
clockwise

Press the  button to finalize display orientation, and save orientation information with the image.



Sequence Display Options



Press the  button (playback mode) → MENU button → Sequence display options →  button

Select the method used to display images in the sequence (82).

Option	Description
Individual pictures	Displays each image in a sequence individually.  is displayed on the playback screen.
Key picture only (default setting)	Displays only the key picture for images in a sequence.

Settings are applied to all sequences, and the setting is saved in the camera's memory even after the camera is turned off.

Choose Key Picture

Press the  button (playback mode) → display a sequence for which you want to change the key picture → MENU button → Choose key picture →  button

Specify a different image in the sequence as the key picture.

- When the key picture selection screen is displayed, select an image (115).



The Network Menu

Press the **MENU** button →  menu icon →  button

Configure the wireless network settings to connect the camera to a smart device or the ML-L7 Remote Control (available separately).

- When you establish a wireless connection between the camera and a smart device using the SnapBridge app, you can upload images captured with the camera to the smart device or perform remote photography. See the included “SnapBridge Connection Guide” for the connection procedure.
- Some settings cannot be changed while a wireless connection is established. To change them, disconnect the wireless connection.

Option	Description
Airplane mode	Select On to turn off all wireless connections.
Choose connection	Select whether to connect the camera to a smart device or the ML-L7 Remote Control (available separately).
Connect to smart device	Select when using the SnapBridge app to connect a smart device with the camera. See the included “SnapBridge Connection Guide” for more information. <ul style="list-style-type: none">• Select Smart device in Choose connection before selecting this option.
Connection to remote	Select when connecting the ML-L7 Remote Control (available separately) with the camera. The camera waits for the connection to be established ( 216). <ul style="list-style-type: none">• Select Remote control in Choose connection before selecting this option.
Send while shooting	Set the conditions for automatically sending images to a smart device. <ul style="list-style-type: none">• The size of images that are uploaded is restricted to 2 megapixels. To upload still images at their original size, use Download pictures in the SnapBridge app.



Option	Description
Wi-Fi	SSID* : Change the SSID. Set a 1- to 32-character alphanumeric SSID.
	Auth./encryp. : Select whether or not to encrypt the communications between the camera and the connected smart device. Communications are not encrypted when Open is selected.
	Password* : Set the password. Set an 8- to 36-character alphanumeric password.
	Channel : Select the channel used for the Wi-Fi connection. If the communication quality is poor or the image upload speed is extremely slow when using a Wi-Fi connection, try changing the channel.
	Subnet mask : Use the default setting (255.255.255.0) under normal conditions.
	DHCP server IP address : Use the default setting (192.168.0.10) under normal conditions.
Current settings	Display the current settings.
Bluetooth	Connection : Select Disable to turn off Bluetooth communication.
	Paired devices : Change the smart device to connect with, or delete the connected smart device. Up to five smart devices can be registered in the camera, but the camera can connect to only one device at a time.
	Send while off : Set whether or not to allow the camera to communicate with the smart device when the camera is off or in standby mode (📖24).
Restore default settings	Restore all network menu settings to their default values.

* See “Operating the Text Input Keyboard” (📖163) for information on how to enter alphanumeric characters.

Bluetooth Communication Indicator on the Shooting Screen

- Lights up while the camera is connected to a smart device via Bluetooth.
- Flashes when the camera is waiting for the connection to a smart device to be re-established. Also flashes when the Bluetooth connection is cut off while uploading images (📖206).



Operating the Text Input Keyboard

- Use the multi selector ▲▼◀▶ to select alphanumeric characters. Press the **OK** button to enter the selected character in the text field and move the cursor to the next space.
- To move the cursor in the text field, select ← or → on the keyboard, and press the **OK** button.
- To delete one character, press the **🗑** button.
- To apply the setting, select ↩ on the keyboard and press the **OK** button.



The Setup Menu

Time Zone and Date

Press the **MENU** button → **Y** menu icon → Time zone and date → **OK** button

Set the camera clock.

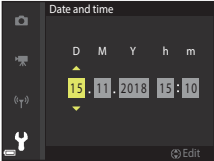
Option	Description
Sync with smart device	Select On to synchronize the date and time setting with a smart device. Enable the clock synchronization function of the SnapBridge app.
Date and time	Set the date and time if Sync with smart device is set to Off . <ul style="list-style-type: none">• Select a field: Press the multi selector ◀▶.• Edit the date and time: Press ▲▼. Date and time can also be changed by rotating the multi selector or command dial.• Apply the setting: Select the minute field setting and press the OK button or ▶. 
Date format	Select Year/Month/Day , Month/Day/Year , or Day/Month/Year .
Time zone	Set time zone and daylight saving time. <ul style="list-style-type: none">• When Travel destination (👤) is set after having set the home time zone (🏠), the time difference between the travel destination and the home time zone is automatically calculated, and the date and time are saved for the selected region.



Setting the Time Zone

- 1 Use the multi selector ▲▼ to select **Time zone** and press the OK button.

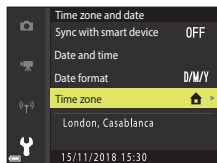

- 2 Select **Home time zone** or **Travel destination** and press the OK button.

- The date and time displayed on the screen changes depending on whether the home time zone or travel destination is selected.

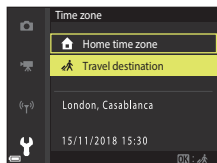

- 3 Press ►.

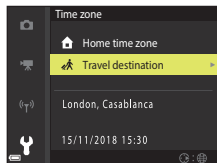

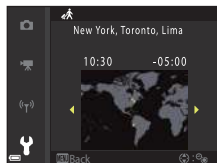

- 4 Use ◀▶ to select the time zone.

- Press ▲ to enable daylight saving time function, and ☀ is displayed. Press ▼ to disable the daylight saving time function.
- Press the OK button to apply the time zone.
- If the correct time is not displayed for the home or travel destination time zone setting, set the appropriate time in **Date and time**.



Slot Empty Release Lock

Press the MENU button →  menu icon → Slot empty release lock →  button





Set whether or not the shutter can be released when no memory card is inserted in the camera.

Option	Description
Release locked (default setting)	Unless a memory card is inserted in the camera, the shutter cannot be released.
Enable release	Even when no memory card is inserted in the camera, the shutter can be released. However, Demo mode is displayed on the image captured when no memory card is inserted and the image cannot be printed or saved on a memory card, although the image is displayed on the screen. Also, the image cannot be transferred to a smart device.



Monitor Settings

Press the MENU button →  menu icon → Monitor settings →  button

Option	Description
Image review	Set whether or not to display the captured image immediately after shooting. <ul style="list-style-type: none"> Default setting: On
Monitor options	Adjust the monitor brightness and hue. <ul style="list-style-type: none"> Use the multi selector ▲▼ to adjust brightness, ◀▶ to adjust hue and then press the  button. Default setting: Brightness 3, Hue 0 Cannot be set when the viewfinder is used.
EVF options	Adjust the viewfinder brightness and hue. <ul style="list-style-type: none"> Use the multi selector ▲▼ to adjust brightness, ◀▶ to adjust hue and then press the  button. Default setting: Brightness 3, Hue 0 Cannot be set when the monitor is used.
View/hide framing grid*	Set whether or not to display a boxed guide for framing on the shooting screen. <ul style="list-style-type: none"> Default setting: Off The framing grid is not displayed when the enlarged center of the image is displayed on the screen while using manual focus.
View/hide histograms*	Set whether or not to display a graph that shows the brightness distribution in the image ( 11, 69) on the shooting screen. <ul style="list-style-type: none"> Default setting: Off Can be displayed only in the following shooting modes: <ul style="list-style-type: none"> When in P, S, A, or M mode (if Face priority, Manual (spot), Manual (normal), or Manual (wide) is selected in AF area mode) When in scene modes (except Easy panorama) The histogram is not displayed on the screen during movie recording or while using manual focus.
Virtual horizon*	Set whether or not to display a virtual horizon on the shooting screen ( 168). <ul style="list-style-type: none"> Default setting: Off

* To display or hide these indicators, press the DISP (display) button when **On** is selected (.



Virtual Horizon

You can check the degree of camera tilt in two directions.



Rolling direction

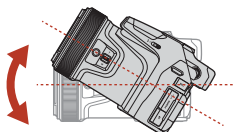

Pitching direction



When the reference line is displayed in yellow, the camera is tilted in the left or right direction. The reference line changes to green when the camera is level. Each scale mark represents 5 degrees.



When the ● in the center is displayed in yellow, the camera is tilted in the forward or backward direction. The ● changes to green when the camera is level. Each scale mark represents 10 degrees.

Precision of the Virtual Horizon

Note that an error becomes large if the camera is tilted forward or backward greatly. If the camera is tilted to the unmeasurable extent, the graduations of the virtual horizon turns off.





EVF Auto Toggle (Automatically Switching the Display to the Viewfinder)

Press the MENU button →  menu icon → EVF auto toggle →  button



Option	Description
On (default setting)	When you bring your face close to the viewfinder, the eye sensor responds to it and the display is automatically switched from the monitor to viewfinder.
Off	Even when you bring your face close to the viewfinder, the display is not switched to the viewfinder.

Date Stamp

Press the MENU button →  menu icon → Date stamp →  button

The shooting date and time can be stamped on images when shooting.



Option	Description
 Date	Date is stamped on images.
 Date and time	Date and time are stamped on images.
Off (default setting)	Date and time are not stamped on images.



✓ Notes About Date Stamp

- Stamped date and time form a permanent part of image data and cannot be deleted. The date and time cannot be stamped on images after they have been captured.
- The date and time cannot be stamped in the following situations:
 - When the scene mode is set to **Sports, Night portrait** (when set to **Hand-held**), **Night landscape** (when set to **Hand-held**), **Backlighting** (when **HDR** is set to **On**), **Easy panorama**, **Pet portrait** (when set to **Continuous**), **Multiple exp. Lighten**, **Time-lapse movie**, or **Superlapse movie**
 - When in **Bird-watching** mode (when set to **Continuous**)
 - When **Image quality** (📖121) is set to **RAW, RAW + Fine**, or **RAW + Normal**
 - When **Pre-shooting cache**, **Continuous H: 120 fps**, or **Continuous H: 60 fps** is selected for **Continuous** (📖133)
 - When recording movies
 - When saving still images during movie recording
 - When extracting still images from a movie during movie playback
- The stamped date and time may be difficult to read when using a small image size.

Self-timer: After Release



Press the **MENU** button → **Y** menu icon → Self-timer: after release → **OK** button

Select whether or not to cancel the self-timer setting after shooting with self-timer (📖58).

Option	Description
Exit self-timer mode (default setting)	The self-timer setting is canceled after shooting. <ul style="list-style-type: none">• After shooting with self-timer in Moon mode (📖40), the self-timer setting is 3s (3 seconds).• The pet portrait auto release (📖38) setting is not canceled.• The smile timer (📖60) setting is not canceled.
Stay in self-timer mode	Shooting continues without canceling the self-timer setting. <ul style="list-style-type: none">• The self-timer setting is canceled when the camera is turned off.







Vibration Reduction

Press the **MENU** button →  menu icon → **Vibration reduction** →  button

Select the vibration reduction setting used when shooting.

Select **Off** when using a tripod to stabilize the camera during shooting.

Option	Description
 Normal (default setting)	Suited to capturing images of subjects that are not moving.
 Active	Suited to capturing images if a relatively large camera shake is likely to occur, such as when shooting from a car or under poor foothold conditions.
 Normal (framing first)	Compared to the Normal setting, you can reduce the amount of difference between your intended composition and the captured image.
 Active (framing first)	Compared to the Active setting, you can reduce the amount of difference between your intended composition and the captured image.
Off	Compensation is not performed.

Notes About Vibration Reduction

- After turning on the camera or after switching from playback mode to shooting mode, wait until the shooting screen is ready before taking pictures.
- **Normal** or **Active** is recommended if you are not concerned about the slight variations in image composition that may occur. The amount of camera shake compensation is higher than that of **Normal (framing first)** or **Active (framing first)**.
- **Normal (framing first)** is recommended when you intend to significantly change the direction of the camera while shooting, such as when panning. The camera automatically detects the panning direction and only compensates for vibration caused by camera shake.
- Images on the screen may be displayed blurry immediately after shooting.
- Vibration reduction may be unable to completely eliminate the effects of camera shake in some situations.



AF Assist

Press the MENU button → Y menu icon → AF assist → OK button

Option	Description
Auto (default setting)	The AF-assist illuminator automatically lights up when you press the shutter-release button under dim lighting. The illuminator has a range of about 5.0 m (16 ft) at the maximum wide-angle position and about 7.0 m (22 ft) at the maximum telephoto position. <ul style="list-style-type: none">Note that for some scene modes or focus areas, the AF-assist illuminator may not light.
Off	The AF-assist illuminator does not light.

Digital Zoom

Press the MENU button → Y menu icon → Digital zoom → OK button

Option	Description
On (default setting)	Digital zoom is enabled.
Off	Digital zoom is disabled.

Notes About Digital Zoom

- Digital zoom cannot be used in the following scene modes.
 - Scene auto selector, Portrait, Night portrait, Backlighting** (when set to HDR), **Easy panorama, Pet portrait, Time-lapse movie, Superlapse movie**
- Digital zoom cannot be used in other shooting modes when using certain settings (📖78).



Assign Side Zoom Control

Press the **MENU** button → **Y** menu icon → Assign side zoom control → **OK** button

Choose the function to be performed during shooting when the side zoom control is moved.

Option	Description
Zoom (default setting)	When shooting, use the side zoom control (📖23) to adjust the zoom.
Manual focus	When the focus-mode selector is set to MF (manual focus), use the side zoom control to focus. <ul style="list-style-type: none">• Move the side zoom control toward T to focus on distant subjects.• Move the side zoom control toward W to focus on near subjects.• When the focus-mode selector is set to AF (autofocus), the side zoom control operation is disabled.

Snap-back Zoom

Press the **MENU** button → **Y** menu icon → Snap-back zoom → **OK** button

Select the size of the area that is temporarily visible when the  (snap-back zoom) button (📖72) is pressed (default setting is **Snap back: long**).



Control Ring Options

Press the **MENU** button → **Y** menu icon → Control ring options → **OK** button

Select the option for the control ring when the focus-mode selector is set to **AF** (autofocus).

Option	Description
Exposure compensation (default setting)	Exposure compensation (📖69) can be set with the control ring.
ISO sensitivity	ISO sensitivity (📖137) can be set with the control ring when the shooting mode is P , S , A , M , or Movie manual (except when an HS movie option is selected in Movie options). <ul style="list-style-type: none">• Rotate the multi selector or the control ring to select a setting, and press the OK button or ▶ to apply it.
White balance	White balance (📖129) can be set with the control ring when the shooting mode is P , S , A , M , or Movie manual. <ul style="list-style-type: none">• Rotate the multi selector or the control ring to select a setting, and press the OK button or ▶ to apply it.
None	The control ring operation is disabled when the focus-mode selector is set to AF (autofocus).



AE/AF Lock Button

Press the MENU button → Y menu icon → AE/AF lock button → OK button

Set the function to be performed when the AE-L/AF-L (AE-L/AF-L) button is pressed while shooting.

Option	Description
AE/AF lock (default setting)	Locks both the focus and exposure while the AE-L/AF-L button is pressed.
AE lock only	Locks only the exposure while the AE-L/AF-L button is pressed. ¹
AE lock (Hold)	Locks the exposure when the AE-L/AF-L button is pressed. To unlock, press the button again.
AF lock only	Locks only the focus while the AE-L/AF-L button is pressed. ²

¹ When recording movies, the exposure remains locked after you press the AE-L/AF-L button once. Press the button again to unlock the exposure.

² When recording movies, the focus remains locked after you press the AE-L/AF-L button once. Press the button again to unlock the focus.

Sound Settings

Press the MENU button → Y menu icon → Sound settings → OK button

Option	Description
Button sound	When On (default setting) is selected, the camera produces one beep when operations are performed, two beeps when focus is acquired on the subject, and three beeps when an error occurs. <ul style="list-style-type: none">• Sounds are disabled when using Pet portrait scene mode or Bird-watching mode.
Shutter sound	When On (default setting) is selected, the shutter sound is produced when the shutter is released. <ul style="list-style-type: none">• The shutter sound is not produced when using continuous shooting mode (except Continuous H and Continuous L), when using exposure bracketing, when recording movies, or when using Easy panorama or Pet portrait scene mode or Bird-watching mode.



Auto Off

Press the MENU button → Y menu icon → Auto off → OK button

Set the amount of time that elapses before the camera enters standby mode (📖24). You can select **30 s**, **1 min** (default setting), **5 min**, or **30 min**.

Setting the Auto Off Function

The time that passes before the camera enters standby mode is fixed in the following situations:

- When a menu is displayed: 3 minutes (when auto off is set to **30 s** or **1 min**)
- When the AC adapter is connected: 30 minutes

Format Card

Press the MENU button → Y menu icon → Format card → OK button

Use this option to format a memory card.

Formatting the memory cards permanently deletes all data. Data that has been deleted cannot be recovered. Make sure to save important images to a computer before formatting.

To start formatting, select **Format** on the screen that is displayed and press the OK button.

- Do not turn the camera off or open the battery-chamber/memory card slot cover during formatting.
- You may not be able to select this setting while a wireless connection is established.

Language

Press the MENU button → Y menu icon → Language → OK button

Select a language for display of camera menus and messages.





HDMI

Press the **MENU** button →  menu icon → **HDMI** →  button

Set the HDMI output of the camera.

You can output the live view image to HDMI-compatible devices without the information display, or set the output resolution.

Option	Description	
Clean HDMI output	On	<p>Output the live view image without the information display to an HDMI-compatible device. Use this option when you want to record images from the camera to a commercially available external recorder.</p> <ul style="list-style-type: none">• Rotate the mode dial to Movie manual. In addition, set the focus-mode selector to MF.• Turn on the camera by using the power switch after connecting the camera to an HDMI-compatible device.• The sound that is picked up by the microphone is output to the HDMI-compatible device.• When an information display appears on an external recorder monitor, press the DISP button of the camera () several times to turn off the information display.• 4K UHD image quality cannot be output.• Peaking display, as well as Movie options and Frame rate in the movie menu, are not available while the camera is connected to an HDMI-compatible device. Still images cannot be captured with the camera.• While the camera is connected to an HDMI-compatible device, you can press the  (movie-record) button on the camera to record a movie and save it on the memory card in the camera. The power-on lamp flashes while the camera is recording movies.
	Off (default setting)	Use this option to view captured images. You can also capture still images or record movies with the camera while viewing the subject on a TV monitor.



Option	Description
HDMI output	Select the image resolution when Clean HDMI output is set to On . <ul style="list-style-type: none"><li data-bbox="228 132 881 189">• The image resolution setting is fixed at Auto when Clean HDMI output is set to Off.

- The camera screen does not turn on while the camera is connected to an HDMI-compatible device.

Notes About HDMI Output Resolution

When **Clean HDMI output** is set to **Off**, or when it is set to **On** while **Auto** (default setting) is selected for **HDMI output**, the camera detects the resolution of the output device and automatically sets the HDMI output resolution.



Charge by Computer

Press the MENU button → Y menu icon → Charge by computer → OK button

Option	Description
AUTO Auto (default setting)	When the camera is connected to a computer that is running (📖103), the battery inserted into the camera is automatically charged using power supplied by the computer. <ul style="list-style-type: none">• The power-on lamp slowly flashes while the battery is charging. When charging is complete, the power-on lamp stops flashing and turns on.
Off	The battery inserted into the camera is not charged when the camera is connected to a computer.

✓ Notes About Charging with a Computer

- When connected to a computer, the camera turns on and starts charging. If the camera is turned off, charging stops.
- About 8 hours and 30 minutes are required to charge a fully exhausted battery. Charging time increases when images are transferred while the battery is charging.
- The camera turns off automatically if there is no communication with the computer for 30 minutes after the battery has finished charging.

✓ When the Power-on Lamp (Charge Lamp) Quickly Flashes

Charging cannot be performed, possibly due to one of the reasons described below.

- The ambient temperature is not suited to charging. Charge the battery indoors with an ambient temperature of 5°C to 35°C (41°F to 95°F).
- The USB cable is not connected correctly or the battery is faulty. Make sure that the USB cable is connected correctly or replace the battery if necessary.
- The computer is in sleep mode and is not supplying power. Wake up the computer.
- The battery cannot be charged because the computer cannot supply power to the camera due to the computer's settings or its specifications.

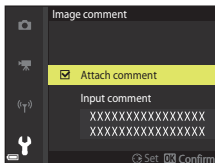

Image Comment

Press the **MENU** button → **Y** menu icon → Image comment → **OK** button

Attach a comment that was previously registered to images that will be captured. You can imprint the attached comment to images that will be sent to a smart device using the SnapBridge app. You must configure the SnapBridge app in advance. See the SnapBridge app online help for more information.

Option	Description
Attach comment (default setting)	<p>A comment registered with Input comment is attached to images.</p> <ul style="list-style-type: none">• Select Attach comment, press the ▶ button, and set the check box to on (✓). When the OK button is pressed, the comment will be attached to the images captured afterwards.
Input comment	<p>You can register a comment of up to 36 alphanumeric characters.</p> <ul style="list-style-type: none">• Select Input comment, press ▶, and the input screen is displayed. See “Operating the Text Input Keyboard” (📖163) for information about the input method.



✓ Notes About Image Comment

Comments cannot be attached to movies.



Copyright Information

Press the **MENU** button → **Y** menu icon → Copyright information → **OK** button

Attach the copyright information that was previously registered to images that will be captured.

You can imprint the attached copyright information to images that will be sent to a smart device using the SnapBridge app. You must configure the SnapBridge app in advance. See the SnapBridge app online help for more information.

Option	Description
Attach copyright info (default setting)	<p>Copyright information registered with Artist and Copyright is attached to images.</p> <ul style="list-style-type: none">• Select Attach copyright info, press the ▶ button, and set the check box to on (✓). When the OK button is pressed, the copyright information will be attached to the images captured afterwards.
Artist	<p>You can register an artist name of up to 36 alphanumeric characters.</p> <ul style="list-style-type: none">• Select Artist, press ▶, and the input screen is displayed. See “Operating the Text Input Keyboard” (📖163) for information about the input method.
Copyright	<p>You can register a copyright owner name of up to 54 alphanumeric characters.</p> <ul style="list-style-type: none">• Select Copyright, press ▶, and the input screen is displayed. See “Operating the Text Input Keyboard” (📖163) for information about the input method.

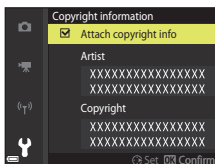

✓ Notes About Copyright Information

- To prevent illegal use of artist names and copyright owner names when lending or transferring ownership of the camera, make sure to disable the **Attach copyright info** setting. Also, make sure that the artist name and copyright owner name are blank.
- Nikon is not responsible for any kind of trouble or damage resulting from the use of **Copyright information**.
- Copyright information cannot be attached to movies.

📎 Copyright Information Display

When copyright information is entered for both **Artist** and **Copyright**, only the Copyright entry is attached to the images in the SnapBridge app.



Location Data

Press the **MENU** button → **Y** menu icon → Location data → **OK** button

Set whether or not to add shooting location information to the images that you take.

Option	Description
Download from device (default setting)	Select Yes to add location information from a smart device to the images that you take. Enable the location information function of the SnapBridge app.
Position	Display the obtained location information.

Toggle Av/Tv Selection

Press the **MENU** button → **Y** menu icon → Toggle Av/Tv selection → **OK** button

Change which controls to use for setting the exposure in **P**, **S**, **A**, **M**, **U**, or **M** (Movie manual) mode.

Option	Description
Do not toggle selection (default setting)	Use the command dial to set the flexible program or shutter speed (Tv), and the multi selector to set the f-number (Av).
Toggle selection	Use the multi selector to set the flexible program or shutter speed (Tv), and the command dial to set the f-number (Av).



Reset File Numbering

Press the **MENU** button → **Y** menu icon → Reset file numbering → **OK** button

When **Yes** is selected, the sequential numbering of file numbers is reset (📖208). After resetting, a new folder is created and the file number for the next image captured starts with "0001."

✓ Notes About Reset File Numbering

Reset file numbering cannot be applied when the folder number reaches 999 and there are images in the folder. Insert a new memory card or format the memory card (📖176).

- **Reset file numbering** cannot be performed when the write-protect switch on the memory card is in the "lock" position. Slide the write-protect switch to the "write" position (📖16, 193).

📎 Folders for Storing Files

Still images and movies shot or recorded with this camera are saved in folders of the memory card.

- Sequential numbers are added to folder names in ascending order, starting with "100" and ending with "999" (the folder names are not displayed on the camera).
- A new folder is created in the following situations:
 - When the number of files in a folder reaches 999
 - When a file in a folder is numbered "9999"
 - When **Reset file numbering** is performed
- A new folder is created each time a series of images are captured using interval timer shooting, and the images are saved in that folder with file numbers starting with "0001."



Peaking

Press the MENU button → Y menu icon → Peaking → OK button

Option	Description
On (default setting)	When operating manual focus, focusing is assisted by highlighting areas that are in focus in white on the image displayed on the screen (📖67, 68).
Off	Peaking is disabled.

Reset All

Press the MENU button → Y menu icon → Reset all → OK button

When **Reset** is selected, the camera's settings are restored to their default values.

- The network menu settings are also restored to their default values.
- Some settings, such as **Time zone and date** or **Language**, are not reset. User settings that were saved in **U** of the mode dial are not reset. To reset these settings, use **Reset user settings** (📖53).
- You may not be able to select this setting while a wireless connection is established.

Resetting File Numbering

To reset file numbering to "0001", delete all images saved on the memory card before selecting **Reset all. Reset file numbering** can also be used to reset to "0001" (📖183).

Firmware Version

Press the MENU button → Y menu icon → Firmware version → OK button

View the current camera firmware version.

- You may not be able to select this setting while a wireless connection is established.



Technical Notes

Notices.....	186
Notes About Wireless Communication Functions	188
Caring for the Product	190
The Camera	190
The Battery	191
The Charging AC Adapter	193
Memory Cards.....	193
Cleaning and Storage	195
Cleaning	195
Storage	195
Error Messages	196
Troubleshooting	199
File Names.....	208
Optional Accessories.....	209
Speedlights (External Flash Units).....	211
ML-L7 Remote Control	213
Specifications.....	218
Memory Cards That Can Be Used.....	223
Index	225



Notices

Notices for Customers in the U.S.A.

IMPORTANT SAFETY INSTRUCTIONS - SAVE THESE INSTRUCTIONS.

DANGER - TO REDUCE THE RISK OF FIRE OR ELECTRIC SHOCK, CAREFULLY FOLLOW THESE INSTRUCTIONS

For connection to a supply not in the U.S.A., use an attachment plug adapter of the proper configuration for the power outlet if needed.

The power supply unit is intended to be correctly orientated in a vertical or floor mount position.

Federal Communications Commission (FCC) Radio Frequency Interference Statement

This equipment has been tested and found to comply with the limits for a Class B digital device, pursuant to Part 15 of the FCC rules. These limits are designed to provide reasonable protection against harmful

interference in a residential installation. This equipment generates, uses, and can radiate radio frequency energy and, if not installed and used in accordance with the instructions, may cause harmful interference to radio communications. However, there is no guarantee that interference will not occur in a particular installation. If this equipment does cause harmful interference to radio or television reception, which can be determined by turning the equipment off and on, the user is encouraged to try to correct the interference by one or more of the following measures:

- Reorient or relocate the receiving antenna.
- Increase the separation between the equipment and receiver.
- Connect the equipment into an outlet on a circuit different from that to which the receiver is connected.
- Consult the dealer or an experienced radio/television technician for help.



CAUTIONS

Modifications

The FCC requires the user to be notified that any changes or modifications made to this device that are not expressly approved by Nikon Corporation may void the user's authority to operate the equipment.

Interface Cables

Use the interface cables sold or provided by Nikon for your equipment. Using other interface cables may exceed the limits of Class B Part 15 of the FCC rules.



Notice for Customers in Canada

CAN ICES-3 B / NMB-3 B

Notices for Customers in Europe

CAUTION: RISK OF EXPLOSION IF BATTERY IS REPLACED BY AN INCORRECT TYPE.

This symbol indicates that electrical and electronic equipment is to be collected separately.

The following apply only to users in European countries:

- This product is designated for separate collection at an appropriate collection point. Do not dispose of as household waste.
- Separate collection and recycling helps conserve natural resources and prevent negative consequences for human health and the environment that might result from incorrect disposal.
- For more information, contact the retailer or the local authorities in charge of waste management.



DISPOSE OF USED BATTERIES ACCORDING TO THE INSTRUCTIONS.

This symbol on the battery indicates that the battery is to be collected separately.

The following apply only to users in European countries:

- All batteries, whether marked with this symbol or not, are designated for separate collection at an appropriate collection point. Do not dispose of as household waste.
- For more information, contact the retailer or the local authorities in charge of waste management.



Notes About Wireless Communication Functions

Restrictions on Wireless Devices

The wireless transceiver included in this product conforms to wireless regulations in the country of sale and is not for use in other countries (products purchased in the EU or EFTA can be used anywhere within the EU and EFTA). Nikon does not accept liability for use in other countries. Users who are unsure as to the original country of sale should consult with their local Nikon service center or Nikon-authorized service representative. This restriction applies to wireless operation only and not to any other use of the product.

Security

Although one of the benefits of this product is that it allows others to freely connect for the wireless exchange of data anywhere within its range, the following may occur if security is not enabled:

- Data theft: Malicious third-parties may intercept wireless transmissions to steal user IDs, passwords, and other personal information.
- Unauthorized access: Unauthorized users may gain access to the network and alter data or perform other malicious actions. Note that due to the design of wireless networks, specialized attacks may allow unauthorized access even when security is enabled. Nikon is not responsible for data or information leaks that may occur during data transfer.
- Do not access networks that you are not permitted to use, even if they are displayed on your smartphone or tablet. Doing so may be regarded as unauthorized access. Only access networks that you are permitted to use.

Personal Information Management and Disclaimer

- User information registered and configured on the product, including wireless LAN connection settings and other personal information, is susceptible to alteration and loss resulting from operational error, static electricity, accident, malfunction, repair or other handling. Always keep separate copies of important information. Nikon is not responsible for any direct or indirect damages or lost profits resulting from alteration or loss of content that is not attributable to Nikon.
- Before discarding this product or transferring it to another owner, perform **Reset all** in the setup menu (📖113) to delete all user information registered and configured with the product, including wireless LAN connection settings and other personal information.
- Nikon is not responsible for any damages resulting from unauthorized use of this product by third parties in the event that the product is stolen or lost.



Precautions when Exporting or Carrying This Product Abroad

This product is controlled by the United States Export Administration Regulations (EAR). The permission of the United States government is not required for export to countries other than the following, which as of this writing are subject to embargo or special controls: Cuba, Iran, North Korea, Sudan, and Syria (list subject to change).

Notice for Customers in the U.S.A. and Canada

Federal Communications Commission (FCC) and Innovation, Science and Economic Development Canada (ISED)

Declaration of Conformity

This device complies with part 15 of FCC Rules and Innovation, Science and Economic Development Canada's licence-exempt RSSs. Operation is subject to the following two conditions: (1) this device may not cause harmful interference, and (2) this device must accept any interference received, including interference that may cause undesired operation.

FCC/ISED RF Exposure Statement

This transmitter must not be co-located or operated in conjunction with any other antenna or transmitter.

The available scientific evidence does not show that any health problems are associated with using low power wireless devices. There is no proof, however, that these low power wireless devices are absolutely safe. Low power wireless devices emit low levels of radio frequency energy (RF) in the microwave range while being used. Whereas high levels of RF can produce health effects (by heating tissue), exposure of low-level RF that does not produce heating effects causes no known adverse health effects. Many studies of low-level RF exposures have not found any biological effects. Some studies have suggested that some biological effects might occur, but such findings have not been confirmed by additional research. This product has been tested and found to comply with FCC/ISED radiation exposure limits set forth for an uncontrolled environment and meets the FCC radio frequency (RF) Exposure Guidelines and RSS-102 of the ISED radio frequency (RF) Exposure rules. Please refer to the SAR test report that was uploaded to FCC website.

Notice for Customers in Europe

Declaration of Conformity (Europe)

Hereby, Nikon Corporation declares that the radio equipment type COOLPIX P1000 is in compliance with Directive 2014/53/EU.

The full text of the EU declaration of conformity is available at the following internet address:

http://imaging.nikon.com/support/pdf/DoC_P1000.pdf.

- Operating frequency:
 - Wi-Fi: 2412–2462 MHz (1-11 channels)
 - Bluetooth: 2402–2480 MHz
 - Bluetooth Low Energy: 2402–2480 MHz
- Maximum output power: 9.2 dBm (EIRP)



Caring for the Product

Observe the precautions described below in addition to the warnings in "For Your Safety" (Ⓛvi-ix) when using or storing the device.

The Camera

Do Not Apply Strong Impact to the Camera

The product may malfunction if subjected to strong shock or vibration. In addition, do not touch or apply force to the lens.

Keep Dry

The device will be damaged if immersed in water or subjected to high humidity.

Avoid Sudden Changes in Temperature

Sudden changes in temperature, such as when entering or leaving a heated building on a cold day, can cause condensation to form inside the device. To prevent condensation, place the device in a carrying case or a plastic bag before exposing it to sudden changes in temperature.

Keep Away from Strong Magnetic Fields

Do not use or store this device in the vicinity of equipment that generates strong electromagnetic radiation or magnetic fields. Doing so could result in loss of data or camera malfunction.

Do Not Point the Lens at the Sun

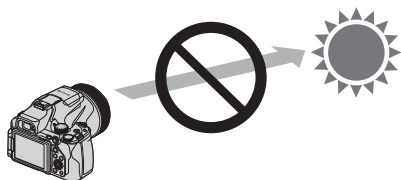

Avoid pointing the lens at the sun or other strong light sources when shooting or when leaving the camera unattended without a lens cap. Strong light sources such as sunlight are concentrated through the lens, which may cause deformation of the internal parts of the lens or discoloration or burn-in on the image sensor. The camera may be damaged even when the lens is pointed toward the sun for a few seconds, particularly when the lens is in a telephoto position. The camera may not be able to perform exposure control when the internal parts of the lens are deformed.

Unevenness may appear in images when discoloration or burn-in occurs on the image sensor. It is recommended that you attach the lens cap when you are not using the camera.



Turn the Product Off Before Removing or Disconnecting the Power Source or Memory Card

Do not remove the battery while the product is on, or while images are being saved or deleted. Forcibly cutting power in these circumstances could result in loss of data or in damage to the memory card or internal circuitry.

Notes About the Monitor

- Monitors (including electronic viewfinders) are constructed with extremely high precision; at least 99.99% of pixels are effective, with no more than 0.01% being missing or defective. Hence while these displays may contain pixels that are always lit (white, red, blue, or green) or always off (black), this is not a malfunction and has no effect on images recorded with the device.
- Images in the monitor may be difficult to see under bright lighting.
- Do not apply pressure to the monitor, as this could cause damage or malfunction. Should the monitor break, care should be taken to avoid injury caused by broken glass and to prevent the liquid crystal from the display touching the skin or entering the eyes or mouth.

The Battery

Precautions for Use

- Note that the battery may become hot after use.
- Do not use the battery at ambient temperatures below 0°C (32°F) or above 40°C (104°F) as this could cause damage or malfunction.
- If you notice any abnormalities such as excessive heat, smoke, or an unusual smell coming from the battery, immediately discontinue use and consult your retailer or Nikon-authorized service representative.
- After removing the battery from the camera or optional battery charger, put the battery in a plastic bag, etc. in order to insulate it.

Charging the Battery

Check the battery level before using the camera and replace or charge the battery if necessary.

- Charge the battery indoors with an ambient temperature of 5°C to 35°C (41°F to 95°F) before use.
- A high battery temperature may prevent the battery from charging properly or completely, and may reduce battery performance. Note that the battery may become hot after use; wait for the battery to cool before charging. When charging the battery inserted into this camera using the Charging AC Adapter or a computer, the battery is not charged at battery temperatures below 0°C (32°F) or above 50°C (122°F).
- Do not continue charging once the battery is fully charged as this will result in reduced battery performance.
- The battery temperature may increase during charging. However, this is not a malfunction.



Carrying Spare Batteries

Whenever possible, carry fully charged spare batteries when taking pictures on important occasions.

Using the Battery When Cold

On cold days, the capacity of batteries tends to decrease. If an exhausted battery is used at a low temperature, the camera may not turn on. Keep spare batteries in a warm place and exchange as necessary. Once warmed, a cold battery may recover some of its charge.

Battery Terminals

Dirt on the battery terminals may prevent the camera from functioning. Should the battery terminals become dirty, wipe them off with a clean, dry cloth before use.

Charging an Exhausted Battery

Turning the camera on or off while an exhausted battery is inserted in the camera may result in reduced battery life. Charge the exhausted battery before use.

Storing the Battery

- Always remove the battery from the camera or optional battery charger when it is not being used. Minute amounts of current are drawn from the battery while it is in the camera, even when not in use. This may result in excessive battery drain and complete loss of function.
- Recharge the battery at least once every six months and completely exhaust it before returning it to storage.
- Put the battery in a plastic bag, etc. in order to insulate it and store it in a cool place. The battery should be stored in a dry location with an ambient temperature of 15°C to 25°C (59°F to 77°F). Do not store the battery in hot or extremely cold locations.

Battery Life

A marked drop in the time a fully charged battery retains its charge, when used at room temperature, indicates that the battery needs to be replaced. Purchase a new battery.

Recycling Used Batteries

Recycle rechargeable batteries in accord with local regulations, being sure to first insulate the terminals with tape.



The Charging AC Adapter

- The EH-73P/EH-73PCH Charging AC Adapter is for use only with compatible devices. Do not use with another make or model of device.
- Do not use any USB cable other than the UC-E21. Using a USB cable other than the UC-E21 could result in overheating, fire or electric shock.
- Do not, under any circumstances, use another make or model of AC adapter other than the EH-73P/EH-73PCH Charging AC Adapter, and do not use a commercially available USB-AC adapter or a battery charger for a mobile phone. Failure to observe this precaution could result in overheating or in damage to the camera.
- The EH-73P/EH-73PCH is compatible with AC 100–240 V, 50/60 Hz electrical outlets. When using in other countries, use a plug adapter (commercially available) as necessary. For more information about plug adapters, consult your travel agency.

Memory Cards

Precautions for Use

- Use only Secure Digital memory cards (📖223).
- Be sure to follow the precautions described in the documentation included with the memory card.
- When the write-protect switch on the memory card is in the “lock” position, images cannot be captured or deleted, and the card cannot be formatted.
- Do not put labels or stickers on memory cards.

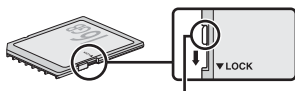

Write-protect switch



Formatting

- Do not format the memory card using a computer.
- The first time you insert a memory card that has been used in another device into this camera, be sure to format it with this camera. We recommend formatting new memory cards with this camera before using them with this camera.
- **Note that formatting a memory card permanently deletes all images and other data on the memory card.** Be sure to make copies of any images you wish to keep before formatting the memory card.
- If the message **Card is not formatted. Format card?** is displayed when the camera is turned on, the memory card must be formatted. If there is data that you do not want to delete, select **No**. Copy the necessary data to a computer, etc. If you want to format the memory card, select **Yes**. The confirmation dialog will be displayed. To start formatting, press the  button.
- Do not perform the following during formatting, while data is being written to or deleted from the memory card, or during data transfer to a computer. Failure to observe this precaution could result in the loss of data or in damage to the camera or memory card:
 - Open the battery-chamber/memory card slot cover to remove/insert the battery or memory card.
 - Turn off the camera.
 - Disconnect the AC adapter.



Cleaning and Storage

Cleaning

Do not use alcohol, thinner, or other volatile chemicals.

Lens/ viewfinder	Avoid touching glass parts with your fingers. Remove dust or lint with a blower (typically a small device with a rubber bulb attached to one end that is pumped to produce a stream of air out the other end). To remove fingerprints or other stains that cannot be removed with a blower, wipe the lens with a soft cloth, using a spiral motion that starts at the center of the lens and working toward the edges. If this fails, clean the lens using a cloth lightly dampened with commercial lens cleaner.
Monitor	Remove dust or lint with a blower. To remove fingerprints and other stains, clean the monitor with a soft, dry cloth, being careful not to apply pressure.
Body	Use a blower to remove dust, dirt, or sand, then wipe gently with a soft, dry cloth. After using the camera at the beach or other sandy or dusty environment, wipe off any sand, dust, or salt with a dry cloth lightly dampened with fresh water and dry thoroughly. Note that foreign matter inside the camera could cause damage not covered by the warranty.

Storage

Remove the battery if the camera will not be used for an extended period. To prevent mold or mildew, take the camera out of storage at least once a month.

Turn the camera on and release the shutter a few times before putting the camera away again. Do not store the camera in any of the following locations:



- Places that are poorly ventilated or subject to humidity of over 60%
- Exposed to temperatures above 50°C (122°F) or below -10°C (14°F)
- Next to equipment that produces strong electromagnetic fields, such as televisions or radios

For storing the battery, follow the precautions in “The Battery” (📖191) in “Caring for the Product” (📖190).



Error Messages









Refer to the table below if an error message is displayed.

Display	Cause/Solution	
Battery temperature is elevated. The camera will turn off.	The camera turns off automatically. Wait until the camera or battery temperature has cooled before resuming use.	-
The camera will turn off to prevent overheating.		
Memory card is write protected.	The write-protect switch is in the "lock" position. Slide the write-protect switch to the "write" position.	16, 193
This card cannot be used.	An error occurred while accessing the memory card. <ul style="list-style-type: none"> • Use an approved memory card. • Check that the terminals are clean. • Confirm that the memory card is correctly inserted. 	16, 223
This card cannot be read.		
Card is not formatted. Format card?	The memory card has not been formatted for use in the camera. Formatting deletes all data saved on the memory card. If you need to keep copies of any images, make sure to select No and save the copies to a computer or other medium before formatting the memory card. Select Yes and press the  button to format the memory card.	16, 194
Out of memory.	Delete images or insert a new memory card.	16, 28
Image cannot be saved.	An error occurred while saving the image. Insert a new memory card or format the memory card.	16, 176
	The camera has run out of file numbers. Insert a new memory card or format the memory card.	16, 176
Image cannot be modified.	Check that the images can be edited.	83, 205
Cannot record movie.	A time-out error occurred while saving the movie on the memory card. Select a memory card with a faster write speed.	223
Cannot reset file numbering.	File numbering cannot be reset because the sequential number of a folder has reached the upper limit. Insert a new memory card or format the memory card.	16, 176



Display	Cause/Solution	
Set the focus-mode selector to MF.	When Clean HDMI output is set to On and the camera is connected to an HDMI-compatible device, set the focus-mode selector to MF .	5, 177
Memory contains no images.	Insert a memory card that contains images.	16
File contains no image data.	The file was not created or edited with this camera. The file cannot be viewed on this camera. View the file using a computer or the device used to create or edit this file.	–
All images are hidden.	<ul style="list-style-type: none"> • There are no images available for a slide show, etc. • There are no images that can be displayed on the image selection screen for deletion. 	–
This image cannot be deleted.	The image is protected. Disable protection.	159
Raise the flash.	<ul style="list-style-type: none"> • When the scene mode is Scene auto selector, you can capture an image even if the built-in flash is lowered but the flash will not fire. • When the scene mode is Night portrait or Backlighting with HDR set to Off, you must raise the built-in flash to capture an image. 	34 35, 37
Turn the camera off and then on again.	A lens error occurred. Do not apply force to the lens. Turn the camera off and then on again to return the lens to normal operation. If the error persists after turning the camera off and on, contact your retailer or Nikon-authorized service representative.	199
Speedlight setting error	A Speedlight function that cannot be used with the camera is set. Change the Speedlight setting.	211
Communications error	An error occurred while communicating with the printer. Turn the camera off and reconnect the USB cable.	105
System error	An error occurred in the camera's internal circuitry. Turn the camera off, remove and reinsert the battery, and turn the camera on. If the error persists, contact your retailer or Nikon-authorized service representative.	199



Display	Cause/Solution	
Printer error: check printer status.	After solving the problem, select Resume and press the  button to resume printing.*	–
Printer error: check paper.	Load the specified size of paper, select Resume , and press the  button to resume printing.*	–
Printer error: paper jam.	Remove the jammed paper, select Resume , and press the  button to resume printing.*	–
Printer error: out of paper.	Load the specified size of paper, select Resume , and press the  button to resume printing.*	–
Printer error: check ink.	There is a problem with the printer's ink. Check the ink, select Resume , and press the  button to resume printing.*	–
Printer error: out of ink.	Replace the ink cartridge, select Resume , and press the  button to resume printing.*	–
Printer error: file corrupt.	There is a problem with the image file to be printed. Select Cancel and press the  button to cancel printing.	–
Clean HDMI output enabled. Select "Movie manual" mode.	When Clean HDMI output is set to On and the camera is connected to an HDMI-compatible device, rotate the mode dial to Movie manual.	94

* See the documentation provided with your printer for further guidance and information.





Troubleshooting

If the camera fails to function as expected, check the list of common problems below before consulting your retailer or Nikon-authorized service representative.

Power, Display, Settings Issues

Problem	Cause/Solution	
The camera is on but does not respond.	<ul style="list-style-type: none"> • Wait for recording to end. • If the problem persists, turn the camera off. If the camera does not turn off, remove and reinsert the battery or batteries or, if you are using an AC adapter, disconnect and reconnect the AC adapter. Note that although any data currently being recorded will be lost, data that have already been recorded will not be affected by removing or disconnecting the power source. 	–
The camera cannot be turned on.	The battery is exhausted.	16, 17, 191
The camera turns off without warning.	<ul style="list-style-type: none"> • The camera automatically turns off to save power (auto off function). • The camera and battery may not work properly at low temperatures. • The inside of the camera has become hot. Leave the camera off until the inside of the camera has cooled, and then try turning it on again. 	24 191 –
The monitor or viewfinder is blank.	<ul style="list-style-type: none"> • The camera is off. • The battery is exhausted. • The camera automatically turns off to save power (auto off function). • You cannot turn on both the monitor and viewfinder at the same time. It may take a while to switch between the monitor and viewfinder. • The camera is connected to a TV or computer. • Interval timer shooting, Multiple exp. Lighten scene mode (when Star trails is set) shooting, or time-lapse movie shooting is in progress, or the camera is capturing images with a long time-exposure using the Bulb setting or Time setting. 	19 22 24 – – –
The camera becomes hot.	The camera may become hot when used for an extended period of time such as to shoot movies, or when used in a hot environment; this is not a malfunction.	–







Problem	Cause/Solution	
The battery inserted in the camera cannot be charged.	<ul style="list-style-type: none"> • Confirm all connections. • When connected to a computer, the camera may not charge for any of the reasons described below. <ul style="list-style-type: none"> - Off is selected for Charge by computer in the setup menu. - Battery charging stops if the camera is turned off. - Battery charging is not possible if the camera's display language and date and time have not been set, or the date and time were reset after the camera's clock battery was exhausted. Use the Charging AC Adapter to charge the battery. - Battery charging may stop when the computer enters sleep mode. - Depending on the computer specifications, settings, and status, battery charging may not be possible. 	17 113, 179 - 19 - -
The monitor is hard to see.	<ul style="list-style-type: none"> • The surrounding area is too bright. <ul style="list-style-type: none"> - Move to a darker place. - Use the viewfinder. • Adjust the screen brightness. 	26 167
The viewfinder is hard to see.	<ul style="list-style-type: none"> • Adjust the diopter of the viewfinder. • Adjust the screen brightness. 	26 167
 flashes on the screen.	<ul style="list-style-type: none"> • If the camera clock has not been set,  flashes on the shooting screen, and images and movies saved before the clock is set are dated "00/00/0000 00:00" and "01/01/2018 00:00" respectively. Set the correct time and date for Time zone and date in the setup menu. • The camera clock is not as accurate as ordinary watches or clocks. Periodically compare the time of the camera clock with that of a more accurate timepiece and reset as required. 	10, 164
Date and time of recording are not correct.		
No information displayed on the screen.	Shooting and photo information may be hidden. Press the DISP button until information is displayed.	8
Date stamp not available.	Time zone and date has not been set in the setup menu.	113, 164
Date not stamped on images even when Date stamp is enabled.	<ul style="list-style-type: none"> • The current shooting mode does not support Date stamp. • A function that restricts the Date stamp function is enabled. • The date cannot be stamped on movies. 	31, 170 75 -





Problem	Cause/Solution	
Screen for setting time zone and date is displayed when the camera is turned on.	The clock battery is exhausted; all settings were restored to their default values. Configure the camera settings again. <ul style="list-style-type: none"> The internal clock battery is used to power the camera clock and to retain certain settings. Charging time of the clock battery takes about 10 hours when you insert the battery into the camera or connect the AC adapter (available separately) to the camera, and the clock battery operates for several days even after the camera battery is removed. 	-
The camera settings reset.		
Reset file numbering cannot be done.	Although a new folder is created on the memory card by resetting file numbering, etc., if the sequential number of a folder name (which is not displayed on the camera) reaches the upper limit ("999"), reset is not possible. Change the memory card, or format the memory card. <ul style="list-style-type: none"> The write-protect switch is in the "lock" position. Slide the write-protect switch to the "write" position. 	176, 183
The camera makes sound.	When Autofocus mode is set to Full-time AF or while in some shooting modes, the camera may produce an audible focusing sound.	31, 143, 153

Shooting Issues

Problem	Cause/Solution	
Cannot switch to shooting mode.	Disconnect the USB cable.	103
Cannot take pictures or record movies.	<ul style="list-style-type: none"> When the camera is in playback mode, press the  button, shutter-release button or  button. When menus are displayed, press the MENU button. When the scene mode is Night portrait or Backlighting with HDR set to Off, raise the built-in flash. The built-in flash is charging while  is flashing. The battery is exhausted. Insert a memory card with sufficient free space. 	2, 27 114 25, 35, 37 55 17, 191 16





Problem	Cause/Solution	
The camera cannot focus.	<ul style="list-style-type: none"> The subject is too close. Try shooting using the Scene auto selector or Close-up scene mode, or the macro close-up focus mode. Incorrect focus mode setting. Check or change the setting. The subject is hard to focus on. Set AF assist in the setup menu to Auto. Subject is not in focus area when the shutter-release button is pressed halfway. The focus-mode selector is set to MF (manual focus). Turn the camera off and then on again. The camera may move slightly when operated, even if it is attached to a tripod, which may interfere with the autofocus. 	31, 34, 36, 54, 62, 61, 65, 113, 172, 24, 140, 67, –, 23
Colored stripes appear on the screen when shooting.	<p>Colored stripes may appear when shooting subjects with repeating patterns (such as window blinds); this is not a malfunction.</p> <p>The colored stripes will not appear in captured images or recorded movies. However, when using Continuous H: 120 fps or HS 480/4x, the colored stripes may be seen in the captured images and recorded movies.</p>	–
Images are blurred.	<ul style="list-style-type: none"> Use the flash. Enable vibration reduction. Use a tripod to stabilize the camera (using the self-timer setting of  10s (10 seconds) at the same time is more effective). 	25, 55, 154, 171, 23, 58
Bright specks appear in images captured with flash.	Flash is reflecting off particles in air. Lower the built-in flash.	25, 55
Flash does not fire.	<ul style="list-style-type: none"> The built-in flash is lowered. A shooting mode where the flash cannot fire is selected. A function that restricts the flash is enabled. 	25, 73, 75
Digital zoom cannot be used.	<ul style="list-style-type: none"> Digital zoom is set to Off in the setup menu. Digital zoom cannot be used with certain shooting modes or when using certain settings in other functions. 	113, 172, 78, 172
Image size not available.	<ul style="list-style-type: none"> A function that restricts the Image size option is enabled. When the scene mode is set to Easy panorama, the image size is fixed. 	75, 41



Problem	Cause/Solution	
No sound when the shutter is released.	Off is selected for Shutter sound in Sound settings in the setup menu. No sound is produced with some shooting modes and settings, even when On is selected.	78, 113, 175
AF-assist illuminator does not light.	Off is selected for the AF assist option in the setup menu. AF-assist illuminator may not light depending on the position of the focus area or the current scene mode, even when Auto is selected.	113, 172
Images appear smeared.	The lens is dirty. Clean the lens.	195
Colors are unnatural.	White balance or hue is not adjusted properly.	37, 129
Randomly spaced bright pixels ("noise") appear in image.	The subject is dark and the shutter speed is too slow or ISO sensitivity is too high. Noise can be reduced by: <ul style="list-style-type: none"> • Using the flash • Specifying a lower ISO sensitivity setting 	25, 55, 137
Bright spots appear in image.	When shooting at a slow shutter speed in multiple exposure mode, noise (bright spots) may appear in saved images.	–
Images are too dark (underexposed).	<ul style="list-style-type: none"> • The flash window is blocked. • The subject is beyond the range of the flash. • Adjust exposure compensation. • Increase ISO sensitivity. • The subject is backlit. Use the flash or the Backlighting scene mode. 	22, 220, 69, 137, 25, 37
Images are too bright (overexposed).	Adjust exposure compensation.	69
Skin tones are not softened.	<ul style="list-style-type: none"> • Under some shooting conditions, facial skin tones may not be softened. • For images containing four or more faces, try using Skin softening in the playback menu. 	65, 85, 113



Problem	Cause/Solution	
Saving images takes time.	<p>It may take more time to save images in the following situations:</p> <ul style="list-style-type: none"> • When the noise reduction function is in operation • When the flash mode is set to  (auto with red-eye reduction/red-eye reduction) • When capturing images in the following scene modes. <ul style="list-style-type: none"> - Noise reduction burst in Landscape or Close-up Hand-held in Night landscape - HDR is set to On in Backlighting - Easy panorama • When using the Bulb setting or Time setting to capture images with a long time-exposure • Continuous in the shooting menu is set to Continuous H: 120 fps or Continuous H: 60 fps • When using smile timer while shooting • When using Active D-Lighting while shooting • When using multiple exposure while shooting • When Image quality is set to RAW, RAW + Fine, or RAW + Normal • When capturing still images while recording a movie with Movie options set to 2160/30p or 2160/25p 	<p>–</p> <p>56</p> <p>34, 36</p> <p>36</p> <p>37</p> <p>41</p> <p>50</p> <p>113,</p> <p>133</p> <p>60</p> <p>144</p> <p>145</p> <p>121</p> <p>93</p>
A ring-shaped belt or rainbow-colored stripe appears on the screen or images.	<p>When shooting with backlighting or when a very strong light source (such as sunlight) is in the frame, a ring-shaped belt or rainbow-colored stripe (ghosting) may occur.</p> <p>Change the position of the light source, or frame the picture so that the light source does not enter the frame, and try again.</p>	–
Cannot select a setting/ Selected setting is disabled.	<ul style="list-style-type: none"> • Certain menu items are unavailable depending on the shooting mode. Menu items that cannot be selected are displayed in gray. • A function that restricts the selected function is enabled. 	–



Playback Issues

Problem	Cause/Solution	
File cannot be played back.	<ul style="list-style-type: none"> • This camera may not be able to play back images saved with another make or model of digital camera. • This camera cannot play back RAW images or movies saved with another make or model of digital camera. • This camera may not be able to play back data edited on a computer. • Files cannot be played back during interval timer shooting. 	<p>–</p> <p>–</p> <p>–</p> <p>133</p>





Problem	Cause/Solution	
Cannot zoom in on image.	<ul style="list-style-type: none"> • Playback zoom cannot be used with movies. • This camera may not be able to zoom in on images captured with another make or model of digital camera. • When zooming in on a small-sized image, the magnification rate shown on the screen may differ from the actual magnification rate of the image. 	–
Cannot edit image.	<ul style="list-style-type: none"> • Some images cannot be edited. Images that have already been edited may not be edited again. • There is not enough free space on the memory card. • This camera is unable to edit images captured with other cameras. • Editing functions used for images are not available for movies. 	43, 83, 122 – – –
Cannot rotate image.	This camera cannot rotate images captured with another make or model of digital camera.	–



External Device Issues

Problem	Cause/Solution	
Cannot establish a wireless connection with a smart device. ¹	<ul style="list-style-type: none"> • When establishing a wireless connection for the first time, follow the instructions in the included “SnapBridge Connection Guide” and connect. 	–
	<ul style="list-style-type: none"> • If a wireless connection is established, perform the following operations. <ul style="list-style-type: none"> - Turn the camera off and then on again. - Restart the SnapBridge app. - Cancel the connection and then establish a connection again. 	–
	<ul style="list-style-type: none"> • Check the Network menu settings on the camera. <ul style="list-style-type: none"> - Set Airplane mode to Off. - Set Bluetooth → Connection to Enable. 	161
	<ul style="list-style-type: none"> • If the camera is registered with two or more smart devices, select the smart device you want to connect in Network menu → Bluetooth → Paired devices in the camera. If two or more cameras are registered in the SnapBridge app, switch the connection on the app. 	162
	<ul style="list-style-type: none"> • Use a sufficiently charged battery to prevent the camera from turning off unexpectedly. 	–
	<ul style="list-style-type: none"> • Insert a memory card with sufficient free space into the camera. 	16
	<ul style="list-style-type: none"> • Disconnect the HDMI cable or USB cable. 	103
	<ul style="list-style-type: none"> • Enable Bluetooth, Wi-Fi, and the location data functions on the smart device. 	–
<ul style="list-style-type: none"> • In the  tab of the SnapBridge app → Auto link options → turn on Auto link. If it is off, Download pictures and Remote photography can be used, but images cannot be downloaded automatically. 	–	



Problem	Cause/Solution	
<p>Cannot upload images to a smart device that has a wireless connection established with the SnapBridge app.¹</p>	<ul style="list-style-type: none"> • Perform the operations described below when uploading automatically. <ul style="list-style-type: none"> - On the camera, set Network menu → Send while shooting → Still images to Yes. - In the  tab of the SnapBridge app → Auto link options → turn on Auto link. - In the  tab of the SnapBridge app → Auto link options → turn on Auto download. - If Network menu → Bluetooth → Send while off on the camera is set to Off, turn on the camera or set it to On. • When there is a large number of images to upload during Bluetooth communication, communication may be disconnected while uploading images. If you turn the camera off and then on again, the camera is reconnected to the smart device and image upload resumes in Send while shooting or Mark for upload. • Insert a memory card into the camera. • You may not be able to upload images or uploading may be canceled while the camera is being operated. 	<p>161</p> <p>–</p> <p>–</p> <p>162</p> <p>157, 161</p> <p>16</p> <p>–</p>
<p>Cannot perform remote photography from a smart device that has a wireless connection established with the SnapBridge app.¹</p>	<ul style="list-style-type: none"> • You cannot perform remote photography without a memory card inserted into the camera. Insert the memory card. • You may not be able to perform remote photography while the camera is being operated. 	<p>16</p> <p>–</p>
<p>Cannot upload still images at the original size by using the SnapBridge app.¹</p>	<p>For Send while shooting and Mark for upload in the camera, the image size that can be uploaded is restricted to 2 megapixels. Use Download pictures in the SnapBridge app to upload the original size of still images.</p>	<p>–</p>
<p>Communication quality is poor or image upload speed is extremely slow when using wireless connection with SnapBridge app.¹</p>	<p>On the camera, try changing the channel in Network menu → Wi-Fi → Network settings.</p>	<p>162</p>



Problem	Cause/Solution	
The camera does not respond when operating the ML-L7 Remote Control. ²	<ul style="list-style-type: none"> The camera is not connected to the ML-L7 Remote Control (available separately). Press the power button on the remote control to establish the connection. If the  icon is not displayed on the shooting screen, perform pairing again. The remote control can be used only for shooting operations. Fn1 (Function 1) / Fn2 (Function 2) buttons on the remote control cannot be used with this camera. 	216 213 214
Cannot be paired with the ML-L7 Remote Control. ²	<p>Check the Network menu settings on the camera.</p> <ul style="list-style-type: none"> Select Remote control in Choose connection. Set Airplane mode to Off. Set Bluetooth → Connection to Enable. 	161
Images saved in the camera are not displayed on a connected smart device or computer.	<p>If the number of images saved on a memory card in the camera exceeds 10,000, images captured thereafter may not be displayed in a connected device.</p> <ul style="list-style-type: none"> Reduce the number of images saved on the memory card. Copy the necessary images to a computer, etc. 	–
Images are not displayed on TV.	<ul style="list-style-type: none"> A computer or printer is connected to the camera. The memory card contains no images. 	–
Nikon Transfer 2 does not start when the camera is connected to a computer.	<ul style="list-style-type: none"> The camera is off. The battery is exhausted. The USB cable is not correctly connected. The camera is not recognized by the computer. The computer is not set to start Nikon Transfer 2 automatically. For more information about Nikon Transfer 2, refer to help information contained in Nikon Transfer 2. 	– 103, 179 103, 109 – –
The PictBridge screen is not displayed when the camera is connected to a printer.	<p>With some PictBridge-compatible printers, the PictBridge startup screen may not be displayed and it may be impossible to print images when Auto is selected for Charge by computer in the setup menu. Set Charge by computer to Off and reconnect the camera to the printer.</p>	113, 179
Images to be printed are not displayed.	The memory card contains no images.	–
Cannot select paper size with the camera.	<p>The camera cannot be used to select the paper size in the following situations, even when printing from a PictBridge-compatible printer. Use the printer to select the paper size.</p> <ul style="list-style-type: none"> The printer does not support the paper sizes specified by the camera. The printer automatically selects the paper size. 	–

¹ See the included “SnapBridge Connection Guide” and SnapBridge online help.

² Refer to the User’s Manual provided with the ML-L7 Remote Control (available separately).



File Names

Images or movies are assigned file names as follows.

File name: DSCN0001.JPG

(1) (2) (3)

(1) Identifier	<p>Not shown on the screen of the camera.</p> <ul style="list-style-type: none">• DSCN: Original still images, movies, still images created by the movie editing function• SSCN: Small picture copies• RSCN: Cropped copies• FSCN: Images created by an image editing function other than crop and small picture, movies created by the movie editing function
(2) File number	<p>Assigned in ascending order, starting with "0001" and ending with "9999."</p> <ul style="list-style-type: none">• A new folder is created each time a series of images are captured using interval timer shooting, and the images are saved in that folder with file numbers starting with "0001."
(3) Extension	<p>Indicates file format.</p> <ul style="list-style-type: none">• .JPG: JPEG still images• .NRW: RAW still images• .MP4: Movies

Notes

When images are captured with the **Image quality** (📖121) setting set to **RAW + Fine** or **RAW + Normal**, the RAW and JPEG images that are saved at the same time are assigned the same identifier and file number. The pair of images is saved in the same folder, and is counted as one file.

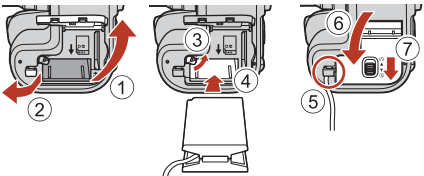

Optional Accessories

Battery charger	MH-29 Battery Charger Charging time is about 3 hours for a fully exhausted battery.
AC adapter	EH-5b/EH-5c AC Adapter and EP-5C Power Connector When the power connector is inserted into the camera and the AC adapter is connected, the camera can be powered from an electrical outlet. The AC adapter and the power connector are available separately. (How to attach the EP-5C)  <ul style="list-style-type: none">• Open the power connector cover (2), and insert the power connector with the positive and negative terminals oriented correctly (4).• Before closing the battery-chamber/memory card slot cover, fully insert the power connector cable into the slot in the battery chamber (5). If part of the cable protrudes from the slots, the cover or cable may be damaged when the cover is closed.• Insert the DC plug of the AC Adapter into the DC plug connector of the Power Connector.
Accessory shoe cover	BS-1 Accessory Shoe Cover Protects the accessory shoe.
Speedlight (external flash unit)	See “Speedlights (External Flash Units)” (211) for information on compatible Speedlights and how to use them.
Filter	77NC 77mm Screw-on Neutral Color NC Filter (Φ77 mm) Protects the lens. When you use the built-in flash with the filter attached, the image periphery may appear dark.



<p>External microphone</p>	<ul style="list-style-type: none"> • ME-1 Stereo Microphone • ME-W1 Wireless Microphone <p>Connect the audio cable (included with the wireless microphone) to the headphone jack of the receiver and the external microphone connector of the camera. See the documentation provided with the ME-W1 for more information.</p> <div data-bbox="567 65 951 331"> <p>External microphone connector</p> </div>
<p>Remote control accessories</p>	<p>MC-DC2 Remote Cord You can use the MC-DC2 to release the shutter when it is connected to the accessory terminal.</p> <hr/> <p>WR-R10/WR-T10 Wireless Remote Controller When the WR-R10 (receiver) is connected to the accessory terminal, the camera can be controlled wirelessly using the WR-T10 (transmitter). A set that includes the WR-R10 Wireless Remote Controller (receiver), WR-T10 Wireless Remote Controller (transmitter), and WR-A10 WR Adapter is also available.</p> <p>WR-1 Wireless Remote Controller The WR-1 can be configured as a transmitter or a receiver. When the WR-1 is connected to the accessory terminal for use as a receiver, the camera can be controlled wirelessly using the WR-T10 Wireless Remote Controller or another WR-1 acting as a transmitter.</p> <hr/> <p>ML-L7 Remote Control See "ML-L7 Remote Control" (📖213) for information on how to use it.</p>

Availability may vary with country or region.
See our website or brochures for the latest information.



Speedlights (External Flash Units)

The following Speedlights can be used with the camera. The standard i-TTL flash function is available.

- SB-5000, SB-700, SB-500

How to Attach the Speedlight

- Do not raise the built-in flash.
- Refer to the documentation provided with your Speedlight for more information on how to attach and detach the Speedlight with a locking pin and other details.
- Attempting to attach an accessory that does not support this camera may damage the camera and the accessory.

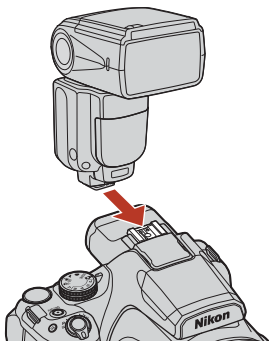

✔ Notes About the Built-in Flash

The built-in flash of this camera cannot be used when a Speedlight is attached.

Do not raise the built-in flash when a Speedlight is attached. Doing so may cause it to hit the Speedlight, resulting in product damage.

✔ Use Only Nikon Flash Accessories

Use only Nikon Speedlights. Flash units of other manufacturers (with voltages over 250 V applied to the camera's X sync contact, or causing short circuit at the accessory shoe contact) could not only prevent normal operation, but damage the sync circuitry of the camera or flash.

✔ Notes About Using Speedlights (External Flash Units)

If vignetting appears in the captured image, try to put some distance between the camera and the subject or remove the lens hood.



Functions That Can Be Used in Combination with the Speedlight

		SB-5000	SB-700	SB-500
i-TTL	i-TTL balanced fill-flash	–	–	–
	Standard i-TTL flash	✓	✓	✓
AA	Auto aperture flash	✓	–	–
A	Non-TTL auto flash	–	–	–
M	Manual flash	✓	✓	–
GN	Distance-priority manual flash	✓	✓	–
RPT	Repeating flash	✓	–	–
Red-eye reduction		✓	✓	✓



Notes About i-TTL Flash

- The monitor preflashes are fired to measure the reflecting light from a subject in order to adjust the flash output of the Speedlight.
 - Standard i-TTL flash: The flash output is adjusted to achieve proper exposure according to the brightness of the main subject without consideration of the background light. This setting is optimal for taking images with emphasis on the main subjects.
- When shooting using i-TTL flash, set the flash control mode of the Speedlight to i-TTL before taking pictures.



Notes About Speedlights

- This camera does not support flash color information communication, Auto FP High-Speed Sync, FV lock, AF-assist illumination for multi-point AF, or the wireless lighting function when using Speedlights.
- When using the power zoom function with the SB-5000 or SB-700, the zoom head position is automatically set depending on the focal length of the lens.
- When using a Speedlight, the image periphery may appear dark if the zoom is at the wide-angle position. In such cases, use the wide panel of the SB-5000 or SB-700.
- When set to STBY (standby), the Speedlight turns on and off at the same time as the camera. Confirm on the Speedlight that the flash-ready indicators are on.
- Refer to the documentation provided with your Speedlight for more information.



ML-L7 Remote Control

You can pair the camera with the ML-L7 Remote Control (available separately) (📖216) via Bluetooth, and use it to control the camera. The functions described in “Parts and Functions of the Remote Control (for P1000)” (📖214) can be performed when shooting with this camera.

- The camera can only be paired with one remote control at a time. When the camera is paired with a different remote control, only the most recent pairing information is saved.
- Refer to the User’s Manual provided with the ML-L7 Remote Control.



Parts and Functions of the Remote Control (for P1000)

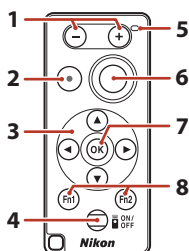

	Parts	Function
1	- button/+ button	Zooms out when the - button is pressed and zooms in when the + button is pressed, while the shooting screen is displayed.
2	Movie recording button	Starts recording a movie when the button is pressed, and stops recording when pressed again.
3	Multi selector	<ul style="list-style-type: none"> • Functions similarly to the multi selector on the camera, enabling you to configure settings on the shooting screen, such as the flash mode (☞55), self-timer (☞58), focus mode (☞62), and exposure compensation (☞69). With some shooting modes and menu settings, it is possible to adjust the effect or move the focus area (☞140). • When using manual focus, the focus can be adjusted with ▲▼ (☞67).
4	Power button	Press the button to turn on the remote control and search for a device that has already been paired. Press and hold the button (for at least 3 seconds) to search for a new pairing device. To turn off the remote control, press the button again.
5	Status lamp	Indicates the remote control status or shooting session status, based on the color and behavior of the lamp. See "Status Lamp on the Remote Control (for P1000)" (☞215) for more information.
6	Shutter-release button	Functions similarly to the shutter-release button on the camera. <ul style="list-style-type: none"> • Half-press and press-and-hold operations are not available. • When using the self-timer, you can press the button during the countdown to cancel shooting.



	Parts	Function
7	 (apply selection) button	Applies the selected item. When adjusting manual focus, press this button to stop focusing.
8	Fn1 (Function 1) / Fn2 (Function 2) buttons	Cannot be used with this camera.

Status Lamp on the Remote Control (for P1000)

Color	Status	Description
Green	Flashing about every second	Remote control is searching for device that has already been paired.
Green	Flashing quickly (about every 0.5 second)	Pairing process is being performed.
Green	Flashing about every 3 seconds	Connection is established between remote control and camera.
Orange	Flashes once	Still image shooting starts.
Orange	Flashes twice	Still image shooting ends (e.g. shooting with the Time setting).
Red	Flashes once	Movie recording starts.
Red	Flashes twice	Movie recording ends.



Pairing the Camera and Remote Control

Before using the remote control for the first time, it must be paired with the camera.

1 Press the **MENU** button on the camera.

2 Press the multi selector ◀, use ▲▼ to select the (T) menu icon, and press the OK button.

3 Select **Choose connection**, and press the OK button.

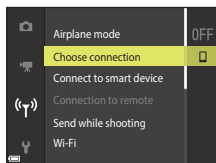

4 Select **Remote control**, and press the OK button.

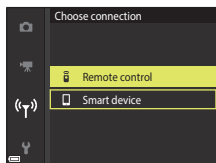

5 Select **Connection to remote**, and press the OK button.

- Pairing is enabled and the camera waits for the connection to be established.

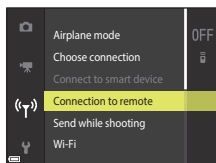

6 Press and hold (for at least three seconds) the power button on the remote control.

- Pairing starts for the camera and remote control. While the process is being performed, the status lamp on the remote control flashes about every 0.5 second.
- When pairing is complete, a connection is established between the camera and the remote control. When you enter shooting mode, the  icon is displayed on the shooting screen.
- If a pairing failure message is displayed, perform the procedure again from step 5.

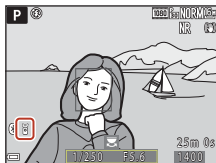

Switching the Connection to a Smart Device

- Switch the connection from **Remote control** to **Smart device** in **Choose connection** in the camera network menu ( 161, 216).
- When the SnapBridge app is launched on your smart device, and a connection is established between the camera and smart device, the  icon is displayed on the shooting screen.
- See the included “SnapBridge Connection Guide” when establishing a wireless connection with a smart device for the first time.



Specifications

Nikon COOLPIX P1000 Digital Camera

Type	Compact digital camera
Number of effective pixels	16.0 million (Image processing may reduce the number of effective pixels.)
Image sensor	6.2 × 4.6 mm (1/2.3-in. type) CMOS; approx. 16.79 million total pixels
Lens	NIKKOR lens with 125× optical zoom
Focal length	4.3–539 mm (angle of view equivalent to that of 24–3000 mm lens in 35mm [135] format)
f/-number	f/2.8–8
Construction	17 elements in 12 groups (5 ED lens elements and 1 super ED lens element)
Digital zoom magnification	Up to 4× (angle of view equivalent to that of approx. 12000 mm lens in 35mm [135] format) Up to 3.6× when recording movies with 2160/30p (4K UHD) or 2160/25p (4K UHD)
Vibration reduction	Lens shift (still images) Combination of lens shift and electronic VR (movies)
Autofocus (AF)	Contrast-detect AF
Focus range	<ul style="list-style-type: none">• [W]: Approx. 30 cm (1 ft)–∞, [T]: Approx. 7.0 m (23 ft)–∞• Macro close-up mode: Approx. 1 cm (0.4 in.)–∞ (wide-angle position), Approx. 7.0 m (23 ft)–∞ (telephoto position) (All distances measured from center of front surface of lens)
Focus-area selection	Target finding AF, face priority, manual (spot), manual (normal), manual (wide), subject tracking
Viewfinder	Electronic viewfinder, 1 cm (0.39-in.), approx. 2359k-dot OLED with the diopter adjustment function (-3 – +3 m ⁻¹)
Frame coverage (shooting mode)	Approx. 99% horizontal and vertical (compared to actual picture)
Frame coverage (playback mode)	Approx. 100% horizontal and vertical (compared to actual picture)



Monitor	8.1 cm (3.2-in.), approx. 921k-dot (RGB), wide viewing angle TFT LCD with anti-reflection coating and 5-level brightness adjustment, vari-angle TFT LCD
Frame coverage (shooting mode)	Approx. 99% horizontal and vertical (compared to actual picture)
Frame coverage (playback mode)	Approx. 100% horizontal and vertical (compared to actual picture)
Storage	
Media	SD/SDHC/SDXC memory card
File system	DCF and Exif 2.31 compliant
File formats	Still images: JPEG, RAW (NRW) (Nikon's own format) Movies: MP4 (Video: H.264/MPEG-4 AVC, Audio: AAC stereo)
Image size	
Still image	16 M 4608×3456 , 8 M 3264×2448 , 4 M 2272×1704 , 2 M 1600×1200 , 16:9 12 M 4608×2592 , 3:2 14 M 4608×3072 , 1:1 12 M 3456×3456
Movie	2160/30p (4K UHD), 2160/25p (4K UHD), 1080/30p, 1080/25p, 1080/60p, 1080/50p, 720/30p, 720/25p, 720/60p, 720/50p, HS 480/4x, HS 720/2x, HS 1080/0.5x
ISO sensitivity (Standard output sensitivity)	<ul style="list-style-type: none"> • ISO 100*–1600 * The lowest ISO sensitivity in Movie manual mode is ISO 125. • ISO 3200, 6400 (available when using P, S, A, M, or Movie manual mode)
Exposure	
Metering mode	Matrix, center-weighted, spot
Exposure control	Programmed auto exposure with flexible program, shutter-priority auto, aperture-priority auto, manual, exposure bracketing, exposure compensation (–2.0 – +2.0 EV in steps of 1/3 EV)
Shutter	Mechanical and CMOS electronic shutter
Speed	<ul style="list-style-type: none"> • 1/4000*–1 s • 1/4000*–30 s (when ISO sensitivity is 100 in M mode) * At wide-angle position, with largest f-number setting (smallest aperture) • Bulb and Time setting (can be set when ISO sensitivity is 100 in M mode): Up to 60 seconds • 1/8000–1/30 s (when recording movies)
Flash sync speed	Synchronizes with all shutter speeds
Aperture	Electronically-controlled 7-blade iris diaphragm
Range	10 steps of 1/3 EV (W) (A , M mode)
Self-timer	Can be selected from 10 s and 3 s



Flash	
Range of built-in flash (approx.) (ISO sensitivity: Auto)	[W]: Approx. 0.3–12 m (12 in.–41 ft) Approx. 5.0–8.0 m (17–26 ft) (focal length equivalent to that of 2000 mm lens in 35mm [135] format) • When focal length is equivalent to that of 3000 mm lens in 35mm [135] format: Approx. 7.0–8.2 m (23–26 ft) (ISO sensitivity: 3200), Approx. 7.0–11 m (23–38 ft) (ISO sensitivity: 6400)
Flash control	TTL auto flash with monitor preflashes
Flash exposure compensation	In steps of 1/3 EV in the range between –2 and +2 EV
Accessory shoe	
ISO 518 hot-shoe with sync and data contacts and safety lock	
Interface	
USB connector	Micro-USB connector (Do not use any USB cable other than the included UC-E21 USB Cable.), Hi-Speed USB • Supports Direct Print (PictBridge)
HDMI output connector	HDMI micro connector (Type D)
Accessory terminal	Compatible with the following accessories (available separately): • MC-DC2 Remote Cord • WR-R10/WR-1 Wireless Remote Controller
External microphone connector	Stereo mini-pin jack (3.5 mm diameter; plug-in power supported)
Wi-Fi (Wireless LAN)	
Standards	IEEE 802.11b/g (standard wireless LAN protocol)
Operating frequency	2412–2462 MHz (1–11 channels)
Maximum output power	9.2 dBm (EIRP)
Authentication	Open system, WPA2-PSK
Bluetooth	
Communication protocols	Bluetooth Specification Version 4.1
Operating frequency	Bluetooth: 2402–2480 MHz Bluetooth Low Energy: 2402–2480 MHz



Power sources	One EN-EL20a Rechargeable Li-ion Battery (included) EH-5b/EH-5c AC Adapter; requires EP-5C Power Connector (available separately)
Charging time	Approx. 3 h (when using EH-73P/EH-73PCH Charging AC Adapter and when no charge remains)
Battery life ¹	
Still images	Approx. 250 shots when using EN-EL20a
Movie recording (actual battery life for recording) ²	Approx. 1 h 20 min when using EN-EL20a
Tripod socket	0.635 cm (1/4 in., ISO 1222)
Dimensions (W × H × D)	Approx. 146.3 × 118.8 × 181.3 mm (5.8 × 4.7 × 7.2 in.) (excluding projections)
Weight	Approx. 1415 g (3 lb 2 oz) (including battery and memory card)
Operating environment	
Temperature	0°C–40°C (32°F–104°F)
Humidity	85% or less (no condensation)

- All measurements are performed in conformity with Camera and Imaging Products Association (CIPA) standards or guidelines.

¹ Battery life does not reflect the use of SnapBridge and may vary with the conditions of use, including temperature, the interval between shots, and the length of time that menus and images are displayed.

² Individual movie files cannot exceed 29 minutes in length, even when there is sufficient free space on the memory card for longer recording. The maximum file size for individual movie files is 4 GB. When recording a movie longer than approximately six minutes at an image size/frame rate of **2160/30p** (4K UHD) or longer than approximately seven minutes at an image size/frame rate of **2160/25p** (4K UHD), multiple files are created when the file size of the recorded movie exceeds 4 GB, and the files cannot be played back continuously. Recording may end before this limit is reached if camera temperature becomes elevated.

EN-EL20a Rechargeable Li-ion Battery

Type	Rechargeable lithium-ion battery
Rated capacity	DC 7.2 V, 1110 mAh
Operating temperature	0°C–40°C (32°F–104°F)
Dimensions (W × H × D)	Approx. 30.7 × 50.0 × 14.0 mm (1.2 × 2.0 × 0.6 in.)
Weight	Approx. 42 g (1.5 oz)



EH-73P/EH-73PCH Charging AC Adapter

Rated input	AC 100–240 V, 50/60 Hz, MAX 0.14 A
Rated output	DC 5.0 V, 1.0 A, 5.0 W
Operating temperature	0°C–40°C (32°F–104°F)
Average active efficiency	73.77%
No-load power consumption	0.075 W
Dimensions (W × H × D)	Approx. 55 × 22 × 54 mm (2.2 × 0.9 × 2.2 in.) (excluding plug adapter) For Argentina: Approx. 55 × 63 × 59 mm (2.2 × 2.5 × 2.4 in.) For India: Approx. 55 × 63.5 × 59 mm For Korea: Approx. 55 × 67 × 59 mm
Weight	Approx. 51 g (1.8 oz) (excluding plug adapter) For Argentina: Approx. 76 g (2.7 oz) For India: Approx. 81 g For Korea: Approx. 73 g

The symbols on this product represent the following:

~ AC, == DC,  Class II equipment (The construction of the product is double-insulated.)

- Nikon will not be held liable for any errors this manual may contain.
- The appearance of this product and its specifications are subject to change without notice.
- The sample images displayed on the camera and the images and illustrations in the manual are for illustrative purposes only.

Notice for customers in Europe Distributor (Importer for EU Countries) Nikon Europe B.V.

The Garden, Stroombaan 14,
1181 VX Amstelveen, The Netherlands
+31-20-7099-000

Commercial registration number: 34036589



Memory Cards That Can Be Used

The camera supports SD, SDHC, and SDXC memory cards.

- The camera supports UHS-I.
- Memory cards with an SD Speed Class rating of 6 or faster are recommended for recording movies (when recording 4K UHD movies at an image size/frame rate of **2160/30p** or **2160/25p**, cards rated UHS Speed Class 3 or faster are recommended). When using a memory card with a lower Speed Class rating, movie recording may stop unexpectedly.
- If you use a card reader, make sure that it is compatible with your memory card.
- Contact the manufacturer for information on features, operation, and limitations on use.

Trademark Information

- Windows is either a registered trademark or trademark of Microsoft Corporation in the United States and/or other countries.
- The *Bluetooth*® word mark and logos are registered trademarks owned by Bluetooth SIG, Inc. and any use of such marks by Nikon Corporation is under license.
- Apple®, App Store®, the Apple logos, Mac, OS X, macOS, iPhone®, iPad®, iPod touch® and iBooks are trademarks or registered trademarks of Apple Inc., in the U.S. and other countries.
- Android, Google Play and the Google Play logo are trademarks of Google LLC. The Android robot is reproduced or modified from work created and shared by Google and used according to terms described in the Creative Commons 3.0 Attribution License.
- iOS is a trademark or registered trademark of Cisco Systems, Inc., in the United States and/or other countries and is used under license.
- Adobe, the Adobe logo, Acrobat, and Reader are either trademarks or registered trademarks of Adobe Systems Incorporated in the United States and/or other countries.
- SDXC, SDHC, and SD Logos are trademarks of SD-3C, LLC.



- PictBridge is a trademark.
- HDMI, HDMI logo and High-Definition Multimedia Interface are trademarks or registered trademarks of HDMI Licensing, LLC.



- Wi-Fi and the Wi-Fi logo are trademarks or registered trademarks of the Wi-Fi Alliance.
- All other trade names mentioned in this manual or the other documentation provided with your Nikon product are the trademarks or registered trademarks of their respective holders.

Use of the Made for Apple badge means that an accessory has been designed to connect specifically to the Apple products identified in the badge, and has been certified by the developer to meet Apple performance standards. Apple is not responsible for the operation of this device or its compliance with safety and regulatory standards. Please note that the use of this accessory with an Apple product may affect wireless performance.

AVC Patent Portfolio License

This product is licensed under the AVC Patent Portfolio License for the personal and non-commercial use of a consumer to (i) encode video in compliance with the AVC standard ("AVC video") and/or (ii) decode AVC video that was encoded by a consumer engaged in a personal and non-commercial activity and/or was obtained from a video provider licensed to provide AVC video. No license is granted or shall be implied for any other use. Additional information may be obtained from MPEG LA, L.L.C. See <http://www.mpegla.com>.

FreeType License (FreeType2)

Portions of this software are copyright © 2012 The FreeType Project (<http://www.freetype.org>). All rights reserved.

MIT License (HarfBuzz)

Portions of this software are copyright © 2016 The HarfBuzz Project (<http://www.freedesktop.org/wiki/Software/HarfBuzz>). All rights reserved.







Index







Symbols

- Auto mode 31, 32
- Creative mode..... 31, 44
- SCENE** Scene mode..... 31, 33
- A** Aperture-priority auto mode
..... 31, 46
- S** Shutter-priority auto mode.... 31, 46
- Moon mode 31, 33, 40
- Bird-watching mode..... 31, 33, 40
- P** Programmed auto mode 31, 46
- Movie manual mode..... 31, 94
- M** Manual mode 31, 46
- U** User settings mode..... 31, 52
- Playback zoom 27, 80
- W** Wide-angle..... 71
- Thumbnail playback..... 27, 81
- T** Telephoto 71
- Snap-back zoom button 3, 5, 72
- Apply selection button 4, 6
- Playback button..... 4, 7, 27
- Delete button..... 4, 7, 28, 83
- (Movie-record) button
..... 4, 6, 25, 90
- DISP** Display button..... 4, 7, 8
- Fn** Function button 2, 7, 70
- Flash pop-up control..... 2, 25, 55
- MENU** Menu button 4, 7, 113
- Monitor button 4, 7, 26
- AE-L/AF-L button..... 5, 66, 175
- Self-timer/Smile timer..... 54, 58, 60
- Focus mode..... 54, 61
- Flash mode 54, 55
- Exposure compensation 54, 69
- A**
- AC adapter..... 103, 209
- Active D-Lighting..... 116, 144
- AE/AF lock button..... 119, 175
- AF area mode..... 70, 116, 140
- AF assist 119, 172
- AF-assist illuminator..... 2
- Airplane mode 118, 161
- Aperture-priority auto mode 31, 46
- Assign side zoom control..... 119, 173
- Auto flash 56
- Auto mode 31, 32
- Auto off..... 24, 119, 176
- Auto with red-eye reduction 56, 57
- Autofocus..... 61, 65
- Autofocus mode..... 116, 117, 143, 153
- B**
- Backlighting 33, 37
- Battery 16, 221
- Battery charger..... 209
- Battery level indicator..... 22
- Beach 33
- Bird-watching mode 31, 33, 40
- Bluetooth..... 118, 162
- Brightness..... 167
- Built-in flash..... 2, 55
- Bulb setting (long time-exposure)... 50
- Button sound 175
- C**
- Calendar display 81
- Charge by computer 119, 179
- Charge lamp..... 2, 17
- Charging AC Adapter..... 17, 222
- Choose connection..... 118, 161
- Choose key picture..... 118, 160
- Clean HDMI output..... 104, 177
- Close-up 33, 36
- Color temperature 130









Command dial	7, 46	EVF options	167
Computer.....	103, 109	Exposure bracketing.....	116, 139
Connect to smart device	118, 161	Exposure compensation.....	54, 69
Connection to remote	118, 161	Exposure mode	117
Connector cover	3, 17, 103	Extension	208
Continuous	40, 70, 116, 133	External mic sensitivity.....	117, 156
Contrast.....	126	Extracting still images.....	101
Control ring.....	7, 174	Eye sensor	4, 26
Control ring options.....	119, 174	Eyelet for camera strap	2, 15
COOLPIX Custom Picture Control	116, 117, 128	E	
COOLPIX Picture Control	70, 116, 117, 124	Face detection	64
Copyright information	119, 181	Face priority	140
Creative mode.....	31, 44	Fast motion movies	151, 152
Crop.....	80, 88	File name	208
Custom Picture Control	116, 117, 128	Fill flash	56
D		Filter effects.....	86, 118, 126
Date and time.....	19, 119, 164	Fireworks show 	33, 37
Date format.....	19, 164	Firmware version	120, 184
Date stamp.....	119, 169	Flash exp. comp.	116, 143
Daylight saving time	19, 165	Flash mode.....	54, 55
Delete	28, 83	Flash-ready indicator	55
Digital zoom	71, 119, 172	Fn button setting	70, 114
Diopter adjustment control.....	3, 26	F-number.....	46
Direct Print.....	103, 105	Focal length	147, 148, 218
D-Lighting.....	84, 118	Focal length selection	40
Dusk/dawn 	33	Focus.....	24, 91, 140, 143, 153
Dynamic Fine Zoom.....	71	Focus area	11, 24, 38, 140
E		Focus indicator	9, 24
Easy panorama 	33, 41	Focus lock	66
Editing movies	100	Focus mode	54, 61
Editing still images	83	Focus-mode selector	5
EH-73P/EH-73PCH	222	Food 	33, 37
Electronic VR.....	117, 154	Format.....	16, 119, 176
EN-EL20a.....	221	Format card.....	16, 119, 176
EVF auto toggle.....	119, 169	Format memory cards.....	16, 119, 176
		Frame rate.....	117, 155
		Full-frame playback.....	12, 27, 80, 81
		Full-time AF	143, 153





- Functions that cannot be used simultaneously..... 75
- H**
- HDMI..... 119, 177
- HDMI micro connector..... 3, 104
- HDR..... 37
- High-speed continuous..... 133
- Histogram..... 13, 69, 167
- HS movie..... 151, 152
- I**
- Identifier..... 208
- Image comment..... 119, 180
- Image quality..... 70, 116, 121
- Image review..... 167
- Image selection screen..... 115
- Image sharpening..... 126
- Image size..... 70, 116, 123
- Infinity..... 62
- Interval timer shooting..... 133, 135
- ISO sensitivity..... 70, 116, 117, 137
- L**
- Landscape ..... 33, 34
- Language..... 119, 176
- Lens..... 2, 195, 218
- Lens cap..... 15
- Lens hood..... 15
- Li-ion rechargeable battery..... 16, 221
- Location data..... 119, 182
- M**
- M exposure preview..... 117, 148
- Macro close-up..... 62
- Manual focus..... 67
- Manual mode..... 31, 46
- Mark for upload..... 118, 157
- Memory capacity..... 22, 90
- Memory card..... 16, 193, 223
- Metering..... 70, 116, 132
- Microphone (stereo)..... 2
- Micro-USB connector.... 3, 17, 105, 109
- Minimum shutter speed..... 137
- Mode dial..... 2, 5, 22, 31
- Monitor..... 4, 8, 18, 195
- Monitor options..... 167
- Monitor settings..... 119, 167
- Moon mode..... 31, 33, 40
- Movie manual mode..... 31, 94
- Movie manual mode menu... 117, 149
- Movie menu..... 117, 150
- Movie options..... 117, 150
- Movie playback..... 27, 90
- Movie recording..... 25, 90
- Movie recording time remaining..... 90, 91
- Multi selector..... 6, 54
- Multiple exp. Lighten ..... 33, 39
- Multiple exposure..... 116, 145
- N**
- Network menu..... 113, 161
- Night landscape ..... 33, 36
- Night portrait ..... 33, 35
- Noise reduction filter..... 116, 144
- Number of exposures remaining..... 22, 122
- NX Studio..... 103, 109
- O**
- Optical zoom..... 71
- Optional accessories..... 209
- P**
- Pairing the remote control..... 216
- Paper size..... 106, 107
- Party/indoor ..... 33, 35
- Peaking..... 120, 184
- Pet portrait ..... 33, 38
- PictBridge..... 103, 105



Picture Control		Scene auto selector 	31, 33, 34
.....	70, 116, 117, 124	Scene mode.....	31, 33
Playback.....	27, 90	Selective color 	33, 38
Playback menu.....	118, 157	Self-timer.....	54, 58
Playback mode.....	27	Self-timer lamp.....	2, 59, 60
Playback zoom.....	27, 80	Self-timer: after release.....	119, 170
Portrait 	33	Send while shooting.....	118, 161
Power.....	19	Sequence.....	28, 82
Power connector.....	209	Sequence display options.....	118, 160
Power connector cover.....	4	Setup menu.....	119, 164
Power switch.....	2, 19	Shooting.....	22, 31, 90
Power-on lamp.....	2, 24	Shooting information.....	8
Preset manual.....	131	Shooting menu.....	116, 121, 124
Pre-shooting cache.....	133, 134	Shooting mode.....	31
Pressing halfway.....	6, 24, 62	Shutter sound.....	175
Print.....	105, 106, 107	Shutter speed.....	46, 49
Printer.....	103, 105	Shutter-priority auto mode.....	31, 46
Programmed auto mode.....	31, 46	Shutter-release button.....	2, 6, 24, 62
Protect.....	118, 159	Side zoom control.....	3, 5, 23
Q		Single.....	133
Quick adjust.....	126	Single AF.....	143, 153
Quick retouch.....	84, 118	Skin softening.....	65, 85, 118
R		Slide show.....	118, 158
Rear-curtain sync.....	56	Slot empty release lock.....	119, 166
Rechargeable battery.....	17	Slow motion movies.....	151, 152
Red-eye reduction.....	56, 57	Slow sync.....	56
Red-eye reduction lamp.....	2, 57	Small picture.....	87, 118
Remote control.....	213	Smile timer.....	54, 60
Reset all.....	120, 184	Snap-back zoom.....	119, 173
Reset file numbering.....	120, 183	Snow 	33
Reset user settings.....	53	Soft SOFT	33
Restore default settings.....	119, 162	Sound settings.....	119, 175
Rotary multi selector.....	6, 54	Speaker.....	4
Rotate image.....	118, 159	Sports 	33, 35
S		Standard flash.....	56
Saturation.....	126	Startup zoom position.....	117, 148
Save user settings.....	53	Subject tracking.....	141, 142
		Sunset 	33



Superlapse movie 	33, 98
Sync with smart device	164
I	
Target finding AF	63, 141
Telephoto	71
Thumbnail playback	27, 81
Time difference	164
Time setting (long time-exposure)	50
Time zone	19, 165
Time zone and date	19, 119, 164
Time-lapse movie 	33, 96
Toggle Av/Tv selection	119, 182
Tone level	13
Tone level information	8, 13
Toning	127
TV	103, 104
U	
USB cable	17, 103, 105, 109
User settings mode	31, 52
V	
Vibration reduction	70, 119, 171
View/hide framing grid	11, 167
Viewfinder	4, 8, 26, 195
Virtual horizon	11, 167, 168
Volume	99
W	
White balance	70, 116, 117, 129
Wide-angle	71
Wi-Fi	118, 162
Wind noise reduction	117, 154
Z	
Zoom	71
Zoom control	2, 5, 71
Zoom memory	117, 147
Zoom microphone	117, 155



No reproduction in any form of this manual, in whole or in part (except for brief quotation in critical articles or reviews), may be made without written authorization from NIKON CORPORATION.

NIKON CORPORATION

© 2018 Nikon Corporation



YP2G08(11)
6MQA5711-08