

**Nikon**

DIGITAL CAMERA

# COOLPIX L110

## User's Manual

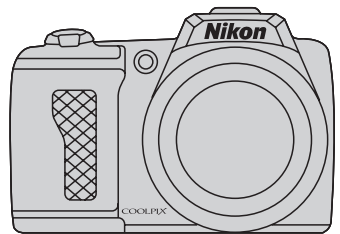

En

### **Trademark Information**

- Microsoft, Windows and Windows Vista are either registered trademarks or trademarks of Microsoft Corporation in the United States and/or other countries.
- Macintosh, Mac OS, and QuickTime are trademarks of Apple Inc.
- Adobe and Acrobat are registered trademarks of Adobe Systems Inc.
- SD and SDHC Logos are trademarks of SD-3C, LLC.
- PictBridge is a trademark.
- HDMI, (**HDMI**) logo and High-Definition Multimedia Interface are trademarks or registered trademarks of HDMI Licensing LLC.
- All other trade names mentioned in this manual or the other documentation provided with your Nikon product are trademarks or registered trademarks of their respective holders.

### **AVC Patent Portfolio License**

This product is licensed under the AVC Patent Portfolio License for the personal and non-commercial use of a consumer to (i) encode video in compliance with the AVC standard ("AVC video") and/or (ii) decode AVC video that was encoded by a consumer engaged in a personal and non-commercial activity and/or was obtained from a video provider licensed to provide AVC video. No license is granted or shall be implied for any other use. Additional information may be obtained from MPEG LA, L.L.C.

See <http://www.mpegla.com>.

**Introduction**

**First Steps**

**Basic Photography and Playback:  Easy Auto Mode**

**More on Shooting**

**More on Playback**

**Editing Image**

**Movie Recording and Playback**

**Connecting to Televisions, Computers and Printers**

**Basic Camera Setup**

**Notes on Camera Care and General Usage**

**Technical Notes**

## For Your Safety

To prevent damage to your Nikon product or injury to yourself or to others, read the following safety precautions in their entirety before using this equipment. Keep these safety instructions where all those who use the product will read them. The consequences that could result from failure to observe the precautions listed in this section are indicated by the following symbol:



This icon marks warnings, information that should be read before using this Nikon product, to prevent possible injury.

### WARNINGS

#### **Turn off in the event of malfunction**

Should you notice smoke or an unusual smell coming from the camera or AC adapter, unplug the AC adapter and remove the battery immediately, taking care to avoid burns. Continued operation could result in injury. After removing or disconnecting the power source, take the equipment to a Nikon-authorized service representative for inspection.

#### **Do not disassemble**

Touching the internal parts of the camera or AC adapter could result in injury. Repairs should be performed only by qualified technicians. Should the camera or AC adapter break open as the result of a fall or other accident, take the product to a Nikon-authorized service representative for inspection, after unplugging the product and/or removing the battery.

#### **Do not use the camera or AC adapter in the presence of flammable gas**

Do not use electronic equipment in the presence of flammable gas, as this could result in explosion or fire.

#### **Handle the camera strap with care**

Never place the strap around the neck of an infant or child.

#### **Keep out of reach of children**

Particular care should be taken to prevent infants from putting the battery or other small parts into their mouths.

### **Observe caution when handling the battery**

The battery may leak or explode if improperly handled. Observe the following precautions when handling the battery for use in this product:

- Before replacing the battery, turn the product off. If you are using the AC adapter, be sure it is unplugged.
- Use only the batteries approved for use in this product (📖 14). Do not combine old and new batteries or batteries of different makes or types.
- When charging Nikon EN-MH2 rechargeable Ni-MH batteries, use only the specified charger and charge the batteries four at a time. When replacing the batteries with EN-MH2-B2 batteries (available separately), purchase two sets (total of four batteries).
- The EN-MH2 rechargeable batteries are for use with Nikon digital cameras only, and are compatible with COOLPIX L110.
- Insert batteries in the correct orientation.
- Do not short or disassemble the battery or attempt to remove or break the battery insulation or casing.
- Do not expose the battery to flame or to excessive heat.
- Do not immerse in or expose to water.
- Do not transport or store with metal objects such as necklaces or hairpins.
- Batteries are prone to leakage when fully discharged. To avoid damage to the product, be sure to remove the battery when no charge remains.

### **Observe the following precautions when handling the Battery Chargers (available separately)**

- Discontinue use immediately should you notice any change in the battery, such as discoloration or deformation.
  - If liquid from the damaged battery comes in contact with clothing or skin, rinse immediately with plenty of water.
- Keep Dry. Failure to observe this precaution could result in fire or electric shock.
  - Dust on or near the metal parts of the plug should be removed with a dry cloth. Continued use could result in fire.
  - Do not handle the power cable or go near the battery charger during lightning storms. Failure to observe this precaution could result in electric shock.
  - Do not damage, modify, forcibly tug or bend the power cable, place it under heavy objects, or expose it to heat or flame. Should the insulation be damaged and the wires become exposed, take it to a Nikon-authorized service representative for inspection. Failure to observe these precautions could result in fire or electric shock.
  - Do not handle the plug or battery charger with wet hands. Failure to observe this precaution could result in electric shock.
  - Do not use with travel converters or adapters designed to convert from one voltage to another or with DC-to-AC inverters. Failure to observe this precaution could damage the product or result in overheating or fire.

 **Use appropriate cables**

When connecting cables to the input and output jacks, use only the cables provided or sold by Nikon for the purpose, to maintain compliance with product regulations.

 **Handle moving parts with care**

Be careful that your fingers or other objects are not pinched by the lens cover or other moving parts.

 **CD-ROMs**

The CD-ROMs supplied with this device should not be played back on audio CD equipment. Playing CD-ROMs on an audio CD player could cause hearing loss or damage the equipment.

 **Observe caution when using the flash**

Using the flash close to your subject's eyes could cause temporary visual impairment. Particular care should be observed if photographing infants, when the flash should be no less than 1 m (3 ft. 4 in.) from the subject.

 **Do not operate the flash with the flash window touching a person or object**

Failure to observe this precaution could result in burns or fire.

 **Avoid contact with liquid crystal**

Should the monitor break, care should be taken to avoid injury caused by broken glass and to prevent liquid crystal from the monitor touching the skin or entering the eyes or mouth.

 **Turn the power off when using inside an airplane or the hospital**

Turn the power off while inside the airplane during take off or landing. Follow the instructions of the hospital when using while in a hospital. The electromagnetic waves given out by this camera may disrupt the electronic systems of the airplane or the instruments of the hospital.

# Notices

## **Notice for Customers in the U.S.A.**

### **Federal Communications Commission (FCC) Radio Frequency Interference Statement**

This equipment has been tested and found to comply with the limits for a Class B digital device, pursuant to Part 15 of the FCC rules. These limits are designed to provide reasonable protection against harmful interference in a residential installation. This equipment generates, uses, and can radiate radio frequency energy and, if not installed and used in accordance with the instructions, may cause harmful interference to radio communications. However, there is no guarantee that interference will not occur in a particular installation. If this equipment does cause harmful interference to radio or television reception, which can be determined by turning the equipment off and on, the user is encouraged to try to correct the interference by one or more of the following measures:

- Reorient or relocate the receiving antenna.
- Increase the separation between the equipment and receiver.
- Connect the equipment into an outlet on a circuit different from that to which the receiver is connected.
- Consult the dealer or an experienced radio/television technician for help.



### **CAUTIONS**

#### **Modifications**

The FCC requires the user to be notified that any changes or modifications made to this device that are not expressly approved by Nikon Corporation may void the user's authority to operate the equipment.

#### **Interface Cables**

Use the interface cables sold or provided by Nikon for your equipment. Using other interface cables may exceed the limits of Class B Part 15 of the FCC rules.

#### **Notice for customers in the State of California**

#### **WARNING**

Handling the cord on this product will expose you to lead, a chemical known to the State of California to cause birth defects or other reproductive harm.

#### ***Wash hands after handling.***

Nikon Inc.,  
1300 Walt Whitman Road  
Melville, New York 11747-3064  
USA  
Tel: 631-547-4200

## **Notice for customers in Canada**

### **CAUTION**

This Class B digital apparatus complies with Canadian ICES-003.

### **ATTENTION**

Cet appareil numérique de la classe B est conforme à la norme NMB-003 du Canada.

### **Symbol for Separate Collection in European Countries**

This symbol indicates that this product is to be collected separately.



The following apply only to users in European countries:

- This product is designated for separate collection at an appropriate collection point. Do not dispose of as household waste.
- For more information, contact the retailer or the local authorities in charge of waste management.



This symbol on the battery indicates that the battery is to be collected separately.



The following apply only to users in European countries:



- All batteries, whether marked with this symbol or not, are designated for separate collection at an appropriate collection point. Do not dispose of as household waste.
- For more information, contact the retailer or the local authorities in charge of waste management.

# Table of Contents





For Your Safety .....	ii
WARNINGS .....	ii
Notices .....	v
<hr/>	
Introduction .....	1
About This Manual .....	1
Information and Precautions .....	2
Parts of the Camera .....	4
The Camera Body .....	4
Raising and Lowering the Built-in Flash .....	6
Attaching the Camera Strap and Lens Cap .....	7
The Monitor .....	8
Basic Operations .....	10
 (shooting mode) button .....	10
 (playback) button .....	10
 (movie-record) button .....	10
The Multi Selector .....	11
<b>MENU</b> button .....	12
Switching Between Tabs .....	12
Help Displays .....	13
About the Shutter-release Button .....	13
<hr/>	
First Steps .....	14
Inserting the Batteries .....	14
Applicable Batteries .....	14
Turning On and Off the Camera .....	14
Setting Display Language, Date and Time .....	16
Inserting Memory Cards .....	18
Removing Memory Cards .....	19

## Table of Contents



---

Basic Photography and Playback:  Easy Auto Mode .....	20
Step 1 Turn the Camera On and Select  (Easy Auto) Mode .....	20
Indicators Displayed in  (Easy auto) Mode.....	21
Step 2 Frame a Picture .....	22
Using the Zoom.....	23
Step 3 Focus and Shoot .....	24
Step 4 Viewing and Deleting Images.....	26
Viewing Images (Playback Mode) .....	26
Deleting Images .....	26
Easy Auto Mode.....	28
Using the Flash.....	29
Taking Pictures with the Self-timer .....	32
Adjusting the Brightness: Exposure Compensation .....	33



---

More on Shooting .....	34
Selecting Shooting Mode .....	34
Shooting Suited for the Scene (Scene Mode).....	35
Selecting a Scene Mode.....	35
Features .....	36
Taking Pictures for a Panorama .....	42
Capturing Smiling Faces Automatically (Smart Portrait Mode) .....	44
Shooting Continuously at High Speed (Sport Continuous) .....	46
Sport Continuous Menu .....	47
Auto Mode.....	48
Macro Mode.....	49
Shooting Menu (Auto Mode).....	50
Displaying the Shooting Menu .....	50
 Image Mode (Image Quality/Image Size) .....	51
 White Balance (Adjusting hue) .....	53
 Continuous .....	55
 ISO Sensitivity .....	56
 Color Options.....	57
Camera Settings that Cannot Be Set at the Same Time .....	58



---

More on Playback.....	59
Full-frame Operation .....	59
Viewing Multiple Images: Thumbnail Playback.....	60
Calendar Display.....	61
Taking a Closer Look: Playback Zoom .....	62
Playback Menu.....	63
 Print Set .....	64
 Slide Show .....	66
 Delete .....	67

---





















Editing Image.....	69
Image Editing Function .....	69
Editing Images .....	70
 D-Lighting: Enhancing Brightness and Contrast .....	70
 Small Picture: Resizing Images.....	71
 Crop: Creating a Cropped Copy .....	72

---

Movie Recording and Playback.....	73
Recording Movies .....	73
Movie Menu .....	75
 Movie Options.....	77
 Autofocus Mode .....	78
 Wind Noise Reduction .....	78
Movie Playback.....	79
Deleting Movies.....	79

---

Connecting to Televisions, Computers and Printers .....	80
Connecting to a TV .....	80
Connecting to a Computer.....	82
Before Connecting the Camera.....	82
Transferring Pictures from a Camera to a Computer .....	83
Connecting to a Printer.....	87
Connecting the Camera and Printer.....	88
Printing Images One at a Time .....	89
Printing Multiple Images.....	90

<b>Basic Camera Setup</b> .....	<b>93</b>
<b>Setup Menu</b> .....	<b>93</b>
 Menu .....	96
 Welcome Screen .....	97
 Date .....	98
 Monitor Settings .....	101
 Date Imprint .....	103
 Vibration Reduction .....	104
 Motion Detection .....	105
 AF Assist .....	106
 Sound Settings .....	107
 Auto Off .....	108
 Format Memory/  Format Card .....	109
 Language .....	110
 TV Settings .....	110
 Blink Warning .....	111
 Reset All .....	112
 Battery Type .....	114
 Protect .....	114
 Rotate Image .....	115
 Copy: Copying Between Memory Card and Internal Memory .....	116
 Firmware Version .....	117
<b>Notes on Camera Care and General Usage</b> .....	<b>118</b>
<b>Caring for the Camera</b> .....	<b>118</b>
Cleaning .....	120
Storage .....	121
<b>Technical Notes</b> .....	<b>122</b>
<b>Optional Accessories</b> .....	<b>122</b>
Approved Memory Cards .....	122
<b>Image File and Folder Names</b> .....	<b>123</b>
<b>Error Messages</b> .....	<b>124</b>
<b>Troubleshooting</b> .....	<b>128</b>
<b>Specifications</b> .....	<b>133</b>
Supported Standards .....	136
<b>Index</b> .....	<b>137</b>

## About This Manual

Thank you for purchasing a Nikon COOLPIX L110 digital camera. This manual was written to help you enjoy taking pictures with your Nikon digital camera. Read this manual thoroughly before use, and keep it where all those who use the product will read it.

### Symbols and Conventions

To make it easier to find the information you need, the following symbols and conventions are used:



This icon marks cautions, information that should be read before use, to prevent damage to the camera.



This icon marks tips, additional information that may be helpful when using the camera.



This icon marks notes, information that should be read before using the camera.



This icon indicates that more information is available elsewhere in this manual or in the *Quick Start Guide*.

### Notations

- A Secure Digital (SD) memory card is referred to as a “memory card”.
- The setting at the time of purchase is referred to as the “default setting”.
- The names of menu items displayed in the camera monitor, and the names of buttons or messages displayed in the computer monitor appear in bold.

### Screen Samples

In this manual, images are sometimes omitted from monitor display samples so that monitor indicators can be more clearly shown.

### Illustrations and Screen Display

Illustrations and text displays shown in this manual may differ from actual display.

### Memory Cards

Images taken with this camera can be saved in the camera’s internal memory or on removable memory cards. If a memory card is inserted, all new images will be saved on the memory card and delete, playback and format operations will apply only to the images on the memory card. The memory card must be removed before the internal memory can be formatted or used to save, delete or view images.

# Information and Precautions

## Life-Long Learning

As part of Nikon's "Life-Long Learning" commitment to ongoing product support and education, continually updated information is available online at the following sites:

- For users in the U.S.A.: <http://www.nikonusa.com/>
- For users in Europe and Africa: <http://www.europe-nikon.com/support/>
- For users in Asia, Oceania, and the Middle East: <http://www.nikon-asia.com/>

Visit these sites to keep up-to-date with the latest product information, tips, answers to frequently asked questions (FAQs), and general advice on digital imaging and photography. Additional information may be available from the Nikon representative in your area. See the URL below for contact information:

<http://imaging.nikon.com/>

## Use Only Nikon Brand Electronic Accessories

Nikon COOLPIX cameras are designed to the highest standards and include complex electronic circuitry. Only Nikon brand electronic accessories (including battery chargers, batteries and AC adapters) certified by Nikon specifically for use with this Nikon digital camera are engineered and proven to operate within the operational and safety requirements of this electronic circuitry.

THE USE OF NON-NIKON ELECTRONIC ACCESSORIES COULD DAMAGE THE CAMERA AND MAY VOID YOUR NIKON WARRANTY.

For more information about Nikon brand accessories, contact a local authorized Nikon dealer.

## Before Taking Important Pictures

Before taking pictures on important occasions (such as at weddings or before taking the camera on a trip), take a test shot to ensure that the camera is functioning correctly. Nikon will not be held liable for damages or lost profits that may result from product malfunction.

## About the Manuals

- No part of the manuals included with this product may be reproduced, transmitted, transcribed, stored in a retrieval system, or translated into any language in any form, by any means, without Nikon's prior written permission.
- Nikon reserves the right to change the specifications of the hardware and software described in these manuals at any time and without prior notice.
- Nikon will not be held liable for any damages resulting from the use of this product.
- While every effort was made to ensure that the information in these manuals is accurate and complete, we would appreciate it were you to bring any errors or omissions to the attention of the Nikon representative in your area (address provided separately).

## Notice Concerning Prohibition of Copying or Reproduction

Note that simply being in possession of material that was digitally copied or reproduced by means of a scanner, digital camera or other device may be punishable by law.

- **Items prohibited by law from being copied or reproduced**

Do not copy or reproduce paper money, coins, securities, government bonds or local government bonds, even if such copies or reproductions are stamped "Sample". The copying or reproduction of paper money, coins, or securities that are circulated in a foreign country is prohibited. Unless the prior permission of the government was obtained, the copying or reproduction of unused postage stamps or post cards issued by the government is prohibited. The copying or reproduction of stamps issued by the government and of certified documents stipulated by law is prohibited.

- **Cautions on certain copies and reproductions**

The government has issued cautions on copies or reproductions of securities issued by private companies (shares, bills, checks, gift certificates, etc.), commuter passes or coupon tickets, except when a minimum of necessary copies are to be provided for business use by a company. Also, do not copy or reproduce passports issued by the government, licenses issued by public agencies and private groups, ID cards and tickets, such as passes and meal coupons.

- **Comply with copyright notices**

The copying or reproduction of copyrighted creative works such as books, music, paintings, woodcut prints, maps, drawings, movies and photographs is governed by national and international copyright laws. Do not use this product for the purpose of making illegal copies or to infringe copyright laws.

## Disposing of Data Storage Devices



Please note that deleting images or formatting data storage devices such as memory cards or built-in camera memory does not completely erase the original image data. Deleted files can sometimes be recovered from discarded storage devices using commercially available software, potentially resulting in the malicious use of personal image data. Ensuring the privacy of such data is the user's responsibility.

Before discarding a data storage device or transferring ownership to another person, erase all data using commercial deletion software, or format the device and then completely refill it with images containing no private information (for example, pictures of empty sky). Be sure to also replace any pictures selected for the welcome screen (📖 97). Care should be taken to avoid injury or damage to property when physically destroying data storage devices.

# Parts of the Camera

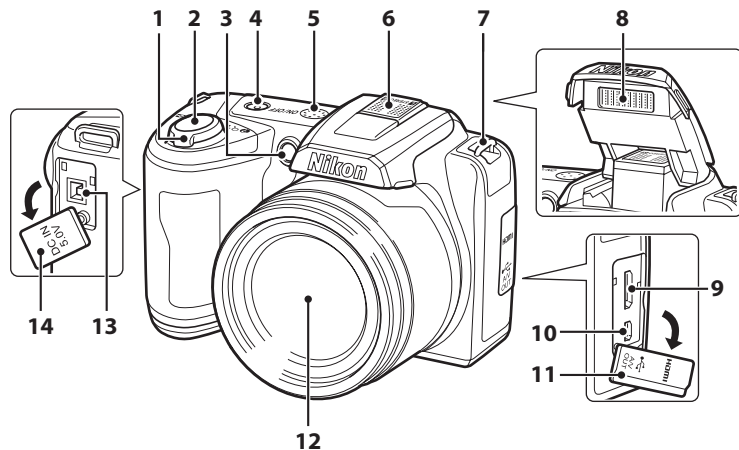
## The Camera Body



<b>1</b>	Zoom control .....	23
	<b>W</b> : wide .....	23
	<b>T</b> : tele .....	23
	 : thumbnail playback .....	60
	 : playback zoom .....	62
	 : help .....	13
<b>2</b>	Shutter-release button .....	24
<b>3</b>	Self-timer lamp .....	32
	AF-assist illuminator .....	25, 106
<b>4</b>	Power switch/Power-on lamp .....	20, 108
<b>5</b>	Speaker .....	79

<b>6</b>	Built-in microphone (stereo) .....	73
<b>7</b>	Eyelet for camera strap .....	7
<b>8</b>	Built-in flash .....	6, 29
<b>9</b>	HDMI mini connector .....	80
<b>10</b>	USB connector and audio/video .....	80, 83, 88
	output .....	80, 83, 88
<b>11</b>	Pin cover .....	80, 83, 88
<b>12</b>	Lens .....	120, 133
<b>13</b>	DC input connector (for AC adapter .....	15, 122
<b>14</b>	available separately from Nikon) .....	15, 122
	DC input connector cover .....	15

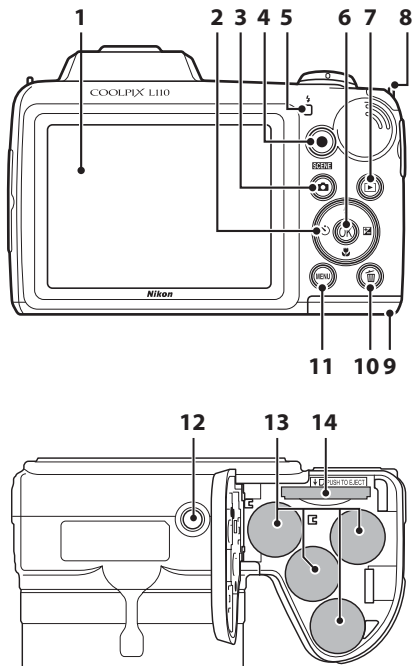

<b>1</b>	Monitor .....	8	<b>9</b>	Battery-chamber/ memory card slot cover .....	14, 18
<b>2</b>	Multi selector .....	11	<b>10</b>	🗑️ (delete) button .....	26, 79
<b>3</b>	📷 (shooting mode) button .....	10	<b>11</b>	<b>MENU</b> button .....	12, 50, 63, 75, 94
<b>4</b>	● (movie-record) button .....	10	<b>12</b>	Tripod socket	
<b>5</b>	Flash lamp .....	29	<b>13</b>	Battery-chamber .....	14
<b>6</b>	OK (apply selection) button .....	11	<b>14</b>	Memory card slot .....	18
<b>7</b>	▶ (playback) button .....	10, 26			
<b>8</b>	Eyelet for camera strap .....	7			

## Raising and Lowering the Built-in Flash

### Raising the built-in flash

See “Using the Flash” (📖 29) for more information about flash settings.

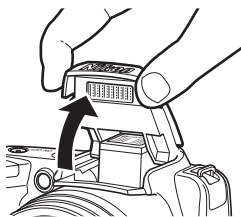

### Lowering the Built-in Flash.

Push the built-in flash down gently to lower the built-in flash when not in use.



## Attaching the Camera Strap and Lens Cap

Attach the lens cap to the camera strap, and then attach the strap to the camera (at two places).

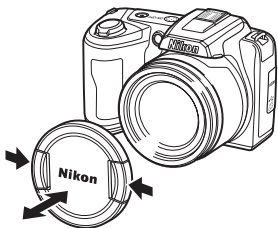
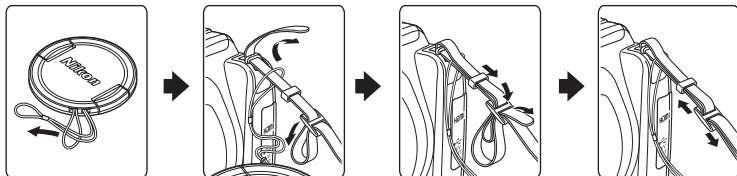
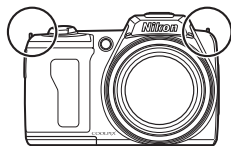

### ✓ Lens Cap

- Remove the lens cap before you shoot a picture.
- At times when you will not be shooting pictures such as when the power is off or while you are carrying the camera, attach the lens cap to the camera to protect the lens.

## The Monitor

The following indicators may be displayed in the monitor during shooting and playback (actual display varies with current camera settings).

The indicators and photo info displayed during shooting and playback will turn off after a few seconds (📖 101).

### Shooting

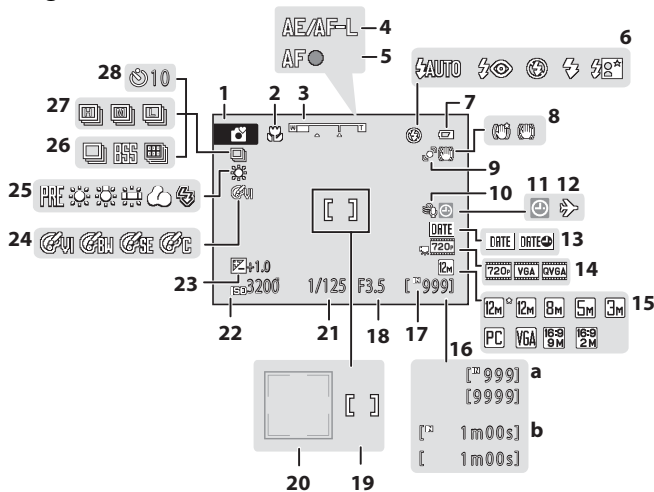

<b>1</b> Shooting mode* .....	20, 34, 44, 46, 48, 73	<b>16</b> a Number of exposures remaining (still images) .....	20
<b>2</b> Macro mode .....	49	<b>16</b> b Movie length .....	73
<b>3</b> Zoom indicator .....	23, 49	<b>17</b> Internal memory indicator .....	21
<b>4</b> AE/AF-L indicator .....	43	<b>18</b> Aperture .....	24
<b>5</b> Focus indicator .....	24	<b>19</b> Focus area .....	22, 24
<b>6</b> Flash mode .....	29	<b>20</b> Focus area (Face Detection) .....	22, 24
<b>7</b> Battery level indicator .....	20	<b>21</b> Shutter speed .....	24
<b>8</b> Vibration reduction icon (still images) ...	21, 104	<b>22</b> ISO sensitivity .....	30, 56
<b>9</b> Motion detection icon .....	21, 105	<b>23</b> Exposure compensation value .....	33
<b>10</b> Wind noise reduction .....	78	<b>24</b> Color options .....	57
<b>11</b> "Date not set" indicator .....	124	<b>25</b> White balance mode .....	53
<b>12</b> Travel destination indicator .....	98	<b>26</b> Continuous shooting mode .....	55
<b>13</b> Date imprint .....	103	<b>27</b> Type of sport continuous mode .....	47
<b>14</b> Movie options .....	77	<b>28</b> Self-timer indicator .....	32
<b>15</b> Image mode .....	51		

\* Differs according to the current shooting mode. Refer to the sections on each mode for details.

## Playback

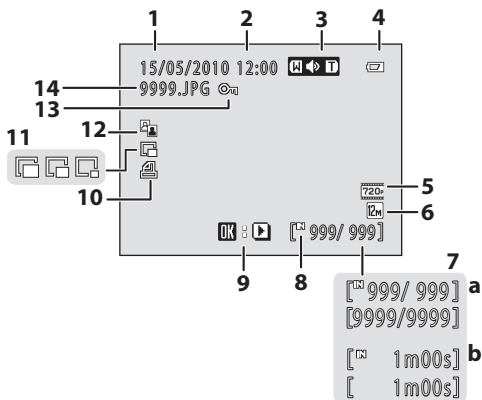





<b>1</b>	Date of recording .....	16	<b>8</b>	Internal memory indicator .....	26
<b>2</b>	Time of recording .....	16	<b>9</b>	Movie playback indicator .....	79
<b>3</b>	Volume .....	79	<b>10</b>	Print-order icon .....	64
<b>4</b>	Battery level indicator .....	20	<b>11</b>	Small picture .....	71
<b>5</b>	Movie options* .....	77	<b>12</b>	D-Lighting icon .....	70
<b>6</b>	Image mode* .....	51	<b>13</b>	Protect icon .....	114
<b>7</b>	<b>a</b> Current frame number/ total number of frames .....	26	<b>14</b>	File number and type .....	123
	<b>b</b> Movie length .....	79			

\* The displayed icons vary with the settings in shooting mode.

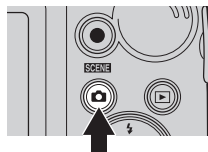
## Basic Operations



### (shooting mode) button



- Press  in playback mode to enter shooting mode.
- Press  in shooting mode to display the shooting-mode selection menu and change the shooting mode ( 34).

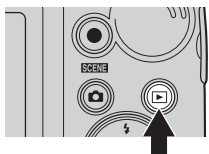

### (playback) button

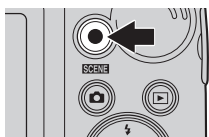

- During shooting mode, the camera enters the playback mode when  is pressed.
- If the camera is turned off, hold down  to turn the camera on in playback mode.

### (movie-record) button





- Press the  (movie-record) button in shooting mode to start recording a movie. Press the  (movie-record) button again to stop recording.
- Press the  (movie-record) button in playback mode to enter shooting mode.

## The Multi Selector

This section describes standard uses of the multi selector to select modes, select menu options and to apply selection. Operate the multi selector by pressing it up, down, left, right, or by pressing **OK**.

### For Shooting

Display  (flash mode) menu (📖 29)/select the item above.

Display  (self-timer) menu (📖 32).

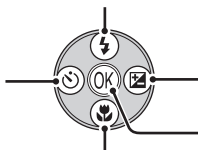

Display  (exposure compensation) menu (📖 33).

Apply selection.

Display  (macro mode) menu (📖 49)/select the item below.

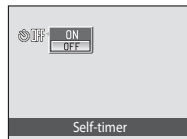

### For Playback

Display the previous image.

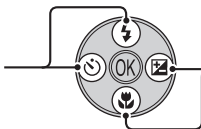

Display the next image.



### For the Menu Screen

Select the item above.

Select the item to the left/return to the previous screen.

Select the item below.

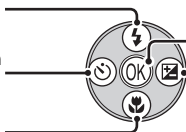





Apply selection (Go to the next screen).

Select the item to the right/go to the next screen (apply selection).



### Notes on the Multi Selector

In this manual, , ,  and  are used in some cases for indicating the up, down, left and right operating parts of the multi selector.

## MENU button

Press **MENU** to display the menu for the selected mode.

- Use the multi selector to apply settings (📖 11).
- Select a tab on the left side of the monitor to display the corresponding menu.
- To exit the menu display, press **MENU** again.

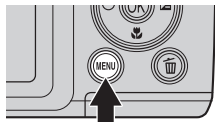

Menus available for the current mode are displayed. Display the movie menu (during shooting). Display the setup menu.

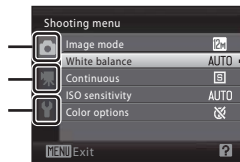

Displayed when the menu contains two or more pages.

Displayed when there are more previous menu items.

Displayed when there are one or more menu items to follow.

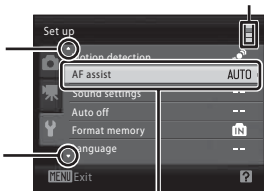

Select an item and press **OK** or the multi selector **▶** to proceed to the next set of options.

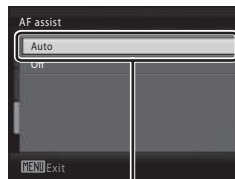

Press **OK** or the multi selector **▶** to apply selection.

## Switching Between Tabs

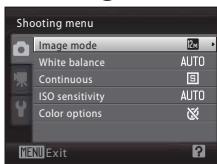

Press the multi selector **◀** to highlight the tab.



Press the multi selector **▲▼** to select a tab and press **OK** or **▶**.

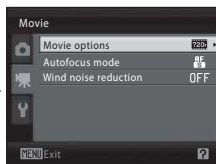

The selected menu will be displayed.

To display the tabs, press the multi selector **◀** while the menu is displayed in the following modes.

- Easy auto mode, scene mode and smart portrait mode

## Help Displays

Rotate the zoom control to **T** (?) when **?** (?) is displayed at the lower right of the menu screen to view a description of the currently selected menu option.

To return to the original menu, rotate the zoom control to **T** (?) again.

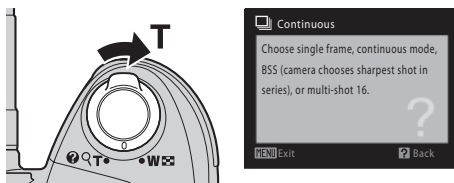

## About the Shutter-release Button

The camera features a two-stage shutter-release button. To set focus and exposure, press the shutter-release button halfway, stopping when you feel resistance. Focus and exposure lock while the shutter-release button is held in this position. To release the shutter and take a picture, press the shutter-release button the rest of the way down. Do not use force when pressing the shutter-release button, as this may result in camera shake and blurred images.

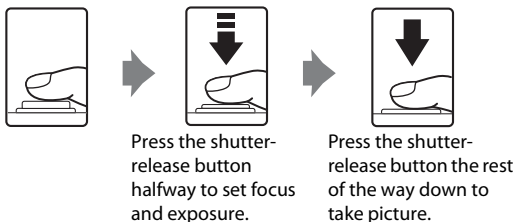

## Inserting the Batteries

### 1 Open the battery-chamber/memory card slot cover.

- Before opening the battery-chamber/memory card slot cover, hold the camera upside down to prevent the batteries from falling out.

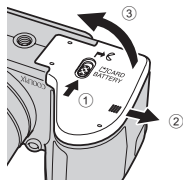

### 2 Insert the Batteries

- Confirm that the positive (+) and negative (-) terminals are oriented correctly as described on the label at the entrance of the battery chamber, and insert the batteries.

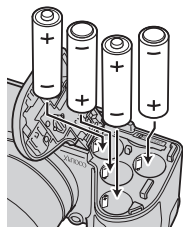

### 3 Close the battery-chamber/memory card slot cover.

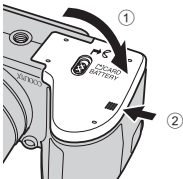



## Applicable Batteries

- Four FR6/L91 (AA-size) lithium batteries (batteries supplied)
- Four LR6/L40 (AA-size) alkaline batteries
- Four EN-MH2 rechargeable Ni-MH (nickel metal hydride) batteries

## Turning On and Off the Camera

After removing the lens cap, press the power switch to turn on the camera. The power-on lamp (green) lights for a moment, then the monitor turns on. Press the power switch again to turn the camera off. When the camera turns off, both the power-on lamp and monitor turn off.

If the camera is turned off, hold down  to turn the camera on in playback mode ( 26).

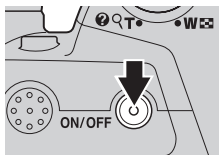

## ✓ Removing the Batteries

Before opening the battery-chamber/memory card slot cover, turn the camera off and confirm that the power-on lamp and the monitor are off.

## ✓ Additional Precautions Regarding Batteries

- Read and follow the warnings and cautions (📖 iii, 119).
- Be sure to read and follow the warnings for the battery on page iii and the section, “The Battery” (📖 119), before using the battery.
- Do not combine old and new batteries or batteries of different makes or types.
- Batteries with the following defects cannot be used:

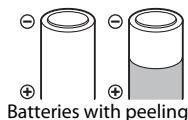

Batteries with peeling



Batteries with insulation that does not cover the area around the negative terminal.

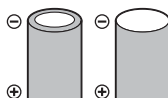

Batteries with a flat negative terminal

## ✓ Notes on the EN-MH2 rechargeable Ni-MH batteries

When using EN-MH2 batteries with the COOLPIX L110, charge the batteries four at a time using Battery Charger MH-73 (📖 114, 122).

## ✓ Battery Type

To improve battery performance, set the Battery type setting (📖 114) in the setup menu (📖 93) to match the type of batteries inserted into the camera.

The default setting is the type of battery supplied with purchase. When any other type of battery is used, turn the camera on and change the setting.

## 🔪 Alkaline Batteries



Performance of alkaline batteries may vary greatly depending on the manufacturer. Choose a reliable brand.

## 🔪 Alternative Power Sources

To power the camera continuously for extended periods, use an AC Adapter EH-67 (available separately) (📖 122). Do not, under any circumstances, use another make or model of AC adapter. Failure to observe this precaution could result in overheating or in damage to the camera.

## 🔪 Auto Off (Standby Mode)

If no operations are performed for a specified amount of time, the monitor turns off, the power-on lamp flashes, and the camera enters standby mode. After an additional three minutes, the auto power off feature turns the camera off.

- During shooting or playback, the camera enters standby mode if no operations are performed for 30 seconds (default setting).
- During standby mode, the monitor is off and the power-on lamp flashes; you can turn the monitor on by pressing any of the following buttons: power switch, shutter-release button,  button,  button, or the  (movie-record) button
- The amount of time that passes before the camera enters standby mode is determined by the Auto off setting (📖 108) in the setup menu (📖 93).

## 🔪 Lens Error

If **Lens Error** is displayed, make sure that the lens cap has been removed, then turn the camera on again.

# Setting Display Language, Date and Time

A language-selection and date setting screen for the internal clock is displayed the first time the camera is turned on.

- 1 Press the power switch to turn on the camera.**

The power-on lamp (green) lights for a moment and the monitor turns on.

Remove the lens cap.

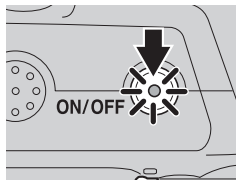

- 2 Use the multi selector to choose the desired language and press **OK**.**

For information on using the multi selector, see "The Multi Selector" (📖 11).



- 3 Choose **Yes** and press **OK**.**

If **No** is selected, the date and time are not set.

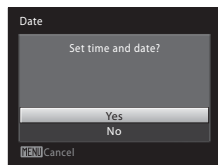

- 4 Press **◀** or **▶** to select your home time zone (city name) (📖 100) and press **OK**.**

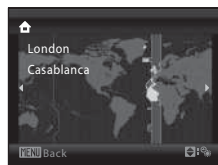

## Daylight Saving Time

To use the camera in an area where daylight saving time is in effect, press **▲** on the home time zone in Step 4 to set the daylight saving time to on.

When the daylight saving time setting is selected, the  mark appears at the top of the monitor. To release the daylight saving time setting, press **▼**.

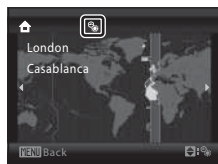

**5** Change the date and time.

- Press ▲ or ▼ to edit the highlighted item.
- Press ► to move the cursor in the following order.  
D -> M -> Y -> Hour -> Minute -> **DMY**
- Press ◀ to return to the previous item.

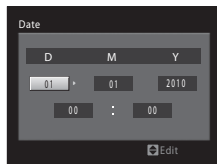
**6** Choose the order in which the day, month and year are displayed and press **OK** or ►.

- The settings are applied.

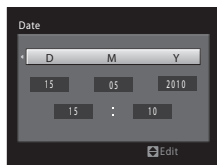
**7** Make sure that the lens cap has been removed, then press **Q**.

- The shooting-mode selection menu is displayed.

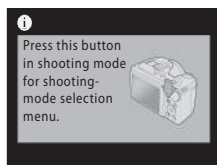
**8** When **Easy auto mode** is displayed, press **OK**.

- The camera enters shooting mode and you can take pictures in Easy auto mode (📖 20).
- Press the multi selector ▲ or ▼ before **OK**, to switch to another shooting mode (📖 34).

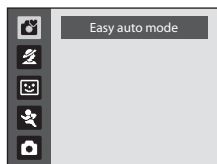
**📌** Changing the Date and Time, Date Imprint

- To change the date and time, select **Date** from **Date** (📖 98) in the setup menu (📖 93) and follow the instructions starting from the above step 5.
- To change the time zone and the daylight saving settings, select **Time zone** from **Date** in the setup menu (📖 98, 99).
- To imprint the shooting date into images when taking pictures, make sure the date and time are set, then set **Date imprint** (📖 103) in the setup menu.

# Inserting Memory Cards

Images are saved in the camera's internal memory (approximately 43 MB) or on removable Secure Digital (SD) memory cards (available separately) (122).

*If a memory card is inserted into the camera, images are automatically saved on the memory card and images saved to the memory card can be played back, deleted or transferred. Remove the memory card to save images in the internal memory, or play back, delete or transfer images from the internal memory.*

- 1 Confirm the power-on lamp and the monitor are off and open the battery-chamber/memory card slot cover.

Be sure to turn off the camera before opening the battery-chamber/memory card slot cover.

Before opening the battery-chamber/memory card slot cover, hold the camera upside down to prevent the batteries from falling out.

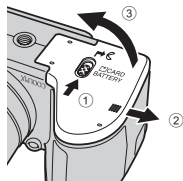

- 2 Insert the memory card.

Slide the memory card in correctly until it clicks into place.

Close the battery-chamber/memory card slot cover.

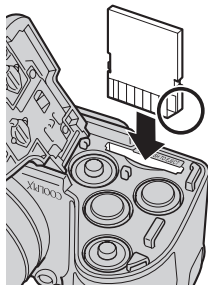

## Inserting Memory Cards

**Inserting the memory card upside down or backwards could damage the camera or the memory card.** Make sure that the memory card is correctly oriented.

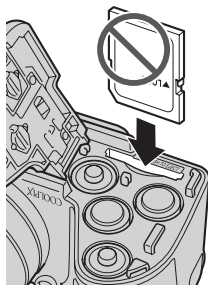

## Removing Memory Cards

Before opening the battery-chamber/memory card slot cover, **turn the camera off** and confirm that the power-on lamp and the monitor are off. Open the battery-chamber/memory card slot cover and press the card in (1) to partially eject the card. Remove the card (2), being careful not to bend it.

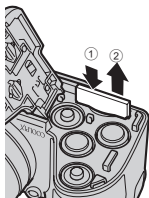

## Formatting Memory Cards

If the message at right is displayed, the memory card must be formatted before use (109). **Note that formatting permanently deletes all images and other data on the memory card.** Be sure to make copies of any images you wish to keep before formatting the memory card.

To format the memory card, use the multi selector to select **Yes** and press **OK**. To start formatting, choose **Format** and press **OK**.

- Do not turn the camera off or open the battery-chamber/memory card slot cover until formatting is complete.
- **The first time you insert the memory cards used in other devices into the camera, be sure to format them using this camera (109).**

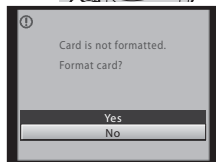

## The Write Protect Switch

SD memory cards are equipped with a write protect switch. Images cannot be saved or deleted and the memory card cannot be formatted when this switch is in the "lock" position. Unlock by sliding the switch to the "write" position.

## Memory Cards

- Use only Secure Digital memory cards.
- Do not perform the following during formatting, while data is being written to or deleted from the memory card, or during data transfer to a computer. Failure to observe this precaution could result in the loss of data or in damage to the camera or memory card:
  - Insert or remove the card
  - Remove the batteries
  - Turn off the camera
  - Disconnect the AC adapter
- Do not format the memory card using a computer.
- Do not disassemble or modify.
- Do not drop, bend, or expose to water or strong physical shocks.
- Do not touch the metal terminals with your fingers or metal objects.
- Do not affix labels or stickers to the memory card.
- Do not leave in direct sunlight, closed vehicles or areas exposed to high temperatures.
- Do not expose to humidity, dust, or to corrosive gases.

Write protect switch

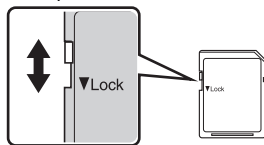

## Step 1 Turn the Camera On and Select (Easy Auto) Mode

In (easy auto) mode, the camera automatically determines an appropriate shooting mode when you frame a picture, allowing you to easily take pictures using a shooting mode that suits the scene ( 28).

### 1 Remove the lens cap and press the power switch to turn on the camera.

- The power-on lamp (green) lights for a moment and the monitor turns on. The lens extends at this time.
- Raise the built-in flash ( 6).

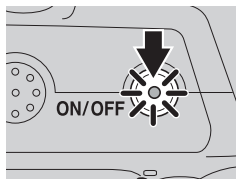

### 2 Press to display the shooting-mode selection menu.

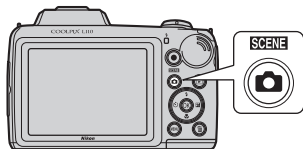

### 3 Press the multi selector to choose and press .

- The camera enters (easy auto) mode.

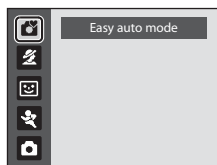

### 4 Check the battery level and number of exposures remaining.

#### Battery level indicator

Monitor	Description
NO INDICATOR	The battery level is high.
	Batteries low. Prepare to replace batteries.
Battery exhausted.	Cannot take pictures. Replace with new batteries.

#### Battery level indicator

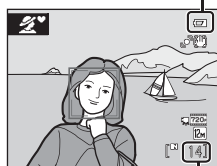





#### Number of exposures remaining

#### Number of Exposures Remaining

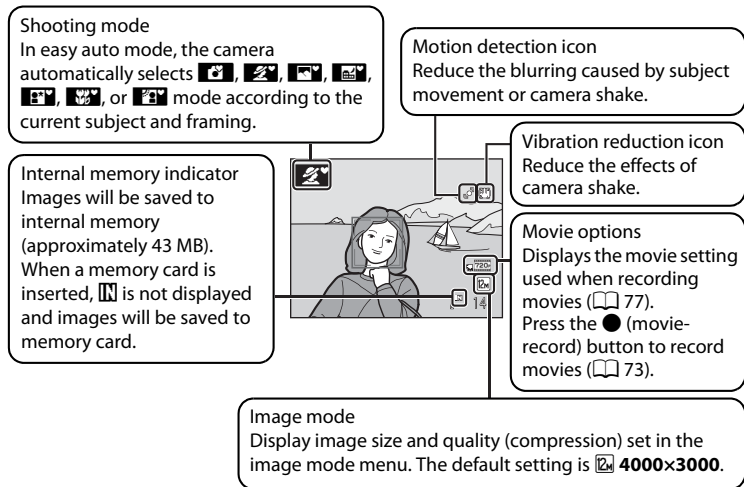



The number of images that can be saved depends on the capacity of the internal memory or memory card and image mode setting ( 52).

## Indicators Displayed in (Easy auto) Mode





The indicators and photo info displayed during shooting and playback will turn off after a few seconds ( 101). While the monitor is off during standby mode, you can turn the monitor on by pressing any of the following buttons ( 108): power switch, shutter-release button,  button, or  (movie-record) button



### Functions Available in Easy Auto Mode

- When the camera is pointed at a person's face, the camera automatically detects the face and focuses on it ( 24, 28).
- The self-timer ( 32) and exposure compensation ( 33) are available.
- The macro mode button ( 11, 49) on the multi selector is not available. Changes to macro mode when the camera selects close-up scene mode.
- Image mode ( 51) can be changed by pressing **MENU**.

### Note on the Flash

When the built-in flash is lowered, the flash setting is fixed at off and  is displayed at the top of the monitor. In situations where flash is needed, such as in dark locations or when the subject is backlit, be sure to raise the built-in flash by hand ( 6, 29).

### Notes on Vibration Reduction and Motion Detection

- See **Vibration reduction** ( 104) or **Motion detection** ( 105) in the setup menu ( 93) for more information.
- Set **Vibration reduction** to **Off** when using a tripod.

## Step 2 Frame a Picture

### 1 Ready the camera.

- Hold the camera steadily in both hands, keeping your fingers and other objects away from the lens, flash, AF-assist illuminator and microphone.

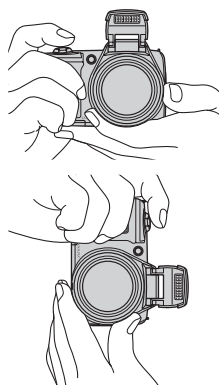

### 2 Frame the picture.

- When the camera determines a scene mode, the shooting mode icon changes (📖 28).
- When the camera detects a human face, that face is framed by a yellow double border. Up to 12 faces can be detected. When the camera detects more than one face, the face closest to the camera is framed by a double border and the others by single borders.
- When shooting non-human subjects or when no faces are detected, the camera will focus on the center of the monitor. Position the main subject near the center of the focus area.

Shooting mode icon

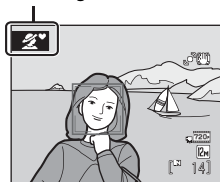

### ✓ Easy auto mode

- The desired scene mode may not be selected in certain conditions. In this case, select another shooting mode.
- When digital zoom is in effect, the shooting mode is 📷.

## Using the Zoom

Use the zoom control to activate optical zoom.

Rotate the zoom control toward **T** to zoom in, increasing the size of the subject.

Rotate the zoom control toward **W** to zoom out, increasing the area visible in the frame.

A zoom indicator is displayed at the top of the monitor when the zoom control is rotated.

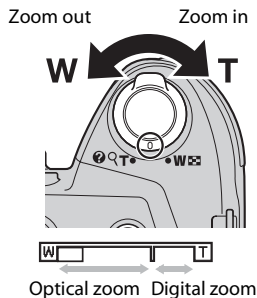

## Digital Zoom

When the camera is zoomed in to the maximum optical zoom magnification, rotating and holding the zoom control at **T** triggers digital zoom. Digital zoom can magnify the subject up to about 4x beyond the magnification of the optical zoom.

When digital zoom is used, the focus area is not displayed and the camera focuses at the center of the frame.

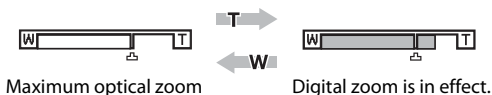

## Digital Zoom and Interpolation

Unlike optical zoom, digital zoom uses a digital imaging process known as interpolation to magnify images, resulting in slight deterioration of image quality.

Interpolation is applied when shooting still images at zoom positions beyond .

When zoom is increased beyond the  position, interpolation is initiated and the zoom indicator turns yellow to indicate that interpolation is being applied.

The position of  moves to the right as image size decreases, allowing you to confirm the zoom positions at which still images can be captured without interpolation using the current image mode setting.



When the image size is small.

## Step 3 Focus and Shoot

### 1 Press the shutter-release button halfway.

- Press halfway (📖 13) to focus. When the subject is in focus, the focus area glows green.

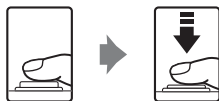

When a face is detected:



Shutter Speed    Aperture

When shooting non-human subjects or when no faces are detected:

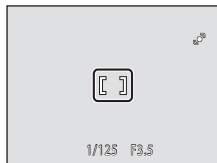

- When digital zoom is used, the focus area is not displayed and the camera focuses at the center of the frame. When the subject is in focus, the focus indicator glows green.

Focus indicator



- The shutter speed and aperture are displayed when the shutter-release button is pressed halfway.
- Focus and exposure remain locked while the shutter release button is pressed halfway.
- When the camera is unable to focus, the focus area, or focus indicator, blinks red. Change the composition and press the shutter-release button halfway again.

### 2 Press the shutter-release button the rest of the way down.

- The image is saved to the memory card or internal memory.



### **During Saving**

While images are being saved, the number of exposures remaining display will blink. Do not open the battery-chamber/memory card slot cover.

Removing the memory card or the battery during saving may result in loss of data or in damage to the saved data, camera or card.

### **Autofocus**

Autofocus may not perform as expected in the following situations. In some rare cases, the subject may not be in focus despite the fact that the focus area or the focus indicator glows green:



- Subject is very dark
- Objects of sharply differing brightness are included in the scene (e.g. the sun is behind the subject and the subject is in deep shadow)
- No contrast between the subject and surroundings (e.g. when the subject is wearing a white shirt and is standing in front of a white wall)
- Several objects are at different distances from the camera (e.g. the subject is inside a cage)
- Subject is moving rapidly

In these situations, try pressing the shutter-release button halfway again to refocus, several times if necessary. If the subject is still not in focus, select auto mode and use focus lock ( 48) to take the picture by first focusing on an object that is the same distance from the camera as the desired subject.



### **Notes on Face Detection**

See "Notes on Face Detection" ( 28) for more information.

### **The Did someone blink? Screen**

When  **Blink warning** is set to **On**, the **Did someone blink?** screen ( 111) is displayed after taking a picture if the camera detects a face with closed eyes.













### **AF-assist Illuminator and Flash**

If the subject is poorly lit, the AF-assist illuminator ( 106) may light by pressing the shutter-release button halfway, or the flash ( 29) may fire by pressing the shutter-release button all the way down.

## Step 4 Viewing and Deleting Images

### Viewing Images (Playback Mode)

Press .

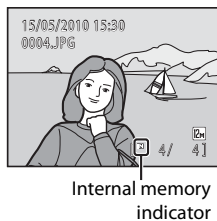
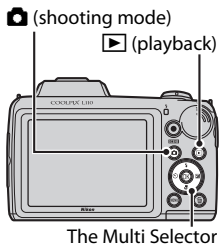

- The last image taken is displayed in full-frame playback mode.
- Use the multi selector , ,  or  to view additional images. Hold down the multi selector , ,  or  to quickly scan through images.
- Pictures may be displayed briefly at low resolution while being read from the memory card or internal memory.
- Press  or the  (movie-record) button to switch to shooting mode. You can also press the shutter-release button.
- When  is displayed, images saved in the internal memory are displayed. When a memory card is inserted,  is not displayed and images saved on the memory card are displayed.

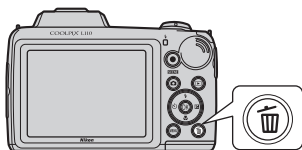

### Deleting Images

- 1 Press  to delete the image currently displayed in the monitor.



- 2 Use the multi selector to select **Yes** and press .
  - Deleted pictures cannot be recovered.
  - To exit without deleting the image, choose **No** and press .



### Playback Mode

See “More on Playback” (📖 59) and “Editing Image” (📖 69) for more information.

### Power ON by Pressing

When the camera is off, hold down  to turn on the camera in playback mode. The lens will not extend.

### Viewing Image

- Pictures taken using face detection (📖 24) are automatically rotated when viewing them full-frame.
- While the monitor is off during standby mode, it will turn on again when the power switch, shutter-release button, or  button is pressed (📖 108).

### Deleting the Last Image Taken While in Shooting Mode

In shooting mode, press  to delete the last images taken.

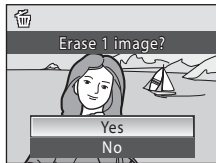







### Selecting Multiple Pictures for Deletion

When **Delete** (📖 67) is selected from the playback menu (📖 63), multiple images can be deleted.

# Easy Auto Mode

## Automatic Scene Selection

The camera automatically selects one of the following scenes when you point the camera at a subject.

-  Auto mode (general use)
-  Portrait (📖 36)
-  Landscape (📖 36)
-  Night portrait (📖 37)
-  Night landscape (📖 39)
-  Close-up (📖 39)
-  Backlight (📖 41)

## Notes on Face Detection

- The camera's ability to detect faces depends on a variety of factors, including whether or not the subject is facing the camera. The camera may be unable to detect faces in the following situations:
  - When faces are partially hidden by sunglasses or other obstructions
  - When faces take up too much or too little of the frame
- When there are multiple people in the frame, the face on which the camera focuses depends on a variety of shooting conditions, such as whether or not the subject is facing the camera.
- In some cases, including those noted in "Autofocus" (📖 25), autofocus may not perform as expected, and the subject may not be in focus despite the fact that the double border glows green. When the camera is unable to focus, use another mode, such as  (auto) mode, focus on another subject positioned at the same distance from the camera as the actual portrait subject, and use focus lock (📖 48).

## Using the Flash

In dark locations or when the subject is backlit, you can shoot pictures with flash by raising the built-in flash.

- The flash has a range of about 0.5 to 5.5 m (1 ft. 8 in. to 18 ft.) when the camera is zoomed out all the way, and about 1.5 to 3.5 m (5 ft. to 11 ft.) when the camera is zoomed in all the way.
- If the built-in flash is raised when using easy auto mode (📖 20), the camera automatically sets a flash mode according to the determined scene mode. When the built-in flash is lowered, the flash setting changes to off and 📷 is displayed at the top of the monitor.

### Selecting a Flash Mode

When using Auto mode (📖 48), certain scene modes (📖 35), or smart portrait mode (📖 44), the following flash modes are available.

 **AUTO** Auto

Flash fires automatically when lighting is poor.

 **Auto with red-eye reduction**

Reduces “red-eye” in portraits (📖 31).

 **Off**

Flash will not fire even when lighting is poor.

 **Fill flash**

Flash fires when a picture is taken. Use to “fill-in” (illuminate) shadows and back-lit subjects.

 **Slow sync**

Auto flash mode is combined with slow shutter speed.

Flash illuminates main subject; Slow shutter speeds are used to capture background at night or under dim light.

## 1 Raise the built-in flash (📖 6).

- When the built-in flash is lowered, it is fixed to 📷 (off).

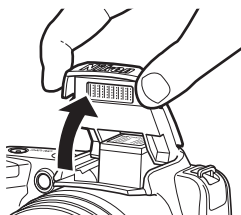



## 2 Press (flash mode) on the multi selector.

- The flash menu is displayed.



## 3 Press the multi selector or to select a mode, and press .

- The icon for the selected flash mode is displayed at the top of the monitor.
- When  (auto) is applied,  disappears after a few seconds regardless of the monitor settings (101).
- If a setting is not applied by pressing  within a few seconds, the selection is cancelled.

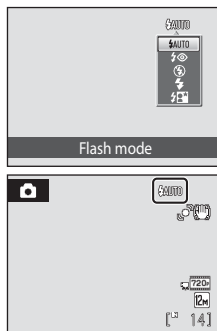

### Lowering the Built-in Flash

Push the built-in flash down gently to lower the built-in flash when not in use (6).

### Shooting When Lighting Is Poor and the Flash Is Disabled ()

- Use of a tripod is recommended to stabilize the camera during shooting and avoid the effects of camera shake. Set **Vibration reduction** (104) to **Off** when using a tripod.
- The **ISO** is displayed when the camera automatically increases sensitivity to minimize blur caused by slow shutter speed. Images taken when **ISO** is displayed may be slightly mottled.

### Note on Using the Flash

When using the flash, reflections from dust particles in the air may appear as bright spots in images. To reduce these reflections, set the flash to  (off).

### The Flash Lamp

The flash lamp indicates flash status when the shutter-release button is pressed halfway.









- On:** Flash will fire when picture is taken.
- Blinks:** Flash charging. Wait a few seconds and try again.
- Off:** Flash will not fire when picture is taken.

If the remaining battery level is low, the monitor will turn off until the flash has finished charging.



## The Flash Mode Setting

The default setting of flash mode depends on the shooting mode.

-  (easy auto) mode:  AUTO Auto
- Scene mode: The default setting depends on the scene menu ( 35).
-  (smart portrait) mode:  AUTO Auto
-  (sport continuous) mode:  Off (locked)
-  (auto) mode:  AUTO Auto

Flash cannot be used simultaneously with certain features. → Camera Settings that Cannot Be Set at the Same Time ( 58)

When the shooting mode is  (auto) mode ( 48), the changed flash setting is saved even if the camera is turned off.

## Red-eye Reduction

This camera is equipped with an **advanced red-eye reduction** system.

Pre-flashes are fired several times at low intensity before the main flash to reduce the effects of red-eye.

If the camera detects “red-eye” when a picture is taken, Nikon’s own In-Camera Red-Eye Fix processes the image before it is saved.

Note the following when using red-eye reduction:

- Because pre-flashes are fired before the picture is taken, there is a slight lag between when the shutter-release button is pressed and when the picture is shot.
- The time required to save images increases slightly.
- Red-eye reduction may not always produce the desired results.
- In some rare cases, other portions of images may be affected. Use flash modes other than auto

## Taking Pictures with the Self-timer

When using the self-timer, pictures are taken 10 seconds after the shutter-release button is pressed. When using the self-timer, use of a tripod is recommended. Set **Vibration reduction** (📖 104) in the setup menu (📖 93) to **Off** when using a tripod.

### 1 Press (self-timer) on the multi selector.

The self-timer menu is displayed.



### 2 Press the multi selector or to select **ON**, and press .

The self-timer icon ( 10) is displayed.

If a setting is not applied by pressing  within a few seconds, the selection is cancelled.

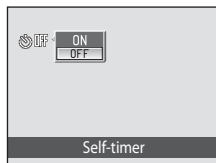

### 3 Frame the picture and press the shutter-release button halfway.

Focus and exposure are set.



### 4 Press the shutter-release button the rest of the way down.

The self-timer starts and the number of seconds remaining until the shutter is released is displayed in the monitor. The self-timer lamp blinks. The lamp stops blinking one second before the picture is taken and remains lit until the shutter is released.

When the shutter is released, the self-timer is set to **OFF**.

To stop the timer before a picture is taken, press the shutter-release button again.

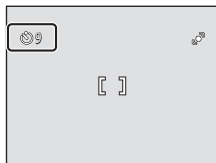

# Adjusting the Brightness: Exposure Compensation



Exposure compensation is used to alter exposure from the value suggested by the camera to make images brighter or darker.

## 1 Press (exposure compensation) on the multi selector.

- The exposure compensation guide is displayed.



## 2 Press the multi selector or to adjust the exposure, and press .

- To make the subject brighter, adjust the exposure compensation to the "+" side.
- To make the subject darker, adjust the exposure compensation to the "-" side.
- Exposure compensation can be set to values between -2.0 and +2.0 EV.
- If a setting is not applied by pressing  within a few seconds, the selection is cancelled.
- When set to any value other than **0.0**, the value is displayed with the  icon in the monitor.

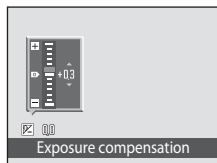

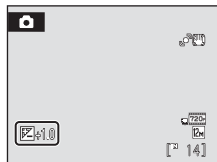

## 3 Press the shutter-release button to shoot.

- To turn off exposure compensation, repeat from step 1 and set the value to **0.0**, then press .







### Exposure Compensation Value

When shooting mode is  (auto) mode ( 48), the exposure compensation setting is saved even if the camera is turned off.

### Using Exposure Compensation

- The camera tends to reduce exposure when the frame is dominated by brightly lit objects and to increase exposure when the frame is mostly dark. Positive compensation may therefore be required to capture the brilliancy of very bright objects that fill the frame (for example, sunlit expanses of water, sand, or snow) or when the background is much brighter than the main subject.
- Negative compensation may be called for when large areas of the frame contain very dark objects (for example, a swath of dark green leaves) or when the background is much darker than the main subject.

## Selecting Shooting Mode







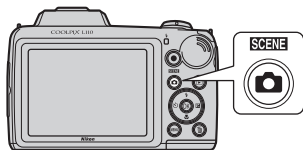

Select the shooting mode from  easy auto mode,  scene mode,  smart portrait,  sport continuous mode, or  auto mode.

### 1 Press in shooting mode.

- The shooting-mode selection menu is displayed.



### 2 Use the multi selector or to select a shooting mode and press .

- The camera enters the selected shooting mode.
- When scene mode is selected (the second icon from the top), the scene type can be changed before pressing . Press , press , , , or  to select the desired scene type, then press .
- To return to the current shooting mode without switching shooting modes, press  or the shutter-release button.

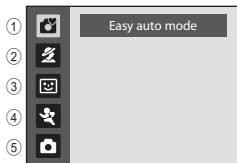

#### 1 Easy auto mode 20

By simply framing a picture, the camera automatically selects the optimum scene mode for simpler shooting.

#### 2 Scene 35

Camera settings are automatically optimized for the selected scene type.

#### 3 Smart portrait 44

The camera detects a smiling face to shoot the face automatically.

#### 4 Sport continuous 46

Allows rapid, continuous shooting while you press and hold the shutter-release button fully.

#### 5 Auto mode 48

You can change the flash mode, use macro mode (for close-ups), etc., and take pictures. You can also select to shoot bursts of pictures continuously.

## Shooting Suited for the Scene (Scene Mode)

Camera settings are automatically optimized for the selected scene type. The following scene modes are available.

Portrait	Beach/snow	Close-up	Backlight
Landscape	Sunset	Food	Panorama assist
Night portrait	Dusk/dawn	Museum	
Party/indoor	Night landscape	Copy	

### Selecting a Scene Mode

- 1 Press in shooting mode to display the shooting-mode selection menu and use the multi selector and to select scene mode.

- The icon of the last scene mode used is displayed. (Portrait) is the default setting.

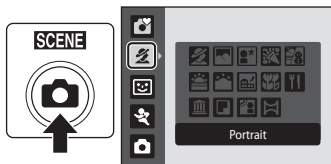

- 2 Press , press the multi selector , , , or to select a scene, and press .

- The shooting mode screen for the selected scene is displayed.
- Features → 36

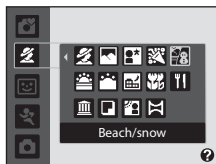

- 3 Frame the subject and shoot.





- For scene modes that use the flash, be sure to raise the built-in flash before shooting.



### Image Mode

When using scene mode, you can set **Image mode** ( 51) by pressing **MENU**. If the image mode setting is changed, the new image mode setting is also applied to other shooting modes (except sport continuous).

## Features

The following icons are used for descriptions in this section: : flash mode when the built-in flash is raised ([book 29](#)); : self-timer ([book 32](#)); : macro mode ([book 49](#)); : exposure compensation ([book 33](#)).

### Portrait

Use this mode for taking portraits in which the main subject stands out clearly.

- If the camera detects a face, it focuses on the face. See "Face Detection" ([book 24](#)) for more information.
- If more than one face is detected, the camera focuses on the face closest to the camera.
- If no faces are detected, the camera will focus on the center of the screen.
- Digital zoom is not available.



\* Other settings can be selected.

### Landscape

Use this mode for vivid landscapes and cityscapes.

- Camera focuses at infinity. The focus area or focus indicator ([book 8](#)) always glows green when the shutter-release button is pressed halfway. Note, however, that objects in the foreground may not always be in focus.
- The AF-assist illuminator ([book 106](#)) does not light.



\* Other settings can be selected.

### Night portrait



Use this mode to achieve a natural balance between the main subject and background lighting in portraits taken at night.

- Shoot pictures with the built-in flash raised.
- If the camera detects a face, it focuses on the face. See “Face Detection” (📖 24) for more information.
- If more than one face is detected, the camera focuses on the face closest to the camera.
- If no faces are detected, the camera will focus on the center of the screen.
- Digital zoom is not available.



\*<sup>1</sup> Flash mode is set to fill flash with slow sync and red-eye reduction, and cannot be changed.

\*<sup>2</sup> Other settings can be selected.

### Party/indoor



Captures the effects of candlelight and other indoor background lighting.

- The camera focuses on the subject in the center of the frame.
- As pictures are easily affected by camera shake, hold the camera steadily. In a dark place, the use of a tripod is recommended. Set **Vibration reduction** (📖 104) to **Off** when using a tripod.



\*<sup>1</sup> The flash may change to slow sync with red-eye reduction. Other settings can be selected.

\*<sup>2</sup> Other settings can be selected.

: For those scene modes with , use of a tripod is recommended. Set **Vibration reduction** (📖 104) to **Off** when using a tripod.

**NR**: Indicates images shot in this scene mode are processed automatically to reduce noise, and therefore may take more time to save.

## Shooting Suited for the Scene (Scene Mode)

### Beach/snow

Captures the brightness of such subjects as snowfields, beaches, or sunlit expanses of water.

- The camera focuses on the subject in the center of the frame.



\* Other settings can be selected.

### Sunset

Preserves the deep hues seen in sunsets and sunrises.

- The camera focuses on the subject in the center of the frame.





\* Other settings can be selected.

### Dusk/dawn







Preserves the colors seen in the weak natural light before sunrise or after sunset.

- Camera focuses at infinity. The focus area or focus indicator ( 8) always glows green when the shutter-release button is pressed halfway. Note, however, that objects in the foreground may not always be in focus.
- The AF-assist illuminator ( 106) does not light.



\* Other settings can be selected.



: For those scene modes with , use of a tripod is recommended. Set **Vibration reduction** ( 104) to **Off** when using a tripod.

: Indicates images shot in this scene mode are processed automatically to reduce noise, and therefore may take more time to save.

### Night landscape



Slow shutter speeds are used to produce stunning night landscapes.

- Camera focuses at infinity. The focus area or focus indicator ( 8) always glows green when the shutter-release button is pressed halfway. Note, however, that objects in the foreground may not always be in focus.
- The AF-assist illuminator ( 106) does not light.







			Off*		Off		0.0*
---	---	---	------	---	-----	---	------

\* Other settings can be selected.

### Close-up



Photograph flowers, insects and other small objects at close range.

- Macro mode ( 49) will turn **ON** and the zoom will automatically move to the closest possible shooting position.
- The closest distance at which the camera can focus varies depending on the zoom position. The camera can focus at distances as close as 1 cm (0.4 in.) from the lens when  and the zoom indicator glow green (zoom indicator is positioned near .
- The camera focuses on the subject in the center of the frame. Use focus lock to frame the picture on an object not in the center of the frame ( 48).
- The camera focuses continuously until the shutter-release button is pressed halfway to lock the focus.
- As pictures are easily affected by camera shake, check the **Vibration reduction** ( 104) setting and hold the camera steadily.



	<b>FLASH</b> *		Off*		On		0.0*
---	----------------	---	------	---	----	---	------

\* Other settings can be selected. Note that the flash may be unable to light the entire subject at distances of less than 50 cm (1 ft. 8 in.).





: For those scene modes with , use of a tripod is recommended. Set **Vibration reduction** ( 104) to **Off** when using a tripod.

**NR**: Indicates images shot in this scene mode are processed automatically to reduce noise, and therefore may take more time to save.

## Shooting Suited for the Scene (Scene Mode)

### Food

Use this mode when taking pictures of food.

- Macro mode (📖 49) will turn **ON** and the zoom will automatically move to the closest possible shooting position.  
The closest distance at which the camera can focus varies depending on the zoom position. The camera can focus at distances as close as 1 cm (0.4 in.) from the lens when  and the zoom indicator glow green (zoom indicator is positioned near .
- You can adjust the hue using the slider displayed on the left side of the monitor. Press the multi selector  to increase the amount of red, or  to increase the amount of blue. The hue setting is saved even when the camera is turned off.
- The camera focuses on the subject in the center of the frame. Use focus lock to frame the picture on an object not in the center of the frame (📖 48).
- The camera focuses continuously until the shutter-release button is pressed halfway to lock the focus.
- As pictures are easily affected by camera shake, check the **Vibration reduction** (📖 104) setting and hold the camera steadily.

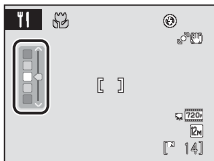

\* Other settings can be selected.

### Museum

Use indoors where flash photography is prohibited (for example, in museums and art galleries) or in other settings in which you do not want to use the flash.

- The camera focuses on the subject in the center of the frame.
- BSS (best shot selector) can be used to shoot (📖 55).
- As pictures are easily affected by camera shake, check the **Vibration reduction** (📖 104) setting and hold the camera steadily.
- The AF-assist illuminator (📖 106) does not light.



\* Other settings can be selected.

**Copy**

Provides clear pictures of text or drawings on a white board or in print.

- The camera focuses on the subject in the center of the frame.
- Use macro mode (📖 49) to focus at short ranges.
- Colored text and drawings may not show up well.



\* Other settings can be selected.

**Backlight**

Use when light is coming from behind your subject, throwing features or details into shadow. The flash fires automatically to “fill in” (illuminate) shadows.

- Shoot pictures with the built-in flash raised.
- The camera focuses on the subject in the center of the frame.



\* Other settings can be selected.

**Panorama assist**



Use when taking a series of pictures that will later be joined to form a single panorama image using the supplied Panorama Maker software. See Taking Pictures for a Panorama (📖 42) for details.



\* Other settings can be selected.

## Taking Pictures for a Panorama





The camera focuses on the subject in the center of the frame. Use a tripod for best results. Set **Vibration reduction** (📖 104) to **Off** when using a tripod.



- 1 Press  in shooting mode to display the shooting-mode selection menu and use the multi selector to select  **Panorama assist** (📖 35).

The panorama direction icon () is displayed to show the direction in which pictures are joined.



- 2 Use the multi selector to choose the direction and press .

Select how pictures are joined together in the completed panorama; right () , left () , up () or down () .

The yellow panorama direction icon () is displayed to the direction pressed and the direction is fixed when  is pressed. The white fixed direction  is displayed.

Apply flash mode (📖 29), self-timer (📖 32), macro mode (📖 49) and exposure compensation (📖 33) settings with this step, if necessary. Press  to reselect the direction.



- 3 Shoot the first picture.

The first picture is superimposed in the first third of the monitor.



- 4 Shoot the second picture.

Frame the next picture so that one third of the frame overlaps the first picture, and press the shutter-release button.

Repeat until you have taken the necessary number of pictures to complete the panorama.



## 5 Press **OK** when shooting is completed.

- The camera returns to step 2.



### **✓** Panorama Assist

- Set flash mode, self-timer, macro mode and exposure compensation before taking the first picture. They cannot be changed after the first picture is taken. Images cannot be deleted, nor can zoom or Image mode setting (📖 51) be adjusted after the first picture is taken.
- The panorama series is terminated if the camera enters standby mode with the auto off function (📖 108) during shooting. Setting the time allowed to elapse before the auto off function is enabled to a longer setting is recommended.

### **🔍** Note on AE/AF-L

All pictures taken in a panorama series have the same white balance, exposure, and focus settings.

When the first picture is shot, AE/AF-L is displayed to indicate that exposure, white balance, and focus are locked.



### **🔍** Panorama Maker

Install Panorama Maker from the supplied Software Suite CD.





Transfer images to a computer (📖 82) and use Panorama Maker (📖 86) to join them in a single panorama.

### **🔍** More Information

See "Image File and Folder Names" (📖 123) for more information.

# Capturing Smiling Faces Automatically (Smart Portrait Mode)

The camera detects a smiling face to shoot the face automatically.

- 1 Press  in shooting mode to display the shooting-mode selection menu and use the multi-selector  or  to select  and press .

The camera enters smart portrait mode.

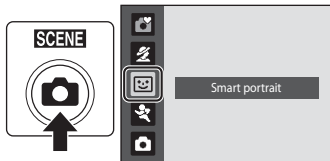

- 2 Frame the picture.

- Raise the built-in flash when using the flash.
- Point the camera at the subject.
- If the camera detects a person's face, the face is framed by a double yellow border in the focus area, and when the face comes into focus, the double border turns green for a moment and the focus is locked.
- Up to three faces can be detected. When the camera detects more than one face, the face nearest the center of the screen is framed by a double border in the focus area and the other faces are framed by a single border.

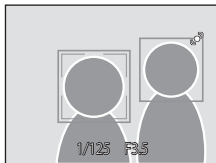

- 3 The shutter is automatically released.

- If the camera detects the smiling face of the person framed by a double border, the shutter is automatically released.
- The self-timer lamp ( 4) blinks when the camera detects a face, and it flickers immediately after the shutter is released. Each time the shutter is released, the camera again begins face detection and smile detection operations for continuous automatic shooting.
- Pictures can also be taken by pressing the shutter-release button. If the camera does not detect any faces, the camera focuses on the subject in the center of the frame.

- 4 Exit smart portrait mode by pressing .

Change to another shooting mode.



### **Face Detection and Smiling Face Detection features**





- In some shooting conditions, face detection does not work and faces cannot be detected.
- Notes on Face Detection →  28

### **Auto Off (Standby Mode) When Using Smart Portrait Mode**

When using smart portrait mode, Auto off ( 108) will turn the camera off if no operations are performed in the following situations:

- The camera does not detect any faces.
- The camera detected the face but cannot detect a smiling face.

### **Functions Available in Smart Portrait Mode**

- Digital zoom is not available.
- Flash mode ( 29) changes automatically to  **AUTO** (auto), but can be changed.
- The exposure compensation ( 33) is available.
- The self-timer and macro mode are not available.
- Image mode ( 51) can be changed by pressing **MENU**. If the image mode setting is changed, the new image mode setting is also applied to other shooting modes (except sport continuous).





### **More Information**

See, "Autofocus" ( 25) for more information.

# Shooting Continuously at High Speed (Sport Continuous)

Sport continuous mode allows rapid, continuous shooting while you press and hold the shutter-release button fully. With continuous shooting, instantaneous movements in moving subjects can be captured.

- With the default setting of **Continuous H**, the camera shoots up to 20 pictures at a rate of up to about 11.1 frames per second (fps).
- ISO sensitivity is set high.
- Image mode can be set to **3M 2048x1536** or smaller.
- The focus, exposure, and white balance settings are fixed at the values for the first picture in each series.

- 1** Press  in shooting mode to display the shooting-mode selection menu and use the multi-selector  or  to select  and press .

The camera enters sport continuous mode.

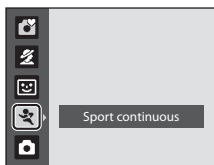

- 2** Press **MENU**, then confirm or set the items in the sport continuous menu.

- sport continuous menu →  47
- Press **MENU** after setting the items to return to shooting mode.

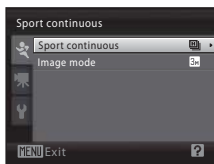

- 3** Frame the subject and shoot.

- The camera focuses on the subject in the center of the frame. Pressing the shutter-release button halfway sets the focus and exposure.
- Continuous shooting continues as long while the shutter-release button is held all the way down, and stops when the number of shot frames reaches the maximum available number ( 47).

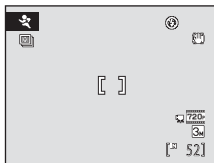

## Functions Available with Sport Continuous

- The exposure compensation ( 33) is available.
- The flash is disabled.
- The self-timer and macro mode are not available.

**✓ Notes on Sport Continuous Shooting**

- It may take some time to save the images after shooting. The time it takes to save the images depends on the number of shots taken, the image mode, the memory card's write speed, etc.
- Because the ISO sensitivity is set to 640 or higher, images may appear rough as a result. Proper exposure may not be obtained in clear weather (images may be overexposed).
- Smear (📖 121) visible in the monitor when shooting with sport continuous will be visible in the saved image data. To reduce smear effects, avoid bright objects such as the sun, reflections of the sun, and electric lights when shooting.
- When shooting under lights that have a high flicker rate, such as fluorescent or mercury lights, exposure and white balance may differ from image to image.
- The shutter speed is set automatically within the range of 1/8000 s to 1/15 s.
- The speed of continuous shooting may be slower depending on shutter speed settings and the write speed of the memory card.
- When using sport continuous mode, the camera focuses continuously until the shutter-release button is pressed halfway to lock the focus. A sound will be heard while the camera focuses.

**🔍 More Information**

See, "Autofocus" (📖 25) for more information.

**Sport Continuous Menu**

The following items can be set in the sport continuous menu. In sport continuous mode, press **MENU** (📖 12) to display the sport continuous menu, then use the multi-selector (📖 11) to modify and apply settings.

**Sport continuous**

Select the sport continuous mode type to determine the maximum continuous shooting speed and maximum number of frames to be shot.

- **📷 Continuous H** (default setting): Approx. 11.1 frames per second (20 frames max.)
- **📷 Continuous M**: Approx. 7.3 frames per second (20 frames max.)
- **📷 Continuous L**: Approx. 4.4 frames per second (20 frames max.)

**Image mode**

**Image mode** (📖 51) can be set.

- In sport continuous mode, the following image mode settings are available:  
**📷 2048×1536** (default setting), **📷 1024×768**, **📷 640×480**, **📷 1920×1080**.
- The image mode setting in the sport continuous menu is saved separately from the image mode setting in other shooting modes and is not applied to the other modes.

# Auto Mode

In (auto) mode, macro mode ( 49) and exposure compensation ( 33) can be applied and pictures can be taken using flash mode ( 29) and self-timer ( 32). Pressing **MENU** in (auto) mode allows you to specify settings for all shooting menu items ( 50) depending upon the shooting situations.

## 1 Press to display the shooting-mode selection menu.

- The shooting-mode selection menu is displayed.

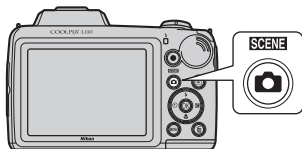

## 2 Press the multi selector or to choose and press **OK**.

- The camera enters (auto) mode.
- Raise the built-in flash when using the flash.
- Set the flash mode ( 29), self-timer ( 32), exposure compensation ( 33), and macro mode ( 49) to match the shooting conditions.
- Press **MENU** to display the shooting menu, and set the items in the shooting menu to match the shooting conditions ( 50).

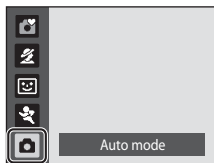

## 3 Frame the subject and shoot.

- The camera focuses on the subject in the center of the frame.

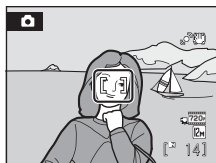

## Focus Lock

When the camera focuses on an object in the center of the frame, you can use focus lock to focus on an off-center subject.

- Be sure that the distance between the camera and the subject does not change while focus is locked.
- When the shutter-release button is pressed halfway, exposure is locked.



Position the subject in the center of the frame.



Press the shutter release button halfway.



Confirm that the focus area is green.





Continue holding down the shutter-release button halfway and recompose the picture.



Press the shutter-release button the rest of the way down.

## Macro Mode

Macro mode is used for taking pictures of objects as close as 1 cm (0.4 in.). Note that the flash may be unable to light the entire subject at distances of less than 50 cm (1 ft. 8 in.).

When using  (auto) mode, follow the procedure below. Macro mode can also be used with some scene modes ( 39, 40, 41).

### 1 Press (macro mode) on the multi selector.

- The macro menu is displayed.





### 2 Press the multi selector or to select **ON**, and press .

The macro mode icon () is displayed.

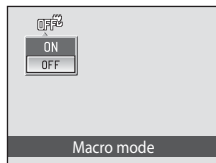
If a setting is not applied by pressing  within a few seconds, the selection is cancelled.



### 3 Use the zoom control and frame the picture.



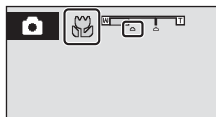





The camera can focus at distances as close as 1 cm (0.4 in.) from the lens when  and the zoom indicator glow green (zoom indicator is positioned near ).



## Autofocus









When shooting still images using macro mode, the camera focuses continuously until the shutter-release button is pressed halfway to lock the focus. A sound will be heard while the camera focuses.

## The Macro Mode Setting



-  (easy auto) mode: Changes to macro mode when the camera selects . The macro mode button on the multi selector cannot be used.
- Scene mode: The default setting depends on the scene menu ( 35). Macro mode is turned on when  **Close-up** or  **Food** are selected in scene mode.
-  (smart portrait) mode,  (sport continuous) mode: Macro mode cannot be used.
- When shooting mode is  (auto) mode, the macro mode setting is saved even if the camera is turned off.

## Shooting Menu (Auto Mode)

While shooting in  (auto) mode ( 48), the shooting menu contains the following options.

	<b>Image mode</b>  51
	Choose image size and quality (compression). Also available when using other shooting modes.
<b>WB</b>	<b>White balance</b>  53
	Match white balance to the light source.
	<b>Continuous</b>  55
	Change settings to Continuous or BSS (best shot selector).
<b>ISO</b>	<b>ISO sensitivity</b>  56
	Control the camera's sensitivity to light.
	<b>Color options</b>  57
	Make colors more vivid or save images in monochrome.

## Displaying the Shooting Menu

Press  in shooting mode to display the shooting-mode selection menu and set the shooting mode to  (auto) mode ( 48).

Press **MENU** to display the shooting menu.

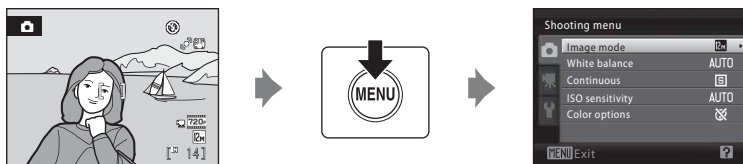

- Use the multi selector to choose and apply settings ( 11).
- To exit the shooting menu, press **MENU**.

### Camera settings that cannot be applied at the same time

50 Some functions may not be set at the same time ( 58).

## Image Mode (Image Quality/Image Size)

Set to (auto) mode (📖 48) → MENU (Shooting menu) → Image mode

Choose image size and quality (compression). The size of the files, and with it the number of images that can be saved, depends on the size and quality (compression) of the images. Before shooting, choose an image mode according to how you plan to use the image.

Setting	Size (pixels)	Description
4000×3000★	4000×3000	Highest quality, suitable for enlargements or high-quality prints. The compression ratio is approximately 1:4.
4000×3000 (default setting)	4000×3000	Best choice in most situations. The compression ratio is approximately 1:8.
3264×2448	3264×2448	
2592×1944	2592×1944	
2048×1536	2048×1536	Smaller size allows more images to be saved. The compression ratio is approximately 1:8.
1024×768	1024×768	Suited to display on a computer monitor. The compression ratio is approximately 1:8.
640×480	640×480	Suited to distribution by e-mail or full-screen display on a television with a 4:3 aspect ratio.
3968×2232	3968×2232	Images with an aspect ratio of 16:9 can be taken. The compression ratio is approximately 1:8.

The icon for the current setting is displayed in the monitor in shooting and playback modes (📖 8, 9).

### Note on Image Mode









- If the image mode setting is changed, the new image mode setting is also applied to other shooting modes (except sport continuous).
- This feature cannot be used simultaneously with certain features. → “Camera Settings that Cannot Be Set at the Same Time” (📖 58)

### Image Mode for Sport Continuous Mode

- In sport continuous mode (📖 46), the following image mode settings are available: 2048×1536, 1024×768, 640×480, 1920×1080 (image size 1920 × 1080, compression ratio 1/8).
- The image mode setting in the sport continuous menu (📖 46) is saved separately from the image mode setting in other shooting modes and is not applied to the other modes.

## Number of Exposures Remaining

The following table lists the approximate number of images that can be saved in internal memory and on a 4 GB memory card. Note that the number of images that can be saved will differ depending on the composition of the image (due to JPEG compression). In addition, this number may differ depending on the make of memory card, even if the capacity for the memory card is the same.

Image mode	Internal memory (Approx. 43 MB)	Memory card <sup>*1</sup> (4 GB)	Print size (printed at 300 dpi; cm/in.) <sup>*2</sup>
 4000×3000★	7	650	34×25/13.4×9.8
 4000×3000	14	1280	34×25/13.4×9.8
 3264×2448	21	1910	28×21/11×8.3
 2592×1944	33	2940	22×16/8.7×6.2
 2048×1536	52	4640	17×13/6.7×5.1
 1024×768	171	15000	9×7/3.5×2.8
 640×480	305	24000	5×4/2×1.6
 3968×2232	19	1720	34×19/13.4×7.5
 1920×1080	76	6700	16×9/6.5×3.5

<sup>\*1</sup> If the number of exposures remaining is 10,000 or more, the number of exposures remaining display shows **9999**.

<sup>\*2</sup> Print sizes are calculated by dividing the number of pixels by printer resolution (dpi) and multiplying by 2.54 cm (1 in.). However, at the same image size, images printed at higher resolutions will print smaller than the size indicated, and those printed at lower resolutions will print larger than the size indicated.

## WB White Balance (Adjusting hue)

Set to  (auto) mode (📖 48) → MENU (Shooting menu) → **WB** White balance

The color of light reflected from an object varies with the color of the light source. The human brain is able to adapt to changes in the color of the light source, with the result that white objects appear white whether seen in the shade, direct sunlight, or under incandescent lighting. Digital cameras can mimic this adjustment by processing images according to the color of the light source. This is known as “white balance”.

Although the default setting, **Auto** can be used under most types of lighting, you can apply the white balance setting suited to a particular light source to achieve more accurate results.

### **AUTO** Auto (default setting)

White balance automatically adjusted to suit lighting conditions. Best choice in most situations.

### **PRE** Preset manual

Neutral-colored object used as reference to set white balance under unusual lighting conditions. Please refer to “Preset Manual” for more information(📖 54).

### Daylight

White balance adjusted for direct sunlight.

### Incandescent

Use under incandescent lighting.

### Fluorescent

Use under most types of fluorescent lighting.

### Cloudy

Use when taking pictures under overcast skies.

### Flash

Use with flash mode.

The icon for the current setting is displayed in the monitor (📖 8). However, when **Auto** is selected, no icon is displayed.

## White Balance

- This feature cannot be used simultaneously with certain features. → “Camera Settings that Cannot Be Set at the Same Time” (📖 58)
- At white-balance settings other than **Auto** or **Flash**, turn the flash off (🔇) (📖 29).

## Preset Manual

Preset manual is used with mixed lighting or to compensate for light sources with a strong color cast (for example, to make pictures taken under a lamp with a red shade look as though they had been taken under white light).

**1** Place a white or gray reference object under the lighting that is used during shooting.

**2** Display the shooting menu (📖 34), use the multi selector to select **PRE Preset manual** in the **White balance** menu, and press **OK**.

The camera zooms in.

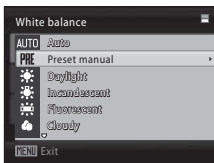

**3** Select **Measure**.

To apply the most recently measured value for preset manual, choose **Cancel** and press **OK**. The most recently measured value is applied for white balance.

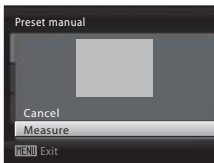

**4** Frame the reference object.

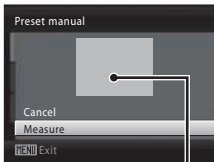

Reference object frame

**5** Press **OK**.

The shutter is released (no image is captured) and the new white-balance value is set.

### ✔ Note on Preset Manual

The camera cannot measure a white balance value for when the flash fires. When shooting with the flash, set **White balance** to **Auto** or **Flash**.

## Continuous

Set to (auto) mode (📖 48) → MENU (Shooting menu) → Continuous

Change settings to Continuous or BSS (best shot selector).

Flash will be switched off for **Continuous**, **BSS** or **Multi-shot 16**, and focus, exposure and white balance are fixed at the values for the first picture in each series.

### Single (default setting)

One shot is taken each time shutter-release button is pressed.

### Continuous

While the shutter-release button is held all the way down, up to 4 pictures are taken at a rate of about 1.0 frames per second (fps) when image mode is set to **4000×3000**.

### **BSS** BSS (Best Shot Selector)

The “best shot selector” is recommended when shooting with the flash off or the camera zoomed in, or in other situations in which inadvertent motion can result in blurred images.

When BSS is on, the camera takes up to 10 pictures while the shutter-release button is held all the way down. The sharpest image in the series is automatically selected and saved.

### Multi-shot 16

Each time the shutter-release button is pressed all the way down, the camera takes 16 shots at a rate of about 7.4 frames per second (fps), then arranges them in a single image. Images are captured with the image mode locked at **2560×1920**.

- Digital zoom cannot be used.

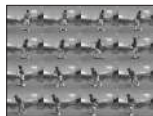

The icon for the current setting is displayed in the monitor during shooting (📖 8). When set to **Single**, no icon is displayed.

### **Note on Continuous Shooting**

- The frame rate with continuous shooting may vary, depending upon the current image mode setting, the memory card used, and the shooting environment.
- This feature cannot be used simultaneously with certain features. → “Camera Settings that Cannot Be Set at the Same Time” (📖 58)

### **Note on BSS**

**BSS** is best suited to shooting subjects that are not moving. When shooting moving subjects or when the composition of the picture changes while shooting, the desired results may not be achieved.

### **Note on Multi-shot 16**

Smear (📖 121) visible in the monitor when shooting with Multi-shot 16 will be visible in the saved image data. To reduce smear effects, avoid bright objects such as the sun, reflections of the sun, and electric lights when shooting.

## ISO ISO Sensitivity

Set to  (auto) mode (📖 48) → MENU (Shooting menu) → ISO ISO sensitivity

Sensitivity is a measure of how quickly the camera reacts to light. The higher the sensitivity, the less light needed to make an exposure. Although a high ISO rating is suited for taking pictures of subjects in action or in poor lighting, high sensitivity is often associated with “noise” - randomly spaced, brightly colored pixels concentrated in dark parts of the image.

### Auto (default setting)

Sensitivity is ISO 80 under normal conditions; when lighting is poor and the flash is off, the camera compensates by raising sensitivity to a maximum of ISO 800.

80, 100, 200, 400, 800, 1600, 3200, 6400

Sensitivity will be locked at the specified value.

- When ISO sensitivity is locked, **Motion detection** (📖 105) does not function.

The icon for the current setting is displayed in the monitor (📖 8). When **Auto** is selected, the **ISO** icon is not displayed at ISO 80, but is displayed if the ISO sensitivity automatically increases to more than 80 (📖 30).

### ✔ Notes on ISO Sensitivity

This feature cannot be used simultaneously with certain features. → “Camera Settings that Cannot Be Set at the Same Time” (📖 58)

### ✔ ISO 3200 and ISO 6400

When **ISO sensitivity** is set to **3200** or **6400**, the available **Image mode** settings are limited to **S** **2048×1536**, **PC** **1024×768**, and **VGA** **640×480**. The image mode of the shooting mode is shown in red and  is displayed next to the ISO sensitivity in the lower left of the monitor.



## Color Options

Set to  (auto) mode (📖 48) → MENU (Shooting menu) →  Color options

Make colors more vivid or save images in monochrome.

 **Standard color (default setting)**  
Use for images exhibiting natural color.

 **Vivid color**  
Use to achieve a vivid, “photoprint” effect.

 **Black-and-white**  
Save images in black-and-white.

 **Sepia**  
Save images in sepia tones.

 **Cyanotype**  
Save images in cyan-blue monochrome.

The effects of the selected option can be previewed in the monitor (📖 8). At settings other than **Standard color**, the icon for the current setting is displayed in the monitor.

### Notes on Color Options

This feature cannot be used simultaneously with certain features. → “Camera Settings that Cannot Be Set at the Same Time” (📖 58)

## Camera Settings that Cannot Be Set at the Same Time

Certain settings in the shooting menu cannot be used with other functions.









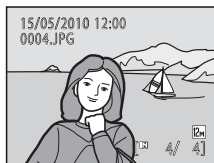











Restricted Functions	Setting	Description
Flash mode	Continuous (📖 55)	If set to <b>Continuous</b> , <b>BSS</b> , or <b>Multi-shot 16</b> , the flash cannot be used.
Digital zoom	Continuous (📖 55)	Digital zoom cannot be used when shooting with <b>Multi-shot 16</b> .
Image mode	Continuous (📖 55)	When using <b>Multi-shot 16</b> , <b>Image mode</b> is fixed at <b>5M 2560×1920</b> .
	ISO sensitivity (📖 56)	When the <b>ISO sensitivity</b> is set to <b>3200</b> or <b>6400</b> , the available <b>Image modes</b> are restricted to <b>3M 2048×1536</b> , <b>PC 1024×768</b> , and <b>VA 640×480</b> . For all other image mode settings, if <b>ISO sensitivity</b> is set to <b>3200</b> or <b>6400</b> , the image mode setting changes to <b>3M 2048×1536</b> .
White balance	Color options (📖 57)	When using <b>Black-and-white</b> , <b>Sepia</b> , or <b>Cyanotype</b> , the <b>White balance</b> setting is fixed at <b>Auto</b> .
Continuous	Self-timer (📖 32)	When using the self-timer, the setting is fixed at <b>Single</b> .
ISO sensitivity	Continuous (📖 55)	When using <b>Multi-shot 16</b> , <b>ISO sensitivity</b> is set automatically according to the brightness.
Date imprint	Continuous (📖 55)	The shooting date and time cannot be imprinted in images captured when using <b>Continuous</b> or <b>BSS</b> .
Motion detection	Continuous (📖 55)	<b>Motion detection</b> does not function when shooting with <b>Multi-shot 16</b> .
	ISO sensitivity (📖 56)	<b>Motion detection</b> does not function when ISO sensitivity is set to any setting other than <b>Auto</b> .

## Full-frame Operation

Press  button during shooting to switch to playback mode and view images (📖 26).

The following operations can be performed while viewing images in full-frame.



To	Use	Description	📖
Choose images		Press    or  to view the previous or next image. Hold down the multi-selector  ,  ,  or  to quickly scan through images.	26
View thumbnails/ calendar	<b>W</b> 	Display 4, 9, or 16 image thumbnails. While displaying 16 image thumbnails, rotate the zoom control to <b>W</b>  to display the calendar.	60, 61
Playback zoom	<b>T</b> 	The image can be enlarged up to about 10x. Press  to return to full-frame playback.	62
Movie Playback		Play the selected movie.	79
Deleting Images		Delete the selected image.	26
Menu Display	<b>MENU</b>	Display the playback menu.	63
Switch to shooting mode		Press  or the  (movie-record) button. You can also press the shutter-release button to return to shooting mode.	10
			
			

### Viewing Images

Images taken using face detection (📖 24) will be automatically rotated when viewing them full-frame.

## Viewing Multiple Images: Thumbnail Playback

Rotate the zoom control to **W** (📐) in full-frame playback mode (📖 26) to display images in “contact sheets” of thumbnail images. The following operations can be performed while thumbnails are displayed.

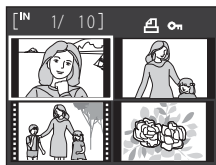

To	Use	Description	📖
Choose images		Press the multi selector ▲, ▼, ◀ or ▶.	11
Increase the number of images displayed/ apply the calendar display	<b>W</b> (📐)	Rotate the zoom control to <b>W</b> (📐) to increase the number of picture thumbnails displayed: 4 → 9 → 16. Rotate the zoom control to <b>W</b> (📐) in the 16-picture thumbnail display to apply the calendar display (📖 61), and images can be found by the date on which they were captured. Rotate the zoom control to <b>T</b> (🕒) to return to thumbnail display mode.	-
Reduce the number of frames displayed	<b>T</b> (🕒)	Rotate the zoom control to <b>T</b> (🕒) to reduce the number of frames displayed from 16 → 9 → 4. While 4 frames are displayed, rotate the zoom control to <b>T</b> (🕒) again to return to full-frame display mode.	-
Switch to full-frame playback	<b>OK</b>	Press <b>OK</b> .	26
Switch to shooting mode		Press  or the  (movie-record) button. You can also press the shutter-release button to return to shooting mode.	10

### Thumbnail Playback Mode Display

While images selected for **Print Set** (📖 64) and **Protect** (📖 114) are chosen, the icons shown on the right are displayed with them. Movies are displayed as film frames.

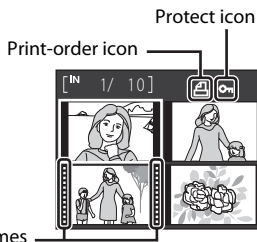

## Calendar Display

When displaying 16 thumbnail frames in playback mode (📖 60), switch to calendar display by rotating the zoom control to **W** (🗓️).

You can select images to view based on the day they were taken. Days containing images have a yellow line under them.

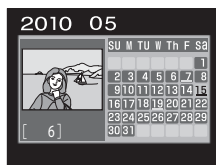

To	Use	Description	📖
Choose date		Press the multi selector ▲, ▼, ◀ or ▶.	11
Switch to full-frame playback		The first image for that date will be displayed full-frame.	26
Switch to thumbnail display	<b>T</b> (📷)	Rotate the zoom control to <b>T</b> (📷).	–

### 🗒️ Calendar display

- Images taken when the camera's date is not set are treated as images taken on January 1, 2010.
- 🗑️ and MENU are not available during calendar display.

## Taking a Closer Look: Playback Zoom

Rotating the zoom control to **T** (Q) during full-frame playback mode (📖 26) zooms the current image, with the center of the image displayed in the monitor.

- The guide displayed in the right bottom in the monitor will show which part of the image is currently displayed.



The following operations can be performed while images are zoomed in.

To	Use	Description	📖
Zoom in	<b>T</b> (Q)	Zoom increases each time the zoom control is rotated to <b>T</b> (Q), up to about 10x.	–
Zoom out	<b>W</b> (📐)	Zoom decreases each time the zoom control is rotated to <b>W</b> (📐). When the magnification ratio reaches 1x, the display returns to full-frame playback mode.	–
View other areas of image		Press the multi selector ▲, ▼, ◀ or ▶ to scroll to areas of the image not visible in the monitor.	11
Switch to full-frame playback	OK	Press OK.	26
Crop image	MENU	Press MENU to crop current image to contain only the portion visible in the monitor.	72
Switch to shooting mode		Press  or the ● (movie-record) button. You can also press the shutter-release button to return to shooting mode.	10
	●		

### Images taken using Face Detection





When the zoom control is rotated to **T** (Q) during full-frame playback mode for images taken using Face Detection (📖 24), the image will be enlarged with the face detected with shooting at the center of the monitor.

- If several faces are detected, the image will be enlarged using the face that was focused on during shooting time as the centralized point, and pressing the multi selector ▲, ▼, ◀ or ▶ will enable you to switch between the people's faces.
- Rotate the zoom control toward **T** (Q) again or toward **W** (📐) to zoom in or out as normal.



# Playback Menu

The following options are available in playback mode.

	<b>D-Lighting</b> <span style="float: right;">70</span>
Enhances brightness and contrast in dark portions of images.	
	<b>Print set</b> <span style="float: right;">64</span>
Select images to print and the number of copies for each.	
	<b>Slide show</b> <span style="float: right;">66</span>
View images saved in the internal memory or on a memory card in an automatic slide show.	
	<b>Delete</b> <span style="float: right;">67</span>
Delete selected images or all images. Multiple images can be deleted with one operation.	
	<b>Small picture</b> <span style="float: right;">71</span>
Create a small copy of the current image.	

## Displaying the Playback Menu

Press  to enter playback mode.

Display the playback menu by pressing **MENU**.

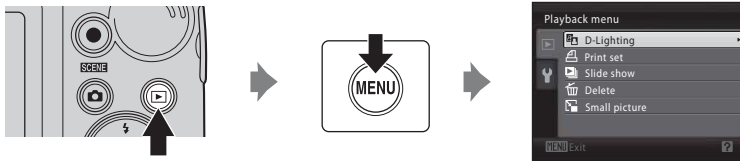

- Use the multi selector to choose and apply settings (70).
- To exit the playback menu, press **MENU**.



## Protecting Images From Accidental Deletion, Rotating Images

- You can prevent images from accidental deletion by using **Protect** (77) in the setup menu (93).
- You can rotate images by using **Rotate image** (78) in the setup menu (93).

## Copying Files Between the Internal Memory and Memory Card

You can copy files between the internal memory and memory card by using **Copy** (79) in the setup menu (93).

## Print Set

Press the  button (Playback mode) → MENU (Playback menu) →  Print set

When printing images using one of the following methods, you can select which images will be printed and the number of copies of each image will be printed, and save this electronic “print order” information on the memory card.

- Printing by inserting the camera's memory card into the card slot of a DPOF-compatible printer (📖 136)
- Printing by taking the camera's memory card to a photo lab
- Printing by connecting the camera (📖 87) to a PictBridge-compatible printer (📖 136) (by removing the memory card from the camera, you can also use this method to print images saved in the internal memory)

### 1 Press MENU in playback mode.

The playback menu is displayed.

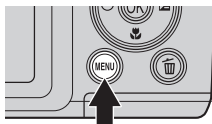

### 2 Use the multi selector to choose **Print set** and press **OK**.

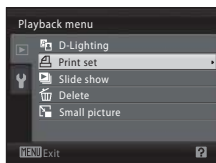

### 3 Choose **Select images** and press **OK**.

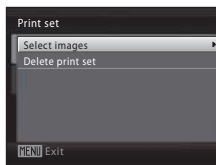

### 4 Choose the images (up to 99) and number of copies (up to nine) of each.

Press the multi selector ◀ or ▶ to choose the desired images. Press ▲ or ▼ to set the number of copies for each. Images selected for printing can be identified by the check mark (✔) and the numeral indicating the number of copies to be printed. Images for which no copies have been specified will not be printed.

Rotate the zoom control to **T** (📷) to display full-frame playback, and **W** (📷) to switch back to 12 thumbnails. Press **OK** when setting is complete.

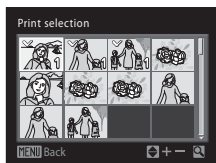

## 5 Choose whether or not to also print shooting date and photo information.

Choose **Date** and press **OK** to print date of recording on all images in the print order.

Choose **Info** and press **OK** to print photo information (shutter speed and aperture) on all images in the print order.

Choose **Done** and press **OK** to complete the print order and exit.

Images selected for printing are indicated by the  icon displayed during playback.

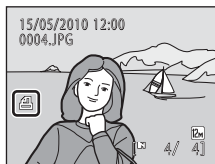
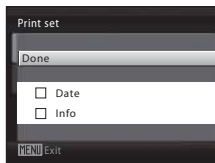

## Notes on Printing Shooting Date and Photo Information

When the **Date** and **Info** options are enabled in the print set menu, shooting date and photo information are printed on images when a DPOF-compatible printer (📖 136) which supports printing of shooting date and photo information is used.

- Photo information cannot be printed when the camera is connected directly to a printer, via the supplied USB cable, for DPOF printing (📖 91).
- **Date** and **Info** are reset each time the **Print set** menu is displayed.
- The date and time printed on images with DPOF printing when **Date** in the **Print set** menu is enabled, are those saved with the image when it was taken. Date and time printed using this option are not affected when the camera's date and time setting are changed from the setup menu after images are saved.



## Deleting All Print Orders

Select **Delete print set** in step 3 of the print set procedure (📖 64) and press **OK** to delete print orders for all images.

## Date Imprint

The shooting date and time can be imprinted in images at the time of shooting by using **Date imprint** (📖 103) in the setup menu. Dates can be printed from printers that do not support date imprinting (📖 65). Only the Date imprint date and time on images will be printed, even if **Print set** is enabled with date selected in the print set screen.

## Slide Show

Press the  button (Playback mode) → MENU (Playback menu) →  Slide show

View images saved in the internal memory or on a memory card in an automatic slide show.

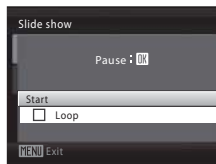

### 1 Use the multi selector to choose **Start** and press .

To repeat the slide show automatically, enable **Loop** and press  before selecting **Start**. The check mark () is added to the loop option when enabled.



### 2 The slide show begins.

While the slide show is in progress, the following operations can be performed:

- Use the multi selector to switch images. Hold  or  down to fast forward or rewind.
- Press  to pause the slide show.





### 3 Choose **End** or **Restart**.

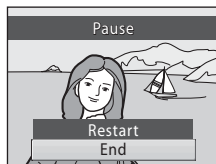

When the slide show ends or is paused, select **End** and press  to return to the playback menu, or choose **Restart** to play the slide show again.



### Notes on Slide Show

- Only the first frame of movies ( 79) included in slide shows is displayed.
- Even if **Loop** is selected, the monitor can continuously display the Slide Show for up to 30 minutes ( 108).

## Delete

Press the  button (Playback mode) → MENU (Playback menu) →  Delete

Delete selected images or all images.



### Erase selected images

Delete selected images. → Selecting Multiple Images ( 68)

### Erase all images

Delete all images.

## Notes on Deletion

- Once deleted, images cannot be recovered. Transfer important images to a computer before deletion.
- Images marked with the  icon are protected and cannot be deleted ( 114).

## Selecting Multiple Images

The screen shown on the right will be displayed in the menus (shown below) when choosing images.

- Playback menu: Print set: **Select images** (📖 64),  
 Delete: **Erase selected images** (📖 67)
- Setup menu: Welcome screen: **Select an image** (📖 97),  
 Protect (📖 114),  
 Rotate image (📖 115),  
 Copy: **Selected images** (📖 116)

Follow the procedure described below to choose the images.



### 1 Press the multi selector ◀ or ▶ to choose the desired image.

Only one image can be selected for **Welcome screen** and **Rotate image**. Proceed to step 3.

Rotate the zoom control to **T** (🔍) to display full-frame playback, and **W** (📐) to switch back to 12 thumbnails.



### 2 Press ▲ or ▼ to select **ON** or **OFF** (or the number of copies).

When **ON** is selected, a check mark (✔) is displayed in the top left corner of the current image. Repeat steps 1 and 2 to select additional images.



### 3 To fix the selection of images, press Ⓞ.



A confirmation dialog is displayed for certain screens, such as **Erase selected images**. In this case follow the on-screen directions.

## Image Editing Function

Use the camera to edit images in-camera and save them as separate files. The editing features described below are available (📖 123).

Editing function	Description
D-Lighting (📖 70)	Create a copy of the current image with enhanced brightness and contrast, brightening dark portions of the image.
Small picture (📖 71)	Create a small copy of images suitable for use on web pages or as e-mail attachments.
Crop (📖 72)	Enlarge the image or refine the composition and create a copy containing only the portion visible in the monitor.

### Notes on Image Editing

- Images taken at an **Image mode** setting (📖 51) of  **3968×2232** or  **1920×1080** cannot be edited.
- Only images taken with the COOLPIX L110 can be edited with this camera.
- When using a different model of digital camera, images edited with this camera may not be displayed properly and may not be able to be transferred to a computer.
- Editing functions are not available when there is not enough free space in the internal memory or on the memory card.

### Restrictions on Image Editing

The following limitations apply when editing images that were created by editing.

Copies Created By:	Can Be Edited By:
D-Lighting	Small picture and crop can be used.
Small picture Crop	Additional editing is not possible.

- Images cannot be edited twice with the same editing function.
- To use D-Lighting together with small picture or crop, use D-Lighting first, and use small picture or crop as the last edit function performed on that image.



### Original Images and Edited Copies

- Copies created with editing functions are not deleted if the original images are deleted. The original images are not deleted if copies created with editing functions are deleted.
- Edited copies are saved with the same shooting date and time as the original.
- Edited copies do not retain the **Print set** (📖 64) and **Protect** (📖 114) settings of the original.

## Editing Images

### **D-Lighting: Enhancing Brightness and Contrast**

Create a copy of the current image with enhanced brightness and contrast, brightening dark portions of the image. Enhanced copies are saved as separate files.

- 1 Select the desired image from full-frame ( 26) or thumbnail ( 60) playback mode and press **MENU**.

- The playback menu is displayed.

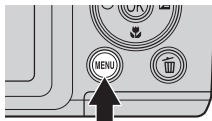

- 2 Use the multi selector to choose  **D-Lighting** and press **OK**.

- The original version is displayed on the left and the edited version is displayed on the right.



- 3 Choose **OK** and press **OK**.

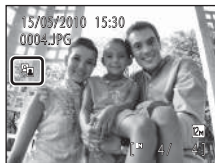
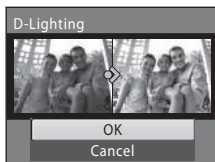

- A new image with enhanced brightness and contrast is created.
- To cancel, select **Cancel** and press **OK**.
- Images created with D-Lighting can be identified by the  icon displayed during playback.





### **More Information**

See "Image File and Folder Names" ( 123) for more information.

## Small Picture: Resizing Images

Create a small copy of the current image. Suitable for uploading to web sites or sending by e-mail. The following sizes are available:  **640×480**,  **320×240**, and  **160×120**. Small copies are saved as JPEG files with a compression ratio of 1:16.

- 1 Select the desired image from full-frame ( 26) or thumbnail ( 60) playback mode and press **MENU**.

- The playback menu is displayed.

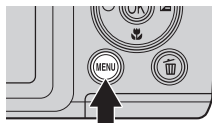

- 2 Use the multi selector to choose  **Small picture** and press **OK**.

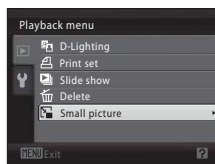

- 3 Choose the desired copy size and press **OK**.

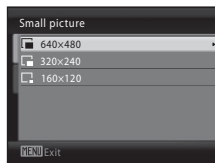

- 4 Choose **Yes** and press **OK**.



- A new, smaller copy is created.
- To cancel, select **No** and press **OK**.
- The copy is displayed with a gray frame.



### More Information

See "Image File and Folder Names" ( 123) for more information.

## ✂ Crop: Creating a Cropped Copy

Create a copy containing only the portion visible in the monitor when **MENU**  is displayed with playback zoom ( 62) enabled. Cropped copies are saved as separate files.

### 1 Rotate the zoom control to **T** (📐) in full-frame playback mode to zoom in on the image.

- To crop an image displayed in “tall” (portrait) orientation, zoom in on picture until the black bars displayed on the both sides of the monitor disappear. The cropped image is displayed in landscape orientation. To crop the image in its current “tall” (portrait) orientation, first, use the **Rotate image** option ( 115) to rotate the image so that it is displayed in landscape orientation. Next, enlarge the image for cropping, crop the image, and then rotate the cropped image back to “tall” (portrait) orientation.

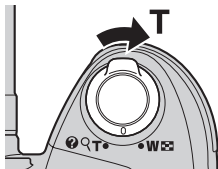

### 2 Refine copy composition.

Rotate the zoom control to **T** (📐) or **W** (📏) to adjust the zoom ratio.

Press the multi selector **▲**, **▼**, **◀** or **▶** to scroll the image until only the portion you want to copy is visible in the monitor.

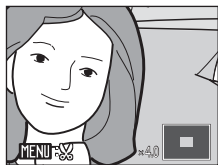

### 3 Press **MENU**.

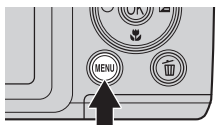



### 4 Use the multi selector to select **Yes** and press **OK**.

A new image, containing only the portion visible in the monitor, is created.

To exit without cropping the image, choose **No** and press **OK**.



#### **About the size of the original image**

The smaller the cropped area of the image, the smaller of the cropped image size (number of pixels). When the image is cropped and the size of the cropped copy is 320 × 240 or 160 × 120, the image is displayed with a gray border on the playback screen, and the small picture icon  or  is displayed on the left of the playback screen.

#### **More Information**

See “Image File and Folder Names” ( 123) for more information.

## Recording Movies

You can use the camera to record high-definition movies with sound.

The maximum movie length for each movie is 29 minutes, regardless of memory card capacity (📖 77).

### 1 Turn the camera on and display the shooting mode screen.

- Movies can be recorded in any shooting mode (📖 34).
- The current movie options setting is displayed. The default setting is **HD720p (1280×720)** (📖 77).

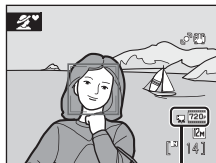

Movie options

### 2 Lower the built-in flash (📖 6)

Recording movies while the built-in flash is raised may cause the audio to be muffled.

### 3 Press the ● (movie-record) button to start recording.

- Recording begins after the monitor turns off briefly.
- The camera focuses on the subject in the center of the frame. The focus area is not displayed while recording movies.
- When **Movie options** is set to **720p HD720p (1280×720)**, the aspect ratio is 16:9 and the movie is recorded as shown on the right.
- Digital zoom cannot be used while recording movies. If digital zoom is used before recording, it will be canceled when recording starts.
- The progress bar displayed at the bottom of the monitor during recording indicates the amount of recording time remaining. If recording time runs out, recording stops automatically.

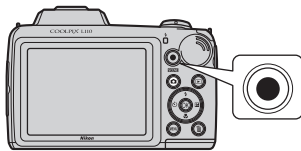



### 4 Press the ● (movie-record) button to stop recording.



### ✓ Recording Movies

- When recording movies, we recommend using a memory card with a Class 6 or higher speed class rating (📖 122). When using a memory card with a low speed class, recording may stop unexpectedly.
- When recording movies, the angle of view (field of view) is smaller than when shooting still images.
- Digital zoom cannot be used while recording movies.
- Operation sounds from the time of recording (the zoom control being rotated, the lens zooming, the autofocus, etc.) may be heard when playing back movies.
- Smear (📖 121) visible in the monitor when recording will be visible in the saved image data. To reduce smear effects, avoid bright objects such as the sun, reflections of the sun, and electric lights when recording movie.



### ✓ Autofocus

- When **Autofocus mode** in the movie menu is set to  **Single AF** (default setting), focus is locked when the ● (movie-record) button is pressed and recording starts (📖 78).
- Autofocus may not perform as expected in certain situations (📖 25). Try using the following methods in these situations.
  1. Before recording, set **Autofocus mode** to  **Single AF** (default setting) in the movie menu.
  2. Aim the camera at another subject that is positioned the same distance from the camera as the desired subject, press the ● (movie-record) button to start recording, then aim the camera at the desired subject.

### ✓ While the Camera Is Saving Movies







When movie recording stops, the movie is not completely saved until the shooting screen is displayed. Do not open the battery-chamber / memory card slot cover if the movie has not yet been completely saved. Removing the memory card or the battery while a movie is being saved may result in loss of the movie data or damage to the camera or the memory card.

### ✍ Functions Available in Movie Mode

- When the shooting mode is set to  (auto) mode (📖 48), the current settings for white balance (📖 53) and color options (📖 57) are used when recording movies.
- When the shooting mode is set to any mode other than  (auto) mode, **White balance** is set to **Auto** and **Color options** is set to **Standard color** when recording movies. Movies are recorded in color even when scene mode is set to **Copy**.
- The current exposure compensation setting is used when recording movies. If macro mode is enabled before the ● (movie-record) button is pressed, the camera can record movies of subjects that are close to the camera.
- When using the self-timer, the camera waits for 10 seconds after the ● (movie-record) button is pressed, then focuses and begins recording.
- Flash will not fire even when lighting is poor.
- When recording movies, electronic vibration reduction is used automatically to reduce the effects of camera shake.
- To change the settings for **Movie options**, **Autofocus mode**, or **Wind noise reduction**, press **MENU** before recording to display the  (movie) tab (📖 75).

## Movie Menu

The movie menu contains the following options.



	<b>Movie options</b>	 77
The movie menu offers the options shown below.		
	<b>Autofocus mode</b>	 78
Select how the camera focuses in movie mode.		
	<b>Wind noise reduction</b>	 78
Reduces the effects of wind noise when recording movies.		

## Displaying the Movie Menu

### 1 Display the shooting mode screen and press **MENU**.

- The menu is displayed.



- When using easy auto mode, scene mode, or smart portrait mode, press the multi selector ( 11)  to display the tabs.

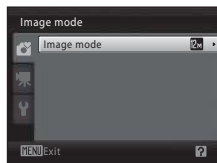

### 2 Press the multi selector .

You can now select a tab.

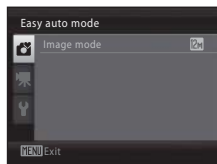

### 3 Press or to select the tab.

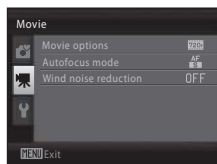

### 4 Press ► or OK.

You can now select an item from the movie menu.

Use the multi selector to choose and apply settings (11).

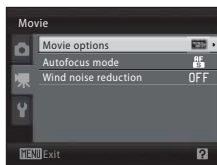

To exit the movie menu, press **MENU** or press ◀ and select another tab.



## 🎬 Movie Options



Display the shooting mode screen → Press the **MENU** button → 🎬 (Movie menu) (📖 75)  
→ 🎬 Movie options

The movie menu offers the options shown below. As resolution and bit rate increase, image quality and file size also increase.

Option	Description
 <b>HD 720p (1280 × 720)</b> (default setting)	Movies with an aspect ratio of 16:9 are recorded in high definition. This option is suited to playback on a wide screen TV. <ul style="list-style-type: none"> <li>• Image size: 1280 × 720 pixels</li> <li>• Movie bitrate: 9.0 Mbps</li> </ul>
 <b>VGA (640 × 480)</b>	Movies with an aspect ratio of 4:3 are recorded. <ul style="list-style-type: none"> <li>• Image size: 640 × 480 pixels</li> <li>• Movie bitrate: 3.0 Mbps</li> </ul>
 <b>QVGA (320 × 240)</b>	Movies with an aspect ratio of 4:3 are recorded. <ul style="list-style-type: none"> <li>• Image size: 320 × 240 pixels</li> <li>• Movie bitrate: 640 kbps</li> </ul>

- The movie bitrate is the volume of movie data recorded per second. As a variable bitrate (VBR) system has been adopted, the movie recording rate varies automatically according to the subject so that more data is recorded per second for movies containing frequently moving subjects, thus increasing movie file size.
- The frame rate is approximately 30 frames per second in any options.

## 📎 Movie Options and Maximum Movie Length

Option	Internal memory (Approx. 43 MB)	Memory card (4 GB)*
 <b>HD 720p (1280×720)</b> (default setting)	34 s	50 min
 <b>VGA (640×480)</b>	1 min 34 s	2 h 30 min
 <b>QVGA (320×240)</b>	4 min 26 s	10 h



All figures are approximate. The maximum recording time varies depending on the type of memory card used, the bit rate of recorded movies, etc.

\* The maximum recording time for each movie is 29 minutes. Even if the memory card has capacity to record for more than 29 minutes, the camera displays no more than 29 minutes as the available recording time.



## 🔍 More Information

See "Image File and Folder Names" (📖 123) for more information.



## Autofocus Mode

Display the shooting mode screen → Press the MENU button →  (Movie menu) (📖 75)  
→  Autofocus mode

Choose how the camera focuses in movie mode.

Setting	Description
 <b>Single AF</b> (default setting)	Focus is locked when the  (movie-record) button is pressed.
 <b>Full-time AF</b>	The camera focuses continuously while recording. To prevent sound of camera focusing from interfering with recording, use of <b>Single AF</b> is recommended.

## Wind Noise Reduction

Display the shooting mode screen → Press the MENU button →  (Movie menu) (📖 75)  
→  Wind noise reduction

Reduces the effects of wind noise when recording movies.

The icon for the current setting is displayed in the monitor during shooting (📖 8).  
When set to **Off**, no icon is displayed.

Setting	Description
On	The sound of the camera focusing may be heard in recorded movies. Select this setting when recording in places with strong wind. Using this setting may make other sounds difficult to hear during playback.
<b>Off</b> (default setting)	Turns Wind noise reduction off.

## Movie Playback

In full-frame playback mode (📖 26), movies can be identified by the Movie options icon (📖 77). To play a movie, display it in full-frame playback mode and press **OK**.

Use the zoom control **T** (🔍)/**W** (📐) during playback to adjust the volume.

Playback controls are displayed at the top of the monitor. Press the multi selector ◀ or ▶ to choose a control, then press **OK** to perform the selected operation. The following operations are available.

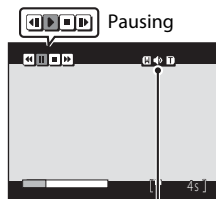
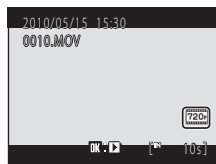

During playback      Volume indicator

To	Use	Description
Rewind	⏮	Rewind movie. Playback resumes when <b>OK</b> is released.
Advance	⏭	Advance movie. Playback resumes when <b>OK</b> is released.
Pause	⏸	Pause playback. The following operations can be performed while playback is paused.
		⏮      Rewind movie by one frame. Rewind continues while <b>OK</b> is pressed.
		⏭      Advance movie by one frame. Advance continues while <b>OK</b> is pressed.
	▶	Resume playback.
End	⏹	End playback and return to full-frame playback.

## Deleting Movies

Press **🗑** when displayed in full-frame playback mode (📖 26), or when selected in thumbnail (📖 60) playback mode. A confirmation dialog is displayed. Choose **Yes** and press **OK** to delete the movie, or choose **No** and press **OK** to return to the normal playback display without deleting the movie.



### ✔ Note on Movie Playback

Only movies recorded with COOLPIX L110 can be played back.

## Connecting to a TV

Connect the camera to a television to play back images on the television.

If you have an HDMI compatible TV, you can enjoy playing back images at high definition image quality by connecting the camera to the television using an HDMI cable (available separately from third-party suppliers).

### 1 Turn off the camera.

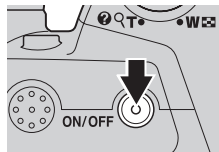

### 2 Connect the camera to the TV using the supplied audio video cable.

#### When using the supplied audio/video cable (AV cable)

Connect the yellow plug to the video-in jack on the TV, and the white plug to the audio-in jack.

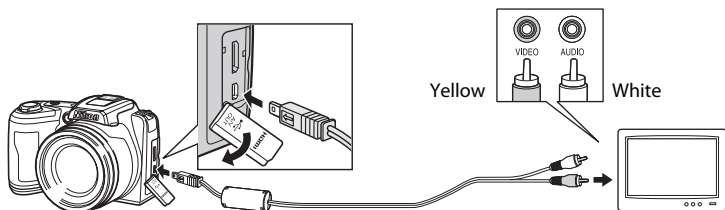

#### When using an HDMI cable (available separately from third-party suppliers)

Connect the HDMI cable to the HDMI input on the TV.

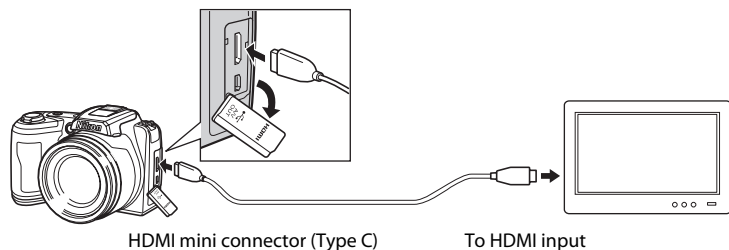

### 3 Tune the television to the video channel.

- See the documentation provided with your television for details.

### 4 Hold down to turn on the camera.

- The camera enters playback mode, and the images taken are displayed on the television.
- While connected to the TV, the camera monitor remains off.

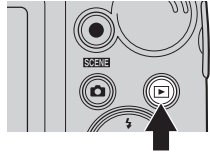

### Notes on HDMI Connection

- An HDMI cable is not included. Please purchase an HDMI cable. The camera's HDMI output uses an HDMI mini connector (Type C). When purchasing an HDMI cable, confirm that one end of the cable has an HDMI mini-pin connector.
- To play back images and movies in high definition on an HDMI-compatible TV, we recommend capturing still images with **Image mode** (📖 51) set to  **2048x1536** or higher, and recording movies with **Movie options** (📖 77) set to **HD720p (1280x720)** or higher.

### Connecting the Audio/Video Cable

- When connecting the AV cable, be sure that the camera connector is oriented correctly. Do not use force when connecting the AV cable to the camera. When disconnecting the AV cable, do not pull the connector at an angle.
- Do not connect an audio/video cable and an HDMI cable to the camera at the same time.
- Do not connect a USB cable and an HDMI cable to the camera at the same time.

### Video Mode

Be sure that the camera's video mode setting conforms to the standard used by your television. The video mode setting is an option set in the **Set up** menu (📖 93) → **TV settings** (📖 110).

## Connecting to a Computer

Use the supplied USB cable to connect the camera to a computer, and copy (transfer) pictures to a computer with the supplied Nikon Transfer software.

### Before Connecting the Camera

#### Install the Software

Before connecting the camera to a computer, software, including Nikon Transfer, ViewNX for displaying transferred pictures, and Panorama Maker for creating panorama photos, must be installed using the supplied Software Suite CD. For more information on installing the software, refer to the *Quick Start Guide*.

#### Compatible Operating Systems

##### Windows

- Windows 7 (Home Basic/Home Premium/Professional/Enterprise/Ultimate editions)
- Windows Vista Service Pack 2 (Home Basic/Home Premium/Business/Enterprise/Ultimate editions)
- 32-bit versions of Windows XP Service Pack 3 (Home Edition/Professional)

##### Macintosh

Mac OS X (version 10.4.11, 10.5.8, 10.6)

For information on the requirements for playing back high-definition and full-HD movies, refer to the ViewNX help information (System Requirements>H.264 High-Definition (HD) movie playback) (📖 86).

Refer to the Nikon website for the latest information on operating system compatibility.

#### Note on Power Source

When connecting the camera to a computer, use fully charged batteries to prevent the camera from turning off unexpectedly.

If the AC Adapter EH-67 (📖 122) (available separately) is used, COOLPIX L110 can be powered from an electrical outlet. Do not use any other make or model of AC adapter as they may cause the camera to overheat or malfunction.

## Transferring Pictures from a Camera to a Computer

- 1 Start the computer to which Nikon Transfer was installed.
- 2 Be sure that the camera is off.
- 3 Connect the camera to the computer using the supplied USB cable.

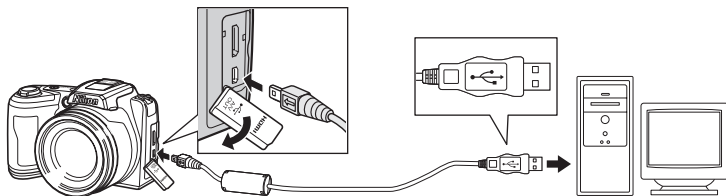

- 4 Turn on the camera.

The power-on lamp will light. The camera monitor will remain off.

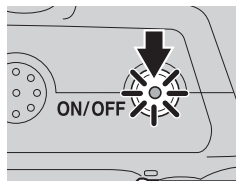

### ✓ Connecting the USB Cable

- Be sure that connectors are properly oriented. Do not attempt to insert connectors at an angle, and do not use force when connecting or disconnecting the USB cable.
- The connection may not be recognized if the camera is connected to the computer via a USB hub.

## 5 Start Nikon Transfer installed on the computer.

### • Windows 7

When the **Devices and Printers ► L110** screen is displayed, click **Change program** under **Import pictures and videos**. Select **Copy pictures to a folder on my computer** in the **Change program** dialog and click **OK**.

Double-click **Copy pictures to a folder on my computer** on the **Devices and Printers ► L110** screen.

### • Windows Vista

When the **AutoPlay** dialog is displayed, click **Copy pictures to a folder on my computer using Nikon Transfer**.

### • Windows XP

When the action selection dialog is displayed, select **Nikon Transfer Copy pictures to a folder on my computer**, and click **OK**.

### • Mac OS X

Nikon Transfer will start automatically when the camera is connected to the computer if **Yes** was selected in the Auto-Launch setting dialog when Nikon Transfer was first installed.

- If there are a large number of images on the memory card, it may take some time for Nikon Transfer to start.

## 6 Confirm that the source device is displayed in the transfer options **Source** panel and click **Start Transfer**.

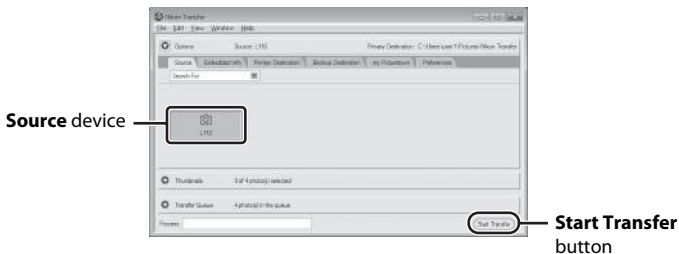

At the Nikon Transfer default settings, all pictures are transferred to the computer.

At the Nikon Transfer default settings, ViewNX starts automatically when transfer is complete and transferred pictures can be viewed.

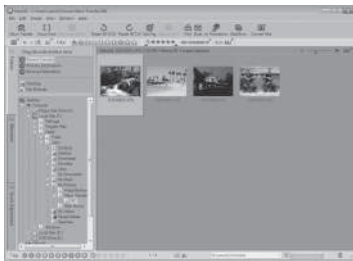

For more information on using Nikon Transfer or ViewNX, refer to help information contained in Nikon Transfer or ViewNX (📖 86).

## Disconnecting the camera

Do not turn off the camera or disconnect the camera from the computer during transfer.

When transfer is complete, turn off the camera and disconnect the USB cable.

## 📎 Using a Card Reader

The pictures stored on the memory card inserted into a card reader or similar device can also be transferred to the computer using Nikon Transfer.

- If the memory card capacity is 2 GB or more, or if the memory card is SDHC-compliant, the card reader or similar device must support these memory card specifications.
- Insert a memory card into the card reader or similar device, and refer to the steps 5 and 6 (📖 84) to transfer pictures.
- To transfer pictures stored in the camera's internal memory to the computer, the pictures must first be copied to a memory card using the camera (📖 116).

## 🔍 Starting Nikon Transfer or ViewNX Manually

### Windows

Choose **Start** menu>**All Programs**>**Nikon Transfer**>**Nikon Transfer** (or **All Programs**>**ViewNX**>**ViewNX**).

Double-clicking the Nikon Transfer or ViewNX shortcut icon on the desktop will also start Nikon Transfer or ViewNX.

### Macintosh

Open **Applications** and double-click **Nikon Software**>**Nikon Transfer**>**Nikon Transfer** (or **Nikon Software**>**ViewNX**>**ViewNX**).

Clicking the Nikon Transfer or ViewNX icon on the Dock will also start Nikon Transfer or ViewNX.

### Viewing Nikon Transfer and ViewNX Help Information

For more information on Nikon Transfer or ViewNX, start Nikon Transfer or ViewNX and select **Nikon Transfer Help** or **ViewNX Help** from the **Help** menu.

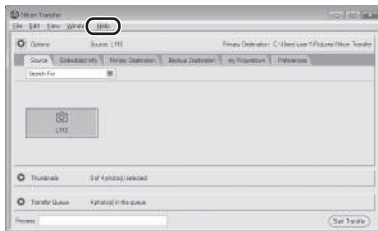

### Panorama Creation with Panorama Maker

- Use a series of pictures taken in **Panorama assist** scene mode (📖 41) to create a single panorama photo with Panorama Maker.
- Panorama Maker can be installed on a computer using the supplied Software Suite CD.
- After installation is complete, follow the procedure described below to start Panorama Maker.

#### Windows

Choose **Start menu>All Programs>ArcSoft Panorama Maker 5>Panorama Maker 5**.

#### Macintosh

Open **Applications** and double-click the **Panorama Maker 5** icon.

- For more information on using Panorama Maker, refer to the on-screen instructions and help information contained in Panorama Maker.

### Image File Names and Folder Names

See "Image File and Folder Names" (📖 123) for more information.

## Connecting to a Printer

Users of PictBridge-compatible (📖 136) printers can connect the camera directly to the printer and print images without using a computer.

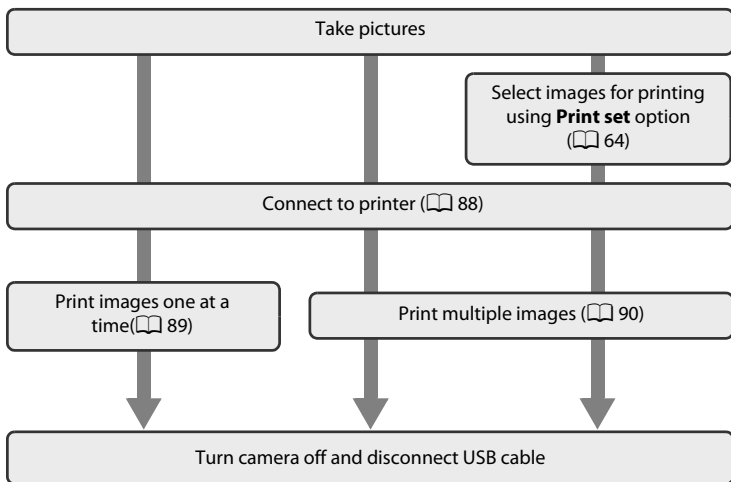

### ✔ Note on Power Source

- When connecting the camera to a printer, use batteries with adequate charge remaining to power the camera to prevent the camera from turning off unexpectedly.
- To power the camera continuously for extended periods, use an AC Adapter EH-67 (available separately) (📖 122). Do not, under any circumstances, use another make or model of AC adapter. Failure to observe this precaution could result in overheating or in damage to the camera.

### 📖 Printing Images

In addition to printing images transferred to a computer from your personal printer and printing over a direct camera-to-printer connection, the following options are also available for printing images:

- Insert a memory card into a DPOF-compatible printer's card slot
- Take a memory card to a digital photo lab

For printing using these methods, you can specify the images and the number of prints each using **Print set** in the playback menu (📖 64).

## Connecting the Camera and Printer

- 1 Turn off the camera.

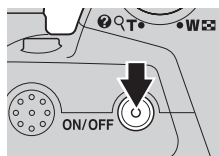

- 2 Turn on the printer.

Check printer settings.

- 3 Connect the camera to the printer using the supplied USB cable.

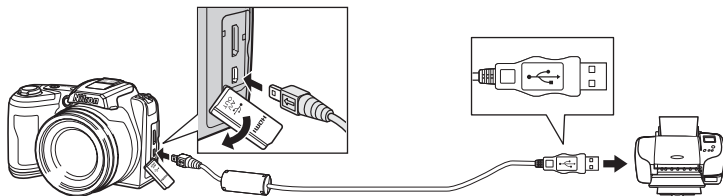

- 4 Turn on the camera.

- When connected correctly, the PictBridge startup screen (①) is displayed in the camera monitor. Then the **Print selection** screen is displayed (②).

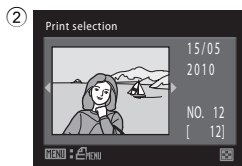
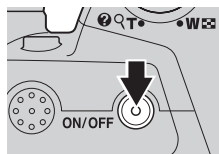

### Connecting the USB Cable

When connecting the USB cable, be sure that the connectors are oriented correctly. Do not use force when connecting the USB cable. When disconnecting the USB cable, do not pull the connector at an angle.

## Printing Images One at a Time

After connecting the camera to the printer correctly (📖 88), print images by following the procedure below.

**1** Use the multi selector to choose the desired image and press **OK**.

- Rotate the zoom control to **W** (🖼️) to display 12 thumbnails, and **T** (🔍) to switch back to full-frame playback.

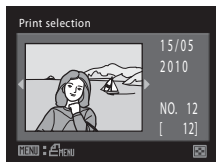

**2** Choose **Copies** and press **OK**.

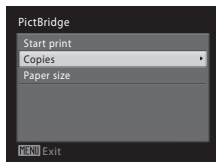

**3** Choose the number of copies (up to nine) and press **OK**.

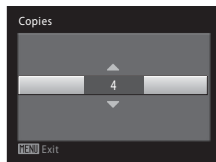

**4** Choose **Paper size** and press **OK**.

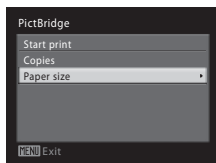

**5** Choose the desired paper size and press **OK**.

- To specify paper size using printer settings, choose **Default** in the paper size menu.

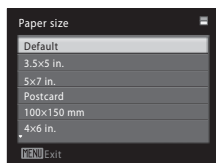

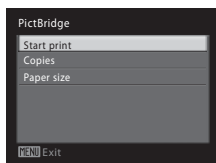
**6** Choose **Start print** and press **OK**.**7** Printing starts.

Monitor display returns to that shown in step 1 when printing is complete.

To cancel before all copies have been printed, press **OK**.

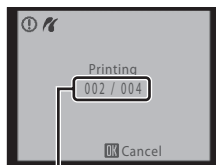

Current print/ total number of prints

**Printing Multiple Images**

After connecting the camera to the printer correctly (88), print images by following the procedure below.

**1** When the **Print selection** screen is displayed, press **MENU**.

The **Print menu** is displayed.

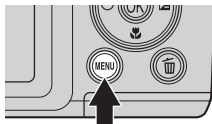
**2** Use the multi selector to choose **Paper size** and press **OK**.

Press **MENU** to exit the print menu.

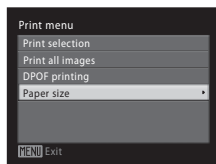
**3** Choose the desired paper size and press **OK**.

To specify paper size using printer settings, choose **Default** in the paper size menu.

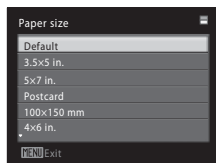

#### 4 Choose **Print selection**, **Print all images** or **DPOF printing** and press **OK**.

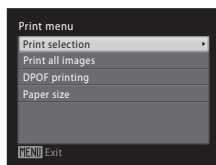

##### Print selection

Choose the images (up to 99) and number of copies (up to nine) of each.

- Press the multi selector ◀ or ▶ to select images, and press ▲ or ▼ to set the number of copies for each.
- Images selected for printing can be identified by the check mark (✓) and the numeral indicating the number of copies to be printed. Images for which no copies have been specified will not be printed.
- Rotate the zoom control to **T** (Q) to display full-frame playback, and **W** (R) to switch back to 12 thumbnails.
- Press **OK** when setting is complete.
- The menu shown on the right is displayed. To print, select **Start print** and press **OK**. Choose **Cancel** and press **OK** to return to the print menu.

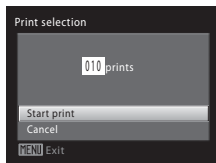

##### Print all images

All images saved in the internal memory, or on the memory card, are printed one at a time.

- The menu shown on the right is displayed. To print, select **Start print** and press **OK**. Choose **Cancel** and press **OK** to return to the print menu.

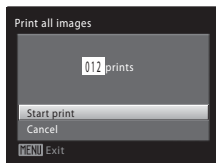

## DPOF printing

Print images for which a print order was created in **Print set** (64).

- The menu shown on the right is displayed. To print, select **Start print** and press **OK**. Choose **Cancel** and press **OK** to return to the print menu.
- To view the current print order, choose **View images** and press **OK**. To print images, press **OK** again.

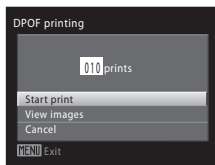

## 5 Printing starts.

- Monitor display returns to the print menu (step 2) when printing is complete.
- To cancel before all copies have been printed, press **OK**.

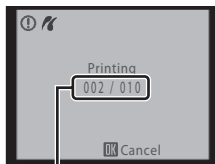

Current print/ total number of prints

## Paper Size





The camera supports the following paper sizes: **Default** (the default paper size for the current printer), **3.5 x 5 in.**, **5 x 7 in.**, **100 x 150 mm**, **4 x 6 in.**, **8 x 10 in.**, **Letter**, **A3**, and **A4**. Only sizes supported by the current printer will be displayed. To specify paper size using printer settings, choose **Default** in the paper size menu.

## Setup Menu

The setup menu contains the following options.

	<b>Menus</b> <span style="float: right;">📖 96</span>
	Select how menus are displayed.
	<b>Welcome screen</b> <span style="float: right;">📖 97</span>
	Specify the welcome screen displayed when the camera is turned on.
	<b>Date</b> <span style="float: right;">📖 98</span>
	Set camera clock and choose home and destination time zones.
	<b>Monitor settings</b> <span style="float: right;">📖 101</span>
	Adjust photo info, image review, and brightness settings.
	<b>Date imprint</b> <span style="float: right;">📖 103</span>
	Imprint date on images.
	<b>Vibration reduction</b> <span style="float: right;">📖 104</span>
	Specify the vibration reduction setting for shooting still images.
	<b>Motion detection</b> <span style="float: right;">📖 105</span>
	Specify whether or not motion detection is used to reduce the effects of subject movement and camera shake when taking still images.
	<b>AF assist</b> <span style="float: right;">📖 106</span>
	Enable or disable AF-assist illuminator.
	<b>Sound settings</b> <span style="float: right;">📖 107</span>
	Specify sound settings.
	<b>Auto off</b> <span style="float: right;">📖 108</span>
	Set time before camera enters standby mode to save power.
	<b>Format memory/Format card</b> <span style="float: right;">📖 109</span>
	Format internal memory or memory card.
	<b>Language</b> <span style="float: right;">📖 110</span>
	Choose the language used for camera monitor display.
	<b>TV settings</b> <span style="float: right;">📖 110</span>
	Adjust settings for connection to a television.
	<b>Blink warning</b> <span style="float: right;">📖 111</span>
	Set whether or not to detect human subjects with eyes closed when shooting pictures using face detection.
	<b>Reset all</b> <span style="float: right;">📖 112</span>
	Restore camera settings to default values.
	<b>Battery type</b> <span style="float: right;">📖 114</span>
	Select the type of batteries used.

## Setup Menu

	<b>Protect</b> <span style="float: right;">📖 114</span>
	Protect selected images from accidental deletion.
	<b>Rotate image</b> <span style="float: right;">📖 115</span>
	Change the orientation of an image.
	<b>Copy</b> <span style="float: right;">📖 116</span>
	Copy files between memory card and internal memory.
	<b>Firmware version</b> <span style="float: right;">📖 117</span>
	Display camera firmware version.

## Displaying the Setup Menu

### 1 Press **MENU**.

The menu is displayed.

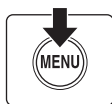

- When using easy auto mode, scene mode, or smart portrait mode, press the multi selector (📖 11) ◀ to display the tabs.

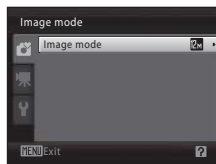

### 2 Press the multi selector ◀.

- You can now select a tab.

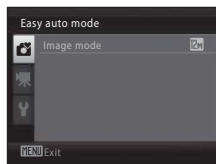

### 3 Press ▲ or ▼ to select the **Y** tab.

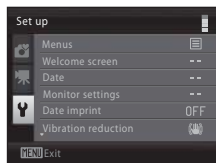

**4** Press **▶** or **OK**.

- You can now select an item from the setup menu.
- Use the multi selector to choose and apply settings (📖 11).
- To exit the setup menu, press **MENU** or press **◀** and select another tab.

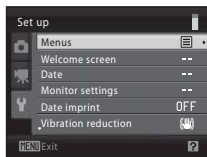

## **Menus**

Press the MENU button →  (Setup menu) (📖 94) →  Menus

Select how menus are displayed.

### **Text (default setting)**

Menus are displayed in list format.

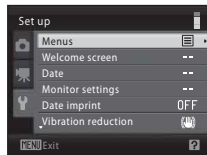

### **Icons**

All menu items can be displayed in a single page.

### Menu names



## Welcome Screen

Press the MENU button →  (Setup menu) (📖 94) →  Welcome screen

Specify the welcome screen displayed when the camera is turned on.

### None (default setting)

The welcome screen is not displayed when the camera is turned on; the shooting mode or playback mode screen is displayed.

### COOLPIX

The welcome screen is displayed when the camera is turned on, then the shooting mode or playback mode screen is displayed.

### Select an image

An image captured with this camera is used as the welcome screen. When the image selection screen is displayed (📖 68), select the desired image and press  to register the image as the welcome screen.

- As the selected image is saved in the camera, the image is displayed in the welcome screen even if the original image is deleted.
- Images captured with an **Image mode** (📖 51) setting of  **3968×2232** or  **1920×1080**, and image copies created using small picture (📖 71) or crop (📖 72) that are 320×240 or smaller, cannot be selected.

## Date







Press the **MENU** button →  (Setup menu) ( 94) →  Date

Set the camera clock.



### Date

Set camera clock to current date and time.

Use the multi selector to set the date and time.

- Highlight an item (day, month, year, hour, minute, and the order in which day, month, and year are displayed): Press  or .
- Edit the highlighted item: Press  or .
- Finish setting: After selecting the order in which the day, month, and year are displayed, press  ( 11).

### Time zone

Set the home () time zone (district) or daylight saving time. When the destination () time zone is selected, the time difference ( 100) is automatically calculated and the date and time in the selected region are saved. This can be useful when travelling.

## Setting Travel Destination Time Zone

- 1 Use the multi selector to choose **Time zone** and press .

The Time zone menu is displayed.

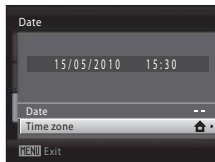

- 2 Choose  **Travel destination** and press .

The date and time displayed in the monitor changes according to the region currently selected.

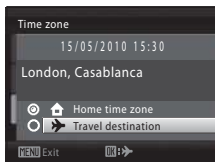

### 3 Press ►.

The new city time zone menu is displayed.

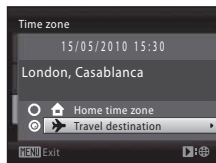

### 4 Press ◀ or ▶ to select the travel destination time zone (city name).

To use the camera in an area where daylight saving time is in effect, press ▲ to display the ☀ mark at the top of the monitor and set the daylight saving time. When the daylight saving time goes into effect, the clock is automatically advanced one hour. To turn off the daylight saving time setting, press ▼.

Press OK to enter the travel destination.

While the travel destination time zone is selected, the 📍 icon will be displayed in the monitor when the camera is in shooting mode.



## ✓ The Clock Battery

The camera's clock is powered by a clock battery that is independent of the batteries that powers the camera. The clock battery charges when the main batteries are installed or an AC adapter is connected, and can provide several days of backup power after about 10 hours of charging.

### 📌 🏠 (Home Time Zone)

- To switch to the home time zone, choose 🏠 **Home** in step 2 and press OK.
- To change the home time zone, choose 🏠 **Home** in step 2 and perform steps 3 and 4, to set the home time zone.

### 📌 ⌚ Daylight Saving Time

When the summer saving time begins or ends, turn the daylight saving time option on or off using the home time zone display in Step 4.

### 📌 📅 Imprinting the date on pictures

After setting the date and time, set the **Date imprint** setting (📖 103) in the setup menu. Once **Date imprint** is set, the shooting date and time can be imprinted on the image data when taking pictures.

## Setup Menu





### Time Zones

The camera supports the time zones listed below.

For time zones not listed below, set the camera's clock manually to local time using **Date** in the setup menu.

UTC +/-	Time zone	UTC +/-	Time zone
-11	Midway, Samoa	+1	Madrid, Paris, Berlin
-10	Hawaii, Tahiti	+2	Athens, Helsinki, Ankara
-9	Alaska, Anchorage	+3	Moscow, Nairobi, Riyadh, Kuwait, Manama
-8	PST (PDT): Los Angeles, Seattle, Vancouver	+4	Abu Dhabi, Dubai
-7	MST (MDT): Denver, Phoenix, La Paz	+5	Islamabad, Karachi
-6	CST (CDT): Chicago, Houston, Mexico City	+5.5	New Delhi
-5	EST (EDT): New York, Toronto, Lima	+6	Colombo, Dhaka
-4.5	Caracas	+7	Bangkok, Jakarta
-4	Manaus	+8	Beijing, Hong Kong, Singapore
-3	Buenos Aires, Sao Paulo	+9	Tokyo, Seoul
-2	Fernando de Noronha	+10	Sydney, Guam
-1	Azores	+11	New Caledonia
±0	London, Casablanca	+12	Auckland, Fiji

## Monitor Settings

Press the **MENU** button →  (Setup menu) ( 94) →  Monitor settings

The following settings are available.

### Photo info

Choose information displayed in the monitor during shooting and playback mode. ( 102)

### Image review

- **On** (default setting): Images are automatically displayed briefly immediately after shooting.
- **Off**: Images are not displayed after shooting.









### Brightness

Choose from five settings for monitor brightness. The default setting is **3**.

## Photo Info

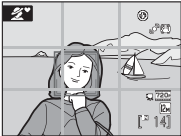
Select whether or not photo info is displayed.

See “The Monitor” (📖 8, 9) for information on indicators in the monitor.

	Shooting mode	Playback mode
Show info		
Auto info (default setting)	The same information as in <b>Show info</b> is displayed. If no operations are performed after a few seconds, the display will be the same as <b>Hide info</b> . The information is displayed again when an operation is performed.	
Hide info		
Framing grid	 <p>In the following shooting modes, a framing grid is displayed to help frame pictures, in addition to the information displayed in <b>Auto info</b>.</p> <ul style="list-style-type: none"> <li>•  (Easy auto)</li> <li>•  (Auto)</li> </ul> <p>In other shooting modes, the same information as in <b>Auto info</b> is displayed.</p>	 <p>The same information as in <b>Auto info</b> is displayed.</p>

## **DATE** Date Imprint

Press the **MENU** button → **Y** (Setup menu) (📖 94) → **DATE** Date imprint

The shooting date and time can be imprinted in images at the time of shooting. This information can be printed even from printers that do not support printing of date and time (📖 65).



### Off (default setting)

Date and time are not imprinted on images.

### **DATE** Date

The shooting date is imprinted in images.

### **DATE** Date and time

The shooting date and time is imprinted in images.

At settings other than **Off**, the icon for the current setting is displayed in the monitor (📖 8).

## **✓** Date imprint

- Imprinted dates form a permanent part of image data and cannot be deleted.
- Date imprint is disabled in the following situations.
  - When using the **Museum** or **Panorama assist** scene modes.
  - When using sport continuous mode.
  - When Continuous (📖 55) is set to **Continuous** or **BSS**.
  - When recording movies.
- Dates imprinted at an **Image mode** setting (📖 51) of **VGA 640×480** may be difficult to read. Select **PC 1024×768** or larger when using date imprint.
- The date is saved using the format selected in the setup menu's **Date** item (📖 16, 98).

## **📎** Date Imprint and Print Set

When images are printed from DPOF-compatible printers that can print date and photo information, you can use **Print Set** (📖 64) and print the shooting date and photo information on the images. In such a case, it is unnecessary to imprint date and time on images beforehand using **Date Imprint**.

## Vibration Reduction

Press the MENU button →  (Setup menu) (📖 94) →  Vibration reduction

Specify the vibration reduction setting for shooting still images. Vibration reduction effectively corrects blur that commonly occurs when shooting with zooming or at slow shutter speeds. Set vibration reduction to **Off** when using a tripod to stabilize the camera during shooting.

### On (hybrid)

Image-sensor shift vibration reduction reduces the effects of camera shake. Additionally, electronic vibration reduction is used to process images and remove the effects of camera shake in the following situations.

- When the flash does not fire
- When a shutter speed slower than 1/60 seconds is used
- When **Self-timer** is disabled
- When **Continuous** is set to **Single**
- When ISO sensitivity is set to 200 or less

### On (default setting)

Image-sensor shift vibration reduction reduces the effects of camera shake.

### Off

Vibration reduction is not used.

The vibration reduction setting can be confirmed in the monitor during shooting (📖 8, 21) (When it is set to **Off**, no icon is displayed).

## Notes on Vibration reduction

- Vibration reduction may take a few seconds to activate after the power is turned on, or the camera enters shooting mode from playback mode. Wait until the display stabilizes before shooting.
- Due to characteristics of the vibration reduction function, images displayed on the camera's monitor immediately after shooting may appear blurry.
- Vibration reduction may be unable to completely eliminate the effects of camera shaking in some situations.
- When set to **On (hybrid)**, electronic vibration reduction may not reduce the effects of camera shake if the amount of vibration is very small or very large.
- When set to **On (hybrid)**, electronic vibration reduction does not function if shutter speed is fast or very slow.
- When set to **On (hybrid)**, the camera automatically releases the shutter two times for each shot and processes the image, therefore it takes more time to save captured images. The **Shutter sound** (📖 107) will be heard only once. Only one image is saved.

## Using Vibration Reduction with Movies

When recording movies, electronic vibration reduction is used automatically to reduce the effects of camera shake.

## Motion Detection



Press the **MENU** button →  (Setup menu) (📖 94) →  Motion detection

Specify whether or not motion detection is used to reduce the effects of subject movement and camera shake when taking still pictures.

### Auto (default setting)

When the camera detects subject movement or camera shake, the ISO sensitivity and shutter speed are automatically increased to reduce blurring.

Note that motion detection is not active in the following situations:

- When the flash is set to  (fill flash)
- When the **ISO sensitivity** option (📖 56) is set fixed at a particular value in  (auto) mode
- When using **Multi-shot 16** (📖 55)
- In the following scene modes: **Night portrait** (📖 37), **Dusk/dawn** (📖 38), **Night landscape** (📖 39), **Museum** (📖 40), **Backlight** (📖 41)
- When using Sport Continuous mode (📖 46)

### Off

Motion detection is not enabled.

The motion detection setting can be confirmed in the monitor during shooting (📖 21).

When the camera detects shaking and increases shutter speed, the motion detection indicator turns green. When set to **Off**, no icon is displayed.

## Notes on Motion detection

- Blurring caused by camera shake or subject movement may not be eliminated depending on shooting conditions.
- Motion detection may not function if the subject exhibits significant movement or is too dark.
- The images taken may become somewhat grainy.

## AF Assist

Press the MENU button →  (Setup menu) ( 94) →  AF assist

Specify whether or not the AF-assist illuminator is used to help the camera focus when the subject is poorly lit.

### Auto (default setting)



AF-assist illuminator will be used to assist the focus operation when the subject is poorly lit. The illuminator has a range of about 4.0 m (13 ft.) at the maximum wide-angle position and 3.0 m (9 ft. 10 in.) at the maximum telephoto position.

However, the AF-assist illumination will not turn on in some scene modes even if **Auto** is selected ( 36-40).

### Off

Disable this function. The camera may be unable to focus if lighting is poor.

## 🔊 Sound Settings

Press the MENU button →  (Setup menu) ( 94) → 🔊 Sound settings

Specify sound settings.

### Button sound

Turn the button sound **On** or **Off**. When **On** (default setting) is selected, a beep will sound once when operations are completed successfully, twice when the focus has been locked, and three times when an error is detected, and Start-up sound will also play when the camera is turned on.

### Shutter sound

Choose shutter sound from **On** (default setting) or **Off**.

Note that even when set to **On**, the shutter sound will not be heard in the following situations.

- When **Continuous** is set to **Continuous**, **BSS**, or **Multi-shot 16**
- When scene mode is set to **Museum**
- When using sport continuous

## Auto Off

Press the MENU button →  (Setup menu) ( 94) →  Auto off

When the camera is on and a period of time passes without any operations, the camera will enter standby mode ( 15) to save power.

Once the camera has entered standby mode, the power-on lamp will blink. If no operations are performed for another three minutes, the camera will turn off.

Use this option to set time before camera enters standby mode.

### Auto off

Choose the time allowed to elapse before the camera enters standby mode if no operations are performed from **30 s** (default setting), **1 min**, **5 min**, and **30 min**.

### Sleep mode

If **On** (default setting) is selected, the camera will enter standby mode when there is no change in the brightness of the subject, even before the time selected in the auto off menu has elapsed. The camera will enter sleep mode after 30 seconds when **Auto off** is set to **1 min** or less, or after 1 minute when **Auto off** is set to **5 min** or more.



## Notes on Auto Off

The time allowed to elapse before the camera enters standby mode is fixed in the following cases:

- While menus are displayed: 3 minutes
- While slide show is in progress: Up to 30 minutes

## Exiting Standby Mode

Press one of the following buttons to exit standby mode.

- Power switch
- Shutter-release button
-  button
-  button
-  (movie-record) button

## Format Memory/ Format Card

Press the MENU button →  (Setup menu) ( 94) →  Format memory/ Format card

Use this option to format the internal memory or a memory card.

### Formatting internal memory

To format the internal memory, remove the memory card from the camera.

The **Format memory** option is displayed in the setup menu.

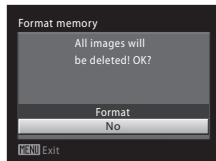

### Formatting a Memory Card

When the memory card is inserted into the camera, the **Format card** option is displayed in the setup menu.

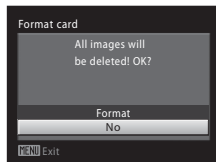

## Formatting Internal Memory and Memory Cards

- Formatting the internal memory or memory cards **permanently deletes all data**. Be sure to transfer important images to a computer before formatting.
- Do not turn the camera off or open the battery-chamber/memory card slot cover during formatting.
- The first time you insert the memory cards used in other devices into this camera, be sure to format them using this camera.

## Language



Press the MENU button →  (Setup menu) (📖 94) →  Language

Select one of 24 languages for display of camera menus and messages.

Čeština	Czech
Dansk	Danish
Deutsch	German
English	(default setting)
Español	Spanish
Ελληνικά	Greek
Français	French
Indonesia	Indonesian
Italiano	Italian
Magyar	Hungarian
Nederlands	Dutch
Norsk	Norwegian

Polski	Polish
Português	Portuguese
Русский	Russian
Suomi	Finnish
Svenska	Swedish
Türkçe	Turkish
عربي	Arabic
简体中文	Simplified Chinese
繁體中文	Traditional Chinese
日本語	Japanese
한글	Korean
ภาษาไทย	Thai

## TV Settings

Press the MENU button →  (Setup menu) (📖 94) →  TV settings

Adjust settings for connection to a television.



### Video mode

Choose from **NTSC** and **PAL**.

### HDMI

Select the HDMI output image resolution from **Auto** (default setting), **480p**, **720p**, and **1080i**. When set to **Auto**, the resolution is automatically set to **480p**, **720p**, or **1080i** according to high-definition television that is connected to the camera.

## Blink Warning

Press the MENU button →  (Setup menu) (📖 94) →  Blink warning

Set whether or not to detect human subjects with eyes closed when shooting pictures using face detection (📖 24) in the following situations.

-  (Easy auto) mode
- **Portrait** (📖 36) or **Night portrait** (📖 37) scene modes

### On

When the camera detects that one or more human subjects have closed their eyes shortly after detecting the faces and shooting them, the **Did someone blink?** screen will be displayed in the monitor. The face of the human subject that may have closed his/her eyes is framed by a yellow border. In such a case, you can check the shot picture and determine if you take the picture again.  
→ “Operating the Did someone blink? Screen”

### Off (default setting)











Blink warning does not take effect.

## Operating the Did someone blink? Screen

The following operations are available when the **Did someone blink?** screen is displayed.

If no operations are performed for a few seconds, the screen automatically returns to the shooting mode screen.



To	Use	Description
Enlarge and display the face of the person who blinked	<b>T</b> 	Rotate the zoom control to <b>T</b>  .
Switch to full-frame playback	<b>W</b> 	Rotate the zoom control to <b>W</b>  .
Select the face to be displayed		If the camera detects more than one human subjects with their eyes closed, press <b>▲▼◀▶</b> during the enlarged display to switch over the face displayed.
Delete the shot image		Press  .
Return to shooting mode		Press  or the shutter-release button.
		

## Reset All

Press the MENU button →  (Setup menu) (📖 94) →  Reset all

When **Reset** is selected, the camera's settings will be restored to their default values.

### Pop-up Menu

Option	Default value
Flash mode (📖 29)	Auto
Self-timer (📖 32)	Off
Macro mode (📖 49)	Off
Exposure compensation (📖 33)	0.0

### Scene Mode

Option	Default value
Scene mode (📖 35)	Portrait
Hue adjustment in food mode (📖 40)	Center

### Sport Continuous Menu

Option	Default value
Sport continuous (📖 46)	Continuous H
Image mode (📖 51)	 2048x1536

### Shooting Menu

Option	Default value
Image mode (📖 51)	 4000x3000
White balance (📖 53)	Auto
Continuous (📖 55)	Single
ISO sensitivity (📖 56)	Auto
Color options (📖 57)	Standard color

### Movie Menu

Option	Default value
Movie options (📖 77)	HD 720p (1280x720)
Autofocus mode (📖 78)	Single AF
Wind noise reduction (📖 78)	Off

## Setup Menu

Option	Default value
Menus (📖 96)	Text
Welcome screen (📖 97)	None
Photo info (📖 101)	Auto info
Image review (📖 101)	On
Brightness (📖 101)	3
Date imprint (📖 103)	Off
Vibration reduction (📖 104)	On
Motion detection (📖 105)	Auto
AF assist (📖 106)	Auto
Button sound (📖 107)	On
Shutter sound (📖 107)	On
Auto off (📖 108)	30 s
Sleep mode (📖 108)	On
HDMI (📖 110)	Auto
Blink warning (📖 111)	Off

## Others

Option	Default value
Paper size (📖 89, 90)	Default

- Choosing **Reset all** also clears the current file number (📖 123) from the memory. Numbering will continue from the lowest number available. To reset file numbering to "0001", delete all images (📖 67) before selecting **Reset all**.
- The following settings in the menus will remain unaffected even if **Reset all** is performed.



Shooting menu:

Preset manual in the **White balance** menu (📖 54)

Setup menu:

Settings for image registered for **Welcome screen** (📖 97), **Date** (📖 98), **Language** (📖 110), **Video mode** (📖 110), and **Battery type** (📖 114)

## Battery Type

Press the MENU button →  (Setup menu) ( 94) →  Battery type

To ensure that the camera shows the correct battery level ( 20), choose the type that matches the batteries currently in use.

Alkaline	LR6/L40 (AA-size) alkaline batteries
COOLPIX (Ni-MH)	Nikon EN-MH2 rechargeable Ni-MH (nickel metal hydride) batteries
Lithium (default setting)	FR6/L91 (AA-size) lithium batteries

## Protect



Press the MENU button →  (Setup menu) ( 94) →  Protect

Protect selected images from accidental deletion. Use the image selection screen to turn protection on and off for selected images (see “Selecting Multiple Images” ( 68) for more information).

Note, however, that formatting the camera’s internal memory or the memory card will permanently erase protected files ( 109).

Protected images can be identified by the  icon ( 9, 60) in playback mode.

## Rotate Image

Press the MENU button →  (Setup menu) (📖 94) →  Rotate image

Set the image orientation (vertical or horizontal frame) displayed on the camera monitor after the pictures are taken.

Images can be rotated 90° clockwise or counterclockwise.

Images that were saved in the portrait (vertical) orientation can be rotated up to 180° in either direction.

Select images on the image selection screen (📖 68) to display the image rotation screen. Press the multi selector ◀ or ▶ to rotate the image 90°.

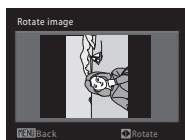

Rotate 90°  
counterclockwise



Rotate 90°  
clockwise

Press  to select the displayed direction and the vertical / horizontal position data will be saved on the image.

## Copy: Copying Between Memory Card and Internal Memory

Press the MENU button →  (Setup menu) ( 94) →  Copy

Copy images between the internal memory and a memory card.

- 1 Select an option from the copy screen using the multi selector and press .

 → : Copy images from internal memory to memory card.

 → : Copy images from memory card to internal memory.

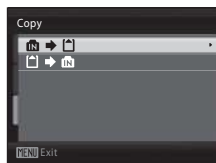



- 2 Choose the copy option and press .

**Selected images:** Copy images selected from the image selection screen ( 68).

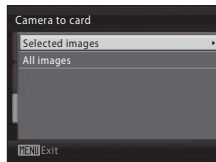
**All images:** Copy all images.



### Notes on Copy

- JPEG- and MOV-format files can be copied. Files saved in any other format cannot be copied.
- Images taken with another make of camera or that have been modified on a computer cannot be copied.
- When copying images for which Print set ( 114) options are enabled, the print set settings are not copied. However, when copying pictures for which Protect ( 64) is enabled, the protect setting is copied.

### More Information

See "Image File and Folder Names" ( 123) for more information.

## Ver. Firmware Version

Press the **MENU** button → **Y** (Setup menu) (📖 94) → **Ver.** Firmware version

View the current camera firmware version.

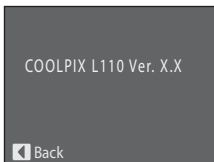

### Caring for the Camera

To ensure continued enjoyment of this Nikon product, observe the following precautions when using or storing the device:

**✔ Keep dry**

The device will be damaged if immersed in water or subjected to high humidity.

**✔ Do not drop**

The product may malfunction if subjected to strong shock or vibration.

**✔ Handle the lens and all moving parts with care**

Do not apply force to the lens, monitor, memory card slot or battery chamber. These parts are easily damaged. Applying force to the lens cover could result in camera malfunction or damage to the lens. Should the monitor break, care should be taken to avoid injury caused by broken glass and to prevent the liquid crystal from the display touching the skin or entering the eyes or mouth.

**✔ Do not point the lens at strong light sources for extended periods**

Avoid pointing the lens at the sun or other strong light sources for extended periods when using or storing the camera. Intense light may cause deterioration of the image sensor, producing a white blur effect in photographs.

**✔ Keep away from strong magnetic fields**

Do not use or save this device in the vicinity of equipment that generates strong electromagnetic radiation or magnetic fields. Strong static charges or the magnetic fields produced by equipment such as radio transmitters could interfere with the monitor, damage data saved on the memory card, or affect the product's internal circuitry.

**✔ Avoid sudden changes in temperature**

Sudden changes in temperature, such as when entering or leaving a heated building on a cold day, can cause condensation to form inside the device. To prevent condensation, place the device in a carrying case or a plastic bag before exposing it to sudden changes in temperature.

**✔ Turn the product off before removing or disconnecting the power source**

Do not remove the battery while the product is on, or while images are being saved or deleted. Forcibly cutting power in these circumstances could result in loss of data or in damage to product memory or internal circuitry.

 **The Battery**

- After purchasing replacement rechargeable batteries, charge them before use. They are not fully charged at the time of purchase.  
Be sure to read and follow the information found in “Optional Accessories” (📖 122) and in the documentation included with the Battery Charger MH-73 (available separately).
- Check the battery level when taking the camera out, and replace the batteries if necessary (📖 20). If possible, carry spare batteries when taking pictures on important occasions.
- Battery capacity tends to decrease on cold days. Be sure that the batteries are fresh before heading outside to take pictures in cold weather. Keep spare batteries in a warm place and exchange as necessary. Once warmed, a cold battery may recover some of its charge.
- Dirt on the battery terminals can prevent the camera from functioning.
- Used batteries are a valuable resource. Please recycle used batteries in accordance with local regulations.

## Cleaning

<b>Lens</b>	Avoid touching glass parts with your fingers. Remove dust or lint with a blower (typically a small device with a rubber bulb attached to one end that is pumped to produce a stream of air out the other end). To remove fingerprints or other stains that cannot be removed with a blower, wipe the lens with a soft cloth, using a spiral motion that starts at the center of the lens and working toward the edges. If this fails, clean the lens using a cloth lightly dampened with commercial lens cleaner.
<b>Monitor</b>	Remove dust or lint with a blower. To remove fingerprints and other stains, clean the monitor with a soft, dry cloth, being careful not to apply pressure.
<b>Body</b>	Use a blower to remove dust, dirt or sand, then wipe gently with a soft, dry cloth. After using the camera at the beach or seaside, wipe off any sand or salt with a dry cloth lightly dampened with fresh water, then dry thoroughly. Note that foreign matter inside the camera could cause damage not covered by the warranty.

Do not use alcohol, thinner, or other volatile chemicals.

## Storage

Turn the camera off when not in use. Check that the power-on lamp is off before putting the camera away. Remove the battery if the camera will not be used for an extended period. Do not store the camera with naphtha or camphor moth balls, or in any of the following locations:

- Next to equipment that produces strong electromagnetic fields, such as televisions or radios
- Exposed to temperatures below  $-10^{\circ}\text{C}$  ( $14^{\circ}\text{F}$ ) or above  $50^{\circ}\text{C}$  ( $122^{\circ}\text{F}$ )
- Poorly ventilated or subject to humidities of over 60%

To prevent mold or mildew, take the camera out of storage at least once a month. Turn the camera on and release the shutter a few times before putting the camera away again.



### Notes on the Monitor

- The monitor may contain a few pixels that are always lit or that do not light. This is a characteristic common to all TFT LCD displays, and does not indicate a malfunction. Images saved using the product will not be affected.
- When framing bright subjects, vertical comet-like streaks that whiten toward either end may appear in the display. This phenomenon, known as “smear”, does not indicate a malfunction. In shooting modes other than Sport continuous mode, Multi-shot 16 and movie mode, smear has no effect on the images that are saved.
- Images in the monitor may be difficult to see under bright lighting.
- The monitor is lit by an LED backlight. Should the monitor begin to dim or flicker, contact your Nikon-authorized service representative.



### Notes on Smear

White or colored streaks may be visible when bright subjects are framed in the monitor. This phenomenon, known as “smear,” occurs when extremely bright light strikes the image sensor; it is characteristic of image sensors and does not indicate a malfunction. Smear may also take the form of partial discoloration in the monitor during shooting. It does not appear in images recorded with the camera except in the cases of movies and of images recorded with **Multi-shot 16** selected for **Continuous**. When shooting in these modes, we recommend that you avoid bright subjects such as the sun, reflected sunlight, and electric lights.

## Optional Accessories

Battery charger/ Rechargeable batteries*	<ul style="list-style-type: none"> <li>Battery Charger MH-73 (includes four EN-MH2 rechargeable Ni-MH batteries)</li> <li>Replacement rechargeable batteries: Rechargeable Ni-MH batteries EN-MH2-B4 (set of four EN-MH2 batteries)</li> </ul>
AC adapter	AC Adapter EH-67
USB cable	USB Cable UC-E6
AV cable	Audio Video Cable EG-CP14
Lens cap	Lens Cap LC-CP20

\* When using with the COOLPIX L110, charge the four EN-MH2 rechargeable Ni-MH batteries at a time using Battery Charger MH-73. Also, do not mix batteries that have a different amount of charge remaining (🔋 119). EN-MH1 rechargeable Ni-MH batteries cannot be used.

## Approved Memory Cards

The following Secure Digital (SD) memory cards have been tested and approved for use in this camera.

Memory cards with an SD Speed Class (\*1) rating of class 6 or faster are recommended for recording movies. Movie recording may stop unexpectedly when memory cards with a lower Speed Class rating are used.

SanDisk	2 GB*2, 4 GB*3, 8 GB*3, 16 GB*3, 32 GB*3
TOSHIBA	2 GB*2, 4 GB*3, 8 GB*3, 16 GB*3, 32 GB*3
Panasonic	2 GB*2, 4 GB*3, 8 GB*3, 12 GB*3, 16 GB*3, 32 GB*3
Lexar	2 GB*2, 4 GB*3, 8 GB*3

\*1 A standard for defining the read/write speed of SD and SDHC memory cards.

\*2 If the memory card will be used with a card reader or similar device, check that device supports 2 GB cards.



\*3  SDHC-compliant. If the memory card will be used with a card reader or similar device, check that device supports SDHC.

Contact the manufacturer for details on the above cards.

## Image File and Folder Names

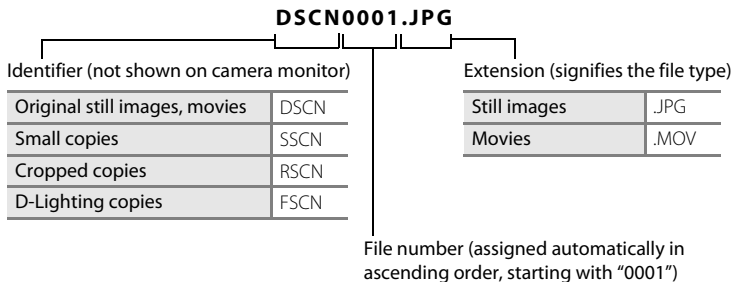









Images and movies are assigned file names as follows.





- Files are saved in folders named with a folder number followed by a five-character identifier: "P\_" plus a three-digit sequence number for images taken using panorama assist (e.g. "101P\_001";  42) and "NIKON" for all other images (e.g. "100NIKON"). When the number of files within a folder reaches 9999, a new folder will be created. File numbers will be assigned automatically starting with "0001".
- Files copied using **Copy > Selected images** are copied to the current folder, where they are assigned new file numbers in ascending order starting from the largest file number in memory. **Copy > All images** copies all folders from the source medium; file names do not change but new folder numbers are assigned in ascending order, starting from the largest folder number on the destination medium ( 116).
- Folders can hold up to 200 images; if an image is taken when the current folder contains 200 images, a new folder will be created by adding one to the current folder number. If an image is taken when the current folder is numbered 999 and contains 200 images or an image numbered 9999, no further images can be taken until the medium is formatted ( 109) or a new memory card inserted.

## Error Messages

















The following table lists the error messages and other warnings displayed in the monitor, as well as the solutions for dealing with them.

Display	Problem	Solution	
 (blinks)	Clock not set.	Set clock.	98
	Battery running low.	Prepare to replace batteries.	14, 114
 Battery exhausted.	Battery exhausted.	Replace batteries.	
 Battery temperature high	Battery temperature is high.	Turn off camera, and allow battery to cool down before resuming use. After 5 seconds, this message will disappear, the monitor will turn off, and the power-on lamp and flash lamp will blink rapidly. After the lamps blink for three minutes, the camera will turn off automatically. Pressing the power switch also turns off the camera.	14
 (blinks red)	Camera cannot focus.	<ul style="list-style-type: none"> <li>• Refocus.</li> <li>• Use focus lock.</li> </ul>	24, 25, 48
 Please wait for the camera to finish recording.	Camera cannot perform other operations until saving is complete.	Wait until message clears from display automatically when saving is complete.	25
 Memory card is write protected.	Write-protect switch is in "lock" position.	Slide write-protect switch to "write" position.	19
 This card cannot be used.	Error accessing memory card.	<ul style="list-style-type: none"> <li>• Use approved card.</li> <li>• Check that connectors are clean.</li> <li>• Confirm that memory card is correctly inserted.</li> </ul>	122
 This card cannot be read.			18
			18

Display	Problem	Solution	
<p><b>i</b> Card is not formatted. Format card?</p> <p>Yes No</p>	Memory card has not been formatted for use in COOLPIX L110.	All data saved on the memory card will be deleted. If there is any data on the card that you want to keep, select <b>No</b> , and backup the data to a computer before formatting the memory card. To format the memory card, select <b>Yes</b> and press <b>OK</b> .	19
<p><b>i</b> Out of memory.</p>	Memory card is full.	<ul style="list-style-type: none"> <li>• Choose smaller image mode.</li> <li>• Delete images.</li> <li>• Insert new memory card.</li> <li>• Remove memory card and use internal memory.</li> </ul>	51 26, 67, 79 18 19
<p><b>i</b> Image cannot be saved.</p>	Error occurred while saving image.	Format internal memory or memory card.	109
	Camera has run out of file numbers.	<ul style="list-style-type: none"> <li>• Insert new memory card.</li> <li>• Format internal memory or memory card.</li> </ul>	18 109
	Image cannot be used for welcome screen.	<p>The following cannot be registered as the welcome screen.</p> <ul style="list-style-type: none"> <li>• Images reduced to 320 × 240 or smaller when edited using crop or small picture</li> <li>• Images captured at an Image mode setting of  <b>3968×2232</b> or  <b>1920×1080</b>.</li> </ul>	51, 71, 72
	There is not enough memory to copy the image.	Delete images from destination.	67
<p><b>i</b> Image cannot be modified.</p>	You are trying to edit an image that cannot be edited.	<ul style="list-style-type: none"> <li>• Confirm the editing features that can be used.</li> <li>• These options cannot be used with movies.</li> </ul>	69 –
<p><b>i</b> Cannot record movie.</p>	Time out error while recording movie.	Choose memory card with faster write speed.	18

## Error Messages

Display	Problem	Solution	
<b>i</b> Memory contains no images.	No images in the internal memory or memory card.	Remove memory card to play back images from internal memory.	116
<b>i</b> File contains no image data.	File not created with COOLPIX L110.	File cannot be viewed on this camera. View file using the computer or any other devices which was used to create or edit this file.	–
<b>i</b> This file cannot be played back.			
<b>i</b> All images are hidden.	The image cannot be played back in a slide show.	–	66
<b>i</b> This image cannot be deleted.	Image is protected.	Disable protection.	114
<b>i</b> Travel destination is in the current time zone.	Destination in same time zone as home.	–	98
<b>i</b> Raise the flash.	The built-in flash is lowered.	<ul style="list-style-type: none"> <li>• Raise the built-in flash when changing the flash mode.</li> <li>• Raise the built-in flash when shooting using the <b>Night portrait</b> and <b>Backlight</b> scene modes.</li> </ul>	6, 29 37, 41
<b>i</b> Lower the flash.	The flash is raised when recording a movie.	May hamper sound recording. Quietly lower the flash. The sound of the flash being lowered may be recorded.	73
<b>i</b> Lens error. (If the lens cap is attached, turn the camera off, remove the lens cap, and turn the camera on.)	Lens error.	Remove the lens cap if still attached, and turn camera off and then on again. If error persists, contact retailer or Nikon-authorized service representative.	20
<b>i</b> Communications error	USB cable disconnected during printing.	Turn camera off, reconnect USB cable.	88

Display	Problem	Solution	
System error 	Error has occurred in camera's internal circuitry.	Turn camera off, remove and reinsert battery, and turn camera on. If error persists, contact retailer or Nikon-authorized service representative.	14, 20
 Printer error: check printer status.	Running out of ink or printer error.	Check printer. After solving the problem, select <b>Resume</b> and press  to resume printing.*	–
 Printer error: check paper	Specified size of paper is not loaded in printer.	Load the specified paper, select <b>Resume</b> and press  to resume printing.*	–
 Printer error: paper jam	Paper has jammed in the printer.	Eject the jammed paper, select <b>Resume</b> and press  to resume printing.*	–
 Printer error: out of paper	No paper is loaded in printer.	Load the specified paper, select <b>Resume</b> and press  to resume printing.*	–
 Printer error: check ink	Ink error.	Check ink, select <b>Resume</b> and press  to resume printing.*	–
 Printer error: out of ink	Ink cartridge is empty.	Replace ink, select <b>Resume</b> and press  to resume printing.*	–
 Printer error: file corrupt	An error caused by the image file has occurred.	Select <b>Cancel</b> and press  to cancel printing.	–

\* See the documentation provided with your printer for further guidance and information.

## Troubleshooting

If the camera fails to function as expected, check the list of common problems below before consulting your retailer or Nikon-authorized service representative. Refer to the page numbers in the right-most column for more information.

### Display, Settings and Power Supply



Problem	Cause/Solution	
Monitor is blank	<ul style="list-style-type: none"><li>• Camera is off.</li><li>• Battery exhausted.</li><li>• Standby mode for saving power: press the shutter-release button halfway.</li><li>• When flash lamp blinks red, wait until flash has charged.</li><li>• Camera and computer are connected via USB cable.</li><li>• Camera and TV are connected via AV cable or HDMI cable.</li></ul>	20 20 15, 24 30 83 80
Monitor is hard to read	<ul style="list-style-type: none"><li>• Adjust monitor brightness.</li><li>• Monitor is dirty. Clean monitor.</li></ul>	101 120
Camera turns off without warning	<ul style="list-style-type: none"><li>• Battery exhausted.</li><li>• Camera has turned off automatically to save power.</li><li>• Battery is cold.</li></ul>	20 108 119
Date and time of recording are not correct	<ul style="list-style-type: none"><li>• Images taken while the clock is not set will have a time stamp of "00/00/0000 00:00"; movies will be dated "01/ 01/2010 00:00". Set the correct date and time using <b>Date</b> in the setup menu.</li><li>• Check camera clock regularly against more accurate timepieces and reset as required.</li></ul>	16 98
No indicators displayed in monitor	<b>Hide info</b> is selected for <b>Photo info</b> . Select <b>Show info</b> .	101
<b>Date imprint</b> not available	Camera clock has not been set.	16, 98
Date not being displayed on images even when <b>Date imprint</b> is enabled	<ul style="list-style-type: none"><li>• Date imprint cannot be used with the current shooting mode.</li><li>• A feature that cannot be used with date imprint is selected.</li><li>• Date imprint cannot be used when recording movies.</li></ul>	103
Camera settings reset	The clock battery is exhausted; all settings were restored to their default values.	99



Problem	Cause/Solution	
Monitor turns off, and the power-on lamp blinks rapidly.	Battery temperature is high. Turn off camera and allow battery to cool down before resuming use. After the lamps blink for three minutes, the camera will turn off automatically. Pressing the power switch also turns off the camera.	14





## Electronically Controlled Cameras

In extremely rare instances, unusual characters may appear in the monitor and the camera may stop functioning. In most cases, this phenomenon is caused by a strong external static charge. Turn the camera off, remove and replace the battery, then turn the camera on again. In the event of continued malfunction, contact your retailer or Nikon-authorized service representative. Note that disconnecting the power source as described above may result in the loss of any data not saved to internal memory or the memory card at the time the problem occurred. Data already saved will not be affected.



## Shooting

Problem	Cause/Solution	
No picture taken when shutter-release button is pressed.	<ul style="list-style-type: none"> <li>• When camera is in playback mode, press .</li> <li>• When menus are displayed, press <b>MENU</b>.</li> <li>• Battery exhausted.</li> <li>• When flash lamp blinks, flash is charging.</li> </ul>	10
		12
		20
		30
Cannot use shooting mode.	Disconnect the HDMI cable or USB cable.	80, 83, 88
Camera cannot focus.	<ul style="list-style-type: none"> <li>• The intended subject is one with which autofocus does not perform well.</li> <li>• Set <b>AF assist</b> in the setup menu to <b>Auto</b>.</li> <li>• Focus error. Turn camera off and then on again.</li> </ul>	25
		106
		20
Images are blurred.	<ul style="list-style-type: none"> <li>• Use flash.</li> <li>• Raise the ISO sensitivity.</li> <li>• Use vibration reduction and motion detection.</li> <li>• Use <b>BSS</b> (Best Shot Selector).</li> <li>• Use tripod and self-timer.</li> </ul>	29
		56
		104, 105
		55
		5, 32
Comet-like streaks that whiten toward either end appear in the monitor.	Smear may occur when the camera is aimed at a bright subject. When using multi-16, sport continuous, or when recording movies, avoid bright objects such as the sun, reflections of the sun, and electric lights.	55, 121

Problem	Cause/Solution	
Bright specks appear in images taken with flash.	Flash is reflecting off particles in air. Lower the built-in flash or set flash mode to  (Off).	6, 29
Flash does not fire.	<ul style="list-style-type: none"> <li>• The built-in flash is lowered, or flash mode is set to  (Off).</li> <li>• Some scene modes that cannot turn on flash are selected.</li> <li>• Sport continuous mode is selected.</li> <li>• A feature that cannot be used with the flash is selected.</li> </ul>	6, 29 35 46 58
Digital zoom cannot be used.	Digital zoom cannot be used in the following situations. <ul style="list-style-type: none"> <li>• When <b>Portrait</b> or <b>Night portrait</b> is selected for Scene mode.</li> <li>• When smart portrait mode is selected.</li> <li>• When <b>Multi-shot 16</b> is selected for <b>Continuous</b>.</li> <li>• When recording movies</li> </ul>	36, 37 44 55 73
<b>Image mode</b> not available.	<ul style="list-style-type: none"> <li>• A feature that cannot be used with image mode is selected.</li> <li>• Available image modes differ according to the current shooting mode.</li> </ul>	58 51
No sound when shutter is released.	<ul style="list-style-type: none"> <li>• <b>Off</b> is selected for <b>Sound settings &gt; Shutter sound</b> in setup menu.</li> <li>• Do not block the speaker.</li> </ul>	107 4
AF-assist illuminator does not light.	<ul style="list-style-type: none"> <li>• <b>Off</b> is selected for <b>AF assist</b> option in camera setup menu.</li> <li>• AF-assist illuminator turns off automatically in some scene modes.</li> </ul>	106 36-41
Images appear smeared.	Lens is dirty. Clean lens.	120
Hues are unnatural.	White balance does not match light source.	53
Randomly spaced bright pixels ("noise") appear in image.	The subject is dark, so shutter speed is too slow or ISO sensitivity is too high. <ul style="list-style-type: none"> <li>• Noise can be reduced by using flash.</li> <li>• Select a lower ISO sensitivity.</li> </ul>	29 56
Images are too dark (underexposed).	<ul style="list-style-type: none"> <li>• The built-in flash is lowered, or flash mode is set to  (Off).</li> <li>• Flash window is blocked.</li> <li>• Subject is beyond flash range.</li> <li>• Adjust exposure compensation.</li> <li>• Raise the ISO sensitivity.</li> <li>• Subject is backlit. Select the <b>Backlight</b> scene mode, or set the flash mode to .</li> </ul>	6, 29 22 29 33 56 29, 41

Problem	Cause/Solution	
Images are too bright (overexposed).	Adjust exposure compensation.	33
Unexpected results when flash set to  (auto with red-eye reduction).	When taking pictures with  (auto with red-eye reduction), or when taking pictures with Night portrait (either in easy auto mode or the Night portrait scene mode) and the fill flash with slow sync and red-eye reduction is used, red-eye reduction may be applied, in rare cases, to areas not affected by red-eye. Use auto mode or any scene mode other than <b>Night portrait</b> , and change the flash mode to any setting other than  (auto with red-eye reduction) and try shooting again.	28, 29, 37

## Playback

Problem	Cause/Solution	
File cannot be played back.	<ul style="list-style-type: none"> <li>File was overwritten or renamed by computer or other make of camera.</li> <li>Only movies recorded with COOLPIX L110 can be played back.</li> </ul>	– 79
Cannot zoom in on images.	Playback zoom cannot be used with movies, small pictures, or images that have been cropped to 320 × 240 or smaller.	–
Cannot use D-Lighting, crop, or small picture options.	<ul style="list-style-type: none"> <li>These options cannot be used with movies.</li> <li>Images taken at an <b>Image mode</b> setting of  <b>3968×2232</b> or  <b>1920×1080</b> cannot be edited.</li> <li>Select image that supports D-Lighting, crop, or small picture.</li> <li>Camera is unable to edit images taken with other cameras.</li> </ul>	79 51 69 69
Images not displayed on television.	<ul style="list-style-type: none"> <li>Select the correct <b>Video mode</b> or <b>HDMI TV settings (Setup menu &gt; TV settings)</b>.</li> <li>Memory card contains no images. Replace memory card. Remove memory card to play back images from internal memory.</li> <li>An AV cable or a USB cable is connected to the camera while an HDMI cable is also connected.</li> </ul>	110 18 81

## Troubleshooting

Problem	Cause/Solution	
Nikon Transfer does not start when camera is connected.	<ul style="list-style-type: none"> <li>• Camera is off.</li> <li>• Battery exhausted.</li> <li>• USB cable is not correctly connected.</li> <li>• Camera is not recognized by the computer.</li> <li>• Confirm system requirements.</li> <li>• Computer is not set to launch Nikon Transfer automatically. For more information about Nikon Transfer, refer to help information contained in Nikon Transfer.</li> </ul>	<p>20 20 83 – 82 –</p>
Images to be printed are not displayed.	Memory card contains no images. Replace memory card. Remove memory card to print images from internal memory.	18
Cannot select paper size with camera.	<p>Even when using a PictBridge compatible printer, paper size cannot be selected from the camera in the following situations. Use the printer to select paper size.</p> <ul style="list-style-type: none"> <li>• The printer does not support the paper sizes used by the camera.</li> <li>• The printer automatically selects the paper size.</li> </ul>	89, 90

# Specifications

## Nikon COOLPIX L110 Digital Camera

Type	Compact digital camera
Effective pixels	12.1 million
Image sensor	1/2.3-in. CCD; total pixels: 12.39 million
Lens	15× optical zoom, NIKKOR lens
Focal length	5.0-75.0mm Angle of view equivalent to that of 28-420mm lens in 35mm [135] format
f/-number	f/3.5-5.4
Construction	12 elements in 8 groups
Digital zoom	Up to 4× Angle of view equivalent to that of approx. 1680mm lens in 35mm [135] format
Vibration reduction	Combination of image-sensor shift and electronic VR (for still images) Electronic VR (movies)
Autofocus (AF)	Contrast-detect AF
Focus range (from lens)	<ul style="list-style-type: none"><li>• Approx. 50 cm (1 ft. 8 in.) to ∞ (W); approx. 1.5 m (5 ft.) to ∞ (T)</li><li>• Macro mode: 1 cm (0.4 in.) (middle zoom position) to ∞</li></ul>
Focus-area selection	Center, face detection
Monitor	7.5 cm/3-in., approx. 460k-dot, TFT LCD with anti-reflection coating and 5-level brightness adjustment
Frame coverage (shooting mode)	Approx. 97% horizontal and 97% vertical (Compared to actual picture)
Frame coverage (playback mode)	Approx. 100% horizontal and 100% vertical (Compared to actual picture)
Storage	
Media	Internal memory (Approx. 43 MB), Secure Digital (SD) memory cards
File system	DCF, Exif 2.2, and DPOF compliant
File formats	Still pictures: JPEG Movies: MOV (Video: MPEG-4 AVC/H.264, Audio: AAC, stereo)
Image size (pixels)	<ul style="list-style-type: none"><li>• 12M (High) [4000×3000★]</li><li>• 12M [4000×3000]</li><li>• 8M [3264×2448]</li><li>• 5M [2592×1944]</li><li>• 3M [2048×1536]</li><li>• PC [1024×768]</li><li>• VGA [640×480]</li><li>• 16:9 [3968×2232]</li><li>• 16:9 [1920×1080]</li></ul>
ISO sensitivity (Standard output sensitivity)	ISO 80, 100, 200, 400, 800, 1600, 3200, 6400, Auto (ISO 80-800), Sport continuous mode (ISO 640-3200)

## Specifications

<b>Exposure</b>	
<b>Metering</b>	256-segment matrix, center-weighted (when using up to 2x digital zoom), spot (digital zoom 2x or more)
<b>Exposure control</b>	Programmed auto exposure with motion detection and exposure compensation (-2.0 to +2.0 EV in steps of 1/3 EV)
<b>Range</b>  (auto) mode	[W]: 0.7 to 15.9 EV [T]: 1.9 to 17.1 EV (exposure values achieved with automatic ISO sensitivity adjustment converted to ISO 100 values)
<b>Shutter</b>	Mechanical and charge-coupled electronic shutter
<b>Speed</b>	1/1000 - 2 s, 1/8000 - 1/15 s (Sport continuous mode)
<b>Aperture</b>	Electronically-controlled ND filter (-2 AV) selection
<b>Range</b>	2 steps (f/3.5 and f/7 [W])
<b>Self-timer</b>	Approx. 10 seconds
<b>Built-in flash</b>	
<b>Range (approx.)</b> <b>(ISO sensitivity: Auto)</b>	[W]: 0.5 to 5.5 m (1 ft. 8 in. to 18 ft.) [T]: 1.5 to 3.5 m (5 ft. to 11 ft.)
<b>Flash control</b>	TTL auto flash with monitor preflashes
<b>Interface</b>	Hi-Speed USB
<b>Data transfer protocol</b>	MTP, PTP
<b>Video output</b>	Can be selected from NTSC and PAL
<b>I/O terminal</b>	Audio video output/digital I/O (USB), HDMI mini connector (HDMI output), DC input connector
<b>Supported languages</b>	Arabic, Chinese (Simplified and Traditional), Czech, Danish, Dutch, English, Finnish, French, Greek, German, Hungarian, Indonesian, Italian, Japanese, Korean, Polish, Portuguese, Norwegian, Russian, Spanish, Swedish, Thai, Turkish
<b>Power sources</b>	<ul style="list-style-type: none"><li>• Four FR6/L91 (AA-size) lithium batteries</li><li>• Four LR6/L40 (AA-size) alkaline batteries</li><li>• Four EN-MH2 rechargeable Ni-MH batteries (available separately)</li><li>• AC Adapter EH-67 (available separately)</li></ul>
<b>Number of Exposures Possible (Battery life)*</b>	Approx. 840 shots with lithium, 270 shots with alkaline, or 500 shots with EN-MH2 batteries
<b>Dimensions (W × H × D)</b>	Approx. 108.9 × 74.3 × 78.1 mm (Approx. 4.3 × 3.0 × 3.1 in.) (excluding projections)
<b>Weight</b>	Approx. 406 g (14.4 oz) (including batteries and SD memory card)
<b>Operating environment</b>	
<b>Operating temperature</b>	0 to 40°C (32 to 104°F)
<b>Humidity</b>	Less than 85% (no condensation)

- Unless otherwise stated, all figures are for a camera with fully-charged lithium batteries operated at an ambient temperature of 25°C (77°F).
- \* Based on Camera and Imaging Products Association (CIPA) standards for measuring the life of camera batteries. Measured at 23 (±2) °C (69 to 77°F); zoom adjusted with each shot, flash fired with every other shot, image mode set to  **4000×3000**. Battery life may vary depending on shooting interval and length of time menus and images are displayed. Supplied batteries are for trial use only.

## Specifications

Nikon will not be held liable for any errors this manual may contain.



















The appearance of this product and its specifications are subject to change without notice.

## Supported Standards

- **DCF:** Design Rule for Camera File System is a standard widely used in the digital camera industry to ensure compatibility among different makes of camera.
- **DPOF:** Digital Print Order Format is an industry-wide standard that allows images to be printed from print orders saved on the memory card.
- **Exif version 2.2:** This camera supports Exif (Exchangeable Image File Format for Digital Still Cameras) version 2.2, a standard that allows information saved with photographs to be used for optimal color reproduction when images are output from Exif-compliant printers.
- **PictBridge:** A standard developed cooperatively by the digital camera and printer industries, allowing photographs to be output directly to a printer without connecting the camera to a computer.

# Index

## Symbols

-  (apply selection) button 5, 11
-  (movie-record) button 5, 10
-  (Playback) button 5, 10
-  (shooting mode) button 5, 10
-  Auto mode 48
-  Delete button 5, 26, 27, 79
-  D-Lighting 70
-  Easy auto mode 28, 20
-  Exposure compensation 33
-  Flash mode 30
-  Macro mode 49
-  Playback mode 26
-  Scene mode 35
-  Self-timer 32
-  Smart portrait mode 44
-  Sport continuous mode 46
- AE/AF-L** 43
- W** button 4, 23, 59, 60, 61, 62
-  button 4, 23, 59, 60, 61, 62
- T** button 4, 13, 23, 59, 60, 61, 62
-  button 4, 23, 59, 60, 61, 62
-  button 4, 13
- MENU** button 5, 12

## A



- AC adapter 15, 122
- AF-assist illuminator 4, 25, 106
- Alkaline batteries 14, 15
- Aperture 24
- Audio-in/Video-in jack 80
- Auto flash 29
- Auto off 15, 108
- Autofocus 24, 49, 78
- Autofocus mode 78

## B

- Backlight  41
- Batteries 14, 99
- Battery level 20
- Battery type 15, 114

- Battery-chamber 5
- Battery-chamber/memory card slot cover 5, 14, 18
- Beach/snow  38
- Best Shot Selector 55
- Black-and-white 57
- Blink warning 111
- Brightness 101
- BSS 55
- Built-in flash 4, 29
- Built-in microphone 4
- Button sound 107

## C

- Calendar display 61
- Close-up  39
- Cloudy 53
- Color options 57
- Compression ratio 51
- Computer 82
- Continuous 55
- Copy 116
- Copy  41
- Crop 72
- Cyanotype 57

## D

- Date 16, 98
- Date imprint 103
- Daylight 53
- Daylight saving time 16, 99
- DC input connector 4
- DC input connector cover 4
- Delete 26, 27, 67, 79
- Digital zoom 23
- Direct print 87
- D-Lighting 69, 70
- DPOF 136
- DPOF printing 92
- DSCN 123
- Dusk/dawn  38

## E

Easy auto mode 20, 28  
EH-67 15, 122  
EN-MH2 14, 114, 119, 122  
Exposure compensation 33  
Extension 123  
Eyelet for camera strap 4

## F

File names 123  
Fill flash 29  
Firmware version 117  
Flash 29, 30  
Flash lamp 5, 30  
Fluorescent 53  
Focus 13, 24, 78  
Focus lock 25, 48  
Folder names 123  
Food  40  
Format 19, 109  
Format memory card 19, 109  
Formatting internal memory 109  
FSCN 123  
Full-frame playback mode 27  
Full-time AF 78

## H

Halfway 13  
HDMI 110  
HDMI cable 80  
HDMI input 80  
HDMI mini connector 4  
Help 13

## I

Identifier 123  
Image mode 21, 35, 51  
Image review 101  
Image size 51  
Incandescent 53  
Indicator lamp 5

Internal memory 18  
ISO sensitivity 30, 46, 56

## J

JPG 123



## L

Landscape  36  
Language 110  
Lens 4, 133  
Lithium batteries 14

## M

Macro mode 49  
Memory capacity 20  
Memory card 18, 122  
Memory card slot 5, 18  
Menus 96  
Monitor 5, 8, 120  
Monitor settings 101  
Motion detection 105  
MOV 123  
Movie menu 73, 75  
Movie playback 79  
Movie settings 77  
Multi selector 5, 11  
Multi-shot 16 55  
Museum  40



## N

Nickel metal hydride batteries 14  
Night landscape  39  
Night Portrait  37  
Nikon Transfer 83  
Number of Exposures Remaining 20, 52

## O

Off 29  
Optical zoom 23  
Optional Accessories 122

**P**

Panorama assist  41, 42  
Paper size 89, 90  
Party/indoor  37  
Photo info 101  
PictBridge 87, 136  
Playback 26, 27, 59, 60, 62, 79  
Playback button 5, 10  
Playback menu 63  
Playback zoom 62  
Portrait  36  
Power 14, 16, 20  
Power switch 4, 14, 20  
Power-on lamp 4, 14, 20  
Preset manual 54  
Print 64, 89, 90  
Print set 64  
Print Set (Date) 65  
Printer 87  
Protect 114

**R**

Recording movies button 5, 10  
Red-eye reduction 29, 31  
Replay mode 26  
Reset all 112  
Rotate image 115  
RSCN 123

**S**

Scene mode 35, 36  
Self-timer 32  
Self-timer lamp 4, 32  
Sepia 57  
Setup menu 93  
Shooting 20, 22, 24  
Shooting mode button 5, 10  
Shutter sound 107  
Shutter speed 24  
Shutter-release button 4, 24  
Single 55

Single AF 78  
Sleep Mode 108  
Slide show 66  
Slow Sync 29  
Small picture 71  
Smart portrait 44  
Sound settings 107  
Speaker 4  
Sport continuous mode 46  
SSCN 123  
Standard color 57  
Strap 7  
Sunset  38

**T**

Tabs 12  
Thumbnail playback 60  
Time zone 16, 98, 100  
Tripod socket 5  
TV 80  
TV settings 110

**U**

USB Cable 82, 83  
USB connector and audio/video output 4, 80, 82, 88

**V**

Vibration reduction 104  
Video mode 110  
ViewNX 85  
Vivid color 57  
Volume 79

**W**

Welcome screen 97  
White balance 53  
Wind noise reduction 78

**Z**

Zoom control 4, 23, 79



A series of horizontal dashed lines spanning the width of the page, intended for handwriting practice. There are 15 lines in total, starting from the top right and extending to the left edge of the page.



A series of horizontal dashed lines for handwriting practice, starting from the top right and extending across the page.



A series of horizontal dashed lines spanning the width of the page, providing a guide for handwriting practice. There are 15 lines in total, starting from the top and extending to the bottom of the page.



# ***Nikon***

No reproduction in any form of this manual, in whole or in part (except for brief quotation in critical articles or reviews), may be made without written authorization from NIKON CORPORATION.



**NIKON CORPORATION**

Fuji Bldg., 2-3 Marunouchi 3-chome,  
Chiyoda-ku, Tokyo 100-8331, Japan

© 2010 Nikon Corporation

Printed in Europe

CT0A01(11)

6MM74311-01