

**Nikon**

DIGITAL CAMERA

**COOLPIX A**

Reference Manual

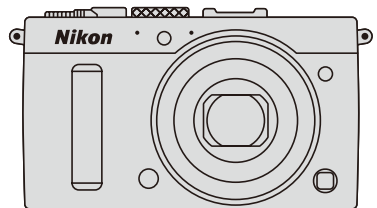

En

Menu items, options, and messages displayed in the camera monitor are shown in **bold**.

### **Memory Cards**

SD and SDHC/SDXC memory cards are referred to as “memory cards” in this manual.

### **Camera Settings**

The explanations in this manual assume that default settings are used.

### **Help**













Use the camera’s on-board help feature for help on menu items and other topics. See page 12 for details.





### **For Your Safety**

Before using the camera for the first time, read the safety instructions in “For Your Safety” (□ vi–viii).

# Where to Find It

Find what you're looking for from:

|  |   |
|--|---|
|  <b>The Table of Contents</b> ..... |  <b>xiii</b> |
|  <b>For Your Safety</b> .....       |  <b>vi</b>   |
|  <b>Menu Options</b> .....          |  <b>16</b>   |
|  <b>The Index</b> .....             |  <b>253</b>  |
|  <b>Troubleshooting</b> .....       |  <b>238</b>  |
|  <b>Error Messages</b> .....        |  <b>242</b>  |

|   |  |
|---|--|
|  <b>Introduction</b>                   |  <b>1</b>     |
|  <b>Basic Photography</b>              |  <b>27</b>    |
|  <b>Recording and Viewing Movies</b>   |  <b>38</b>    |
|  <b>P, S, A, and M Modes</b>           |  <b>52</b>    |
|  <b>User Settings: U1 and U2 Modes</b> |  <b>60</b>    |
|  <b>Release Mode</b>                   |  <b>63</b>    |
|  <b>Image Quality and Size</b>         |  <b>69</b>    |
|  <b>Focus</b>                          |  <b>74</b>    |
|  <b>ISO Sensitivity</b>                |  <b>81</b>    |
|  <b>Exposure</b>                       |  <b>85</b>    |
|  <b>White Balance</b>                 |  <b>89</b>   |
|  <b>Image Enhancement</b>            |  <b>99</b>  |
|  <b>Flash Photography</b>            |  <b>112</b> |
|  <b>Other Shooting Options</b>       |  <b>121</b> |
|  <b>More on Playback</b>             |  <b>132</b> |
|  <b>Connections</b>                  |  <b>154</b> |
|  <b>Camera Menus</b>                 |  <b>172</b> |
|  <b>Technical Notes</b>              |  <b>226</b> |

# Quick Start Guide

Follow these steps for a quick start with the COOLPIX A. For safety precautions, see “For Your Safety” ( vi).

## 1 Attach the camera strap.

Attach the strap securely to the camera eyelets.

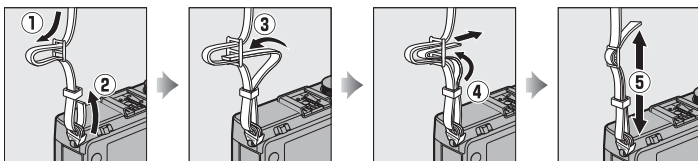

## 2 Charge the battery ( 20).

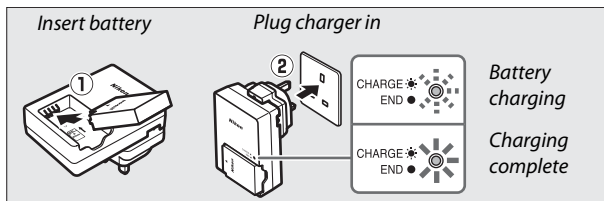

## 3 Insert the battery and a memory card ( 21, 23).

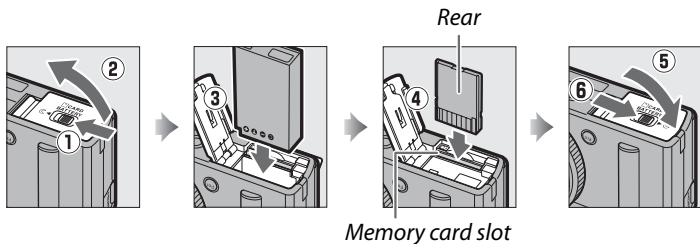

- 4 Turn the camera on** (📖 2).  
When using the camera for the first time, you will be prompted to choose a language and set the camera clock (📖 25).

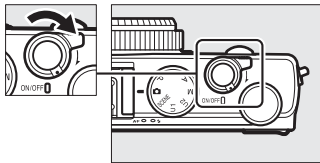

- 5 Rotate the focus mode selector to AF (autofocus;**  
📖 75).

*Focus mode selector*

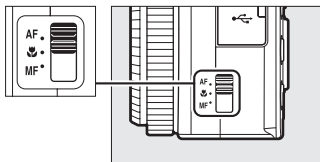

- 6 Frame the photograph** (📖 29).

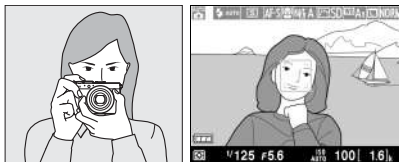

- 7 Focus and shoot** (📖 30).  
The focus area will light green when the focus operation is complete.



- 8 View the photograph**  
(📖 33).



▶ button

# For Your Safety

To prevent damage to your Nikon product or injury to yourself or to others, read the following safety precautions in their entirety before using this equipment. Keep these safety instructions where all those who use the product will read them.



This icon marks warnings, information that should be read before using this Nikon product, to prevent possible injury.

## ■ ■ WARNINGS



### **Turn off in the event of malfunction**

Should you notice smoke or an unusual smell coming from the camera or battery charger, unplug the battery charger and remove the battery immediately, taking care to avoid burns. Continued operation could result in injury. After removing or disconnecting the power source, take the equipment to a Nikon-authorized service representative for inspection.



### **Do not disassemble**

Touching the internal parts of the camera or battery charger could result in injury. Repairs should be performed only by qualified technicians. Should the camera or battery charger break open as the result of a fall or other accident, take the product to a Nikon-authorized service representative for inspection, after unplugging the product and/or removing the battery.



### **Do not use the camera or battery charger in the presence of flammable gas**

Using the camera in the presence of flammable gases such as propane and gasoline, as well as flammable sprays or dust could result in explosion or fire.



### **Handle the camera strap with care**

Never place the strap around the neck of an infant or child.



### **Keep out of reach of children**

Do not keep the products within reach of children. Doing so may cause injury. Particular care should be taken to prevent infants from putting the battery or other small parts into their mouths.



### **Do not remain in contact with the camera, battery charger, or AC adapter for extended periods while the devices are on or in use**

Parts of the devices become hot. Leaving the devices in direct contact with the skin for extended periods may result in low-temperature burns.

**⚠ Store out of direct sunlight**

When the camera is not in use, turn it off to close the lens cover and store it out of direct sunlight. Light focused by the lens could cause fire.

**⚠ Observe caution when handling the battery**

The battery may leak, overheat, or explode if improperly handled. Observe the following precautions when handling the battery for use in this product:

- Before replacing the battery, turn the product off.
- The camera takes EN-EL20 rechargeable Li-ion batteries only (supplied), which must be charged using the supplied MH-27 battery charger. The optional ML-L3 remote control uses 3 V CR2025 batteries only.
- When inserting the battery, do not attempt to insert it upside down or backwards.
- Do not short or disassemble the battery or attempt to remove or break the battery insulation or casing.
- Do not expose the battery to flame or to excessive heat.
- Do not immerse in or expose to water.
- Replace the terminal cover when transporting the battery. Do not transport or store with metal objects such as necklaces or hairpins.

- The battery is prone to leakage when fully discharged. To avoid damage to the product, be sure to remove the battery when no charge remains.
- Discontinue use immediately should you notice any change in the battery, such as discoloration or deformation.
- If liquid from the damaged battery comes in contact with clothing or skin, rinse immediately with plenty of water.
- If leaked battery fluid gets into your eyes, rinse them out immediately with clean running water and get medical treatment.
- Do not attempt to charge non-rechargeable batteries.

**⚠ Observe the following precautions when handling the battery charger**

- Keep dry. Failure to observe this precaution could result in fire or electric shock.
- Dust on or near the metal parts of the plug should be removed with a dry cloth. Continued use could result in fire.
- Do not handle the plug or go near the battery charger during lightning storms. Failure to observe this precaution could result in electric shock.
- Do not handle the plug or battery charger with wet hands. Failure to observe this precaution could result in electric shock.

- Do not use with travel converters or adapters designed to convert from one voltage to another or with DC-to-AC inverters. Failure to observe this precaution could damage the product or cause overheating or fire.

**⚠ Use appropriate cables**

When connecting cables to the input and output jacks, use only the cables provided or sold by Nikon for the purpose, to maintain compliance with product regulations.

**⚠ Handle moving parts with care**

Be careful that your fingers or other objects are not pinched by the lens cover or other moving parts.

**⚠ CD-ROMs**

The CD-ROMs included with this device should not be played back on audio CD equipment. Playing CD-ROMs on an audio CD player could cause hearing loss or damage the equipment.

**⚠ Observe caution when using the flash**

Using the flash close to your subject's eyes could cause temporary visual impairment. Particular care should be observed if photographing infants, when the flash should be no less than 1 m (3 ft 4 in.) from the subject.

**⚠ Do not aim a flash at the operator of a motor vehicle**

Failure to observe this precaution could result in accidents.

**⚠ Do not operate the flash with the flash window touching a person or object**  
Failure to observe this precaution could result in burns or fire.

**⚠ Avoid contact with liquid crystal**  
Should the monitor break, care should be taken to avoid injury caused by broken glass and to prevent liquid crystal from the monitor touching the skin or entering the eyes or mouth.

**⚠ Follow the directions of airline and hospital personnel**

Remove Eye-Fi cards from the camera before boarding an aircraft, and turn the product off during takeoff and landing or when so directed by airline or hospital staff. Radio waves emitted by the device could interfere with aircraft navigation or hospital medical equipment.

# Notices

- No part of the manuals included with this product may be reproduced, transmitted, transcribed, stored in a retrieval system, or translated into any language in any form, by any means, without Nikon's prior written permission.
- Nikon reserves the right to change the specifications of the hardware and software described in these manuals at any time and without prior notice.
- Nikon will not be held liable for any damages resulting from the use of this product.
- While every effort has been made to ensure that the information in these manuals is accurate and complete, we would appreciate it were you to bring any errors or omissions to the attention of the Nikon representative in your area (address provided separately).

## **Notice for Customers in Canada**

### **CAUTION**

This Class B digital apparatus complies with Canadian ICES-003.

### **ATTENTION**

Cet appareil numérique de la classe B est conforme à la norme NMB-003 du Canada.

## **Notices for Customers in Europe**

### **CAUTION**

RISK OF EXPLOSION IF BATTERY IS REPLACED BY AN INCORRECT TYPE.  
DISPOSE OF USED BATTERIES ACCORDING TO THE INSTRUCTIONS.

This symbol indicates that electrical and electronic equipment is to be collected separately.



- For more information, contact the retailer or the local authorities in charge of waste management.

The following apply only to users in European countries:

- This product is designated for separate collection at an appropriate collection point. Do not dispose of as household waste.
- Separate collection and recycling helps conserve natural resources and prevent negative consequences for human health and the environment that might result from incorrect disposal.

This symbol on the battery indicates that the battery is to be collected separately.



The following apply only to users in European countries:

- All batteries, whether marked with this symbol or not, are designated for separate collection at an appropriate collection point. Do not dispose of as household waste.
- For more information, contact the retailer or the local authorities in charge of waste management.

## Notices for Customers in the U.S.A.

### The Battery Charger

# IMPORTANT SAFETY INSTRUCTIONS—SAVE THESE INSTRUCTIONS DANGER—TO REDUCE THE RISK OF FIRE OR ELECTRIC SHOCK, CAREFULLY FOLLOW THESE INSTRUCTIONS

For connection to a supply not in the U.S.A., use an attachment plug adapter of the proper configuration for the power outlet if needed. This power unit is intended to be correctly oriented in a vertical or floor mount position.

### Federal Communications Commission (FCC) Radio Frequency Interference Statement

This equipment has been tested and found to comply with the limits for a Class B digital device, pursuant to Part 15 of the FCC rules. These limits are designed to provide reasonable protection against harmful interference in a residential installation. This equipment generates, uses, and can radiate radio frequency energy and, if not installed and used in accordance with the instructions, may cause harmful interference to radio communications. However, there is no guarantee that interference will not occur in a particular installation. If this equipment does cause harmful interference to radio or television reception, which can be determined by turning the equipment off and on, the user is encouraged to try to correct the interference by one or more of the following measures:

- Reorient or relocate the receiving antenna.
- Increase the separation between the equipment and receiver.
- Connect the equipment into an outlet on a circuit different from that to which the receiver is connected.
- Consult the dealer or an experienced radio/television technician for help.



**Nikon**  
COOLPIX A

### CAUTIONS

#### *Modifications*

The FCC requires the user be notified that any changes or modifications made to this device that are not expressly approved by Nikon Corporation may void the user's authority to operate the equipment.

#### *Interface Cables*

Use the interface cables sold or provided by Nikon for your equipment. Using other interface cables may exceed the limits of Class B Part 15 of the FCC rules.

### Notice for Customers in the State of California

**WARNING:** Handling the cord on this product may expose you to lead, a chemical known to the State of California to cause birth defects or other reproductive harm. *Wash hands after handling.*

Nikon Inc., 1300 Walt Whitman Road,  
Melville, New York 11747-3064, U.S.A.  
Tel.: 631-547-4200

## **Notice Concerning Prohibition of Copying or Reproduction**

Note that simply being in possession of material that has been digitally copied or reproduced by means of a scanner, digital camera, or other device may be punishable by law.

### **• Items prohibited by law from being copied or reproduced**

Do not copy or reproduce paper money, coins, securities, government bonds, or local government bonds, even if such copies or reproductions are stamped “Sample.”

The copying or reproduction of paper money, coins, or securities which are circulated in a foreign country is prohibited.

Unless the prior permission of the government has been obtained, the copying or reproduction of unused postage stamps or post cards issued by the government is prohibited.

The copying or reproduction of stamps issued by the government and of certified documents stipulated by law is prohibited.

### **• Cautions on certain copies and reproductions**

The government has issued cautions on copies or reproductions of

securities issued by private companies (shares, bills, checks, gift certificates, etc.), commuter passes, or coupon tickets, except when a minimum of necessary copies are to be provided for business use by a company. Also, do not copy or reproduce passports issued by the government, licenses issued by public agencies and private groups, ID cards, and tickets, such as passes and meal coupons.

### **• Comply with copyright notices**

The copying or reproduction of copyrighted creative works such as books, music, paintings, woodcuts, prints, maps, drawings, movies, and photographs is governed by national and international copyright laws. Do not use this product for the purpose of making illegal copies or to infringe copyright laws.

## **Disposing of Data Storage Devices**

Please note that deleting images or formatting memory cards or other data storage devices does not completely erase the original image data. Deleted files can sometimes be recovered from discarded storage devices using commercially available software, potentially resulting in the malicious use of personal image data. Ensuring the privacy of such data is the user’s responsibility.

Before discarding a data storage device or transferring ownership to another person, erase all data using commercial deletion software, or format the device and then (after disconnecting any optional GPS devices) completely refill it with images containing no private information (for example, pictures of empty sky). Be sure to also replace any pictures selected for preset manual white balance (□ 94). Care should be taken to avoid injury when physically destroying data storage devices.

### **Use Only Nikon Brand Electronic Accessories**

Nikon cameras are designed to the highest standards and include complex electronic circuitry. Only Nikon brand electronic accessories (including chargers, batteries, AC adapters, and flash accessories) certified by Nikon specifically for use with this Nikon digital camera are engineered and proven to operate within the operational and safety requirements of this electronic circuitry.

The use of non-Nikon electronic accessories could damage the camera and may void your Nikon warranty. The use of third-party rechargeable Li-ion batteries not bearing the Nikon holographic seal shown at right could interfere with normal operation of the camera or result in the batteries overheating, igniting, rupturing, or leaking.

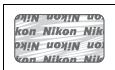

For more information about Nikon brand accessories, contact a local authorized Nikon dealer.

#### **✔ Use Only Nikon Brand Accessories**

Only Nikon brand accessories certified by Nikon specifically for use with your Nikon digital camera are engineered and proven to operate within its operational and safety requirements. THE USE OF NON-NIKON ACCESSORIES COULD DAMAGE YOUR CAMERA AND MAY VOID YOUR NIKON WARRANTY.

#### **✔ Servicing the Camera and Accessories**

The camera is a precision device and requires regular servicing. Nikon recommends that the camera be inspected by the original retailer or a Nikon-authorized service representative once every one to two years, and that it be serviced once every three to five years (note that fees apply to these services). Frequent inspection and servicing are particularly recommended if the camera is used professionally. Any accessories regularly used with the camera, such as lenses or optional flash units, should be included when the camera is inspected or serviced.

# Table of Contents

|                                  |          |
|----------------------------------|----------|
| Quick Start Guide.....           | iv       |
| For Your Safety .....            | vi       |
| Notices.....                     | ix       |
| <b>Introduction</b>              | <b>1</b> |
| <hr/>                            |          |
| Getting to Know the Camera ..... | 2        |
| The Camera Body.....             | 2        |
| The Monitor.....                 | 5        |
| The Information Display .....    | 7        |
| The Mode Dial .....              | 9        |
| The Command Dial.....            | 10       |
| Camera Menus: An Overview.....   | 12       |
| Using Camera Menus.....          | 13       |
| Menu Options .....               | 16       |
| First Steps .....                | 20       |
| Charge the Battery.....          | 20       |
| Insert the Battery.....          | 21       |
| Insert a Memory Card .....       | 23       |
| Basic Setup .....                | 25       |

---

|  |    |
|--|----|
| Battery Level and Card Capacity .....        | 27 |
| “Point-and-Shoot” Photography (📷 Mode) ..... | 29 |
| Basic Playback.....                          | 33 |
| Deleting Unwanted Photographs .....          | 34 |
| Creative Photography (Scene Modes) .....     | 35 |
| 👤 Portrait .....                             | 35 |
| 🏞️ Landscape.....                            | 35 |
| 👶 Child .....                                | 35 |
| 🏈 Sports .....                               | 36 |
| 🌸 Close up.....                              | 36 |
| 🌃 Night Portrait.....                        | 36 |
| 🌃 Night Landscape .....                      | 36 |
| 🎉 Party/Indoor.....                          | 36 |
| 🏖️ Beach/Snow .....                          | 36 |
| 🌅 Sunset.....                                | 36 |
| 🌅 Dusk/Dawn.....                             | 36 |
| 🐾 Pet Portrait .....                         | 36 |
| 💡 Candlelight .....                          | 36 |
| 🌸 Blossom.....                               | 36 |
| 🍁 Autumn Colors .....                        | 36 |
| 🍽️ Food.....                                 | 37 |
| 👤 Silhouette .....                           | 37 |
| 📷 High Key .....                             | 37 |
| 📷 Low Key .....                              | 37 |

**Recording and Viewing Movies**

---

|                                   |    |
|-----------------------------------|----|
| Recording Movies.....             | 38 |
| The Movie Recording Display ..... | 41 |
| Movie Settings.....               | 43 |
| Viewing Movies .....              | 45 |
| Editing Movies .....              | 47 |
| Trimming Movies.....              | 47 |
| Saving Selected Frames .....      | 50 |

## **P, S, A, and M Modes** **52**

---

|                                  |    |
|----------------------------------|----|
| Shutter Speed and Aperture ..... | 52 |
| P: Programmed Auto.....          | 53 |
| S: Shutter-Priority Auto .....   | 54 |
| A: Aperture-Priority Auto .....  | 55 |
| M: Manual.....                   | 56 |

## **User Settings: U1 and U2 Modes** **60**

---

|                               |    |
|-------------------------------|----|
| Saving User Settings .....    | 60 |
| Recalling User Settings ..... | 62 |
| Resetting User Settings.....  | 62 |

## **Release Mode** **63**

---

|  |    |
|--|----|
| Single-Frame, Continuous, Self-timer, Remote, and Movie<br>Modes ..... | 63 |
| Self-Timer and Remote Control Modes .....                              | 66 |

## **Image Quality and Size** **69**

---

|                     |    |
|---------------------|----|
| Image Quality ..... | 69 |
| Image Size.....     | 72 |

## **Focus** **74**

---

|                     |    |
|---------------------|----|
| Autofocus .....     | 75 |
| Autofocus Mode..... | 75 |
| AF-Area Mode .....  | 76 |
| Focus Lock.....     | 79 |
| Manual Focus .....  | 80 |

## **ISO Sensitivity** **81**

---

|                                    |    |
|------------------------------------|----|
| Auto ISO Sensitivity Control ..... | 83 |
|------------------------------------|----|

---

**Exposure** **85**

---

|                            |    |
|----------------------------|----|
| Metering .....             | 85 |
| Exposure Compensation..... | 87 |

---

**White Balance** **89**

---

|                                |    |
|--------------------------------|----|
| White Balance Options .....    | 89 |
| Fine-Tuning White Balance..... | 92 |
| Preset Manual .....            | 94 |

---

**Image Enhancement** **99**

---

|   |     |
|---|-----|
| Picture Controls.....   | 99  |
| Selecting a Picture Control.....  | 99  |
| Modifying Picture Controls.....   | 101 |
| Creating Custom Picture Controls.....                                   | 106 |
| Sharing Custom Picture Controls .....                                   | 109 |
| Preserving Detail in Highlights and Shadows<br>(Active D-Lighting)..... | 110 |

---

**Flash Photography** **112**

---

|                               |     |
|-------------------------------|-----|
| Using the Built-in Flash..... | 112 |
| Flash Mode.....               | 113 |
| Flash Compensation.....       | 116 |
| FV Lock .....                 | 118 |

---

**Other Shooting Options** **121**

---

|                                  |     |
|----------------------------------|-----|
| Restoring Default Settings ..... | 121 |
| Bracketing .....                 | 123 |
| Interval Timer Photography.....  | 127 |
| Using a GPS Unit .....           | 130 |

## More on Playback

132

|  |     |
|--|-----|
| Full-Frame Playback .....                          | 132 |
| Photo Information.....                             | 134 |
| Thumbnail Playback .....                           | 140 |
| Calendar Playback.....                             | 142 |
| Taking a Closer Look: Playback Zoom.....           | 144 |
| Protecting Photographs from Deletion.....          | 146 |
| Deleting Photographs .....                         | 148 |
| Full-Frame, Thumbnail, and Calendar Playback ..... | 148 |
| The Playback Menu .....                            | 150 |

## Connections



154



|   |     |
|---|-----|
| Using ViewNX 2.....                         | 154 |
| Installing ViewNX 2 .....                   | 154 |
| Copy Pictures to the Computer .....         | 156 |
| View Pictures .....                         | 158 |
| Printing Photographs.....                   | 159 |
| Connecting the Printer .....                | 159 |
| Printing Pictures One at a Time .....       | 161 |
| Printing Multiple Pictures .....            | 163 |
| Creating a DPOF Print Order: Print Set..... | 166 |
| Viewing Photographs on TV.....              | 169 |
| HDMI Options.....                           | 171 |

## Camera Menus

172

|   |     |
|---|-----|
| ▶ The Playback Menu: <i>Managing Images</i> ..... | 172 |
| Playback Folder .....                             | 173 |
| Playback Display Options .....                    | 173 |
| Image Review.....                                 | 173 |
| Rotate Tall .....                                 | 174 |
| Slide Show.....                                   | 174 |

|  |     |
|--|-----|
|  The Shooting Menu: <i>Shooting Options</i> ..... | 176 |
| Reset Shooting Menu .....  | 176 |
| Storage Folder.....  | 177 |
| Color Space .....  | 178 |
| Long Exposure NR .....   | 179 |
| High ISO NR.....   | 179 |
| Built-in AF-assist Illuminator .....   | 180 |
| Exposure Comp. for Flash .....   | 180 |
| Flash Cntrl for Built-in Flash .....   | 181 |
| Auto Bracketing Set .....  | 181 |
|  The Setup Menu: <i>Camera Setup</i> .....      | 182 |
| Format Memory Card .....   | 183 |
| Monitor Brightness.....  | 183 |
| Photo Info .....   | 184 |
| Flicker Reduction.....   | 184 |
| Time Zone and Date .....   | 185 |
| Language .....   | 186 |
| Image Comment .....  | 186 |
| Auto Image Rotation .....  | 187 |
| Self-Timer.....  | 188 |
| Auto off Timer .....   | 189 |
| Image Review Time .....  | 189 |
| Remote on Duration (ML-L3) .....   | 189 |
| Beep .....   | 190 |
| Shutter Sound .....  | 190 |
| File Number Sequence.....  | 191 |
| MF Distance Indicator Units .....  | 192 |
| Reverse Indicators.....  | 192 |
| Assign Fn1 Button.....   | 193 |
| Assign  /Fn2 Button .....                     | 194 |
| Reverse Dial Rotation .....  | 194 |
| Slot Empty Release Lock.....   | 195 |
| Eye-Fi Upload .....  | 195 |
| Firmware Version .....   | 196 |

|  |     |
|--|-----|
|  The Retouch Menu: <i>Creating Retouched Copies</i> .....   | 197 |
| Creating Retouched Copies .....  | 198 |
| D-Lighting .....   | 200 |
| Red-Eye Correction .....   | 201 |
| Trim .....   | 202 |
| Monochrome .....   | 203 |
| Filter Effects .....   | 203 |
| Color Balance .....  | 205 |
| Image Overlay .....  | 206 |
| NEF (RAW) Processing .....   | 209 |
| Resize .....   | 211 |
| Quick Retouch .....  | 213 |
| Straighten .....   | 213 |
| Fisheye .....  | 213 |
| Color Outline .....  | 214 |
| Color Sketch .....   | 214 |
| Perspective Control .....  | 215 |
| Miniature Effect .....   | 216 |
| Selective Color .....  | 217 |
| Side-by-Side Comparison .....  | 219 |
|  Recent Settings/  My Menu ..... | 221 |
| My Menu .....  | 222 |

## Technical Notes

**226**

|   |     |
|---|-----|
| Optional Flash Units (Speedlights) .....          | 226 |
| Other Accessories .....                           | 230 |
| Caring for the Camera .....                       | 232 |
| Cleaning .....                                    | 232 |
| Storage .....                                     | 232 |
| Caring for the Camera and Battery: Cautions ..... | 233 |
| Caring for the Camera .....                       | 233 |
| Caring for the Battery .....                      | 234 |
| The Charger .....                                 | 235 |
| Available Settings .....                          | 236 |

|                             |     |
|-----------------------------|-----|
| Troubleshooting .....       | 238 |
| Battery/Display .....       | 238 |
| Shooting (All Modes).....   | 238 |
| Shooting (P, S, A, M) ..... | 240 |
| Playback.....               | 240 |
| Miscellaneous .....         | 241 |
| Error Messages.....         | 242 |
| Specifications .....        | 245 |
| Approved Memory Cards ..... | 251 |
| Memory Card Capacity .....  | 252 |
| Index.....                  | 253 |



# Introduction

Thank you for your purchase of a Nikon digital camera. To get the most from your camera, please be sure to read all instructions thoroughly and keep them where they will be read by all who use the product.

## Symbols and Conventions

To make it easier to find the information you need, the following symbols and conventions are used:



This icon marks cautions; information that should be read before use to prevent damage to the camera.



This icon marks notes; information that should be read before using the camera.



This icon marks references to other pages in this manual.



### Before Taking Important Pictures

Before taking pictures on important occasions (such as at weddings or before taking the camera on a trip), take a test shot to ensure that the camera is functioning normally. Nikon will not be held liable for damages or lost profits that may result from product malfunction.



### Life-Long Learning

As part of Nikon's "Life-Long Learning" commitment to ongoing product support and education, continually-updated information is available on-line at the following sites:

- **For users in the U.S.A.:** <http://www.nikonusa.com/>
- **For users in Europe and Africa:** <http://www.europe-nikon.com/support/>
- **For users in Asia, Oceania, and the Middle East:** <http://www.nikon-asia.com/>

Visit these sites to keep up-to-date with the latest product information, tips, answers to frequently-asked questions (FAQs), and general advice on digital imaging and photography. Additional information may be available from the Nikon representative in your area. See the following URL for contact information: <http://imaging.nikon.com/>



# Getting to Know the Camera

## The Camera Body

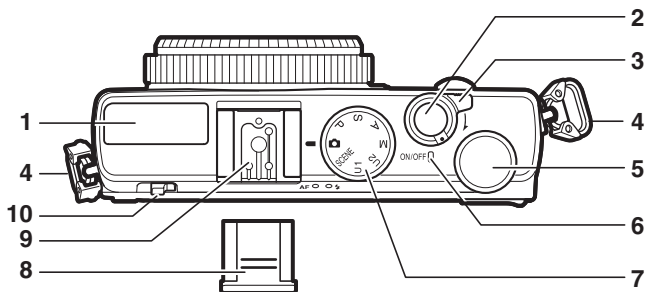

|   |  |     |    |                                 |     |
|---|--|-----|----|---------------------------------|-----|
| 1 | Built-in flash .....                               | 112 | 5  | Command dial .....              | 10  |
| 2 | Shutter-release button<br>Taking photographs ..... | 29  | 6  | Power-on lamp .....             | 25  |
|   | Recording movies .....                             | 38  | 7  | Mode dial .....                 | 9   |
| 3 | Power switch .....                                 | 2   | 8  | Accessory Shoe Cover BS-1 ..... | 226 |
| 4 | Eyelets for camera strap .....                     | iv  | 9  | Accessory shoe .....            | 226 |
|   |  |     | 10 | Flash pop-up control .....      | 112 |

### **The Power Switch**

To turn the camera on, rotate the power switch.  
To turn the camera on for playback without extending the lens, press and hold the  button (□ 4).

To turn the camera off, rotate the power switch;  
the monitor will turn off.

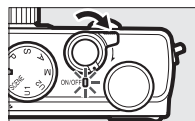

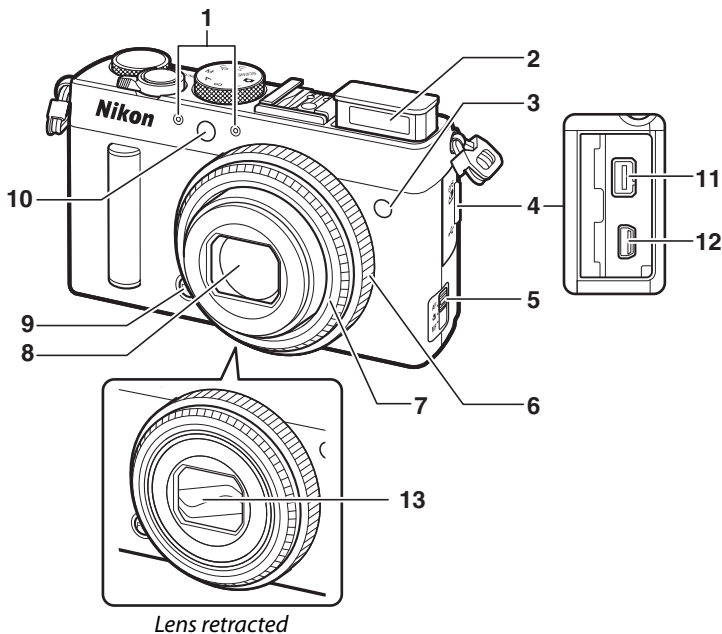

|   |     |   |          |
|---|-----|---|----------|
| <b>1</b> Stereo microphone.....               | 43  | <b>8</b> Lens.....                              | 245      |
| <b>2</b> Built-in flash .....                 | 112 | <b>9</b> Fn1 button                             |          |
| <b>3</b> Infrared receiver for remote control |     | Fn1.....  | 193      |
| .....   | 67  | <b>10</b> AF-assist illuminator/self-timer lamp |          |
| <b>4</b> Accessory terminal/USB connector     |     | .....   | 29       |
| cover .....                                   | 231 | <b>11</b> Accessory terminal.....               | 231      |
| <b>5</b> Focus-mode selector.....             | 74  | <b>12</b> USB connector.....                    | 156, 159 |
| <b>6</b> Focus ring.....                      | 80  | <b>13</b> Lens cover                            |          |
| <b>7</b> Lens ring                            |     |   |          |

### **✓ The Microphone and Speaker**

Do not place the microphone or speaker in close proximity to magnetic devices. Failure to observe this precaution could affect the data recorded on the magnetic devices.

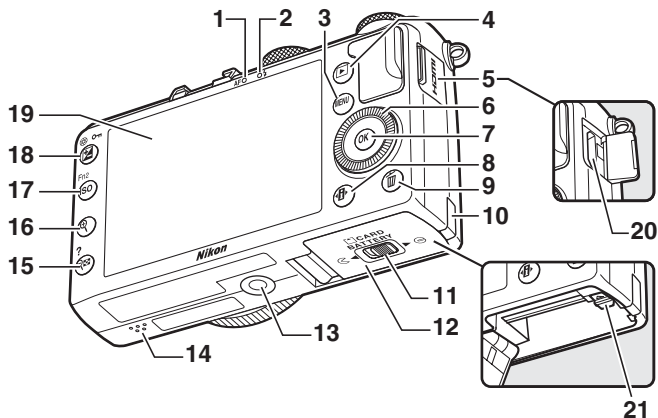

|   |   |
|---|---|
| <p><b>1</b> AF lamp/memory-card access lamp ..... 23, 30</p> <p><b>2</b> Flash lamp..... 112</p> <p><b>3</b> MENU button<br/>Menus ..... 12, 172</p> <p><b>4</b>  button<br/>Playback ..... 33, 132</p> <p><b>5</b> HDMI connector cover..... 170</p> <p><b>6</b> Rotary multi selector* ..... 13</p> <p><b>7</b>  button ..... 13</p> <p><b>8</b>  button ..... 7</p> <p><b>9</b>  button<br/>Deleting pictures during playback<br/>..... 34, 148</p> <p><b>10</b> Power connector cover..... 230</p> <p><b>11</b> Battery-chamber/<br/>memory card slot cover latch ..... 20</p> <p><b>12</b> Battery-chamber/<br/>memory card slot cover ..... 23</p> <p><b>13</b> Tripod socket</p> | <p><b>14</b> Speaker ..... 3</p> <p><b>15</b>  (?) button<br/>Thumbnails ..... 140<br/>Zooming out during playback<br/>..... 142<br/>Help..... 12</p> <p><b>16</b>  button<br/>Zooming in during playback ... 144</p> <p><b>17</b> ISO (Fn2) button<br/>ISO ..... 81<br/>Fn2 ..... 194</p> <p><b>18</b>  (@/0-m) button<br/>Exposure compensation ..... 87<br/>Adjusting aperture ..... 56<br/>Protecting photographs from<br/>deletion ..... 146</p> <p><b>19</b> Monitor ..... 12</p> <p><b>20</b> HDMI mini connector (Type C) .... 169</p> <p><b>21</b> Battery latch..... 22</p> |
|---|---|

\* The rotary multi selector is referred to by the term “multi selector” throughout this manual.



## ■ Playback Mode

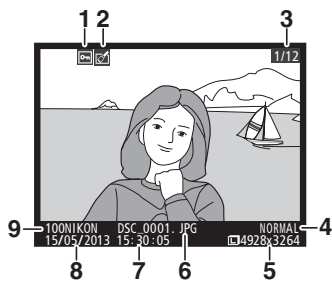

|   |                                     |         |
|---|-------------------------------------|---------|
| 1 | Protect status .....                | 146     |
| 2 | Retouch indicator.....              | 197     |
| 3 | Frame number/total number of images |         |
| 4 | Image quality .....                 | 69      |
| 5 | Image size .....                    | 72      |
| 6 | File name.....                      | 191     |
| 7 | Time of recording.....              | 25, 185 |
| 8 | Date of recording .....             | 25, 185 |
| 9 | Folder name .....                   | 177     |

# The Information Display

To adjust camera settings, press the **Fn** button. Current settings are shown in the monitor information display; highlight items using the multi selector (13) and press **OK** to view options for the highlighted item.

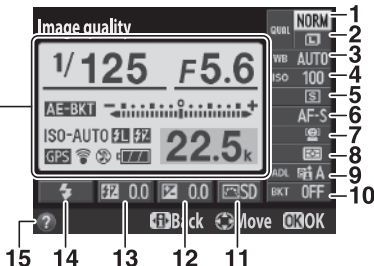
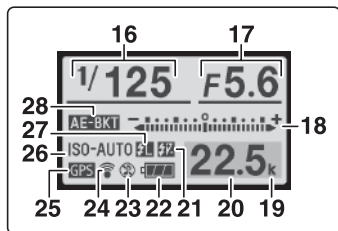
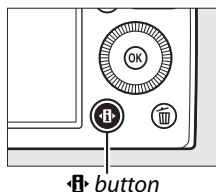

|    |                                    |        |    |  |     |
|----|------------------------------------|--------|----|--|-----|
| 1  | Image quality .....                | 69     | 18 | Exposure indicator.....  | 57  |
| 2  | Image size .....                   | 72     |    | Exposure compensation display .....                                | 87  |
| 3  | White balance .....                | 89     |    | Bracketing progress indicator .....                                | 125 |
| 4  | ISO sensitivity.....               | 81     | 19 | "K" (appears when memory remains<br>for over 1000 exposures) ..... | 27  |
| 5  | Release mode.....                  | 63     | 20 | Number of exposures remaining.....                                 | 27  |
| 6  | AF mode.....                       | 74     | 21 | Manual flash indicator   |     |
| 7  | AF-area mode .....                 | 76     |    | Flash compensation indicator for<br>optional flash units .....     | 116 |
| 8  | Metering.....                      | 85     | 22 | Battery indicator .....  | 27  |
| 9  | Active D-Lighting .....            | 110    | 23 | "Beep" indicator .....   | 190 |
| 10 | Bracketing increment .....         | 123    | 24 | Eye-Fi connection indicator .....                                  | 195 |
| 11 | Picture Control.....               | 99     | 25 | GPS connection indicator .....                                     | 130 |
| 12 | Exposure compensation.....         | 87     | 26 | Auto ISO sensitivity indicator .....                               | 83  |
|    | Exposure compensation value .....  | 87     | 27 | FV lock indicator .....  | 118 |
| 13 | Flash compensation indicator ..... | 116    | 28 | Bracketing indicator.....  | 123 |
|    | Flash compensation value.....      | 116    |    | ADL bracketing progress indicator                                  |     |
| 14 | Flash mode .....                   | 113    |    | .....  | 125 |
| 15 | Help icon .....                    | 12     |    |  |     |
| 16 | Shutter speed.....                 | 54, 56 |    |  |     |
| 17 | Aperture .....                     | 55, 56 |    |  |     |

**Note:** Display shown with all indicators lit for illustrative purposes.

 **The Information Display**

To hide the information display, press the  button again.



# The Mode Dial

Rotate the mode dial to choose from the following shooting modes:

Mode dial

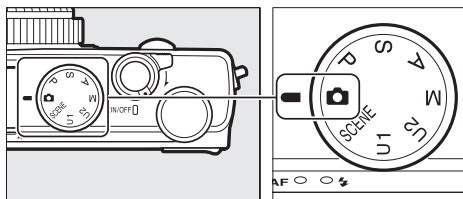

## **Auto Mode** (📖 29)

Select this mode for simple, point-and-shoot photography.

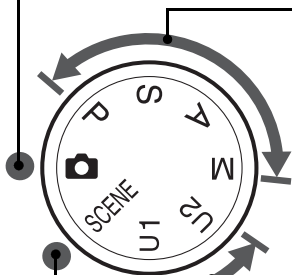

## **P, S, A, and M Modes**

Select these modes for full control over camera settings.

- **P—Programmed auto** (📖 53)
- **S—Shutter-priority auto** (📖 54)
- **A—Aperture-priority auto** (📖 55)
- **M—Manual** (📖 56)

## **U1 and U2 Modes** (📖 60)

Store and recall customized shooting settings.

## **Scene Modes** (📖 35)

The camera automatically optimizes settings to suit the selected scene. Match your selection to the scene being photographed.

# The Command Dial

The command dial can be used with other controls to adjust a variety of settings when shooting information is displayed in the monitor.

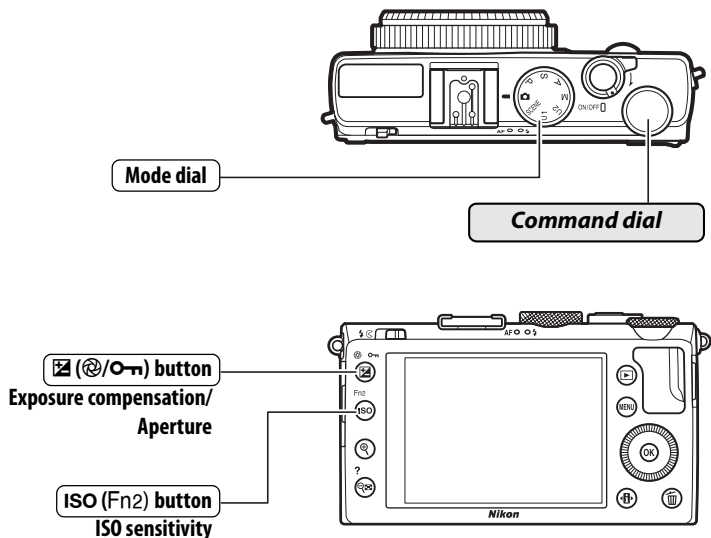

Choose a combination of aperture and shutter speed (mode P; 53).

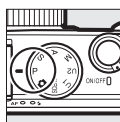

Mode P



Command dial



Choose a shutter speed  
(mode S or M;  54, 56).

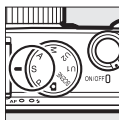

Mode S or  
M



Command  
dial



Choose an aperture  
(mode A;  55).

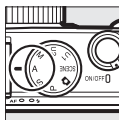

Mode A



Command  
dial



Choose an  
aperture  
(mode M;  
 56).

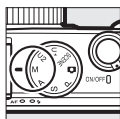

Mode M

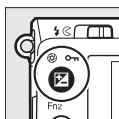

 button



Command  
dial



Set exposure  
compensation  
(mode P, S, or  
A;  87).

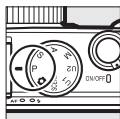

Mode P, S  
or A

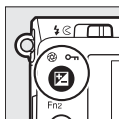

 button



Command  
dial



Adjust ISO sensitivity  
( 81).

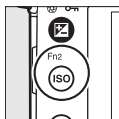

ISO (Fn2)  
button



Command  
dial



# Camera Menu: An Overview

Most shooting, playback, and setup options can be accessed from the camera menu. To view the menus, press the **MENU** button.

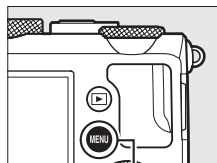

MENU button

## Tabs

Choose from the following menus:

- ▶: **Playback** (📖 172)
- 📷: **Shooting** (📖 176)
- ⚙️: **Setup** (📖 182)
- ✍️: **Retouch** (📖 197)
- 📄/📄: **Recent settings** or **My Menu** (defaults to **Recent settings**; 📖 221)

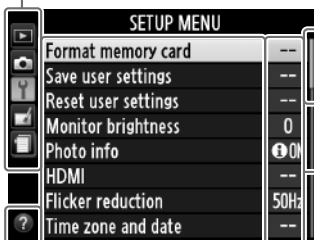





Slider shows position in current menu.

Current settings are shown by icons.

## Menu options

Options in current menu.



If a  icon appears at the bottom left corner of the monitor, a description of the currently selected option or menu can be displayed by pressing the  button. A description of the currently selected option or menu will be displayed while the button is pressed. Press  or  to scroll through the display.

# Using Camera Menus

The multi selector and **OK** button are used to navigate the camera menus.

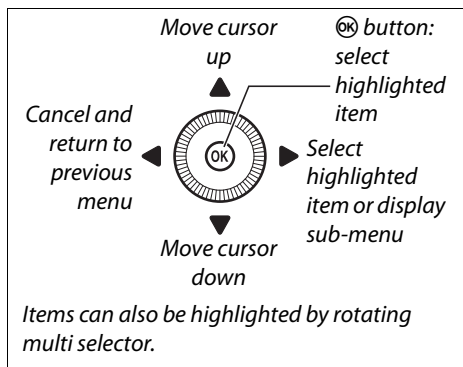

Follow the steps below to navigate the menus.

## 1 Display the menus.

Press the **MENU** button to display the menus.

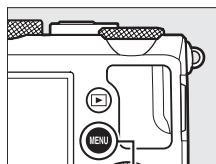

**MENU** button

## 2 Highlight the icon for the current menu.

Press **◀** to highlight the icon for the current menu.





---

## 7 Highlight an option.

Press ▲ or ▼ to highlight an option.



---

## 8 Select the highlighted item.

Press **OK** to select the highlighted item.  
To exit without making a selection, press the **MENU** button.



Note the following:

- Menu items that are displayed in gray are not currently available.
- While pressing ► generally has the same effect as pressing **OK**, there are some cases in which selection can only be made by pressing **OK**.
- To exit the menus and return to shooting mode, press the shutter-release button halfway (📖 31).



# Menu Options

## ▶ **PLAYBACK MENU**

(📖 172)

|                                 |                   |
|---------------------------------|-------------------|
| <b>Delete</b>                   | Selected          |
|                                 | Select date       |
|                                 | All               |
| <b>Playback folder</b>          | Current (default) |
|                                 | All               |
| <b>Playback display options</b> | None (image only) |
|                                 | Highlights        |
|                                 | RGB histogram     |
|                                 | Shooting data     |
|                                 | Overview          |
| <b>Image review</b>             | On (default)      |
|                                 | Off               |
| <b>Rotate tall</b>              | On (default)      |
|                                 | Off               |
| <b>Slide show</b>               | Start             |
|                                 | Frame interval    |
| <b>DPOF print order</b>         | Select/set        |
|                                 | Deselect all?     |

## 📷 **SHOOTING MENU**

(📖 176)



|                            |               |
|----------------------------|---------------|
| <b>Reset shooting menu</b> | Yes           |
|                            | No            |
| <b>Storage folder</b>      | Select folder |
|                            | New           |
|                            | Rename        |
|                            | Delete        |

|                               |                         |
|-------------------------------|-------------------------|
| <b>Image quality</b>          | NEF (RAW) + JPEG fine   |
|                               | NEF (RAW) + JPEG normal |
|                               | NEF (RAW) + JPEG basic  |
|                               | NEF (RAW)               |
|                               | JPEG fine               |
|                               | JPEG normal (default)   |
|                               | JPEG basic              |
| <b>Image size</b>             | Large (default)         |
|                               | Medium                  |
|                               | Small                   |
| <b>White balance</b>          | Auto (default)          |
|                               | Incandescent            |
|                               | Fluorescent             |
|                               | Direct sunlight         |
|                               | Flash                   |
|                               | Cloudy                  |
|                               | Shade                   |
|                               | Preset manual           |
| <b>Set Picture Control</b>    | Standard (default)      |
|                               | Neutral                 |
|                               | Vivid                   |
|                               | Monochrome              |
|                               | Portrait                |
| <b>Manage Picture Control</b> | Landscape               |
|                               | Save/edit               |
|                               | Rename <sup>1</sup>     |
|                               | Delete <sup>1</sup>     |
|                               | Load/save               |

|                                       |                                       |
|---------------------------------------|---------------------------------------|
| <b>Color space</b>                    | sRGB (default)                        |
|                                       | Adobe RGB                             |
| <b>Active D-Lighting</b> <sup>2</sup> | Auto                                  |
|                                       | Extra high                            |
|                                       | High                                  |
|                                       | Normal                                |
|                                       | Low                                   |
|                                       | Off                                   |
| <b>Long exposure NR</b>               | On                                    |
|                                       | Off (default)                         |
| <b>High ISO NR</b>                    | High                                  |
|                                       | Normal (default)                      |
|                                       | Low                                   |
|                                       | Off                                   |
| <b>ISO sensitivity settings</b>       | ISO sensitivity                       |
|                                       | Auto ISO sensitivity control          |
| <b>Release mode</b>                   | Single frame (default)                |
|                                       | Continuous                            |
|                                       | Self-timer                            |
|                                       | Delayed remote (ML-L3)                |
|                                       | Quick-response (ML-L3)                |
|                                       | Movie recording                       |
|                                       | <b>Built-in AF-assist illuminator</b> |
| Off                                   |                                       |
| <b>Exposure comp. for flash</b>       | Entire frame (default)                |
|                                       | Background only                       |
| <b>Flash ctrl for built-in flash</b>  | TTL (default)                         |
|                                       | Manual                                |
| <b>Optional flash</b>                 | TTL (default)                         |
|                                       | Manual                                |

|                                |                         |
|--------------------------------|-------------------------|
| <b>Auto bracketing set</b>     | AE bracketing (default) |
|                                | WB bracketing           |
|                                | ADL bracketing          |
| <b>Interval timer shooting</b> | Choose start time       |
|                                | Now                     |
|                                | Start time              |
|                                | Interval                |
|                                | Number of times         |
| <b>Movie settings</b>          | Start                   |
|                                | Frame size/frame rate   |
|                                | Movie quality           |
|                                | Microphone              |

1 Not available if no custom Picture Controls are present.



2 Defaults to **Off** (modes P, S, A, M, , , and ) or **Auto** (other modes).

## Y SETUP MENU (📖 182)

|                            |                     |
|----------------------------|---------------------|
| <b>Format memory card</b>  | –                   |
| <b>Save user settings</b>  | Save to U1          |
|                            | Save to U2          |
| <b>Reset user settings</b> | Reset U1            |
|                            | Reset U2            |
| <b>Monitor brightness</b>  | –5 – +3             |
| <b>Photo info</b>          | Show info (default) |
|                            | Hide info           |
|                            | Framing grid        |
|                            | Virtual horizon     |
| <b>HDMI</b>                | Output resolution   |
|                            | Device control      |
| <b>Flicker reduction</b>   | 50 Hz               |
|                            | 60 Hz               |



|                                    |                      |
|------------------------------------|----------------------|
| <b>Time zone and date</b>          | Time zone            |
|                                    | Date and time        |
|                                    | Date format          |
|                                    | Daylight saving time |
| <b>Language</b>                    | See page 247.        |
| <b>Image comment</b>               | Input comment        |
|                                    | Attach comment       |
| <b>Auto image rotation</b>         | On (default)         |
|                                    | Off                  |
| <b>Self-timer</b>                  | Self-timer delay     |
|                                    | Number of shots      |
| <b>Auto off timer</b>              | 20 s                 |
|                                    | 1 min (default)      |
|                                    | 5 min                |
|                                    | 30 min               |
| <b>Image review time</b>           | 1 s (default)        |
|                                    | 4 s                  |
|                                    | 8 s                  |
|                                    | 20 s                 |
|                                    | 1 min                |
| <b>Remote on duration (ML-L3)</b>  | 1 min (default)      |
|                                    | 5 min                |
|                                    | 10 min               |
|                                    | 15 min               |
| <b>Beep</b>                        | High                 |
|                                    | Low                  |
|                                    | Off (default)        |
| <b>Shutter sound</b>               | On (default)         |
|                                    | Off                  |
| <b>File number sequence</b>        | On                   |
|                                    | Off (default)        |
|                                    | Reset                |
| <b>MF distance indicator units</b> | m (default)          |
|                                    | ft                   |

|                                |  |
|--------------------------------|--|
| <b>Reverse indicators</b>      |                |
|                                | <br>(default) |
| <b>Assign Fn1 button</b>       | Flash mode (default)   |
|                                | Release mode   |
|                                | Self-timer   |
|                                | FV lock  |
|                                | AE/AF lock   |
|                                | AE lock only   |
|                                | AE lock (Hold)   |
|                                | AF lock only   |
|                                | AF-ON  |
|                                | Exposure compensation  |
| + NEF (RAW)                    |  |
| <b>Assign ISO/Fn2 button</b>   | ISO sensitivity<br>(default)   |
|                                | White balance  |
|                                | Image quality/size   |
|                                | Metering   |
|                                | Active D-Lighting  |
|                                | Auto bracketing  |
| Monitor brightness             |  |
| <b>Reverse dial rotation</b>   | Exposure compensation  |
|                                | Shutter speed/aperture   |
| <b>Slot empty release lock</b> | Release locked<br>(default)  |
|                                | Enable release   |
| <b>GPS</b>                     | Auto off   |
|                                | Position   |
|                                | Use GPS to set camera clock  |

|                         |                  |
|-------------------------|------------------|
| <b>Eye-Fi upload*</b>   | Enable (default) |
|                         | Disable          |
| <b>Firmware version</b> | –                |

\* Available only with compatible Eye-Fi memory cards.

## **RETOUCH MENU** ( 197)

|                             |                   |
|-----------------------------|-------------------|
| <b>D-Lighting</b>           | –                 |
| <b>Red-eye correction</b>   | –                 |
| <b>Trim</b>                 | –                 |
| <b>Monochrome</b>           | Black-and-white   |
|                             | Sepia             |
|                             | Cyanotype         |
| <b>Filter effects</b>       | Skylight          |
|                             | Warm filter       |
|                             | Red intensifier   |
|                             | Green intensifier |
|                             | Blue intensifier  |
|                             | Cross screen      |
|                             | Soft              |
| <b>Color balance</b>        | –                 |
| <b>Image overlay</b>        | –                 |
| <b>NEF (RAW) processing</b> | –                 |
| <b>Resize</b>               | Select image      |
|                             | Choose size       |
| <b>Quick retouch</b>        | –                 |
| <b>Straighten</b>           | –                 |
| <b>Fisheye</b>              | –                 |

|                                 |                        |
|---------------------------------|------------------------|
| <b>Color outline</b>            | –                      |
| <b>Color sketch</b>             | –                      |
| <b>Perspective control</b>      | –                      |
| <b>Miniature effect</b>         | –                      |
| <b>Selective color</b>          | –                      |
| <b>Edit movie</b>               | Choose start/end point |
|                                 | Save selected frame    |
| <b>Side-by-side comparison*</b> | –                      |

\* Only available when  button is pressed to display retouch menu during full-frame playback.

## **RECENT SETTINGS** ( 221)

|                   |                 |
|-------------------|-----------------|
| <b>Choose tab</b> | My Menu         |
|                   | Recent settings |

## **MY MENU** ( 222)

|                      |                 |
|----------------------|-----------------|
| <b>Add items</b>     | Playback menu   |
|                      | Shooting menu   |
|                      | Setup menu      |
|                      | Retouch menu    |
| <b>Remove items*</b> | –               |
| <b>Rank items</b>    | –               |
| <b>Choose tab</b>    | My Menu         |
|                      | Recent settings |

\* Items can also be deleted by highlighting them in MY MENU and pressing the  button twice.



# First Steps

## Charge the Battery

The camera is powered by an EN-EL20 rechargeable Li-ion battery (supplied). To maximize shooting time, charge the battery in the supplied MH-27 battery charger before use. About two hours are required to fully recharge the battery when no charge remains.

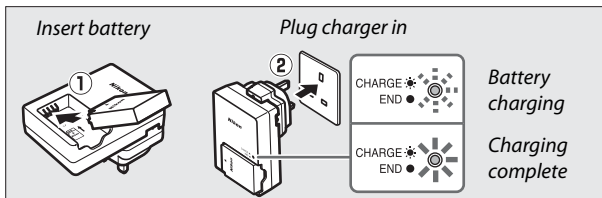

Unplug the charger and remove the battery when charging is complete.

### **The Plug Adapter**

Depending on the country or region of purchase, a plug adapter may be supplied with the charger. The shape of the adapter varies with the country or region of purchase. If a plug adapter is supplied, raise the wall plug and connect the plug adapter as shown at right, making sure the plug is fully inserted. Attempting to forcibly remove the plug adapter could damage the product.

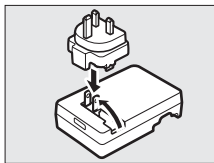

# Insert the Battery

## 1 Open the battery-chamber/ memory card slot cover.

Unlatch (1) and open (2) the battery-chamber/memory card slot cover.

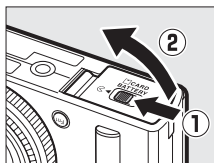

## 2 Insert the battery.

Insert the battery in the orientation shown (1), using the battery to keep the orange battery latch pressed to one side. The latch locks the battery in place when the battery is fully inserted (2).

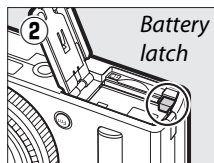
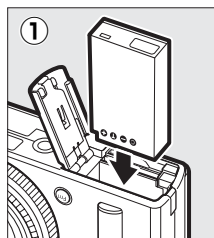

## 3 Close the battery-chamber/ memory card slot cover.

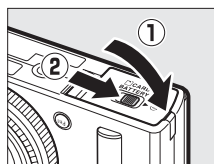

### **Removing the Battery**

To remove the battery, turn the camera off and open the battery-chamber/memory card slot cover. Press the battery latch in the direction shown by the arrow to release the battery and then remove the battery by hand.

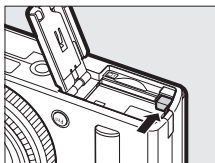

### **Inserting and Removing Batteries**

Always turn the camera off before inserting or removing batteries.

### **The Battery and Charger**

Read and follow the warnings and cautions on pages vi – viii and 233 – 235 of this manual. Do not short the charger terminals; failure to observe this precaution could result in overheating and damage to the charger. Do not move the charger or touch the battery during charging. Failure to observe this precaution could in very rare instances result in the charger showing that charging is complete when the battery is only partially charged. Remove and reinsert the battery to begin charging again. If the CHARGE lamp flashes quickly, unplug the charger and remove and reinsert the battery. If the problem persists, cease use immediately and take battery and charger to your retailer or a Nikon-authorized service representative.

The battery may be hot immediately after use. Wait for the battery to cool before recharging.

Use the charger with compatible batteries only. Unplug when not in use.

# Insert a Memory Card

The camera stores pictures on Secure Digital (SD) memory cards (available separately; □ 251). To install a memory card, turn the camera off and, holding the card in the orientation shown below, slide it in until it clicks into place.

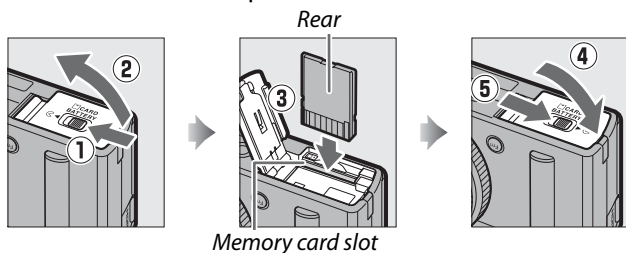

Inserting memory cards upside down or backwards could damage the camera or the card. Check to be sure the card is in the correct orientation.

## ✓ Formatting Memory Cards

If this is the first time the memory card will be used in the camera or if the card has been formatted in another device, select **Format memory card** in the setup menu and follow the on-screen instructions to format the card (□ 183). *Note that this permanently deletes any data the card may contain.* Be sure to copy any photographs and other data you wish to keep to a computer before proceeding.

## ✎ Removing Memory Cards

After confirming that the AF lamp/memory-card access lamp is off, turn the camera off, open the battery-chamber/memory card slot cover, and press the card in to eject it (①). The card can then be removed by hand (②).

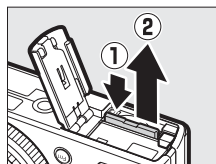

## ✓ Inserting and Removing Memory Cards

Always turn the camera off before inserting or removing memory cards.

## ✔ Memory Cards

- Memory cards may be hot after use. Observe due caution when removing memory cards from the camera.
- Do not remove memory cards from the camera, turn the camera off, or remove or disconnect the power source during formatting or while data are being recorded, deleted, or copied to a computer. Failure to observe these precautions could result in loss of data or in damage to the camera or card.
- Do not touch the card terminals with your fingers or metal objects.
- Do not bend, drop, or subject to strong physical shocks.
- Do not apply force to the card casing. Failure to observe this precaution could damage the card.
- Do not expose to water, heat, high levels of humidity, or direct sunlight.
- Do not format memory cards in a computer.

## ✍ The Write Protect Switch

SD memory cards are equipped with a write protect switch to prevent accidental loss of data. When this switch is in the “lock” position, the memory card can not be formatted and photos can not be deleted or recorded. To unlock the memory card, slide the switch to the “write” position.

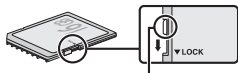

*Write-protect switch*

# Basic Setup

A language-selection dialog will be displayed the first time the camera is turned on. Choose a language and set the time and date. Photographs can not be taken until you have set the time and date.

## 1 Turn the camera on.

A language-selection dialog will be displayed.

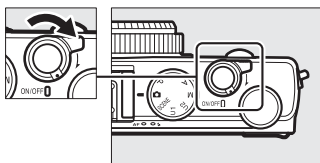

## 2 Choose a language and set the camera clock.

Use the multi selector and **OK** button to select a language and set the camera clock (note that the camera uses a 24-hour clock).



Select language



Select time zone

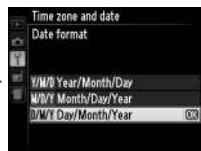

Select date format

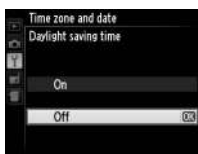

Select daylight saving time option



Press **◀** or **▶** to highlight items and rotate the multi selector or press **▲** or **▼** to change

**Note:** The language and date/time can be changed at any time using the **Language** and **Time zone and date** options in the setup menu (185).

When setup is complete, the lens will extend and the view through the lens will be displayed in the monitor.

 **The Clock Battery**

The camera clock is powered by an independent, rechargeable power source, which is charged as necessary when the main battery is installed or the camera is powered by an optional EP-5C power connector and EH-5b AC adapter (□ 247). A day of charging will power the clock for about 2 weeks. If the camera displays a warning at startup stating that the clock is not set the clock battery is exhausted and the clock has been reset. Set the clock to the correct time and date (□ 185).

 **The Camera Clock**

The camera clock is less accurate than most watches and household clocks. Check the clock regularly against more accurate time pieces and reset as necessary.

# Basic Photography

## Battery Level and Card Capacity

Before shooting, turn the camera on and check the battery level and number of exposures remaining. Battery level is shown in the monitor as follows:



*Battery indicator*      *Number of exposures remaining*

| Monitor  | Description  |
|--|--|
|  | Battery fully charged.   |
|  | Battery partially discharged.  |
|  | Low battery. Ready fully-charged spare battery or prepare to charge battery. |
| <b>Shutter release disabled.<br/>Recharge battery.</b> | Battery exhausted; shutter release disabled.<br>Charge or exchange battery.  |

The monitor also shows the number of exposures remaining, or in other words the number of photographs that can be taken at current settings (values over 1000 are rounded down to the nearest hundred; e.g., values between 1600 and 1699 are shown as 1.6 k). If a warning is displayed stating that there is not enough memory for additional photographs, insert another memory card or delete some photos.

### **Auto Power Off**

If no operations are performed for the length of time selected for **Auto off timer** in the setup menu (📖 189; the default for both shooting and playback is about 1 minute), the monitor will turn off to save power and the power-on lamp will flash. The display can be reactivated using the power switch, rotating the mode dial, or by pressing the shutter-release or  button. If no operations are performed for a further three minutes or so, the camera will turn off automatically.



# “Point-and-Shoot” Photography (📷 Mode)

This section describes how to take photographs in 📷 mode, automatic “point-and-shoot” modes in which the majority of settings are controlled by the camera in response to shooting conditions.

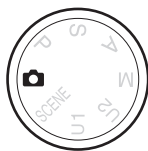

## 1 Select 📷.

Mode dial

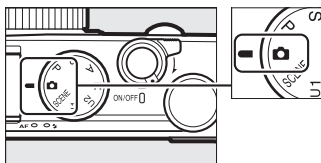

## 2 Ready the camera.

Keep your elbows propped lightly against your torso for support and place one foot half a pace ahead of the other to keep your upper body stable. Be careful that your fingers or hair, the camera strap, or other objects do not obstruct the lens, flash, AF-assist illuminator, or microphone. When using the flash to take pictures in “tall” (portrait) orientation, hold the camera so that the flash is above the lens. If lighting is poor, use the built-in flash (📖 112) or mount the camera on a tripod to prevent blur.



## 3 Frame the photograph.

## 4 Press the shutter-release button halfway.

Press the shutter-release button halfway to focus. If a face is detected, the camera will focus on the face; otherwise, the camera will focus on the subject in the focus area selected with the multi selector before the shutter-release button was pressed halfway. When the focus operation is complete, the focus area will light green, the AF lamp/memory-card access lamp will light, and focus will lock (if the camera is unable to focus, the focus area will flash red and the AF lamp/memory-card access lamp will flash). If the subject is poorly lit, the AF-assist illuminator (📖 180) may light to assist the focus operation.

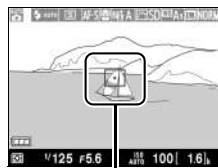

Focus area

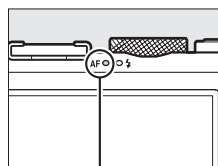
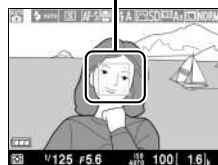

AF lamp/memory-card access lamp

## 5 Shoot.

Smoothly press the shutter-release button the rest of the way down to release the shutter and record the photograph. The AF lamp/memory-card access lamp will light while the photograph is being recorded to the memory card. *Do not eject the memory card or remove or disconnect the power source until the lamp has gone out and recording is complete. The photograph will be displayed in the monitor for about a second when shooting is complete.*



## The Shutter-Release Button

The camera has a two-stage shutter-release button. The camera focuses when the shutter-release button is pressed halfway. To take the photograph, press the shutter-release button the rest of the way down.





*Focus: press halfway*



*Shoot: press all the way down*

## Getting Good Results with Autofocus

Autofocus does not perform well under the conditions listed below, and in rare instances the focus area and AF lamp/memory-card access lamp may light green even when the camera is not in focus. If the camera is unable to focus using autofocus, try pressing the shutter-release button halfway a few times, focus manually ( 80) or use focus lock ( 79) to focus on another subject at the same distance and then recompose the photograph.

- The subject is extremely dark.
- The frame contains areas of sharply contrasting brightness (e.g., the subject is half in the shade).
- There is little or no contrast between the subject and the background (e.g., the subject is the same color as the background).
- The focus area contains objects at different distances from the camera (e.g., the subject is inside a cage).
- The subject is dominated by regular geometric patterns (e.g., blinds or a row of windows in a skyscraper).
- The subject is moving quickly.



### **The Shooting Display**

Although they will not appear in the final picture, jagged edges, color fringing, moiré, and bright spots may appear in the monitor, while bright bands may appear in some areas with flashing signs and other intermittent light sources or if the subject is briefly illuminated by a flash or other bright, momentary light source. In addition, distortion may occur if the camera is panned horizontally or an object moves at high speed through the frame. Flicker and banding visible in the monitor under fluorescent, mercury vapor, or sodium lamps can be reduced using **Flicker reduction** (☐ 184), although they may still be visible in the final photograph at some shutter speeds. Note that the temperature of the camera's internal circuits may rise and noise (bright spots, randomly-spaced bright pixels, or fog) may be displayed if the camera is used continuously for extended periods (the camera may also become noticeably warm, but this does not indicate a malfunction).

### **Temperature Warnings**



If the ambient temperature is high or the camera has been used for extended periods, particularly in continuous release mode, a warning may be displayed and the camera may turn off automatically to prevent damage to its internal circuits. If a temperature warning is displayed when you turn the camera on, allow the camera to turn off and wait for the internal circuits to cool before trying again.



# Basic Playback

- 1 Press the  button.**  
A photograph will be displayed in the monitor.



- 2 View additional pictures.**  
Additional pictures can be displayed by pressing  or  or by rotating the multi selector or command dial.



To end playback and return to shooting mode, press the shutter-release button halfway.



# Deleting Unwanted Photographs



To delete the photograph currently displayed in the monitor, press the  button. *Note that photographs can not be recovered once deleted.*

## 1 Display the photograph.

Display the photograph you wish to delete as described on the preceding page.



## 2 Delete the photograph.

Press the  button. A confirmation dialog will be displayed; press the  button again to delete the image and return to playback. To exit without deleting the picture, press .

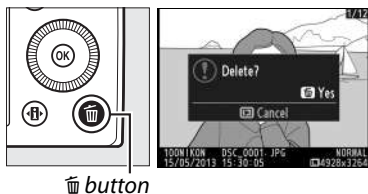

### Delete

To delete selected images, all images taken on a selected date, or all images in a chosen folder, use the **Delete** option in the playback menu ( 150).

# Creative Photography (Scene Modes)

Choosing a scene mode automatically optimizes settings to suit the selected scene.



## SCENE Mode

To view the currently selected scene, rotate the mode dial to SCENE. To choose another scene, rotate the command dial. The selected scene is shown by an icon in the monitor.

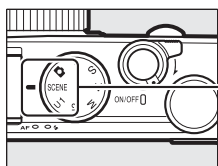

Mode dial

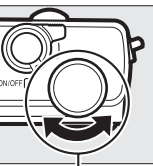

Command dial



Monitor

### **Portrait**

Use for portraits with soft, natural-looking skin tones. If the subject is far from the background, background details will be softened to lend the composition a sense of depth.

### **Landscape**

Use for vivid landscape shots in daylight.

### **Child**

Use for snapshots of children. Clothing and background details are vividly rendered, while skin tones remain soft and natural.

 **Sports**

Fast shutter speeds freeze motion for dynamic sports shots in which the main subject stands out clearly. While the shutter-release button is pressed all the way down, the camera will take up to 26 shots at frame rates as high as 4 fps (normal quality, size L; all figures are approximate).

 **Close up**

Use for close-up shots of flowers, insects, and other small objects.

 **Night Portrait**

Use for a natural balance between the main subject and the background in portraits taken under low light.

 **Night Landscape**

Reduce noise and unnatural colors when photographing night landscapes, including street lighting and neon signs.

 **Party/Indoor**

Capture the effects of indoor background lighting. Use for parties and other indoor scenes.

 **Beach/Snow**

Capture the brightness of sunlit expanses of water, snow, or sand.

 **Sunset**

Preserves the deep hues seen in sunsets and sunrises.

 **Dusk/Dawn**

Preserves the colors seen in the weak natural light before dawn or after sunset.

 **Pet Portrait**

Use for portraits of active pets.

 **Candlelight**

Capture the effects of background lighting in photographs taken by candlelight.

 **Blossom**

Use for fields of flowers, orchards in bloom, and other landscapes featuring expanses of blossoms.

 **Autumn Colors**

Captures the brilliant reds and yellows in autumn leaves.

 **Food**

Use for vivid photographs of food.

 **Silhouette**

Silhouette subjects against bright backgrounds.

 **High Key**

Use with bright scenes to create bright images that seem filled with light.

 **Low Key**

Use with dark scenes to create dark, somber images with prominent highlights.





## 4 Choose a shooting mode.

Aperture can not be adjusted while recording is in progress; in A and M modes, adjust aperture before beginning recording. Shutter speed can only be adjusted in mode M, when it can be set to values between  $1/8000$  s and  $1/30$  s. Flexible program (□ 53) is not available.

## 5 Focus.

Frame the opening shot and focus as described in Steps 3 and 4 on page 29. When using manual focus (□ 74), note that focus can not be adjusted during recording; adjust focus before recording begins.



## 6 Start recording.

Press the shutter-release button the rest of the way down to start recording movie footage with sound. A recording indicator and the time available are displayed in the monitor. In P, S, and A modes, exposure can be altered by up to  $\pm 2$  EV in steps of  $1/3$  EV by pressing the  (Ⓢ/Ⓞ) button and rotating the command dial (□ 87).

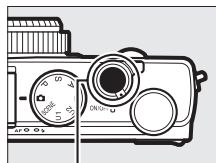

Shutter-release button

Recording indicator



Time remaining



## 7 End recording.

Press the shutter-release button all the way down to end recording. Recording will end automatically when the maximum length is reached, the memory card is full or another mode is selected.

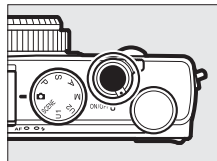

### **Maximum Length**

The maximum length for individual movie files is 20 minutes or 29 minutes 59 seconds (☞ 43); note that depending on memory card write speed, shooting may end before this length is reached (☞ 251).

### **Autofocus and AF-Area Modes**

For information on choosing autofocus and AF-area modes, see page 75 and 76 respectively.

### **Full-Time-Servo AF (AF-F)**

In AF-F mode, the camera will adjust focus in response to changes in the distance to the subject during shooting (☞ 75).

### **AF-ON**

If **AF-ON** is selected for **Assign Fn1 button** in the setup menu (☞ 193), autofocus can be initiated by pressing the Fn1 button.

### **Focus and Exposure Lock**

Focus and/or exposure lock can be assigned to the Fn1 button using the **Assign Fn1 button** option in the setup menu (☞ 193).

### **ISO Sensitivity**

In mode M, ISO sensitivity can be manually set to values between ISO 100 and 6400 (☞ 81). In other modes, the camera automatically selects a value between ISO 100 and 6400.

# The Movie Recording Display



| Item               | Description                                |    |
|--------------------|--|----|
| ① "No movie" icon  | Indicates that movies can not be recorded. | —  |
| ② Movie frame size | The frame size for movie recording.        | 43 |
| ③ Time remaining   | The recording time available for movies.   | 39 |

## Before Recording

Choose a color space before recording (📖 178).

### **Recording Movies**

Flicker, banding, or distortion may be visible in the monitor and in the final movie under fluorescent, mercury vapor, or sodium lamps or if the camera is panned horizontally or an object moves at high speed through frame (for information on reducing flicker and banding, see **Flicker reduction**,  184). Jagged edges, color fringing, moiré, and bright spots may also appear. Bright bands may appear in some areas of the frame with flashing signs and other intermittent light sources or if the subject is briefly illuminated by a flash or other bright, momentary light source. When recording movies, avoid pointing the camera at the sun or other strong light sources. Failure to observe this precaution could result in damage to the camera's internal circuitry.

The camera can record both video and sound; do not cover the microphone during recording. Note that the built-in microphone may record lens noise during autofocus.

Note that the temperature of the camera's internal circuits may rise and noise (bright spots, randomly-spaced bright pixels, or fog) may be displayed if the camera is used continuously for extended periods (the camera may also become noticeably warm, but this does not indicate a malfunction).

If the ambient temperature is high or the camera has been used for extended periods, particularly in continuous release mode, a warning may be displayed and the camera may turn off automatically to prevent damage to its internal circuits. If a temperature warning is displayed when you turn the camera on, allow the camera to turn off and wait for the internal circuits to cool before trying again.

### **See Also**

Frame size and movie quality options are available in the **Movie settings** menu ( 43).

# Movie Settings

Use the **Movie settings** option in the shooting menu to adjust the following settings.

- **Frame size/frame rate, Movie quality:** Choose from the following options.

| Frame size/frame rate  |                         | Movie quality   | Maximum length<br>(★ High quality/<br>Normal) <sup>2</sup> |
|--|-------------------------|---|--|
| Frame size<br>(pixels)   | Frame rate <sup>1</sup> | Maximum bit rate<br>(Mbps)<br>(★ High quality/<br>Normal) |  |
| $\frac{1080}{60} \frac{PA}{25} / \frac{1080}{60} \frac{P}{25}$ | 1920 × 1080             | 30p   | 20 min/<br>29 min 59 s                                     |
| $\frac{1080}{60} \frac{PA}{25} / \frac{1080}{25} \frac{P}{25}$ | 1920 × 1080             | 25p   |  |
| $\frac{1080}{60} \frac{PA}{25} / \frac{1080}{24} \frac{P}{24}$ | 1920 × 1080             | 24p   |  |
| $\frac{720}{60} \frac{PA}{25} / \frac{720}{60} \frac{P}{25}$   | 1280 × 720              | 30p   | 29 min 59 s/<br>29 min 59 s                                |
| $\frac{720}{60} \frac{PA}{25} / \frac{720}{25} \frac{P}{25}$   | 1280 × 720              | 25p   |  |
| $\frac{720}{60} \frac{PA}{25} / \frac{720}{24} \frac{P}{24}$   | 1280 × 720              | 24p   |  |

- 1 Listed value. Actual frame rates for 30p, 25p, and 24p are 29.97, 25, and 23.976 fps respectively.
- 2 Camera may turn off automatically to prevent overheating before maximum length is reached.

- **Microphone:** Turn the audio recording on or off.



## Frame Size and Rate

Frame size and rate affects the distribution and amount of noise (randomly-spaced bright pixels, fog, or bright spots).

## 1 Select Movie settings.

Press the **MENU** button to display the menus. Highlight **Movie settings** in the shooting menu and press **▶**.

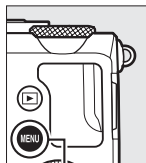

MENU button

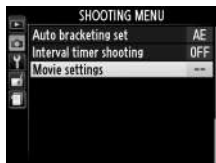

## 2 Choose movie options.

Highlight the desired item and press **▶**, then highlight an option and press **OK**.





### The Icon

 is displayed in full-frame and movie playback if the movie was recorded without sound.





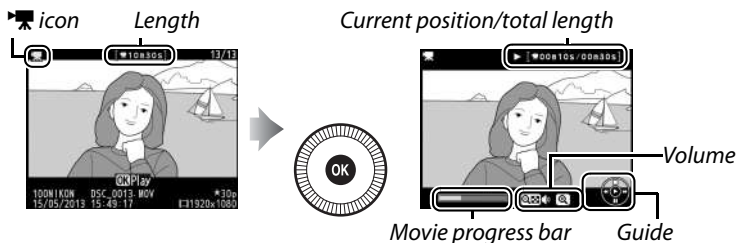

# Viewing Movies









Movies are indicated by a  icon in full-frame playback ( 132). Press  to start playback.



The following operations can be performed:

| To                 | Use  | Description  |
|--------------------|--|--|
| Pause              |   | Pause playback.  |
| Play               |   | Resume playback when movie is paused or during rewind/advance.   |
| Advance/<br>rewind |  | Speed increases with each press, from 2x to 4x to 8x to 16x; keep pressed to skip to beginning or end of movie (first frame is indicated by  in top right corner of monitor, last frame by  ). If playback is paused, movie rewinds or advances one frame at a time; hold for continuous rewind or advance. Frame advance/rewind can also be performed by rotating multi selector or command dial. |





| To                            | Use   | Description  |
|-------------------------------|---|--|
| Adjust volume                 |  (?)  | Press  to increase volume,  (?) to decrease. |
| Return to full-frame playback |  /  | Press  or  to exit to full-frame playback. |
| Exit to shooting mode         |    | Press shutter-release button halfway to exit to shooting display.  |
| Display menus                 | <b>MENU</b>   | See page 172 for more information.   |





# Editing Movies

Trim footage to create edited copies of movies or save selected frames as JPEG stills.

| Option  | Description   |
|---|---|
|  <b>Choose start/end point</b> | Create a copy from which the opening or closing footage has been removed. |
|  <b>Save selected frame</b>    | Save a selected frame as a JPEG still.                                    |

## Trimming Movies

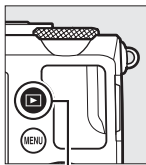

To create trimmed copies of movies:

- 1 Display a movie full frame.**  
Press the  button to display pictures full frame in the monitor and press  and  to scroll through pictures until the movie you wish to edit is displayed.



 button



- 2 Choose a starting or end point.**  
Play the movie back as described on page 45, pressing  to start and resume playback and  to pause. Your approximate position in the movie can be ascertained from the movie progress bar.



Movie progress bar

### 3 Display movie edit options.

Press the  (PZ/OK) button to display movie edit options.

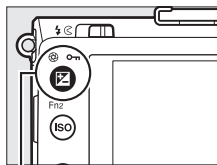

 (PZ/OK) button

### 4 Select Choose start/end point.



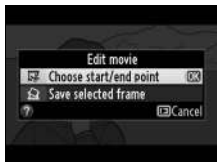

Highlight **Choose start/end point** and press .

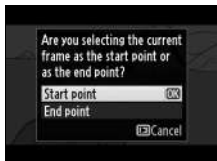

The dialog shown at right will be displayed; choose whether the current frame will be the starting or end point of the copy and press .



### 5 Delete frames.

If the desired frame is not currently displayed, press  or  or rotate the command dial to advance or rewind. To switch the current selection from start point () to end point () or vice versa, press  (PZ/OK).



Once you have selected the start point and/or end point, press . All frames before the selected start point and after the selected end point will be removed from the copy.



## 6 Save the copy.

Highlight one of the following and press **OK**:

- **Save as new file:** Save the copy to a new file.
- **Overwrite existing file:**  
Replace the original movie file with the edited copy.
- **Cancel:** Return to Step 5.
- **Preview:** Preview the copy.



Edited copies are indicated by a  icon in full-frame playback.



### **Trimming Movies**

Movies must be at least 2 seconds long. If a copy can not be created at the current playback position, the current position will be displayed in red in Step 5 and no copy will be created. The copy will not be saved if there is insufficient space available on the memory card.

Copies have the same time and date of creation as the original.

# Saving Selected Frames

To save a copy of a selected frame as a JPEG still:



## 1 View the movie and choose a frame.

Play the movie back as described on page 45; your approximate position in the movie can be ascertained from the movie progress bar. Pause the movie at the frame you intend to copy.



Progress bar

## 2 Display movie edit options.

Press the  (/) button to display movie edit options.

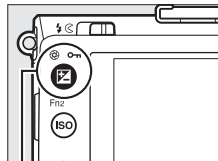

 (/) button

## 3 Choose Save selected frame.

Highlight **Save selected frame** and press .

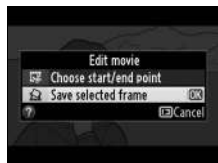

## 4 Create a still copy.

Press **▲** to create a still copy of the current frame.



## 5 Save the copy.

Highlight **Yes** and press **OK** to create a JPEG copy of the selected frame. Movie stills are indicated by a  icon in full-frame playback.



### **Save Selected Frame**

JPEG movie stills created with the **Save selected frame** option can not be retouched. JPEG movie stills lack some categories of photo information (📖 134).

# P, S, A, and M Modes

## Shutter Speed and Aperture

P, S, A, and M modes offer different degrees of control over shutter speed and aperture:



|   | Mode                            | Description   |
|---|---------------------------------|---|
| P | Programmed auto<br>(☞ 53)       | Camera sets shutter speed and aperture for optimal exposure. Recommended for snapshots and in other situations in which there is little time to adjust camera settings. |
| S | Shutter-priority auto<br>(☞ 54) | User chooses shutter speed; camera selects aperture for best results. Use to freeze or blur motion.   |
| A | Aperture-priority auto (☞ 55)   | User chooses aperture; camera selects shutter speed for best results. Use to blur background or bring both foreground and background into focus.                        |
| M | Manual (☞ 56)                   | User controls both shutter speed and aperture. Set shutter speed to “Bulb” or “Time” for long time-exposures (☞ 58).  |

## P: Programmed Auto

In this mode, the camera automatically adjusts shutter speed and aperture according to a built-in program to ensure optimal exposure in most situations. This mode is recommended for snapshots and other situations in which you want to leave the camera in charge of shutter speed and aperture.



PS  
AM

### Flexible Program

In mode P, different combinations of shutter speed and aperture can be selected by rotating the command dial (“flexible program”).

Rotate the dial

counterclockwise for

large apertures (low f-numbers) that blur background details or fast shutter speeds that “freeze” motion. Rotate the dial in the opposite direction for small apertures (high f-numbers) that increase depth of field or slow shutter speeds that blur motion. All combinations produce the same exposure. While flexible program is in effect, a **P\*** indicator is displayed. To restore default shutter speed and aperture settings, rotate the command dial until the indicator is no longer displayed, choose another mode, or turn the camera off.

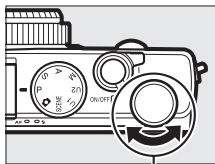

*Command dial*



# S: Shutter-Priority Auto



To choose a shutter speed, rotate the command dial.

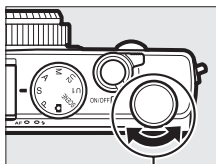

*Command dial*



PS  
AM

In shutter-priority auto, you choose the shutter speed while the camera automatically selects the aperture that will produce the optimal exposure. Use slow shutter speeds to suggest motion by blurring moving subjects, fast shutter speeds to “freeze” motion.



*Fast shutter speed ( $1/1600$  s)*



*Slow shutter speed ( $1/6$  s)*

# A: Aperture-Priority Auto



To choose aperture, rotate the command dial.

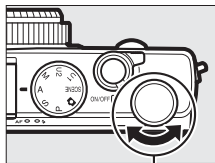

*Command dial*



In aperture-priority auto, you choose the aperture while the camera automatically selects the shutter speed that will produce the optimal exposure. Large apertures (low f-numbers) increase flash range and reduce depth of field, blurring objects behind and in front of the main subject. Small apertures (high f-numbers) increase depth of field, bringing out details in the background and foreground. Short field depths are generally used in portraits to blur background details, long field depths in landscape photographs to bring the foreground and background into focus.

PS  
AM





*Large aperture (f/5.6)*



*Small aperture (f/22)*

# M: Manual

In manual mode, you control both shutter speed and aperture. Rotate the command dial to choose a shutter speed, and the multi selector to set aperture (shutter speed can also be set by keeping the  button pressed and rotating the multi selector, aperture by keeping the  button pressed and rotating the command dial). Use the exposure indicators to check exposure.

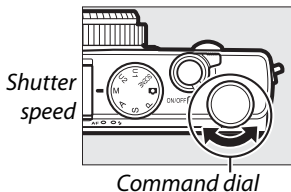

Multi selector

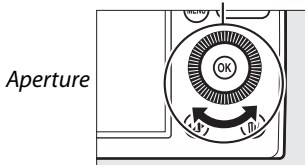

### **The Exposure Indicator**

If a shutter speed other than “bulb” or “time” is selected (□ 58), the exposure indicator shows whether the photograph would be under- or over-exposed at current settings. If the subject is too bright or too dark for the camera to meter, the indicator will flash.

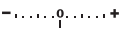
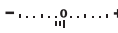
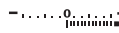
| Optimal exposure  | Underexposed by $\frac{1}{3}$ EV  | Overexposed by over 2 EV  |
|---|---|---|
|  |  |  |

- The baseline for the exposure indicator is adjusted for exposure compensation (□ 88).

### **See Also**

The **Reverse indicators** option in the setup menu can be used to reverse the exposure indicators so that negative values are displayed on the right and positive values on the left (□ 192).

## ■ ■ Long Time-Exposures (M Mode Only)

Select the following shutter speeds for long time-exposures of moving lights, the stars, night scenery, or fireworks.

- **Bulb:** The shutter remains open while the shutter-release button is held down. To prevent blur, use a tripod or an optional MC-DC2 remote cord (□ 231). The shutter-release button on the MC-DC2 performs the same role as the camera shutter-release button.
- **Time:** Requires an optional ML-L3 remote control (□ 231). Start the exposure by pressing the ML-L3 shutter-release button. The shutter remains open for 30 minutes or until the button is pressed a second time.



*Length of exposure: 35 s*

PS  
AM

### 1 Ready the camera.

Mount the camera on a tripod or place it on a stable, level surface. To prevent loss of power before the exposure is complete, use a fully charged EN-EL20 battery or an optional EH-5b AC adapter and EP-5C power connector. Note that noise (bright spots, randomly-spaced bright pixels, or fog) may be present in long exposures; before shooting, choose **On** for **Long exposure NR** in the shooting menu (□ 179).

### 2 Rotate the mode dial to M. *Mode dial*

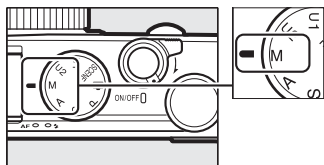

---

### 3 Choose a shutter speed.

Rotate the command dial to choose a shutter speed of **Bulb**. For a shutter speed of “**Time**”, select a remote control release mode (📖 66) after choosing the shutter speed.



Command dial



---

### 4 Open the shutter.

**Bulb:** After focusing, press the shutter-release button on the camera or optional remote cord all the way down. Keep the shutter-release button pressed until the exposure is complete.

**Time:** Press the ML-L3 shutter-release button all the way down.

---

### 5 Close the shutter.

**Bulb:** Take your finger off the shutter-release button.

**Time:** Press the ML-L3 shutter-release button all the way down. Shooting ends automatically after 30 minutes.

# User Settings: U1 and U2

## Modes

Assign frequently-used settings to the U1 and U2 positions on the mode dial.

### Saving User Settings

- 1 Select a mode.**  
Rotate the mode dial to the desired mode.

Mode dial

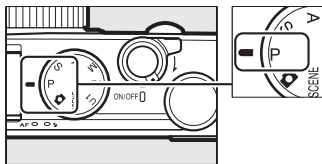

- 2 Adjust settings.**  
Make the desired adjustments to flexible program, shutter speed, aperture, exposure and flash compensation, flash mode, metering, autofocus and AF-area modes, bracketing, and shooting menu (📖 176) settings (note that the camera will not store the options selected for **Reset shooting menu**, **Storage folder**, **Manage Picture Control**, **Release mode**, or **Interval timer shooting**).

### 3 Select **Save user settings**.

Press the **MENU** button to display the menus. Highlight **Save user settings** in the setup menu and press ►.

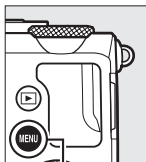

MENU button



### 4 Select **Save to U1** or **Save to U2**.

Highlight **Save to U1** or **Save to U2** and press ►.

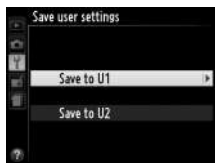

### 5 Save user settings.

Highlight **Save settings** and press **OK** to assign the settings selected in Steps 1 and 2 to the mode dial position selected in Step 4.



# Recalling User Settings

Simply rotate the mode dial to U 1 to recall the settings assigned to **Save to U1**, or to U2 to recall the settings assigned to **Save to U2**.

Mode dial

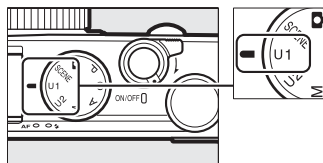

# Resetting User Settings

To reset settings for U 1 or U2 to default values:

## 1 Select Reset user settings.

Press the **MENU** button to display the menus. Highlight **Reset user settings** in the setup menu and press **▶**.

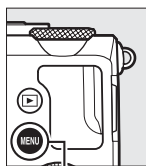

MENU button



## 2 Select Reset U1 or Reset U2.

Highlight **Reset U1** or **Reset U2** and press **▶**.

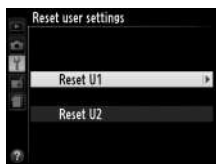

## 3 Reset user settings.







Highlight **Reset** and press **OK**. The shooting mode will be set to P.



# Release Mode

## Single-Frame, Continuous, Self-timer, Remote, and Movie Modes

Choose from the following release modes:

| Mode   | Description  |
|--|--|
|     | <b>Single frame:</b> Camera takes one photograph each time shutter-release button is pressed all the way down.                                       |
|     | <b>Continuous:</b> The camera takes photographs at about 4 frames per second (fps) while the shutter-release button is pressed all the way down.     |
|     | <b>Self-timer:</b> Use self-timer for self-portraits or to reduce blurring caused by camera shake (□ 66).  |
|  2s | <b>Delayed remote (ML-L3):</b> Shutter is released 2 s after shutter-release button on optional ML-L3 (□ 231) remote control is pressed (□ 66).      |
|     | <b>Quick-response (ML-L3):</b> Shutter is released when shutter-release button on optional ML-L3 (□ 231) remote control is pressed (□ 66).           |
|    | <b>Movie recording:</b> Movie recording begins when shutter-release button is pressed all the way down and ends when button is pressed again (□ 38). |

# 1 Press the button.

Shooting information will be displayed in the monitor.

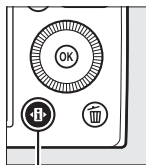

 button



Information display

# 2 Display release mode options.

Highlight the current release mode and press  to display release mode options.

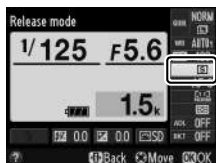

# 3 Select a release mode.

Highlight a release mode and press . Press the shutter-release button halfway to return to the shooting display.



## Continuous Release Mode

Continuous release mode can not be used with the built-in flash; lower the flash or turn the flash off (☞ 112–116) when shooting in continuous release mode.

## Buffer Size

The approximate number of images that can be stored in the memory buffer at current settings is shown in the monitor exposure-count display while the shutter-release button is pressed halfway (up to 26 large, normal-quality JPEG images or 9 large, RAW+JPEG fine images can be stored in the buffer, although the number of pictures that can be taken before the frame rate drops varies with shooting conditions and memory card performance). The illustration shows the display when space remains in the buffer for about 17 pictures.



## The Memory Buffer

The camera is equipped with a memory buffer for temporary storage, allowing shooting to continue while photographs are being saved to the memory card. Up to 100 photographs can be taken in succession.

While photographs are being recorded to the memory card, the AF lamp/memory-card access lamp will light (☞ 23). Depending on shooting conditions and memory card performance, recording may take from a few seconds to a few minutes. *Do not remove the memory card or remove or disconnect the power source until the access lamp has gone out.* If the camera is switched off while data remain in the buffer, the power will not turn off until all images in the buffer have been recorded. If the battery is exhausted while images remain in the buffer, the shutter release will be disabled and the images transferred to the memory card.

## The Shooting Menu

The release mode can also be selected using the **Release mode** option in the shooting menu (☞ 176).



# Self-Timer and Remote Control Modes

The self-timer and optional ML-L3 remote control (📖 231) allow the photographer to be at a distance from the camera when a photo is taken.

## 1 Mount the camera on a tripod.

Mount the camera on a tripod or place the camera on a stable, level surface.

## 2 Select a release mode.

Select 🕒 **Self-timer**, ⌚ **2s Delayed remote (ML-L3)**, or ⌚ **Quick-response (ML-L3)** mode (📖 63; note that if no operations are performed for about a minute after a remote control mode is selected, the camera will turn off automatically).

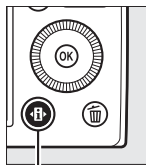

Fn button



Information display

### 3 Frame the photograph and shoot.

**Self-timer mode:** Press the shutter-release button halfway to focus, and then press the button the rest of the way down. The self-timer lamp will start to flash, stopping two seconds before the photo is taken. The shutter will be released ten seconds after the timer starts.

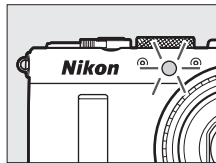

**Remote control mode (ML-L3):** From a distance of 5 m (16 ft) or less, aim the transmitter on the ML-L3 at the infrared receiver on the front of the camera ( 3 ) and press the ML-L3 shutter-release button to focus and shoot. *In delayed remote mode*, the self-timer lamp will light for about two seconds before the shutter is released. *In quick-response remote mode*, the self-timer lamp will flash after the shutter has been released.

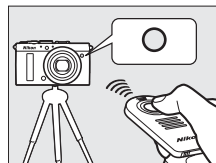

Turning the camera off cancels self-timer and remote control release modes and restores the previously selected release mode.





### ✔ Before Using the ML-L3 Remote Control

Before using the ML-L3 for the first time, remove the clear plastic battery-insulator sheet.

### ✔ Remote Control Photography

Note that the shutter may not respond to the ML-L3 remote control if there is a bright light source behind the camera.

In —quick response (ML-L3)—and  2s—delayed release (ML-L3)—release modes, the camera responds only to the shutter-release button on the ML-L3 remote control.

### ✍ Using the Built-in Flash

To use the flash, slide the flash pop-up control to raise the flash before shooting. The flash will not fire if it is raised while the self-timer or delayed remote release timer is counting down. Note that when the flash is used in self-timer mode, only one photograph will be taken when the flash fires, regardless of the number of exposures selected for **Self-timer** in the setup menu ( 188). In remote control modes, the flash begins charging when remote control mode is selected; once the flash is charged, it will automatically fire when required. The camera will only respond to the ML-L3 shutter-release button once the flash has charged. In flash modes that support red-eye reduction, shutter release will be delayed for about a second to allow red-eye reduction to take effect.

### ✍ See Also

The **Self-timer** and **Remote on duration (ML-L3)** options in the setup menu can be used to choose the duration of the self-timer and the number of shots taken and how long the camera will wait for a signal from the remote ( 188, 189).

# Image Quality and Size

Together, image quality and size determine how much space each photograph occupies on the memory card. Larger, higher quality images can be printed at larger sizes but also require more memory, meaning that fewer such images can be stored on the memory card (☐ 252).

## Image Quality

Choose a file format and compression ratio (image quality).

| Option                         | File type    | Description   |
|--------------------------------|--------------|---|
| <b>NEF (RAW) + JPEG fine</b>   | NEF/<br>JPEG | Two images are recorded: one NEF (RAW) image and one fine-quality JPEG image.   |
| <b>NEF (RAW) + JPEG normal</b> |              | Two images are recorded: one NEF (RAW) image and one normal-quality JPEG image.   |
| <b>NEF (RAW) + JPEG basic</b>  |              | Two images are recorded: one NEF (RAW) image and one basic-quality JPEG image.  |
| <b>NEF (RAW)</b>               | NEF          | Raw data from the image sensor are saved directly to the memory card. Settings such as white balance and contrast can be adjusted after shooting. |
| <b>JPEG fine</b>               | JPEG         | Record JPEG images at a compression ratio of roughly 1 : 4 (fine quality).  |
| <b>JPEG normal</b>             |              | Record JPEG images at a compression ratio of roughly 1 : 8 (normal quality).  |
| <b>JPEG basic</b>              |              | Record JPEG images at a compression ratio of roughly 1 : 16 (basic quality).  |



# 1 Press the button.

Shooting information will be displayed in the monitor.

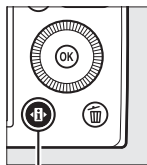

 button



Information display

# 2 Display image quality options.

Highlight the current image quality in the information display and press .



# 3 Choose a file type.

Highlight an option and press . To return to shooting mode, press the shutter-release button halfway.



## **NEF (RAW) Images**

Note that the option selected for image size does not affect the size of NEF (RAW) images. White balance bracketing (☐ 123) is not available at image quality settings of NEF (RAW) or NEF (RAW)+JPEG.

NEF (RAW) images can be viewed on the camera or using software such as Capture NX 2 (available separately; ☐ 231) or ViewNX 2 (available on the supplied ViewNX 2 CD). JPEG copies of NEF (RAW) images can be created using the **NEF (RAW) processing** option in the retouch menu (☐ 209).

## **NEF (RAW) + JPEG**

When photographs taken at NEF (RAW) + JPEG are viewed on the camera, only the JPEG image will be displayed. When photographs taken at these settings are deleted, both NEF and JPEG images will be deleted.

## **The Shooting Menu**

Image quality can also be adjusted using the **Image quality** option in the shooting menu (☐ 176).





## **See Also**

Image quality and size can also be adjusted by rotating the command dial while keeping the **ISO** (Fn2) button pressed (☐ 194). For information on using the Fn1 button to record NEF (RAW) images, see page 193.



# Image Size

Choose a size for JPEG images:

| Image size   | Size (pixels) | Print size (cm/in.)*    |
|--|---------------|-------------------------|
|  <b>Large</b>  | 4928 × 3264   | 41.7 × 27.6/16.4 × 11.4 |
|  <b>Medium</b> | 3696 × 2448   | 31.3 × 20.7/12.3 × 8.2  |
|  <b>Small</b>  | 2464 × 1632   | 20.9 × 13.8/8.2 × 5.4   |

\* Approximate size when printed at 300 dpi. Print size in inches equals image size in pixels divided by printer resolution in dots per inch (dpi); 1 inch=approximately 2.54 cm).

## 1 Press the button.

Shooting information will be displayed in the monitor.

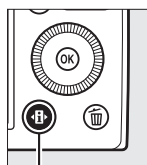

 button

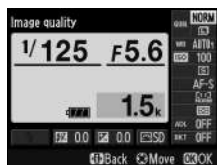

Information display

## 2 Display image size options.

Highlight the current image size in the information display and press .

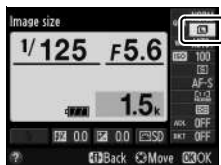

## 3 Choose an image size.

Highlight an option and press . To return to shooting mode, press the shutter-release button halfway.



### **The Shooting Menu**

Image size can also be adjusted using the **Image size** option in the shooting menu (📖 176).



### **The ISO (Fn2) Button**

Image quality and size can also be adjusted by rotating the command dial while keeping the **ISO (Fn2)** button pressed (📖 194).



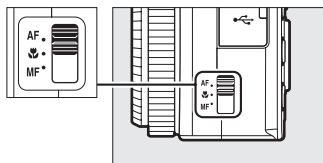

# Focus

The focus-mode selector can be used to choose between normal and macro autofocus and manual focus modes. The user can also select the focus area for automatic or manual focus (☞ 75, 80) or use focus lock to focus to recompose photographs after focusing (☞ 79).



*Focus-mode selector*

## **Normal and Macro Autofocus**

Use normal autofocus to focus on subjects about 50 cm (1 ft 8 in.) or more in front of the lens, macro autofocus to focus on flowers, insects, or other small objects at ranges of about 10 cm (4 in.) or more. Note that even when **AF** (normal autofocus) is selected, macro autofocus is used when  or  is chosen in scene mode.

## **Autofocus with Manual Override**

After pressing the shutter-release button halfway to focus using autofocus, you can make manual adjustments to focus by keeping the shutter-release button pressed halfway and rotating the focus ring (☞ 80). To refocus using autofocus, lift your finger from the shutter-release button and then press it halfway again.

# Autofocus

## Autofocus Mode

Choose from the following autofocus modes.

| Option                            | Description   |
|-----------------------------------|---|
| AF-S<br><b>Single-servo AF</b>    | For stationary subjects. Focus locks when shutter-release button is pressed halfway.  |
| AF-F<br><b>Full-time-servo AF</b> | For moving subjects. Camera focuses continuously until shutter-release button is pressed. Focus locks when shutter-release button is pressed halfway. |

### 1 Press the button.

Shooting information will be displayed in the monitor.

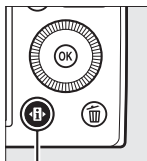

 button



Information display

### 2 Display autofocus modes.

Highlight the current autofocus mode in the information display and press .

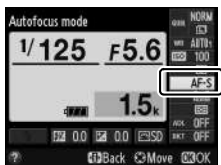





### 3 Choose a mode.

Highlight an option and press . To return to shooting mode, press the shutter-release button halfway.



# AF-Area Mode

Choose how the focus area for autofocus is selected in modes other than .

| Option  | Description   |
|---|---|
|  <b>Face-priority AF</b>    | The camera automatically detects and focuses on portrait subjects. Use for portraits.                                     |
|  <b>Wide-area AF</b>        | Use for hand-held shots of landscapes and other non-portrait subjects. Use the multi-selector to position the focus area. |
|  <b>Normal-area AF</b>      | Use for pin-point focus on a selected spot in the frame.  |
|  <b>Subject-tracking AF</b> | Track a selected subject as it moves through the frame.   |

- 1 Press the  button.**  
Shooting information will be displayed in the monitor.

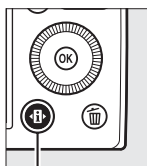

 button



Information display

- 2 Display AF-area mode options.**  
Highlight the current AF-area mode in the information display and press .

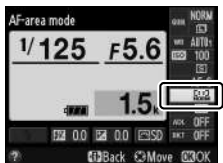

### 3 Choose an AF-area mode.

Highlight an option and press **OK**. To return to shooting mode, press the shutter-release button halfway.



**Face-priority AF:** The camera automatically detects and focuses on portrait subjects; the selected subject is indicated by a double yellow border (if multiple faces, up to a maximum of 35, are detected, the camera will focus on the closest subject; to choose a different subject, use the multi selector). If the camera can no longer detect the subject (because, for example, the subject has turned to face away from the camera), the border will no longer be displayed and the camera will focus using Normal-area AF.



*Focus area*

#### **Wide-area/normal-area AF:**

Use the multi selector to move the focus area anywhere in the frame, or press **OK** to position the focus area in the center of the frame.

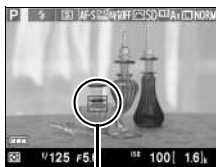

*Focus area*

**Subject-tracking AF:** Position the focus area over your subject and press **OK**. The focus area will track the selected subject as it moves through the frame. To end tracking, press **OK** again.



*Focus area*

Note that the camera may be unable to track subjects if they move quickly, leave the frame or are obscured by other objects, change visibly in size, color, or brightness, or are too small, too large, too bright, too dark, or similar in color or brightness to the background.



# Focus Lock

If the camera is unable to focus using autofocus (📖 75), use focus lock to recompose the photograph after focusing on another object at the same distance as your original subject.

## 1 Focus.

Position the subject in the selected focus area and press the shutter-release button halfway to initiate focus.

Check that the focus area is displayed in green. Focus will lock while the shutter-release button is pressed halfway.



## 2 Recompose the photograph and shoot.

Do not change the distance between the camera and the subject while focus lock is in effect. If the subject moves, focus again at the new distance.



### The Fn1 Button

Focus lock can also be assigned to the Fn1 button (📖 193), in which case focus can be kept locked between shots by keeping the Fn1 button pressed.

# Manual Focus

To focus manually, rotate the focus ring until the subject is in focus (the faster the ring is rotated, the more rapidly focus will be adjusted). To magnify the view in the monitor for precise focus, press the  button. While the view through the lens is zoomed in, the multi selector can be used to scroll to areas of the frame not visible in the monitor.

The distance indicator on the right side of the display shows the approximate focus distance (the actual focus distance varies with aperture) in meters or feet; the units used can be selected using the **MF distance indicator units** option in the setup menu (📖 192).

*Focus-mode selector*

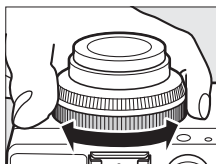
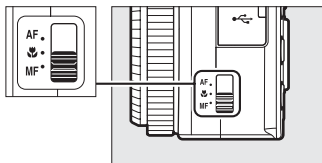

*Distance indicator*



# ISO Sensitivity

The higher the ISO sensitivity, the less light needed to make an exposure, allowing higher shutter speeds or smaller apertures, but the more likely the image is to be affected by noise (randomly-spaced bright pixels, fog, or lines). Noise is particularly likely at settings between Hi 0.3 (equivalent to ISO 8000) and Hi 2 (equivalent to ISO 25600). Choosing **Auto** allows the camera to set ISO sensitivity automatically in the range ISO 100 to 3200 in response to lighting conditions.

| Mode  | ISO sensitivity   |
|---|---|
|  SCENE | Auto; 100–6400 in steps of $1/3$ EV; Hi 0.3, Hi 0.7, Hi 1, Hi 2 |
| P, S, A, M  | 100–6400 in steps of $1/3$ EV; Hi 0.3, Hi 0.7, Hi 1, Hi 2       |

## 1 Press the button.

Shooting information will be displayed in the monitor.

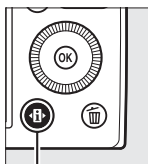

 button



Information display

## 2 Display ISO sensitivity options.

Highlight the current ISO sensitivity in the information display and press .

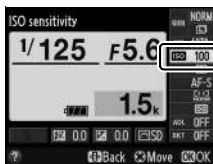

### 3 Choose an ISO sensitivity.

Highlight an option and press **OK**. To return to shooting mode, press the shutter-release button halfway.

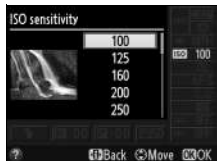

#### **Auto**

If the mode dial is rotated to P, S, A, or M after **Auto** is selected for ISO sensitivity in another mode, the ISO sensitivity last selected in P, S, A, or M mode will be restored.

#### **The Shooting Menu**

ISO sensitivity can also be adjusted using the **ISO sensitivity settings** option in the shooting menu (📖 176).



#### **See Also**

For information on enabling auto ISO sensitivity control in P, S, A, or M modes, see page 83. For information on using the **High ISO NR** option in the shooting menu to reduce noise at high ISO sensitivities, see page 179. For information on using the **ISO** (Fn2) button and the command dial to select ISO sensitivity, see page 194.

# Auto ISO Sensitivity Control (P, S, A, and M Modes Only)

If **On** is selected for **ISO sensitivity settings > Auto ISO sensitivity control** in the shooting menu, ISO sensitivity will automatically be adjusted if optimal exposure can not be achieved at the value selected by the user (ISO sensitivity is adjusted appropriately when the flash is used).

## 1 Select Auto ISO sensitivity control for ISO sensitivity settings in the shooting menu.

To display the menus, press the **MENU** button.

Select **ISO sensitivity settings** in the shooting menu, highlight **Auto ISO sensitivity control** and press **▶**.

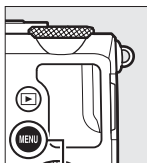

MENU button

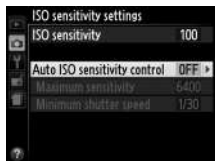

## 2 Select On.

Highlight **On** and press **OK** (if **Off** is selected, ISO sensitivity will remain fixed at the value selected by the user).

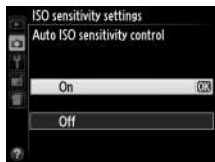

### 3 Adjust settings.

The maximum value for auto ISO sensitivity can be selected using **Maximum sensitivity** (the minimum value for auto ISO

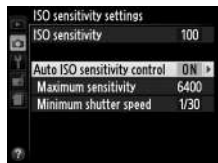

sensitivity is automatically set to ISO 100). In modes P and A, sensitivity will only be adjusted if underexposure would result at the shutter speed selected for **Minimum shutter speed** ( $1/1000-1$  s). Shutter speeds slower than the minimum value may be used if optimum exposure can not be achieved at the ISO sensitivity value selected for **Maximum sensitivity**. Press **OK** to exit when settings are complete.

ISO

#### **Auto ISO Sensitivity Control**



Noise (randomly-spaced bright pixels, fog, or lines) is more likely at higher sensitivities. Use the **High ISO NR** option in the shooting menu to reduce noise (see page 176). Note that ISO sensitivity may be raised automatically when auto ISO sensitivity control is used in combination with slow sync flash modes (available with the built-in flash and the optional flash units listed on page 226), possibly preventing the camera from selecting slow shutter speeds.



# Exposure

## Metering

Choose how the camera sets exposure in P, S, A, and M modes (in other modes, the camera selects the metering method automatically).

| Method  | Description  |
|---|--|
|  <b>Matrix metering</b>          | Produces natural results in most situations. Camera meters a wide area of the frame and sets exposure according to tone distribution, color, and composition.                            |
|  <b>Center-weighted metering</b> | Camera meters entire frame but assigns greatest weight to center area. Classic meter for portraits.  |
|  <b>Spot metering</b>            | Camera meters only current focus area, making it possible to meter off-center subjects. Ensures that subject will be correctly exposed, even when background is much brighter or darker. |



## 1 Press the button.

Shooting information will be displayed in the monitor.

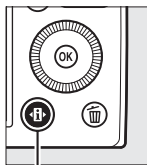

 button



Information display

## 2 Display metering options.

Highlight the current metering method in the information display and press .



## 3 Choose a metering method.

Highlight an option and press . To return to shooting mode, press the shutter-release button halfway.



### See Also

For information on using the **ISO** (Fn2) button and the command dial to choose a metering method, see page 194.

# Exposure Compensation

(P, S, and A Modes Only)

Exposure compensation is used to alter exposure from the value suggested by the camera, making pictures brighter or darker. It is most effective when used with center-weighted or spot metering (☐ 85). Choose from values between  $-5$  EV (underexposure) and  $+5$  EV (overexposure) in increments of  $1/3$  EV. In general, positive values make the subject brighter while negative values make it darker.





$-1$  EV



No exposure compensation



$+1$  EV

To choose a value for exposure compensation, press the  (/) button and rotate the command dial until the desired value is displayed in the monitor.

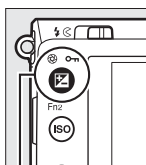

 (/) button

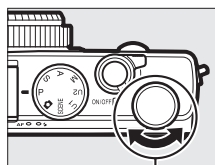

Command dial

Normal exposure can be restored by setting exposure compensation to  $\pm 0$ . Exposure compensation is not reset when the camera is turned off.



### **The Information Display**

Exposure compensation can also be adjusted by selecting the current exposure compensation setting in the information display (📖 7).

### **Using a Flash**

When a flash is used, exposure compensation affects both background exposure and flash level. The **Exposure comp. for flash** option in the shooting menu (📖 180) can be used to restrict the effects of exposure compensation to the background only.

### **Mode M**

In mode M, exposure compensation affects only the exposure indicator; shutter speed and aperture do not change. The value selected for exposure compensation in other modes remains in effect when mode M is selected.

### **See Also**

For information on automatically varying exposure over a series of shots, see page 123. For information on using the Fn1 button and the command dial to adjust exposure compensation, see page 193.







# White Balance

(P, S, A, and M Modes Only)

## White Balance Options

White balance ensures that colors are unaffected by the color of the light source. Auto white balance is recommended for most light sources; in P, S, A, and M modes, other values can be selected if necessary according to the type of source:

|   | Option                    | Color temp.* | Description   |
|---|---------------------------|--------------|---|
| AUTO  | Auto                      | 3500–8000 K  | Automatic white balance adjustment. Recommended in most situations. |
|   | Normal                    |              |   |
|   | Keep warm lighting colors |              |   |
|    | Incandescent              | 3000 K       | Use under incandescent lighting.                                    |
|    | Fluorescent               |              | Use with:   |
|   | Sodium-vapor lamps        | 2700 K       | • Sodium-vapor lighting (found in sports venues).                   |
|   | Warm-white fluorescent    | 3000 K       | • Warm-white fluorescent lights.                                    |
|   | White fluorescent         | 3700 K       | • White fluorescent lights.   |
|   | Cool-white fluorescent    | 4200 K       | • Cool-white fluorescent lights.                                    |
|   | Day white fluorescent     | 5000 K       | • Daylight white fluorescent lights.                                |
|   | Daylight fluorescent      | 6500 K       | • Daylight fluorescent lights.                                      |
|   | High temp. mercury-vapor  | 7200 K       | • High color temperature light sources (e.g. mercury-vapor lamps).  |
|  | Direct sunlight           | 5200 K       | Use with subjects lit by direct sunlight.                           |

| Option                   | Color temp.* | Description  |
|--------------------------|--------------|--|
| <b>Flash</b>             | 5400 K       | Use with built-in or optional flash.   |
| <b>Cloudy</b>            | 6000 K       | Use in daylight under overcast skies.  |
| <b>Shade</b>             | 8000 K       | Use in daylight with subjects in the shade.  |
| <b>PRE Preset manual</b> | —            | Use subject, light source, or existing photograph as reference for white balance (☐ 94). |

\* All values are approximate and do not reflect fine-tuning (if applicable).

## 1 Press the button.

Shooting information will be displayed in the monitor.

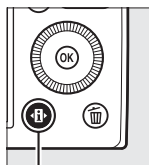

button



Information display

## 2 Display white balance options.

Highlight the current white balance setting in the information display and press .

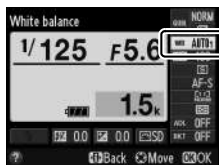

## 3 Choose a white balance option.

Highlight an option and press . To return to shooting mode, press the shutter-release button halfway.



## The Shooting Menu













White balance can be selected using the **White balance** option in the shooting menu (☐ 176), which also can be used to fine-tune white balance (☐ 92) or measure a value for preset white balance (☐ 94).

The **Auto** option in the **White balance** menu offers a choice of **Normal** and **Keep warm lighting colors**, which preserves the warm colors produced by incandescent lighting, while the  **Fluorescent** option can be used to select the light source from the bulb types.



## Color Temperature

The perceived color of a light source varies with the viewer and other conditions. Color temperature is an objective measure of the color of a light source, defined with reference to the temperature to which an object would have to be heated to radiate light in the same wavelengths. While light sources with a color temperature in the neighborhood of 5000–5500 K appear white, light sources with a lower color temperature, such as incandescent light bulbs, appear slightly yellow or red. Light sources with a higher color temperature appear tinged with blue. The camera white balance options are adapted to the following color temperatures (all figures are approximate):

-  (sodium-vapor lamps): **2700 K**
-  (incandescent)/  
•  (warm-white fluorescent): **3000 K**
-  (white fluorescent): **3700 K**
-  (cool-white fluorescent): **4200 K**
-  (day white fluorescent): **5000 K**
-  (direct sunlight): **5200 K**
-  (flash): **5400 K**
-  (cloudy): **6000 K**
-  (daylight fluorescent): **6500 K**
-  (high temp. mercury-vapor): **7200 K**
-  (shade): **8000 K**

## See Also

For information on using the **ISO** (Fn2) button and the command dial to select white balance, see page 194.

# Fine-Tuning White Balance

White balance options other than **Preset manual** can be “fine-tuned” to compensate for variations in the color of the light source or to introduce a deliberate color cast into an image.

## 1 Select a white balance option in the shooting menu.

To display the menus, press the **MENU** button. Select **White balance** in the shooting menu, then

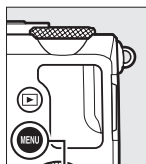

MENU button

highlight an option other than **Preset manual** and press **▶**. If an option other than **Auto** or **Fluorescent** is selected, proceed to Step 2. If **Auto** or **Fluorescent** is selected, highlight the desired setting and press **▶**.

## 2 Fine tune white balance.

Use the multi selector to fine-tune white balance. White balance can be fine-tuned on the amber (A)–blue (B) axis and the green (G)–magenta (M) axis. The horizontal (amber–blue) axis corresponds to color temperature, while the vertical (green–magenta) axis has the similar effects to the corresponding color compensation (CC) filters.

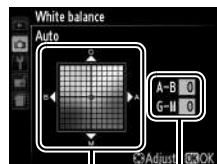

Coordinates

Adjustment

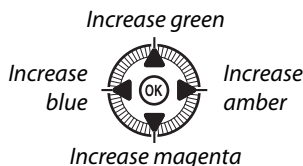

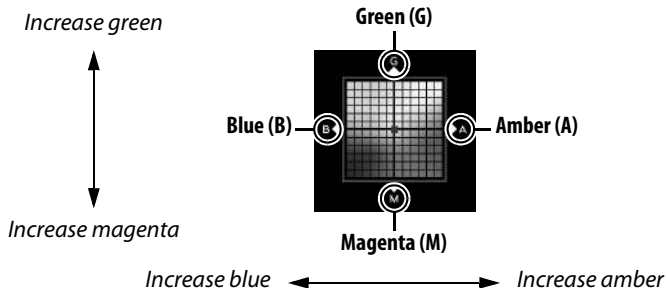

### 3 Press **OK**.

Press **OK** to save settings and return to the shooting menu. If white balance has been fine-tuned, an asterisk (“\*”) will be displayed in the monitor.



#### **White Balance Fine-Tuning**

The colors on the fine-tuning axes are relative, not absolute. For example, moving the cursor to **B** (blue) when a “warm” setting such as (incandescent) is selected will make photographs slightly “colder” but will not actually make them blue.

#### **See Also**

When white balance bracketing is on, the camera will create several images each time the shutter is released (123). White balance will be varied with each image, “bracketing” the value currently selected for white balance.

# Preset Manual

Preset manual is used to record and recall custom white balance settings for shooting under mixed lighting or to compensate for light sources with a strong color cast. Two methods are available for setting preset white balance:

| Method    | Description  |
|-----------|--|
| Measure   | Neutral gray or white object is placed under lighting that will be used in final photo and white balance measured by camera (see below). |
| Use photo | White balance is copied from photo on memory card (□ 97).  |

## ■ ■ *Measuring a Value for Preset White Balance*

Before proceeding, choose an option other than **Movie recording** for **Release mode** (□ 63).

### 1 Light a reference object.

Place a neutral gray or white object under the lighting that will be used in the final photograph. Note that exposure is automatically increased by 1 EV when measuring white balance; in mode M, adjust exposure so that the exposure indicator shows  $\pm 0$  (□ 57).

### 2 Display white balance options.

To display the menus, press the **MENU** button. Highlight **White balance** in the shooting menu and press **▶** to display white balance options. Highlight **Preset manual** and press **▶**.

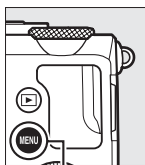

MENU button

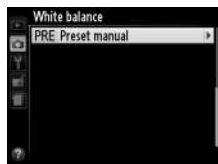

### 3 Select Measure.

Highlight **Measure** and press ►. The menu shown at right will be displayed; highlight **Yes** and press OK.



The message shown at right will be displayed before the camera enters preset measurement mode. When the camera is ready to measure white balance, a flashing **PRE** will appear in the monitor.

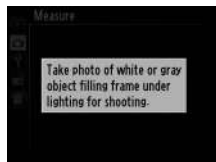

### 4 Measure white balance.

Before the indicator stops flashing, frame the reference object so that it fills the display and press the shutter-release button all the way down. No photograph will be recorded; white balance can be measured accurately even when the camera is not in focus.



#### ✔ Preset White Balance

The camera can store only one value for preset white balance at a time; the existing value will be replaced when a new value is measured.

#### ✎ Default Preset White Balance

The default value for preset white balance is 5200 K, the same as **Direct sunlight**.

## 5 Check the results.

If the camera was able to measure a value for white balance, the message shown at right will be displayed.



If lighting is too dark or too bright, the camera may be unable to measure white balance and the message shown at right will be displayed. Return to Step 4 and measure white balance again.



### Other Methods for Measuring Preset White Balance

To enter preset measurement mode (see above) after selecting preset white balance in the information display, press  for a few seconds. If white balance has been assigned to the ISO (Fn2) button, white balance preset measurement mode can be activated by keeping the ISO (Fn2) button pressed for a few seconds after selecting preset white balance with the ISO (Fn2) button and command dial.

## ■ Copying White Balance from a Photograph

Follow the steps below to copy a value for white balance from a photograph on the memory card.

### 1 Select Preset manual.

To display the menus, press the **MENU** button. Highlight **White balance** in the shooting menu and press ► to display white balance options.

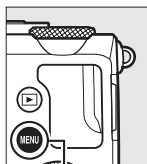

MENU button

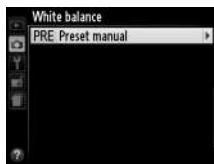

Highlight **Preset manual** and press ►.

### 2 Select Use photo.

Highlight **Use photo** and press ►.

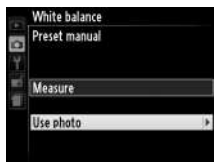

### 3 Choose Select image.

Highlight **Select image** and press ► (to skip the remaining steps and use the image last selected for preset white balance, select **This image**).

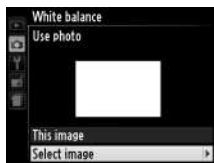

- 4 Choose a folder.**  
Highlight the folder containing the source image and press ►.

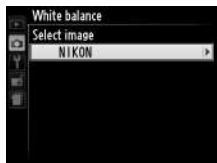

- 5 Highlight the source image.**



- 6 Copy white balance.**  
Press **OK** to set preset white balance to the white balance value for the highlighted photograph.



### Inspecting Pictures

The picture currently highlighted in the thumbnail display can be inspected by pressing **Q**; the picture will be displayed full screen while the **Q** button is pressed.

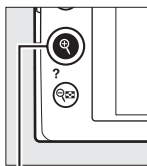

**Q** button



# Image Enhancement







## Picture Controls

(P, S, A, and M Modes Only)

Nikon's unique Picture Control system makes it possible to share image processing settings, including sharpening, contrast, brightness, saturation, and hue, among compatible devices and software.

### Selecting a Picture Control

The camera offers six Picture Controls. In P, S, A, and M modes, you can choose a Picture Control according to the subject or type of scene (in other modes, the camera selects a Picture Control automatically).

| Option   | Description   |
|--|---|
|  <b>Standard</b>    | Standard processing for balanced results. Recommended for most situations.  |
|  <b>Neutral</b>     | Minimal processing for natural results. Choose for photographs that will later be extensively processed or retouched. |
|  <b>Vivid</b>       | Pictures are enhanced for a vivid, photoprint effect. Choose for photographs that emphasize primary colors.           |
|  <b>Monochrome</b> | Take monochrome photographs.  |
|  <b>Portrait</b>  | Process portraits for skin with natural texture and a rounded feel.   |
|  <b>Landscape</b> | Produces vibrant landscapes and cityscapes.   |



## 1 Press the button.

Shooting information will be displayed in the monitor.

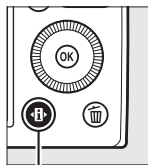

 button



Information display

## 2 Display Picture Control options.

Highlight the current Picture Control and press .

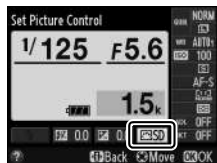

## 3 Select a Picture Control.

Highlight a Picture Control and press . To return to shooting mode, press the shutter-release button halfway.





### The Shooting Menu

Picture Controls can also be selected using the **Set Picture Control** option in the shooting menu ( 176).



### Custom Picture Controls

Custom Picture Controls are created through modifications to existing Picture Controls using the **Manage Picture Control** option in the shooting menu ( 106). Custom Picture Controls can be saved to a memory card and shared with other cameras and software that support the base Picture Control ( 109).

# Modifying Picture Controls

Existing preset or custom Picture Controls (📖 106) can be modified to suit the scene or the user's creative intent. Choose a balanced combination of sharpening, contrast, and saturation using **Quick adjust**, or make manual adjustments to individual settings.

## 1 Display the Picture Control menu.

To display the menus, press the **MENU** button. Highlight **Set Picture Control** in the shooting menu and press ►.

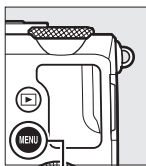

MENU button



## 2 Select a Picture Control.

Highlight the desired Picture Control and press ►.



### 3 Adjust settings.

Press ▲ or ▼ to highlight the desired setting and press ◀ or ▶ to choose a value (see 103). Repeat this step until all settings have been adjusted, or select

**Quick adjust** to choose a preset combination of settings. Default settings can be restored by pressing the  button.



### 4 Save changes and exit.

Press .



#### **Modifications to Original Picture Controls**

Picture Controls that have been modified from default settings are indicated by an asterisk ("\*").



## Picture Control Settings



| Option                                       | Description  |   |
|--|--|---|
| Quick adjust                                 | Choose from options between <b>-2</b> and <b>+2</b> to reduce or exaggerate the effect of the selected Picture Control by adjusting sharpening, contrast, and saturation (note that this resets all manual adjustments). For example, choosing positive values for <b>Vivid</b> makes pictures more vivid. Not available with <b>Neutral</b> , <b>Monochrome</b> , or custom Picture Controls. |   |
| Manual adjustments<br>(all Picture Controls) | <b>Sharpening</b>  | Control the sharpness of outlines. Select <b>A</b> to adjust sharpening automatically according to the type of scene, or choose from values between <b>0</b> (no sharpening) and <b>9</b> (the higher the value, the greater the sharpening).   |
|  | <b>Contrast</b>  | Select <b>A</b> to adjust contrast automatically according to the type of scene, or choose from values between <b>-3</b> and <b>+3</b> (choose lower values to prevent highlights in portrait subjects from being “washed out” in direct sunlight, higher values to preserve detail in misty landscapes and other low-contrast subjects). |
|  | <b>Brightness</b>  | Choose <b>-1</b> for reduced brightness, <b>+1</b> for enhanced brightness. Does not affect exposure.   |
| Manual adjustments<br>(non-monochrome only)  | <b>Saturation</b>  | Control the vividness of colors. Select <b>A</b> to adjust saturation automatically according to the type of scene, or choose from values between <b>-3</b> and <b>+3</b> (lower values reduce saturation and higher values increase it).   |
|  | <b>Hue</b>   | Choose negative values (to a minimum of <b>-3</b> ) to make reds more purple, blues more green, and greens more yellow, positive values (up to <b>+3</b> ) to make reds more orange, greens more blue, and blues more purple.   |
| Manual adjustments<br>(monochrome only)      | <b>Filter effects</b>  | Simulate the effect of color filters on monochrome photographs. Choose from <b>OFF</b> , yellow, orange, red, and green (☞ 105).  |
|  | <b>Toning</b>  | Choose the tint used in monochrome photographs from <b>B&amp;W</b> (black-and-white), <b>Sepia</b> , <b>Cyanotype</b> (blue-tinted monochrome), <b>Red</b> , <b>Yellow</b> , <b>Green</b> , <b>Blue Green</b> , <b>Blue</b> , <b>Purple Blue</b> , <b>Red Purple</b> (☞ 105).   |



## ✔ "A" (Auto)

Results for auto sharpening, contrast, and saturation vary with exposure and the position of the subject in the frame.

## ✎ The Picture Control Grid

Pressing the  button in Step 3 on page 102 displays a Picture Control grid showing the contrast and saturation for the selected Picture Control in relation to the other Picture Controls (only contrast is displayed when **Monochrome** is selected). Release the  button to return to the Picture Control menu.

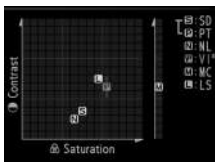

The icons for Picture Controls that use auto contrast and saturation are displayed in green in the Picture Control grid, and lines appear parallel to the axes of the grid.

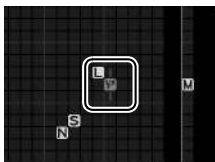

## ✎ Previous Settings

The line under the value display in the Picture Control setting menu indicates the previous value for the setting. Use this as a reference when adjusting settings.

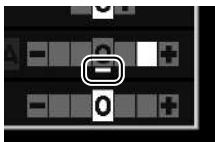

### Filter Effects (Monochrome Only)

The options in this menu simulate the effect of color filters on monochrome photographs. The following filter effects are available:

| Option |        | Description   |
|--------|--------|---|
| Y      | Yellow | Enhances contrast. Can be used to tone down the brightness of the sky in landscape photographs. Orange produces more contrast than yellow, red more contrast than orange. |
| O      | Orange |   |
| R      | Red    |   |
| G      | Green  | Softens skin tones. Can be used for portraits.  |

Note that the effects achieved with **Filter effects** are more pronounced than those produced by physical glass filters.

### Toning (Monochrome Only)

Pressing ▼ when **Toning** is selected displays saturation options. Press ◀ or ▶ to adjust saturation. Saturation control is not available when **B&W** (black-and-white) is selected.



# Creating Custom Picture Controls

The Picture Controls supplied with the camera can be modified and saved as custom Picture Controls.

## 1 Select Manage Picture Control.

To display the menus, press the **MENU** button. Highlight **Manage Picture Control** in the shooting menu and press **▶**.

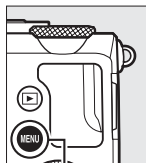

MENU button



## 2 Select Save/edit.

Highlight **Save/edit** and press **▶**.





## 3 Select a Picture Control.

Highlight an existing Picture Control and press **▶**, or press **OK** to proceed to step 5 to save a copy of the highlighted Picture Control without further modification.



## 4 Edit the selected Picture Control.

See page 103 for more information. To abandon any changes and start over from default settings, press the  button. Press  when settings are complete.









## 5 Select a destination.

Highlight a destination for the custom Picture Control (C-1 through C-9) and press .



## 6 Name the Picture Control.

The text-entry dialog shown at right will be displayed. By default, new Picture Controls are named by adding a two-digit number (assigned automatically) to the name of the existing Picture Control; to use the default name, proceed to Step 7. To move the cursor in the name area, hold the  (/ ) button and press  or . To enter a new letter at the current cursor position, use the multi selector to highlight the desired character in the keyboard area and press . To delete the character at the current cursor position, press the .



Keyboard area

Name area

Custom Picture Control names can be up to nineteen characters long. Any characters after the nineteenth will be deleted.



## 7 Save changes and exit.

Press  to save changes and exit. The new Picture Control will appear in the Picture Control list.

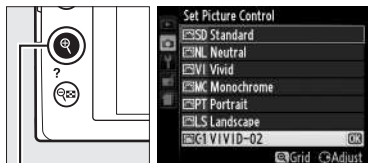

 button



### **Manage Picture Control > Rename**

Custom Picture Controls can be renamed at any time using the **Rename** option in the **Manage Picture Control** menu.

### **Manage Picture Control > Delete**

The **Delete** option in the **Manage Picture Control** menu can be used to delete selected custom Picture Controls when they are no longer needed.

# Sharing Custom Picture Controls

Custom Picture Controls created using the Picture Control Utility available with ViewNX 2 or optional software such as Capture NX 2 can be copied to a memory card and loaded into the camera, or custom Picture Controls created with the camera can be copied to the memory card to be used in compatible cameras and software and then deleted when no longer needed.

To copy custom Picture Controls to or from the memory card, or to delete custom Picture Controls from the memory card, highlight **Load/save** in the **Manage Picture Control** menu and press **▶**. The following options will be displayed:



- **Copy to camera:** Copy custom Picture Controls from the memory card to custom Picture Controls C-1 through C-9 on the camera and name them as desired.

- **Delete from card:** Delete selected custom Picture Controls from the memory card. The confirmation dialog shown at right will be displayed before a Picture Control is deleted; to delete the selected Picture Control, highlight **Yes** and press **OK**.



- **Copy to card:** Copy a custom Picture Control (C-1 through C-9) from the camera to a selected destination (1 through 99) on the memory card.

## Saving Custom Picture Controls

Up to 99 custom Picture Controls can be stored on the memory card at any one time. The memory card can only be used to store user-created custom Picture Controls. The preset Picture Controls supplied with the camera can not be copied to the memory card, renamed, or deleted.

# Preserving Detail in Highlights and Shadows (Active D-Lighting)

(P, S, A, and M Modes Only)

Active D-Lighting preserves details in highlights and shadows, creating photographs with natural contrast. Use for high contrast scenes, for example when photographing brightly lit outdoor scenery through a door or window or taking pictures of shaded subjects on a sunny day. It is most effective when used with matrix metering (☐ 85).



Active D-Lighting: OFF **Off**



Active D-Lighting: **On** **Auto**



## “Active D-Lighting” Versus “D-Lighting”

The **Active D-Lighting** option in the shooting menu adjusts exposure before shooting to optimize the dynamic range, while the **D-Lighting** option in the retouch menu (☐ 200) brightens shadows in images after shooting.

## 1 Press the button.

Shooting information will be displayed in the monitor.

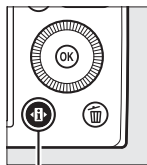

 button







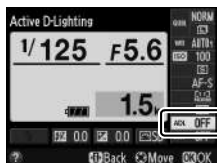

Information display

## 2 Display Active D-Lighting options.

Highlight Active D-Lighting in the information display and press .



## 3 Choose an option.

Highlight  **Auto**,  **Extra high**,  **High**,  **Normal**,  **Low**, or **OFF Off** and press .

If  **Auto** is selected, the camera will automatically adjust Active D-Lighting according to shooting conditions. To return to shooting mode, press the shutter-release button halfway.



### **Active D-Lighting**

Active D-Lighting can not be used with movies. Noise (randomly-spaced bright pixels, fog, or lines) may appear in photographs taken with Active D-Lighting. Uneven shading may be visible with some subjects. Active D-Lighting can not be used at ISO sensitivities of Hi 0.3 or above.

### **See Also**

For information on automatically varying Active D-Lighting over a series of shots, see page 123. For information on using the **ISO (Fn2)** button and command dial to select an **Active D-Lighting** option, see page 194.



# Flash Photography

## Using the Built-in Flash

The camera supports a variety of flash modes for photographing poorly lit or backlit subjects.

### 1 Raise the flash.

Slide the flash pop-up control to raise the flash. Charging begins when the flash is raised; once charging is complete, a flash-ready indicator (⚡) will be displayed and the flash lamp will light when the shutter-release button is pressed halfway.

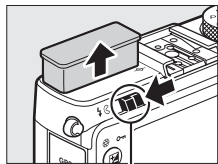

Flash pop-up control

### 2 Choose a flash mode.

See page 113 for more information. In **⌘** mode, flash mode is fixed at ⚡ (fill flash) and the flash fires with every shot.

### 3 Take pictures.

In **📷, 📷, 📷, 📷, 📷, 📷, and 📷 modes**, the flash fires as required. To turn the flash off, lower the flash or choose a flash mode of **📷**.

In **P, S, A, M, and ⌘ modes**, the flash fires with every shot. Lower the flash to prevent it firing.





### 3 Choose a flash mode.

Highlight a mode and press **OK**. Press the shutter-release button halfway to return to shooting mode.

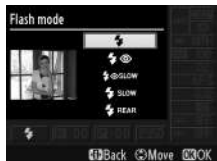

#### Flash Modes

The flash modes listed on the previous page may combine one or more of the following settings, as shown by the flash mode icon:

- **AUTO (auto flash)**: Flash fires as required when lighting is poor or subject is back lit.
- **RED-EYE REDUCTION**: Use for portraits. Flash fires at low intensity before main flash, reducing “red-eye” but increasing lag between shutter-release button being pressed all the way down and shutter being released.
- **OFF**: Flash does not fire even when lighting is poor or subject is back-lit.
- **SLOW (slow sync)**: Shutter speed slows automatically to capture background lighting at night or under low light. Use to include background lighting in portraits.
- **REAR (rear-curtain sync)**: The flash fires just before the shutter closes, creating streams of light behind moving light sources as shown below at left.



*Rear-curtain sync enabled*



*Rear-curtain sync disabled*

### **See Also**

For information on using the Fn1 button and the command dial to choose the flash mode, see page 193.

### **Lowering the Built-in Flash**

To save power when the flash is not in use, press it gently downward until the latch clicks into place. Do not use force; failure to observe this precaution could result in product malfunction.

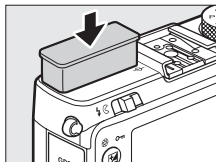

### **The Built-in Flash**

The shutter release may be briefly disabled to protect the flash after it has been used for several consecutive shots. The flash can be used again after a short pause.

Objects close to the camera may appear overexposed in photographs taken with the flash at high ISO sensitivities.



# Flash Compensation

(P, S, A, and M Modes Only)

Flash compensation is used to alter flash output from the level suggested by the camera, changing the brightness of the main subject relative to the background. Choose from values between  $-3$  EV (darker) and  $+1$  EV (brighter) in increments of  $1/3$  EV; in general, positive values make the subject brighter while negative values make it darker.

## 1 Press the button.

Shooting information will be displayed in the monitor.

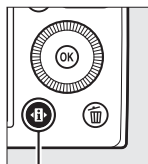

 button



Information display

## 2 Display flash compensation options.

Highlight flash compensation in the information display and press .

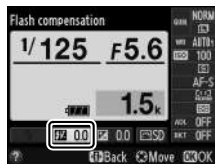

## 3 Choose a value.

Highlight a value and press . To return to shooting mode, press the shutter-release button halfway.



Normal flash output can be restored by setting flash compensation to  $\pm 0$ . Flash compensation is not reset when the camera is turned off.

### **Optional Flash Units**

Flash compensation is also available with optional SB-910, SB-900, SB-800, SB-700, SB-600, and SB-400 flash units; in the case of all but the SB-400, it can be adjusted using the controls on the flash unit in addition to the procedure described above. The flash compensation selected with the optional flash unit is added to the flash compensation selected with the camera.

### **See Also**

The **Exposure comp. for flash** option in the shooting menu (📖 180) can be used to restrict the effects of exposure compensation to the background only.



# FV Lock

This feature is used to lock flash output, allowing photographs to be recomposed without changing the flash level and ensuring that flash output is appropriate to the subject even when the subject is not positioned in the center of the frame. Flash output is adjusted automatically for any changes in ISO sensitivity and aperture.

To use FV lock:

## 1 Assign FV lock to the Fn1 button.

Select **FV lock** for **Assign Fn1 button** in the setup menu (📖 193), then press **MENU** to return to the shooting display.



## 2 Raise the flash.

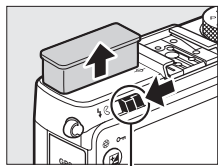

*Flash pop-up control*

## 3 Focus.

Position the subject in the center of the frame and press the shutter-release button halfway to focus.



---

## 4 Lock flash level.

After confirming that the flash ready indicator (⚡) is displayed, press the Fn1 button. The flash will emit a monitor preflash to determine the appropriate flash level. Flash output will be locked at this level and an FV lock icon (🔒) will be displayed.

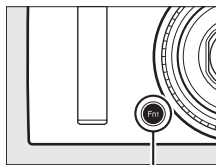

Fn1 button



---

## 5 Recompose the photograph.



---

## 6 Take the photograph.

Press the shutter-release button the rest of the way down to shoot. If desired, additional pictures can be taken without releasing FV lock.

---

## 7 Release FV lock.

Press the Fn1 button to release FV lock. Confirm that the FV lock icon (🔒) is no longer displayed.



 **Using FV Lock with the Built-in Flash**

FV lock is only available with the built-in flash when **TTL** is selected for **Flash cntrl for built-in flash** in the shooting menu (📖 181).

 **Using FV Lock with Optional Flash Units**

FV lock is also available with optional flash units in TTL and (where supported) monitor pre-flash AA and monitor pre-flash A flash control modes. See the flash unit manual for details.









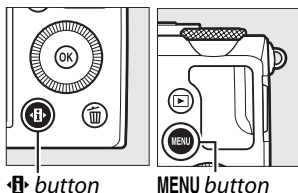

































# Other Shooting Options

## Restoring Default Settings

The camera settings listed below and on page 122 can be restored to default values by holding the  and MENU buttons down together for more than two seconds. The monitor turns off briefly while settings are reset.



| Option            |   | Default          |  |
|-------------------|---|------------------|---|
| Image quality     |   | JPEG normal      | 69  |
| Image size        |   | Large            | 72  |
| White balance     | P, S, A, M  | Auto             | 89  |
| Fine tuning       |   | A-B: 0, G-M: 0   | 92  |
| ISO sensitivity   | P, S, A, M  | 100              | 81  |
|                   | Other shooting modes  | Auto             |   |
| Release mode      |    | Continuous       | 63  |
|                   | Other modes   | Single frame     |   |
| Autofocus mode    |   | AF-S             | 75  |
| AF-area mode      |    | Wide-area AF     | 76  |
|                   | P, S, A, M,  ,  ,  ,  ,    | Normal-area AF   |   |
|                   |  ,  ,  ,  ,  ,  ,  | Face-priority AF |   |
| Metering          | P, S, A, M  | Matrix metering  | 85  |
| Active D-Lighting | P, S, A, M  | Off              | 110   |

| Option                    |   | Default                |  |
|---------------------------|---|------------------------|---|
| Bracketing                | P, S, A, M  | Off                    | 123,<br>181   |
| Picture Control settings* | P, S, A, M  | Unmodified             | 99  |
| Exposure compensation     | P, S, A, M  | 0.0                    | 87  |
| Flash compensation        | P, S, A, M  | 0.0                    | 116   |
| Flash mode                | P, S, A, M,    | Fill flash             | 113   |
|                           |        | Auto                   |   |
|                           |    | Auto+red-eye reduction |   |
|                           |    | Auto +slow sync        |   |
|                           |                 | Off                    |   |
| Flexible program          | P   | —                      | 53  |

\* Current Picture Control only.



# Bracketing

(P, S, A, and M Modes Only)

Bracketing automatically varies exposure, Active D-Lighting (ADL), or white balance slightly with each shot, “bracketing” the current value. Choose in situations in which it is difficult to set exposure, white balance, or Active D-Lighting and there is not time to check results and adjust settings with each shot, or to experiment with different settings for the same subject.

## 1 Choose a bracketing option.

After pressing **MENU** to display the menus, highlight **Auto bracketing set** in the shooting menu and press

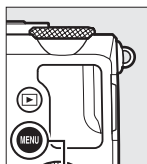

MENU button



▶.  
The options shown at right will be displayed. Highlight the desired bracketing type and press **OK**, then press **MENU** to return to the shooting display.



## 2 Press the **INFO** button.

Shooting information will be displayed in the monitor.

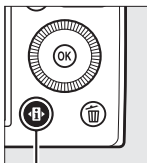

INFO button



Information display

### 3 Display bracketing options.

Highlight the current bracketing setting and press **OK**.

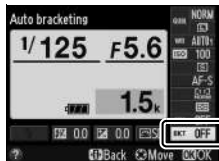

### 4 Select a bracketing increment.

Highlight a bracketing increment and press **OK**.  
Choose from values between 0.3 and 2 EV (AE bracketing) or 1 to 3 (WB bracketing), or select **ADL** (ADL bracketing).



### 5 Frame a photograph, focus, and shoot.



**AE bracketing:** The camera will vary exposure with each shot. The value currently selected for exposure compensation is modified as follows: for the first shot, the bracketing increment is added to the current value; for the second shot, the current value is used without modification; and for the third shot, the bracketing increment is subtracted from the current value. The modified values are reflected in the values shown for shutter speed and aperture.

**WB bracketing:** Each shot is processed to create three copies, one at the current white balance setting, one with increased amber, and one with increased blue.



### **Disabling Bracketing**

To disable bracketing and resume normal shooting, select **OFF** in Step 4 on the previous page. To cancel bracketing before all frames have been recorded, rotate the mode dial to a setting other than P, S, A, or M.

### **Memory Card Capacity**

If the memory card fills before all shots in the sequence have been taken, shooting can be resumed from the next shot in the sequence after the memory card has been replaced or shots have been deleted to make room on the memory card.

### **Exposure Bracketing**

The camera modifies exposure by varying shutter speed and aperture (mode P), aperture (mode S), or shutter speed (modes A and M). If auto ISO sensitivity control is enabled in modes P, S, and A, the camera will automatically vary ISO sensitivity for optimum exposure when the limits of the camera exposure system are exceeded; in mode M, the camera will first use auto ISO sensitivity control to bring exposure as close as possible to the optimum and then bracket this exposure by varying shutter speed.

### **See Also**

For information on using the **ISO** (Fn2) button and the command dial to choose the bracketing increment, see page 194.



# Interval Timer Photography

The camera is equipped to take photographs automatically at preset intervals.

Mount the camera on a tripod and frame the subject before proceeding.

## 1 Select Interval timer shooting.

Press the **MENU** button to display the menus. Highlight **Interval timer shooting** in the shooting menu and press **▶**.

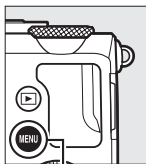

MENU button

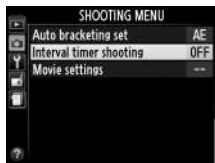

## 2 Choose a starting time.

Choose from the following starting triggers.

- **To start shooting immediately**, highlight **Now** and press **▶**.

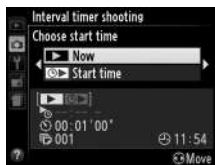

Shooting begins about five seconds after settings are completed; proceed to Step 3.

- **To choose a starting time**, highlight **Start time** and press **▶** to display the start time options shown at right. Press **◀** or **▶** to highlight hours or minutes and press **▲** or **▼** to change. Press **▶** to continue.



### 3 Choose the interval.

Press ◀ or ▶ to highlight hours, minutes, or seconds and press ▲ or ▼ to choose an interval longer than the slowest anticipated shutter speed. Press ▶ to continue.



### 4 Choose the number of intervals.

Press ◀ or ▶ to highlight number of intervals (i.e., the number of times the camera shoots); press ▲ or ▼ to change. Press ▶ to continue.



#### Before Shooting

Select single-frame or continuous release mode when using the interval timer. Before beginning interval timer photography, take a test shot at current settings and view the results in the monitor. To ensure that shooting starts at the desired time, check that the camera clock is set correctly (□ 185).

Use of a tripod is recommended. Mount the camera on a tripod before shooting begins. To ensure that shooting is not interrupted, be sure the battery is fully charged or use an optional EH-5b AC adapter and EP-5C power connector (□ 230).

## 5 Start shooting.

Highlight **On** and press **OK** (to return to the shooting menu without starting the interval timer, highlight **Off** and press **OK**). The first



series of shots will be taken at the specified starting time, or after about 5 s if **Now** was selected for **Choose start time** in Step 2. Shooting will continue at the selected interval until all shots have been taken. Note that because shutter speed and the time needed to record the image to the memory card may vary from shot to shot, intervals may be skipped if the camera is still in the process of recording the previous interval. If shooting can not proceed at current settings (for example, if a shutter speed of **Bulb** is currently selected in shooting mode M or the start time is in less than a minute), a warning will be displayed in the monitor.

If the interval between shots is long enough while the camera is powered by a battery, the monitor will turn off and the power-on lamp will flash between shots. Pictures can not be played back, but images will be displayed in the monitor automatically after shooting. Manual override (74) is not available with autofocus during interval timer shooting; to focus manually, select manual focus mode.

### **Out of Memory**

If the memory card is full, the interval timer will remain active but no pictures will be taken. Resume shooting after deleting some pictures or turning the camera off and inserting another memory card.



# Using a GPS Unit

An optional GP-1 GPS unit (☐ 231) can be connected to the accessory terminal (☐ 3) allowing information on the camera's current position to be recorded when photographs are taken. When connecting GPS units, turn the camera off and note that the unit can not be mounted on the accessory shoe when the built-in flash is used; for more information, see the manual provided with the GP-1.

## ■ Setup Menu Options

The **GPS** item in the setup menu contains the options listed below.

- **Auto off:** Choose whether the camera turns off automatically when a GPS unit is attached.

| Option         | Description  |
|----------------|--|
| <b>Enable</b>  | The camera will enter standby if no operations are performed for the time selected for <b>Auto off timer</b> in the setup menu (☐ 182); if no operations are performed before standby ends, the camera will turn off automatically. This reduces the drain on the battery. |
| <b>Disable</b> | The camera does not turn off automatically while a GPS unit is connected.  |

- **Position:** This item is only available if a GPS unit is connected, when it displays the current latitude, longitude, altitude, and Coordinated Universal Time (UTC) as reported by GPS.
- **Use GPS to set camera clock:** Select **Yes** to synchronize the camera clock with the time reported by the GPS device.



### **Coordinated Universal Time (UTC)**

UTC data is provided by the GPS device and is independent of the camera clock.

## The GPS Icon

Connection status is shown by the GPS icon:

- **GPS (static):** Camera has established communication with the GPS unit. Photo information for pictures taken while this icon is displayed include an additional page of GPS data (📖 138).
- **GPS (flashing):** The GPS unit is searching for a signal. Pictures taken while the icon is flashing do not include GPS data.
- **No icon:** No new GPS data have been received from the GPS unit for at least two seconds. Pictures taken when the GPS icon is not displayed do not include GPS data.



# More on Playback

## Full-Frame Playback

To play photographs back, press the  button. The most recent photograph will be displayed in the monitor.

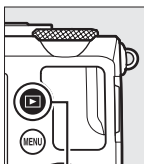



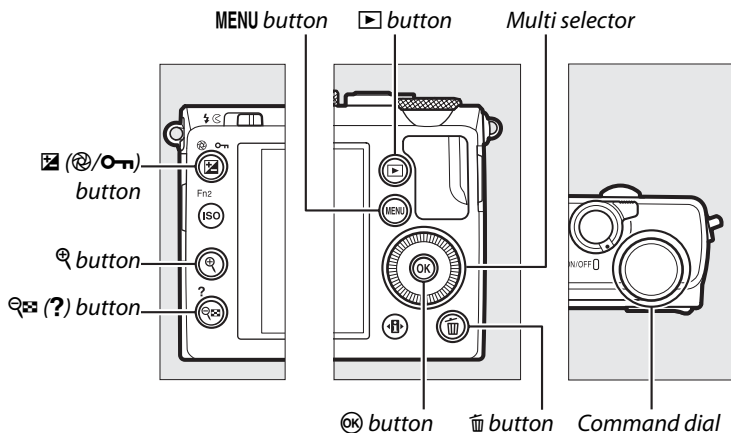









 button

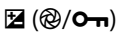
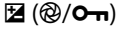

### Rotate Tall

To display “tall” (portrait-orientation) photographs in tall orientation, select **On** for the **Rotate tall** option in the playback menu ( 174).



| To                          | Use   | Description  |
|-----------------------------|---|--|
| View additional photographs |    | Press ► to view photographs in order recorded, ◀ to view photographs in reverse order. Photographs can also be viewed by rotating the multi selector or command dial.  |
| View additional photo info  |    | Change photo info displayed (☞ 134).   |
| View thumbnails             |    | See page 140 for more information on the thumbnail display.  |
| Zoom in on photograph       |    | See page 144 for more information on playback zoom.  |
| Delete images               |    | Confirmation dialog will be displayed. Press  again to delete photo.  |
| Change protect status       |    | To protect image, or to remove protection from protected image, press  button (☞ 146).  |
| Return to shooting mode     |  /  | Press shutter-release button halfway to exit to shooting display.  |
| Retouch photo or play movie |    | Create retouched copy of current photograph (☞ 199; retouch menu can also be displayed by pressing MENU button and selecting  tab). If current picture is marked with  icon to show that it is a movie, pressing  starts movie playback (☞ 45). |
| Display menus               | <b>MENU</b>   | See page 172 for more information.   |

### Image Review

When **On** is selected for **Image review** in the playback menu (☞ 173), photographs are automatically displayed in the monitor for about 1 s after shooting (because the camera is already in the correct orientation, images are not rotated automatically during image review). In continuous release mode, pictures are displayed when shooting ends, beginning with the first photograph in the current series.





## File Information

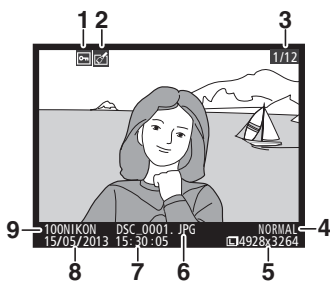

|   |                                     |         |
|---|-------------------------------------|---------|
| 1 | Protect status .....                | 146     |
| 2 | Retouch indicator .....             | 197     |
| 3 | Frame number/total number of images |         |
| 4 | Image quality .....                 | 69      |
| 5 | Image size.....                     | 72      |
| 6 | File name .....                     | 191     |
| 7 | Time of recording .....             | 25, 185 |
| 8 | Date of recording.....              | 25, 185 |
| 9 | Folder name.....                    | 177     |

## Highlights

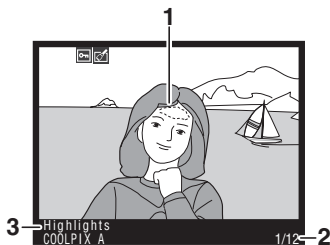

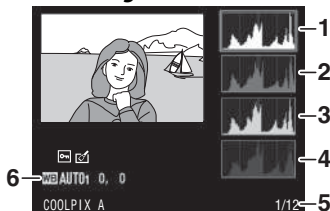

|   |                                     |
|---|-------------------------------------|
| 1 | Image highlights                    |
| 2 | Frame number/total number of images |
| 3 | Camera name                         |

## RGB Histogram



|   |   |    |
|---|---|----|
| 1 | Histogram (RGB channel). In all histograms, horizontal axis gives pixel brightness, vertical axis number of pixels. |    |
| 2 | Histogram (red channel)   |    |
| 3 | Histogram (green channel)   |    |
| 4 | Histogram (blue channel)  |    |
| 5 | Frame number/total number of images   |    |
| 6 | White balance .....   | 89 |
|   | White balance fine-tuning .....   | 92 |
|   | Preset manual.....  | 94 |

## Playback Zoom

To zoom in on the photograph when the histogram is displayed, press . Use the  and  (?) buttons to zoom in and out and scroll the image with the multi selector. The histogram will be updated to show only the data for the portion of the image visible in the monitor.



## Histograms

Camera histograms are intended as a guide only and may differ from those displayed in imaging applications. Some sample histograms are shown below:

If the image contains objects with a wide range of brightnesses, the distribution of tones will be relatively even.



If the image is dark, tone distribution will be shifted to the left.

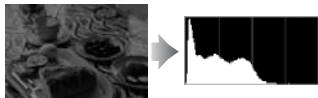

If the image is bright, tone distribution will be shifted to the right.



Increasing exposure compensation shifts the distribution of tones to the right, while decreasing exposure compensation shifts the distribution to the left. Histograms can provide a rough idea of overall exposure when bright ambient lighting makes it difficult to see photographs in the monitor.



## Shooting Data

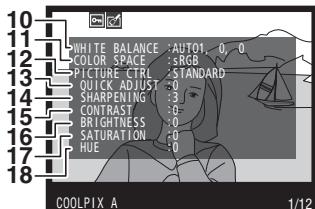
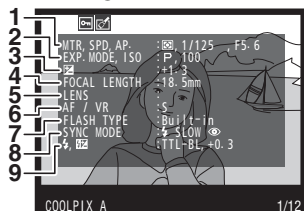

|    |   |            |
|----|---|------------|
| 1  | Metering .....                              | 85         |
|    | Shutter speed.....                          | 54, 56     |
|    | Aperture.....                               | 55, 56     |
| 2  | Shooting mode.....                          | 29, 35, 52 |
|    | ISO sensitivity <sup>1</sup> .....          | 81         |
| 3  | Exposure compensation .....                 | 87         |
| 4  | Focus length                                |            |
| 5  | Lens data                                   |            |
| 6  | Focus mode .....                            | 74, 80     |
| 7  | Flash type .....                            | 112, 226   |
| 8  | Flash mode.....                             | 113        |
| 9  | Flash control .....                         | 181        |
|    | Flash compensation.....                     | 116        |
| 10 | White balance .....                         | 89         |
|    | White balance fine-tuning .....             | 92         |
|    | Preset manual .....                         | 94         |
| 11 | Color space.....                            | 178        |
| 12 | Picture Control.....                        | 99         |
| 13 | Quick adjust <sup>2</sup> .....             | 103        |
|    | Original Picture Control <sup>3</sup> ..... | 99         |
| 14 | Sharpening.....                             | 103        |
| 15 | Contrast.....                               | 103        |
| 16 | Brightness.....                             | 103        |
| 17 | Saturation <sup>4</sup> .....               | 103        |
|    | Filter effects <sup>5</sup> .....           | 103        |
| 18 | Hue <sup>4</sup> .....                      | 103        |
|    | Toning <sup>5</sup> .....                   | 103        |



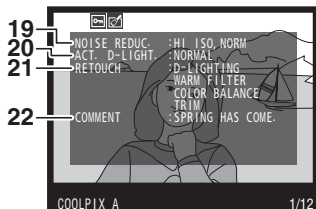

|    |                                   |     |
|----|-----------------------------------|-----|
| 19 | High ISO noise reduction .....    | 179 |
|    | Long exposure noise reduction ... | 179 |
| 20 | Active D-Lighting.....            | 110 |
| 21 | Retouch history .....             | 197 |
| 22 | Image Comment .....               | 186 |

- 1 Displayed in red if photo was taken with auto ISO sensitivity control on.
- 2 **Standard, Vivid, Portrait, and Landscape** Picture Controls only.
- 3 **Neutral, Monochrome,** and custom Picture Controls only.
- 4 Not displayed with monochrome Picture Controls only.
- 5 **Monochrome** Picture Controls only.

### ■ ■ GPS Data \*

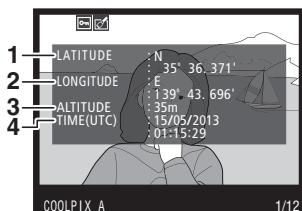

|   |                                  |
|---|----------------------------------|
| 1 | Latitude                         |
| 2 | Longitude                        |
| 3 | Altitude                         |
| 4 | Coordinated Universal Time (UTC) |

\* Data for movies are for start of recording.

## Overview Data

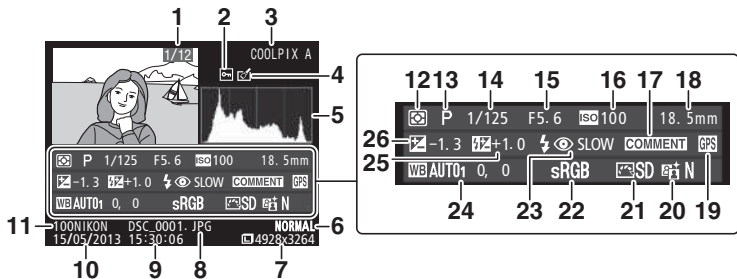

|    |   |            |    |                                 |        |
|----|---|------------|----|---------------------------------|--------|
| 1  | Frame number/total number of images                               |            | 14 | Shutter speed.....              | 54, 56 |
| 2  | Protect status .....  | 146        | 15 | Aperture.....                   | 55, 56 |
| 3  | Camera name   |            | 16 | ISO sensitivity * .....         | 81     |
| 4  | Retouch indicator .....   | 197        | 17 | Image comment indicator.....    | 186    |
| 5  | Histogram showing the distribution of tones in the image (☐ 136). |            | 18 | Focal length                    |        |
| 6  | Image quality .....   | 69         | 19 | GPS data indicator.....         | 130    |
| 7  | Image size .....  | 72         | 20 | Active D-Lighting.....          | 110    |
| 8  | File name .....   | 191        | 21 | Picture Control.....            | 99     |
| 9  | Time of recording .....   | 25, 185    | 22 | Color space.....                | 178    |
| 10 | Date of recording.....  | 25, 185    | 23 | Flash mode.....                 | 113    |
| 11 | Folder name .....   | 177        | 24 | White balance .....             | 89     |
| 12 | Metering .....  | 85         | 25 | White balance fine-tuning ..... | 92     |
| 13 | Shooting mode .....   | 29, 35, 52 | 26 | Preset manual .....             | 94     |
|    |   |            |    | Flash compensation.....         | 116    |
|    |   |            |    | Exposure compensation .....     | 87     |









\* Displayed in red if photo was taken with auto ISO sensitivity control on.





# Thumbnail Playback

To display images in “contact sheets” of four, nine, or 72 images, press the  (?) button.



| To                       | Use   | Description  |
|--------------------------|---|--|
| Display more images      |  (?) | Press  (?) button to increase the number of images displayed.   |
| Display fewer images     |      | Press  button to reduce the number of images displayed. When four images are displayed, press to view highlighted image full frame. |
| Highlight images         |      | Use multi selector or command dial to highlight images for full-frame playback, playback zoom ( <a href="#">144</a> ), deletion ( <a href="#">148</a> ), or protection ( <a href="#">146</a> ).                      |
| View highlighted image   |     | Press  to display the highlighted image full frame.  |
| Delete highlighted photo |    | See page 148 for more information.   |



| To   | Use   | Description   |
|--|---|---|
| Change protect status of highlighted photo |  (Ⓢ/Ⓛ)   | See page 146 for more information.                                |
| Return to shooting mode                    |  /  | Press shutter-release button halfway to exit to shooting display. |
| Display menus                              | <b>MENU</b>   | See page 172 for more information.                                |



# Calendar Playback

To view images taken on a selected date, press the  (?) button when 72 images are displayed.











Full-frame playback

Thumbnail playback

Calendar playback

The operations that can be performed depend on whether the cursor is in the date list or the thumbnail list:







| To  | Use   | Description   |
|---|---|---|
| Toggle between date list and thumbnail list             |  (?) | Press  (?) button in date list to place cursor in thumbnail list. Press again to return to date list.  |
| Exit to thumbnail playback/Zoom in on highlighted photo |      | <ul style="list-style-type: none"> <li>• <b>Date list:</b> Exit to 72-frame playback.</li> <li>• <b>Thumbnail list:</b> Press and hold  button to zoom in on highlighted picture.</li> </ul> |
| Highlight dates/Highlight images                        |     | <ul style="list-style-type: none"> <li>• <b>Date list:</b> Use multi selector or command dial to highlight date.</li> <li>• <b>Thumbnail list:</b> Use multi selector or command dial to highlight picture.</li> </ul>  |
| Toggle full frame playback                              |    | <ul style="list-style-type: none"> <li>• <b>Date list:</b> View pictures taken on selected date.</li> <li>• <b>Thumbnail list:</b> View highlighted picture.</li> </ul>   |

| To   | Use   | Description   |
|--|---|---|
| Delete highlighted photo(s)                |  | <ul style="list-style-type: none"> <li>• <b>Date list:</b> Delete all pictures taken on selected date.</li> <li>• <b>Thumbnail list:</b> Delete highlighted picture (📖 148).</li> </ul> |
| Change protect status of highlighted photo |  | See page 146 for more information.  |
| Return to shooting mode                    |  | Press shutter-release button halfway to exit to shooting display.   |
| Display menus                              | <b>MENU</b>   | See page 172 for more information.  |







# Taking a Closer Look: Playback Zoom

Press the  button to zoom in on the image displayed in full-frame playback or on the image currently highlighted in thumbnail or calendar playback. The following operations can be performed while zoom is in effect:





| To                                  | Use   | Description   |
|-------------------------------------|---|---|
| Zoom in or out                      |    | Press  to zoom in to maximum of approximately 31× (large images), 23× (medium images) or 15× (small images). Press  (?) to zoom out. While photo is zoomed in, use multi selector to view areas of image not visible in monitor. Keep multi selector pressed to scroll rapidly to other areas of frame. Navigation window is displayed when zoom ratio is altered; area currently visible in monitor is indicated by yellow border. |
| View other areas of image           |    |   |
| Select/zoom in on or out from faces |  | Faces (up to 35) detected during zoom are indicated by white borders in navigation window. Use the multi selector to view other faces, or press  to zoom in on the currently selected face. Press  again to return to normal zoom.  |



| To                      | Use   | Description  |
|-------------------------|---|--|
| View other images       |  | Rotate command dial or multi selector to view same location in other images at current zoom ratio. Playback zoom is cancelled when a movie is displayed. |
| Cancel zoom             |  | Cancel zoom and return to full-frame playback.   |
| Change protect status   |  | See page 146 for more information.   |
| Return to shooting mode |  | Press shutter-release button halfway to exit to shooting display.  |
| Display menus           | <b>MENU</b>   | See page 172 for more information.   |



# Protecting Photographs from Deletion

In full-frame, zoom, thumbnail, and calendar playback, the  (/ ) button can be used to protect photographs from accidental deletion. Protected files can not be deleted using the  button or the **Delete** option in the playback menu. Note that protected images *will* be deleted when the memory card is formatted ( 183).

To protect a photograph:

## 1 Select an image.

Display the image in full-frame playback or playback zoom or highlight it in the thumbnail list in thumbnail or calendar playback.



Full-frame playback





Thumbnail playback



Calendar playback

## 2 Press the () button.





The photograph will be marked with a  icon. To remove protection from the photograph so that it can be deleted, display the photograph or highlight it in the thumbnail list and then press the  () button.



 () button



### **Removing Protection from All Images**

To remove protection from all images in the folder or folders currently selected in the **Playback folder** menu, press the  (/  ) and  buttons together for about two seconds during playback.



# Deleting Photographs

To delete the photograph displayed in full-frame playback or the photograph highlighted in the thumbnail list, press the  button. To delete multiple selected photographs, all photographs taken on a selected date, or all photographs in the current playback folder, use the **Delete** option in the playback menu. Once deleted, photographs can not be recovered. Note that protected pictures can not be deleted.

## Full-Frame, Thumbnail, and Calendar Playback

Press the  button to delete the current photograph.

### 1 Select an image.

Display the image or highlight it in the thumbnail list in thumbnail or calendar playback.

### 2 Press the button.

A confirmation dialog will be displayed.

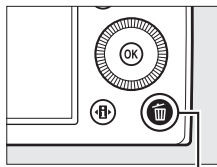

 button



Full-frame playback

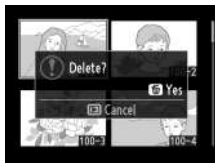



Thumbnail playback



Calendar playback  
(thumbnail list)

### 3 Press the button again.

To delete the photograph, press the  button again. To exit without deleting the photograph, press the  button.

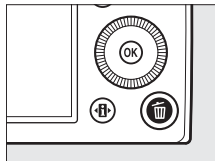



#### **Calendar Playback**

During calendar playback, you can delete all photographs taken on a selected date by highlighting the date in the date list and pressing the  button.



# The Playback Menu

The **Delete** option in the playback menu contains the following options. Note that depending on the number of images, some time may be required for deletion.

| Option  | Description   |
|---|---|
|  <b>Selected</b>    | Delete selected pictures.   |
|  <b>Select date</b> | Delete all pictures taken on a selected date.                               |
| <b>ALL All</b>  | Delete all pictures in the folder currently selected for playback (🗂️ 173). |

## ■ Selected: Deleting Selected Photographs

- 1 Choose Selected for the Delete option in the playback menu.**  
Press the **MENU** button and select **Delete** in the playback menu. Highlight **Selected** and press **▶**.

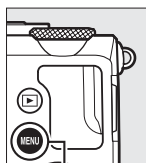

MENU button

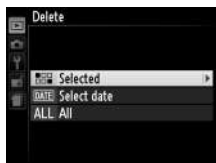



- 2 Highlight a picture.**  
Use the multi selector to highlight a picture (to view the highlighted picture full screen, press and hold the  button).



---

### 3 Select the highlighted picture.

Press the  (?) button to select the highlighted picture. Selected pictures are marked by a  icon. Repeat steps 2 and 3 to select additional pictures; to deselect a picture, highlight it and press  (?).

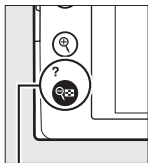

 (?) button



---

### 4 Press to complete the operation.

A confirmation dialog will be displayed; highlight **Yes** and press .



## ■ Select Date: Deleting Photographs Taken on a Selected Date

### 1 Choose Select date.

In the delete menu, highlight **Select date** and press **▶**.



### 2 Highlight a date.

Press **▲** or **▼** to highlight a date.

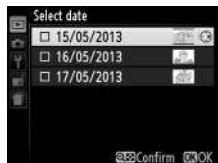

To view the pictures taken on the highlighted date, press **Q** (?). Use the multi-selector to scroll through the pictures, or press and hold **Q** to view the current picture full screen. Press **Q** (?) to return to the date list.

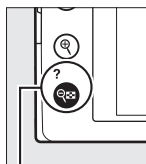

**Q** (?) button



### 3 Select the highlighted date.

Press **▶** to select all pictures taken on the highlighted date.

Selected dates are marked with a **☑** icon. Repeat steps 2 and 3 to select additional dates; to deselect a date, highlight it and press **▶**.

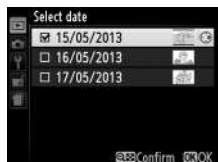

---

**4** Press **OK** to complete the operation.

A confirmation dialog will be displayed; highlight **Yes** and press **OK**.

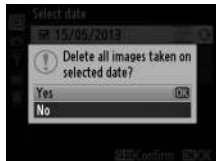

# Connections

## Using ViewNX 2

The supplied ViewNX 2 software can be used to copy pictures to your computer, where they can be viewed, retouched, and shared.



## Installing ViewNX 2

### ■ Supported Operating Systems

At the time of writing, ViewNX 2 was compatible with the following operating systems. For the latest information on supported operating systems, see the websites listed on page 1.

| Windows   | Macintosh                            |
|---|--------------------------------------|
| Windows 8, Windows 7, Windows Vista, Windows XP | Mac OS X version 10.6, 10.7, or 10.8 |

### 1 Start the computer and insert the installer CD.

**Windows:** If prompted, follow the on-screen instructions to launch the ViewNX 2 installer.

**Mac OS:** The contents of the CD will be displayed; double-click the **Welcome** icon to display the language-selection dialog.



---

## 2 Select a language.

If the desired language is not available, click **Region Selection** to choose a different region and then choose the desired language (region selection is not available in the European release). After choosing a language, click **Next**. The dialog shown below at right will be displayed.

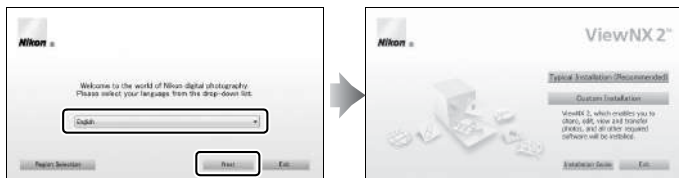

To view detailed installation instructions, click **Installation Guide** before proceeding.

---

## 3 Start the installer.

Click **Install** and follow the on-screen instructions.

---

## 4 Exit the installer.

Click **Yes** (Windows) or **OK** (Mac OS) when installation is complete. The following software is installed:

- ViewNX 2 (includes the following three modules: Nikon Transfer 2, used to copy pictures to the computer, ViewNX 2, used to view, retouch, and print pictures, and Nikon Movie Editor, used for simple movie editing)
- Panorama Maker (join pictures together to create a panorama)
- Apple QuickTime (Windows only)

---

## 5 Remove the installer CD from the CD-ROM drive.



# Copy Pictures to the Computer

Before proceeding, be sure you have installed the software on the supplied ViewNX 2 CD (📖 154).

## 1 Choose how pictures will be copied to a computer.

- **Direct USB connection:** Turn the camera off and ensure that a memory card containing pictures is inserted in the camera. Connect the camera to the computer using the supplied UC-E16 USB cable; the camera will turn on automatically.

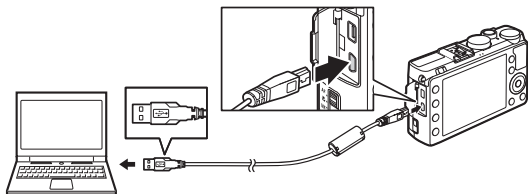

- **SD card slot:** If your computer is equipped with an SD card slot, the card can be inserted directly in the slot.
- **SD card reader:** Connect a card reader (available separately from third-party suppliers) to the computer and insert the memory card.

Nikon Transfer 2 will start automatically (if a dialog is displayed prompting you to choose a program, select **Nikon Transfer 2**). Note that Nikon Transfer 2 may take some time to launch if the memory card contains a very large number of pictures; wait until the Nikon Transfer 2 dialog is displayed before proceeding to Step 2.

### **USB Hubs**

Connect the camera directly to the computer; do not connect the cable via a USB hub or keyboard.



## 2 Copy pictures.

After confirming that the desired camera or memory card is displayed in the “Options” panel “Source” tab (①), click **Start Transfer** (②). At default settings, all pictures on the memory card will be copied to the computer.



## 3 Terminate the connection.

If the camera is connected to the computer, turn the camera off and disconnect the USB cable. If you are using a card reader or card slot, choose the appropriate option in the computer operating system to eject the removable disk corresponding to the memory card and then remove the card from the card reader or card slot.

### Windows 7

If the following dialog is displayed, select Nikon Transfer 2 as described below.

1 Under **Import pictures and videos**, click **Change program**. A program selection dialog will be displayed; select **Import File using Nikon Transfer 2** and click **OK**.



2 Double-click **Import File**.

# View Pictures

Pictures are displayed in ViewNX 2 when transfer is complete.

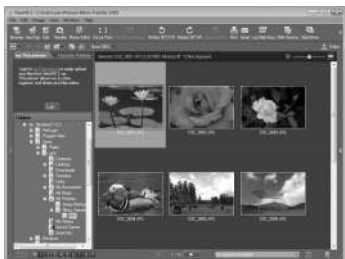

## **Starting ViewNX 2 Manually**

- Windows: Double-click the ViewNX 2 shortcut on the desktop.
- Mac OS: Click the ViewNX 2 icon in the Dock.

## **For More Information**

Consult online help for more information on using ViewNX 2.



# Printing Photographs

Selected JPEG images can be printed on a PictBridge printer (☞ 249) connected directly to the camera.

## Connecting the Printer

Connect the camera using the supplied UC-E16 USB cable.

---

**1** Turn the camera off.

---

**2** Connect the USB cable.

Turn the printer on and connect the USB cable as shown. Do not use force or attempt to insert the connectors at an angle.

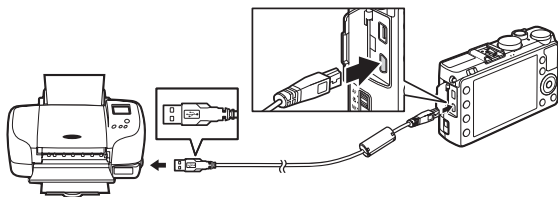

The camera will turn on automatically and a welcome screen will be displayed in the monitor, followed by a PictBridge playback display.



### **Printing Via Direct USB Connection**

Be sure the EN-EL20 battery is fully charged or use an optional EH-5b AC adapter and EP-5C power connector (☞ 230). When taking photographs to be printed via direct USB connection, set **Color space** to **sRGB** (☞ 178).

### **USB Hubs**

Connect the camera directly to the printer; do not connect the cable via a USB hub.



# Printing Pictures One at a Time

## 1 Select a picture.

Press ◀ or ▶ to view additional pictures.

Press the Ⓜ button to zoom in on the current frame (📖 144; press ▶ to exit zoom). To view six pictures at a time, press the Ⓜ(?) button. Use the multi selector to highlight pictures, or press Ⓜ to display the highlighted picture full frame.



## 2 Display printing options.

Press Ⓜ to display PictBridge printing options.



## 3 Adjust printing options.

Press ▲ or ▼ to highlight an option and press ▶ to select.

| Option        | Description  |
|---------------|--|
| Page size     | Highlight a page size (only sizes supported by the current printer are listed) and press Ⓜ to select and exit to the previous menu (to print at the default page size for the current printer, select <b>Printer default</b> ).                                |
| No. of copies | Press ▲ or ▼ to choose number of copies (maximum 99), then press Ⓜ to select and return to the previous menu.  |
| Border        | This option is available only if supported by the printer. Highlight <b>Printer default</b> (use current printer settings), <b>Print with border</b> (print photo with white border), or <b>No border</b> and press Ⓜ to select and exit to the previous menu. |



| Option            | Description   |
|-------------------|---|
| <b>Time stamp</b> | Highlight <b>Printer default</b> (use current printer settings), <b>Print time stamp</b> (print times and dates of recording on photos), or <b>No time stamp</b> and press <b>OK</b> to select and exit to the previous menu.   |
| <b>Cropping</b>   | This option is available only if supported by the printer. To exit without cropping, highlight <b>No cropping</b> and press <b>OK</b> . To crop the current picture, highlight <b>Crop</b> and press <b>▶</b> . A crop selection dialog will be displayed; press <b>Ⓚ</b> to increase the size of the crop, <b>Ⓚ(?)</b> to decrease. Position the crop using the multi selector and press <b>OK</b> . Note that print quality may drop if small crops are printed at large sizes. |

## 4 Start printing.

Select **Start printing** and press **OK** to start printing. To cancel before all copies have been printed, press **OK**.



# Printing Multiple Pictures

## 1 Display the PictBridge menu.

Press the **MENU** button in the PictBridge playback display.

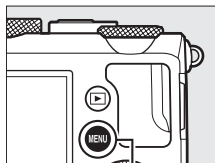

MENU button

## 2 Choose an option.

Highlight one of the following options and press ►.











- **Print select:** Select pictures for printing.
- **Select date:** Print one copy of all the pictures taken on a selected date.
- **Print (DPOF):** Print an existing print order created with the **DPOF print order** option in the playback menu (☞ 166). The current print order will be displayed in Step 3.
- **Index print:** To create an index print of all JPEG pictures on the memory card, proceed to Step 4. Note that if the memory card contains more than 256 pictures, only the first 256 images will be printed.







### ✓ Selecting Photographs for Printing

NEF (RAW) photographs (☞ 69) can not be selected for printing. JPEG copies of NEF (RAW) images can be created using the **NEF (RAW) processing** option in the retouch menu (☞ 209).





### 3 Select pictures or choose a date.

**If you chose Print select or Print (DPOF) in Step 2,** use the multi selector to scroll through the pictures on the memory card. To display the current picture full screen, press and hold the  button. To select the current picture for printing, hold the  button and press . The picture will be marked with a  icon and the number of prints will be set to 1. Keeping the  button pressed, press  or  to specify the number of prints (up to 99; to deselect the picture, press  when the number of prints is 1). Continue until all the desired pictures have been selected.

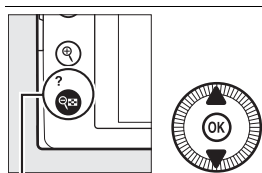
**If you chose Select date in Step 2,** press  or  to highlight a date and press  to toggle the highlighted date on or off. To view the pictures taken on the selected date, press . Use the multi selector to scroll through the pictures, or press and hold  to view the current picture full screen. Press  again to return to the date selection dialog.



 button +  :  
Choose number of copies

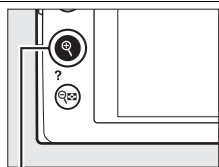

 button: View photo full screen



 button: View highlighted photo full screen

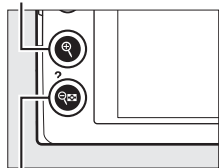

 button: View photos for selected date



---

## 4 Display printing options.

Press  to display PictBridge printing options.





---

## 5 Adjust printing options.

Choose page size, border, and time stamp options as described on page 161 (a warning will be displayed if the selected page size is too small for an index print).

---

## 6 Start printing.

Select **Start printing** and press  to start printing. To cancel before all copies have been printed, press .



### See Also

See page 242 for information on what to do if an error occurs during printing.





---

### 3 Display imprint options.

Press **OK** to display data imprint options.

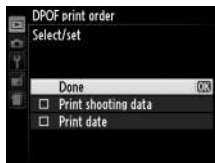

---

### 4 Select imprint options.

Highlight the following options and press **▶** to toggle the highlighted option on or off (to complete the print order without including this information, proceed to Step 5).

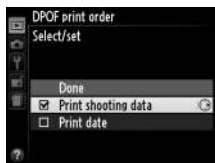

- **Print shooting data:** Print shutter speed and aperture on all pictures in print order.
- **Print date:** Print date of recording on all pictures in print order.

---

### 5 Complete the print order.

Press **OK** to complete the print order.



### **DPOF Print Order**

To print the current print order when the camera is connected to a PictBridge printer, select **Print (DPOF)** in the PictBridge menu and follow the steps in “Printing Multiple Pictures” to modify and print the current order (📖 163). DPOF print date and shooting data options are not supported when printing via direct USB connection; to print the date of recording on photographs in the current print order, use the PictBridge **Time stamp** option.

The **DPOF print order** option can not be used if there is not enough space on the memory card to store the print order.

NEF (RAW) photographs (📖 69) can not be selected using this option. JPEG copies of NEF (RAW) images can be created using the **NEF (RAW) processing** option in the retouch menu (📖 209).

Print orders may not print correctly if images are deleted using a computer or other device after the print order is created.



# Viewing Photographs on TV

The camera can be connected to high-definition video devices using a High-Definition Multimedia Interface (HDMI) cable (available separately from commercial sources). The cable must have a HDMI mini connector (Type C) for connection to the camera.

---

## 1 Turn the camera off.

Always turn the camera off before connecting or disconnecting an HDMI cable.

---

## 2 Connect the HDMI cable as shown.

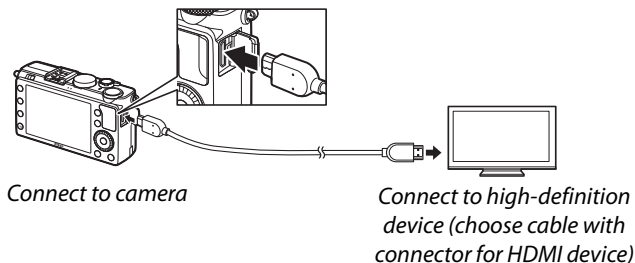

---

## 3 Tune the device to the HDMI channel.

---

## 4 Turn the camera on and press the button.

During playback, images will be displayed on the high-definition television or monitor screen. Note that the edges of images may not be displayed.



### **Standard Televisions**

The camera can only be connected to devices with an HDMI connector.

### **Television Playback**

Use of an EH-5b AC adapter and EP-5C power connector (available separately) is recommended for extended playback. Volume can be adjusted using television controls; the camera controls can not be used.

### **Using External HDMI Displays**

HDMI displays connected via an HDMI cable can be used during shooting. During movie recording, images will be output to the HDMI device at the resolution and frame rate selected for **Movie settings > Frame size/frame rate** in the shooting menu (☞ 43); note, however, that if **1080i (interlaced)** is selected for **HDMI > Output resolution** in the setup menu, the image will be output at 720p, while if **1920 × 1080; 30p** or **1920 × 1080; 25p** is selected for **Frame size/frame rate**, the image will be displayed on the camera, not on the HDMI device. Movies may be output at a frame size smaller than that selected for **Frame size/frame rate** (☞ 43).

### **Close the Connector Cover**

Close the connector cover when the connectors are not in use. Foreign matter in the connectors can interfere with data transfer.



# HDMI Options

The **HDMI** option in the setup menu controls output resolution and can be used to enable the camera for remote control from devices that support HDMI-CEC (**H**igh-**D**efinition **M**ultimedia **I**nterface–**C**onsumer **E**lectronics **C**ontrol, a standard that allows HDMI devices to be used to control peripherals to which they are connected). Note that when connected to an HDMI-CEC device, the camera will turn off automatically if no operations are performed for 30 minutes, regardless of the option selected for **Auto off timer**.

## ■ ■ *Output Resolution*

Choose the format for images output to the HDMI device. If **Auto** is selected, the camera will automatically select the appropriate format. Regardless of the option selected, **Auto** will be used for movie recording and playback.

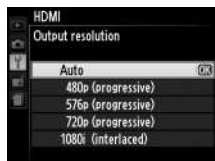

## ■ ■ *Device Control*

If **On** is selected for **HDMI > Device control** in the setup menu when the camera is connected to a television that supports HDMI-CEC and both the camera and television are on, the display shown at right will appear on the television and the television remote can be used in place of the camera multi selector and **OK** button during full-frame playback and slide shows. If **Off** is selected, the television remote can not be used to control the camera.

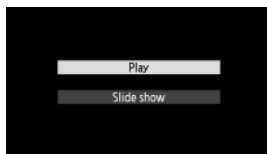

# Camera Menus

## ▶ The Playback Menu: *Managing Images*

To display the playback menu, press **MENU** and select the  (playback menu) tab.

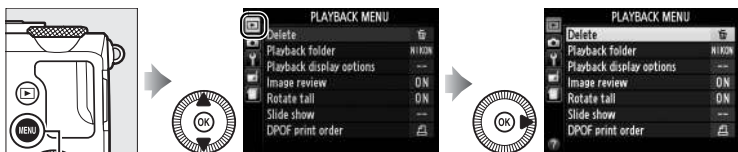

**MENU** button

The playback menu contains the following options:

| Option                          |  |
|---------------------------------|---|
| <b>Delete</b>                   | 150   |
| <b>Playback folder</b>          | 173   |
| <b>Playback display options</b> | 173   |
| <b>Image review</b>             | 173   |

| Option                  |  |
|-------------------------|---|
| <b>Rotate tall</b>      | 174   |
| <b>Slide show</b>       | 174   |
| <b>DPOF print order</b> | 166   |

### See Also

Menu defaults are listed on page 16.



## Playback Folder

MENU button →  playback menu

Choose a folder for playback:

| Option         | Description  |
|----------------|--|
| <b>All</b>     | Pictures in all folders will be visible during playback.   |
| <b>Current</b> | Only photos in the folder currently selected for <b>Storage folder</b> in the shooting menu (📖 177) are displayed during playback. |

## Playback Display Options

MENU button →  playback menu

Choose the information that can be displayed by pressing ▲ or ▼ in full-frame playback (📖 134). Press ▲ or ▼ to highlight an option, then press ► to select the option for the photo information display. A  appears next to selected items; to deselect, highlight and press ►. To return to the playback menu, highlight **Done** and press .

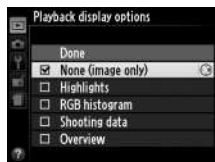

## Image Review

MENU button →  playback menu

Choose whether pictures are automatically displayed in the monitor immediately after shooting. If **Off** is selected, pictures can only be displayed by pressing the  button.

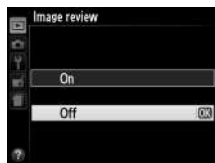

## Rotate Tall

MENU button →  playback menu

Choose whether to rotate “tall” (portrait-orientation) pictures for display during playback. Note that because the camera itself is already in the appropriate orientation during shooting, images are not rotated automatically during image review.

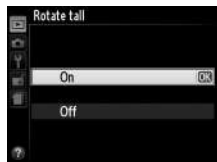

| Option     | Description   |
|------------|---|
| <b>On</b>  | “Tall” (portrait-orientation) pictures are automatically rotated for display in the camera monitor. Pictures taken with <b>Off</b> selected for <b>Auto image rotation</b> (📖 187) will be displayed in “wide” (landscape) orientation. |
| <b>Off</b> | “Tall” (portrait-orientation) pictures are displayed in “wide” (landscape) orientation.   |

## Slide Show

MENU button →  playback menu

Create a slide show of the pictures in the current playback folder (📖 173).

| Option                | Description                                     |
|-----------------------|---|
| <b>Start</b>          | Start slide show.                               |
| <b>Frame interval</b> | Choose how long each picture will be displayed. |



To start the slide show, highlight **Start** and press **OK**. The following operations can be performed while the slide show is in progress:



| To                         | Use         | Description  |
|----------------------------|-------------|--|
| Skip back/skip ahead       |             | Press <b>◀</b> to return to previous frame, <b>▶</b> to skip to next frame, or rotate multi selector or command dial to skip frames. |
| View additional photo info |             | Change photo info displayed (📖 134).   |
| Pause/resume slide show    |             | Pause show. Press again to resume.   |
| Exit to playback menu      | <b>MENU</b> | End show and return to playback menu.  |
| Exit to playback mode      |             | End show and return to playback mode.  |
| Exit to shooting mode      |             | Press shutter-release button halfway to exit to shooting display.  |

The dialog shown at right is displayed when the show ends. Select **Restart** to restart or **Exit** to return to the playback menu.



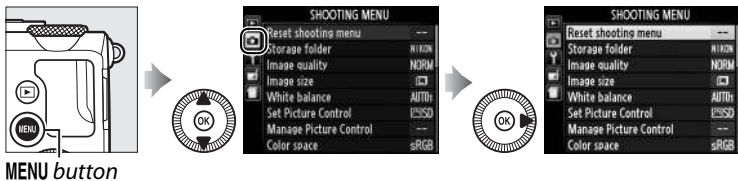

# The Shooting Menu: *Shooting Options*

To display the shooting menu, press **MENU** and select the  (shooting menu) tab.



The shooting menu contains the following options:

| Option                        |  | Option                                |  |
|-------------------------------|---|---------------------------------------|---|
| <b>Reset shooting menu</b>    | 176   | <b>High ISO NR</b>                    | 179   |
| <b>Storage folder</b>         | 177   | <b>ISO sensitivity settings</b>       | 81  |
| <b>Image quality</b>          | 69  | <b>Release mode</b>                   | 63  |
| <b>Image size</b>             | 72  | <b>Built-in AF-assist illuminator</b> | 180   |
| <b>White balance</b>          | 89  | <b>Exposure comp. for flash</b>       | 180   |
| <b>Set Picture Control</b>    | 99  | <b>Flash cntrl for built-in flash</b> | 181   |
| <b>Manage Picture Control</b> | 106   | <b>Auto bracketing set</b>            | 181   |
| <b>Color space</b>            | 178   | <b>Interval timer shooting</b>        | 127   |
| <b>Active D-Lighting</b>      | 110   | <b>Movie settings</b>                 | 43  |
| <b>Long exposure NR</b>       | 179   |                                       |   |

**Note:** Depending on camera settings, some items may be grayed out and unavailable. For information on the options available in each shooting mode, see page 236.

## **Reset Shooting Menu**

**MENU button** →  *shooting menu*

Select **Yes** to restore shooting menu options to their default values ( 16).



Create, rename, or delete folders, or choose the folder in which subsequent photographs will be stored.

- **Select folder:** Choose the folder in which subsequent photographs will be stored.



- **New:** Create a new folder and name it as described on pages 107–108. Folder names can be up to five characters long.
- **Rename:** Select a folder from the list and rename it as described on pages 107–108.
- **Delete:** Delete all empty folders on the memory card.

### Folder Names

On the memory card, folder names are preceded by a three-digit folder number assigned automatically by the camera (e.g., 100NIKON). Each folder can contain up to 999 photographs. During shooting, pictures are stored in the highest-numbered folder with the selected name. If a photograph is taken when the current folder is full or contains a photograph numbered 9999, the camera will create a new folder by adding 1 to the current folder number (e.g., 101NIKON). The camera treats folders with the same name but different folder numbers as the same folder. For example, if the folder NIKON is selected for **Storage folder**, photographs in all folders named NIKON (100NIKON, 101NIKON, 102NIKON, etc.) will be visible when **Current** is selected for **Playback folder** ( 173). Renaming changes all folders with the same name but leaves the folder numbers intact. Selecting **Delete** deletes empty numbered folders but leaves other folders with the same name intact.



The color space determines the gamut of colors available for color reproduction. Choose **sRGB** for photographs that will be printed or used “as is,” with no further modification. **Adobe RGB** has a wider color gamut and is recommended for images that will be extensively processed or retouched after leaving the camera.

### **Color Space**

Color spaces define the correspondence between colors and the numeric values that represent them in a digital image file. The sRGB color space is widely used, while the Adobe RGB color space is typically used in publishing and commercial printing. sRGB is recommended when taking photographs that will be printed without modification or viewed in applications that do not support color management, or when taking photographs that will be printed with ExifPrint, the direct printing option on some household printers, or kiosk printing or other commercial print services. Adobe RGB photographs can also be printed using these options, but colors may not be as vivid.

JPEG photographs taken in the Adobe RGB color space are DCF compliant; applications and printers that support DCF will select the correct color space automatically. If the application or device does not support DCF, select the appropriate color space manually. For more information, see the documentation provided with the application or device.

### **Nikon Software**

ViewNX 2 (supplied) and Capture NX 2 (available separately) automatically select the correct color space when opening photographs created with this camera.

## Long Exposure NR

MENU button →  shooting menu

If **On** is selected, photographs taken at shutter speeds slower than 1 s will be processed to reduce noise (bright spots, randomly-spaced bright pixels, or fog). The time required for processing roughly doubles; the message shown at right will be displayed when processing starts and pictures can not be taken until processing is complete (if the camera is turned off before processing is complete, the picture will be saved but noise reduction will not be performed). In continuous release mode, frame rates will slow and while photographs are being processed, the capacity of the memory buffer will drop. Long exposure noise reduction is not available during movie recording.

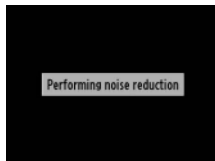

## High ISO NR

MENU button →  shooting menu

Photographs taken at high ISO sensitivities can be processed to reduce “noise.”

| Option        | Description  |
|---------------|--|
| <b>High</b>   | Reduce noise (randomly-spaced bright pixels, lines, or fog), particularly in photographs taken at high ISO sensitivities. Choose the amount of noise reduction performed from <b>High</b> , <b>Normal</b> , and <b>Low</b> . |
| <b>Normal</b> |  |
| <b>Low</b>    |  |
| <b>Off</b>    | Noise reduction is only performed at ISO sensitivities of ISO 1600 and higher. The amount of noise reduction is less than the amount performed when <b>Low</b> is selected for <b>High ISO NR</b> .                          |



## Built-in AF-assist Illuminator

MENU button →  shooting menu

Choose whether the built-in AF-assist illuminator lights to assist the focus operation when lighting is poor.

*AF-assist illuminator*

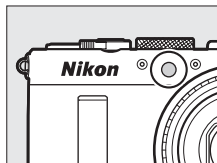

| Option     | Description  |
|------------|--|
| <b>On</b>  | The AF-assist illuminator lights when lighting is poor.  |
| <b>Off</b> | The AF-assist illuminator does not light to assist the focus operation. The camera may not be able to focus using autofocus when lighting is poor. |



### See Also

For information on the shooting modes in which AF-assist is available, see page 236.

## Exposure Comp. for Flash

MENU button →  shooting menu

Choose how the camera adjusts flash level when exposure compensation is used.



| Option   | Description   |
|--|---|
|  <b>Entire frame</b>     | Both flash level and exposure compensation are adjusted to modify exposure over the entire frame. |
|  <b>Background only</b> | Exposure compensation applies to background only.   |



## Flash Cntrl for Built-in Flash

MENU button →  shooting menu

Choose the flash mode for the built-in flash.

| Option   | Description   |
|--|---|
| TTL  <b>TTL</b> | Flash output is adjusted automatically in response to shooting conditions.  |
|  <b>Manual</b>  | Choose a flash level between <b>Full</b> and <b>1/32</b> ( $1/32$ of full power). The camera does not emit monitor pre-flashes. |

### **Manual**







A  icon flashes in the monitor when **Manual** is selected and the flash is raised.

### **The SB-400**

When an optional SB-400 flash unit is attached and turned on, **Flash cntrl for built-in flash** changes to **Optional flash**, allowing the flash control mode for the SB-400 to be selected from **TTL** and **Manual**.

## Auto Bracketing Set

MENU button →  shooting menu

Choose the setting or settings bracketed when auto bracketing ( 123) is in effect. Choose **AE bracketing** ( 124) to bracket exposure, **WB bracketing** ( 124) to perform white-balance bracketing ( 123), or **ADL bracketing** ( 125) to perform bracketing using Active D-Lighting ( 110). Note that white balance bracketing is not available at image quality settings of NEF (RAW) or NEF (RAW) + JPEG.



# Y The Setup Menu: *Camera Setup*

To display the setup menu, press **MENU** and select the **Y** (setup menu) tab.



**MENU** button

The setup menu contains the following options:

| Option                     |     | Option                             |     |
|----------------------------|-----|------------------------------------|-----|
| <b>Format memory card</b>  | 183 | <b>Remote on duration (ML-L3)</b>  | 189 |
| <b>Save user settings</b>  | 60  | <b>Beep</b>                        | 190 |
| <b>Reset user settings</b> | 62  | <b>Shutter sound</b>               | 190 |
| <b>Monitor brightness</b>  | 183 | <b>File number sequence</b>        | 191 |
| <b>Photo info</b>          | 184 | <b>MF distance indicator units</b> | 192 |
| <b>HDMI</b>                | 169 | <b>Reverse indicators</b>          | 192 |
| <b>Flicker reduction</b>   | 184 | <b>Assign Fn1 button</b>           | 193 |
| <b>Time zone and date</b>  | 185 | <b>Assign ISO/Fn2 button</b>       | 194 |
| <b>Language</b>            | 186 | <b>Reverse dial rotation</b>       | 194 |
| <b>Image comment</b>       | 186 | <b>Slot empty release lock</b>     | 195 |
| <b>Auto image rotation</b> | 187 | <b>GPS</b>                         | 130 |
| <b>Self-timer</b>          | 188 | <b>Eye-Fi upload*</b>              | 195 |
| <b>Auto off timer</b>      | 189 | <b>Firmware version</b>            | 196 |
| <b>Image review time</b>   | 189 |                                    |     |

\* Only available when compatible Eye-Fi memory card is inserted (195).



## See Also

Menu defaults are listed on page 16.

## Format Memory Card

MENU button →  setup menu

Memory cards must be formatted before first use or after being used or formatted in other devices.

### Formatting Memory Cards

Formatting memory cards permanently deletes any data they may contain. Be sure to copy any photographs and other data you wish to keep to a computer before proceeding (📖 156).

#### 1 Highlight Yes.

To exit without formatting the memory card, highlight **No** and press .

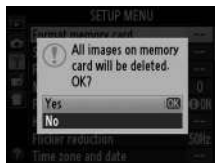

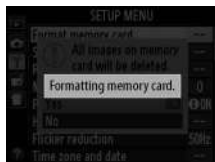

#### 2 Press .

The message shown at right will be displayed while formatting is in progress. *Do not remove the memory card or remove or disconnect the power source during formatting.*



## Monitor Brightness

MENU button →  setup menu

Press  or  to choose monitor brightness. Choose higher values for increased brightness, lower values for reduced brightness. Choose lower values if the monitor seems too bright when an optional external viewfinder is attached (📖 231).

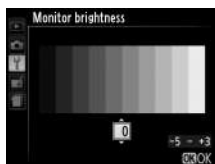

## Photo Info

MENU button →  setup menu

Choose the information displayed in the monitor during shooting. Select **Show info** or **Hide info** to view or hide shooting indicators (📖 134). Select **Framing grid** to view a framing grid or **Virtual horizon** to display a virtual horizon to assist in keeping the camera level.



## Flicker Reduction

MENU button →  setup menu

Reduce flicker and banding when shooting under fluorescent or mercury-vapor lighting. Choose an option that matches the frequency of the local AC power supply.



### **Flicker Reduction**

If you are unsure as to the frequency of the local power supply, test both options and choose the one that produces the best results. Flicker reduction may not produce the desired results if the subject is very bright, in which case you should select mode A or M and choose a smaller aperture (higher f-number).

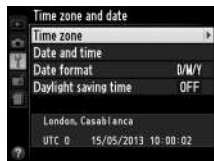

Change time zones, set the camera clock, choose the date display order, and turn daylight saving time on or off.

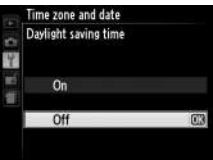

| Option                             | Description   |
|------------------------------------|---|
| <p><b>Time zone</b></p>            | <p>Choose a time zone. The camera clock is automatically set to the time in the new time zone.</p>   |
| <p><b>Date and time</b></p>        | <p>Set the camera clock (📖 25).</p>    |
| <p><b>Date format</b></p>          | <p>Choose the order in which the day, month, and year are displayed.</p>   |
| <p><b>Daylight saving time</b></p> | <p>Turn daylight saving time on or off. The camera clock will automatically be advanced or set back one hour. The default setting is <b>Off</b>.</p>  |



Choose a language for camera menus and messages.

## Image Comment

Add a comment to new photographs as they are taken. Comments can be viewed as metadata in ViewNX 2 (supplied) or Capture NX 2 (available separately; □ 231). The comment is also visible on the shooting data page in the photo information display (□ 137). The following options are available:

- **Input comment:** Input a comment as described on page 107. Comments can be up to 36 characters long.
- **Attach comment:** Select this option to attach the comment to all subsequent photographs. **Attach comment** can be turned on and off by highlighting it and pressing ►. After choosing the desired setting, highlight **Done** and press Ⓚ to exit.



Photographs taken while **On** is selected contain information on camera orientation, allowing them to be rotated automatically during playback or when viewed in ViewNX 2 or Capture NX 2 (available separately; □ 231). The following orientations are recorded:



*Landscape (wide)  
orientation*



*Camera rotated 90°  
clockwise*

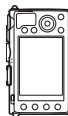

*Camera rotated 90°  
counterclockwise*

Camera orientation is not recorded when **Off** is selected. Choose this option when panning or taking photographs with the lens pointing up or down.



### **Rotate Tall**

To automatically rotate “tall” (portrait-orientation) photographs for display during playback, select **On** for the **Rotate tall** option in the playback menu (□ 174).

Choose the length of the shutter release delay and the number of shots taken ( 66).

- **Self-timer delay:** Choose the length of the shutter-release delay.
- **Number of shots:** Press ▲ and ▼ to choose the number of shots taken each time the shutter-release button is pressed (from 1 to 9).

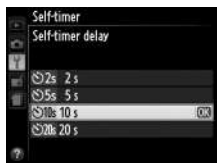

## Auto off Timer

MENU button →  setup menu

Choose the delay before the monitor turns off to save power when no operations are performed; the camera will turn off automatically if no operations are performed for an additional three minutes after the monitor has turned off. Note that regardless of the option selected, the monitor will remain on for 3 minutes while menus or shooting information is displayed and for 30 minutes when an optional EH-5b AC adapter is connected, and will not turn off during slide shows or while images are being transmitted using an Eye-Fi card.



## Image Review Time

MENU button →  setup menu

Choose how long pictures are displayed in the monitor after shooting.



## Remote on Duration (ML-L3)

MENU button →  setup menu

Choose how long the camera will wait for a signal from the optional ML-L3 remote control before cancelling the currently selected remote control release mode and turning off (□ 66). Choose shorter times for longer battery life.



## Beep

MENU button →  setup menu

Choose the pitch (**High** or **Low**) of the beep that sounds when the camera focuses using autofocus, while the release timer is counting down in self-timer and delayed remote modes (📖 63) when a photograph is taken in quick-response remote mode (📖 63), or if you attempt to take a photograph when the memory card is locked (📖 24). Select **Off** to prevent the beep from sounding. Note that a beep will not sound in movie mode when the memory card is locked or the camera focuses.



## Shutter Sound

MENU button →  setup menu

Choose whether the camera makes a sound when the shutter is released.

### The Icon

A  icon is displayed when an option other than **Off** is selected for **Beep** or **Shutter sound**.



When a photograph is taken, the camera names the file by adding one to the last file number used. This option controls whether file numbering continues from the last number used when a new folder is created, the memory card is formatted, or a new memory card is inserted in the camera.

| Option       | Description   |
|--------------|---|
| <b>On</b>    | When a new folder is created, the memory card formatted, or a new memory card inserted in the camera, file numbering continues from the last number used. If a photograph is taken when the current folder contains a photograph numbered 9999, a new folder will be created automatically and file numbering will begin again from 0001. |
| <b>Off</b>   | File numbering is reset to 0001 when a new folder is created, the memory card is formatted, or a new memory card is inserted in the camera. Note that a new folder is created automatically if a photograph is taken when the current folder contains 999 photographs.  |
| <b>Reset</b> | Resets the file numbering for <b>On</b> to 0001 and creates a new folder with the next photograph taken.  |

### **File Number Sequence**

If the current folder is numbered 999 and contains either 999 photographs or a photograph numbered 9999, the shutter-release button will be disabled and no further photographs can be taken. Choose **Reset** and then either format the current memory card or insert a new memory card.





## MF Distance Indicator Units

MENU button →  setup menu

Choose whether the focus distance for manual focus is displayed in meters (m) or feet (ft).

## Reverse Indicators

MENU button →  setup menu

If  (+<sup>0</sup>-) is selected, the exposure indicator is displayed with positive values on the left and negative values on the right. Select  (-<sup>0</sup>+) to display negative values on the left and positive values on the right.



Choose the role played by the Fn1 button:

| Option                       | Description   |
|------------------------------|---|
| <b>Flash mode</b>            | Press the Fn1 button and rotate the command dial to choose the flash mode (☞ 113).  |
| <b>Release mode</b>          | Press the Fn1 button and rotate the command dial to choose the release mode (☞ 63).   |
| <b>Self-timer</b>            | Press the Fn1 button to select self-timer mode. Press again to cancel self-timer mode (☞ 66).   |
| <b>FV lock</b>               | Press the Fn1 button once to lock flash output, again to release (☞ 118).   |
| <b>AE/AF lock</b>            | Lock exposure and focus while the Fn1 button is pressed (☞ 79).   |
| <b>AE lock only</b>          | Lock exposure at the value selected by the metering system while the Fn1 button is pressed. Exposure will not change if the composition is changed while the button is pressed.   |
| <b>AE lock (Hold)</b>        | Press the Fn1 button to lock exposure. Exposure remains locked until the Fn1 button is pressed again or the auto off timer expires.   |
| <b>AF lock only</b>          | Focus locks while the Fn1 button is pressed (☞ 79).   |
| <b>AF-ON</b>                 | Pressing Fn1 button initiates autofocus. When single-servo autofocus is selected, the camera can not be focused by pressing the shutter-release button.   |
| <b>Exposure compensation</b> | Press the Fn1 button and rotate the command dial to choose the exposure compensation value (☞ 87).  |
| <b>+ NEF (RAW)</b>           | Press the Fn1 button to record NEF (RAW) copies with all photos taken the next time the shutter-release button is pressed. Normal shooting will then resume automatically. To exit without creating NEF (RAW) copies, press the Fn1 button again. This option has no effect when <b>Movie recording</b> is selected for <b>Release mode</b> . |



## Assign ISO/Fn2 Button

MENU button → Y setup menu

Choose the role played by the ISO (Fn2) button:

| Option                    | Description  |
|---------------------------|--|
| <b>ISO sensitivity</b>    | Press the <b>ISO</b> (Fn2) button and rotate the command dial to set ISO sensitivity (☞ 81).   |
| <b>White balance</b>      | Press the <b>ISO</b> (Fn2) button and rotate the command dial to adjust white balance (☞ 89).  |
| <b>Image quality/size</b> | Press the <b>ISO</b> (Fn2) button and rotate the command dial to choose image quality and size (☞ 69, 72).   |
| <b>Metering</b>           | Press the <b>ISO</b> (Fn2) button and rotate the command dial to choose metering option (☞ 85).  |
| <b>Active D-Lighting</b>  | Press the <b>ISO</b> (Fn2) button and rotate the command dial to choose a setting for Active D-Lighting (☞ 110).   |
| <b>Auto bracketing</b>    | Press the <b>ISO</b> (Fn2) button and rotate the command dial to choose the bracketing increment (exposure and white balance bracketing) or turn ADL bracketing on or off (☞ 123). |
| <b>Monitor brightness</b> | Keeping the <b>ISO</b> (Fn2) button pressed, press ▲ or ▼ to adjust monitor brightness (☞ 183).  |

## Reverse Dial Rotation

MENU button → Y setup menu

Reverse the direction of rotation of the command dial and multi selector when they are used to make adjustments to exposure compensation (**Exposure compensation**) and/or shutter speed and aperture (**Shutter speed/aperture**). Highlight options and press ► to select or deselect, then highlight **Done** and press OK.

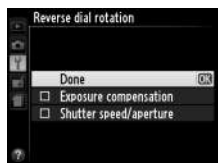

## Slot Empty Release Lock

MENU button →  setup menu

If **Release locked** is selected, the shutter-release button is only enabled when a memory card is inserted in the camera. Selecting **Enable release** allows the shutter to be released when no memory card is inserted, although no pictures will be recorded (they will however be displayed in the monitor in demo mode).





## Eye-Fi Upload

MENU button →  setup menu

This option is displayed only when an Eye-Fi memory card (available separately from third-party suppliers) is inserted in the camera. Choose **Enable** to upload photographs to a preselected destination. Note that pictures will not be uploaded if signal strength is insufficient.

Observe all local laws concerning wireless devices. Where wireless devices are prohibited, remove the card from the camera, as the card may continue to emit wireless signals even when **Disable** is selected.

When an Eye-Fi card is inserted, its status is indicated by an icon in the monitor:

- : Eye-Fi upload disabled.
- : Eye-Fi upload enabled but no pictures available for upload.
-  (static): Eye-Fi upload enabled; waiting to begin upload.
-  (animated): Eye-Fi upload enabled; uploading data.
- : Error — camera can not control Eye-Fi card.



### **Eye-Fi Cards**

Eye-Fi cards can not be used with optional WU-1a wireless mobile adapters. Do not insert Eye-Fi cards while a WU-1a is connected.

Eye-Fi cards may emit wireless signals when **Disable** is selected. If a warning is displayed in the monitor ( 243), turn the camera off and remove the card.

See the manual provided with the Eye-Fi card, and direct any inquiries to the manufacturer. The camera can be used to turn Eye-Fi cards on and off, but may not support other Eye-Fi functions.

### **Supported Eye-Fi Cards**

Some cards may not be available in some countries or regions; consult the manufacturer for more information. Eye-Fi cards are for use only in the country of purchase.

### **Using Eye-Fi Cards in Ad Hoc Mode**

Additional time may be required when connecting using Eye-Fi cards that support ad hoc mode. Select longer values for **Auto off timer** in the setup menu ( 189).

## **Firmware Version**

MENU button →  setup menu

View the current camera firmware version.























# The Retouch Menu: Creating Retouched Copies

To display the retouch menu, press **MENU** and select the  (retouch menu) tab.



**MENU** button

The retouch menu is used to create trimmed or retouched copies of the photographs on the memory card, and is only available when a memory card containing photographs is inserted in the camera.

| Option  |                             |  | Option   |                                 |  |
|---|-----------------------------|---|--|---------------------------------|---|
|    | <b>D-Lighting</b>           | 200   |   | <b>Straighten</b>               | 213   |
|    | <b>Red-eye correction</b>   | 201   |   | <b>Fisheye</b>                  | 213   |
|    | <b>Trim</b>                 | 202   |   | <b>Color outline</b>            | 214   |
|    | <b>Monochrome</b>           | 203   |   | <b>Color sketch</b>             | 214   |
|    | <b>Filter effects</b>       | 203   |   | <b>Perspective control</b>      | 215   |
|    | <b>Color balance</b>        | 205   |   | <b>Miniature effect</b>         | 216   |
|    | <b>Image overlay</b>        | 206   |   | <b>Selective color</b>          | 217   |
|    | <b>NEF (RAW) processing</b> | 209   |   | <b>Edit movie</b>               | 47  |
|   | <b>Resize</b>               | 211   |  | <b>Side-by-side comparison*</b> | 219   |
|  | <b>Quick retouch</b>        | 213   |  |                                 |   |

\* Available only if  button is pressed in full-frame playback when a retouched image or original is displayed.



# Creating Retouched Copies

To create a retouched copy:

- 1 Display retouch options.**  
Highlight the desired item in the retouch menu and press **▶**.

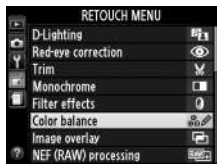

- 2 Select a picture.**  
Highlight a picture and press **OK** (to view the highlighted picture full screen, press and hold the **Q** button).



- 3 Select retouch options.**  
For more information, see the section for the selected item. To exit without creating a retouched copy, press **MENU**.

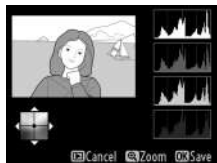

- 4 Create a retouched copy.**  
Press **OK** to create a retouched copy. Retouched copies are indicated by a  icon.



## Creating Retouched Copies During Playback

Options other than **Image overlay** and **Edit movie** can be used during playback.



*Display picture full frame and press .*



*Highlight an option and press .*

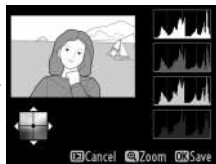

*Create retouched copy.*

## Retouch

The camera may not be able to display or retouch images created with other devices. If the image was recorded at image quality settings of NEF (RAW) + JPEG ( 69), retouch options apply only to the JPEG copy (**Image overlay** and **NEF (RAW) processing** excepted). Note that the monitor will turn off and the operation will be cancelled if no actions are performed for a brief period; any unsaved changes will be lost.

## Retouching Copies

Most options can be applied to copies created using other retouch options, although with the exceptions of **Image overlay** and **Edit movie > Choose start/end point**, each option can be applied only once (note that multiple edits may result in loss of detail). Options that can not be applied to the current image are grayed out and unavailable.

## Image Quality

Except in the case of copies created with **Trim**, **Image overlay**, **NEF (RAW) processing**, and **Resize**, copies created from JPEG images are the same size and quality as the original, while copies created from NEF (RAW) photos are saved as large fine-quality JPEG images.



## D-Lighting

MENU button →  retouch menu

D-Lighting brightens shadows, making it ideal for dark or backlit photographs.



*Before*











*After*

Press ▲ or ▼ to choose the amount of correction performed. The effect can be previewed in the edit display. Press **OK** to copy the photograph.









This option is used to correct “red-eye” caused by the flash, and is available only with photographs taken using the flash. The photograph selected for red-eye correction can be previewed in the edit display. Confirm the effects of red-eye correction and create a copy as described in the following table. Note that red-eye correction may not always produce the expected results and may in very rare circumstances be applied to portions of the image that are not affected by red-eye; check the preview thoroughly before proceeding.

| To                        | Use   | Description   |
|---------------------------|---|---|
| Zoom in                   |  | Press  button to zoom in,  (?) button to zoom out. While photo is zoomed in, use multi selector to view areas of image not visible in monitor. Keep multi selector pressed to scroll rapidly to other areas of frame. Navigation window is displayed when zoom buttons or multi selector is pressed; area currently visible in monitor is indicated by yellow border. Press  to cancel zoom. |
| Zoom out                  |  |   |
| View other areas of image |  | If the camera detects red-eye in the selected photograph, a copy will be created that has been processed to reduce its effects. No copy will be created if the camera is unable to detect red-eye.  |
| Cancel zoom               |  |   |
| Create copy               |  |   |



Create a cropped copy of the selected photograph. The selected photograph is displayed with the selected crop shown in yellow; create a cropped copy as described in the following table.



| To                       | Use   | Description  |
|--------------------------|---|--|
| Increase size of crop    |  | Press the  button to increase the size of the crop. |
| Reduce size of crop      |  | Press the  button to reduce the size of the crop.   |
| Change crop aspect ratio |  | Rotate the command dial to switch between aspect ratios of 3 : 2, 4 : 3, 5 : 4, 1 : 1, and 16 : 9.                                   |
| Move crop                |  | Use multi selector to move the crop to another area of the image. Press and hold the selector to move the crop more quickly.         |
| Create copy              |  | Save the current crop as a separate file.  |

### Trim: Image Quality and Size

Copies created from NEF (RAW) or NEF (RAW) + JPEG photos have an image quality of JPEG fine (69); cropped copies created from JPEG photos have the same image quality as the original. The size of the copy varies with crop size and aspect ratio and appears at upper left in the crop display.



### Viewing Cropped Copies

Playback zoom may not be available when cropped copies are displayed.

## Monochrome

MENU button →  retouch menu

Copy photographs in **Black-and-white**, **Sepia**, or **Cyanotype** (blue and white monochrome).

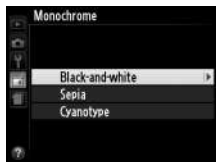

Selecting **Sepia** or **Cyanotype** displays a preview of the selected image; press ▲ to increase color saturation, ▼ to decrease. Press OK to create a monochrome copy.

Increase saturation



Decrease saturation



## Filter Effects

MENU button →  retouch menu

Choose from the following filter effects. After adjusting filter effects as described below, press OK to copy the photograph.

| Option             | Description  |
|--------------------|--|
| <b>Skylight</b>    | Creates the effect of a skylight filter, making the picture less blue. The effect can be previewed in the monitor as shown at right. |
| <b>Warm filter</b> | Creates a copy with warm tone filter effects, giving the copy a “warm” red cast. The effect can be previewed in the monitor.         |

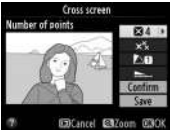
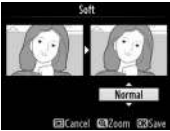

| Option  | Description   |
|---|---|
| <b>Red intensifier</b><br><b>Green intensifier</b><br><b>Blue intensifier</b> | Intensify reds ( <b>Red intensifier</b> ), greens ( <b>Green intensifier</b> ), or blues ( <b>Blue intensifier</b> ). Press ▲ to increase the effect, ▼ to decrease.   |
| <b>Cross screen</b>   | Add starburst effects to light sources. <ul style="list-style-type: none"> <li>• <b>Number of points:</b> Choose from four, six, or eight.</li> <li>• <b>Filter amount:</b> Choose the brightness of the light sources affected.</li> <li>• <b>Filter angle:</b> Choose the angle of the points.</li> <li>• <b>Length of points:</b> Choose the length of points.</li> <li>• <b>Confirm:</b> Preview the effects of the filter as shown at right. Press Ⓞ to preview the copy full frame.</li> <li>• <b>Save:</b> Create a retouched copy.</li> </ul>  |
| <b>Soft</b>   | Add a soft filter effect. Press ▲ or ▼ to choose the filter strength.    |

Use the multi selector to create a copy with modified color balance as shown below. The effect is displayed in the monitor together with red, green, and blue histograms (📖 135) giving the distribution of tones in the copy.

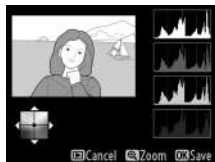

*Increase amount of green*



## Zoom









To zoom in on the image displayed in the monitor, press the  button. The histogram will be updated to show data only for the portion of the image displayed in the monitor. While the image is zoomed in, press the  (/) button to toggle back and forth between color balance and zoom. When zoom is selected, you can zoom in and out with the  and  (?) buttons and scroll the image with the multi selector.



Image overlay combines two existing NEF (RAW) photographs to create a single picture that is saved separately from the originals; the results, which make use of RAW data from the camera image sensor, are noticeably better than overlays created in an imaging application. The new picture is saved at current image quality and size settings; before creating an overlay, set image quality and size ( 69, 72; all options are available). To create an NEF (RAW) copy, choose an image quality of **NEF (RAW)**.



## 1 Select Image overlay.

Highlight **Image overlay** in the retouch menu and press .



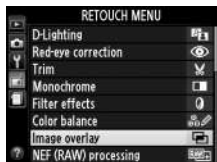

The dialog shown at right will be displayed, with **Image 1** highlighted; press  to display a list of the NEF (RAW) pictures created with this camera.



---

## 2 Select the first image.

Use the multi selector to highlight the first photograph in the overlay. To view the highlighted photograph full frame, press and hold the  button. Press  to select the highlighted photograph and return to the preview display.





---

## 3 Select the second image.

The selected image will appear as **Image 1**. Highlight **Image 2** and press , then select the second photo as described in Step 2.

---

## 4 Adjust gain.

Highlight **Image 1** or **Image 2** and optimize exposure for the overlay by pressing  or  to select gain from values between 0.1 and 2.0. Repeat for the second image. The default value is 1.0; select 0.5 to halve gain or 2.0 to double it. The effects of gain are visible in the **Preview** column.

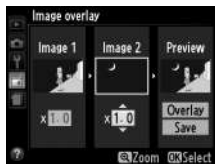

## 5 Preview the overlay.

Press ◀ or ▶ to place the cursor in the **Preview** column and press ▲ or ▼ to highlight **Overlay**. Press OK to preview the overlay as shown at right (to save the overlay without displaying a preview, select **Save**). To return to Step 4 and select new photos or adjust gain, press ⓧ (?).



## 6 Save the overlay.

Press OK while the preview is displayed to save the overlay. After an overlay is created, the resulting image will be displayed full-frame in the monitor.



### Image Overlay

The overlay has the same photo info (including date of recording, metering, shutter speed, aperture, shooting mode, exposure compensation, and image orientation) and values for white balance and Picture Control as the photograph selected for **Image 1**. The current image comment is appended to the overlay when it is saved.



Create JPEG copies of NEF (RAW) photographs ( 69).

## 1 Select NEF (RAW) processing.

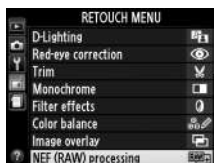
Highlight **NEF (RAW) processing** in the retouch menu and press  to display a picture selection dialog listing only NEF (RAW) images created with this camera.



## 2 Select a photograph.

Use the multi selector to highlight a photograph (to view the highlighted photograph full frame, press and hold the  button). Press  to select the highlighted photograph and proceed to the next step.



### 3 Adjust NEF (RAW) processing settings.

Adjust the settings listed below. Note that white balance is not available with pictures created with image overlay, and that exposure compensation can only be set to values between  $-2$  and  $+2$  EV. If **Auto** is selected for white balance, it will be set to whichever of **Normal** and **Keep warm lighting colors** was in effect when the picture was taken. The Picture Control grid is not displayed when Picture Controls are adjusted.

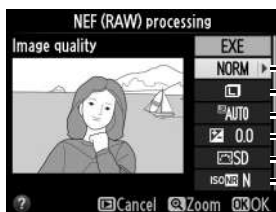

- Image quality (69)
- Image size (72)
- White balance (89)
- Exposure compensation (87)
- Picture Control (99)
- High ISO NR (179)

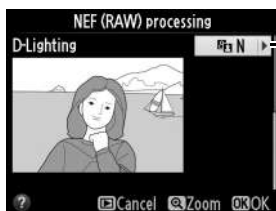

- D-Lighting (200)

### 4 Copy the photograph.

Highlight **EXE** and press **OK** to create a JPEG copy of the selected photograph (note that the copy will be recorded in the color space currently selected in the shooting menu, not the color space selected at the time the photograph was taken; 178). The resulting image will be displayed full-frame in the monitor. To exit without copying the photograph, press the **MENU** button.



Create small copies of selected photographs.

## 1 Select Resize.

To resize selected images, press MENU to display the menus and select **Resize** in the retouch menu.



## 2 Choose a size.

Highlight **Choose size** and press ►.







The options shown at right will be displayed; highlight an option and press **OK**.





### 3 Choose pictures.

Highlight **Select image** and press ►.

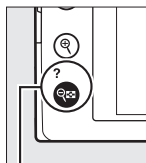

Highlight pictures using the multi selector and press the  (?) button to select or deselect (to view the highlighted picture full screen, press and hold the  button). Selected pictures are marked by a  icon. Press  when the selection is complete.



 (?) button



### 4 Save the resized copies.

A confirmation dialog will be displayed. Highlight **Yes** and press  to save the resized copies.



#### Viewing Resized Copies

Playback zoom may not be available when resized copies are displayed.

#### Image Quality

Copies created from NEF (RAW) or NEF (RAW) + JPEG photos have an image quality ( 69) of JPEG fine; copies created from JPEG photos have the same image quality as the original.

## Quick Retouch

MENU button →  retouch menu

Create copies with enhanced saturation and contrast. D-Lighting is applied as required to brighten dark or backlit subjects.

Press ▲ or ▼ to choose the amount of enhancement. The effect can be previewed in the edit display. Press Ⓞ to copy the photograph.

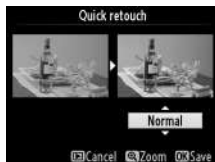

## Straighten

MENU button →  retouch menu

Create a straightened copy of the selected image. Press ► to rotate the image clockwise by up to five degrees in increments of approximately 0.25 degrees, ◀ to rotate it counterclockwise (the effect can be previewed in the edit display; note that edges of the image will be trimmed to create a square copy). Press Ⓞ to copy the photograph, or press ▶ to exit to playback without creating a copy.

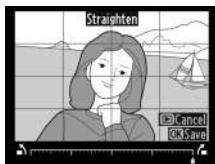

## Fisheye

MENU button →  retouch menu

Create copies that appear to have been taken with a fisheye lens. Press ► to increase the effect (this also increases the amount that will be cropped out at the edges of the image), ◀ to reduce it. The effect can be previewed in the edit display. Press Ⓞ to copy the photograph, or press ▶ to exit to playback without creating a copy.



## Color Outline

MENU button →  retouch menu

Create an outline copy of a photograph to use as a base for painting. The effect can be previewed in the edit display. Press **OK** to copy the photograph.



Before

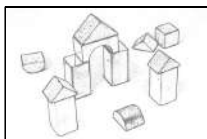

After



## Color Sketch

MENU button →  retouch menu

Create a copy of a photograph that resembles a sketch made with colored pencils. Press **▲** or **▼** to highlight **Vividness** or **Outlines** and press **◀** or **▶** to change. Vividness can be increased to make colors more saturated, or decreased for a washed-out, monochromatic effect, while outlines can be made thicker or thinner. Thicker outlines make colors more saturated. The results can be previewed in the edit display. Press **OK** to copy the photograph, or press **▶** to exit to playback without creating a copy.



## Perspective Control

MENU button →  retouch menu

Create copies that reduce the effects of perspective taken from the base of a tall object. Use the multi selector to adjust perspective (note that greater amounts of perspective control result in more of the edges being cropped out). The results can be previewed in the edit display. Press **OK** to copy the photograph, or press **▶** to exit to playback without creating a copy.











*Before*



*After*



Create a copy that appears to be a photo of a diorama. Works best with photos taken from a high vantage point. The area that will be in focus in the copy is indicated by a yellow frame.

| To                   | Press   | Description   |
|----------------------|---|---|
| Choose orientation   |  (?) | Press  (?) to choose orientation of area that is in focus. |
| Choose area in focus |      | If area of effect is in wide orientation, press ▲ or ▼ to position frame showing area of copy that will be in focus.                        |
|                      |      | If area of effect is in tall orientation, press ◀ or ▶ to position frame showing area of copy that will be in focus.                        |
| Choose size          |      | If area of effect is in wide orientation, press ◀ or ▶ to choose height.  |
|                      |      | If area of effect is in tall orientation, press ▲ or ▼ to choose width.   |
| Preview copy         |      | Preview copy.   |
| Cancel               |    | Exit to full-frame playback without creating copy.  |
| Create copy          |    | Create copy.  |



*Area in focus*

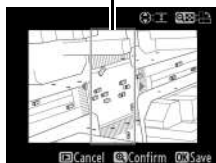

Create a copy in which only selected hues appear in color.

## 1 Select Selective color.

Highlight **Selective color** in the retouch menu and press **▶** to display a picture selection dialog.

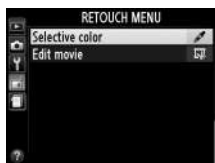

## 2 Select a photograph.

Highlight a photograph (to view the highlighted photograph full frame, press and hold the **Ⓚ** button). Press **Ⓚ** to select the highlighted photograph and proceed to the next step.



## 3 Select a color.

Use the multi selector to position the cursor over an object and press **Ⓚ** (**Ⓚ/O-M**) to select the color of the object as one that will remain in the final copy (the camera may have difficulty detecting unsaturated colors; choose a saturated color). To zoom in on the picture for precise color selection, press **Ⓚ**. Press **Ⓚ** (**?**) to zoom out.



**Ⓚ** (**Ⓚ/O-M**) button

*Selected color*



## 4 Highlight the color range.

Rotate the command dial to highlight the color range for the selected color.



Color range



## 5 Choose the color range.

Press ▲ or ▼ to increase or decrease the range of similar hues that will be included in the final photograph. Choose from values between 1 and 7; note that higher values may include hues from other colors. The effect can be previewed in the edit display.



## 6 Select additional colors.

To select additional colors, rotate the command dial to highlight another of the three color boxes at the top of the display and repeat Steps 3–5 to select another color. Repeat for a third color if desired. To deselect the highlighted color, press (To remove all colors, press and hold . A confirmation dialog will be displayed; select **Yes**).



## 7 Save the edited copy.

Press to copy the photograph.



## Side-by-Side Comparison

Compare retouched copies to the original photographs. This option is only available if the **OK** button is pressed to display the retouch menu when a copy or original is played back full frame.

### 1 Select a picture.

Select a retouched copy (shown by a  icon) or a photograph that has been retouched in full-frame playback and press **OK**.





### 2 Select Side-by-side comparison.

Highlight **Side-by-side comparison** in the retouch menu and press **OK**.





### 3 Compare the copy with the original.

The source image is displayed on the left, the retouched copy on the right, with the options used to create the copy listed at the top of the display. Press ◀ or ▶ to switch between the source image and the retouched copy. To view the highlighted picture full frame, press and hold the  button. If the copy was created from two images using **Image overlay**, press ▲ or ▼ to view the other source image. If multiple copies exist for the current source image, press ▲ or ▼ to view the other copies. To exit to playback mode, press the  button, or press  to return to playback with the highlighted image displayed.

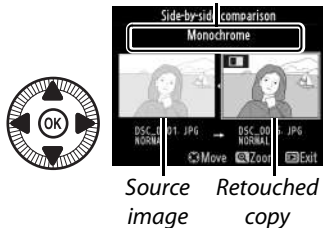
Options used to create copy



#### Side-by-Side comparison

The source image will not be displayed if the copy was created from a photograph that was protected ( 146) or on a locked memory card ( 24).

# Recent Settings/My Menu

To display the recent settings menu, press **MENU** and select the  (recent settings) tab.

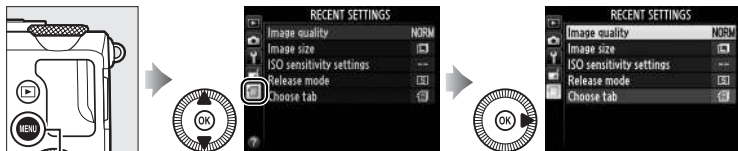

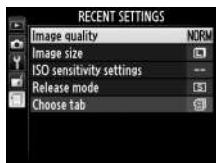

**MENU** button

The recent settings menu lists the 20 most recently used settings, with the most recently-used items first. Press **▲** or **▼** to highlight an option and press **▶** to select.





## Removing Items from the Recent Settings Menu



To remove an item from the recent settings menu, highlight it and press the  button. A confirmation dialog will be displayed; press  again to delete the selected item.



# My Menu



To access a customized menu of up to 20 options selected from the playback, shooting, setup, and retouch menus, select  **My Menu** for  **Recent settings** > **Choose tab**.

## 1 Select Choose tab.



In the recent settings menu () , highlight **Choose tab** and press .



## 2 Select My Menu.

Highlight  **My Menu** and press . The name of the menu will change from “RECENT SETTINGS” to “MY MENU.”



To view recent settings again, select  **Recent settings** for  **My Menu** > **Choose tab**.

## ■ Adding Options to My Menu

### 1 Select Add items.

In My Menu (M), highlight **Add items** and press ►.



### 2 Select a menu.

Highlight the name of the menu containing the option you wish to add and press ►.

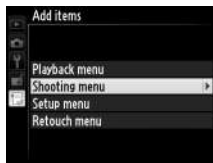

### 3 Select an item.

Highlight the desired menu item and press OK.

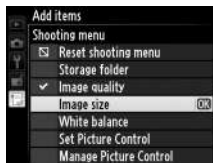

### 4 Position the new item.

Press ▲ or ▼ to move the new item up or down in My Menu. Press OK to add the new item.



### 5 Add more items.

The items currently displayed in My Menu are indicated by a check mark. Items indicated by a ❏ icon can not be selected. Repeat steps 1–4 to select additional items.

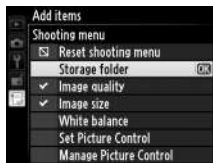

## ■ Deleting Options from My Menu

### 1 Select Remove items.

In My Menu (☰), highlight **Remove items** and press ►.

### 2 Select items.

Highlight items and press ► to select or deselect. Selected items are indicated by a check mark.

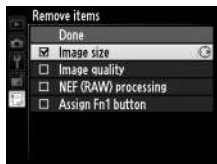



### 3 Delete the selected items.

Highlight **Done** and press ⓄK. A confirmation dialog will be displayed; press ⓄK again to delete the selected items.



#### Deleting Items in My Menu

To delete the item currently highlighted in My Menu, press the  button. A confirmation dialog will be displayed; press  again to remove the selected item from My Menu.



## ■ Reordering Options in My Menu

### 1 Select Rank items.

In My Menu (☰), highlight **Rank items** and press ►.

### 2 Select an item.

Highlight the item you wish to move and press Ⓞ.



### 3 Position the item.

Press ▲ or ▼ to move the item up or down in My Menu and press Ⓞ.

Repeat Steps 2–3 to reposition additional items.



### 4 Exit to My Menu.

Press the **MENU** button to return to My Menu.

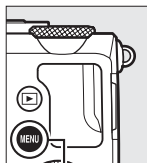

MENU button

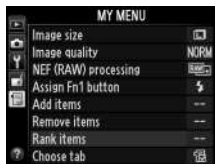

# Technical Notes

Read this chapter for information on compatible accessories, cleaning and storing the camera, and what to do if an error message is displayed or you encounter problems using the camera.

## Optional Flash Units (Speedlights)

Compatible optional flash units can be attached directly to the camera accessory shoe as described below. The accessory shoe is equipped with a safety lock for flash units with a locking pin.

- 1 Remove the accessory shoe cover.

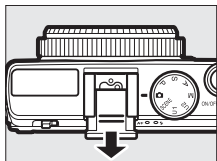

- 2 Mount the flash unit on the accessory shoe.

See the manual provided with the flash unit for details. The built-in flash will not fire when an optional flash unit is attached.

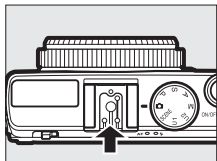

### **✔ Use Only Nikon Flash Accessories**

*Use only Nikon flash units.* Negative voltages or voltages over 250 V applied to the accessory shoe could not only prevent normal operation, but damage the sync circuitry of the camera or flash.

# Compatible Flash Units

The camera can be used with the flash units listed below (for the latest information on compatible flash units, see the websites listed on page 1). For more information, refer to the documentation provided with the flash unit.

| Feature                |         | Flash unit          |                     |        |                     |        |        |
|------------------------|---------|---------------------|---------------------|--------|---------------------|--------|--------|
|                        |         | SB-910 <sup>1</sup> | SB-900 <sup>1</sup> | SB-800 | SB-700 <sup>1</sup> | SB-600 | SB-400 |
| Guide No. <sup>2</sup> | ISO 100 | 34/111              | 34/111              | 38/125 | 28/92               | 30/98  | 21/69  |
|                        | ISO 200 | 48/157              | 48/157              | 53/174 | 39/128              | 42/138 | 30/98  |

- 1 If a color filter is attached to the SB-910, SB-900, or SB-700 when AUTO or  (flash) is selected for white balance, the camera will automatically detect the filter and adjust white balance appropriately.
- 2 m/ft., 20 °C (68 °F), SB-910, SB-900, SB-800, SB-700, and SB-600 at 35 mm zoom head position; SB-910, SB-900, and SB-700 with standard illumination.

The following features are available with compatible flash units:

|                                       |       |  | Compatible flash units |                |        |                |                |
|---------------------------------------|-------|--|------------------------|----------------|--------|----------------|----------------|
|                                       |       |  | SB-900<br>SB-910       | SB-800         | SB-700 | SB-600         | SB-400         |
| Single flash                          | i-TTL | i-TTL balanced fill-flash <sup>1</sup> | ✓                      | ✓              | ✓      | ✓              | ✓              |
|                                       |       | Standard i-TTL flash                   | ✓ <sup>2</sup>         | ✓ <sup>2</sup> | ✓      | ✓ <sup>2</sup> | ✓              |
|                                       | AA    | Auto aperture                          | ✓ <sup>3</sup>         | ✓ <sup>3</sup> | —      | —              | —              |
|                                       | A     | Non-TTL auto                           | ✓ <sup>3</sup>         | ✓ <sup>3</sup> | —      | —              | —              |
|                                       | GN    | Distance-priority manual               | ✓                      | ✓              | ✓      | —              | —              |
|                                       | M     | Manual                                 | ✓                      | ✓              | ✓      | ✓              | ✓ <sup>4</sup> |
|                                       | RPT   | Repeating flash                        | ✓                      | ✓              | —      | —              | —              |
| Flash Color Information Communication |       |  | ✓                      | ✓              | ✓      | ✓              | ✓              |
| FV Lock <sup>5</sup>                  |       |  | ✓                      | ✓              | ✓      | ✓              | ✓              |
| Red-eye reduction                     |       |  | ✓                      | ✓              | ✓      | ✓              | ✓              |
| Camera flash mode selection           |       |  | —                      | —              | —      | —              | ✓              |
| Camera flash unit firmware update     |       |  | ✓                      | —              | ✓      | —              | —              |

1 Not available with spot metering.

2 Can also be selected with flash unit.

3 AA/A mode selection performed on flash unit using custom settings.

4 Can only be selected with camera.

5 Available with i-TTL flash control and when monitor pre-flashes are used in AA and A modes.

### **i-TTL Flash Control**

In i-TTL flash control, the camera adjusts the flash level based on reflections from a series of nearly invisible pre-flashes (monitor pre-flashes) emitted by the flash unit immediately before firing. There are two types of i-TTL flash control: *i-TTL balanced fill-flash*, in which flash output is adjusted for a natural balance between the main subject and ambient background lighting, and *standard i-TTL flash*, in which flash output is adjusted to bright lighting in the frame to a standard level without taking the brightness of the background into account. To use i-TTL flash control with optional flash units other than the SB-400, select i-TTL flash control mode on the flash unit before shooting. When using an SB-700 or SB-400, note that i-TTL balanced fill-flash is activated automatically when matrix or center-weighted metering is selected with the camera, while standard i-TTL is used with spot metering.

### **Optional Flash Units**

Optional flash units enter standby when the camera is turned off; check the flash-ready indicator on the flash unit before shooting. Auto power zoom is supported with SB-910, SB-900, SB-800, SB-700, and SB-600 flash units, but note that a wide panel may be required to eliminate vignetting at ranges under 2 m (6 ft 7 in.). Advanced Wireless Lighting, auto FP high-speed sync, and AF-assist for multi-area AF are not supported.

# Other Accessories

At the time of writing, the following accessories were available for the COOLPIX A.

- **Power Connector EP-5C, AC Adapter EH-5b:** These accessories can be used to power the camera for extended periods (EH-5a and EH-5 AC adapters can also be used). An EP-5C power connector is required to connect the camera to the EH-5b, EH-5a, or EH-5. The power connector and adapters are each sold separately.

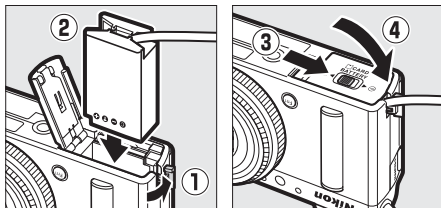

## Power sources

Before closing the battery-chamber/memory card slot cover, be sure the power connector cable is fully inserted in the power connector slot. The cable could be damaged if caught between the cover and the edge of the battery chamber when the cover is closed. After closing the cover, connect the cable to the DC socket on the AC adapter.

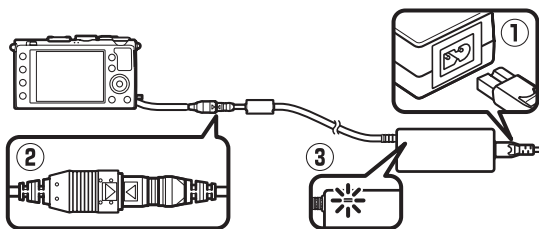

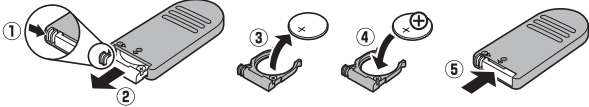
|  |  |
|--|--|
| <b>Viewfinders</b>                       | <ul style="list-style-type: none"> <li>• <b>Optical Viewfinder DF-CP1:</b> Attaches to the camera accessory shoe; covers the angle of view equivalent to that of a 28 mm lens in 35 mm [135] format.</li> </ul>  |
| <b>Software</b>                          | <ul style="list-style-type: none"> <li>• <b>Capture NX 2:</b> A complete photo editing package offering such features as white balance adjustment and color control points.</li> </ul> <p><b>Note:</b> See the websites listed on page 1 for the latest information on supported operating systems.</p>  |
| <b>Remote controls/<br/>remote cords</b> | <ul style="list-style-type: none"> <li>• <b>Wireless Remote Control ML-L3</b> (📖 66): The ML-L3 uses a 3 V CR2025 battery; for safety precautions, see page vii.</li> </ul>  <p>Pressing the battery-chamber latch to the right (1), insert a fingernail into the gap and open the battery chamber (2). Ensure that the battery is inserted in the correct orientation (4).</p> <ul style="list-style-type: none"> <li>• <b>Remote Cord MC-DC2</b></li> </ul> |
| <b>GPS units</b>                         | <p><b>GPS Unit GP-1:</b> The GP-1 attaches to the camera accessory shoe, allowing the current latitude, longitude, altitude, and Coordinated Universal Time (UTC) to be recorded when photographs are taken.</p>   |
| <b>Wireless mobile adapters</b>          | <p><b>Wireless Mobile Adapter WU-1a:</b> Supports two-way communication between the camera and smart devices running the software supplied with the adapter. The WU-1a can not be used with Eye-Fi cards; do not insert Eye-Fi cards while the WU-1a is connected. For more information, see Nikon catalogs or websites or the manual provided with the WU-1a.</p>   |

# Caring for the Camera

## Cleaning

|                    |   |
|--------------------|---|
| <b>Camera body</b> | Use a blower to remove dust and lint, then wipe gently with a soft, dry cloth. After using the camera at the beach or seaside, wipe off sand or salt with a cloth lightly dampened in distilled water and dry thoroughly.<br><b>Important:</b> <i>Dust or other foreign matter inside the camera may cause damage not covered under warranty.</i> |
| <b>Lens</b>        | This glass element is easily damaged. Remove dust and lint with a blower. If using an aerosol blower, keep the can vertical to prevent the discharge of liquid. To remove fingerprints and other stains, apply a small amount of lens cleaner to a soft, dry cloth and clean with care.   |
| <b>Monitor</b>     | Remove dust and lint with a blower. When removing fingerprints and other stains, wipe the surface lightly with a soft, dry cloth or chamois leather. Do not apply pressure, as this could result in damage or malfunction.  |

*Do not use alcohol, thinner, or other volatile chemicals.*

## Storage

When the camera will not be used for an extended period, remove the battery and store it in a cool, dry area with the terminal cover in place. To prevent mold or mildew, store the camera in a dry, well-ventilated area. Do not store your camera with naphtha or camphor moth balls or in locations that:

- are humid (have a humidity of 60% or more) or poorly ventilated
- are next to equipment that produces strong electromagnetic fields, such as televisions or radios
- are exposed to temperatures above 50 °C (122 °F) or below -10 °C (14 °F)

# Caring for the Camera and Battery: Cautions

## Caring for the Camera

**Do not drop:** The product may malfunction if subjected to strong shocks or vibration.

**Keep dry:** This product is not waterproof, and may malfunction if immersed in water or exposed to high levels of humidity. Rusting of the internal mechanism can cause irreparable damage.

**Avoid sudden changes in temperature:** Sudden changes in temperature, such as those that occur when entering or leaving a heated building on a cold day, can cause condensation inside the device. To prevent condensation, place the device in a carrying case or plastic bag before exposing it to sudden changes in temperature.

**Keep away from strong magnetic fields:** Do not use or store this device in the vicinity of equipment that generates strong electromagnetic radiation or magnetic fields. Strong static charges or the magnetic fields produced by equipment such as radio transmitters could interfere with the monitor, damage data stored on the memory card, or affect the product's internal circuitry.

**Do not leave the lens pointed at the sun:** Do not leave the lens pointed at the sun or other strong light source for an extended period. Intense light may cause the image sensor to deteriorate or produce a white blur effect in photographs.

**Turn the product off before removing or disconnecting the power source:** Do not unplug the product or remove the battery while the product is on or while images are being recorded or deleted. Forcibly cutting power in these circumstances could result in loss of data or in damage to product memory or internal circuitry. To prevent an accidental interruption of power, avoid carrying the product from one location to another while the AC adapter is connected.



**Notes on the monitor:** The monitor is constructed with extremely high precision; at least 99.99% of pixels are effective, with no more than 0.01% being missing or defective. Hence while these displays may contain pixels that are always lit (white, red, blue, or green) or always off (black), this is not a malfunction and has no effect on images recorded with the device.

Images in the monitor may be difficult to see in a bright light.

Do not apply pressure to the monitor, as this could cause damage or malfunction. Dust or lint on the monitor can be removed with a blower. Stains can be removed by wiping lightly with a soft cloth or chamois leather. Should the monitor break, care should be taken to avoid injury from broken glass and to prevent liquid crystal from the monitor touching the skin or entering the eyes and mouth.

## **Caring for the Battery**

Batteries may leak or explode if improperly handled. Observe the following precautions when handling batteries:

- Use only batteries approved for use in this equipment.
- Do not expose the battery to flame or excessive heat.
- Keep the battery terminals clean.
- Turn the product off before replacing the battery.
- Remove the battery from the camera or charger when not in use and replace the terminal cover. These devices draw minute amounts of charge even when off and could draw the battery down to the point that it will no longer function. If the battery will not be used for some time, insert it in the camera and run it flat before removing it and storing it in a location with an ambient temperature of 15 °C to 25 °C (59 °F to 77 °F; avoid hot or extremely cold locations). Repeat this process at least once every six months.
- Turning the camera on and off repeatedly when the battery is fully discharged will shorten battery life. Batteries that have been fully discharged must be charged before use.

- The internal temperature of the battery may rise while the battery is in use. Attempting to charge the battery while the internal temperature is elevated will impair battery performance, and the battery may not charge or charge only partially. Wait for the battery to cool before charging.
- Continuing to charge the battery after it is fully charged can impair battery performance.
- A marked drop in the time a fully charged battery retains its charge when used at room temperature indicates that it requires replacement. Purchase a new EN-EL20 battery.
- Charge the battery before use. When taking photographs on important occasions, ready a spare EN-EL20 battery and keep it fully charged. Depending on your location, it may be difficult to purchase replacement batteries on short notice. Note that on cold days, the capacity of batteries tends to decrease. Be sure the battery is fully charged before taking photographs outside in cold weather. Keep a spare battery in a warm place and exchange the two as necessary. Once warmed, a cold battery may recover some of its charge.
- Used batteries are a valuable resource; recycle in accord with local regulations.
- Charge the battery indoors at ambient temperatures of 5 °C–35 °C (41 °F–95 °F). Do not use the battery at ambient temperatures below 0 °C (32 °F) or above 40 °C (104 °F); failure to observe this precaution could damage the battery or impair its performance. Capacity may be reduced and charging times may increase at battery temperatures from 0 °C (32 °F) to 10 °C (50 °F) and from 45 °C (113 °F) to 60 °C (140 °F). The battery will not charge if its temperature is below 0 °C (32 °F) or above 60 °C (140 °F).







## **The Charger**

The supplied charger is for use with EN-EL20 rechargeable Li-ion batteries only. It is intended solely for use in the country of purchase; before visiting other countries, contact your travel agent for information on plug adapters.

# Available Settings

The following table lists the settings that can be adjusted in each mode.

|                                    |  | P                                  | S, A, M        |  |  |  |  |                |                |
|------------------------------------|---|------------------------------------|----------------|---|---|---|---|----------------|----------------|
| Storage folder                     | ✓   | ✓                                  | ✓              | ✓   | ✓   | ✓   | ✓   |                |                |
| Image quality <sup>1,2</sup>       | ✓   | ✓                                  | ✓              | ✓   | ✓   | ✓   | ✓   |                |                |
| Image size <sup>1,2</sup>          | ✓   | ✓                                  | ✓              | ✓   | ✓   | ✓   | ✓   |                |                |
| White balance <sup>1,2</sup>       | —   | ✓                                  | ✓              | —   | —   | —   | —   |                |                |
| Set Picture Control <sup>1,2</sup> | —   | ✓                                  | ✓              | —   | —   | —   | —   |                |                |
| Color space <sup>1</sup>           | ✓   | ✓                                  | ✓              | ✓   | ✓   | ✓   | ✓   |                |                |
| Active D-Lighting <sup>1,2</sup>   | —   | ✓                                  | ✓              | —   | —   | —   | —   |                |                |
| Shooting menu                      | Long exposure NR <sup>1</sup>   | ✓                                  | ✓              | ✓   | ✓   | ✓   | ✓   |                |                |
|                                    | High ISO NR <sup>1</sup>  | ✓                                  | ✓              | ✓   | ✓   | ✓   | ✓   |                |                |
|                                    | ISO sensitivity settings <sup>1,2</sup>   | ✓ <sup>3</sup>                     | ✓              | ✓   | ✓ <sup>3</sup>  | ✓ <sup>3</sup>  | ✓ <sup>3</sup>  | ✓ <sup>3</sup> |                |
|                                    | Release mode <sup>1,2</sup>   | ✓                                  | ✓              | ✓   | ✓   | ✓   | ✓   | ✓              |                |
|                                    | Built-in AF-assist illuminator <sup>1</sup>                                       | ✓                                  | ✓              | ✓   | ✓   | —   | —   | ✓              |                |
|                                    | Exposure comp. for flash <sup>1</sup>   | —                                  | ✓              | ✓   | —   | —   | —   | —              |                |
|                                    | Flash cntrl for built-in flash/Optional flash <sup>1</sup>                        | —                                  | ✓              | ✓   | —   | —   | —   | —              |                |
|                                    | Auto bracketing set <sup>1</sup>  | —                                  | ✓              | ✓   | —   | —   | —   | —              |                |
|                                    | Other settings <sup>2</sup>   | Autofocus mode <sup>1</sup>        | ✓ <sup>4</sup> | ✓   | ✓   | ✓ <sup>4</sup>  | ✓ <sup>4</sup>  | ✓ <sup>4</sup> | ✓ <sup>4</sup> |
|                                    |   | AF-area mode <sup>1</sup>          | —              | ✓   | ✓   | ✓ <sup>4</sup>  | ✓ <sup>4</sup>  | ✓ <sup>4</sup> | ✓ <sup>4</sup> |
|                                    |   | Metering <sup>1</sup>              | —              | ✓   | ✓   | —   | —   | —              | —              |
|                                    |   | Exposure compensation <sup>1</sup> | —              | ✓   | ✓   | —   | —   | —              | —              |
|                                    |   | Auto bracketing                    | —              | ✓   | ✓   | —   | —   | —              | —              |
| Flash mode <sup>1</sup>            |   | ✓ <sup>4</sup>                     | ✓              | ✓   | ✓ <sup>4</sup>  | —   | ✓ <sup>4</sup>  | —              |                |
| Flash compensation <sup>1</sup>    | —   | ✓                                  | ✓              | —   | —   | —   | —   |                |                |

|            |                     | P | S, A,<br>M |  |  |  |  |
|------------|--|---|------------|--|--|---|--|
| Setup menu | Self-timer   | ✓ | ✓          | ✓  | ✓  | ✓   | ✓  |
|            | Auto off timer   | ✓ | ✓          | ✓  | ✓  | ✓   | ✓  |
|            | Image review time  | ✓ | ✓          | ✓  | ✓  | ✓   | ✓  |
|            | Remote on duration (ML-L3)   | ✓ | ✓          | ✓  | ✓  | ✓   | ✓  |
|            | Beep   | ✓ | ✓          | ✓  | ✓  | ✓   | ✓  |
|            | Shutter sound  | ✓ | ✓          | ✓  | ✓  | ✓   | ✓  |
|            | File number sequence   | ✓ | ✓          | ✓  | ✓  | ✓   | ✓  |
|            | MF distance indicator units  | ✓ | ✓          | ✓  | ✓  | ✓   | ✓  |
|            | Reverse indicators   | ✓ | ✓          | ✓  | ✓  | ✓   | ✓  |
|            | Assign Fn1 button  | ✓ | ✓          | ✓  | ✓  | ✓   | ✓  |
|            | Assign  /Fn2 button | ✓ | ✓          | ✓  | ✓  | ✓   | ✓  |
|            | Reverse dial rotation  | ✓ | ✓          | ✓  | ✓  | ✓   | ✓  |
|            | Slot empty release lock  | ✓ | ✓          | ✓  | ✓  | ✓   | ✓  |

- 1 Reset with **Reset shooting menu** (□ 176).
- 2 Reset with two-button reset (□ 121). Two-button reset also resets parameters for Picture Control currently selected with **Set Picture Control**.
- 3 Auto ISO sensitivity control is not available.
- 4 Reset when mode dial is rotated to new setting.

# Troubleshooting

If the camera fails to function as expected, check the list of common problems below before consulting your retailer or Nikon representative.

## Battery/Display

**The camera is on but does not respond:** Wait for recording to end. If the problem persists, turn the camera off. If the camera does not turn off, remove and reinsert the battery or, if you are using an AC adapter, disconnect and reconnect the AC adapter. Note that although any data currently being recorded will be lost, data that have already been recorded will not be affected by removing or disconnecting the power source.

**Display turns off without warning:** Choose longer delays for **Auto off timer** in the setup menu (☐ 189).

## Shooting (All Modes)

**Camera takes time to turn on:** Delete files or folders.

**Shutter-release disabled:**

- Memory card is locked, full, or not inserted (☐ 23, 24).
- Built-in flash is charging.

**No photo taken when remote control shutter-release button is pressed:**

- Replace battery in remote control (☐ 231).
- Built-in flash is charging.
- Time selected for **Remote on duration (ML-L3)** in the setup menu (☐ 189) has elapsed.
- Bright light is interfering with ML-L3 remote control.

**Only one shot taken each time shutter-release button is pressed in continuous shooting mode:** Continuous shooting is not available if built-in flash fires (☐ 65, 115).

**Photos are out of focus:**

- Camera unable to focus using autofocus: use manual focus or focus lock (☐ 31, 74, 79, 80).
- Camera is in manual focus mode: focus manually (☐ 80).



---

**Can not select AF-area mode:** Camera is in  mode (☞ 29).

---

**Image size can not be changed:** An NEF (RAW) option is selected for image quality (☞ 69).

---

**Camera is slow to record photos:** Turn long exposure noise reduction off (☞ 179).

---

**Noise (bright spots, randomly-spaced bright pixels, fog, or lines) appear in photos:**

- Choose lower ISO sensitivity or turn high ISO noise reduction on (☞ 179).
  - Shutter speed is slower than 1 s: use long exposure noise reduction (☞ 179).
  - Turn **Active D-Lighting** off to avoid heightening the effects of noise (☞ 110).
- 

**AF-assist illuminator does not light:**

- The AF-assist illuminator does not light if the subject is brightly lit.
  - The AF-assist illuminator does not light in some autofocus, AF-area, and scene modes.
  - **Off** selected for **Built-in AF-assist illuminator** in the shooting menu (☞ 180).
- 

**Smudges appear in photographs:** Clean lens.

---

**Sound is not recorded with movies:** **Off** is selected for **Movie settings** > **Microphone** (☞ 43).

---

**The brightness of the image in the monitor differs from the final photograph:**

- Center-weighted or spot metering is selected (☞ 85).
  - The camera is in mode M.
  - The subject is too bright or too dark.
  - Active D-Lighting is in effect (☞ 110).
  - The flash is used (☞ 116).
- 

**The monitor is dark:** Increase monitor brightness (☞ 183).

---

**Flicker or banding appears during in the monitor during shooting:** Choose an option for **Flicker reduction** that matches the frequency of the local AC power supply (☞ 184).

---

**Bright bands appear in the monitor:** A flashing sign, flash, or other light source with brief duration was used during shooting.

---

**Menu item can not be selected:** Some options are not available in all modes.

---



# Shooting (P, S, A, M)

---

**Full range of shutter speeds not available:** The flash is in use.

---

**Colors are unnatural:**

- Adjust white balance to match light source (☞ 89).
  - Adjust **Set Picture Control** settings (☞ 99).
- 

**Can not measure white balance:** Subject is too dark or too bright (☞ 96).

---

**Image can not be selected as source for preset white balance:** Image was not created with COOLPIX A (☞ 97).

---

**White balance bracketing unavailable:** NEF (RAW) or NEF+JPEG image quality option selected for image quality (☞ 71).

---

**Effects of Picture Control differ from image to image:** **A** (auto) is selected for sharpening, contrast, or saturation. For consistent results over a series of photos, choose another setting (☞ 104).

---

**Metering can not be changed:** Autoexposure lock is in effect.

---

**Exposure compensation can not be used:** Choose mode P, S, or A (☞ 52).

---

**Noise (reddish areas or other artifacts) appears in long exposures:** Turn long-exposure noise reduction on (☞ 179).

---

## Playback

---

**NEF (RAW) image is not played back:** Photo was taken at image quality of NEF (RAW)+JPEG (☞ 69).

---

**Can not view pictures recorded with other cameras:** Pictures recorded with other makes of camera may not be displayed correctly.

---

**Some pictures are not displayed during playback or message is displayed stating that no images are available for playback:** Select **All** for **Playback folder** (☞ 173).

---

**“Tall” (portrait) orientation photos are displayed in “wide” (landscape) orientation:**

- Select **On** for **Rotate tall** (☞ 174).
  - Photo was taken with **Off** selected for **Auto image rotation** (☞ 187).
  - Photo is displayed in image review (☞ 173).
  - Camera was pointed up or down when photo was taken (☞ 187).
-

---

**Can not delete picture:**

- Picture is protected: remove protection (☞ 146).
- Memory card is locked (☞ 24).

---

**Can not retouch picture:** Photo can not be further edited with this camera (☞ 199).

---

**Can not change print order:**

- Memory card is full: delete pictures (☞ 27, 148).
- Memory card is locked (☞ 24).

---

**Can not select photo for printing:** Photo is in NEF (RAW) format. Create JPEG copy using **NEF (RAW) processing** or transfer to computer and print using supplied software or Capture NX 2 (☞ 156, 209).

---

**Picture is not displayed on TV:** HDMI cable is not correctly connected (☞ 169).

---

**Camera does not respond to remote control for HDMI-CEC television:**

- Select **On** for **HDMI > Device control** in the setup menu (☞ 171).
- Adjust HDMI-CEC settings for the television as described in documentation provided with the device.

---

**Can not transfer photos to computer:** OS not compatible with camera or transfer software. Use card reader to copy photos to computer (☞ 156).

---

**Photos are not displayed in Capture NX 2:** Update to latest version (☞ 231).

---

**Computer displays NEF (RAW) images differently from camera:** Third-party software does not display effects of Picture Controls or Active D-Lighting. Use ViewNX 2 (supplied) or optional Nikon software such as Capture NX 2 (available separately).

---

## **Miscellaneous**

---

**Date of recording is not correct:** Set camera clock (☞ 25, 185).

---

**Menu item can not be selected:** Some options are not available at certain combinations of settings or when no memory card is inserted (☞ 23, 197, 236).

# Error Messages

This section lists the indicators and error messages that appear in the camera displays.

| Indicator  | Solution  |  |
|--|---|---|
| <b>Shutter release disabled.<br/>Recharge battery.</b>   | Low battery. Turn camera off, remove battery, and insert charged battery.   | 27  |
| <b>Initialization error. Turn camera off and then on again.</b>  | Turn camera off, remove and reinsert battery, and turn camera on.   | 2   |
| <b>(Exposure indicator and shutter speed or aperture display flash)</b>  | If subject is too bright, reduce ISO sensitivity or choose a faster shutter speed (mode S) or smaller aperture (higher f-number; mode A). If subject is too dark, increase ISO sensitivity, use the flash, or choose slower shutter speed (mode S) or larger aperture (lower f-number; mode A). | —   |
| <b>A shutter speed of Bulb is not available in shutter-priority auto mode. Choose a different shutter speed or select manual mode.</b> | Change shutter speed or select mode M.  | 54,<br>56   |
| <b>Card is full. It may be possible to take more pictures at a lower image quality or size.</b>  | Adjust image quality and size for smaller file sizes.   | 69,<br>72   |
|  | Delete photographs.   | 148   |
|  | Insert new memory card.   | 23  |
| <b>Error. Turn camera off and then on again.</b>   | Turn camera off, remove and reinsert battery, and turn camera on.   | 2   |
| <b>No memory card.</b>   | Turn camera off and confirm that card is correctly inserted.  | 23  |



| Indicator   | Solution   |  |
|---|--|---|
| <b>This memory card cannot be used. Card may be damaged. Insert another card.</b>                                     | Use Nikon-approved card.   | 251   |
|   | Check that contacts are clean. If card is damaged, contact retailer or Nikon-authorized service representative.  | —   |
|   | Delete files or insert new memory card after copying important images to computer or other device.   | 23, 148   |
|   | Eye-Fi card is still emitting wireless signal after <b>Disable</b> has been selected for <b>Eye-Fi upload</b> . To terminate wireless transmission, turn the camera off and remove the card. | 195   |
| <b>Memory card is locked. Slide lock to "write" position.</b><br><b>Not available if Eye-Fi card is locked.</b>       | Slide card write-protect switch to "write" position.   | 24  |
| <b>This card is not formatted. Format the card.</b>   | Format memory card or insert new memory card.  | 23  |
| <b>Clock has been reset.</b>  | Set camera clock.  | 25  |
| <b>Failed to update flash unit firmware. Flash cannot be used. Contact a Nikon-authorized service representative.</b> | Contact a Nikon-authorized service representative.   | —   |
| <b>Folder contains no images.</b>   | Select folder containing images from <b>Playback folder</b> menu or insert memory card containing images.  | 173   |
| <b>Cannot display this file.</b>  | File has been created or modified using computer or different make of camera, or file is corrupt.  | —   |
| <b>Cannot select this file.</b>   | Images created with other devices can not be retouched.  | 199   |
| <b>Lens error.</b>  | Turn the camera off and then on again. If the problem persists, contact a Nikon-authorized service representative.   | 2   |
| <b>Check printer.</b>   | Check printer. To resume, select <b>Continue</b> (if available).   | 159*  |



| Indicator                | Solution  |  |
|--------------------------|---|---|
| <b>Check paper.</b>      | Insert paper of correct size and select <b>Continue.</b>  | 159*  |
| <b>Paper jam.</b>        | Clear jam and select <b>Continue.</b>                     | 159*  |
| <b>Out of paper.</b>     | Insert paper of selected size and select <b>Continue.</b> | 159*  |
| <b>Check ink supply.</b> | Check ink. To resume, select <b>Continue.</b>             | 159*  |
| <b>Out of ink.</b>       | Replace ink and select <b>Continue.</b>                   | 159*  |

\* See printer manual for more information.



# Specifications

## ■ Nikon COOLPIX A Digital Camera

|                                       |   |
|---------------------------------------|---|
| <b>Type</b>                           | Compact digital camera  |
| <b>Number of effective pixels</b>     | 16.2 million  |
| <b>Image sensor</b>                   | 23.6 × 15.6 mm Nikon DX format CMOS; approx. 16.93 million total pixels   |
| <b>Lens</b>                           | NIKKOR lens   |
| <b>Focal length</b>                   | 18.5 mm (angle of view equivalent to that of 28 mm lens in 35mm [135] format)   |
| <b>f/-number</b>                      | f/2.8   |
| <b>Construction</b>                   | 7 elements in 5 groups  |
| <b>Autofocus (AF)</b>                 | Contrast-detect AF  |
| <b>Focus range</b>                    | Approx. 50 cm (1 ft 8 in.) – ∞; approx. 10 cm (4 in.) – ∞ in macro autofocus mode. All distances measured from center of front surface of lens.   |
| <b>Focus-area selection</b>           | Face-priority, normal area, wide area, and subject-tracking AF  |
| <b>Monitor</b>                        | 7.5 cm (3-in.), approx. 921k-dot, TFT LCD with a wide viewing angle, anti-reflection coating, and 9-level brightness adjustment   |
| <b>Frame coverage (shooting mode)</b> | Approx. 100% horizontal and vertical (compared to actual picture)   |
| <b>Frame coverage (playback mode)</b> | Approx. 100% horizontal and vertical (compared to actual picture)   |
| <b>Storage</b>                        |   |
| <b>Media</b>                          | SD/SDHC/SDXC memory cards   |
| <b>File system</b>                    | DCF, Exif 2.3, DPOF, and PictBridge compliant   |
| <b>File formats</b>                   | <ul style="list-style-type: none"><li>• Still pictures: JPEG, RAW (NEF; a proprietary Nikon format)</li><li>• Movies: MOV (Video: H.264/MPEG-4 AVC, Audio: Linear stereo PCM)</li></ul> |

|   |  |
|---|--|
| <b>Image size (pixels)</b>                          | L (4928 × 3264), M (3696 × 2448), S (2464 × 1632)  |
| <b>ISO sensitivity (Recommended Exposure Index)</b> | ISO 100 – 3200; can be adjusted using <b>ISO sensitivity</b> to 6400, Hi 0.3 (ISO 8000 equivalent), Hi 0.7 (ISO 10000 equivalent), Hi 1 (ISO 12800 equivalent), and Hi 2 (ISO 25600 equivalent)                            |
| <b>Exposure</b>                                     |  |
| <b>Metering mode</b>                                | Matrix, center-weighted, or spot   |
| <b>Exposure control</b>                             | Programmed auto with flexible program, shutter priority auto, aperture-priority auto, manual with exposure bracketing and exposure compensation ( $\pm 5$ EV [photos] or $\pm 2$ EV [movies] in steps of $\frac{1}{3}$ EV) |
| <b>Shutter</b>                                      | Mechanical and CMOS electronic shutter   |
| <b>Speed</b>  | $\frac{1}{2000}$ – 30 s; bulb and time available in mode M (time requires optional ML-L3 remote control)   |
| <b>Aperture</b>                                     | Electronically-controlled 7-blade iris diaphragm   |
| <b>Range</b>  | 19 steps of $\frac{1}{3}$ EV   |
| <b>Self-timer</b>                                   | Choose from durations of approximately 20, 10, 5, and 2 seconds  |
| <b>Built-in flash</b>                               |  |
| <b>Range</b>  | Approx. 0.5 – 11.5 m/1 ft 8 in. – 37 ft (mode  , auto ISO)  |
| <b>Flash control</b>                                | TTL auto flash with monitor pre-flashes; manual flash control available; Guide Number approx. 6/21, or 6/22 when fired in manual mode at full power (ISO 100, m/ft, 23 °C/73.4 °F)   |
| <b>Flash compensation</b>                           | -3 – +1 EV in steps of $\frac{1}{3}$ EV  |
| <b>Accessory shoe</b>                               | ISO 518 hot-shoe with sync and data contacts and safety lock   |
| <b>Interface</b>                                    | Hi-Speed USB   |
| <b>Data transfer protocol</b>                       | PTP  |
| <b>HDMI output</b>                                  | Auto, 480p, 576p, 720p, 1080i  |
| <b>I/O terminals</b>                                | <ul style="list-style-type: none"> <li>• Digital connector (USB)</li> <li>• HDMI mini connector (Type C)</li> <li>• Accessory terminal</li> </ul>  |

|  |   |
|--|---|
| <b>Supported languages</b>   | Arabic, Chinese (Simplified and Traditional), Czech, Danish, Dutch, English, Finnish, French, German, Indonesian, Italian, Japanese, Korean, Norwegian, Polish, European Portuguese, Russian, Spanish, Swedish, Thai, Turkish |
| <b>Power sources</b>   | <ul style="list-style-type: none"> <li>• One rechargeable Li-ion EN-EL20 battery (supplied)</li> <li>• AC Adapter EH-5b; requires Power Connector EP-5C (available separately)</li> </ul>                                     |
| <b>Battery life<sup>1</sup></b>                                    |   |
| <b>Still pictures</b>  | Approx. 230 shots with EN-EL20  |
| <b>Movie recording (endurance for movie recording)<sup>2</sup></b> | Approx. 1 hour and 10 minutes with EN-EL20  |
| <b>Tripod socket</b>   | 1/4 (ISO 1222)  |
| <b>Dimensions (W × H × D)</b>                                      | Approx. 111.0 × 64.3 × 40.3 mm (4.4 × 2.6 × 1.6 in.), excluding projections   |
| <b>Weight</b>  | Approx. 299 g (10.6 oz), including battery and memory card  |
| <b>Operating environment</b>                                       |   |
| <b>Temperature</b>   | 0 °C – 40 °C (32 °F – 104 °F)   |
| <b>Humidity</b>  | 85% or less (no condensation)   |

- Unless otherwise stated, all figures assume a fully-charged battery and an ambient temperature of 23 ±3 °C (73.4 ±5.4 °F) as specified by the Camera and Imaging Products Association (CIPA).
- 1 Figures based on the Camera and Imaging Products Association (CIPA) standards for measuring the endurance of camera batteries. Performance for still pictures measured under the following test conditions: image quality set to JPEG normal, image size set to  **Large** (4928 × 3264), and flash fired with every other shot. Movie recording time assumes movie settings of  **1920 × 1080; 30p** or  **1920 × 1080; 25p**. Performance varies with the condition of the battery, temperature, the interval between shots, and the length of time menus are displayed.
  - 2 Individual movies can be up to 20 minutes or 29 minutes 59 seconds long; recording may end before these limits are reached if the camera temperature rises.

## ■ Rechargeable Li-ion Battery EN-EL20

|                        |   |
|------------------------|---|
| Type                   | Rechargeable lithium-ion battery                    |
| Rated capacity         | DC 7.2 V, 1020 mAh                                  |
| Operating temperature  | 0 °C – 40 °C (32 °F – 104 °F)                       |
| Dimensions (W × H × D) | Approx. 30.7 × 50.0 × 14.0 mm (1.2 × 2.0 × 0.6 in.) |
| Weight                 | Approx. 41 g (1.4 oz), excluding terminal cover     |

## ■ Battery Charger MH-27

|                                |   |
|--------------------------------|---|
| Rated input                    | AC 100–240 V, 50–60 Hz, 0.2 A   |
| Rated output                   | DC 8.4 V, 0.6 A   |
| Supported rechargeable battery | Rechargeable Li-ion Battery EN-EL20   |
| Charging time                  | Approx. 2 hours at an ambient temperature of 25 °C (77 °F) when no charge remains |
| Operating temperature          | 0 °C – 40 °C (32 °F – 104 °F)   |
| Dimensions (W × H × D)         | Approx. 67.0 × 28.0 × 94.0 mm (2.6 × 1.1 × 3.7 in.), excluding plug adapter       |
| Weight                         | Approx. 83 g (2.9 oz), excluding plug adapter                                     |

### Specifications

Nikon reserves the right to change the specifications of the hardware and software described in this manual at any time and without prior notice. Nikon will not be held liable for damages that may result from any mistakes that this manual may contain.

## ■ ■ **Supported Standards**

- **DCF:** The Design Rule for Camera File Systems (DCF) is a standard widely used in the digital camera industry to ensure compatibility among different makes of camera.
- **DPOF:** Digital Print Order Format (DPOF) is an industry-wide standard that allows pictures to be printed from print orders stored on the memory card.
- **Exif version 2.3:** The COOLPIX A supports Exif (Exchangeable Image File Format for Digital Still Cameras) version 2.3, a standard in which information stored with photographs is used for optimal color reproduction when the images are output on Exif-compliant printers.
- **PictBridge:** A standard developed through cooperation with the digital camera and printer industries, allowing photographs to be output directly to a printer without first transferring them to a computer.

## ■ ■ **AVC Patent Portfolio License**

THIS PRODUCT IS LICENSED UNDER THE AVC PATENT PORTFOLIO LICENSE FOR THE PERSONAL AND NON-COMMERCIAL USE OF A CONSUMER TO (i) ENCODE VIDEO IN COMPLIANCE WITH THE AVC STANDARD (“AVC VIDEO”) AND/OR (ii) DECODE AVC VIDEO THAT WAS ENCODED BY A CONSUMER ENGAGED IN A PERSONAL AND NON-COMMERCIAL ACTIVITY AND/OR WAS OBTAINED FROM A VIDEO PROVIDER LICENSED TO PROVIDE AVC VIDEO. NO LICENSE IS GRANTED OR SHALL BE IMPLIED FOR ANY OTHER USE. ADDITIONAL INFORMATION MAY BE OBTAINED FROM MPEG LA, L.L.C. SEE <http://www.mpegla.com>

### **Trademark Information**

Macintosh, Mac OS, and QuickTime are registered trademarks of Apple Inc. in the United States and/or other countries. Microsoft, Windows, and Windows Vista are either registered trademarks, or trademarks of Microsoft Corporation in the United States and/or other countries. PictBridge logo is a trademark. The SD, SDHC, and SDXC logos are trademarks of the SD-3C, LLC. HDMI, the HDMI logo and High-Definition Multimedia Interface are trademarks or registered trademarks of HDMI Licensing LLC.

#### **HDMI**

All other trade names mentioned in this manual or the other documentation provided with your Nikon product are trademarks or registered trademarks of their respective holders.

# Approved Memory Cards

The following SD memory cards have been tested and approved for use in the COOLPIX A. Cards with class 6 or faster write speeds are recommended for movie recording. Recording may end unexpectedly when cards with slower write speeds are used.

|                  | SD memory cards   | SDHC memory cards <sup>2</sup> | SDXC memory cards <sup>3</sup> |
|------------------|-------------------|--------------------------------|--------------------------------|
| <b>SanDisk</b>   | 2 GB <sup>1</sup> | 4 GB, 8 GB, 16 GB, 32 GB       | 64 GB, 128 GB                  |
| <b>Toshiba</b>   |                   |                                | 64 GB                          |
| <b>Panasonic</b> |                   |                                |                                |
| <b>Lexar</b>     | —                 |                                | 64 GB, 128 GB                  |

- 1 Check that any card readers or other devices with which the card will be used support 2 GB cards.
- 2 Check that any card readers or other devices with which the card will be used are SDHC-compliant.
- 3 Check that any card readers or other devices with which the card will be used are SDXC-compliant.



Other cards have not been tested. For more details on the above cards, please contact the manufacturer.

# Memory Card Capacity

The following table shows the number of pictures that can be stored on a 4 GB memory card at different image quality (☐ 69) and size (☐ 72) settings. All figures are approximate; results will vary with the card type, camera settings, and the scene recorded.

| Image quality | Image size | No. of image (4GB) |
|---------------|------------|--------------------|
| NEF (RAW)     | —          | 160                |
| JPEG fine     | Large      | 410                |
|               | Medium     | 720                |
|               | Small      | 1600               |
| JPEG normal   | Large      | 810                |
|               | Medium     | 1400               |
|               | Small      | 3000               |
| JPEG basic    | Large      | 1600               |
|               | Medium     | 2700               |
|               | Small      | 5500               |





































The following table shows the movie footage that can be stored on a 4 GB memory card at different combinations of movie settings (☐ 43). All figures are approximate; results will vary with the card type, camera settings, and the scene recorded.

|   | Frame size/frame rate |            | Footage (★ High quality/Normal)*<br>(4GB) |
|---|-----------------------|------------|---|
|   | Frame size (pixels)   | Frame rate |   |
| $\frac{1080}{60} \frac{P^*}{60} / \frac{1080}{30} \frac{P}{30}$ | 1920 × 1080           | 30p        | 20 minutes/35 minutes                     |
| $\frac{1080}{25} \frac{P^*}{25} / \frac{1080}{25} \frac{P}{25}$ | 1920 × 1080           | 25p        |   |
| $\frac{1080}{24} \frac{P^*}{24} / \frac{1080}{24} \frac{P}{24}$ | 1920 × 1080           | 24p        |   |
| $\frac{720}{60} \frac{P^*}{60} / \frac{720}{30} \frac{P}{30}$   | 1280 × 720            | 30p        | 35 minutes/55 minutes                     |
| $\frac{720}{25} \frac{P^*}{25} / \frac{720}{25} \frac{P}{25}$   | 1280 × 720            | 25p        |   |
| $\frac{720}{24} \frac{P^*}{24} / \frac{720}{24} \frac{P}{24}$   | 1280 × 720            | 24p        | 45 minutes/1 hour 10 minutes              |

\* Individual movies can not exceed 20 minutes or 29 minutes 59 seconds in length (☐ 43). The camera shows the amount of the maximum recording time available for the current movie, but note that the camera may turn off automatically to prevent overheating before this length is reached.

# Index

## Symbols

-  (Auto mode) .....9, 29
- SCENE (Scene mode) .....9, 35
-  (Portrait) .....35
-  (Landscape) .....35
-  (Child) .....35
-  (Sports) .....36
-  (Close up) .....36
-  (Night portrait) .....36
-  (Night landscape) .....36
-  (Party/Indoor) .....36
-  (Beach/Snow) .....36
-  (Sunset) .....36
-  (Dusk/Dawn) .....36
-  (Pet portrait) .....36
-  (Candlelight) .....36
-  (Blossom) .....36
-  (Autumn colors) .....36
-  (Food) .....37
-  (Silhouette) .....37
-  (High key) .....37
-  (Low key) .....37
- P (Programmed auto) .....53
- S (Shutter-priority auto) .....54
- A (Aperture-priority auto) .....55
- M (Manual) .....56
- U1/U2 .....60
-  (Single frame) .....63
-  (Continuous) .....63
-  (Self-timer) .....66
-  2s (Delayed remote (ML-L3)) .....66
-  (Quick-response remote (ML-L3)) .....66
-  (Movie) .....38
-  (Face-priority AF) .....76
-  (Wide-area AF) .....76
-  (Normal-area AF) .....76
-  (Subject-tracking AF) .....76
-  (Matrix metering) .....85
-  (Center-weighted metering) .....85
-  (Spot metering) .....85
- AUTO** (auto flash) ..... 113
-  (red-eye reduction) ..... 113
- SLOW** (slow sync) ..... 113
- REAR** (rear-curtain sync) ..... 113
-  (Help) ..... 12
-  (“Beep” indicator) ..... 190
- r (Memory buffer) .....65
- Fn1 .....193
- ISO** (Fn2) .....194
- 
- ## A
- AC adapter ..... 230
- Accessories ..... 230
- Accessory shoe ..... 226
- Accessory terminal ..... 231
- Accessory terminal accessories ..... 231
- Active D-Lighting ..... 110
- Add items (My Menu) ..... 223
- Adobe RGB ..... 178
- AF ..... 74–79
- AF-area mode ..... 76
- AF-assist ..... 180
- AF-F ..... 75
- AF-S ..... 75
- Aperture ..... 55, 56
- Aperture-priority auto ..... 55
- Auto (White balance) ..... 89
- Auto bracketing ..... 123, 181
- Auto flash ..... 114
- Auto image rotation ..... 187
- Auto off Timer ..... 189
- Autofocus ..... 75–79
- Autofocus mode ..... 75
- Auto-servo AF ..... 75
- Available settings ..... 236
- 
- ## B
- Battery ..... 20, 21, 248
- Beep ..... 190
- Bit rate ..... 43
- Black-and-white ..... 203



|   |          |
|---|----------|
| Blue intensifier (Filter effects) ..... | 204      |
| Border (PictBridge) .....               | 161      |
| Bracketing.....                         | 123, 181 |
| Brightness.....                         | 103      |
| Built-in AF-assist illuminator .....    | 180      |
| Built-in flash .....                    | 112      |
| Bulb .....                              | 58       |
| Burst.....                              | 63       |

## C

|                                     |         |
|-------------------------------------|---------|
| Calendar playback .....             | 142     |
| Capture NX 2.....                   | 231     |
| Center-weighted metering.....       | 85      |
| Charger .....                       | 20, 248 |
| Choose start/end point.....         | 47      |
| Clock.....                          | 185     |
| Cloudy (White balance) .....        | 90      |
| Color balance.....                  | 205     |
| Color outline .....                 | 214     |
| Color sketch .....                  | 214     |
| Color Space .....                   | 178     |
| Color temp.....                     | 89      |
| Color temperature .....             | 91      |
| Command dial.....                   | 10      |
| Continuous (Release mode).....      | 63      |
| Cross screen (Filter effects) ..... | 204     |
| Cyanotype.....                      | 203     |

## D

|                                      |               |
|--------------------------------------|---------------|
| Date and time.....                   | 185           |
| Date format .....                    | 185           |
| Daylight saving time .....           | 185           |
| DCF .....                            | 249           |
| Delayed remote (ML-L3) .....         | 63, 66        |
| Delete .....                         | 34, 148       |
| Delete all images.....               | 150           |
| Delete current image.....            | 148           |
| Delete selected images.....          | 150           |
| Device control (HDMI) .....          | 171           |
| Digital Print Order Format .....     | 163, 166, 249 |
| Direct sunlight (White balance)..... | 89            |
| D-Lighting.....                      | 200           |
| DPOF.....                            | 163, 166, 249 |
| DPOF print order .....               | 166           |

## E

|                             |        |
|-----------------------------|--------|
| Edit movie .....            | 197    |
| Exif version 2.3.....       | 249    |
| Exposure .....              | 85, 87 |
| Exposure compensation ..... | 87     |
| Exposure indicator .....    | 57     |
| Eye-Fi upload.....          | 195    |

## F

|                                       |          |
|---------------------------------------|----------|
| Face-priority AF .....                | 76       |
| File information.....                 | 134      |
| File number sequence .....            | 191      |
| Filter effects .....                  | 203      |
| Filter effects (Picture control)..... | 103, 105 |
| Fine-tuning white balance .....       | 92       |
| Firmware version .....                | 196      |
| Fisheye.....                          | 213      |
| Flash .....                           | 112, 226 |
| Flash (White balance).....            | 90       |
| Flash cntrl for built-in flash.....   | 181      |
| Flash compensation .....              | 116      |
| Flash ready indicator .....           | 119      |
| Flexible program.....                 | 53       |
| Flicker reduction .....               | 184      |
| Fluorescent (White balance).....      | 89       |
| f-number.....                         | 55       |
| Focus .....                           | 74–80    |
| Focus area.....                       | 76       |
| Focus lock.....                       | 79       |
| Focus ring .....                      | 80       |
| Focus-mode selector .....             | 74, 80   |
| Format memory card .....              | 23, 183  |
| Frame size/frame rate .....           | 43       |
| Full-frame playback .....             | 132      |
| Full-time-servo AF .....              | 75       |

## G

|  |               |
|--|---------------|
| GPS.....                                 | 130, 138, 231 |
| GPS data.....                            | 138           |
| GPS unit.....                            | 130, 231      |
| Green intensifier (Filter effects) ..... | 204           |



|  |                  |
|--|------------------|
| <b>H</b>   |                  |
| Help .....   | 12               |
| Hi (Sensitivity) .....                                 | 82               |
| High ISO NR .....                                      | 179              |
| Highlights .....                                       | 135              |
| Histogram .....  | 135, 136         |
| <b>I</b>   |                  |
| Image comment.....                                     | 186              |
| Image overlay .....                                    | 206              |
| Image quality .....                                    | 69               |
| Image review.....                                      | 173              |
| Image size.....  | 72               |
| Incandescent (White balance) .....                     | 89               |
| In-focus indicator.....                                | 79               |
| Information display.....                               | 7                |
| Infrared receiver.....                                 | 3, 67            |
| Interval timer shooting.....                           | 127              |
| ISO sensitivity.....                                   | 81               |
| ISO sensitivity settings.....                          | 82               |
| i-TTL.....   | 181              |
| <b>J</b>   |                  |
| JPEG.....  | 69               |
| JPEG basic.....  | 69               |
| JPEG fine .....  | 69               |
| JPEG normal .....                                      | 69               |
| <b>L</b>   |                  |
| Landscape (Set Picture Control).....                   | 99               |
| Language.....  | 186              |
| Large (Image size) .....                               | 72               |
| Long exposure NR.....                                  | 179              |
| <b>M</b>   |                  |
| Manage Picture Control .....                           | 106              |
| Manual.....  | 56               |
| Manual focus.....                                      | 80               |
| Matrix metering .....                                  | 85               |
| Maximum sensitivity .....                              | 84               |
| Medium (Image size).....                               | 72               |
| Memory buffer.....                                     | 65               |
| Memory card .....                                      | 23, 183, 251     |
| Metering .....   | 85               |
| Microphone.....  | 43               |
| Miniature effect .....                                 | 216              |
| Minimum shutter speed .....                            | 84               |
| Mode dial .....  | 9                |
| Monitor .....  | 5, 132           |
| Monitor brightness.....                                | 183              |
| Monitor pre-flash .....                                | 119              |
| Monochrome.....  | 203              |
| Monochrome (Set Picture Control).....                  | 99               |
| Movie quality.....                                     | 43               |
| Movie settings.....                                    | 43               |
| Movies.....  | 38               |
| My Menu .....  | 222              |
| <b>N</b>   |                  |
| NEF .....  | 69               |
| NEF (RAW) .....  | 69, 209          |
| NEF (RAW) processing .....                             | 209              |
| Neutral (Set Picture Control) .....                    | 99               |
| Nikon Transfer 2.....                                  | 157              |
| Normal-area AF .....                                   | 76               |
| <b>O</b>   |                  |
| Optional flash .....                                   | 181, 226         |
| Output resolution (HDMI) .....                         | 171              |
| Overview data .....                                    | 139              |
| <b>P</b>   |                  |
| Page size (PictBridge) .....                           | 161              |
| Perspective control.....                               | 215              |
| Photo information .....                                | 134              |
| PictBridge.....  | 159, 249         |
| Picture Control Utility .....                          | 109              |
| Picture Controls .....                                 | 99               |
| Playback.....  | 33, 45, 132, 169 |
| Playback display options.....                          | 173              |
| Playback folder.....                                   | 173              |
| Playback menu.....                                     | 172              |
| Playback zoom .....                                    | 144              |
| Portrait (Set Picture Control).....                    | 99               |
| Power connector .....                                  | 230              |
| Preset manual (White balance) .....                    | 94               |
| Press the shutter-release button all the way down..... | 31               |



|  |          |                                |          |
|--|----------|--------------------------------|----------|
| Press the shutter-release button halfway | 30, 31   | Shutter-priority auto          | 54       |
| Print (DPOF)                             | 163      | Shutter-release button         | 31, 79   |
| Print select                             | 163      | Side-by-side comparison        | 219      |
| Printing                                 | 159      | Single frame (Release mode)    | 63       |
| Programmed auto                          | 53       | Single-servo AF                | 75       |
| Protecting photographs                   | 146      | Size                           | 43, 72   |
| <b>Q</b>                                 |          | Skylight (Filter effects)      | 203      |
| Quick retouch                            | 213      | Slide Show                     | 174      |
| Quick-response (ML-L3)                   | 63       | Slot empty release lock        | 195      |
| <b>R</b>                                 |          | Slow sync                      | 114      |
| Rank items (My Menu)                     | 225      | Small (Image size)             | 72       |
| Recent settings                          | 221      | Soft (Filter effects)          | 204      |
| Red intensifier (Filter effects)         | 204      | Speedlight                     | 226      |
| Red-eye correction                       | 201      | Spot metering                  | 85       |
| Red-eye reduction                        | 113      | sRGB                           | 178      |
| Release mode                             | 63       | Standard (Set Picture Control) | 99       |
| Remote control                           | 66, 231  | Start printing (PictBridge)    | 162, 165 |
| Remote cord                              | 58, 231  | Storage Folder                 | 177      |
| Remote on duration (ML-L3)               | 189      | Straighten                     | 213      |
| Remove items (My Menu)                   | 224      | Subject-tracking AF            | 76       |
| Reset                                    | 121, 176 | <b>T</b>                       |          |
| Reset shooting menu                      | 176      | Television                     | 169      |
| Reset user settings                      | 62       | Thumbnail playback             | 140      |
| Resize                                   | 211      | Time                           | 58       |
| Retouch menu                             | 197      | Time stamp (PictBridge)        | 162      |
| Reverse dial rotation                    | 194      | Time zone                      | 185      |
| Reverse indicators                       | 192      | Time zone and date             | 185      |
| RGB Histogram                            | 135      | Timer                          | 66, 127  |
| Rotate tall                              | 174      | Toning                         | 103, 105 |
| <b>S</b>                                 |          | Trim                           | 202      |
| Save selected frame                      | 50       | Trimming movies                | 47       |
| Save user settings                       | 60       | <b>U</b>                       |          |
| Scene mode                               | 35       | USB cable                      | 156, 159 |
| Selective color                          | 217      | Use GPS to set camera clock    | 130      |
| Self-timer                               | 63, 188  | UTC                            | 130, 138 |
| Sensitivity                              | 127      | <b>V</b>                       |          |
| Sepia                                    | 203      | ViewNX 2                       | 154      |
| Setup menu                               | 182      | Virtual horizon                | 17       |
| Shade (White balance)                    | 90       | Vivid (Set Picture Control)    | 99       |
| Shooting data                            | 137      | Volume                         | 46       |
| Shooting menu                            | 176      |                                |          |

## W

---

|                                    |     |
|------------------------------------|-----|
| Warm filter (Filter effects) ..... | 203 |
| WB .....                           | 89  |
| White balance .....                | 89  |
| Wide-area AF .....                 | 76  |



No reproduction in any form of this manual, in whole or in part (except for brief quotation in critical articles or reviews), may be made without written authorization from NIKON CORPORATION.