

Refrigerator
TOP MOUNTED FREEZER SERIES

USER MANUAL

**HD-113FN
SERIES**

Warning notices: Before using this product, please read this manual carefully and keep it for future reference. The design and specifications are subject to change without prior notice for product improvement. Consult with your dealer or manufacturer for details.

The diagram above is just for reference. Please take the appearance of the actual product as the standard.

LANGUAGES

EN	English
AR	Arabic

THANK YOU LETTER

Thank you for choosing Midea! Before using your new Midea product, please read this manual thoroughly to ensure that you know how to operate the features and functions that your new appliance offers in a safe way.

CONTENTS

THANK YOU LETTER	01
SPECIFICATIONS	02
PRODUCT OVERVIEW	03
PRODUCT INSTALLATION	04
OPERATION INSTRUCTIONS	08
CLEANING AND MAINTENANCE	11
TROUBLESHOOTING	12

SPECIFICATIONS

Product model	HD-113FN
Fresh Food Storage Compartment Volume	62L
Frozen Food Storage Volume	25L
Rated Voltage	220V-240V-
Frequency	50Hz
Rated Current	0.6A
Overall Dimension (H x W x D)	837x470x492mm

PRODUCT OVERVIEW

Names of components

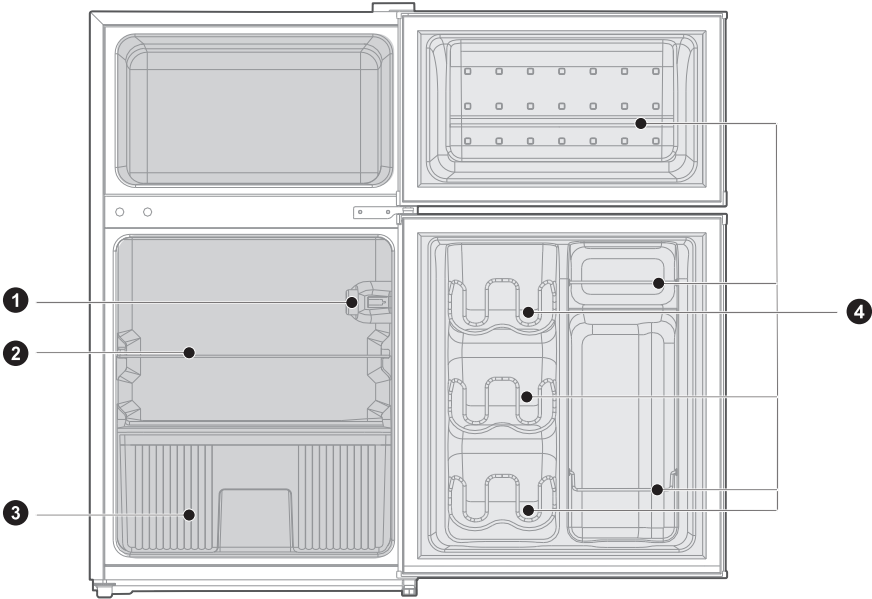

EN

- | | | | |
|---|------------------------------|---|---------------------------|
| 1 | Temperature-control assembly | 3 | Fruits and vegetables box |
| 2 | Shelf | 4 | Fence |

ATTENTION

The picture above is only for reference. The actual configuration will depend on the physical product or statement by the distributor

PRODUCT INSTALLATION

Install Instruction

For refrigerating appliances with climate class

- Depending on the climate class, This refrigerating appliance is intended to be used at ambient temperatures range as specified following table.
- The climate class can be found on the rating plate. The product may not operate properly at temperatures outside of the specific range.
- You can find the climate class on the product label.

Effective temperature range

- The product is designed to operate normally in the temperature range specified by its class rating.

Class	Symbol	Ambient temperature range °C	
		IEC 62552 (ISO 15502)	ISO 8561
Extended temperate	SN	+ 10 to + 32	+ 10 to + 32
Temperate	N	+ 16 to + 32	+ 16 to + 32
Subtropical	ST	+ 16 to + 38	+ 18 to + 38
Tropical	T	+ 16 to + 43	+ 18 to + 43

EN

Dimensions and Clearances

- Too small of a distance from adjacent items may result in the degradation of freezing capability and increased electricity costs. Allow over 100 mm of clearance from each adjacent wall when installing the appliance.

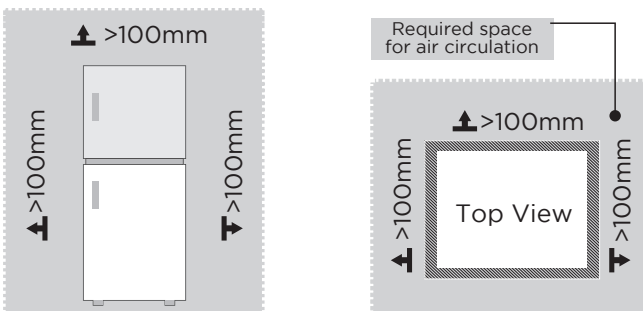

ATTENTION

The picture above is only for reference. The actual configuration will depend on the physical product or statement by the distributor

Space requirement diagram (when the door is open and when the door is closed)

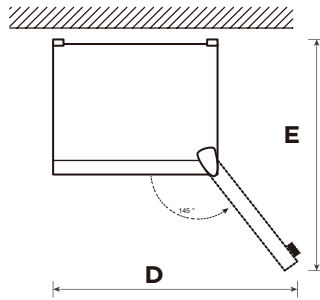
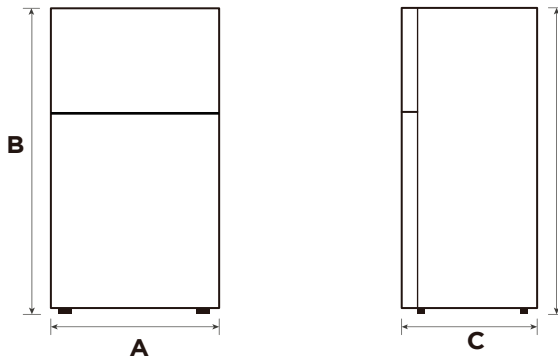



EN

Width	Overall Height	Depth	Width doors open 145°	Depth doors open 145°
A	B	C	D	E
470	837	492	913	678

Notice: All dimensions in mm

Door right-left change

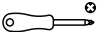
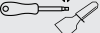
List of tools to be provided by the user

	Cross screwdriver
	Putty knife Thin-blade screwdriver
	5/16" socket spanner
	Masking tape

1. Remove all food from the inner door liner. Fix the door by tapes.
2. Dismantle top hinge cover, top hinge and hole cap of the other side.
3. Remove freezer chamber door as well as middle hinge and hole cap of the other side.
4. Remove refrigerating chamber door and dismantle bottom hinge and adjustable foot.
5. Exchange the installation position of bottom hinge and adjustable foot, then fix them respectively. Remove the hinge sleeve pipe of the refrigerating chamber door, and install it on the other side. Remove the hinge sleeve pipe of the freezing chamber door and install it on the other side.
6. Place refrigerating chamber door on bottom hinge then fix the middle hinge on left side and insert the hole caps on right side.
7. Place freezer chamber door on middle hinge then fix the top hinge, top hinge cover on left side and insert hole caps on right side.

EN

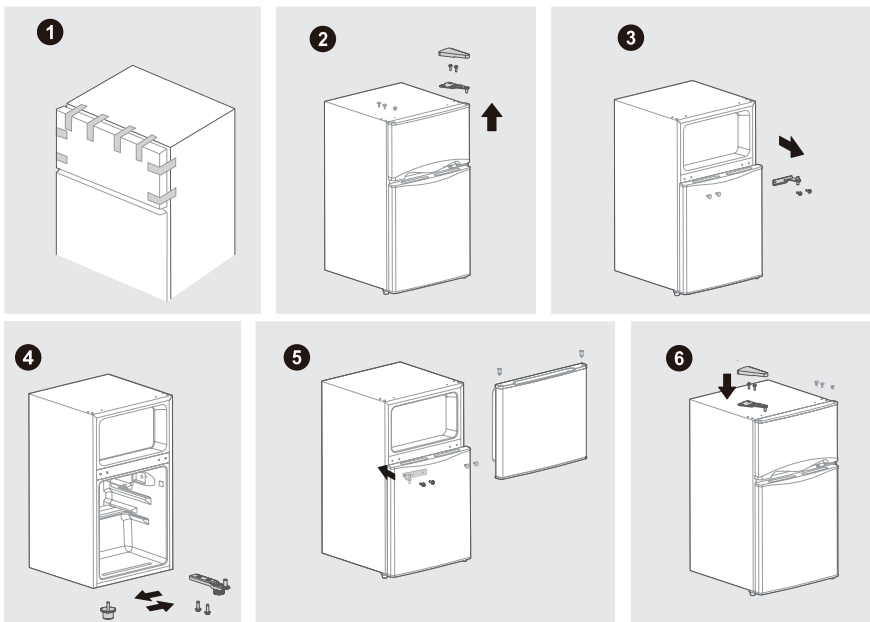



Leveling feet

To avoid vibration, the unit must be leveled.

If required, adjust the leveling screws to compensate for the uneven floor.

The front should be slightly higher than the rear to aid in door closing.

Leveling screws can be turned easily by tipping the cabinet slightly.

Turn the leveling screws counterclockwise  to raise the unit, clockwise  to lower it.

Connecting the appliance

After installing the appliance, connect the power plug into a socket outlet.

ATTENTION

After connecting the power supply cord (or plug) to the outlet, wait 2 or 3 hours before you put food into the appliance. If you add food before the appliance has cooled completely, your food may spoil.

Tips for energy saving

- Do not place the appliance near cookers, radiators or other heat sources. If the ambient temperature is high, the compressor will run more frequently and for longer, resulting in increased energy consumption.
- Ensure that there is sufficient ventilation at the base of the appliance, on the sides of the appliance and at the back of the appliance. Never cover ventilation openings.
- Please also observe the spacing dimensions in the chapter “Installation”.
- The arrangement of drawers, shelves and racks as shown in the illustration offers the most efficient use of energy and should therefore be retained as far as possible. All drawers and shelves should remain in the appliance to keep the temperature stable and save energy.
- An evenly filled refrigerator/freezer compartment contributes to optimal energy use. Therefore, avoid empty or half-empty compartments.
- Allow warm food to cool before placing it in the refrigerator/freezer. Food that has already cooled down increases energy efficiency.
- Open the door only as briefly as necessary to minimise cold loss. Opening the door briefly and closing it properly reduces energy consumption.
- The door seals of your appliance must be perfectly intact so that the doors close properly and energy consumption is not increased unnecessarily.

OPERATION INSTRUCTIONS

Control panel

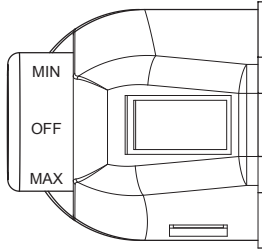

- Turn the temperature control knob to MAX, the internal temperature of the refrigerator becomes lower.
- Turn the temperature control knob to MIN, the internal temperature of the refrigerator becomes higher.
- NOTE: Please adjusting and using between “MAX” and “MIN”.
- Recommended gear: Mid-range

EN

ATTENTION

The actual control panel may differ from model to model.

Changing the Light(optional)

Replacement of incandescent lamps:

- Disconnecting the power supply before carrying out the bulb replacement ,Hold and remove the light bulb cover.
- Dismantle the old bulb by unscrewing it counterclockwise.replace by a new bulb (Max. 15W) by screwing it clockwise, and make sure it is fixed in the bulb holder tightly.
- Reassemble the light cover and re-connect your Fridge to the power supply.

ATTENTION

Any replacement or maintenance of the LED lamps is intended to be made by the manufacturer, its service agent or similar qualified person.

Tips on storing food

Freezer compartment

- The freezer is designated for the storage of food frozen at very low temperature, long-term storage of frozen food, and for the production of ice.
- Only use the shelves in the door of the freezer to store frozen food, not for storing hot food designated for freezing.
- Do not put fresh and frozen food next to each other. The frozen food may thaw.
- When freezing fresh food (such as meat, fish or chopped meat), cut them into parts that can be used at the same time.
- Storing frozen food: instructions are usually stated on the packages, which must be followed. If there is no information on the packaging, food should not be stored for longer than three months from the date of purchase.
- When purchasing frozen food, make sure that it was frozen at a suitable temperature and that the packaging is not damaged.
- Frozen food should be kept in suitable packages to retain the quality and should be returned to the freezer compartment as soon as possible.
- If a package of frozen food shows moisture or abnormal bulging, it is probable that it was stored at the wrong temperature and the content is spoiled.
- The storage period for frozen food depends on the room temperature, the thermostat setting, the frequency of opening the door of the freezer, the type of food and the time of transporting the product from the shop to the household. Always follow the instructions printed on the packaging and never exceed the maximum storage time stated on the package.

Cooling compartment

- To reduce moisture and subsequent ice build-up, never put liquid into the refrigerator in unsealed containers. Frost tends to concentrate in the coolest parts of the evaporator. Storing uncovered liquids results in a more frequent need for defrosting.
- Never put warm foods in the refrigerator. These should first cool down at room temperature and then be placed so as to ensure adequate air circulation in the refrigerator.
- Foods or food containers should not touch the back wall of the refrigerator because they could freeze to the wall. Do not keep regularly opening the door of the refrigerator.
- Meat and clean fish (packed in a package or plastic foil) can be placed in the refrigerator, which can be used in 1-2 days.
- Fruit and vegetables without packaging can be placed in the part designated for fresh fruit and vegetables.

Recommended Temperature

The optimal temperature setting for food storage:

- Fridge: 4 °C , Freezer: -18 °C

ATTENTION

The optimal temperature setting of each compartment depends on the ambient temperature. Above optimal temperature is based on the ambient temperature of 25 °C.



make yourself at home



www.midea.com

© Midea 2022 all rights reserved