

Portable Air Conditioner



SmartHome

Download the app
& activate product



USER MANUAL

MPX0812CWURU
MPX1011CWURU



Warning notices: Before using this product, please read this manual carefully and keep it for future reference.

The design and specifications are subject to change without prior notice for product improvement. Consult with your dealer or the manufacturer for details.

CONTENTS

Safety Precautions	3
Before You Get Started	13
Installation Instructions	15
Operating Instructions	23
Cleaning & Maintenance	26
Troubleshooting Tips	28
Remote Control and App Instructions	29
Warranty.....	47

Read This Manual

Inside you'll find many helpful hints on how to use and maintain your air conditioner properly. Just a little preventive care on your part can save you a great deal of time and money over the life of your air conditioner. You'll find many answers to common problems in the troubleshooting tips - you should be able to fix most of them quickly before calling service. These instructions may not cover every possible condition of use, so common sense and attention to safety is required when installing, operating and maintaining this product.

CAUTION

- For support, please call the Service Center at 1-855-204-5313.
- This appliance is not intended for use by persons (including children) with reduced physical, sensory or mental capabilities or lack of experience and knowledge, unless they have been given supervision or instruction concerning use of the appliance by a person responsible for their safety.
- Children should be supervised to ensure that they do not play with the air conditioner.
- The appliance shall be installed in accordance with national wiring regulations.
- Do not operate your air conditioner in a humid room such as a bathroom or laundry room.

SAFETY PRECAUTIONS

Must read the warning message.

Read Safety Precautions Before Operation and Installation

To prevent death or injury to the user or other people and property damage, the following instructions must be followed.

Incorrect operation due to ignoring of instructions may cause death, harm or damage.

Explanation of Symbols



WARNING

This symbol indicates the possibility of personal injury or loss of life.



CAUTION

This symbol indicates the possibility of property damage or serious consequences.

Electronic Work



WARNING:

BEFORE PERFORMING ANY ELECTRICAL OR WIRING WORK, TURN OFF THE MAIN POWER TO THE SYSTEM.

Electronic Type

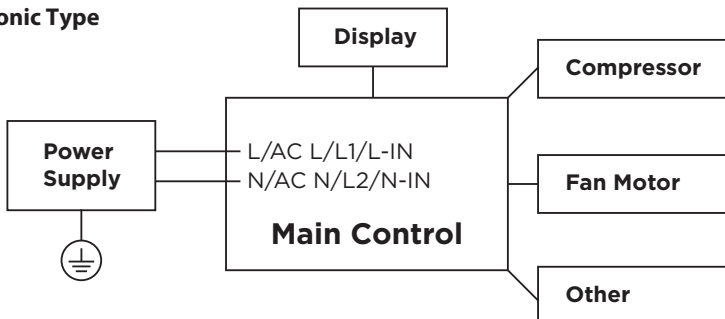

NOTICE:

Please strictly follow the wiring label attached to the machine for all wiring connections. The wiring diagram may vary for different units. Please refer to the wiring diagram on the machine you have purchased. The above wiring diagram is a simplified version for preliminary illustration purposes only.

Operation of Current Device

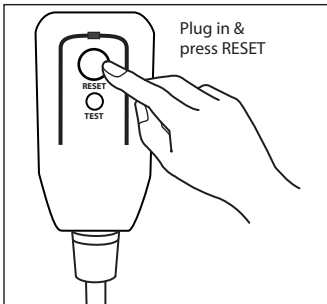

The power supply cord contains a measurement current device that senses damage to the power cord.

Test your power supply cord as follows:

1. Plug in the air conditioner.
2. The power supply cord will have TWO buttons on the plug head. Press the TEST button. You will notice a click as the RESET button pops out.
3. Press the RESET Button. You will notice a click as the button engages.
4. The power supply cord is now supplying electricity to the unit. (On some products this is also indicated by a light on the plug head.)

NOTICE

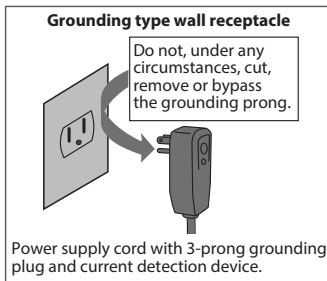

The power supply cord with this air conditioner contains a current detection device designed to reduce the risk of fire.

In the event that the power supply cord is damaged, it can not be repaired. It must be replaced with a cord from the manufacturer.

NOTICE

- Do not use this device to turn the unit on or off.
- Always make sure the RESET button is pushed in for correct operation.
- The power supply must be replaced if it fails to reset when either the TEST button is pushed or it can not be reset. Please contact Customer Service.



WARNING

- Installation must be performed according to the installation instructions. Improper installation can cause water leakage, electrical shock, or fire.
- Use only the included accessories and parts, and specified tools for the installation. Using nonstandard parts can cause water leakage, electrical shock, fire, and injury or property damage.
- Make sure that the outlet you are using is grounded and has the appropriate voltage. The power cord is equipped with a three-prong grounding plug to protect against shock. Voltage information can be found on the nameplate of the unit.
- Your unit must be used in a properly grounded wall receptacle. If the wall receptacle you intend to use is not adequately grounded or protected by a time delay fuse or circuit breaker (the fuse or circuit breaker needed is determined by the maximum current of the unit. The maximum current is indicated on the nameplate located on unit), have a qualified electrician install the proper receptacle.
- Do not touch the unit with wet or damp hands or when barefoot.
- If the air conditioner is knocked over during use, turn off the unit and unplug it from the main power supply immediately. Visually inspect the unit to ensure there is no damage. If you suspect the unit has been damaged, contact a technician or customer service for assistance.
- In a thunderstorm, the power must be cut off to avoid damage to the machine due to lightning.
- Your air conditioner should be used in such a way that it is protected from moisture. e.g. condensation, splashed water, etc. Do not place or store your air conditioner where it can fall or be pulled into water or any other liquid. Unplug immediately if it occurs.
- Install the unit on a flat, sturdy surface. Failure to do so could result in damage or excessive noise and vibration.
- The unit must be kept free from obstruction to ensure proper function and to mitigate safety hazards.
- Do not modify the length of the power cord or use an extension cord to power the unit.
- Do not share a single outlet with other electrical appliances. Improper power supply can cause fire or electrical shock.
- Do not install your air conditioner in a wet room such as a bathroom or laundry room. Too much exposure to water can cause electrical components to short circuit.
- Do not install the unit in a location that may be exposed to combustible gas, as this could cause fire.
- The unit has wheels to facilitate moving. Make sure not to use the wheels on thick carpet or to roll over objects, as this could cause tipping.
- Do not operate a unit that it has been dropped or damaged.
- The appliance with electric heater shall have at least 1 meter of space from combustible materials.
- All wiring must be performed strictly in accordance with the wiring diagram located inside of the unit.
- The unit's circuit board(PCB) is designed with a fuse to provide overcurrent protection. The specifications of the fuse are printed on the circuit board, such as: T 3.15A/250V, etc.
- When the water drainage function is not in use, keep the upper and the lower drain plug firmly attached to the unit to get rid of choking. When the drain plug is not in use, store it carefully to prevent children from choking.



CAUTION

- This appliance is not intended for use by persons (including children) with reduced physical, sensory or mental capabilities or lack of experience and knowledge, unless they have been given supervision or instruction concerning use of the appliance by a person responsible for their safety. Children should be supervised to ensure that they do not play with the appliance. Children must be supervised around the unit at all times.
- If the supply cord is damaged, it must be replaced by the manufacturer, its service agent or similarly qualified persons in order to avoid a hazard.
- Do not use this product for functions other than those described in this instruction manual.
- Before cleaning, turn off the power and unplug the unit.
- Disconnect the power if strange sounds, smells, or smoke comes from it.
- Do not press the buttons on the control panel with anything other than your fingers.
- Do not remove any fixed covers. Never use this appliance if it is not working properly, or if it has been dropped or damaged.
- Do not operate or stop the unit by inserting or pulling out the power cord plug.
- Do not use hazardous chemicals to clean or come into contact with the unit. Do not use the unit in the presence of inflammable substances or vapour such as alcohol, insecticides, petrol, etc.
- Prior to cleaning or other maintenance, the appliance must be disconnected from the supply mains.
- Do not remove any fixed covers. Never use this appliance if it is not working properly, or if it has been dropped or damaged.
- Do not run cord under carpeting. Do not cover cord with throw rugs, runners, or similar coverings. Do not route cord under furniture or appliances. Arrange cord away from traffic area and where it will not be tripped over.
- Do not operate unit with a damaged cord, plug, power fuse or circuit breaker. Discard unit or return to an authorized service facility for examination and/or repair.
- To reduce the risk of fire or electric shock, do not use this fan with any solid-state speed control device.
- The appliance shall be installed in accordance with national wiring regulations.
- Contact an authorized service technician for repair or maintenance of this unit.
- Do not cover or obstruct the inlet or outlet grilles.
- Always transport your air conditioner in a vertical position and stand on a stable, level surface during use.
- Always contact a qualified person to carry out repairs. If the damaged power supply cord must be replaced with a new power supply cord obtained from the product manufacturer and not repaired.
- Hold the plug by the head of the power plug when taking it out.
- Turn off the product when not in use.



CAUTION:

Risk of fire
Flammable materials

IMPORTANT NOTE: Read this manual carefully before installing or operating your new appliance unit. Make sure to save this manual for future reference.

Explanation of symbols displayed on the unit



CAUTION

This symbol shows that the operating manual should be read carefully.



CAUTION

This symbol shows that a service personnel should be handling this equipment with reference to the installation manual.



CAUTION

This symbol shows that information is available in the operating manual or installation manual.

WARNING:

- Servicing shall only be performed as recommended by the equipment manufacturer. Maintenance and repair requiring the assistance of other skilled personnel shall be carried out under the supervision of the person competent in the use of flammable refrigerants.
- DO NOT modify the length of the power cord or use an extension cord to power the unit.
- DO NOT share a single outlet with other electrical appliances. Improper power supply can cause fire or electrical shock.
- Please follow the instructions carefully to handle, install, clear, and service the appliance to avoid any damage or hazard.

Flammable Refrigerant R32 is used within appliance.

- When maintaining or disposing of the appliance, the refrigerant (R32) shall be recovered properly, shall not discharge to air directly.
- Compliance with national gas regulations shall be observed.
- Keep ventilation openings clear of obstruction.
- The appliance shall be stored so as to prevent mechanical damage from occurring.
- The appliance shall be stored in a well-ventilated area where the room size corresponds to the room area as specified for operation.
- Any person who is involved with working on or breaking into a refrigerant circuit should hold a current valid certificate from an industry-accredited assessment authority, which authorises their competence to handle refrigerants safely in accordance with an industry recognised assessment specification. All training shall follow the ANNEX HH requirements of UL 60335-2-40 4th Edition.

Examples for such working procedures are:

- breaking into the refrigerating circuit;
- opening of sealed components;
- opening of ventilated enclosures.

- No open fire or device like switch which may generate spark/arcing shall be around appliance to avoid causing ignition of the flammable refrigerant used. Please follow the instructions carefully to store or maintain the appliance to prevent mechanical damage from occurring.
- Do not use means to accelerate the defrosting process or to clean, other than those recommended by the manufacturer.
- The appliance shall be stored in a room without continuously operating ignition sources (for example: open flames, an operating gas appliance) and ignition sources or (for example: an operating electric heater) close to the appliance.
- Do not pierce or burn.
- Be aware that the refrigerants may not contain an odour.

1. Transport of equipment containing flammable refrigerants

See transport regulations.

2. Marking of equipment using signs

See local regulations.

3. Disposal of equipment using flammable refrigerants

See national regulations.

4. Storage of equipment/appliances

The storage of the appliance should be in accordance with the applicable regulations or instructions, whichever is more stringent.

5. Storage of packed (unsold) equipment

Storage package protection should be constructed such that mechanical damage to the equipment inside the package will not cause a leak of the refrigerant charge. The maximum number of pieces of equipment permitted to be stored together will be determined by local regulations.

6. Information on servicing

1) Checks to the area

Prior to beginning work on systems containing flammable refrigerants, safety checks are necessary to ensure that the risk of ignition is minimised. For repair to the refrigerating system, the following precautions shall be complied with prior to conducting work on the system.

2) Work procedure

Work shall be undertaken under a controlled procedure so as to minimise the risk of a flammable gas or vapour being present while the work is being performed.

3) General work area

All maintenance staff and others working in the local area shall be instructed on the nature of work being carried out. Work in confined spaces shall be avoided. The area around the workspace shall be sectioned off. Ensure that the conditions within the area have been made safe by control of flammable material.

4) Checking for presence of refrigerant

The area shall be checked with an appropriate refrigerating detector prior to and during work, to ensure the technician is aware of potentially flammable atmospheres. Ensure that the leak detection equipment being used is suitable for use with flammable refrigerants, i.e. non-sparking, adequately sealed or intrinsically safe.

5) Presence of fire extinguisher

If any hot work is to be conducted on the refrigeration equipment or any associated parts, appropriate fire extinguishing equipment shall be available to hand. Have a dry powder or CO2 fire extinguisher adjacent to the charging area.

6) No ignition sources

No person carrying out work in relation to a refrigerating system which involves exposing any pipe work that contains or has contained flammable refrigerant shall use any sources of ignition in such a manner that it may lead to the risk of fire or explosion. All possible ignition sources, including cigarette smoking, should be kept sufficiently far away from the site of installation, repairing, removing and disposal, during which flammable refrigerant can possibly be released to the surrounding space. Prior to work taking place, the area around the equipment is to be surveyed to make sure that there are no flammable hazards or ignition risks. No Smoking signs shall be displayed.

7) Ventilated area

Ensure that the area is in the open or that it is adequately ventilated before breaking into the system or conducting any hot work. A degree of ventilation shall continue during the period that the work is carried out. The ventilation should safely disperse any released refrigerant and preferably expel it externally into the atmosphere.

8) Checks to the refrigerating equipment

Where electrical components are being changed, they shall be fit for the purpose and to the correct specifications. At all times, the manufacturer's maintenance and service guidelines shall be followed. If in doubt, consult the manufacturer's technical department for assistance. The following checks shall be applied to installations using flammable refrigerants: the actual refrigerant charge is in accordance with the room size within which the refrigerant containing parts are installed; the ventilation machinery and outlets are operating adequately and are not obstructed; if an indirect refrigerating circuit is being used, the secondary circuit shall be checked for the presence of refrigerant; marking to the equipment continues to be visible and legible.

Markings and signs that are illegible shall be corrected; and refrigerating pipe or components are installed in a position where they are unlikely to be exposed to any substance which may corrode refrigerant containing components, unless the components are constructed of materials which are inherently resistant to being corroded or are suitably protected against being so corroded.

9) Checks to electrical devices

Repair and maintenance to electrical components shall include initial safety checks and component inspection procedures. If a fault exists that could compromise safety, then no electrical supply shall be connected to the circuit until it is satisfactorily dealt with. If the fault cannot be corrected immediately but it is necessary to continue operation, an adequate temporary solution shall be used.

This shall be reported to the owner of the equipment so all parties are advised.

Initial safety checks shall include: That capacitors are discharged: this shall be done in a safe manner to avoid possibility of sparking; that there no live electrical components and wiring are exposed while charging, recovering or purging the system; that there is continuity of earth bonding.

7. Sealed electrical components shall be replaced.

8. Intrinsically safe components must be replaced.

9. Cabling

Check that cabling will not be subject to wear, corrosion, excessive pressure, vibration, sharp edges or any other adverse environmental effects. The check shall also take into account the effects of aging or continual vibration from sources such as compressors or fans.

10. Detection of flammable refrigerants

Under no circumstances shall potential sources of ignition be used in the searching for or detection of refrigerant leaks. A halide torch (or any other detector using a naked flame) shall not be used.

The following leak detection methods are deemed acceptable for systems containing flammable refrigerants. Electronic leak detectors shall be used to detect flammable refrigerants, but the sensitivity may not be adequate, or may need re-calibration. (Detection equipment shall be calibrated in a refrigerant-free area.) Ensure that the detector is not a potential source of ignition and is suitable for the refrigerant used. Leak detection equipment shall be set at a percentage of the LFL of the refrigerant and shall be calibrated to the refrigerant employed and the appropriate percentage of gas (25 % maximum) is confirmed. Leak detection fluids are suitable for use with most refrigerants but the use of detergents containing chlorine shall be avoided as the chlorine may react with the refrigerant and corrode the copper pipe-work. If a leak is suspected, all naked flames shall be removed/ extinguished. If a leakage of refrigerant is found which requires brazing, all of the refrigerant shall be recovered from the system, or isolated (by means of shut off valves) in a part of the system remote from the leak. Removal of refrigerant shall be according to Removal and evacuation.

11. Removal and evacuation

When breaking into the refrigerant circuit to make repairs—or for any other purpose - conventional procedures shall be used. However, for flammable refrigerants it is important that best practice be followed, since flammability is a consideration. The following procedure shall be adhered to:

- Safely remove refrigerant following local and national regulations;
- Evacuate;
- Purge the circuit with inert gas (optional for A2L);
- Evacuate (optional for A2L);
- Continuously flush or purge with inert gas when using flame to open circuit; and
- Open the circuit.

The refrigerant charge shall be recovered into the correct recovery cylinders if venting is not allowed by local and national codes. For appliances containing flammable refrigerants, the system shall be purged with oxygen-free nitrogen to render the appliance safe for flammable refrigerants. This process might need to be repeated several times.

Compressed air or oxygen shall not be used for purging refrigerant systems.

For appliances containing flammable refrigerants, refrigerants purging shall be achieved by breaking the vacuum in the system with oxygen-free nitrogen and continuing to fill until the working pressure is achieved, then venting to atmosphere, and finally pulling down to a vacuum (optional for A2L). This process shall be repeated until no refrigerant is within the system (optional for A2L). When the final oxygen-free nitrogen charge is used, the system shall be vented down to atmospheric pressure to enable work to take place. The outlet for the vacuum pump shall not be close to any potential ignition sources, and ventilation shall be available.

12. Charging procedures

In addition to conventional charging procedures, the following requirements shall be followed. Ensure that contamination of different refrigerants does not occur when using charging equipment. Hoses or lines shall be as short as possible to minimise the amount of refrigerant contained in them. Cylinders shall be kept in an appropriate position according to the instructions. Ensure that the refrigeration system is earthed prior to charging the system with refrigerant. Label the system when charging is complete (if not already). Extreme care shall be taken not to overfill the refrigeration system. Prior to recharging the system it shall be pressure tested with OFN. The system shall be leak tested on completion of charging but prior to commissioning. A follow up leak test shall be carried out prior to leaving the site.

13. Decommissioning

Before carrying out this procedure, it is essential that the technician is completely familiar with the equipment and all its detail. It is recommended good practice that all refrigerants are recovered safely. Prior to the task being carried out, an oil and refrigerant sample shall be taken in case analysis is required prior to re-use of reclaimed refrigerant. It is essential that electrical power is available before the task is commenced.

- a) Become familiar with the equipment and its operation.
- b) Isolate system electrically.
- c) Before attempting the procedure ensure that: Mechanical handling equipment is available, if required, for handling refrigerant cylinders; all personal protective equipment is available and being used correctly; the recovery process is supervised at all times by a competent person; recovery equipment and cylinders conform to the appropriate standards.
- d) Pump down refrigerant system, if possible.
- e) If a vacuum is not possible, make a manifold so that refrigerant can be removed from various parts of the system.
- f) Make sure that cylinder is situated on the scales before recovery takes place.
- g) Start the recovery machine and operate in accordance with manufacturer's instructions.
- h) Do not overfill cylinders. (No more than 80 % volume liquid charge).
- i) Do not exceed the maximum working pressure of the cylinder, even temporarily.
- j) When the cylinders have been filled correctly and the process completed, make sure that the cylinders and the equipment are removed from site promptly and all isolation valves on the equipment are closed off.
- k) Recovered refrigerant shall not be charged into another refrigeration system unless it has been cleaned and checked.

14. Labelling

Equipment shall be labelled stating that it has been de-commissioned and emptied of refrigerant. The label shall be dated and signed. Ensure that there are labels on the equipment stating the equipment contains flammable refrigerant.

15. Recovery

When removing refrigerant from a system, either for servicing or decommissioning, it is recommended good practice that all refrigerants are removed safely. When transferring refrigerant into cylinders, ensure that only appropriate refrigerant recovery cylinders are employed. Ensure that the correct number of cylinders for holding the total system charge is available. All cylinders to be used are designated for the recovered refrigerant and labelled for that refrigerant (i.e. special cylinders for the recovery of refrigerant). Cylinders shall be complete with pressure relief valve and associated shut-off valves in good working order. Empty recovery cylinders are evacuated and, if possible, cooled before recovery occurs. The recovery equipment shall be in good working order with a set of instructions concerning the equipment that is at hand and shall be suitable for the recovery of the flammable refrigerant. If in doubt, the manufacturer should be consulted. In addition, a set of calibrated weighing scales shall be available and in good working order. Hoses shall be complete with leak-free disconnect couplings and in good condition.

The recovered refrigerant shall be processed according to local legislation in the correct recovery cylinder, and the relevant waste transfer note arranged. Do not mix refrigerants in recovery units and especially not in cylinders. If compressors or compressor oils are to be removed, ensure that they have been evacuated to an acceptable level to make certain that flammable refrigerant does not remain within the lubricant. The compressor body shall not be heated by an open flame or other ignition sources to accelerate this process. When oil is drained from a system, it shall be carried out safely.

BEFORE YOU GET STARTED

Preparations Before Installation



The installation must be carried out in strict accordance with the instructions in this manual.



We recommend doing this with a helper.



Installing your AC should take about 30 minutes.



We're here if you need us. Please contact 1-855-204-5313

Ambient Temperature Range For Unit Operating:

Mode	Temperature Range
Cool	16~35°C (60~95°F)
Dry	13~35°C (55~95°F)

Know your Portable Air Conditioner

Energy Rating Information

The energy rating and noise information for this unit is based on the standard installation using an un-extended exhaust duct without window slider adapter (as shown in the Installation section of this manual) and with the unit operating on COOL MODE and HIGH FAN SPEED.

NOTICE

We recommend operating the unit at room temperature (below 95°F), since there is a risk that the unit with a 3-meter extended exhaust duct would not work at a temperature above 95°F under some extreme conditions, such as if the lower air intake is blocked by 50%.

How to Stay Cool with a New Portable Air Conditioner (For the models comply with the requirements of Department Of Energy in US)

Because of a new federal test procedure for Portable Air Conditioners, you may notice that the cooling capacity claims on portable air conditioner packaging are significantly lower than that of models produced prior to 2017. This is due to changes in the test procedure, not to the portable air conditioners themselves.

What Should I Look For First When Purchasing A Portable Air Conditioner?

The right air conditioner helps you cool a room efficiently. An undersized unit won't cool adequately while one that's too large will not remove enough humidity, leaving the air feeling damp. To find the proper air conditioner, determine the square footage of the room you want to cool by multiplying the room length by its width. You also need to know the air conditioner's BTU (British Thermal Unit) rating, which indicates the amount of heat it can remove from a room. A higher number means more cooling power for a larger room. (Be sure you are comparing only newer models to each other. Older models may appear to have a higher capacity, but are actually the same). Be sure to "size up" if your portable air conditioner will be placed in a very sunny room, in a kitchen, or in a room with high ceilings. After you've found the right cooling capacity for your room, you can look at other features.

Why Newer Products Have Lower Cooling Capacity Than Older Models

Federal regulations require manufacturers to calculate cooling capacity based on a specific test procedure, which was changed just this year. Models manufactured before 2017 were tested under a different procedure and cooling capacity was measured differently in prior year's models. So, while the BTUs may be lower now, the actual cooling capacity of the air conditioners has not changed.

What is SACC?

SACC is the representative value of Seasonally Adjusted Cooling Capacity, in Btu/h, as determined in accordance with the DOE test procedure at title 10 Code of Federal Regulations (CFR) 430, subpart B, appendix CC and applicable sampling plans.

INSTALLATION INSTRUCTIONS

Product Installation Location

Your Installation Location Should Meet The Following Requirements:

- Make sure that you install your unit on an even surface to minimize noise and vibration.
- The unit must be installed near a grounded plug, and the Collection Tray Drain (found on the back of the unit) must be accessible.
- The unit should be located at least 30cm (12") from the nearest wall to ensure proper air conditioning. The air outlet of the unit should be at least 50cm (19.7") away from obstacles.
- DO NOT cover the Intakes, Outlets or Remote Signal Receptor of the unit, as this could cause damage to the unit.

Unit Installation Location Restricted Space Requirements

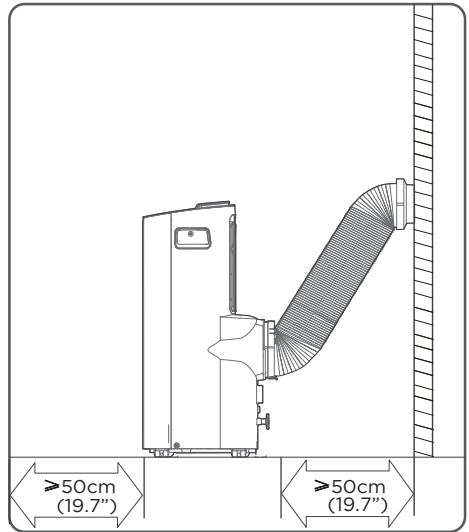
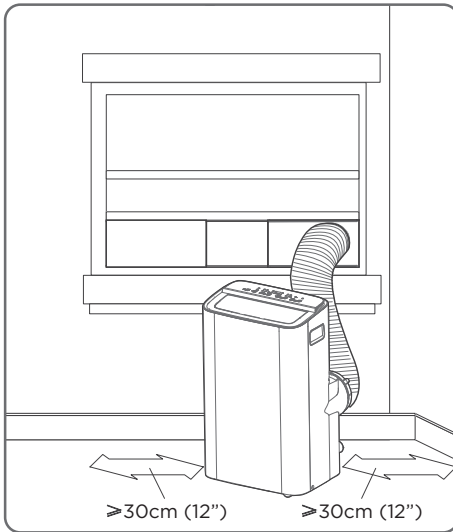

Product Overview

NOTICE

All the illustrations in the manual are for explanation purpose only. Your machine may be slightly different. The actual shape shall prevail.

The unit can be controlled by the unit control panel alone or with the remote control.

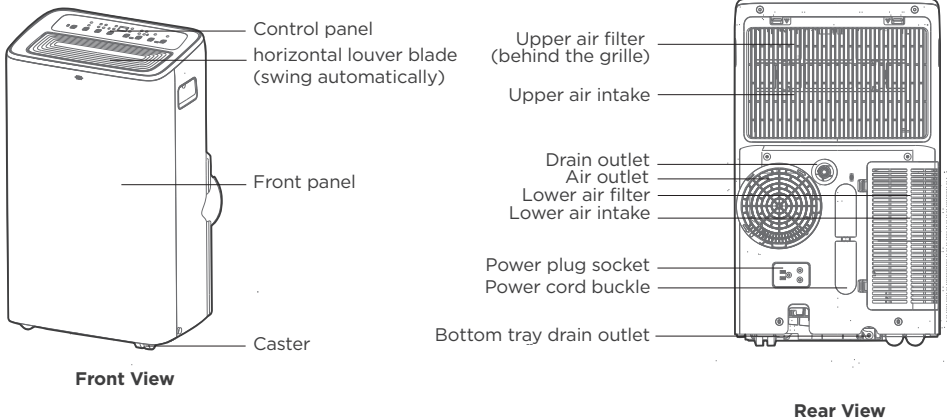

DESIGN NOTICE

In order to ensure optimal performance of our products, the design specifications of the unit and remote control are subject to change without prior notice.

Installation Overview

Installation Completion Display

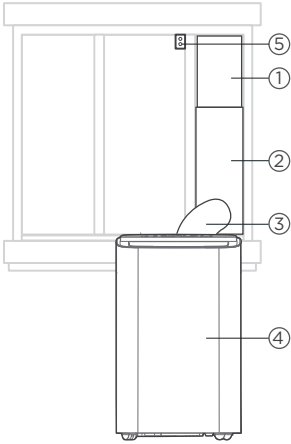

Sliding Window Installation

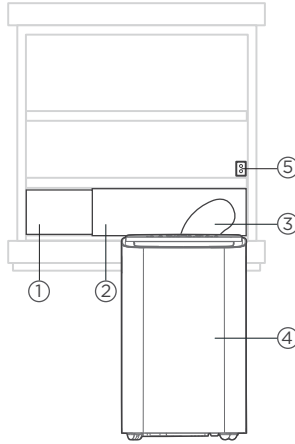

Hung Window Installation

1. Window Slider
2. Window Slider
3. Extended Exhaust Hose
4. Portable Air Conditioner
5. Security Bracket and 2 Screws

NOTICE

Illustrations in this manual are for explanatory purposes. The actual shape of your indoor unit may be slightly different. The actual shape shall prevail.

Tools Needed



Screwdriver
& wrench



Pencil



A tape
measure



Scissors
or Knife



Saw (On some models,
to shorten window adaptor
for narrow windows)

Installation Accessories

NOTICE

Slight variations in design may occur.

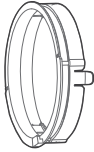

Unit Adapter
(1 pc)

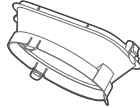

Air exhaust
adapter (1 pc)



Exhaust Hose
(1 pc)



Foam Seal A
(Adhesive) (4 pc)



Foam Seal B
(Adhesive) (2 pc)



Foam Seal C
(Non-adhesive) (2 pc)



Security Bracket
and 2 Screws (1 set)



Drain Hose
(1 pc)



Power Cord
Buckle (1 pc)



Bolt (3 pc)

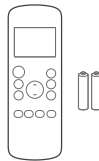

Remote Controller
and Battery (only for
remote control models)
(1 set)



Window Sliders
(1 set)

Confirm Your Window Type (Window Type And Opening Size Of Different Types)

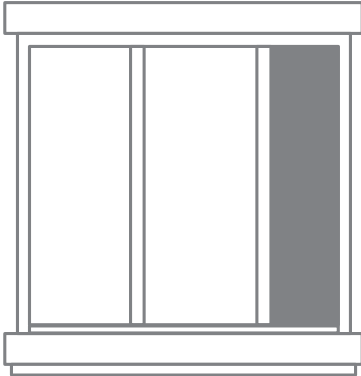

Sliding Window Installation

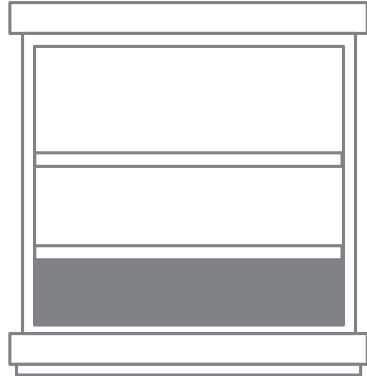

Hung Window Installation

For Optimal Performance In Operation

NOTICE

To ensure proper function, DO NOT overextend or bend the hose. Make sure that there is no obstacle around the air outlet of the exhaust hose (in the range of 500mm) in order to ensure the exhaust system works properly. All the illustrations in this manual are for explanation purpose only. Your air conditioner may be slightly different. The actual shape shall prevail.

INCORRECT

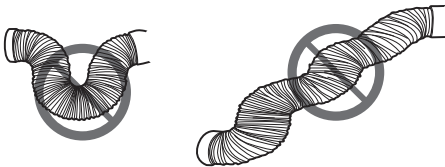

CORRECT

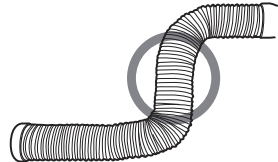

Exhaust Hose And Adapters Installation

1 - Assembling the Exhaust Hose:

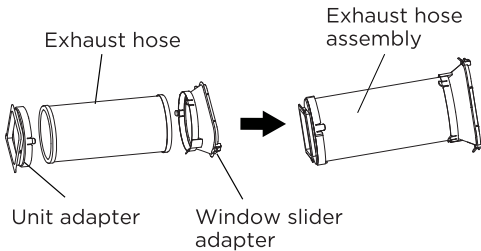

Press the exhaust hose (or extended exhaust hose) into the window slider adapter and unit adapter. The hose should clamp automatically to the elastic buckles of the adapters.

NOTICE

Please install the exhaust hose assembly according to the fittings in your kit.

Connect The Adapter To The Unit And The Window

2 - Preparing the Adjustable Window Slider:

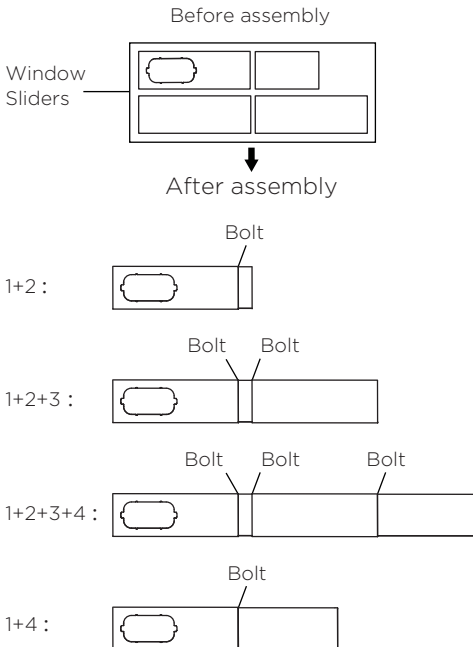

Choose the window sliders according to the size of your window. Sometimes, the sliders may need to be cut short to meet the window size. Please take extra care to cut it properly. Use bolts to fasten the window sliders once they are adjusted to the proper length.

NOTICE

Please base your window slider installation on the accessories in your kit and the size of your window.

3 - Completely Sealing the Window:

Cut the adhesive foam seal A and B strips to the proper lengths, and attach them to the window sash and frame as shown.

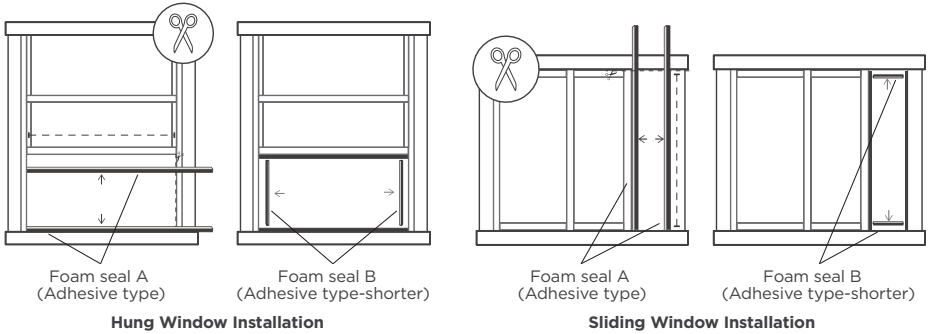

4 - Hung Window Installation:

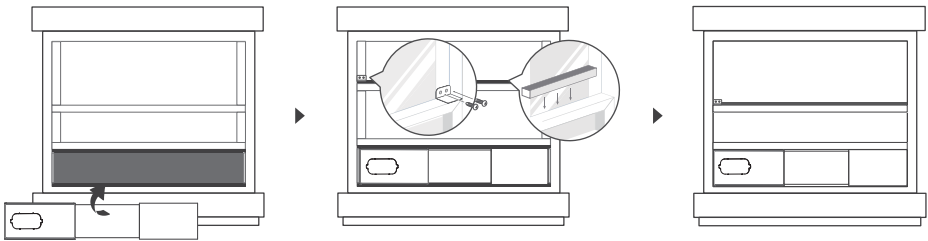

Step 1: Insert the window slider assembly into the window opening.

Step 2: Cut the non-adhesive foam seal C strip to match the width of the window. Insert the seal between the glass and the window frame to prevent air and insects from getting into the room.

Step 3: If desired, install the security bracket with 2 screws as shown.

NOTICE

Once the exhaust hose assembly and adjustable window slider are prepared, choose one of the two installation methods based on your window type.

5 - Sliding Window Installation:

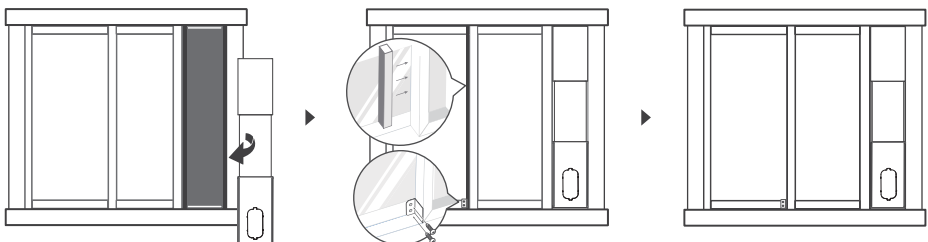

- Step 1:** Insert the window slider assembly into the window opening.
- Step 2:** Cut the non-adhesive foam seal C strip to match the height of the window. Insert the seal between the glass and the window frame to prevent air and insects from getting into the room.
- Step 3:** If desired, install the security bracket with 2 screws as shown.

NOTICE

Once the exhaust hose assembly and adjustable window slider are prepared, choose one of the two installation methods based on your window type.

6 - Install The Exhaust Hose Assembly To The Unit:

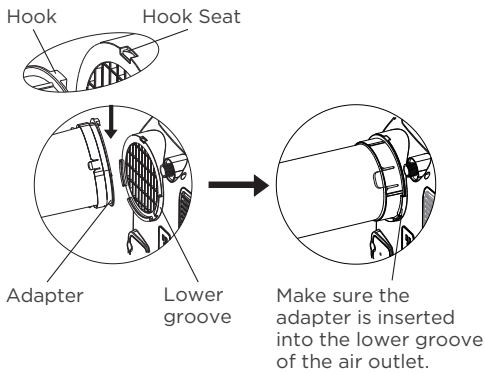

Push the exhaust hose into the air outlet opening of the unit according to the arrow directions (pictured left). Push the hook down into the hook seat, then push the adapter into the grooves of the air outlet.

7 - Connect The Adapter To The Unit And The Window:

Insert the window slider adapter into the hole of the window slider.

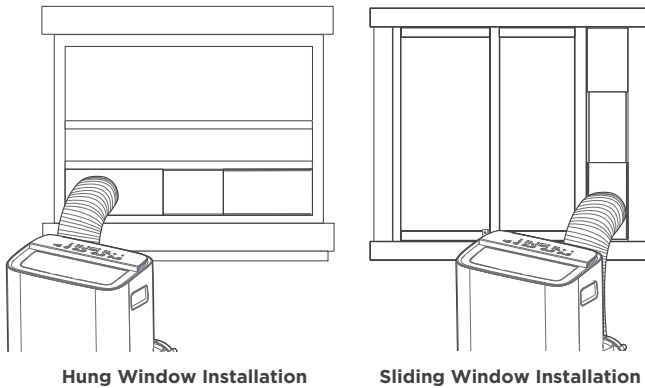

OPERATING INSTRUCTIONS

Electronic Control Operating Instructions

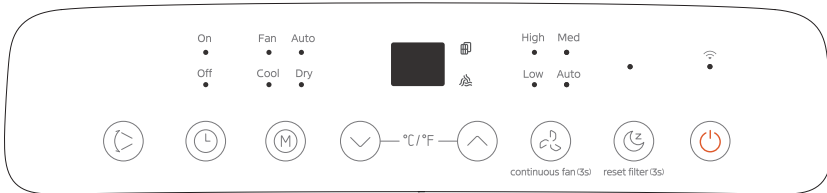

1. POWER Button

Power switch on/off.

Used to initiate the Wireless function. For the first time using the Wireless function, press and hold the POWER button for 3 seconds to initiate the Wireless connection mode. The LED DISPLAY shows 'AP' to indicate you can set Wireless connection. If connection (router) is successful within 8 minutes, the unit will exit Wireless connection mode automatically and the Wireless indicator light illuminates.

If connection fails within 8 minutes, the unit exits Wireless connection mode automatically. After Wireless connection is successful, you can press and hold POWER and DOWN (✓/-) buttons at the same time for 3 seconds to turn off wireless function and the LED display will show 'OF' for 3 seconds. Press the POWER and UP (✓/+) buttons at the same time to turn on Wireless function and the LED DISPLAY shows 'On' for 3 seconds.

NOTICE

When you restart the Wireless function, it may take a period of time to connect to the network automatically.

2. MODE Function

Selects the appropriate operating mode. Each time you press the button, a mode is selected in the following sequence: AUTO, COOL, DRY, FAN. The mode indicator light illuminates under the different mode settings.

3. UP (✓/+) and DOWN (✓/-) Buttons

Used to increase or decrease temperature settings in 1°F or 1°C increments. The range is 16°C/60°F to 30°C/86°F.

TIMER setting in a range of 0~24hrs.

NOTICE

The control is capable of displaying temperature in degrees Fahrenheit or degrees Celsius. To convert from one to the other, press and hold the Up and Down buttons at the same time for 3 seconds.

4. DISPLAY

Shows the set temperature in °C or °F and the Auto-timer settings. While on DRY and FAN modes, it shows the room temperature.

Shows Error codes and protection code:

EH60—Room temperature sensor error.

EH61—Evaporator temperature sensor error.

EC52—Condenser temperature sensor error (on some models).

EH0B—Display panel communication error.

ELOC—Refrigerant leakage detection malfunction (on some models).

P1—Bottom tray is full. Connect the drain hose and drain the collected water. If the P1 code does not erase, call for service.

NOTICE

When one of the above malfunctions occurs, turn off the unit, and check for any obstructions. Restart the unit, and if the malfunction is still present, turn off the unit and unplug the power cord.

Contact the manufacturer, its service agents or a similar qualified person for service.

5. TIMER Button

Used to initiate the AUTO ON start time and AUTO OFF stop time program in conjunction with the UP & DOWN buttons. The timer on/off indicator light illuminates under the timer on/off settings.

6. SWING Mode

Used to initiate the Auto Swing feature. When the operation is ON, press the SWING button to stop the louver at the desired angle.

7. DRY Mode

To turn on Dry mode, press the "MODE" button until the "Dry" indicator light comes on. In this mode, the fan speed or the temperature cannot be adjusted.

NOTICE

Keep windows and doors closed for the best dehumidifying effect.

8. AUTO Mode

When you set the air conditioner to AUTO mode, it will automatically select cooling, heating (heat function only on some models), or fan only operation depending on what temperature you have selected and the room temperature. To turn on Auto mode, press the "MODE" button until the "Auto" indicator light comes on.

The air conditioner will control room temperature automatically around the temperature point you set. Under AUTO mode, you cannot select the fan speed.

NOTICE

Under AUTO mode, both the AUTO mode and the actual operation mode indicator lights illuminate for some models.

9. COOL Mode

To turn on Cool mode, press the "MODE" button until the "Cool" indicator light comes on.

Press the ADJUST buttons UP (∧/+) or DOWN (∨/-) to select your desired room temperature. The temperature can be set within a range of 16°C~30°C/60°F~86°F.

Press the "FAN SPEED" button to choose the fan speed.

10. FAN Mode

To turn on Fan mode, press the "MODE" button until the "Fan" indicator light comes on.

The fan speed indicator light will illuminate under different fan settings.

11. CONSTANT FAN Function

In Cool or Dry mode, press and hold the Fan button for 3 seconds to turn the constant fan function on or off. When the function is turned on, the constant fan light will illuminate. When the function is turned off, the constant fan light will turn off.

12. SLEEP Mode

Press the sleep button to initiate sleep mode. While in this mode, the selected temperature will increase or decrease by 1°C/2°F(or 1°F) after 30 minutes.

The temperature will then increase or decrease by another 1°C/2°F(or 1°F) after an additional 30 minutes. This new temperature will be maintained for 7 hours before it returns to the originally selected temperature. After the 7 hour period, sleep mode is automatically turned off and the unit will continue to operate as originally programmed.

NOTICE

This feature is unavailable under FAN or DRY mode.

Press and hold on the SLEEP button for 3 seconds to initiate the reset filter connection mode. This feature is a reminder to clean the Air Filter for more efficient operation. The LED (light) will illuminate after 250 hours of operation. To reset after cleaning the filter, press the SLEEP button and the light will go off.

Drainage Guide

During dehumidifying mode or heat pump mode (only on some models), remove the upper drain plug from the back of the unit and install the drain connector (5/8" universal female mender) with 3/4" hose (not included).

NOTICE

Make sure the hose is secure so there are no leaks. Direct the hose toward the drain, making sure that there are no kinks that will stop the water flowing. Place the end of the hose into the drain and make sure the end of the hose is down to let the water flow smoothly. When the continuous drain hose is not used, ensure that the corresponding drain plug and knob are installed firmly to prevent leakage.

When the water level of the bottom tray reaches a predetermined level, the unit beeps 8 times and the digital display area shows "P1". At this time the air conditioning/dehumidification process will immediately stop. However, the fan motor will continue to operate (this is normal).

Carefully move the unit to a drain location, remove the bottom drain plug and let the water drain away. Reinstall the bottom drain plug and restart the machine. The "P1" symbol should disappear. If the error repeats, call for service.

NOTICE

Be sure to reinstall the bottom drain plug firmly to prevent leakage before using the unit.

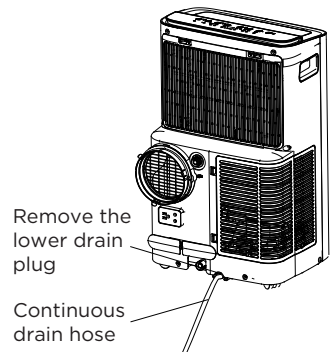
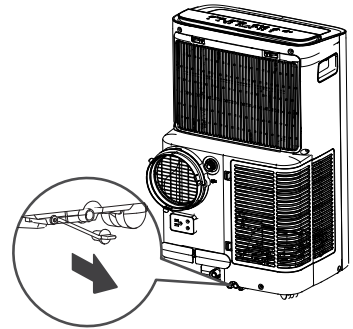
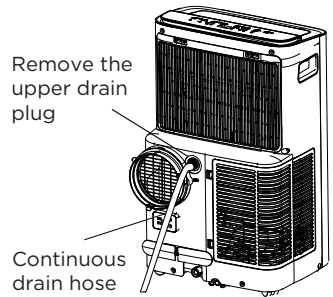

CLEANING & MAINTENANCE

Air Filter & Cabinet Cleaning

Clean the unit using a damp, lint-free cloth and mild detergent.
Dry the unit with a dry, lint-free cloth.

- Take both filters out according to the arrow directions (pictured right).
- Wash each air filter by immersing it gently in warm water (about 40°C/104°F) with a neutral detergent.
- Rinse the filters and dry them in a shady place.
- Install the air filters after cleaning.

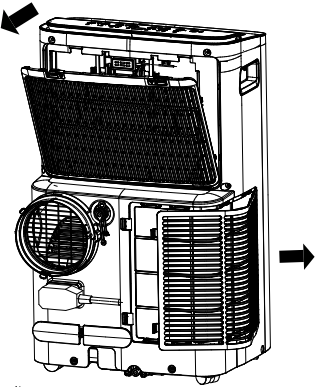

Remove the air filters

CAUTION

DO NOT operate the unit without filters, as dirt and lint will clog it and reduce performance.

Maintenance Tips

- Be sure to clean the air filter every 2 weeks for optimal performance.
- The water collection tray should be drained immediately after P1 error occurs and before storage to prevent mold.
- In households with animals, you will have to periodically wipe down the grill to prevent blocked airflow due to animal hair.

CAUTION

- Always unplug the unit before cleaning or servicing.
- DO NOT use flammable liquids or chemicals to clean the unit.
- DO NOT wash the unit under running water. Doing so causes electrical danger.
- DO NOT operate the machine if the power supply was damaged during cleaning. A damaged power cord must be replaced with a new cord from the manufacturer.

Store The Unit When Not In Use

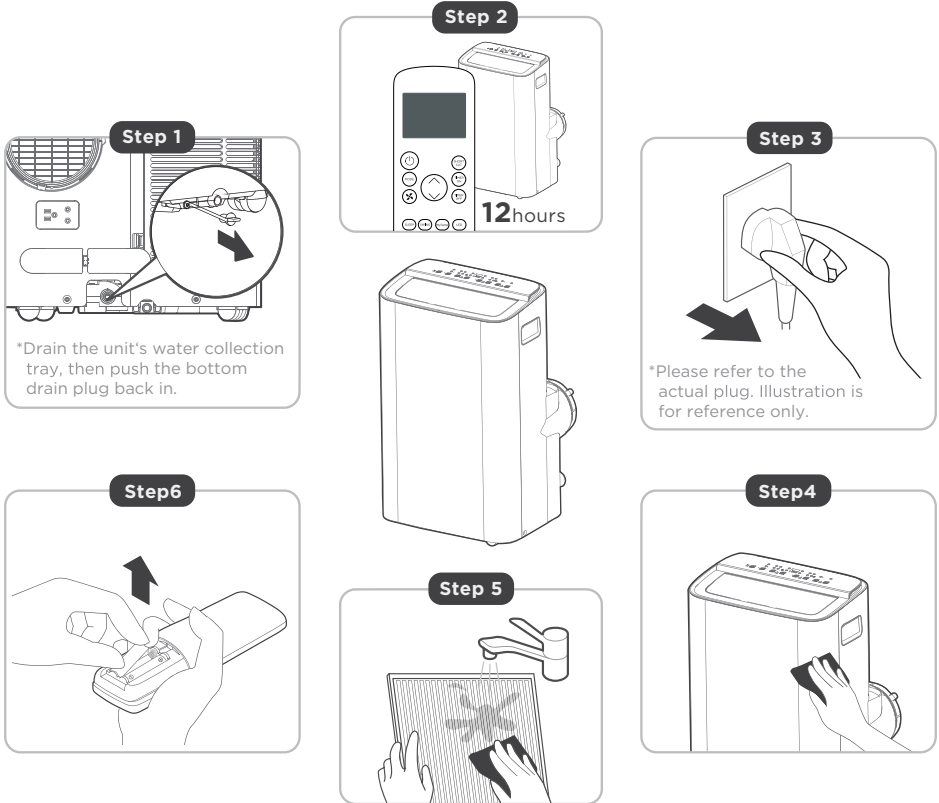

Step 1: Drain the unit's water collection tray by removing the bottom drain plug.

Step 2: Run the appliance on FAN mode for 12 hours in a warm room to dry it and prevent mold.

Step 3: Turn off the appliance and unplug it.

Step 4: Clean the machine.

Step 5: Clean the air filter according to the instructions in the previous section. Reinstall the clean, dry filter before storing.

Step 6: Remove the batteries from the remote control.

NOTICE

- Be sure to store the unit in a cool, dark place. Exposure to direct sunshine or extreme heat can shorten the lifespan of the unit.
- The cabinet and front may be dusted with an oil-free cloth or washed with a cloth dampened in a solution of warm water and mild liquid dishwashing detergent. Rinse thoroughly and wipe dry. Never use harsh cleansers, wax or polish on the cabinet front. Be sure to wring excess water from the cloth before wiping around the controls. Excess water in or around the controls may cause damage to the unit.

TROUBLESHOOTING TIPS

Common Issues

The following problems are not a malfunction and in most situations will not require repairs.

Problem	Reason	Solution
Unit does not turn on when pressing ON/OFF button	P1 Protection Code.	The water collection tray is full. Turn off the unit, drain the water from the water collection tray and restart the unit.
	In COOL mode: room temperature is lower than the set temperature.	Check the set temperature.
Unit does not cool well	The air filter is blocked with dust or animal hair.	Turn off the unit and clean the filter according to instructions.
	Exhaust hose is not connected or is blocked.	Turn off the unit, disconnect the hose, check for blockage and reconnect the hose.
	The unit is low on refrigerant.	Call a service technician to inspect the unit and top off refrigerant.
	Temperature setting is too high.	Decrease the set temperature.
	The windows and doors in the room are open.	Make sure all windows and doors are closed.
	The room area is too large.	Double-check the cooling area.
	There are heat sources inside the room.	Remove the heat sources if possible.
The unit is noisy and vibrates too much	The ground is not level.	Place the unit on a flat, level surface.
	The air filter is blocked with dust or animal hair.	Turn off the unit and clean the filter according to instructions.
The unit makes a gurgling sound	This sound is caused by the refrigerant flow inside the unit.	This is normal.

REMOTE CONTROL AND APP INSTRUCTIONS

Remote Control Specifications

Model	RG57H4(B2)/BGCEFU1
Rated voltage	3.0V (Dry batteries R03/LR03x2)
Signal receiving range	26 ft. (approx. 8 m)
Environment	23°F ~ 140°F (-5°C ~ 60°C)

Function Buttons

Before you begin using your new air conditioner, make sure to familiarize yourself with its remote control. The following is a brief introduction to the remote control itself. For instructions on how to operate your air conditioner, refer to the Operating Instructions section of this manual.

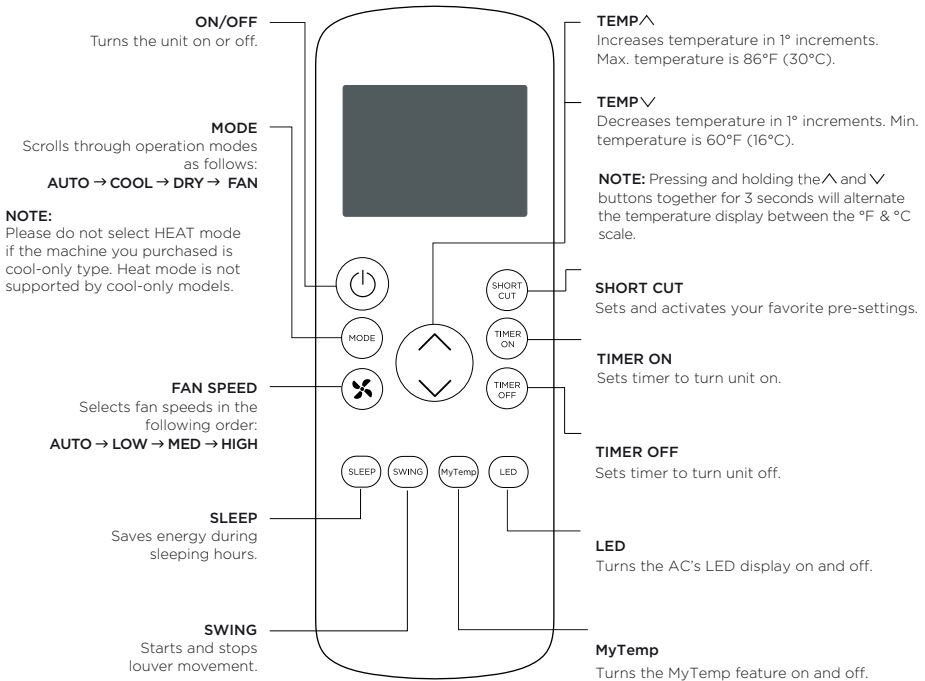

Handling the Remote Control

NOT SURE WHAT A FUNCTION DOES?

Refer to the Operating Instructions section of this manual for a detailed description of the functions available using the remote.

NOTICE

Button designs on your unit may differ slightly from the example shown.

If the unit does not have a specific function, using that function's button on the remote control will have no effect.

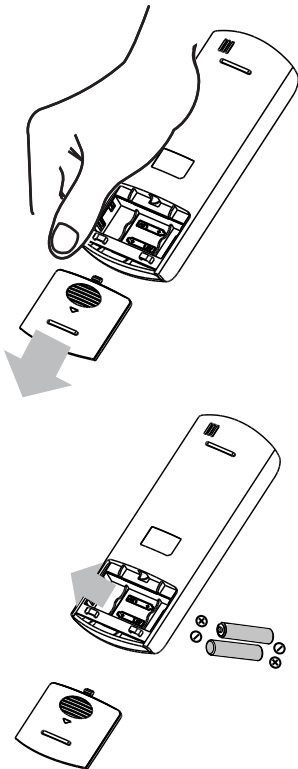

INSERTING AND REPLACING BATTERIES

Your air conditioning unit comes with two AAA batteries. Insert the batteries in the remote control before use.

1. Slide the back cover of the remote control downward, exposing the battery compartment.
2. Insert the batteries, paying attention to align the (+) and (-) ends of the batteries with the symbols inside the battery compartment.
3. Slide the battery cover back into place.

BATTERY NOTES

For optimum product performance:

- Do not mix old and new batteries, or batteries of different types.
- Do not leave batteries in the remote control if you don't plan on using the device for more than 2 months.

BATTERY DISPOSAL

Ensure used batteries are disposed of properly.

TIPS FOR USING REMOTE CONTROL

- The remote control must be used within 26 feet / 8 meters of the unit.
- The unit will beep when it receives a signal from the remote. Curtains, other materials and direct sunlight can interfere with the IR signal receiver.
- In order to properly transmit a command, the ON/OFF indicator must be illuminated on the remote's display. (See the Remote LED Screen Indicators section for more information.)

Remote LED Screen Indicators

Transmission Indicator

Lights up when remote sends signal to unit

MODE display

Displays the current mode, including:

- AUTO 
- COOL 
- DRY 
- HEAT 
- FAN 

ON/OFF display

Appears when the remote is enabled and can send a signal to the unit. If you would like to turn the remote off without affecting the unit, point the remote away from the unit and press the ON/OFF button.

To turn the remote on, point the remote away from the unit and press the ON/OFF button. This indicator will light up when the remote turns on. The unit will not receive commands from the remote if this indicator is not illuminated.

TIMER ON display

Displays when
TIMER ON is set

TIMER OFF display

Displays when
TIMER OFF is set

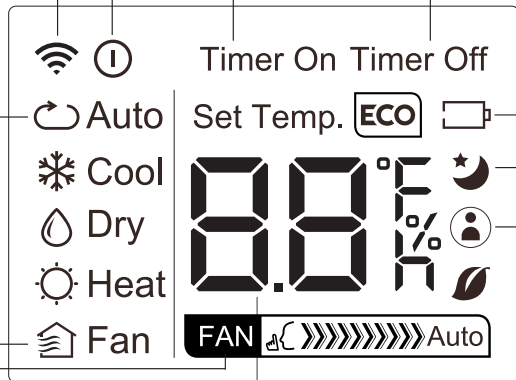

Battery display

Low battery detection

SLEEP display

Displays when SLEEP function is activated

MyTemp display

Indicates that the MyTemp function is on

FAN SPEED display

Displays selected FAN SPEED:

HIGH 

MED 

LOW

This display is blank when set to AUTO speed.

Temperature/Timer display

Displays the set temperature by default, or the timer setting when using TIMER ON/OFF functions:

- Temperature range: 62°F-86°F (17°C-30°C)
- Timer setting range: 0-24 hours

This display is blank when operating in FAN mode.

Basic Functions

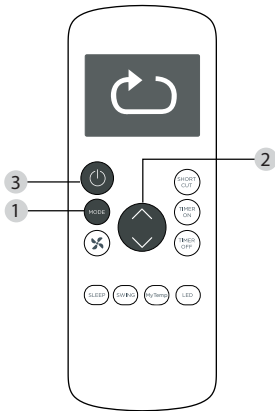

SETTING THE DESIRED TEMPERATURE

The operating temperature range for this unit is 62°F-86°F (17-30°C). You can increase or decrease the set temperature in 1°F or 1°C increments.

Changing the Mode

1. To change the operating mode, press the MODE button until the desired mode appears on the remote's display.
2. Set the desired temperature.

NOTICE

If the unit does not change when the button is pressed, check that the ON/OFF indicator is illuminated. If it is not, point the remote at the unit and press the ON/OFF button.

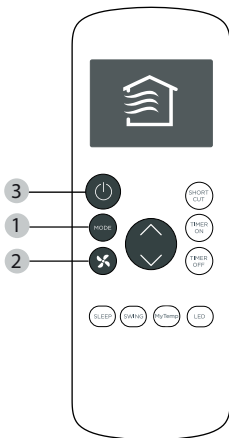

Changing the Fan Speed

To change the fan speed, press the FAN button until the desired fan speed appears on the remote's display.

NOTICE

If the unit does not change when the button is pressed, check that the ON/OFF indicator is illuminated. If it is not, point the remote at the unit and press the ON/OFF button.

Timer Functions

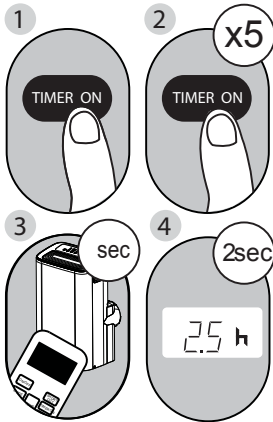

Example: Setting unit to turn on after 2.5 hours.

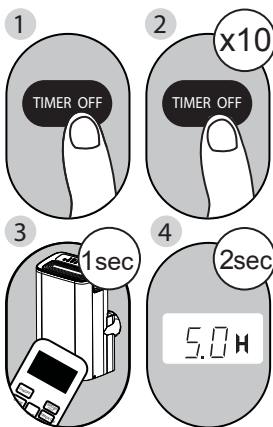

Example: Setting unit to turn off after 5 hours.

Your air conditioning unit has two timer-related functions:

TIMER ON - sets the amount of time after which the unit will automatically turn on.

TIMER OFF - sets the amount of time after which the unit will automatically turn off.

TIMER ON Function

The TIMER ON function allows you to set a period of time after which the unit will automatically turn on, such as when you come home from work.

1. Press the TIMER ON button. By default, the last time period that you set and an "h" (indicating hours) will appear on the display.

NOTICE

This number indicates the amount of time after the current time after which you want the unit to turn on.

For example, if you set TIMER ON for 2 hours, "2.0h" will appear on the screen, and the unit will turn on after 2 hours.

2. Press the TIMER ON button repeatedly to set the time that you want the unit to turn on.
3. Wait 2 seconds and then the TIMER ON function will be activated. The digital display on your remote control will then return to the temperature display.

TIMER OFF Function

The TIMER OFF function allows you to set a period of time after which the unit will automatically turn off, such as when you wake up.

1. Press the TIMER OFF button. By default, the last time period that you set and an "h" (indicating hours) will appear on the display.

NOTICE

This number indicates the amount of time after the current time after which you want the unit to turn off.

For example, if you set TIMER OFF for 2 hours, "2.0h" will appear on the screen, and the unit will turn off after 2 hours.

2. Press the TIMER OFF button repeatedly to set the time that you want the unit to turn off.

Timer Functions (cont.)

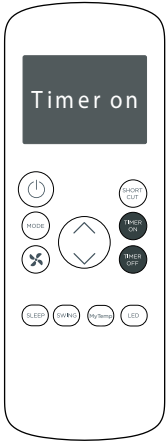

Continue to press
TIMER ON
or
TIMER OFF
until desired time is reached.

- Wait 2 seconds and then the **TIMER OFF** function will be activated. The digital display on your remote control will then return to the temperature display.

NOTICE

When setting the **TIMER ON** or **TIMER OFF** functions from 0 hours (0.0h) to 10 hours (10h), the time will increase in 30 minute increments with each press. From 10 hours (10h) to 24 hours (24h), it will increase in 1 hour increments. The timer will revert to zero after 24 hours.

You can turn off either function by setting the timer to "0.0h".

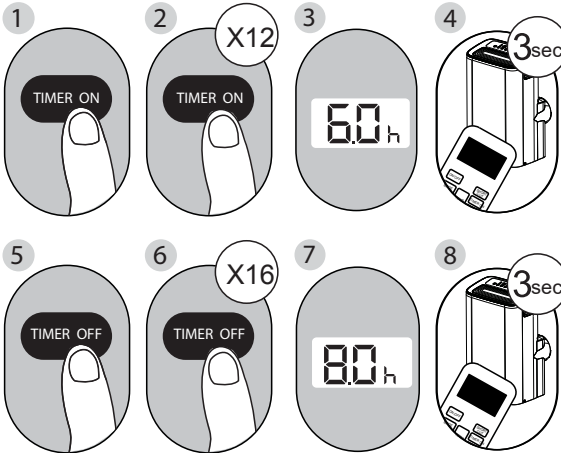

Setting Both **TIMER ON** And **TIMER OFF** At The Same Time

Keep in mind that the time periods you set for both functions refer to hours after the current time. For example, say that the current time is 1:00 PM, and you want the unit to turn on automatically at 7:00 PM, operate for 2 hours, then automatically turn off at 9:00 PM. In that case, you would follow the illustrated sequence to the left.

Example: See the figure below for an example of settings that instruct the unit to turn on after 6 hours, operate for 2 hours, then turn off.

Your remote display

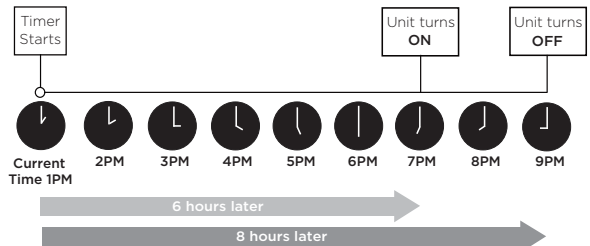
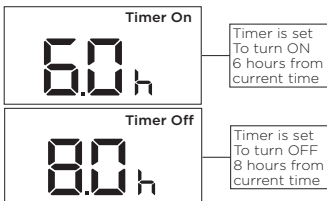

How to Use the Advanced Functions

SLEEP Function

The SLEEP function is used to decrease energy use while you sleep (and don't need the same temperature settings to stay comfortable).

Note: The SLEEP function is not available in FAN or DRY mode.

SWING Function

Used to stop or start louver movement and set the desired up/down air flow direction. The louver angle changes in 6-degree increments with each press (not all models). By pressing for more than 2 seconds, the louver auto swing feature is activated.

MyTemp Function

The MyTemp function enables the remote control to measure the temperature at its current location.

When using AUTO, COOL, measuring ambient temperature from the remote control (instead of from the indoor unit itself) will enable the air conditioner to optimize the temperature around you and ensure maximum comfort.

1. Press the button to activate function.
The remote control will send temperature signals to the unit every three minutes.
2. Press the button again to turn off this function.

SHORTCUT Function

- Used to restore the current settings or resume previous settings.
- Push this button when remote controller is on. The system will automatically revert back to the previous settings, including operating mode, setting temperature, fan speed level and sleep feature (if activated).
- By pressing for more than 2 seconds, the system will automatically store the current operation settings, including operating mode, setting temperature, fan speed level and sleep feature (if activated).

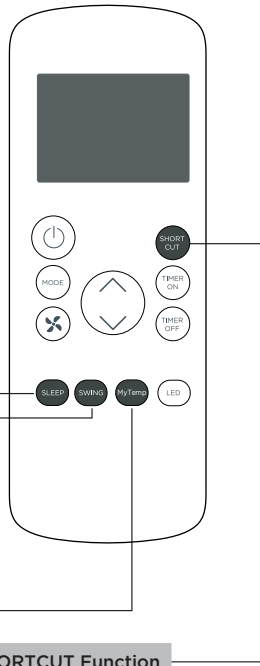

NOTICE

This device complies with part 15 of the FCC Rules. Operation is subject to the following two conditions: (1) This device may not cause harmful interference, and (2) this device must accept any interference received, including interference that may cause undesired operation.

Note: This equipment has been tested and found to comply with the limits for a Class B digital device, pursuant to part 15 of the FCC Rules. These limits are designed to provide reasonable protection against harmful interference in a residential installation. This equipment generates, uses and can radiate radio frequency energy and, if not installed and used in accordance with the instructions, may cause harmful interference to radio communications. However, there is no guarantee that interference will not occur in a particular installation.

If this equipment does cause harmful interference to radio or television reception, which can be determined by turning the equipment off and on, the user is encouraged to try to correct the interference by one or more of the following measures:

- Reorient or relocate the receiving antenna.
- Increase the separation between the equipment and receiver.
- Connect the equipment into an outlet on a circuit different from that to which the receiver is connected.
- Consult the dealer or an experienced radio/TV technician for help.

1 How to use Matter ✨

Connect Your Air Conditioner through Matter

△ Make sure your mobile device is connected to your wireless router.

Wireless router should support and turn on IPv6. Please make sure your smartphone connect to 2.4G but not 5G network.

For best Matter compatibility, connect the AC to the Alexa, Google Home or Apple Home ecosystems along with at least one of their respective Matter enabled smart speakers.

■ Step 1: Connect to smart speaker

Select your preferred ecosystem (Alexa, Google Home or Apple Home) and make sure you've got one of their Matter enabled products (such as their smart speakers) connected to your wireless router.

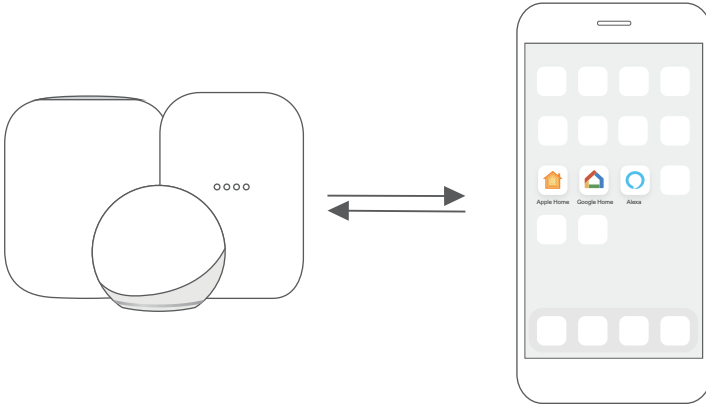

■ Step 2: Turn on Bluetooth

Turn on Bluetooth on your mobile device.

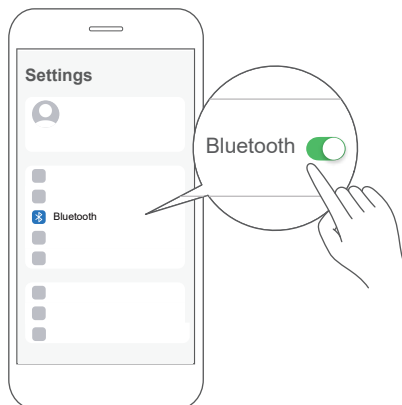

■ Step 3: Enter AP mode

Hold down the CONNECT button for 3 seconds to begin the pairing process ("AP" will appear on the AC's display).

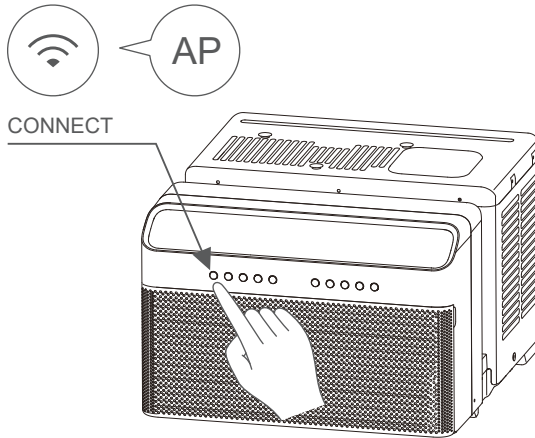

■ Step 4: Open app

Open the Alexa, Google Home, Apple Home app on your mobile device.

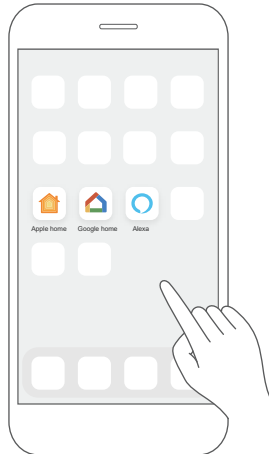

■ Step 5: Scan matter QR code

Tap the "+" and "Add Device/Accessory" or tap "+Add" in your app and then select Matter device and scan the Matter QR code found on the side of the AC device. Follow the respective instructions in the Alexa, Google Home or Apple Home app to complete the pairing process.

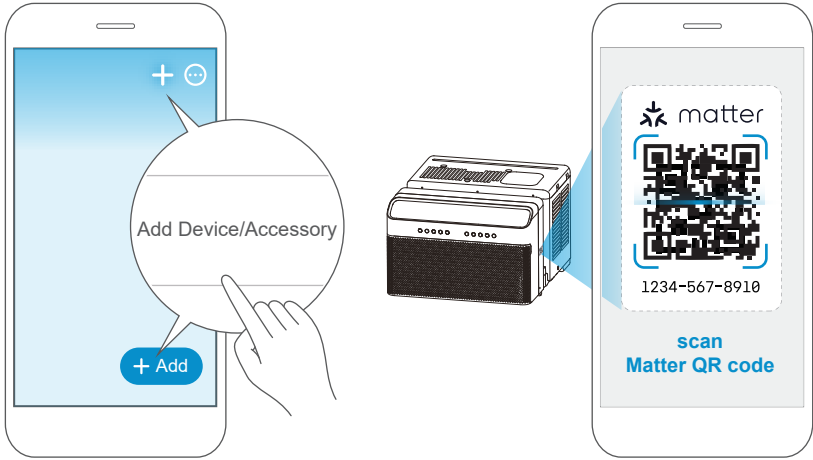

■ Step 6: Control device

After pairing is successful, you can control your AC's temperature and mode settings, etc. through the respective ecosystem app and/or smart speaker.

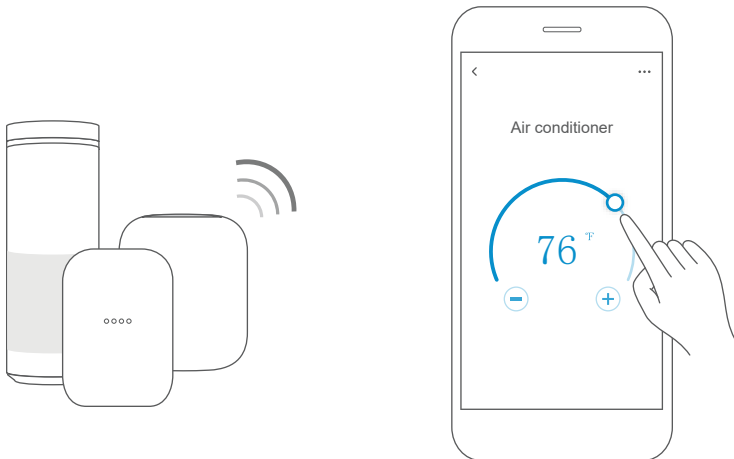

App & Smart Speakers can support Matter only when using these versions or above.

Device	Version
iPhone	iOS 16.5
Apple Home Pod	16.5
Android	Google Play services min version: 22.36.15 Google Home app (GHA) min version: 2.58.24.1-dogfood
Google Home Hub	Google Hub firmware min version: 1.56.324896 (appears on hub as Chromecast firmware version)
Alexa App	2.2.536317
Alexa Echo Device	9094439556

NOTE:

- Setup processes and features may vary between ecosystems.
- Make sure the Matter enabled app is up to date to ensure the best experience.
- Periodically, we will update the device's software to improve the experience. Device software updates can be accomplished through the SmartHome app.

2 How to use SmartHome App

- ⚠ Ensure that your mobile phone is connected to the wireless network. Bluetooth must be turned on. The device must also be powered up.

■ Step 1: Download the SmartHome app

Scan the QR code below to download the SmartHome app from app store or search for it directly on the Google Play Store or Apple's App Store.



■ Step 2: Log in

Open the SmartHome app. Log in directly if you have an existing SmartHome account or create a new account. Alternatively, you can also use a 3rd party login platform.

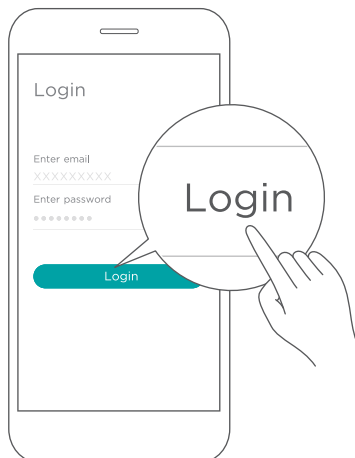

■ Step 3: Connecting the device

1) When you log in, you may see the message "Smart devices discovered nearby". Tap to add your device.

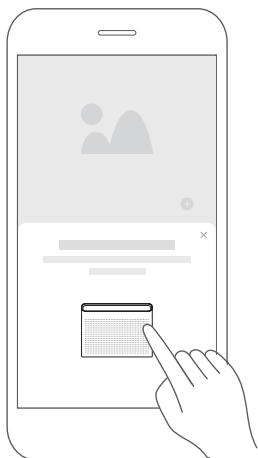

2) If no such message appears, proceed as follows: Tap on "+" and select your device in the list of nearby available devices. If your device is not listed, please add your device manually, first selecting the device category e.g. Window AC.

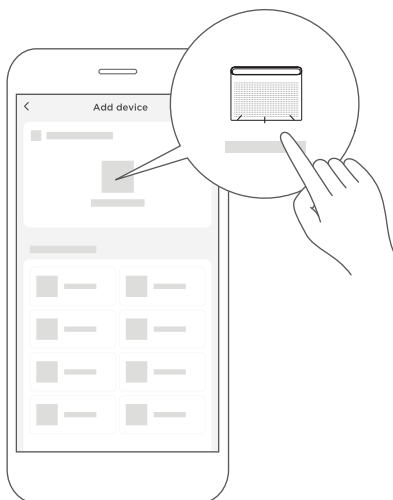

3) Follow the steps in the app to connect your device to the wireless network. If your device fails to connect, follow the additional instructions in the app.

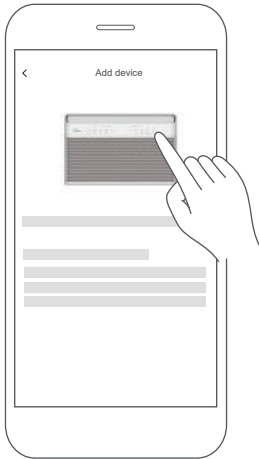

For Window AC



For Portable AC

■ Step 4: Controlling the device

After pairing successfully, a card will be created for the device in the SmartHome app.

Shortcuts for basic functions will appear on the card such as changing the temperature or switching the device on or off.

Tapping on the card, will reveal additional features and settings. The actual UI design may look different from examples due to app updates.

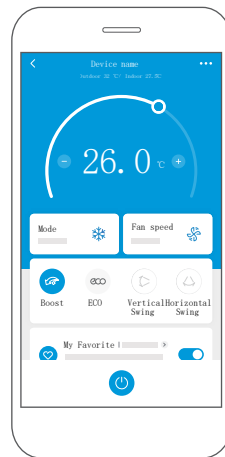
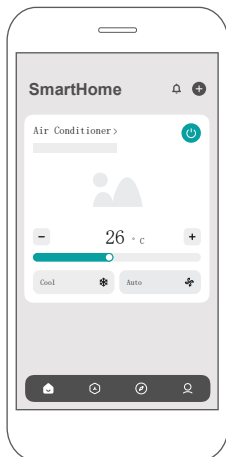

■ Declaration of conformity

FCC ID: 2ADQOMDNA23

IC: 12575A-MDNA23

This device complies with Part 15 of the FCC Rules and Industry Canada's licenceexempt RSSs.

Operation is subject to the following two conditions:

- (1) This device may not cause interference; and
- (2) This device must accept any interference, including interference that may cause undesired operation of the device.

Only operate the device in accordance with the instructions supplied. Changes or modifications to this unit not expressly approved by the party responsible for compliance could void the user's authority to operate the equipment. This device complies with FCC radiation exposure limits set forth for an uncontrolled environment. In order to avoid the possibility of exceeding the FCC radio frequency exposure limits, human proximity to the antenna shall not be less than 20cm (8 inches) during normal operation.

NOTE:

This equipment has been tested and found to comply with the limits for a Class B digital device, pursuant to part 15 of the FCC Rules. These limits are designed to provide reasonable protection against harmful interference in a residential installation.

This equipment generates, uses and can radiate radio frequency energy and, if not installed and used in accordance with the instructions, may cause harmful interference to radio communications. However, there is no guarantee that interference will not occur in a particular installation. If this equipment does cause harmful interference to radio or television reception, which can be determined by turning the equipment off and on, the user is encouraged to try to correct the interference by one or more of the following measures:

- Reorient or relocate the receiving antenna.
- Increase the separation between the equipment and receiver.
- Connect the equipment into an outlet on a circuit different from that to which the receiver is connected.
- Consult the dealer or an experienced radio/TV technician for help.

3 SPECIFICATION

This device is in compliance with the essential requirements and other relevant provisions of Directive 2014/53/EU, in order to avoid the possibility of exceeding the radio frequency exposure limits, human proximity to the antenna shall not be less than 20cm during normal operation. (European Union products only)

Unit model: MPX0812CWRU, MPX1011CWRU

Wireless Module Model: US-SK109

Antenna Type: Printed PCB Antenna

Wireless: 2400 - 2483.5MHz, TX Power: < 20dBm

Operation Temperature: 0°C~45°C/32°F~113°F

Operation Humidity: 10%~85%

Power Input: DC 5V/500mA

BLE: 2402 - 2480MHz, TX Power: < 10dBm

Supplier's Declaration of Conformity
47 CFR § 2.1077 Compliance Information

Unique Identifier: RG57H4(B2)/BGCEFU1

Responsible Party U.S. Contact Information

Midea America Corporation
300 Kimball Dr
Parsippany NJ
07054

Telephone number or internet contact information: Midea.com/us

FCC Compliance Statement (products subject to Part 15)

This device complies with Part 15 of the FCC Rules. Operation is subject to the following two conditions: (1) This device may not cause harmful interference, and (2) this device must accept any interference received, including interference that may cause undesired operation.

WARRANTY

Air Conditioner Limited Warranty

Your product is protected by this Limited Warranty:

Warranty service must be obtained from Midea Consumer Services or an authorized Midea servicer.

Warranty

- Three Year Full warranty from the date of delivery or the purchase date, whichever is later.
- The date of delivery establishes the warranty period, should service be required.

Midea, through its authorized servicers will:

- Pay all costs for repairing or replacing parts of this appliance which prove to be defective in materials or workmanship.

Consumer will be responsible for:

- Diagnostics, removal, transportation and reinstallation cost required because of service.
- Costs of service calls that are a result of items listed under NORMAL RESPONSABILITIES OF THE CONSUMER**

Midea replacement parts shall be used and will be warranted only for the original warranty.

NORMAL RESPONSABILITIES OF THE CONSUMER**

This warranty applies only to products in ordinary household use, and the consumer is responsible for the items listed below:

1. Proper use of the appliance in accordance with instructions provided with the product.
2. Routine maintenance and cleaning necessary to keep the good working condition.
3. Proper installation by an authorized service professional in accordance with instructions provided with the appliance and in accordance with all local plumbing, electrical and/or gas codes.
4. Proper connection to a grounded power supply of sufficient voltage, replacement of blown fuses, repair of loose connections or defects in house wiring.
5. Expenses for making the appliance accessible for servicing.
6. Damages to finish after installation.

EXCLUSIONS

This warranty does not cover the following:

- 1) Failure caused by damage to the unit while in your possession (other than damage caused by defect or malfunction), by its improper installation, or by unreasonable use of the unit, including without limitation, failure to provide reasonable and necessary maintenance or to follow the written installation and Operating Instructions.
- 2) Damages caused by services performed by persons other than those authorized by Midea customer service; or external causes such as abuse, misuse, inadequate power supply or acts of God.
- 3) If the unit is put to commercial, business, rental, or other use or application other than for consumer use, we make no warranties, express or implied, including but not limited to, any implied warranty of merchantability or fitness for use or purpose.
- 4) Products without original serial numbers or products that have serial numbers which have been altered or cannot be readily determined.

NOTICE: Some states do not allow the exclusions or limitation of incidental or consequential damages. So this limitation or exclusion may not apply to you.

IF YOU NEED SERVICE

Keep your bill of sale, delivery slip, or some other appropriate payment Record.

The date on the bill establishes the warranty period, should service be required.

If service is performed, it's your best interest to obtain and keep all receipts.

This written warranty gives you specific legal rights. You may also have other rights that vary from state to state.

Service under this warranty must be obtained by following these steps, in order:

- 1) Contact Midea Consumer Services or an authorized Midea services at 1 866 646 4332.
- 2) If there is a question as to where to obtain service, contact our consumer relations Department.



make yourself at home



www.midea.com

© Midea 2025 all rights reserved

CW0011UI-QB(NEW)A

16122000A82395

20250822