

PORTABLE AIR CONDITIONER

USER MANUAL

MAP05S1AWT
MAP07S1AWT



Before using this product, please read this manual carefully and keep it for future reference. The design and specifications are subject to change without prior notice for product improvement. Consult with your dealer or the manufacturer for details.

THANK YOU LETTER

Thank you for choosing Midea! Before using your new Midea product, please read this manual thoroughly to ensure that you know how to operate the features and functions that your new appliance offers in a safe way.

CONTENTS

THANK YOU LETTER	2
SAFETY INSTRUCTIONS	3
BEFORE YOU GET STARTED	8
PRODUCT INSTALLATION	11
OPERATION INSTRUCTIONS	17
REMOTE CONTROL INSTRUCTIONS	19
DRAINAGE GUIDE	34
CLEANING AND MAINTENANCE	35
TROUBLESHOOTING TIPS	37
WARRANTY	38

Read This Manual

Inside you'll find many helpful hints on how to use and maintain your air conditioner properly. Just a little preventative care on your part can save you a great deal of time and money over the life of your air conditioner. You'll find many answers to common problems in the troubleshooting tips - you should be able to fix most of them quickly before calling service. These instructions may not cover every possible condition of use, so common sense and attention to safety is required when installing, operating and maintaining this product.



CAUTION

- For support, please call the Service Center at 1-866-646-4332.
- This appliance is not intended for use by people (including children) with reduced physical, sensory or mental capabilities or lack of experience and knowledge, unless they have been given supervision or instruction concerning use of the appliance by a person responsible for their safety.
- Children should be supervised to ensure that they do not play with the air conditioner.
- The appliance shall be installed in accordance with national wiring regulations.
- Do not operate your air conditioner in a humid room such as a bathroom or laundry room.

SAFETY PRECAUTIONS

Read Safety Precautions Before Operation and Installation

To prevent property damage or injury or death to the user or other people, the following instructions must be followed.

Incorrect operation due to ignoring of instructions may cause death, harm or damage.

Explanation of Symbols



WARNING

This symbol indicates the possibility of personnel injury or loss of life.



CAUTION

This symbol indicates the possibility of property damage or serious consequences.



WARNING

- Installation must be performed according to the installation instructions. Improper installation can cause water leakage, electrical shock, or fire.
- Use only the included accessories and parts, and specified tools for the installation. Using nonstandard parts can cause water leakage, electrical shock, fire, and injury or property damage.
- Make sure that the outlet you are using is grounded and has the appropriate voltage. The power cord is equipped with a three-prong grounding plug to protect against shock. Voltage information can be found on the nameplate of the unit.
- Your unit must be used in a properly grounded wall receptacle. If the wall receptacle you intend to use is not adequately grounded or protected by a time delay fuse or circuit breaker have a qualified electrician install the proper receptacle. (the fuse or circuit breaker needed is determined by the maximum current of the unit. The maximum current is indicated on the nameplate located on unit).
- Do not touch the unit with wet or damp hands or when barefoot.
- If the air conditioner is knocked over during use, turn off the unit and unplug it from the main power supply immediately. Visually inspect the unit to ensure there is no damage. If you suspect the unit has been damaged, contact a technician or customer service for assistance.
- In a thunderstorm, the power must be cut off to avoid damage to the machine due to lightning.
- Your air conditioner should be used in such a way that it is protected from moisture. e.g. condensation, splashed water, etc. Do not place or store your air conditioner where it can fall or be pulled into water or any other liquid. Unplug immediately if it occurs.
- Install the unit on a flat, sturdy surface. Failure to do so could result in damage or excessive noise and vibration.
- The unit must be kept free from obstruction to ensure proper function and to mitigate safety hazards.
- Do not modify the length of the power cord or use an extension cord to power the unit.
- Do not share a single outlet with other electrical appliances. Improper power supply can cause fire or electrical shock.
- Do not install your air conditioner in a wet room such as a bathroom or laundry room. Too much exposure to water can cause electrical components to short circuit.

- Do not install the unit in a location that may be exposed to combustible gas, as this could cause fire.
- The unit has wheels to facilitate moving. Make sure not to use the wheels on thick carpet or to roll over objects, as this could cause the unit to tip over.
- Do not operate a unit that has been dropped or damaged.
- Ensure the unit remains at least 3ft (1m) away from any combustible materials such as bedding, curtains, and furniture
- All wiring must be performed strictly in accordance with the wiring diagram located inside of the unit.
- The unit's circuit board(PCB) is designed with a fuse to provide overcurrent protection. The specifications of the fuse are printed on the circuit board, such as: T 3.15A/250V, etc.
- When the water drainage function is not in use, keep the upper and lower drain plug firmly attached. When the drain plug is not in use, keep it out of reach of children to avoid a choking hazard.

Operation of Current Device

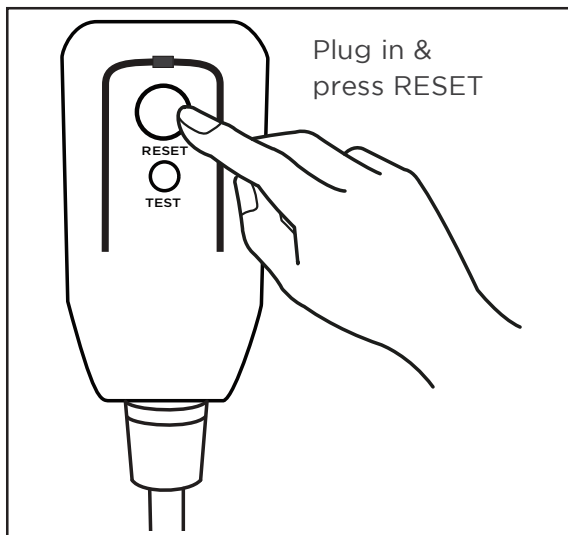

The power supply cord contains a measurement current device that senses damage to the power cord. Test your power supply cord as follows:

1. Plug in the air conditioner.
2. The power supply cord will have TWO buttons on the plug head. Press the TEST button. You will notice a click as the RESET button pops out.
3. Press the RESET Button. You will notice a click as the button engages.
4. The power supply cord is now supplying electricity to the unit. (On some products this is also indicated by a light on the plug head.)

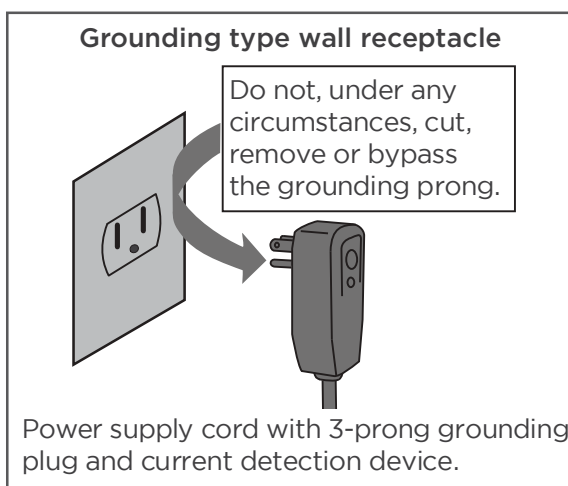

NOTE

The power supply cord with this air conditioner contains a current detection device designed to reduce the risk of fire.

In the event that the power supply cord is damaged, it can not be repaired. It must be replaced with a cord from the manufacturer.

- Do not use this device to turn the unit on or off.
- Always make sure the RESET button is pushed in for correct operation.
- The power supply must be replaced if it fails to reset when either the TEST button is pushed, or it can not be reset. Please contact Customer Service.

CAUTION

- This appliance is not intended for use by persons (including children) with reduced physical, sensory or mental capabilities or lack of experience and knowledge, unless they have been given supervision or instruction concerning use of the appliance by a person responsible for their safety. Children should be supervised to ensure that they do not play with the appliance. Children must be supervised around the unit at all times.
- If the supply cord is damaged, it must be replaced by the manufacturer, its service agent or similarly qualified persons in order to avoid a hazard.
- Do not use this product for functions other than those described in this instruction manual.
- Before cleaning, turn off the power and unplug the unit.
- Disconnect the power if strange sounds, smell, or smoke comes from it.
- Do not press the buttons on the control panel with anything other than your fingers.
- Do not remove any fixed covers. Never use this appliance if it is not working properly, or if it has been dropped or damaged.
- Do not operate or stop the unit by inserting or pulling out the power cord plug.
- Do not use hazardous chemicals to clean or come into contact with the unit. Do not use the unit in the presence of inflammable substances or vapour such as alcohol, insecticides, petrol, etc.
- Prior to cleaning or other maintenance, the appliance must be disconnected from the supply mains.
- Do not remove any fixed covers. Never use this appliance if it is not working properly, or if it has been dropped or damaged.
- Do not run cord under carpeting. Do not cover cord with throw rugs, runners, or similar coverings. Do not route cord under furniture or appliances. Arrange cord away from traffic area and where it will not be tripped over.
- Do not operate unit with a damaged cord, plug, power fuse or circuit breaker. Discard unit or return to an authorized service facility for examination and/or repair.
- To reduce the risk of fire or electric shock, do not use this fan with any solid-state speed control device.
- The appliance shall be installed in accordance with national wiring regulations.
- Contact the authorized service technician for repair or maintenance of this unit.
- Do not cover or obstruct the inlet or outlet grilles.
- Always transport your air conditioner in a vertical position and stand on a stable, level surface during use.
- Always contact a qualified person to carry out repairs. If the damaged power supply cord must be replaced, use a new power supply cord obtained from the product manufacturer. Do not repair the damaged cord.
- Hold the plug by the head of the power plug when taking it out.
- Turn off the product when not in use.



CAUTION:
Risk of fire
flammable materials

IMPORTANT NOTE:Read this manual carefully before installing or operating your new appliance. Make sure to save this manual for future reference.

Explanation of symbols displayed on the unit

	CAUTION	This symbol shows that the operation manual should be read carefully.
	CAUTION	This symbol shows that a service personnel should be handling this equipment with reference to the installation manual.
	CAUTION	This symbol shows that information is available such as the operating manual or installation manual.

! WARNING :

- Servicing shall only be performed as recommended by the equipment manufacturer. Maintenance and repair requiring the assistance of other skilled personnel shall be carried out under the supervision of a person competent in the use of flammable refrigerants.
- DO NOT modify the length of the power cord or use an extension cord to power the unit.
- DO NOT share a single outlet with other electrical appliances. Improper power supply can cause fire or electrical shock.

Please follow the instructions carefully to handle, install, clear, and service the appliance to avoid any damage or hazard.

Flammable

Refrigerant R32 is used within appliance.

- When maintaining or disposing of the appliance, the refrigerant (R32) shall be recovered properly and shall not discharge to air directly.
- Compliance with national gas regulations shall be observed.
- Keep ventilation openings clear of obstruction.
- The appliance shall be stored so as to prevent mechanical damage from occurring.
- The appliance shall be stored in a well-ventilated area where the room size corresponds to the room area as specified for operation.
- Any person who is involved with working on or breaking into a refrigerant circuit should hold a current valid certificate from an industry-accredited assessment authority, which authorizes their competence to handle refrigerants safely in accordance with an industry recognized assessment specification.

Examples for such working procedures are:

- breaking into the refrigerating circuit;
 - opening of sealed components;
 - opening of ventilated enclosures.
-
- No open fire or device like switch which may generate spark/arc shall be around the appliance to avoid causing ignition of the flammable refrigerant used. Please follow the instructions carefully to store or maintain the appliance to prevent mechanical damage from occurring.
 - Do not use means to accelerate the defrosting process or to clean, other than those recommended by the manufacturer.
 - The appliance shall be stored in a room without continuously operating ignition sources (for example: open flames, an operating gas appliance) and ignition sources or (for example: an operating electric heater) close to the appliance.
 - Do not pierce or burn.
 - Be aware that the refrigerants may not contain an odor.

BEFORE YOU GET STARTED



The installation must be carried out in strict accordance with the instructions in this manual.



Installing your AC should take about 30 minutes.



We recommend doing this with a helper.



We're here if you need us, please contact 1-866-646-4332.

! AMBIENT TEMPERATURE RANGE FOR UNIT OPERATING

MODE	Temperature Range
Cool	16-35°C (60-95°F)
Dry	13-35°C (55-95°F)

PRODUCT INSTALLATION LOCATION

Your installation location should meet the following requirements:

- Make sure that you install your unit on an even surface to minimize noise and vibration.
- The unit must be installed near a grounded plug, and the Collection Tray Drain (found on the back of the unit) must be accessible.
- The unit should be located at least 30cm (12") from the nearest wall to ensure proper air conditioning. The air outlet of the unit should be at least 50cm(19.7") away from obstacles.
- DO NOT cover the Intakes, Outlets or Remote Signal Receptor of the unit, as this could cause damage to the unit.

Unit Installation Location Restricted Space Requirements

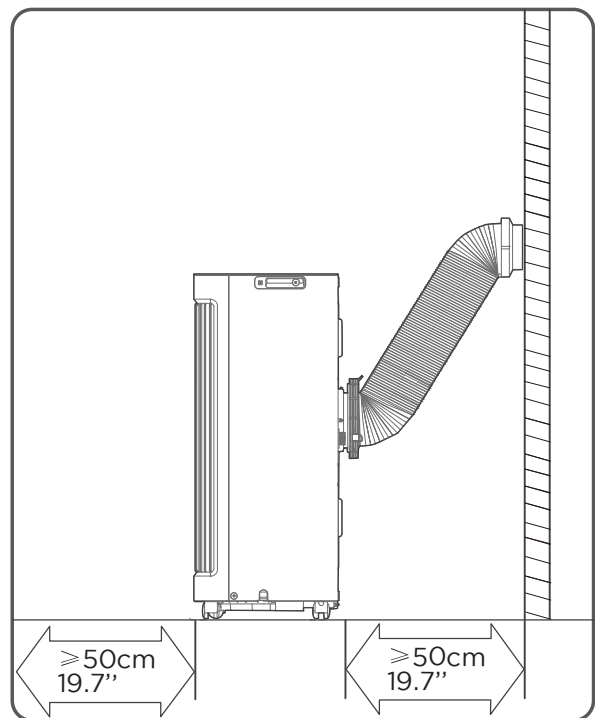
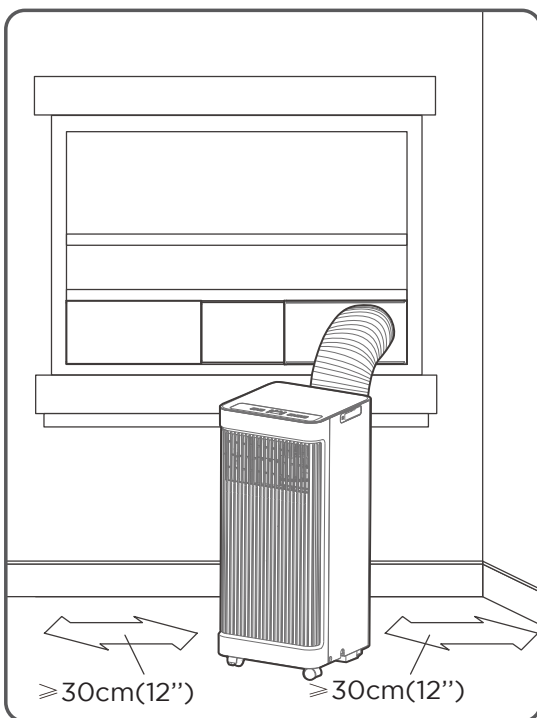

Product overview

NOTE

All the illustrations in the manual are for explanation purpose only. Your machine may be slightly different. The actual shape will remain the same. The unit can be controlled by the unit control panel alone or with the remote control.

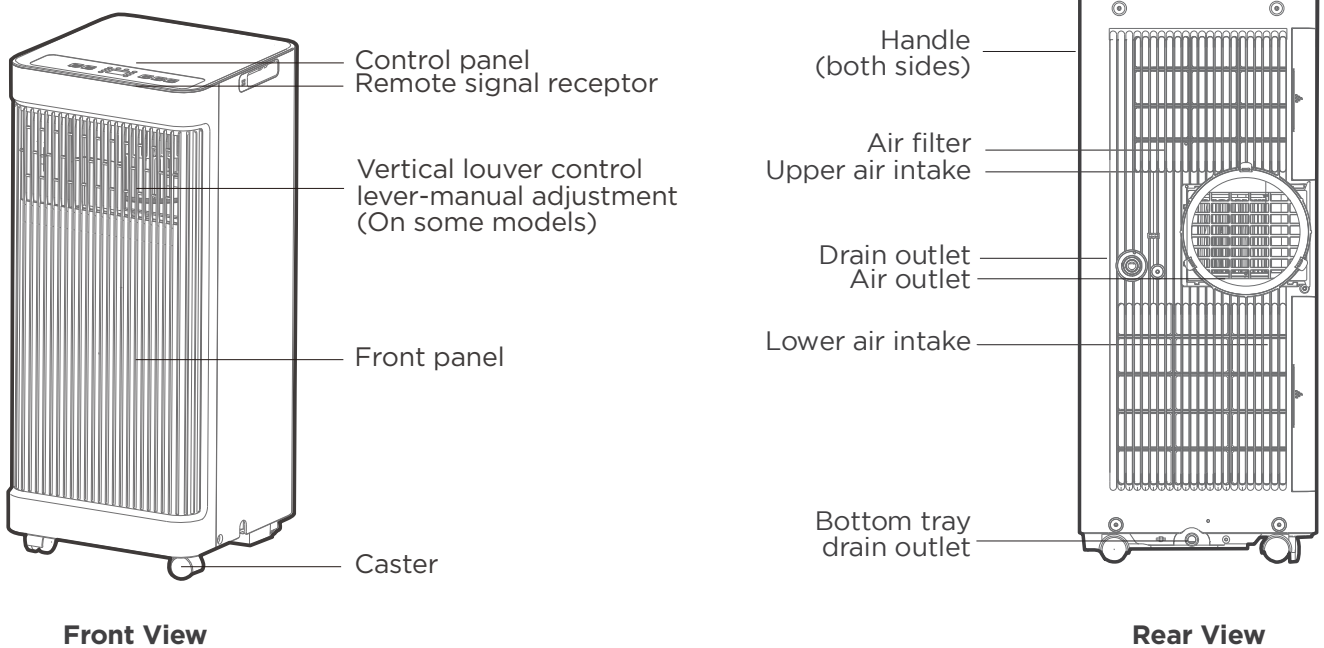

● Design Notice

In order to ensure the optimal performance of our products, the design specifications of the unit and remote control are subject to change without prior notice.

PRODUCT INSTALLATION

Installation Completion Display

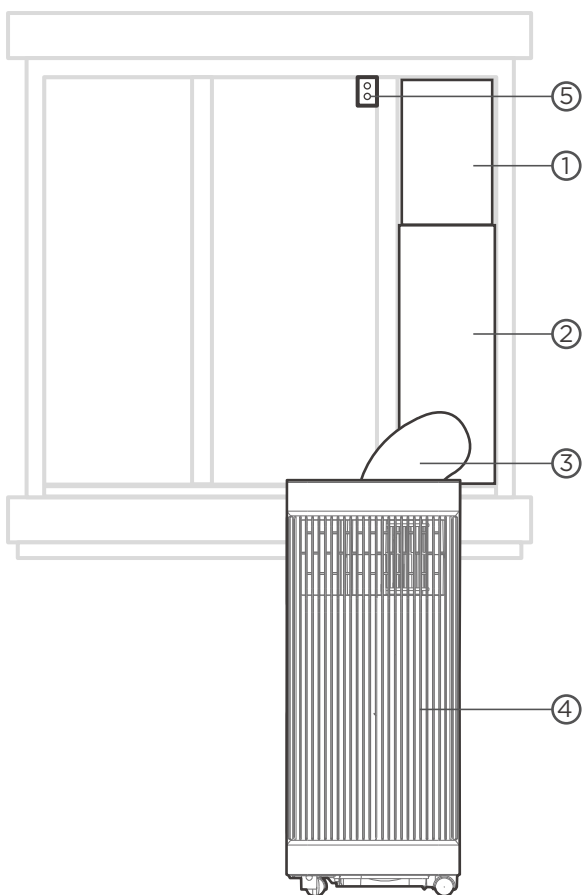

Sliding Window Installation

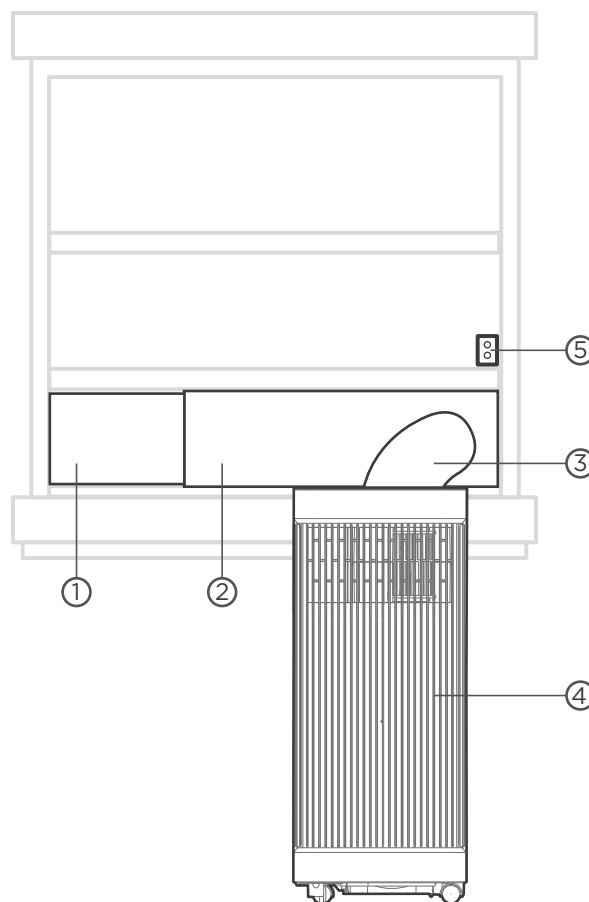

Hung Window Installation

- ① } window slider assembly
- ② }
- ③ Extended Exhaust Hose
- ④ Portable Air Conditioner
- ⑤ Security Bracket and 2 Screws

List of installation tools (not included)



Screwdriver & wrench



Pencil



A tape measure



Scissors or Knife



Saw (On some models, to shorten window adaptor for narrow windows)

Installation accessories

Your Window Installation Kit fits windows 19.4"-62.2" (49.3-158.1cm) and can be shortened for smaller windows.



NOTE

Items with (*) are on some models. Slight variations in design may occur.

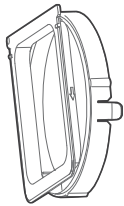

Unit Adaptor (1pc)

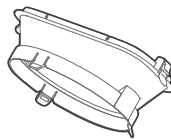

Air exhaust passage(1pc*)



Foam Seal A (Adhesive)
4 pc(*)



Foam Seal B (Adhesive)
2 pc



Foam Seal C (Non-adhesive)
2 pc(*)



Security Bracket and
2 Screws (1 set)



Drain Hose (1pc)

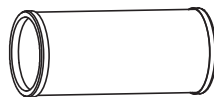

Exhaust Hose

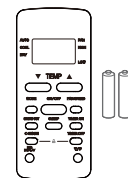

Remote Controller
and Battery (only
for remote control
models)(1set*)



Bolt (3pc*)



Window
Slider A (1pc)

Window
Slider B (1pc)

Window
Slider C (1pc*)

Window
Slider D (1pc*)

Confirm your window type (window type and opening size of different types)

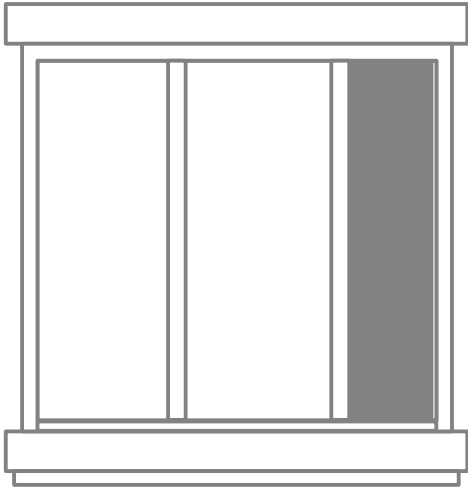

Sliding Window Installation

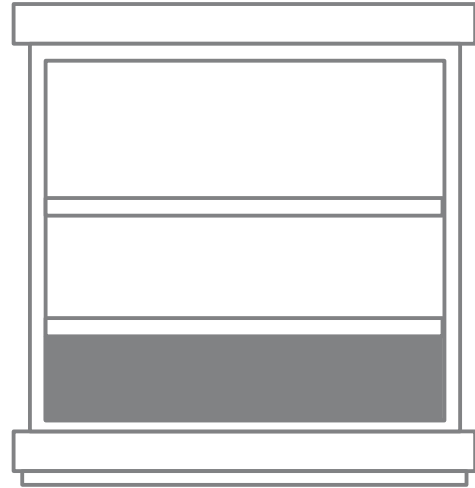

Hung Window Installation

For optimal performance in operation

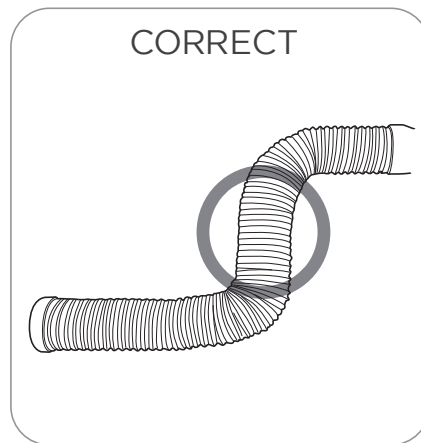
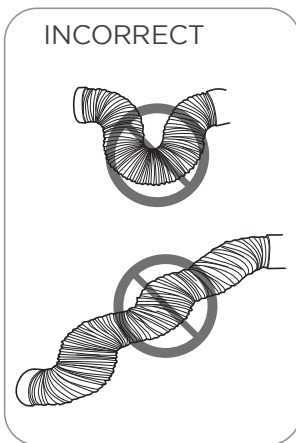

NOTE:

To ensure proper function, DO NOT overextend or bend the hose. Make sure that there is no obstacle around the air outlet of the exhaust hose (in the range of 500mm) in order to ensure the exhaust system works properly. All the illustrations in this manual are for explanation purpose only. Your air conditioner may be slightly different. The actual shape will remain the same.

Exhaust hose and adaptors installation

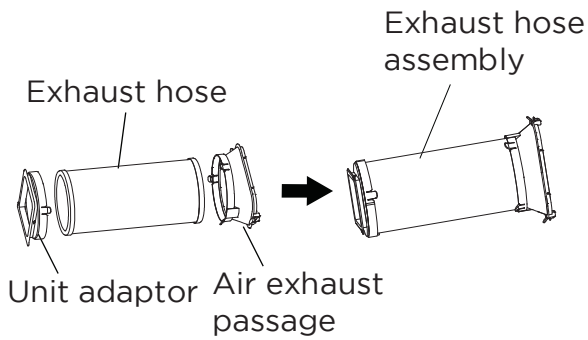

1. The Exhaust Hose assembly installation (window type)

Press the exhaust hose(or extended exhaust hose) into the window slider adaptor and unit adaptor. The pieces will clip together using the tabs on the adaptors.



NOTE: Please install the exhaust hose assembly according to the fittings in your kit.

Connect the adaptor to the unit and the window

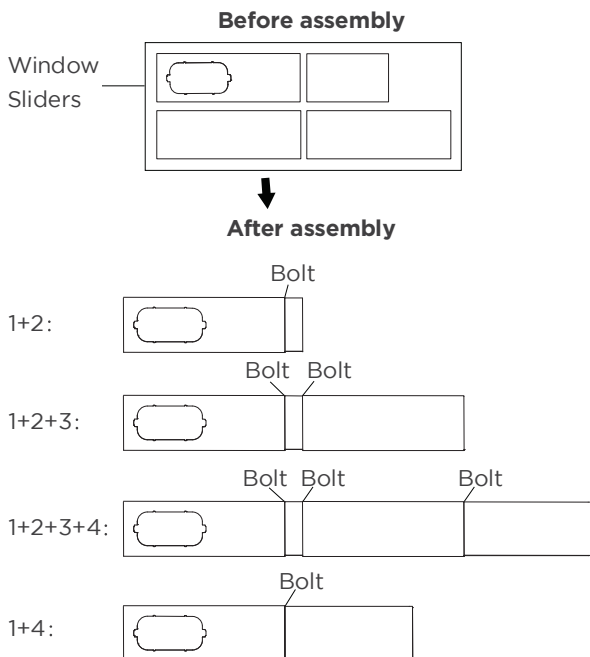

2. Preparing the Adjustable Window Slider

Choose the window sliders according to the size of your window. Some of the sliders may need to be cut to fit the exact window size, make sure to cut the sliders carefully if this is required.

Use bolts to fasten the window sliders once they are adjusted to the proper length.



NOTE: Please base your window slider installation on the accessories in your kit and the size of your window.

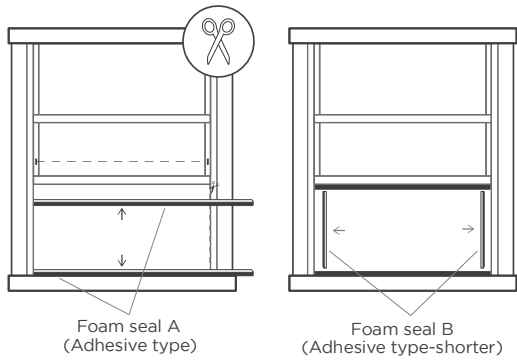

Hung Window Installation

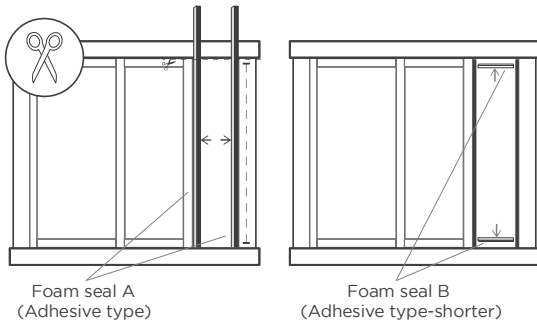

Sliding Window Installation



NOTE: Once the exhaust hose assembly and adjustable window slider are prepared, choose one of the two installation methods based on your window type.

3. Complete sealing of window

Cut the adhesive foam seal A and B strips to the proper lengths, and attach them to the window sash and frame as shown.

4. Hung Window Installation

Step 1:

Insert the window slider assembly into the window opening.

Step 2:

Cut the non-adhesive foam seal C strip to match the width of the window. Insert the seal between the glass and the window frame to prevent air and insects from getting into the room.

Step 3:

If desired, install the security bracket with 2 screws as shown.

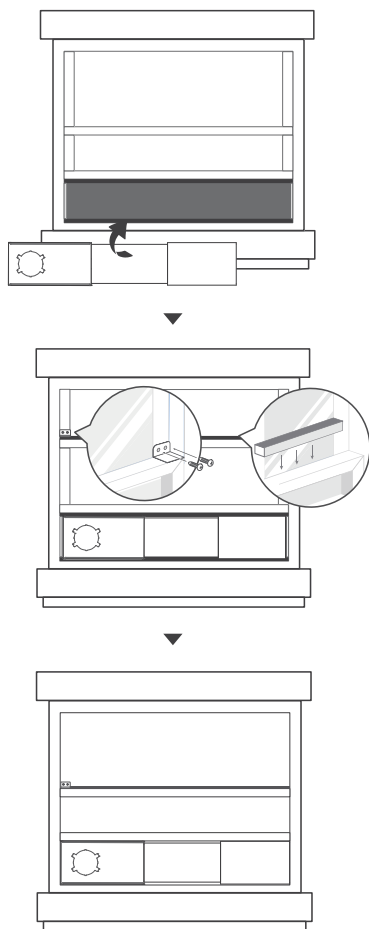

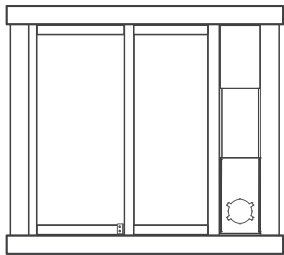
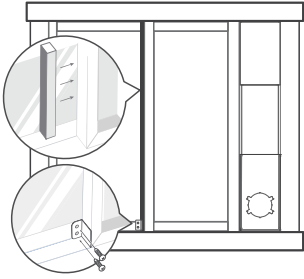
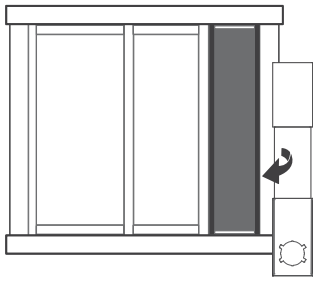

5. Sliding Window Installation

Step 1:

Insert the window slider assembly into the window opening.

Step 2:

Cut the non-adhesive foam seal C strip to match the height of the window. Insert the seal between the glass and the window frame to prevent air and insects from getting into the room.

Step 3:

If desired, install the security bracket with 2 screws as shown.

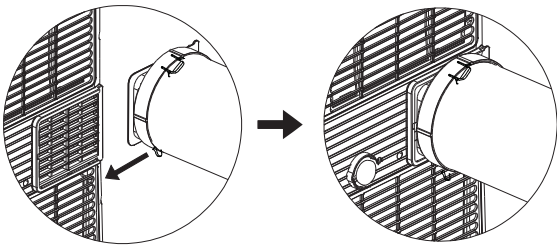

6. Install the exhaust hose assembly to the unit

Push the exhaust hose into the air outlet opening of the unit along the arrow direction.

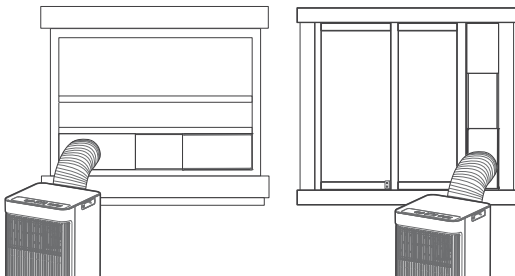

Hung Window Installation

Sliding Window Installation

7. Connect the adaptor to the unit and the window

Insert the window slider adapter into the hole of the window slider.

OPERATION INSTRUCTIONS

Electronic control operating instructions

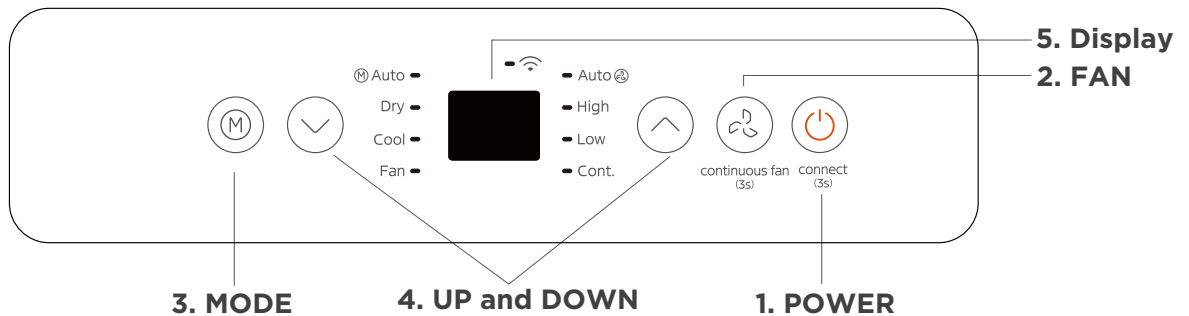

1. POWER button

Power switch on/off.

Wireless operation (on some models)

Used to initiate the wireless connection mode. For the first time using the wireless function, press the POWER button for 3 seconds to initiate the wireless connection mode. The LED DISPLAY shows 'AP' to indicate you can set wireless connection. If connection (router) is successful within 8 minutes, the unit will exit wireless connection mode automatically and the wireless indicator illuminates. If connection fails within 8 minutes, the unit exits wireless connection mode automatically. After wireless connection is successful, for some models you can press MODE and UP (+) buttons at the same time for 3 seconds to turn off wireless function and the LED DISPLAY shows 'OF' for 3 seconds, press MODE button and UP (+) to turn on wireless function and the LED DISPLAY shows 'On' for 3 seconds.

NOTE: When you restart the wireless function, it may take a period of time to connect to the network automatically.

2. FAN button

Press to control the fan speed in four steps: AUTO, HIGH, LOW, and CONT. The fan speed indicator light illuminates under different fan settings.

Continuous Fan function

In COOL or DRY mode, press the Fan button for 3 seconds to turn on or off the continuous fan function. When the function is turned on, the Cont. fan light will illuminate, indicating the fan will run continuously. When the function is turned off, the Cont. fan light will go out, indicating that the fan will stop when the compressor stops.

3. MODE button

Selects the appropriate operating mode. Each time you press the button, the mode is selected in a sequence that goes from AUTO, DRY, COOL and FAN. The mode indicator light illuminates under the different mode setting.

NOTE: In AUTO mode, the FAN speed will be adjusted automatically.

AUTO mode

Press the "MODE" button until the "Auto" indicator light comes on. In this mode, the fan speed or the temperature will be adjusted automatically.

COOL mode

Press the "MODE" button until the "COOL" indicator light comes on. Press the UP and DOWN buttons "∨" or "∧" to select your desired room temperature. The temperature can be set within a range of 16°C-30°C/60°F-86°F. Press the "FAN" button to choose the fan speed.

DRY mode

Press the "MODE" button until the "Dry" indicator light comes on. In this mode, the fan speed or the temperature cannot be adjusted. The fan motor operates at Auto speed.

NOTE: Keep windows and doors closed for the best dehumidifying effect. Do not put the duct to window.

FAN mode

Press the "MODE" button until the "FAN " indicator light comes on.

Press the "FAN SPEED" button on the remote controller to choose the fan speed. The temperature can not be adjusted.

Do not put the duct to window.

4. UP and DOWN buttons

Used to adjust (increasing/decreasing) temperature settings in 1°C/2°F (or 1°F) increments in a range of 16°C/60°F to 30°C/88°F (or 86°F).

NOTE: The control is capable of displaying temperature in degrees Fahrenheit or degrees Celsius. To convert from one to the other, press and hold the Up and Down buttons at the same time for 3 seconds.

5. Display

Shows the set temperature while on Cool, or Auto mode. It shows the room temperature on DRY and FAN modes.

Shows Error codes:

EH00-EEPROM error.

EH60-Room temperature sensor error.

EH61-Evaporator temperature sensor error.

EC52-Condenser temperature sensor error (on some models).

EH0b-Display panel communication error.

EC-Refrigerant leakage detection malfunction(on some models).

Shows protection code:

P1-Bottom tray is full--Connect the drain hose and drain the collected water away. If protection repeats, call for service.

NOTE: When one of the above malfunctions occurs, turn off the unit, and check for any obstructions. Restart the unit, if the malfunction is still present, turn off the unit and unplug the power cord. Contact the manufacturer, its service agents or a similar qualified person for service.

6. Other features

COMFORTSENSE feature (On some models)

This feature can be activated from the remote control ONLY. There is no indicator light on the control panel. The remote control serves as a remote thermostat allowing for the precise temperature control at its location. To activate the ComfortSense feature, point the remote control towards the unit and press the ComfortSense button. The remote control will send this signal to the AC until the ComfortSense button is pressed again. If the unit does not receive the ComfortSense signal during any 7 minute interval, the unit will exit the ComfortSense mode.

NOTE: This feature is unavailable under FAN or DRY mode.

REMOTE CONTROL INSTRUCTIONS

Handling the Remote Control

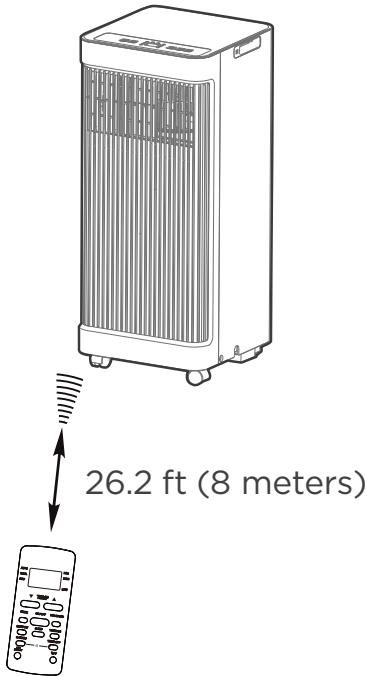

Location of the remote control

Use the remote controller within a distance of 26.2 ft (8 meters) from the air conditioner, pointing it towards the receiver. Reception is confirmed by a beep.

⚠ CAUTION

- The air conditioner will not operate if curtains, doors or other materials block the signals from the remote control to the unit.
- Prevent any liquid from spilling onto the remote control. Do not expose the remote control to direct sunlight or heat.
- If the infrared signal receiver on the indoor unit is exposed to direct sunlight, the air conditioner may not function properly.
- If other electrical appliances react to the remote control, either move these appliances or consult your local dealer.

NOTICE

- Button design is based on typical model and may vary slightly from the actual one you purchased.
- All of the features listed in "Operating Instructions" can be operated using the buttons on the control panel of the unit. If there is a feature listed in the "Operating Instructions" that does not appear on your unit's control panel, then the unit does not have that feature. If the remote control has a button for the missing feature, the unit will still not respond when the button on the remote is pressed.
- When there are significant differences between features or operation implied by the remote control illustration and the actual functions described in the USER'S MANUAL, the descriptions in the USER'S MANUAL should be followed.



NOTE: Some features such as ComfortSense, Timer, and Sleep Mode are only available using the remote control. There will be no corresponding button for these features on the control panel.

Remote Controller Specifications

Rated Voltage: 3.0V (Dry batteries R03/LR03x2)

Environment: 23°F ~140°F (-5°~60°)

Function Buttons

TEMP DOWN Button

Press this button to decrease the indoor temperature setting.

TEMP UP Button

Press this button to increase the indoor temperature setting.

ON/OFF Button

Operation starts when this button is pressed and stops when the button is pressed again.

MODE Button

Press this button to select the desired operation mode.

SHORT CUT Button

Sets and activates your favorite pre-settings.

COMFORTSENSE Button

Press this button to active the ComfortSense mode, to optimize the temperature around you and ensure maximum comfort.

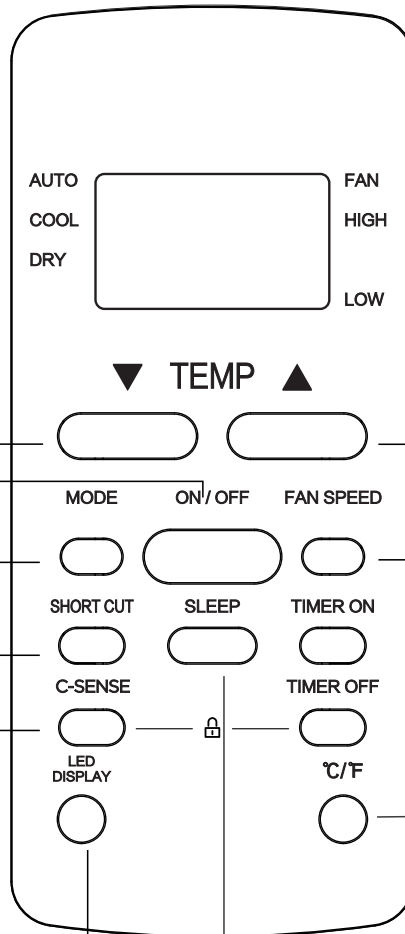

SPEED Button

Used to select the desired fan speed.

TIMER Button

Press this button to activate the “Auto Start” or “Auto Stop” program.

°C/°F Button

Press this button to change the temperature display between Celsius and Fahrenheit

SLEEP Button

Press this button to activate the Sleep mode. This function is available on COOL or AUTO mode only and will maintain the most comfortable temperature for you while saving energy.

LED DISPLAY Button

Turns the unit’s LED display on/off

Remote Screen Indicators

Information is displayed when the remote controller is powered up.

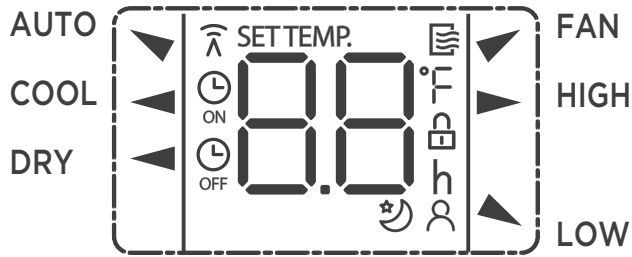

Mode display

AUTO ▼ COOL ◀ DRY ◀
 ▲ FAN

 Displayed when data transmitted.

 Appears when the remote is enabled and can send a signal to the unit. If you would like to turn the remote off without affecting the unit, point the remote away from the unit and press the ON/OFF button. To turn the remote on, point the remote away from the unit and press the ON/OFF button. The unit will not receive commands from the remote if this indicator is not illuminated.

 ON Displayed when TIMER ON time is set

 OFF Displayed when TIMER OFF time is set

 Shows set temperature or room temperature, or time under TIMER setting

 Indicates all the current settings are locked

 Displayed when ComfortSense feature is activated (some units)

 Displayed when SLEEP feature is activated

Fan speed indication

▶ HIGH High speed

▲ LOW Low speed

NO display Auto fan speed

Note:

All indicators shown in the figure are for the purpose of clear presentation. But during the actual operation, only the relative function signs are shown on the display window.

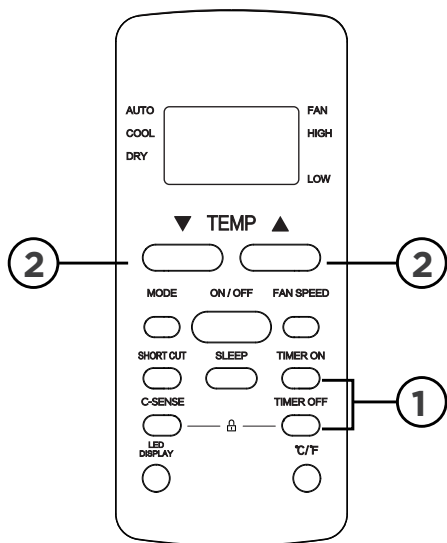

TIMER OPERATION

Press the TIMER button to initiate the Auto-start and Auto-stop setting program of the unit.

To set the Auto-start/stop time.

1. Press the TIMER button, when the TIMER ON indicator is displayed on the LED window of the air conditioner, it indicates the Auto Start setting program is initiated. When the TIMER OFF indicator is displayed on the LED window of the air conditioner, it indicates the Auto Stop setting program is initiated.
2. Press or hold the TEMP UP (▲)/DOWN (▼) to change the Auto time. The control will count down the time remaining until start/stop.
3. The selected time will register in 5 seconds and the air conditioner will automatically revert back to display the previous temperature setting.
4. Turning the unit ON or OFF at any time will cancel the Auto Start/stop function.

NOTES

To cancel the TIMER setting, push the TIMER button and press or hold the TEMP UP (▲)/DOWN (▼) until 0 hour is displayed on the LCD window of the air conditioner.

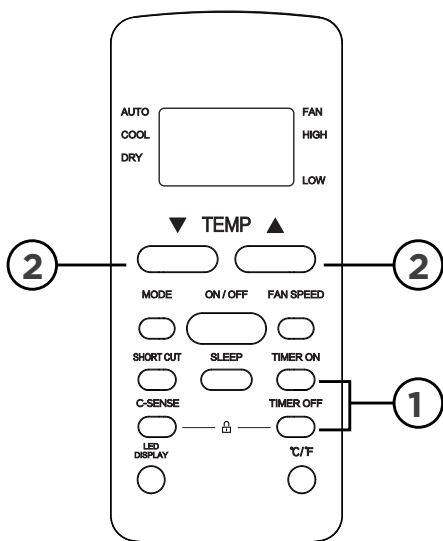

COMBINED TIMER

(Setting both ON and OFF timers simultaneously)

AUTO STOP > AUTO START

(On > Stop > Start operation)

This feature is useful when you want to stop the air conditioner after you go to bed, and start it again in the morning when you wake up or when you return home.

Example:

To stop the air conditioner 2 hours after setting and start it again 10 hours after setting.

1. Press the TIMER button until the TIMER OFF indicator is displayed on the LED display of the air conditioner.
2. Use the TEMP UP (^)/DOWN (v) button to display "2.0" on the LED display of the air conditioner.
3. Press the TIMER button again to display the TIMER OFF on the LED display of the unit.
4. Use the TEMP UP (^)/DOWN (v) button to display "10" on the LED display of the unit.
5. Wait for 5 seconds until the previous display appears in LED window.

AUTO START > AUTO STOP

(Off > Start > Stop operation)

This feature is useful when you want to start the air conditioner before you wake up and stop it after you leave the house.

Example:

To start the air conditioner 5 hours after setting, and stop it 8 hours after setting.

1. Press the TIMER button until the TIMER ON indicator is displayed on the LED display of the air conditioner.
2. Use the TEMP UP (^)/DOWN (v) button to display "5.0" on the LED display of the air conditioner.
3. Press the TIMER button again to display the TIMER OFF on the LED display of the unit.
4. Use the TEMP UP (^)/DOWN (v) button to display "8.0" on the LED display of the unit.
5. Wait for 5 seconds until the previous display appears in LED window.

Timer Functions

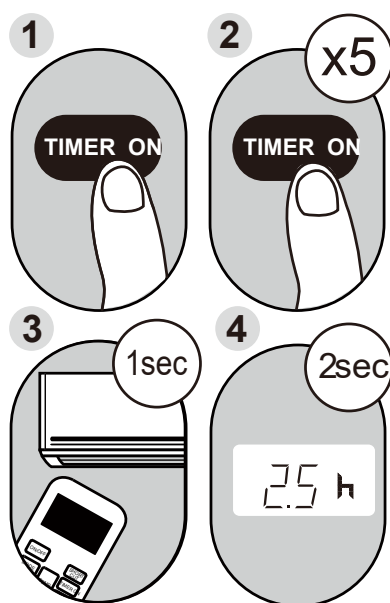

Example: Setting unit to turn on after 2.5 hours.

Your air conditioning unit has two timer-related functions:

TIMER ON - sets the amount of time after which the unit will automatically turn on.

TIMER OFF - sets the amount of time after which the unit will automatically turn off.

TIMER ON function

The TIMER ON function allows you to set a period of time after which the unit will automatically turn on, such as when you come home from work.

1. Press the TIMER ON button. By default, the last time period that you set and an “h” (indicating hours) will appear on the display.

NOTICE

This number indicates the amount of time after the current time after which you want the unit to turn on. For example, if you set TIMER ON for 2 hours, “2.0h” will appear on the screen, and the unit will turn on after 2 hours.

2. Press the TIMER ON button repeatedly to set the amount of time after the current time you want the unit to turn on.
3. Wait 2 seconds, then the TIMER ON function will be activated. The digital display on your remote control will then return to the temperature display.

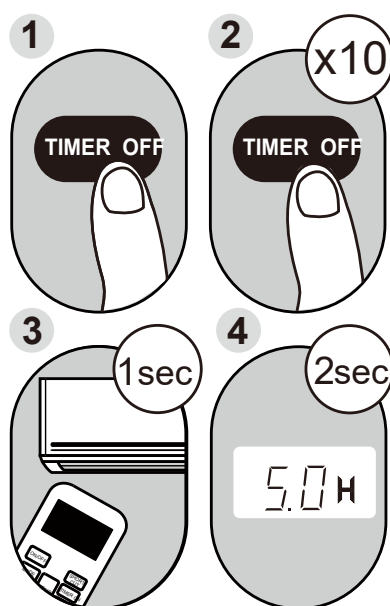

Example: Setting unit to turn off after 5 hours.

TIMER OFF function

The TIMER OFF function allows you to set a period of time after which the unit will automatically turn off, such as when you wake up.

1. Press the TIMER OFF button. By default, the last time period that you set and an “h” (indicating hours) will appear on the display.

NOTICE

This number indicates the amount of time after the current time after which you want the unit to turn off. For example, if you set TIMER OFF for 2 hours, “2.0h” will appear on the screen, and the unit will turn off after 2 hours.

2. Press the TIMER OFF button repeatedly to set the time that you want the unit to turn off.

Timer Functions (cont.)

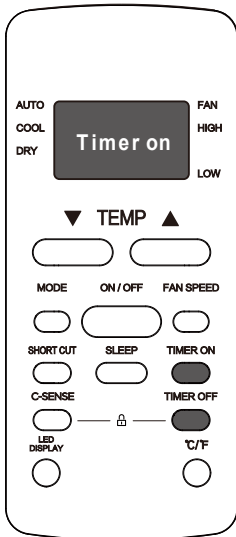

Continue to press **TIMER ON** or **TIMER OFF** until desired time is reached.

- Wait 2 seconds, then the **TIMER OFF** function will be activated. The digital display on your remote control will then return to the temperature display.

NOTE

When setting the **TIMER ON** or **TIMER OFF** functions, up to 10 hours, the time will increase in 30 minute increments with each press. After 10 hours and up to 24, it will increase in 1 hour increments. The timer will revert to zero after 24 hours.

You can turn off either function by setting the timer to "0.0h".

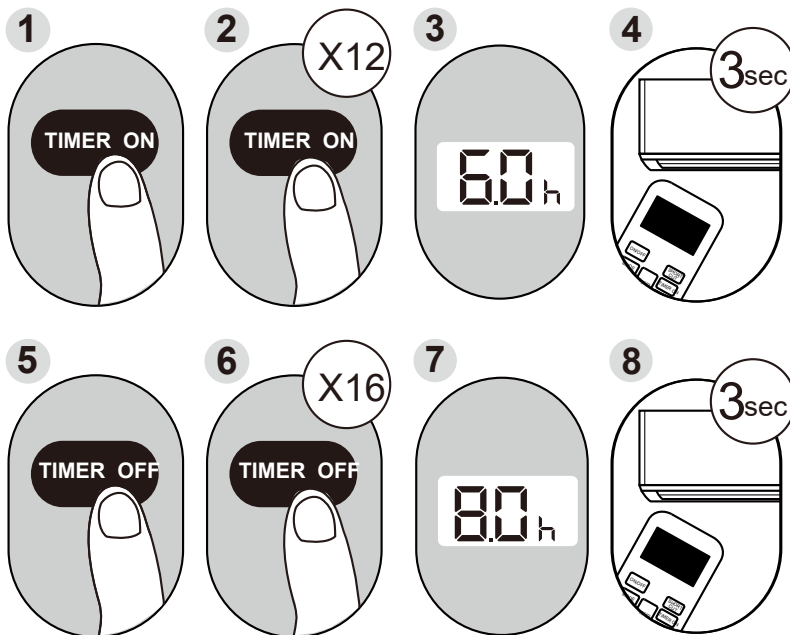

Setting both **TIMER ON** and **TIMER OFF** at the same time

Keep in mind that the time periods you set for both functions refer to hours after the current time.

For example, say that the current time is 1:00 PM, and you want the unit to turn on automatically at 7:00 PM and want it to operate for 2 hours, then automatically turn off at 9:00 PM.

Do the following (side figure):

Example: Setting the unit to turn on after 6 hours, operate for 2 hours, then turn off (see the figure below)

Your remote display

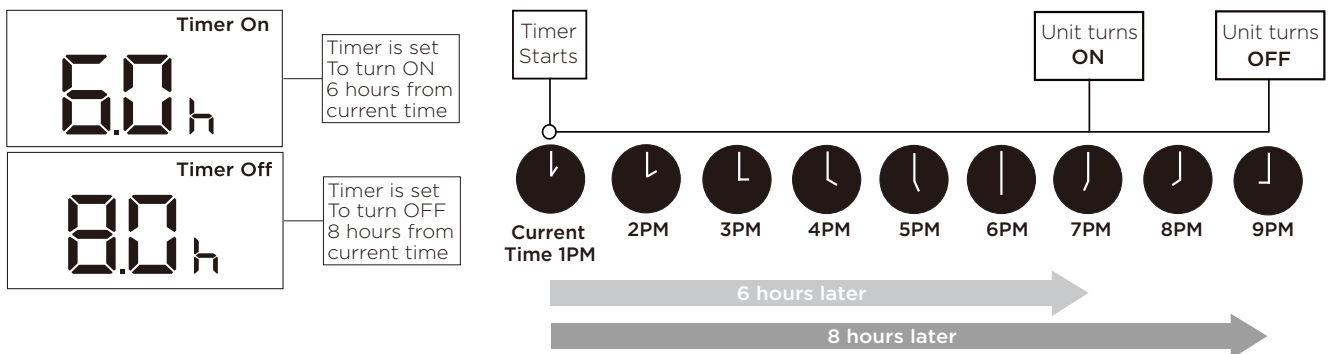

NOTES

- Button design is based on a typical model and may slightly vary from the actual one you purchased.
- This device complies with part 15 of the FCC Rules. Operation is subject to the following two conditions: (1) This device may not cause harmful interference, and (2) this device must accept any interference received, including interference that may cause undesired operation.
- This equipment has been tested and found to comply with the limits for a Class B digital device, pursuant to part 15 of the FCC Rules. These limits are designed to provide reasonable protection against harmful interference in a residential installation. This equipment generates, uses and can radiate radio frequency energy and, if not installed and used in accordance with the instructions, may cause harmful interference to radio communications. However, there is no guarantee that interference will not occur in a particular installation. If this equipment does cause harmful interference to radio or television reception, which can be determined by turning the equipment off and on, the user is encouraged to try to correct the interference by one or more of the following measures:
 - Reorient or relocate the receiving antenna.
 - Increase the separation between the equipment and receiver.
 - Connect the equipment to an outlet on a circuit different from that to which the receiver is connected.
 - Consult the dealer or an experienced radio/TV technician for help.
 - Changes or modifications not approved by the party responsible for compliance could void users authority to operate the equipment.

Battery Warning:

Do not mix old and new batteries and Do not mix alkaline, standard (carbon-zinc) or rechargeable (ni-cad, ni-mh, etc.) batteries

Supplier's Declaration of Conformity 47 CFR § 2.1077 Compliance Information

Unique Identifier: Midea brand, RG51H2(2)/CEFU1-M

Responsible Party U.S. Contact Information

Midea America Corporation
300 Kimball Dr
Parsippany NJ
07054

Telephone number or internet contact information: Midea.com/us

FCC Compliance Statement (products subject to Part 15)

This device complies with Part 15 of the FCC Rules. Operation is subject to the following two conditions: (1) This device may not cause harmful interference, and (2) this device must accept any interference received, including interference that may cause undesired operation.

APP INSTRUCTIONS

Specification of Wireless Module

Wireless Module Model: US-SK109	Operation Temperature: 0°C ~ 45°C / 32°F ~ 113°F
Antenna Type: Printed PCB Antenna	Operation Humidity: 10% ~ 85%
Frequency Band: 2400 - 2483.5MHz	Power Input: DC 5V / 500 mA
	Maximum TX Power: < 20dBm

Precautions

1. Supports operating systems: iOS 10+ or Android 5+.
2. In the event of a OS update, there may be a delay between the update of the OS and a related software update during which your OS may or may not be supported until a new version is released. Your specific mobile phone or problems in your network may prevent the system from working and Midea will not be responsible for any problems that could be caused by incompatibility or network issues.
3. This Smart AC only supports WPA-PSK/WPA2-PSK (recommended) encryption.
4. To ensure proper scanning of the QR code, your smart phone must have at least a 5-megapixel camera.
5. Due to unstable network connectivity, requests may time out. If this happens, re-run the network configuration.
6. Due to unstable network connectivity, commands may time out. If this happens, the smartphone app and the actual product may display conflicting. The information displayed on the actual product is always the most accurate available. Refresh the app to re-sync.

NOTE

Midea will not be responsible for any problems that could be caused by incompatibility or network issues, your wireless router and mobile phone.

1. How to Use SmartHome App

 Ensure that your mobile phone is connected to the wireless network. Bluetooth must be turned on. The device must also be powered up.

STEP 1: Download the SmartHome App

Scan the QR code below to download the SmartHome app from the app store or search for it directly on the Google Play Store or Apple's App Store.

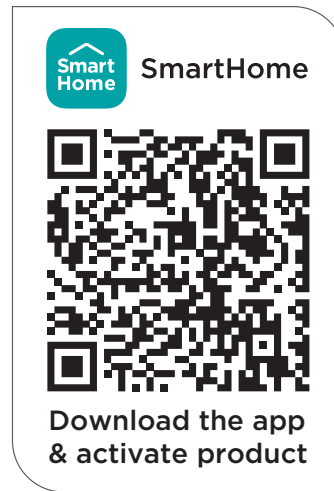

STEP 2: Log in

Open the SmartHome app. Log in directly if you have an existing SmartHome account or create a new account. Alternatively, you can also use a 3rd party login platform.

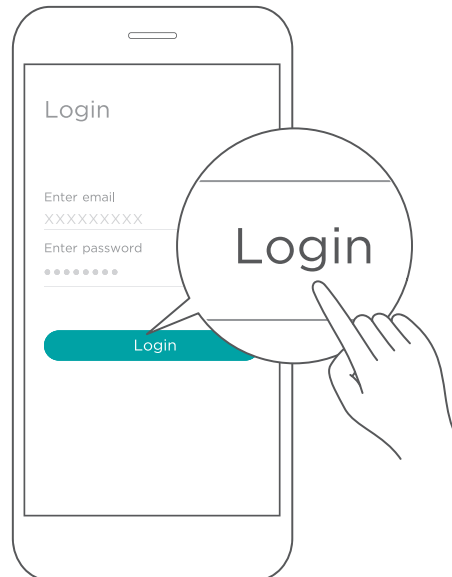

STEP 3: Connecting the Device

- 1) When you log in, you may see the message "Smart devices discovered nearby". Tap to add your device.

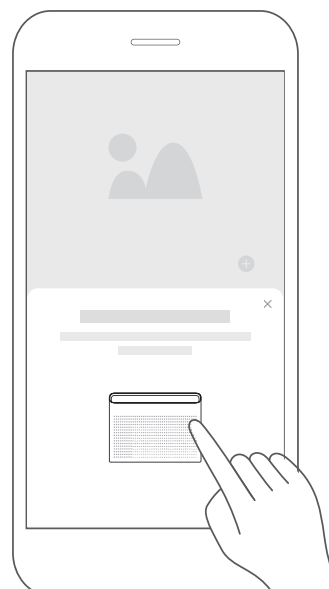

2) If no such message appears, proceed as follows: Tap on “+” and select your device in the list of nearby available devices.

If your device is not listed, please add your device manually, first selecting the device category e.g. Window AC.

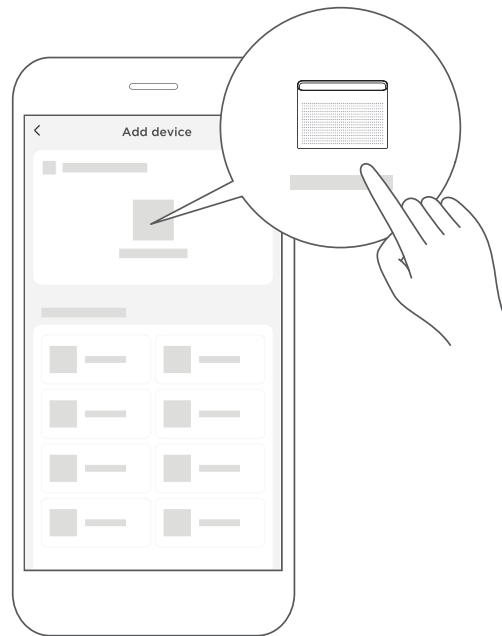

3) Follow the steps in the app to connect your device to the wireless network. If your device fails to connect, follow the additional instructions in the app.

For Window AC

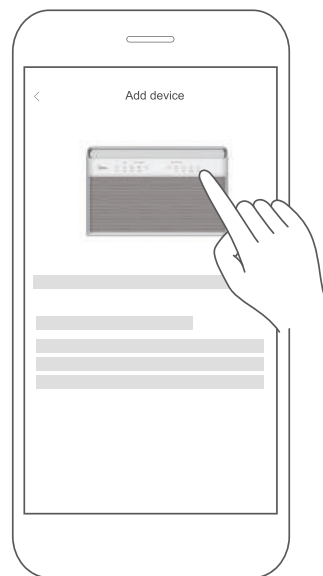

For Portable AC



STEP 4: Controlling the Device

After pairing successfully, a card will be created for the device in the SmartHome app.

Shortcuts for basic functions will appear on the card such as changing the temperature or switching the device on or off.

Tapping on the card, will reveal additional features and settings. The actual UI design may look different from examples due to app updates.

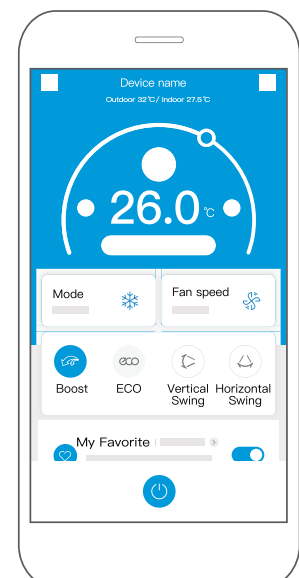
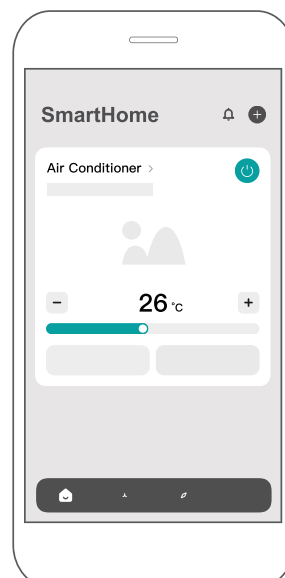

2. How to Use Matter

Matter is a connectivity technology that unifies the smart home by allowing devices and ecosystems (such as Alexa, Google Home and Apple Home) to speak the same language thus creating exciting new features and use cases.

To use Matter, you will need at least one Matter enabled smart speaker from Amazon, Google or Apple, and it's respective app.

- If you have a Matter enabled smart speaker, please proceed to the “How to use Matter” instructions on the following pages.
- If you don't have a Matter enabled smart speaker, you won't be able to use Matter right now. However, you can still achieve full functionality of the product by using our SmartHome app. To do this, proceed to the “How to use SmartHome app” section back on page 20.

Connect Your Air Conditioner Through Matter



Make sure your mobile device is connected to your wireless router.

Wireless router should support and turn on IPv6. Please make sure your smartphone connect to 2.4G but not 5G network.

STEP 1: Connect to Smart Speakers

Select your preferred ecosystems (Alexa, Google Home or Apple Home) and make sure you've got one of their Matter enabled products (such as their smart speakers) connected to your wireless router.

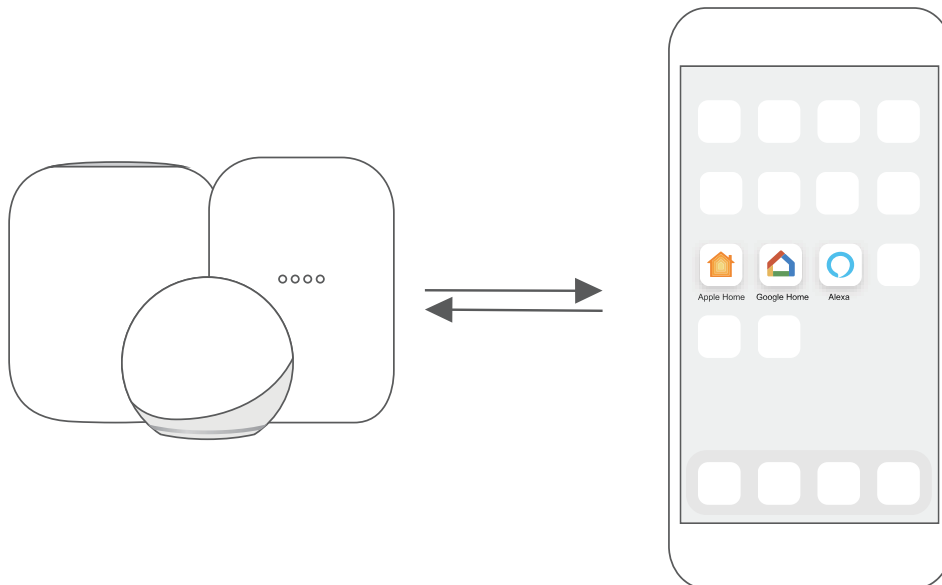

STEP 2: Turn On Bluetooth

Turn on Bluetooth on your mobile device.

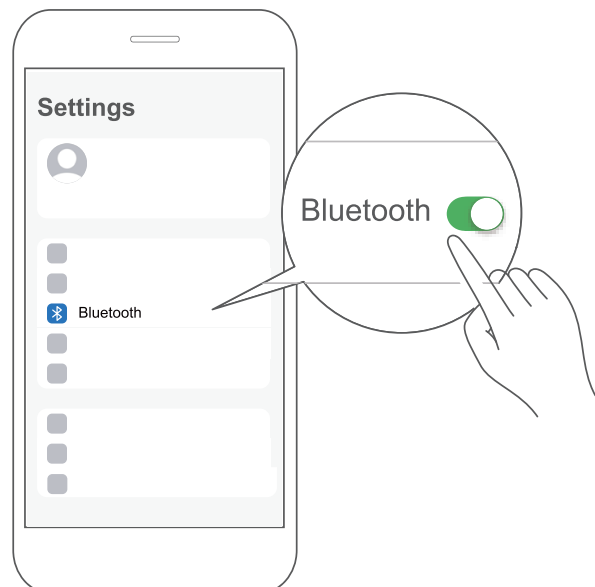

STEP 3: Enter AP Mode

Windows AC: Hold down the CONNECT / Power button for 3 seconds to begin the pairing process ("AP" will appear on the AC's display).

Portable AC: Hold down the SWING / Power button for 3 seconds to begin the pairing process ("AP" will appear on the AC's display).

NOTE

Entering AP pairing mode may vary between different AC models, please follow the instructions of the AC panel.

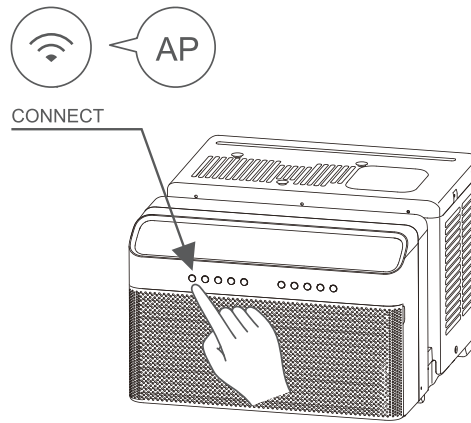

Window AC

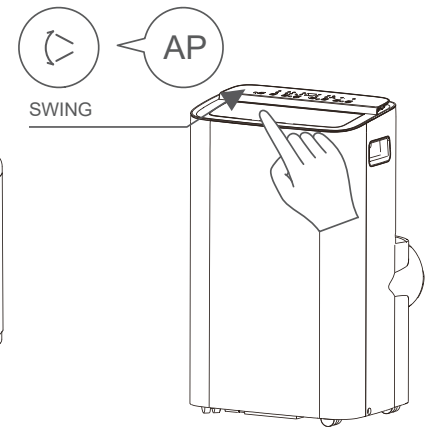

Portable AC

STEP 4: Open App

Open the Alexa, Google Home or Apple Home app on your mobile device.

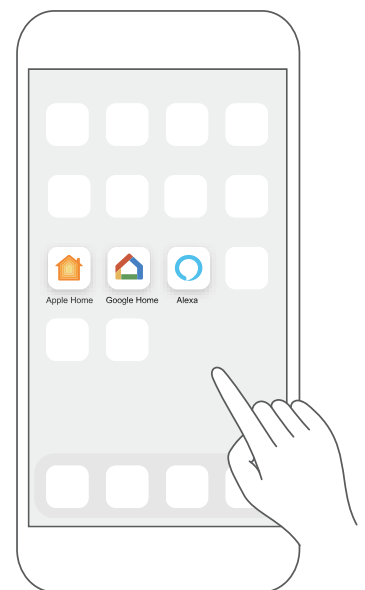

STEP 5: Scan Matter QR code

Tap the "+" and "Add Device/Accessory" or tap "+Add" in your app and then select Matter device and scan the Matter QR code found on the side of the AC device.

Follow the respective instructions in the Alexa, Google Home or Apple Home app to complete the pairing process.

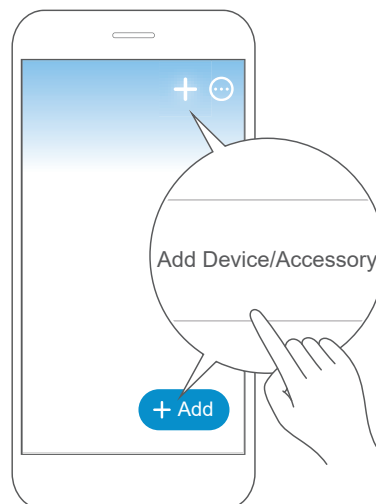

STEP 6: Control Device

After pairing is successful, you can control your AC's temperature and mode settings, etc. through the respective ecosystem app and smart speaker.

Due to a compatibility issue, the temperature value shown in the Alexa, Google Home or Apple Home app may be 1 degree different from that displayed on the air conditioner. However, this will not impact the device's ability to cool the room.

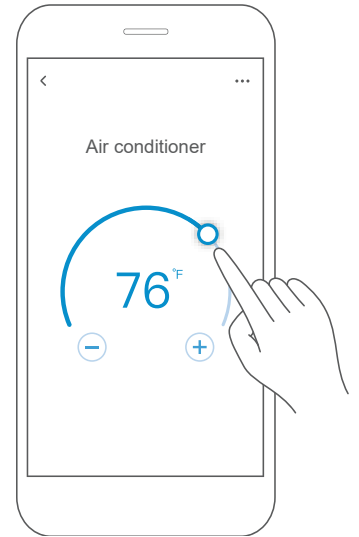
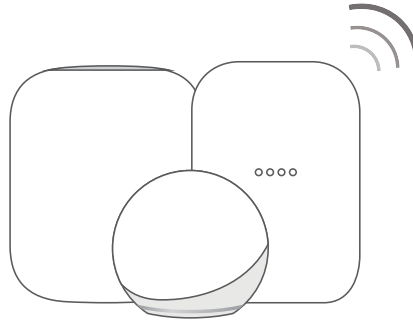

App & Smart Speakers can support Matter only when using these versions or above.

Device	Version
iPhone	iOS16.5
Apple Home Pod	16.5
Android	Google Play services min version: 22.36.15 Google Home app (GHA) min version: 2.58.24.1 - dogfood
Google Home Hub	Google Hub fi rmware min version: 1.56.324896 (appears on hub as Chromecast fi rmware version)
Alexa App	2.2.536317
Alexa Echo Device	9094439556

NOTE

- Setup processes and features may vary between ecosystems.
- The functions shown in the Alexa, Google Home or Apple Home apps may change with updates to their products or apps.
- Make sure the Matter enabled app is up to date to ensure the best experience.
- Periodically, we will update the device's software to improve the experience. Device software updates can be accomplished through the SmartHome app.
-  **matter** is developed by the Connectivity Standards Alliance TM. This brand, related logos, and marks are trademarks of the Alliance, all rights reserved.
- Use of the Works with Apple badge means that an accessory has been designed to work specifically with the technology identified in the badge and has been certified by the developer to meet Apple's performance standards. Apple is not responsible for the operation of this device or its compliance with safety and regulatory standards.

Declaration of Conformity

FCC ID: 2ADQOMDNA23

IC: 12575A-MDNA23

This device complies with Part 15 of the FCC Rules and Industry Canada's licence exempt RSSs.

Operation is subject to the following two conditions:

- (1) This device may not cause interference;
- (2) This device must accept any interference, including interference that may cause undesired operation of the device.

Only operate the device in accordance with the instructions supplied.

Changes or modifications to this unit not expressly approved by the party responsible for compliance could void the user's authority to operate the equipment.

This device complies with FCC radiation exposure limits set forth for an uncontrolled environment. In order to avoid the possibility of exceeding the FCC radio frequency exposure limits, human proximity to the antenna shall not be less than 20cm (8 inches) during normal operation.

NOTE

This equipment has been tested and found to comply with the limits for a Class B digital device, pursuant to part 15 of the FCC Rules. These limits are designed to provide reasonable protection against harmful interference in a residential installation.

This equipment generates, uses and can radiate radio frequency energy and, if not installed and used in accordance with the instructions, may cause harmful interference to radio communications. However, there is no guarantee that interference will not occur in a particular installation. If this equipment does cause harmful interference to radio or television reception, which can be determined by turning the equipment off and on, the user is encouraged to try to correct the interference by one or more of the following measures:

- Reorient or relocate the receiving antenna.
- Increase the separation between the equipment and receiver.
- Connect the equipment into an outlet on a circuit different from that to which the receiver is connected.
- Consult the dealer or an experienced radio/TV technician for help.

We, hereby declare that this device is in compliance with the relevant provisions of RE Directive 2014/53/EU. A copy of the full DoC is attached (European Union products only).

DRAINAGE GUIDE

Dehumidifying Mode Drainage Guide

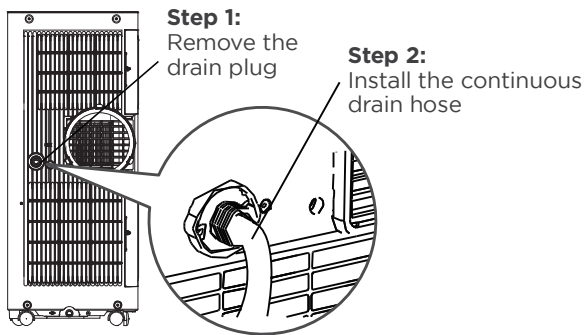

During dehumidifying mode, remove the drain plug from the back of the unit, install the drain connector (5/8" universal female mender) with 3/4" hose.

Place the open end of the hose directly over the drain area in your basement floor.

NOTE: Make sure the hose is secure so there are no leaks. Direct the hose toward the drain, making sure that there are no kinks that will stop the water flowing. Place the end of the hose into the drain and make sure the end of the hose is down to let the water flow smoothly. When the continuous drain hose is not used, ensure that the drain plug is installed firmly to prevent leakage.

Water collection tray Drainage Guide

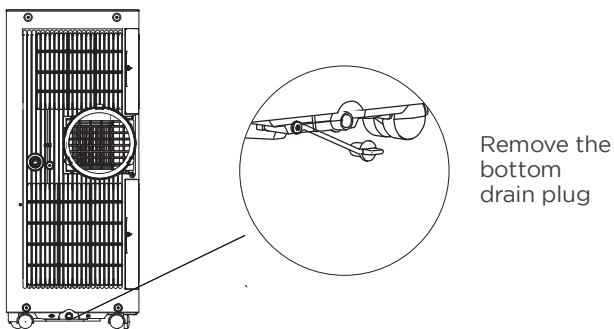

When the water level of the bottom tray reaches a predetermined level, the unit beeps 8 times, the digital display area shows "P1". At this time the air conditioning/dehumidification process will immediately stop. However, the fan motor will continue to operate (this is normal). Carefully move the unit to a drain location, remove the bottom drain plug and let the water drain away. Reinstall the bottom drain plug and restart the machine until the "P1" symbol disappears. If the error repeats, call for service.

NOTE: Be sure to reinstall the bottom drain plug firmly to prevent leakage before using the unit.

CLEANING & MAINTENANCE

How to clean & maintenance your AC.

Air Filter & Cabinet Cleaning

Clean the unit using a damp, lint-free cloth and mild detergent. Dry the unit with a dry, lint-free cloth.

Maintenance Tips

- Be sure to clean the air filter every 2 weeks for optimal performance.
- The water collection tray should be drained immediately after P1 error occurs, and before storage to prevent mold. See Drainage Guide for instructions on how to properly drain.
- In households with animals, you will have to periodically wipe down the grill to prevent blocked airflow due to animal hair.

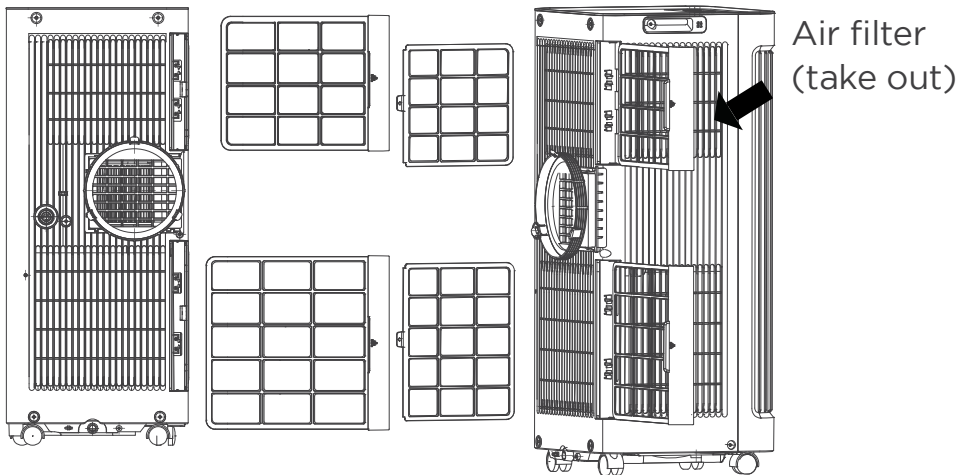

Remove the air filter



CAUTION:

DO NOT operate the unit without filter because dirt and lint will clog it and reduce performance.



CAUTION:

- Always unplug the unit before cleaning or servicing.
- DO NOT use flammable liquids or chemicals to clean the unit.
- DO NOT wash the unit under running water. Doing so causes electrical danger.
- DO NOT operate the machine if the power supply was damaged during cleaning. A damaged power cord must be replaced with a new cord from the manufacturer.

Store the unit when not in use

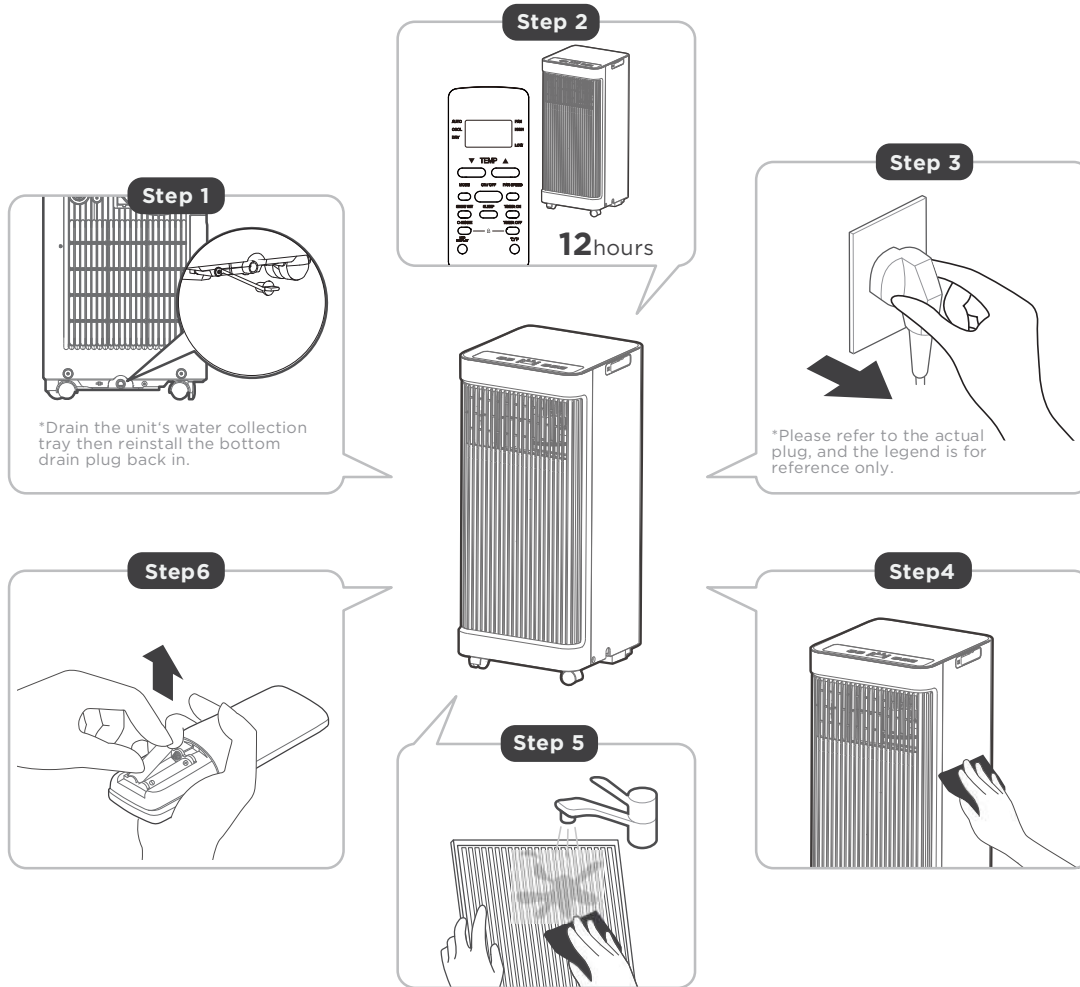

NOTE

- Be sure to store the unit in a cool, dark place. Exposure to direct sunshine or extreme heat can shorten the lifespan of the unit.
- The cabinet and front may be dusted with an oil-free cloth or washed with a cloth dampened in a solution of warm water and mild liquid dishwashing detergent. Rinse thoroughly and wipe dry. Never use harsh cleansers, wax or polish on the cabinet front. Be sure to wring excess water from the cloth before wiping around the controls. Excess water in or around the controls may cause damage to the unit.

Step1: Drain the unit's water collection tray according to the instructions in the drainage guide section.

Step2: Run the appliance on FAN mode for 12 hours in a warm room to dry it and prevent mold.

Step3: Turn off the appliance and unplug it.

Step4: Clean the unit according to the instructions in the previous section.

Step5: Clean the air filters according to the instructions in the previous section. Reinstall the clean dry filter before storing.

Step6: Remove the batteries from the remote control.

TROUBLESHOOTING

Problem Solving

Common Issues

The following problems are not a malfunction and in most situations will not require repairs.

Problem	Possible Causes	Solution
Unit does not turn on when pressing ON/OFF button	P1 Protection Code	The Water Collection Tray is full. Turn off the unit, drain the water from the Water Collection Tray and restart the unit.
	In COOL mode: room temperature is lower than the set temperature	Check the set temperature
Unit does not cool well	The air filter is blocked with dust or animal hair	Turn off the unit and clean the filter according to instructions
	Exhaust hose is not connected or is blocked	Turn off the unit, disconnect the hose, check for blockage and reconnect the hose
	The unit is low on refrigerant	Call a service technician to inspect the unit and top off refrigerant
	Temperature setting is too high	Decrease the set temperature
	The windows and doors in the room are open	Make sure all windows and doors are closed
	The room area is too large	Double-check the cooling area
	There are heat sources inside the room	Remove the heat sources if possible
The unit is noisy and vibrates too much	The ground is not level	Place the unit on a flat, level surface
	The air filter is blocked with dust or animal hair	Turn off the unit and clean the filter according to instructions
The unit makes a gurgling sound	This sound is caused by the flow of refrigerant inside the unit	This is normal

WARRANTY

Air Conditioner Limited Warranty

Your product is protected by this Limited Warranty:

Warranty service must be obtained from Midea Consumer Services or an authorized Midea servicer.

Warranty

- One year full warranty from original purchase date.

Midea, through its authorized services will:

- Pay all costs for repairing or replacing parts of this appliance which prove to be defective in materials or workmanship.

Consumer will be responsible for:

- Diagnostics, removal, transportation and reinstallation cost required because of service.
- Costs of service calls that are a result of items listed under NORMAL RESPONSIBILITIES OF THE CONSUMER**

Midea replacement parts shall be used and will be warranted only for the original warranty.

NORMAL RESPONSIBILITIES OF THE CONSUMER**

This warranty applies only to products in ordinary household use, and the consumer is responsible for the items listed below:

1. Proper use of the appliance in accordance with instructions provided with the product.
2. Routine maintenance and cleaning necessary to keep the good working condition.
3. Proper installation by an authorized service professional in accordance with instructions provided with the appliance and in accordance with all local plumbing, electrical and/or gas codes.
4. Proper connection to a grounded power supply of sufficient voltage, replacement of blown fuses, repair of loose connections or defects in house wiring.
5. Expenses for making the appliance accessible for servicing.
6. Damages to finish after installation.

EXCLUSIONS

This warranty does not cover the following:

- 1) Failure caused by damage to the unit while in your possession (other than damage caused by defect or malfunction), by its improper installation, or by unreasonable use of the unit, including without limitation, failure to provide reasonable and necessary maintenance or to follow the written installation and Operating Instructions.
- 2) Damages caused by services performed by persons other than authorized Midea customer service; or external causes such as abuse, misuse, inadequate power supply or acts of God.
- 3) If the unit is put to commercial, business, rental, or other use or application other than for consumer use, we make no warranties, express or implied, including but not limited to, any implied warranty of merchantability or fitness for use or purpose.
- 4) Products without original serial numbers or products that have serial numbers which have been altered or cannot be readily determined.

NOTE: Some states do not allow the exclusions or limitation of incidental or consequential damages. So this limitation or exclusion may not apply to you.

IF YOU NEED SERVICE

Keep your bill of sale, delivery slip, or some other appropriate payment Record.

The date on the bill establishes the warranty period, should service be required.

If service is performed, its your best interest to obtain and keep all receipts.

This written warranty gives you specific legal rights. You may also have other rights that vary from state to state.

Service under this warranty must be obtained by following these steps, in order:

- 1) Contact Midea Consumer Services or an authorized Midea services at 1 866 646 4332.
- 2) If there is a question as to where to obtain service, contact our consumer relations Department.

The design and specifications are subject to change without prior notice for product improvement. Consult with the sales agency or manufacturer for details. Any updates to the manual will be uploaded to the service website, please check for the latest version.



www.midea.com
© Midea 2023 all rights reserved
MAPS

16120600A27518

2023.12.12