

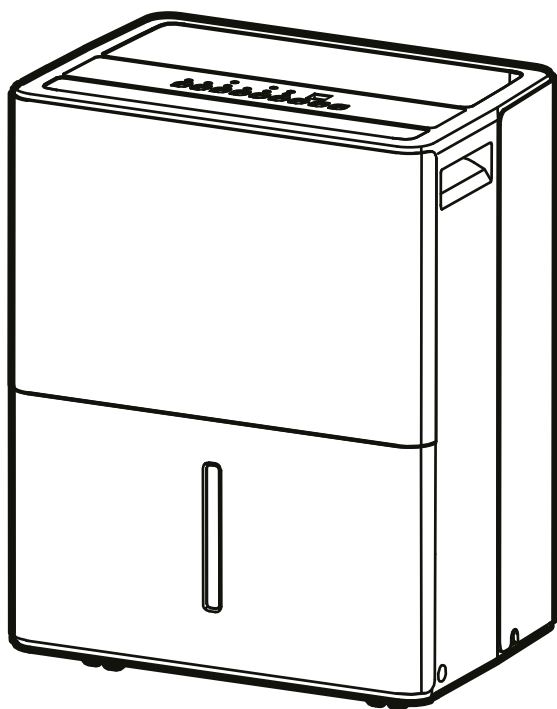

USER MANUAL

Dehumidifier MAD

Rated voltage: 115V
Frequency: 60Hz



⚠ WARNING

Before using this product, please read this manual carefully and keep it for future reference.

The design and specifications are subject to change without prior notice for product improvement.

Consult with your dealer or the manufacturer for details.

MAD22C1AWS
MAD35C1AWS
MAD50C1AWS
MAD50P1AWS
MAD50PS1WS

1	Safety Precautions	3
2	Unit Specifications and Features	7
3	Installation Instructions	8
4	Operating Instructions	9
6	App Instructions	15
5	Care and Cleaning	19
6	Troubleshooting Tips	20
7	Warranty	21

Read This Manual

Inside you will find many helpful hints on how to use and maintain your air conditioner properly. Just a little preventive care on your part can save you a great deal of time and money over the life of your air conditioner. You'll find many answers to common problems in the troubleshooting tips - you should be able to fix most of them quickly before calling service. These instructions may not cover every possible condition of use, so common sense and care for safety is required when installing, operating and maintaining this product.



CAUTION

- For support, please call the Service Center at 1-866-646-4332
- This appliance is not intended for use by persons (including children) with reduced physical, sensory or, or lack of experience and knowledge, unless they have been given supervision or instruction concerning use of the appliance by a person responsible for their mental capabilities safety.
- Children should be supervised to ensure that they do not play with the appliance
- The appliance shall be installed in accordance with national wiring regulations.

SAFETY PRECAUTIONS

To prevent injury to the user or personal and property damage, these instructions must be followed. Incorrect operation due to ignoring of instructions may cause harm or damage. The level of risk is shown by the following indications.

WARNING

This symbol indicates a hazardous situation which, if not avoided, could result in death or serious injury.

CAUTION

This symbol indicates a hazardous situation, which, if not avoided, could result in minor or moderate injury.

NOTICE

This symbol addresses practices not related to physical injury.

WARNING

- Plug in power plug properly.
Otherwise, it may cause electric shock or fire due to excess heat generation.
- Do not modify power cord length or share the outlet with other appliances.
It may cause electric shock or fire due to overheating.
- Always ensure effective grounding.
Incorrect grounding may cause electric shock.
- Unplug the unit if strange sounds, smells, or smoke come from it.
A damaged product may cause fire and electric shock.
- Ventilate room before operating the unit if there is a gas leak from other appliances.
- Do not operate or stop the unit by inserting or pulling out the power plug.
It may cause electric shock.
- Do not allow water to enter into electric parts.
It may cause failure or electric shock.
- Do not use the power outlet if it is loose or damaged.
It may cause fire and electric shock.
- Do not use or keep the power cord close to heating appliances or heat sources such as fireplaces.
It may cause fire and electric shock.
- Do not disassemble or modify unit.
It may cause failure and electric shock.
- Do not damage or use an unspecified power cord.
It may cause fire and electric shock.
- If the power cord is damaged, it must be replaced by the manufacturer or an authorized service center or a similarly qualified person in order to avoid electrical risk.
- Do not use the unit near flammable gas or combustibles, such as gasoline, benzene, thinner, etc.
It may cause fire.

 **WARNING**

- Before cleaning, turn off the power and unplug the unit.
- Be sure the dehumidifier has been securely and correctly installed according to the installation instructions in this manual. Save this manual for possible future use in removing or installing this unit.
- Do not operate with wet hands.
It may cause electric shock.
- Do not open the unit during operation.
It may cause electric shock.
- Avoid fire hazard or electric shock.
Do not use an extension cord or an adaptor plug. Do not remove any prongs from the power cord.
- Be sure the dehumidifier is properly grounded. To minimize shock and fire hazards, proper grounding is important.
The power cord is equipped with a three-prong grounding plug for protection against shock hazards.
- Your dehumidifier must be used in a properly grounded wall receptacle. If the wall receptacle you intend to use is not adequately grounded or protected by a time delay fuse or circuit breaker, have a qualified electrician install the proper receptacle. Ensure the receptacle is accessible after the unit installation.
- Be sure the electrical service is adequate for the model you have chosen. This information can be found on the serial plate, which is located on the side of the cabinet and behind the grille.
- Do not drink the water from the bucket.
- Before cleaning, turn off the power and unplug the unit.
- Do not use the unit in small spaces or place in a sink or shower.
Lack of ventilation can cause overheating and fire.

 **CAUTION**

- Do not use in places where water may splash onto the unit.
Water may enter the unit and degrade the insulation. It may cause an electric shock or fire.
- Place the unit on a level, sturdy section of the floor.
If the unit falls over, it may cause water to spill and damage belongings, or cause electrical shock or fire.
- Never insert your finger or other foreign objects into grills or openings. Take special care to warn children of these dangers.
It may cause failure or electric shock.
- Do not climb up on or sit on the unit.
You may be injured if you fall or if the unit falls over.
- Always insert the filters securely, and take caution to avoid injuries to hand and fingers. Clean filter once every two weeks.
- If water enters the unit, turn the unit off and disconnect the power, contact a qualified service technician.
- Do not place flower vases or other water containers on top of the unit.
Water may spill inside the unit, causing insulation failure and electrical shock or fire.
- If the unit is knocked over during use, turn off the unit and unplug it from the main power supply immediately. Visually inspect the unit to ensure there is no damage. If you suspect the unit has been damaged, contact customer service or a qualified technician.
- In a thunderstorm, the power should be disconnected to the unit due to lightning.
- Do not run power cord under carpeting. Do not cover cord with throw rugs, runners, or similar coverings. Do not route cord under furniture or appliances. Arrange cord away from traffic area and where it will not be tripped over.
- Clean the bucket regularly.

EXPLANATION OF SYMBOLS DISPLAYED ON THE UNIT

	WARNING	This symbol shows that this appliance used a flammable refrigerant. If the refrigerant is leaked and exposed to an external ignition source, there is a risk of fire.
	CAUTION	This symbol shows that the operation manual should be read carefully.
	CAUTION	This symbol shows that a service personnel should be handling this equipment with reference to the installation manual.
	CAUTION	This symbol shows that information is available such as the operating manual or installation manual.

WARNING

- Do not try to accelerate the defrosting process or methods of cleaning that are not recommended by the manufacturer.
- The appliance shall be stored in a room without a continuously operating ignition source (for example, open flames or an operating gas appliance) or an ignition source (for example, an operating electric heater) close to the appliance. The appliance shall also be stored in a room without ignition sources.
- Do not pierce or burn.
- Be aware that the refrigerants may not contain an odor.
- Keep ventilation openings clear of obstruction.
- Unit is only to be serviced by a Midea authorized servicer, please call Customer Service at 1-866-646-4332 for support.
- Flammable refrigerant R32 is used within air conditioner. Please follow the instructions carefully to handle, install, clean, and service the air conditioner to avoid damage or hazard. Do not dispose of air conditioner in regular trash. Contact qualified agency for proper disposal.
- No open fire or devices that generate spark/arc shall be around the air conditioner to avoid causing ignition of the flammable refrigerant used. Please follow the instructions carefully to store or maintain the air conditioner to prevent mechanical damage from occurring.



Caution: Risk of fire/
flammable materials
(Required for R32 units only)



IMPORTANT NOTE: Read this manual carefully before installing or operating your new air conditioning unit. Make sure to save this manual for future reference.

UNIT SPECIFICATIONS AND FEATURES

Product overview

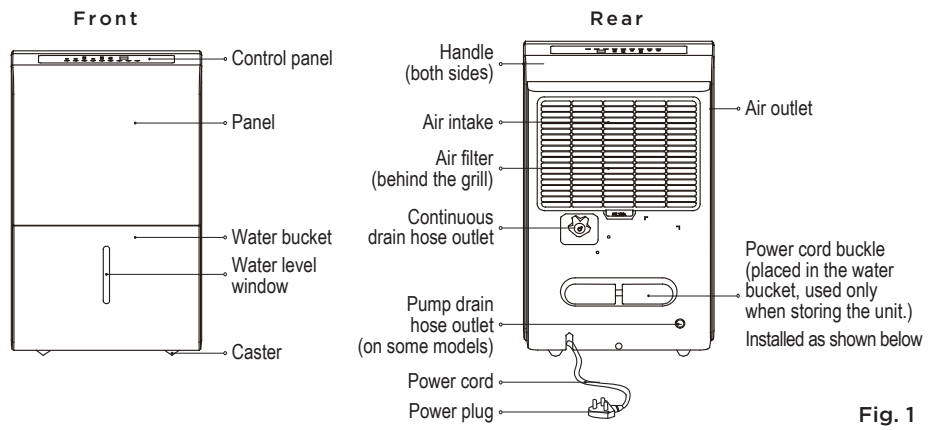
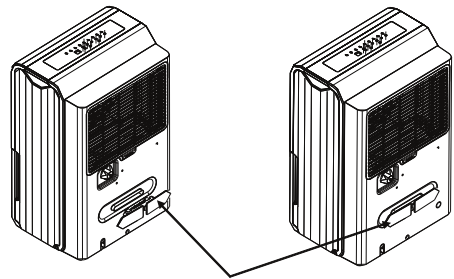

Fig. 1

NOTICE

All the pictures in this manual are for illustrative purposes only. The actual shape of the dehumidifier you purchased may be slightly different, but its operations and functions are similar.



Insert the power cord buckle into the unit.

Fig. 2

Accessories

Pump drain hose (1 pc) (only for units with the drain pump feature)

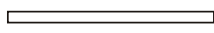

Power cord buckle (1 pc)

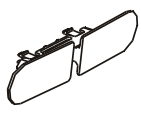

INSTALLATION INSTRUCTIONS

Positioning the Unit

A dehumidifier operating in a basement will have little or no effect in drying an adjacent enclosed storage area, such as a closet, unless there is adequate circulation of air in and out of the area. (See Fig. 3)

- Do not use outdoors.
- This dehumidifier is intended for indoor residential applications only. This dehumidifier should not be used for commercial or industrial applications.
- Place the dehumidifier on a smooth, level floor strong enough to support the unit with a full bucket of water.
- Allow at least 8" of air space on all sides of the unit for air circulation (at least 16" for air outlet).
- Place the unit in an area where the temperature will not fall below 41°F (5°C). The coils can become covered with frost at lower temperatures, which may reduce performance.
- Place the unit away from any clothes dryer, heater or radiator.
- Close all doors, windows and other outside openings to the room.

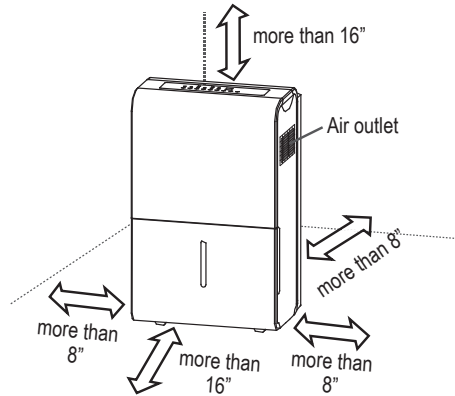
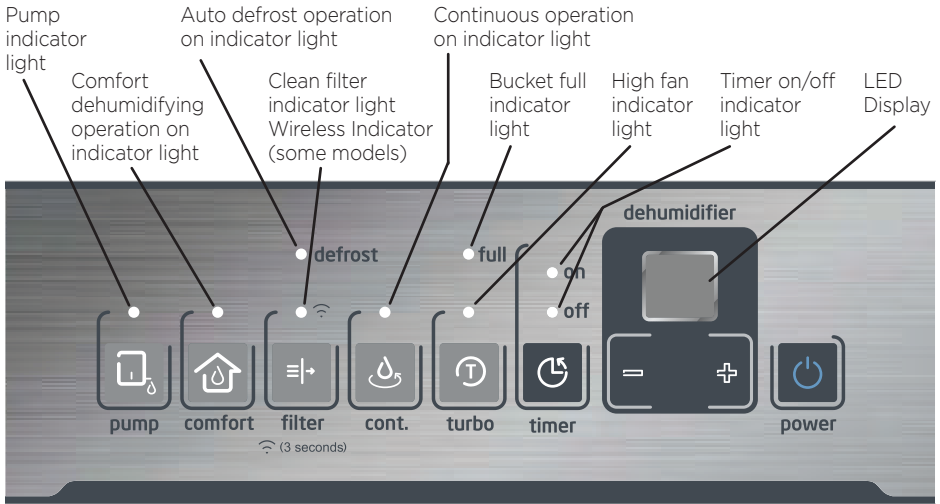

Fig. 3

OPERATING INSTRUCTIONS

Key Pad Features



NOTICE

The appearance of the control panel on your unit may vary slightly. Functions will be similar.

Control Pads

When you push the button to change operation modes, the unit will make a beep sound to indicate that it is changing modes.

(PUMP) Button (PUMP Models Only)

Press to activate the pump operation.

(COMFORT) Button

Press to activate the comfort dehumidifying operation.

NOTICE

Note: When using this function, the humidity level can not be selected. On some models, pressing the Up/Down button will cancel this function.

(FILTER) Button

This feature is a reminder to clean the Air Filter for more efficient operation. The LED (light) will flash after 250 hours of operation. To reset after cleaning the filter, press the Filter button and the light will go off. The 250 hour counter will reset.

(CONTINUE) Button

Press to activate the continuous dehumidifying operation.

NOTICE

When CONTINUOUS function is turned on, the humidity set point cannot be changed manually.

(TURBO) Button

Control the Turbo speed. Press to select either Turbo or normal fan speed. Set the Turbo control to high for maximum moisture removal. When room humidity is at your preferred level, it is advised to turn off Turbo speed.

(TIMER) Button

Starts the Timer ON and Timer OFF function setting.

Up/Down Buttons (◀/▶)

- **Humidity Set Control Buttons**

The humidity level can be set within a range of 35% RH (Relative Humidity) to 85% RH (Relative Humidity) in 5% increments.

For drier air, press the ◀ button and set to a lower value (%).

For damper air, press the ▶ button and set a higher value (%).

- **TIMER Set Control Buttons**

Use the ◀ and ▶ key buttons to set the Timer ON or Timer OFF from 0 to 24 hours.

(POWER) Button

Press to turn the dehumidifier on and off.

LED Display

Shows the set % humidity level from 35% to 85% or auto start/stop time (0 - 24) while setting, then shows the actual (+/- 5% accuracy) room % humidity level in a range of 30% RH (Relative Humidity) to 90% RH (Relative Humidity).

Wireless Indicator

When connecting your air conditioner to Wireless, press the Filter button for 3 seconds to initiate the Wireless connection mode. The display shows 'AP' to indicate the unit is in the Wireless connection mode.

Refer to the instructions within the app to complete the connection process. If connection is successful within 8 minutes, the unit will exit Wireless connection mode automatically and the Wireless indicator illuminates. If connection failed within 8 minutes, the unit exits Wireless connection mode automatically and the Wireless indicator does not illuminate. After Wireless connection is successful, you can control the Dehumidifier within the MSmartHome app.

Error Codes and Protection Code:

- AS** - Humidity sensor error - Unplug the unit and plug it back in. If error persists, contact Customer Service.
- ES** - Tube Temperature sensor of the evaporator error - Unplug the unit and plug it back in. If error persists, contact Customer Service.
- P2** - Bucket is full or bucket is not in right position - Empty the bucket and replace it in the right position. (only available for the unit with no pump feature.)
- P2** - Bucket is full - Empty the bucket. (only available for the unit with pump feature.)
- EC** - Refrigerant leakage detection - Display area will show EC when the unit detects refrigerant leakage. If error persists, contact Customer Service.
- Eb** - Bucket is removed or not in right position - Replace the bucket in the right position. (only available for the unit with pump feature.)

Other Features

Bucket Full Light

Lights up when the bucket is ready to be emptied.

Auto Shut Off

The dehumidifier shuts off when the bucket is full, or when the bucket is removed or not replaced in the proper position. When the set point humidity level is reached, the unit will be shut off automatically. The fan motor will continue operating.

Auto Defrost

When frost builds up on the evaporator coils, the compressor will cycle off and Auto Defrost function will run automatically.

3 minute compressor operation delay protection

After the unit has stopped, it can not be restarted in the first 3 minutes to protect compressor operation. The unit will restart automatically after 3 minutes.

Auto-Restart

If the unit stops unexpectedly due to a power cut, it will restart with the previous function setting automatically when the power resumes.

Setting the Timer ON and Timer OFF

- When the unit is on, first press the Timer button, the Timer OFF indicator light illuminates. It indicates the Timer OFF program is initiated. Press it again the Timer ON indicator light illuminates. It indicates the Timer ON is initiated.
- When the unit is off, first press the Timer button, the Timer ON indicator light illuminates. It indicates the Timer ON program is initiated. Press it again the Timer OFF indicator light illuminates. It indicates the Timer OFF is initiated.

- Press or hold the ◀ and ▶ key buttons to change the Timer by 0.5 hour increments, up to 10 hours, then at 1 hour increments up to 24 hours. The control will count down the time remaining until start.
- The selected time will register in 5 seconds and the system will automatically revert back to display the previous humidity setting.
- When the Timer ON and Timer OFF times are set, within the same program sequence, indicator lights illuminate identifying both ON and OFF times are now programmed.
- Turning the unit ON or OFF at any time or adjusting the timer setting to 0.0 will cancel the Timer function.
- When LED display window displays the code of P2, the Auto Start/Stop function will also be cancelled.

NOTICE

- Before operating the unit, make sure the plug for the drain hose outlet is securely installed.
- When first using the dehumidifier, operate continuously for 24 hours.
- This unit is designed to operate with a working environment between 5°C/41°F and 32°C/90°F.
- Make sure the water bucket is positioned correctly so that the unit can operate properly. When the water in the bucket reaches a certain level, please be careful while moving the unit to avoid spill.

Removing Collected Water

There are three ways to remove collected water:

1. Use the bucket

- When the unit is off, if the bucket is full, the Full indicator light will light.
- When the unit is on, if the bucket is full, the compressor and the fan turn off, and the Full indicator light will light, the digital display shows P2.
- Slowly pull out the bucket. Grip the left and right handles securely, and carefully pull out straight so water does not spill. Do not put the bucket on the as because the bottom of the bucket is uneven. Otherwise water may be spilled.
- Empty the water and reposition the bucket.
- The unit will restart operation when the bucket is back in place.

1. Pull out the bucket.

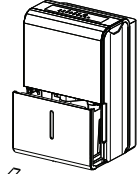

2. Hold both sides of the bucket evenly, and pull it out from the unit.

Fig. 4

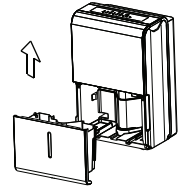

3. Pour the water out.

Fig. 5

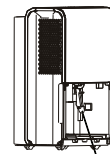

Pump hose drops

Fig. 6

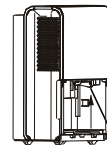

Reinstall pump hose properly

Fig. 7

NOTICE

- When you remove the bucket, do not touch any parts inside the unit. Doing so may damage the product.
- Be sure to push the bucket gently all the way into the unit.
- If the pump hose falls off when you remove the bucket (see Fig. 6), you must reinstall the pump hose properly to the unit before replacing the bucket into the unit (see Fig. 7).
- When the unit is on, if the bucket is removed, the compressor and the fan turn off, then the unit will beep 8 times and the digital display shows Eb.
- When the unit is off, if the bucket is removed, the unit will beep 8 times and the digital display shows Eb.

2. Continuous draining

- Water can be automatically emptied into a floor drain by attaching the unit with a water hose (Id $\geq \varnothing$ 5/16", not included) with a female threaded end (ID: M = 1", not included).
- Remove the plastic cover from the back drain outlet of the unit and set aside, then insert the drain hose through the drain outlet of the unit and lead the drain hose to the floor drain or a suitable drainage facility. (See Fig. 8 and Fig. 9)
- When you remove the plastic cover, if there is some water in the back drain outlet of the unit you must dry it. Make sure the hose is secure so there are no leaks and the end of the hose is level or sloping downwards to let the water flow.
- Direct the hose toward the drain, making sure that there are no kinks that will stop the water flowing.
- Select the desired humidity setting and fan speed on the unit for continuous draining to start.

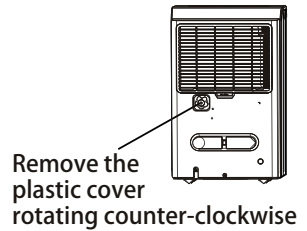

Fig. 8

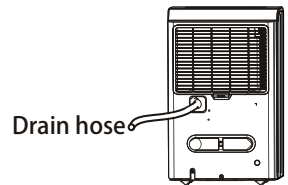

Fig. 9

NOTICE

When the continuous draining feature is not being used, remove the drain hose from the outlet, and dry the water in the continuous drain hose outlet.

Removing the Collected Water (cont.)

3. Pump draining (Pump models only)

Water can be automatically emptied into a floor drain or a suitable drainage facility by attaching the pump drain outlet with a pump drain hose (\varnothing od = 1/4", supplied).

- Remove the continuous drain hose from the unit and install the plastic cover to the continuous drain hose outlet of the unit by clockwise rotation. (See Fig. 10)
- Insert the pump drain hose into the pump drain hose outlet for at least 15 mm (See Fig. 10), then lead the water hose to the floor drain or a suitable drainage facility.
- Press the pump pad on the unit to activate the pump operation. When the bucket is full the pump starts to work.

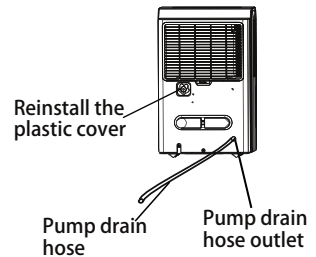

Fig. 10

NOTICE

The pump may generate a loud noise for the first 3-5 minutes of operation.

- Make sure the hose is secure so there are no leaks.
- Direct the hose toward the drain, making sure that there are no kinks that will stop the water flowing.
- Place the end of the hose into the drain.
- Select the desired humidity setting and fan speed on the unit for pump draining to start.

NOTICE

The pump operation light blinks when a failure occurs. Please turn off the unit and disconnect the power cord. Check the following items:

- Cleaning the pump filter:
 - Remove the bucket from the unit, take down the pump and clean the pump filter (See Fig. 11).
- Check if the drain hose is clean and free of debris.
- Empty the water from the bucket.
- Check the hose connection and the bucket for proper fitment. If the error persists, contact Customer Service.

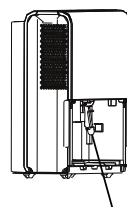

Filter of the pump

Fig. 11

NOTICE

Do not use this operation when the outdoor temperature is equal to or less than 0°C (32°F), otherwise water may freeze ice causing the water hose to be blocked and the unit to stop operating.

Make sure to empty the bucket at least once a week when using the pump draining feature. When the pump draining feature is not being used, remove the pump drain hose from the outlet.

APP INSTRUCTIONS

DECLARATION OF CONFORMITY

We hereby declare that this Dehumidifier is in compliance with the essential requirements and other relevant provisions of Directive 1999/5/EC.

SPECIFICATION OF WIRELESS MODULE

Model: US-SK105	Dimensions: 41 x 24 x 5 (mm)
Antenna Type: Printed PCB Antenna	Operation Temperature: 0°C - 45°C / 32°F - 113°F.
Frequency: 2400-2483.5MHz	Operation Humidity: 10% - 85%
Maximum Transmitted Power: <20dBm	Power Input: DC 5V/300 mA

PRECAUTIONS

1. Supports operating systems: iOS 10+ or Android 5+.
2. In the event of a OS update, there may be a delay between the update of the OS and a related software update during which your OS may or may not be supported until a new version is released. Your specific mobile phone or problems in your network may prevent the system from working and Midea will not be responsible for any problems that could be caused by incompatibility or network issues.
3. This Smart Dehumidifier only supports WPA-PSK/WPA2-PSK (recommended) encryption.
4. To ensure proper scanning of the QR code, your smart phone must have at least a 5-megapixel camera.
5. Due to unstable network connectivity, requests may time out. If this happens, re-run the network configuration.
6. Due to unstable network connectivity, commands may time out. If this happens, the smartphone app and the actual product may display conflicting information. The information displayed on the actual product is always the most accurate available. Refresh the app to re-sync.

NOTICE

Midea will not be responsible for any problems that could be caused by incompatibility or network issues, your wireless router and mobile phone.

SYSTEM OVERVIEW

Devices required to use the Smart Dehumidifier:

1. Smart Phone with compatible iOS or Android system.
2. Wireless Router
3. Smart Dehumidifier

DOWNLOAD AND INSTALL THE APP



Scan to download app.

- You can also go to the Google Play or App Store and search for MSmart Home.

NOTICE

All the images in this manual are for reference only, your product and app may look slightly different. The actual product and app instructions have to be considered.

CREATE YOUR ACCOUNT

- Make sure your smartphone is connected to your wireless router and your wireless router has a working 2.4 GHz internet connection.
- It is recommended to activate your account immediately to be able to recover your password by email.



1. Press Login.

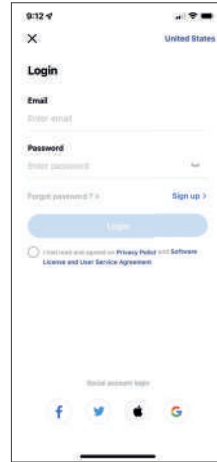

2. Select Sign Up.

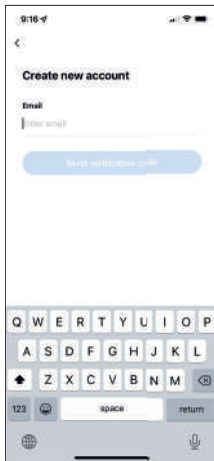

3. Enter your email address.

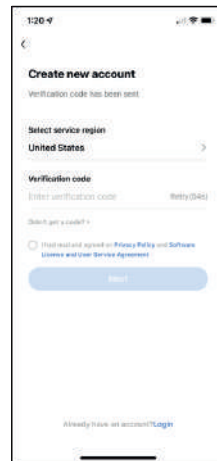

4. Enter the verification code that was sent to your email address.

NOTICE

- Make sure your smartphone is able to connect to the wireless network which will be used.
- Make sure also that the device is not connecting to other networks in range.

ADDITIONAL APP AND SMART HOME FUNCTIONS

For additional instructions regarding the features of the app and Smart Home skill capabilities, scan the QR code below.



Declaration of conformity CONTAINS FCC ID: 2ADQOMDNA21 CONTAINS IC : 12575A-MDNA21

This device complies with Part 15 of the FCC Rules and Industry Canada's licenceexempt RSSs.

Operation is subject to the following two conditions:

- (1) This device may not cause interference;and
- (2) This device must acceptany interference,including interference that may cause undesired operation of the device.

Only operate the device in accordance with the instructions supplied. Changes or modifications to this unit not expressly approved by the party responsible for compliance could void the user's authority to operate the equipment.This device complies with FCC radiation exposure limits set forth for an uncontrolled environment. In order to avoid the possibility of exceeding the FCC radio frequency exposure limits, human proximity to the antenna shall not be less than 20cm (8 inches) during normal operation.

NOTE: This equipment has been tested and found to comply with the limits for a Class B digital device, pursuant to part 15 of the FCC Rules. These limits are designed to provide reasonable protection against harmful interference in a residential installation. This equipment generates, uses and can radiate radio frequency energy and, if not installed and used in accordance with the instructions, may cause harmful interference to radio communications. However, there is no guarantee that interference will not occur in a particular installation. If this equipment does cause harmful interference to radio or television reception, which can be determined by turning the equipment off and on, the user is encouraged to try to correct the interference by one or more of the following measures:

- Reorient or relocate the receiving antenna.
- Increase the separation between the equipment and receiver.
- Connect the equipment into an outlet on a circuit different from that to which the receiver is connected.
- Consult the dealer or an experienced radio/TV technician for help.

Hereby, we declare that this AC is in compliance with the essential requirements and other relevant provisions of RE Directive 2014/53/EU. A copy of the full DoC is attached.

NOTE:

All the illustrations in the manual are for explanation purpose only. Your unit may be slightly different. The actual shape shall prevail.

CARE AND CLEANING

Turn the dehumidifier off and disconnect the plug from the power source before cleaning.

1. Clean the Grill and Case

- Use water and a mild detergent. Do not use bleach or abrasives.
- Do not splash water directly onto the unit. Doing so may cause an electrical shock, cause the insulation to deteriorate, or cause the unit to rust.
- The air intake and outlet may get dirty during operation, use a vacuum cleaner or brush to clean.

2. Clean the bucket

Every few weeks, clean the bucket thoroughly to prevent growth of mold, mildew and bacteria. Partially fill the bucket with clean water and mild detergent. Swish it around in the bucket, empty and rinse.

NOTICE

Do not use a dishwasher to clean the bucket.

3. Clean the air filter

- To remove the filter, pull filter outwards (See Fig. 12).
- Wash the filter with clean water then dry.
- Re-install the filter, replace bucket.

CAUTION

DO NOT operate the dehumidifier without a filter to avoid loss of performance and damage to the unit.

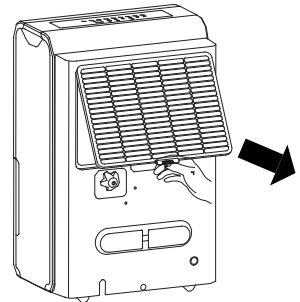

Fig. 12

4. When not using the unit for long time periods

- Before storing the unit, let it rest for one full day so that the system can dry out naturally.
- Clean the unit, water bucket and air filter.
- Wrap the cord with the power cord buckle.
- Cover the unit with a plastic bag.
- Store the unit upright in a dry, well-ventilated area.

TROUBLESHOOTING TIPS

Before calling for service, review this list. It may save you time and money. This list includes common occurrences that are not the result of defective workmanship or materials in this appliance.

Problem	Solution
Unit does not start	Make sure the dehumidifiers plug is connected firmly into the wall outlet.
	Check the house fuse/circuit breaker box.
	Dehumidifier has reached its preset level or bucket is full.
	Water bucket is not in the proper position.
Dehumidifier does not dry the air as it should	Not enough time to remove the moisture.
	Make sure there are no curtains, blinds or furniture blocking the front or back of the dehumidifier.
	The humidity control may not be set low enough.
	Check that all doors, windows and other openings are securely closed.
	Room temperature is too low, below 5°C (41°F).
There is a water vapor source in the room.	
The unit makes a loud noise when operating	Air filter may be dirty. Clean filter. Refer to Care and Cleaning section.
	The unit is tilted instead of upright as it should be.
	The floor surface is not level.
Frost appears on the coils	This is normal. The dehumidifier has Auto defrost feature.
Water on floor	Hose to connector or hose connection may be loose.
	Intended to use the bucket to collect water, but the back drain plug is removed.
ES, AS, P2, EC, Eb and E3 appear in the display	These are error codes and protection code. Check Operating Instructions.
The pump operation on light blinks at 1 Hz	Clean the pump filter.
	Check the pump hose is not blocked or leaking.
	Empty the water bucket.

WARRANTY

Dehumidifier Limited Warranty

Your product is protected by this Limited Warranty:

Warranty service must be obtained from Midea Consumer Services or an authorized Midea servicer.

Warranty

- One year full warranty from original purchase date.

Midea, through its authorized servicers will:

- Pay all costs for repairing or replacing parts of this appliance which prove to be defective in materials or workmanship.

Consumer will be responsible for:

- Diagnostics, removal, transportation and reinstallation cost required because of service.
- Costs of service calls that are a result of items listed under NORMAL RESPONSABILITIES OF THE CONSUMER**

Midea replacement parts shall be used and will be warranted only for the original warranty.

NORMAL RESPONSABILITIES OF THE CONSUMER**

This warranty applies only to products in ordinary household use, and the consumer is responsible for the items listed below:

1. Proper use of the appliance in accordance with instructions provided with the product.
2. Routine maintenance and cleaning necessary to keep the good working condition.
3. Proper installation by an authorized service professional in accordance with instructions provided with the appliance and in accordance with all local plumbing, electrical and/or gas codes.
4. Proper connection to a grounded power supply of sufficient voltage, replacement of blown fuses, repair of loosen connections or defects in house wiring.
5. Expenses for making the appliance accessible for servicing.
6. Damages to finish after installation.

EXCLUSIONS

This warranty does not cover the following:

- 1) Failure caused by damage to the unit while in your possession (other than damage caused by defect or malfunction), by its improper installation, or by unreasonable use of the unit, including without limitation, failure to provide reasonable and necessary maintenance or to follow the written installation and Operating Instructions.
- 2) Damages caused by services performed by persons other than those authorized by Midea customer service; or external causes such as abuse, misuse, inadequate power supply or acts of God.
- 3) If the unit is put to commercial, business, rental, or other use or application other than for consumer use, we make no warranties, express or implied, including but not limited to, any implied warranty of merchantability or fitness for use or purpose.
- 4) Products without original serial numbers or products that have serial numbers which have been altered or cannot be readily determined.

NOTICE: Some states do not allow the exclusions or limitation of incidental or consequential damages. So this limitation or exclusion may not apply to you.

IF YOU NEED SERVICE

Keep your bill of sale, delivery slip, or some other appropriate payment Record.

The date on the bill establishes the warranty period, should service be required.

If service is performed, it's your best interest to obtain and keep all receipts.

This written warranty gives you specific legal rights. You may also have other rights that vary from state to state. Service under this warranty must be obtained by following these steps, in order:

- 1) Contact Midea Consumer Services or an authorized Midea services at 1 866 646 4332.
- 2) If there is a question as to where to obtain service, contact our consumer relations Department.



make yourself at home