

Inverter Window Heat Pump MAW

USER MANUAL

MAW08HV1CWT
MAW12HV1CWT
MAW12HV1CWT-A



SmartHome

Download the app
& activate product



Warning notices: Before using this product, please read this manual carefully and keep it for future reference. The design and specifications are subject to change without prior notice for product improvement. Consult with your dealer or manufacturer for details. The diagram above is just for reference. Please take the appearance of the actual product as the standard.

THANK YOU LETTER

Thank you for choosing Midea! Before using your new Midea product, please read this manual thoroughly to ensure that you know how to operate the features and functions that your new air conditioner offers in a safe way.

CONTENTS

THANK YOU LETTER	2
SAFETY PRECAUTIONS	3
PRODUCT INSTALLATION	12
OPERATION INSTRUCTIONS	20
REMOTE CONTROL AND APP INSTRUCTIONS	24
APP INSTRUCTIONS.....	29
CLEANING AND MAINTENANCE.....	36
TROUBLESHOOTING TIPS	37
WARRANTY	39

SAFETY PRECAUTIONS

Read Safety Precautions Before Operation and Installation

To prevent death or injury to the user or other people and property damage, the following instructions must be followed. Incorrect operation due to ignoring of instructions may cause death, harm or damage.



WARNING

This symbol indicates the possibility of personnel injury or loss of life.



CAUTION

This symbol indicates the possibility of property damage or serious consequences.



WARNING

- Installation must be performed according to the installation instructions. Improper installation can cause water leakage, electrical shock, or fire.
- Use only the included accessories and parts, and specified tools for the installation. Using non-standard parts can cause water leakage, electrical shock, fire, and injury or property damage.
- Make sure that the outlet you are using is grounded and has the appropriate voltage. The power cord is equipped with a three-prong grounding plug to protect against shock. Voltage information can be found on the nameplate of the unit.
- Your unit must be used in a properly grounded wall receptacle. If the wall receptacle you intend to use is not adequately grounded or protected by a time delay fuse or circuit breaker (the fuse or circuit breaker needed is determined by the maximum current of the unit. The maximum current is indicated on the nameplate located on unit), have a qualified electrician install the proper receptacle.
- Install the unit on a flat, sturdy surface. Failure to do so could result in damage or excessive noise and vibration.
- The unit must be kept free from obstruction to ensure proper function and to mitigate safety hazards.
- Do not modify the length of the power cord or use an extension cord to power the unit.
- Do not share a single outlet with other electrical appliances. Improper power supply can cause fire or electrical shock.
- Do not install your air conditioner in a wet room such as a bathroom or laundry room. Too much exposure to water can cause electrical components to short circuit.
- Do not install the unit in a location that may be exposed to combustible gas, as this could cause fire.
The unit has wheels to facilitate moving. Make sure not to use the wheels on thick carpet or to roll over objects, as these could cause tipping.
- Do not operate a unit that it has been dropped or damaged.
- The appliance with electric heater shall have at least 1 meter space to the combustible materials.
- Do not touch the unit with wet or damp hands or when barefoot.
- If the air conditioner is knocked over during use, turn off the unit and unplug it from the main power supply immediately. Visually inspect the unit to ensure there is no damage. If you suspect the unit has been damaged, contact a technician or customer service for assistance.
- In a thunderstorm, the power must be cut off to avoid damage to the machine due to lightning.
- Your air conditioner should be used in such a way that it is protected from moisture. e.g. condensation, splashed water, etc. Do not place or store your air conditioner where it can fall or be pulled into water or any other liquid. Unplug immediately if it occurs.

- All wiring must be performed strictly in accordance with the wiring diagram located inside of the unit.
- The unit's circuit board(PCB) is designed with a fuse to provide overcurrent protection. The specifications of the fuse are printed on the circuit board, such as: T 3.15A/250V, etc.
- When the water drainage function is not in use, keep the upper and the lower drain plug firmly to the unit to get rid of choking. When the drain plug is not in use, keep it carefully to prevent children from choking.



CAUTION

- This appliance is not intended for use by persons (including children) with reduced physical, sensory or mental capabilities or lack of experience and knowledge, unless they have been given supervision or instruction concerning use of the appliance by a person responsible for their safety. Children should be supervised to ensure that they do not play with the appliance.
Children must be supervised around the unit at all times.(be applicable for other countries except the European Countries)
- If the supply cord is damaged, it must be replaced by the manufacturer,its service agent or similarly qualified persons in order to avoid a hazard.
- Prior to cleaning or other maintenance, the appliance must be disconnected from the supply mains.
- Do not remove any fixed covers. Never use this appliance if it is not working properly, or if it has been dropped or damaged.
- Do not run cord under carpeting. Do not cover cord with throw rugs, runners, or similar coverings. Do not route cord under furniture or appliances. Arrange cord away from traffic area and where it will not be tripped over.
- Do not operate unit with a damaged cord, plug, power fuse or circuit breaker. Discard unit or return to an authorized service facility for examination and/or repair.
- To reduce the risk of fire or electric shock, do not use this fan with any solid-state speed control device.
- The appliance shall be installed in accordance with national wiring regulations.
- Contact the authorised service technician for repair or maintenance of this unit.
- Contact the authorised installer for installation of this unit.
- Do not cover or obstruct the inlet or outlet grilles.
- Do not use this product for functions other than those described in this instruction manual.
- Before cleaning, turn off the power and unplug the unit.
- Disconnect the power if strange sounds, smell, or smoke comes from it.
- Do not press the buttons on the control panel with anything other than your fingers.
- Do not remove any fixed covers. Never use this appliance if it is not working properly, or if it has been dropped or damaged.
- Do not operate or stop the unit by inserting or pulling out the power cord plug.
- Do not use hazardous chemicals to clean or come into contact with the unit. Do not use the unit in the presence of inflammable substances or vapour such as alcohol, insecticides, petrol,etc.
- Always transport your air conditioner in a vertical position and stand on a stable, level surface during use.
- Always contact a qualified person to carry out repairs. If the damaged power supply cord must be replaced with a new power supply cord obtained from the product manufacturer and not repaired.
- Hold the plug by the head of the power plug when taking it out.
- Turn off the product when not in use.

Electronic Work



WARNING:

BEFORE PERFORMING ANY ELECTRICAL OR WIRING WORK, TURN OFF THE MAIN POWER TO THE SYSTEM.

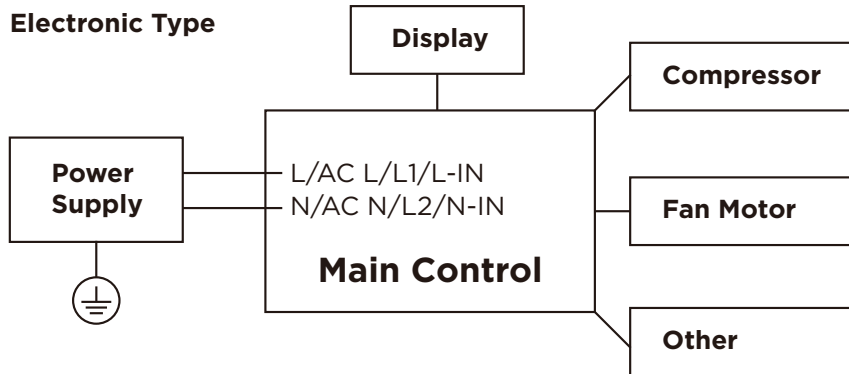

NOTICE:

Please strictly follow the wiring label attached to the machine for all wiring connections. The wiring diagram may vary for different unit. Please refer to the wiring diagram on the machine you have purchased. The above wiring diagram is a simplified version for preliminary illustration purposes only.

WARNING for Using R32 Refrigerant

- Do not use means to accelerate the defrosting process or to clean, other than those recommended by the manufacturer.
- The appliance shall be stored in a room without continuously operating ignition sources (for example: open flames, an operating gas appliance or an operating electric heater).
- Do not pierce or burn.
- Be aware that the refrigerants may not contain an odour.
- Appliance should be installed, operated and stored in a room with a floor area according to the amount of refrigerant to be charged. For specific information on the type of gas and the amount, please refer to the relevant label on the unit itself. When there are differences between the label and the manual on the Min. room area description, the description on label shall prevail.
- Appliance shall be installed, operated and stored in a room with a floor area larger than 4 m².
Appliance shall not be installed in an unventilated space, if that space is smaller than 4 m².
- No open fire or device like switch which may generate spark/arcing shall be around appliance to avoid causing ignition of the flammable refrigerant used.
Please follow the instructions carefully when storing or maintaining the appliance to prevent mechanical damage from occurring.



A2L

CAUTION:
Risk of fire
flammable materials

Explanation of symbols displayed on the unit



CAUTION

This symbol shows that the operation manual should be read carefully.



CAUTION

This symbol shows that a service personnel should be handling this equipment with reference to the installation manual.



CAUTION

This symbol shows that information is available such as the operating manual or installation manual.

⚠ WARNING for Using R32 Refrigerant

- Servicing shall only be performed as recommended by the equipment manufacturer. Maintenance and repair requiring the assistance of other skilled personnel shall be carried out under the supervision of the person competent in the use of flammable refrigerants.
- DO NOT modify the length of the power cord or use an extension cord to power the unit.
- DO NOT share a single outlet with other electrical appliances. Improper power supply can cause fire or electrical shock.
- Please follow the instruction carefully to handle, install, clear, service the appliance to avoid any damage or hazard.
- When maintaining or disposing the appliance, the refrigerant shall be recovered properly, shall not discharge to air directly.
- Compliance with national gas regulations shall be observed.
- Keep ventilation openings clear of obstruction.
- The appliance shall be stored so as to prevent mechanical damage from occurring.
- A warning that the appliance shall be stored in a well-ventilated area where the room size corresponds to the room area as specified for operation.
- Any person who is involved with working on or breaking into a refrigerant circuit should hold a current valid certificate from an industry-accredited assessment authority, which authorises their competence to handle refrigerants safely in accordance with an industry recognised assessment specification. All training shall follow the ANNEX HH requirements of UL 60335-2-40 4th Edition.

Examples for such working procedures are:

- breaking into the refrigerating circuit;
- opening of sealed components;
- opening of ventilated enclosures.

1. Transport of equipment containing flammable refrigerants

See transport regulations.

2. Marking of equipment using signs

See local regulations.

3. Disposal of equipment using flammable refrigerants

See national regulations.

4. Storage of equipment/appliances

The storage of the appliance should be in accordance with the applicable regulations or instructions, whichever is more stringent.

5. Storage of packed (unsold) equipment

Storage package protection should be constructed such that mechanical damage to the equipment inside the package will not cause a leak of the refrigerant charge. The maximum number of pieces of equipment permitted to be stored together will be determined by local regulations.

6. Information on servicing

1) Checks to the area

Prior to beginning work on systems containing flammable refrigerants, safety checks are necessary to ensure that the risk of ignition is minimised. For repair to the refrigerating system, the following precautions shall be complied with prior to conducting work on the system.

2) Work procedure

Work shall be undertaken under a controlled procedure so as to minimise the risk of a flammable gas or vapour being present while the work is being performed.

3) General work area

All maintenance staff and others working in the local area shall be instructed on the nature of work being carried out. Work in confined spaces shall be avoided. The area around the workspace shall be sectioned off. Ensure that the conditions within the area have been made safe by control of flammable material.

4) Checking for presence of refrigerant

The area shall be checked with an appropriate refrigerating detector prior to and during work, to ensure the technician is aware of potentially flammable atmospheres. Ensure that the leak detection equipment being used is suitable for use with flammable refrigerants, i.e. non-sparking, adequately sealed or intrinsically safe.

5) Presence of fire extinguisher

If any hot work is to be conducted on the refrigeration equipment or any associated parts, appropriate fire extinguishing equipment shall be available to hand. Have a dry powder or CO₂ fire extinguisher adjacent to the charging area.

6) No ignition sources

No person carrying out work in relation to a refrigerating system which involves exposing any pipe work that contains or has contained flammable refrigerant shall use any sources of ignition in such a manner that it may lead to the risk of fire or explosion. All possible ignition sources, including cigarette smoking, should be kept sufficiently far away from the site of installation, repairing, removing and disposal, during which flammable refrigerant can possibly be released to the surrounding space. Prior to work taking place, the area around the equipment is to be surveyed to make sure that there are no flammable hazards or ignition risks. No Smoking signs shall be displayed.

7)ventilated area

Ensure that the area is in the open or that it is adequately ventilated before breaking into the system or conducting any hot work. A degree of ventilation shall continue during the period that the work is carried out. The ventilation should safely disperse any released refrigerant and preferably expel it externally into the atmosphere.

8)Checks to the refrigerating equipment

Where electrical components are being changed, they shall be fit for the purpose and to the correct specifications. At all times the manufacturer's maintenance and service guidelines shall be followed. If in doubt consult the manufacturer's technical department for assistance. The following checks shall be applied to installations using flammable refrigerants: the actual refrigerant charge is in accordance with the room size within which the refrigerant containing parts are installed; the ventilation machinery and outlets are operating adequately and are not obstructed; if an indirect refrigerating circuit is being used, the secondary circuit shall be checked for the presence of refrigerant; marking to the equipment continues to be visible and legible.

Markings and signs that are illegible shall be corrected; and refrigerating pipe or components are installed in a position where they are unlikely to be exposed to any substance which may corrode refrigerant containing components, unless the components are constructed of materials which are inherently resistant to being corroded or are suitably protected against being so corroded.

9)Checks to electrical devices

Repair and maintenance to electrical components shall include initial safety checks and component inspection procedures. If a fault exists that could compromise safety, then no electrical supply shall be connected to the circuit until it is satisfactorily dealt with. If the fault cannot be corrected immediately but it is necessary to continue operation, an adequate temporary solution shall be used.

This shall be reported to the owner of the equipment so all parties are advised. Initial safety checks shall include: That capacitors are discharged: this shall be done in a safe manner to avoid possibility of sparking; that there no live electrical components and wiring are exposed while charging, recovering or purging the system; that there is continuity of earth bonding.

7. Sealed electrical components shall be replaced.

8. Intrinsically safe components must be replaced.

9. Cabling

Check that cabling will not be subject to wear, corrosion, excessive pressure, vibration, sharp edges or any other adverse environmental effects. The check shall also take into account the effects of aging or continual vibration from sources such as compressors or fans.

10. Detection of flammable refrigerants

Under no circumstances shall potential sources of ignition be used in the searching for or detection of refrigerant leaks. A halide torch (or any other detector using a naked flame) shall not be used.

The following leak detection methods are deemed acceptable for systems containing flammable refrigerants. Electronic leak detectors shall be used to detect flammable refrigerants, but the sensitivity may not be adequate, or may need re-calibration. (Detection equipment shall be calibrated in a refrigerant-free area.) Ensure that the detector is not a potential source of ignition and is suitable for the refrigerant used. Leak detection equipment shall be set at a percentage of the LFL of the refrigerant and shall be calibrated to the refrigerant employed

and the appropriate percentage of gas (25 % maximum) is confirmed. Leak detection fluids are suitable for use with most refrigerants but the use of detergents containing chlorine shall be avoided as the chlorine may react with the refrigerant and corrode the copper pipe-work. If a leak is suspected, all naked flames shall be removed/ extinguished. If a leakage of refrigerant is found which requires brazing, all of the refrigerant shall be recovered from the system, or isolated (by means of shut off valves) in a part of the system remote from the leak. Removal of refrigerant shall be according to Removal and evacuation.

11. Removal and evacuation

When breaking into the refrigerant circuit to make repairs—or for any other purpose - conventional procedures shall be used. However, for flammable refrigerants it is important that best practice be followed, since flammability is a consideration. The following procedure shall be adhered to:

- Safely remove refrigerant following local and national regulations;
- Evacuate;
- Purge the circuit with inert gas (optional for A2L);
- Evacuate (optional for A2L);
- continuously flush or purge with inert gas when using flame to open circuit; and
- open the circuit.

The refrigerant charge shall be recovered into the correct recovery cylinders if venting is not allowed by local and national codes. For appliances containing flammable refrigerants, the system shall be purged with oxygen-free nitrogen to render the appliance safe for flammable refrigerants. This process might need to be repeated several times. compressed air or oxygen shall not be used for purging refrigerant systems.

For appliances containing flammable refrigerants, refrigerants purging shall be achieved by breaking the vacuum in the system with oxygen-free nitrogen and continuing to fill until the working pressure is achieved, then venting to atmosphere, and finally pulling down to a vacuum (optional for A2L).

This process shall be repeated until no refrigerant is within the system (optional for A2L). When the final oxygen-free nitrogen charge is used. the system shall be vented down to atmospheric pressure to enable work to take place. The outlet for the vacuum pump shall not be close to any potential ignition sources, and ventilation shall be available.

12. Charging procedures

In addition to conventional charging procedures, the following requirements shall be followed.

Ensure that contamination of different refrigerants does not occur when using charging equipment.

Hoses or lines shall be as short as possible to minimise the amount of refrigerant contained in them.

Cylinders shall be kept in an appropriate position according to the instructions.

Ensure that the refrigeration system is earthed prior to charging the system with refrigerant. Label the system when charging is complete (if not already). Extreme care shall be taken not to overfill the refrigeration system. Prior to recharging the system it shall be pressure tested with OFN. The system shall be leak tested on completion of charging but prior to commissioning. A follow up leak test shall be carried out prior to leaving the site.

13. Decommissioning

Before carrying out this procedure, it is essential that the technician is completely familiar with the equipment and all its detail. It is recommended good practice that all refrigerants are recovered safely.

Prior to the task being carried out, an oil and refrigerant sample shall be taken in case analysis is required prior to re-use of reclaimed refrigerant. It is essential that electrical power is available before the task is commenced.

- a) Become familiar with the equipment and its operation.
- b) Isolate system electrically.
- c) Before attempting the procedure ensure that: Mechanical handling equipment is available, if required, for handling refrigerant cylinders; all personal protective equipment is available and being used correctly; the recovery process is supervised at all times by a competent person; recovery equipment and cylinders conform to the appropriate standards.
- d) Pump down refrigerant system, if possible.
- e) If a vacuum is not possible, make a manifold so that refrigerant can be removed from various parts of the system.
- f) Make sure that cylinder is situated on the scales before recovery takes place.
- g) Start the recovery machine and operate in accordance with manufacturer's instructions.
- h) Do not overfill cylinders. (No more than 80 % volume liquid charge).
- i) Do not exceed the maximum working pressure of the cylinder, even temporarily.
- j) When the cylinders have been filled correctly and the process completed, make sure that the cylinders and the equipment are removed from site promptly and all isolation valves on the equipment are closed off.
- k) Recovered refrigerant shall not be charged into another refrigeration system unless it has been cleaned and checked.

14. Labelling

Equipment shall be labelled stating that it has been de-commissioned and emptied of refrigerant. The label shall be dated and signed. Ensure that there are labels on the equipment stating the equipment contains flammable refrigerant.

15.Recovery

When removing refrigerant from a system, either for servicing or decommissioning, it is recommended good practice that all refrigerants are removed safely. When transferring refrigerant into cylinders, ensure that only appropriate refrigerant recovery cylinders are employed. Ensure that the correct number of cylinders for holding the total system charge is available. All cylinders to be used are designated for the recovered refrigerant and labelled for that refrigerant (i.e. special cylinders for the recovery of refrigerant). Cylinders shall be complete with pressure relief valve and associated shut-off valves in good working order. Empty recovery cylinders are evacuated and, if possible, cooled before recovery occurs. The recovery equipment shall be in good working order with a set of instructions concerning the equipment that is at hand and shall be suitable for the recovery of the flammable refrigerant. If in doubt, the manufacturer should be consulted. In addition, a set of calibrated weighing scales shall be available and in good working order. Hoses shall be complete with leak-free disconnect couplings and in good condition.

The recovered refrigerant shall be processed according to local legislation in the correct recovery cylinder, and the relevant waste transfer note arranged. Do not mix refrigerants in recovery units and especially not in cylinders. If compressors or compressor oils are to be removed, ensure that they have been evacuated to an acceptable level to make certain that flammable refrigerant does not remain within the lubricant. The compressor body shall not be heated by an open flame or other ignition sources to accelerate this process. When oil is drained from a system, it shall be carried out safely.

Operation of Current Device

The power supply cord contains a current measuring device that detects damage to the power cord. Test your power supply cord as follows:

1. Plug in the air conditioner.
2. The power supply cord will have TWO buttons on the plug head. Press the TEST button. You will notice a click as the RESET button pops out.
3. Press the RESET Button. You will notice a click as the button engages.
4. The power supply cord is now supplying electricity to the unit. (On some products this is also indicated by a light on the plug head.)

NOTE

The power supply cord with this air conditioner contains a current detection device designed to reduce the risk of fire.

In the event that the power supply cord is damaged, it can not be repaired. It must be replaced with a cord from the manufacturer.

NOTE

- Do not use this device to turn the unit on or off.
- Always make sure the RESET button is pushed in for correct operation.
- The power supply cord must be replaced if it fails to reset when either the TEST button is pushed, or it can not be reset. Please contact Customer Service.

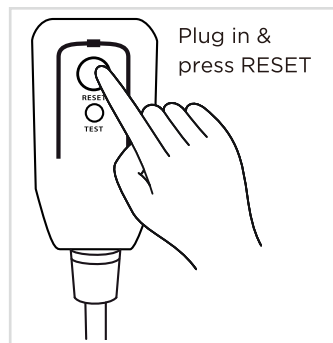

Grounding type wall receptacle

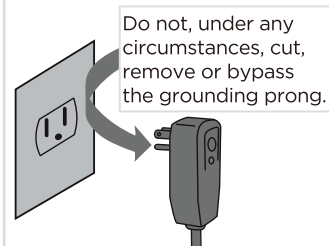

Power supply cord with 3-prong grounding plug and current detection device.

PRODUCT INSTALLATION

WARNING - Before You Begin

Read these instructions completely and carefully.

- **IMPORTANT** - Save these instructions.
- **IMPORTANT** - Observe all governing codes and ordinances.

We recommend that two people install this product.

Proper installation is the responsibility of the installer.

Product failure due to improper installation is not covered under the Limited Warranty.

You **MUST** use all supplied parts and use proper installation procedures as described in these instructions when installing this air conditioner.

Do not, under any circumstances, cut or remove the third (ground) prong from the power cord.

Do not change the plug on the power cord of the air conditioner.

Aluminum house wiring may present special problems - consult a qualified electrician.

When handling the air conditioner, be careful to avoid cuts from sharp metal edges and aluminum fins on front and rear coils. Please wear cut-resistant gloves.

Bracket should only be used for its intended purpose. If not, the warranty will be voided.

Tools You Will Need

Phillips Screwdriver

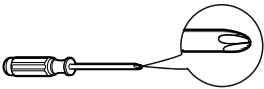

Level



Flathead Screwdriver



Pencil



Ruler or tape measure



Scissors or knife





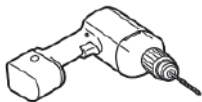



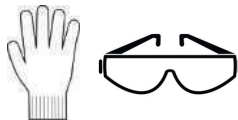

Drill and 1/8" drill bit



Proper PPE



Installation Hardware

	1/2" Screws	7		Weather stripping (10" x 1-1/2" x 1/6")	2
	Lock frame (For Wooden windows)	2		Window sash seal foam	1
	Lock frame (For Vinyl-Clad windows)	2		3/8" Screws	4
	Sash lock	1		Top Rail	1

Some assembly is required. Please read these instructions carefully.

NOTE

- SAVE CARTON and these INSTALLATION INSTRUCTIONS for future reference. The carton is the best way to store unit during winter, or when not in use.
- DO NOT USE ANY SCREWS OTHER THAN THOSE SPECIFIED HERE.
- FOR SAFETY REASONS, THE TOP RAIL MUST BE SECURELY FASTENED WITH ALL FOUR (4) SCREWS.

Before installing unit, the top rail must be assembled on the unit.

- Remove the air conditioner from the carton and place on a flat surface.
- Remove top rail from the rear of the packaging material as shown in Fig. A.
- Align the hole in the top rail with those in the top of the unit as shown in Fig. B.
- Secure the top rail to the unit with the 3/8" Screws as shown in Fig. C.

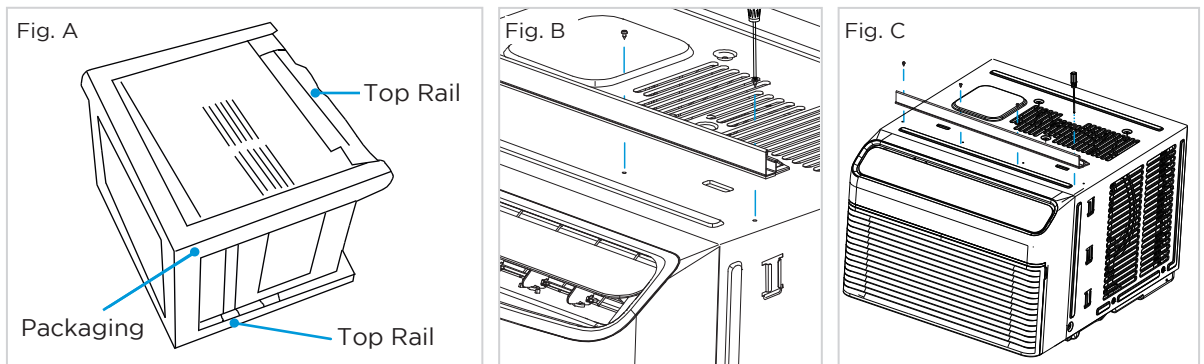

Installation

Left + Right filler panel assembly

NOTE

Top Rail and Side Panels at each side are offset to provide the proper pitch to the rear of (5/16"). This is necessary for proper condensed water utilization and drainage. If you are not using the Side Panels for any reason, this pitch to the rear must be maintained!

1. Install Side Filler Panels

Place unit on floor, a bench or a table. There is a left and right side filler panels - be sure to use the proper panel for each side. When installed, the flange for securing the panel in place to the window sill will be facing into the room.

- A. Hold the side panel in one hand and gently pull back the center to free the open end. See Fig. 1.
- B. Slide the free and "T" section of the panel directly into the cabinet as shown in Fig. 2. Slide the panel down. Be sure to leave enough space to slip the top and bottom of the frame into the rails on the cabinet.
- C. Once the panel has been installed on the side of the cabinet, make sure it sits securely inside the frame channel by making slight adjustments. Slide the top and bottom ends of the frame into the top and bottom rails of the cabinet. Fig. 3.
- D. Slide the panel all the way in and repeat on the other side.

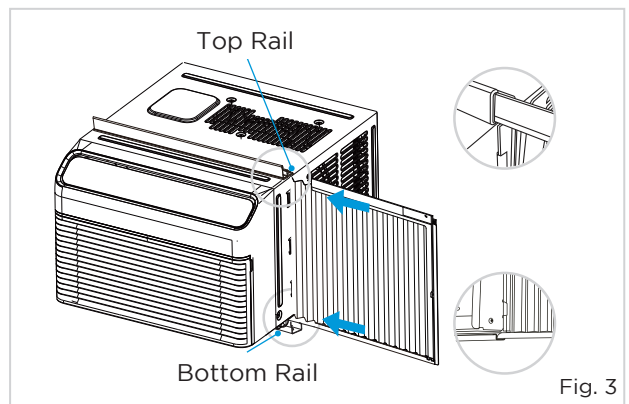
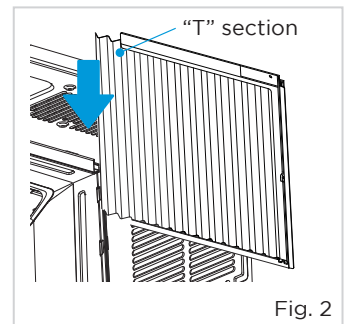
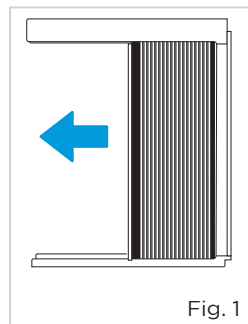

Your air conditioner is designed to install in standard double hung windows with opening widths of 23.6 to 38.8 inches (600 mm to 985mm) (Fig. 4A, Fig. 4B).

Lower sash must open sufficiently to allow a clear vertical opening of 13.8 inches (350 mm).

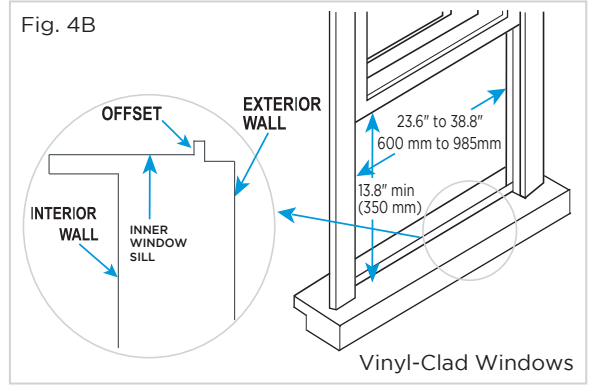
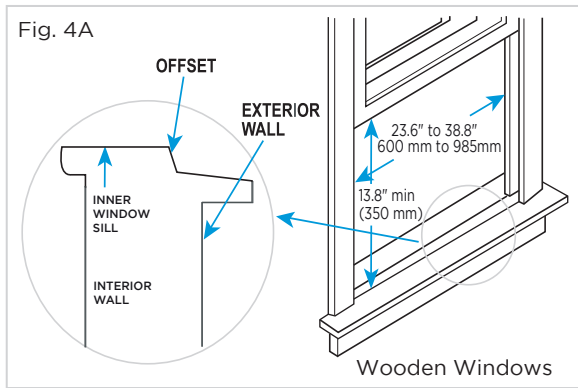

Side louvers and the rear of the air conditioner must have clear air space to allow enough airflow through the condenser, for heat removal. The rear of the unit must be outdoors, not inside a building or garage. There should be at least 11.8 inches (300 mm) clearance around the unit. See Fig. 4C & Fig. 4D.

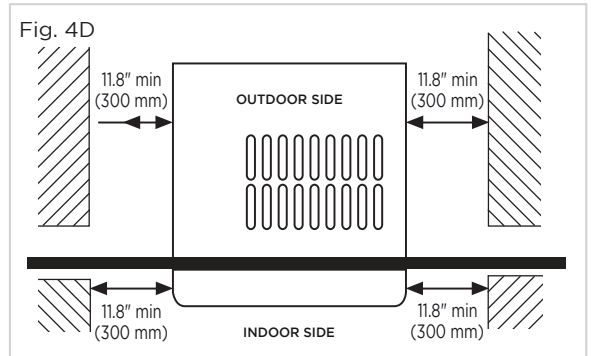
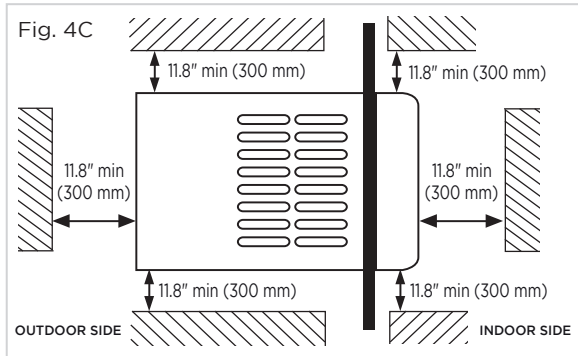

2. Storm Window

If the air conditioner is blocked by Storm Window, add wood as shown in Fig. 5, or remove storm window before air conditioner is installed.

If Storm Window Frame must remain, be sure the drain holes or slots are not caulked or painted shut. Accumulated Rain Water or Condensation must be allowed to drain out.

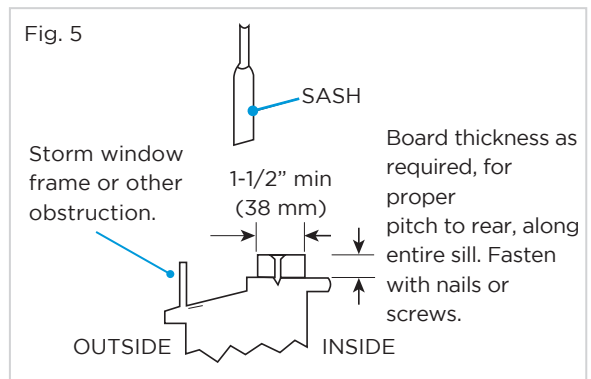

3. Place the Unit Into the Window

Keep a firm grip on the air conditioner, carefully place the unit into the window opening so the bottom of the air conditioner frame is against the window sill (Fig. 6A & Fig. 6B). Carefully close the window behind the top rail of the unit.

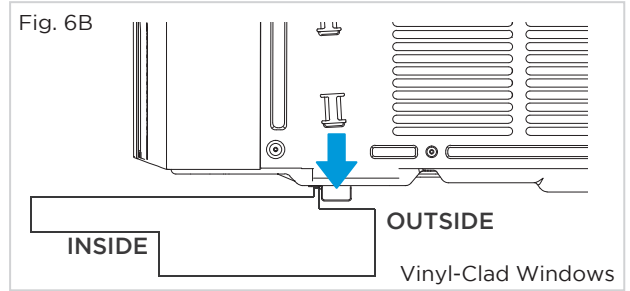
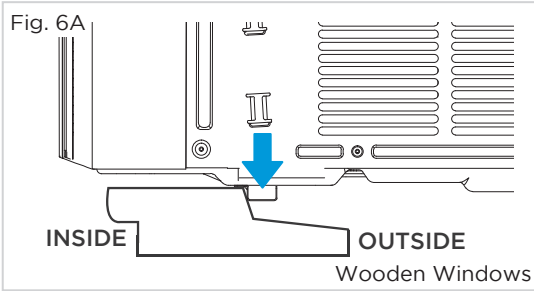

4. Extend the Side Panels

Extend the side panels out against the window frame (Fig. 7A for wooden windows), (Fig. 7B for Vinyl-Clad windows).

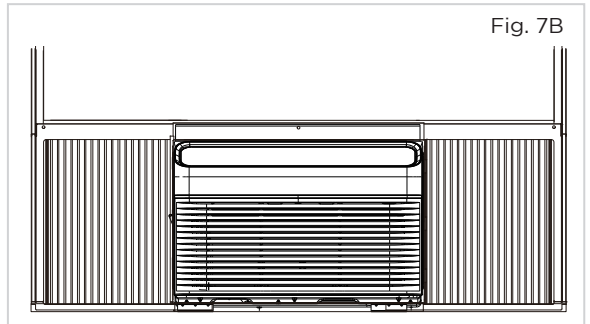
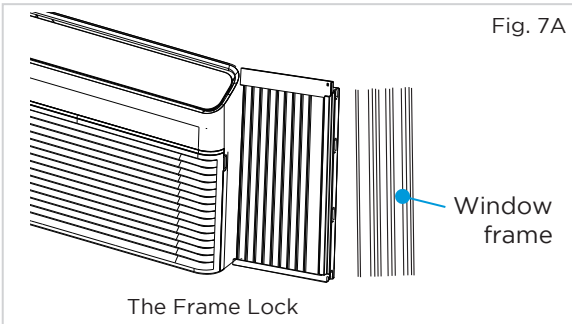

5. Install the Frame Lock

Place the frame lock between the frame extensions and the window sill as shown (Fig. 8A for wooden windows), (Fig. 8B for Vinyl-Clad windows).

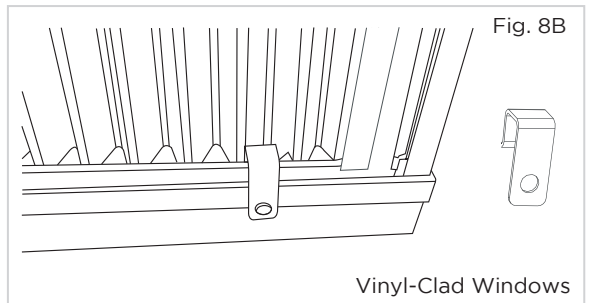
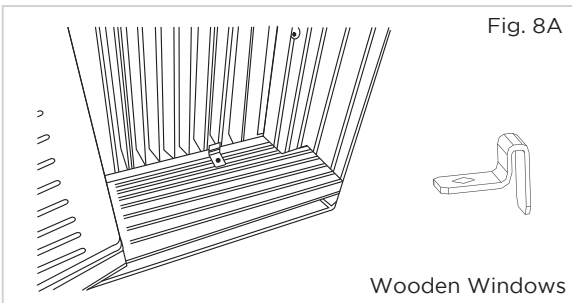

6. Drive Locking Screws

A: For wooden windows:

Drive 1/2" (12.7 mm) locking screws through the frame lock and into the window sash (Fig. 9B).

NOTE

Before driving the screws, use a drill to drill 5 holes through the holes in the frame lock and frame extensions into the window sash as shown (Fig. 9B).

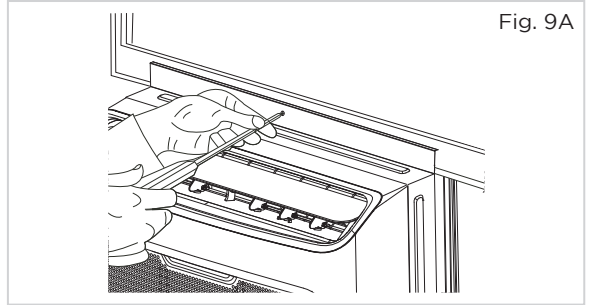

B: For Vinyl-Clad windows:

Drive 1/2" (12.7 mm) locking screws through the frame lock and into the sill (Fig. 9A).

NOTE

To prevent window sill from splitting, drill 1/8" (3mm) pilot holes before driving screws.

Drive 1/2" (12.7 mm) locking screws through frame holes into window sash (Fig. 9B).

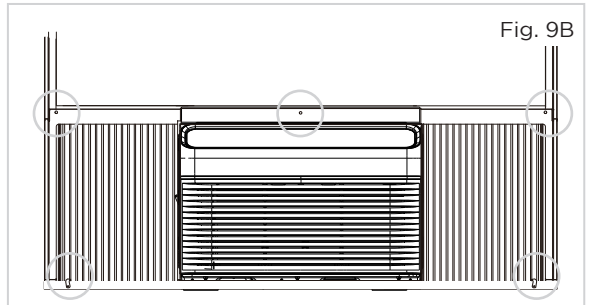

7. Secure Lower Sash

A. To secure lower sash in place, attach right angle sash lock with 1/2"(12.7 mm) screw as shown (Fig. 10).

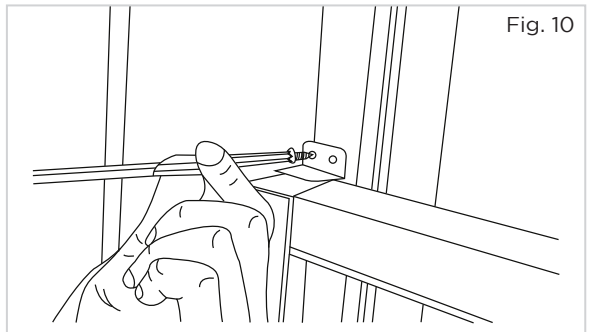

B. Cut foam window seal and insert it into the space between the upper and lower sashes (Fig. 11).

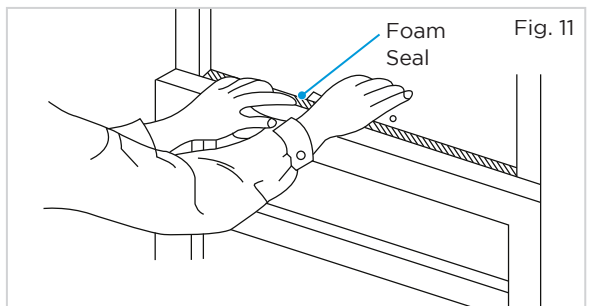

8. Check Installation

Check that air conditioner is tilted back about 1/4" to 1/2" (tilted about 2° to 4° downward to the outside, see Fig. 12A & Fig. 12B). After proper installation, condensate, should not drain from the overflow drain hole during normal use, correct the slope otherwise.

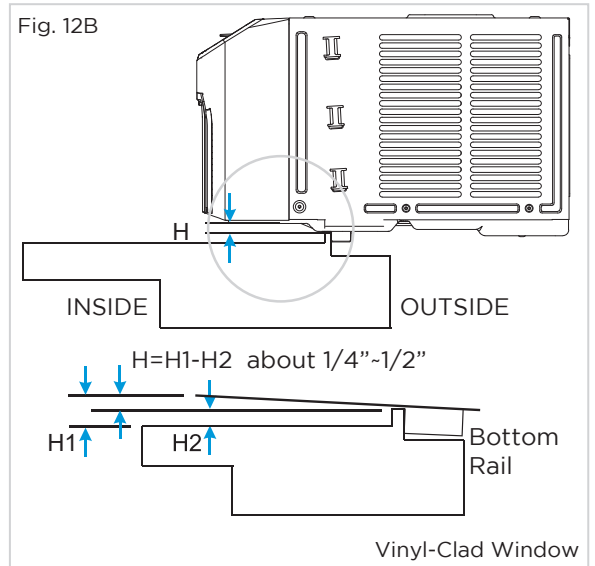
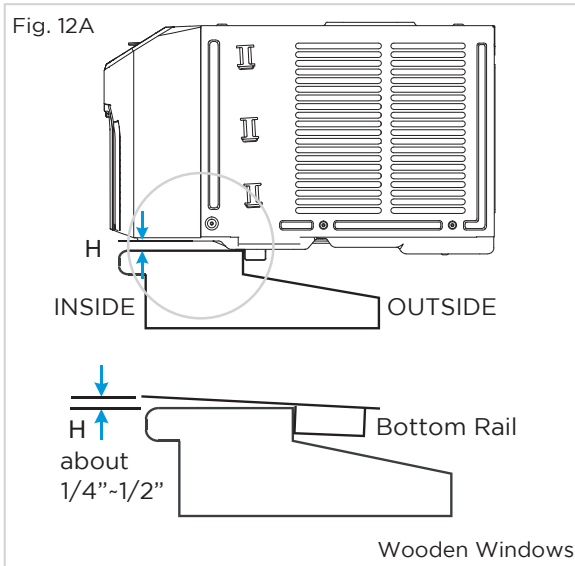

9. Suitable Weather Stripping

In order to minimize air/light leaks between the room air conditioner and the window opening, suitable weather stripping (trim the provided weather stripping into suitable size) should be applied in case of any gaps found at the location as indicated by the arrows in Fig. 13.

Removing the air conditioner from Window

- Turn the air conditioner off, and disconnect power cord.
- Remove sash seal from between windows, and unscrew sash lock.
- Remove screws installed through frame and framelock.
- Remove the insulation panel and close (slide) side panels into frame.
- Keeping a firm grip on air conditioner, raise sash and carefully remove.
- Be careful not to spill any condensate water while lifting unit from window. Store parts WITH air conditioner.



10. Drain Plug

1. The drain plug should remain in place for optimal performance.
2. If you need to store the unit for an extended period, it is recommended to remove the drain plug first, drain the water and then reinstall the drain plug and pack it for storage.

The location of the drain plug and guide label are shown as below.

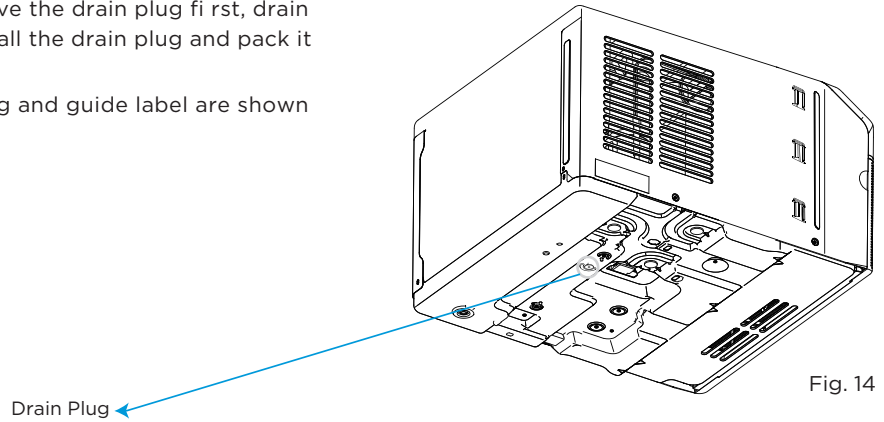

Fig. 14

OPERATION INSTRUCTIONS

Normal Sounds

High Pitched Chatter

High efficiency compressors may have a high pitched sound during cooling cycle.

Sound of Rushing Air

In front of the unit, you may hear the sound of rushing air being moved by the fan.

Gurgle/Hiss

Gurgling or hissing noises may be heard due to refrigerant flowing through evaporator during normal operation.

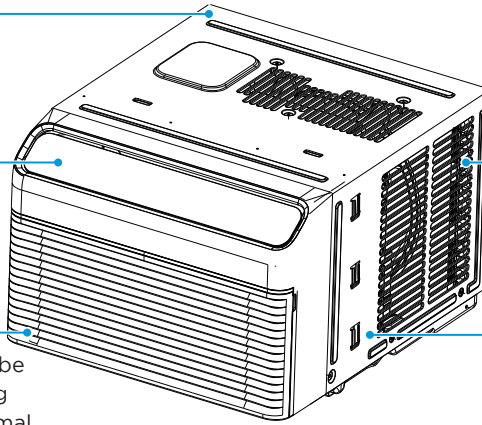

Trickling Sound

Droplets of water hitting condenser during normal operation may cause a trickling sound.

Vibration

Unit may vibrate and make noise because of poor wall or window construction or incorrect installation.

NOTE

All the illustrations in this manual are for explanation purpose only. The actual installation may vary.

Air Conditioner Operation

WARNING

To reduce the risk of fire, electrical shock, or injury to people or property, read the SAFETY PRECAUTIONS before operating this appliance.

Cooling Operation	Outdoor temp.: 64°F ~ 109°F / 18°C ~ 43°C
	Indoor temp.: 60°F ~ 90°F / 16°C ~ 32°C
Heating Operation	Outdoor temp.: 41°F ~ 75°F / 5°C ~ 24°C
	Indoor temp.: 41°F ~ 80°F / 5°C ~ 27°C

NOTE

- The relative humidity of the room should be less than 80%. If the unit is used in a condition with a relative humidity over 80%, there will be condensed water on the surface of the unit.
- Performance may be reduced outside of these operating temperatures.

NOTE

Always wait 3 minutes when turning the unit off and then on again, or when changing from cool to fan and back to cool. This prevents damage from occurring to the compressor.

To begin operating the air conditioner, follow these steps:





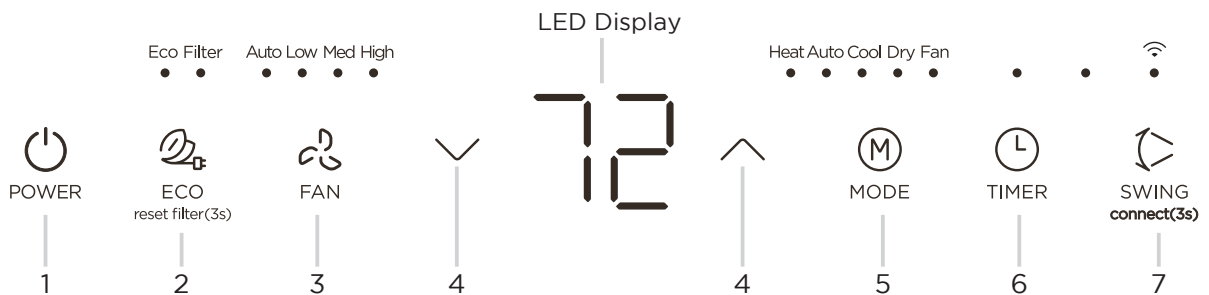

1. Plug in the air conditioner (be sure to follow the power cord instructions).
2. Turn the power on to the air conditioner, using the ON/OFF button.
3. Set the thermostat to the coldest temperature setting.
4. Select the Cool mode setting.
5. Adjust the louver for comfortable air flow (see Air Directional Louvers).
6. Once the room has cooled, adjust the thermostat to the setting you find most comfortable.
7. Make sure the air flow inside and outside is not obstructed by anything.

Air Conditioner Features

ELECTRONIC CONTROL OPERATING INSTRUCTIONS

Before you begin, thoroughly familiarize yourself with the control panel as shown below and all its functions, then follow the symbol for the functions you desire. The unit can be controlled by the control panel, remote control, smart phone app or voice control.



		Description
1	 POWER	ON / OFF <ul style="list-style-type: none"> • Press to turn unit on or off.
2	 ECO reset filter(3s)	ECO / Check Filter Feature <ul style="list-style-type: none"> • Press to initiate this feature, which will maintain comfort and save energy. • Press for 3 sec to turn off the cleaning filter reminder.
3	 FAN	Fan Speed <ul style="list-style-type: none"> • Press to select the Fan Speed in four steps - Auto, Low, Med or High.
4		UP / DOWN Button <ul style="list-style-type: none"> • Press to change temperature setting.
5	 MODE	Mode Functions <ul style="list-style-type: none"> • Press to choose operating mode in a sequence that goes from Heat, Auto, Cool, Dry and Fan.
6	 TIMER	Timer Feature <ul style="list-style-type: none"> • Press to turn unit Auto Start/Stop.
7	 SWING connect(3s)	Swing / Connect Feature <ul style="list-style-type: none"> • Press to initiate the auto swing feature. • Press for 3 sec to initiate smart connection mode (<i>on some models</i>).

1. ON/OFF Button

Press POWER button to turn unit on or off.

NOTE

The unit will automatically initiate the Energy Saver function under Cool, Dry, and Auto modes.

2. ECO Button

Press ECO button to initiate this function. This function is available on COOL, DRY, and AUTO (only AUTO-COOLING and AUTO-FAN) modes. The fan will continue to run for 3 minutes after the compressor shuts off. The fan then cycles on for 2 minutes at 10 minute intervals until the room temperature is above the set temperature, at which time the compressor turns back on and Cooling Starts.

Press ECO button for 3 seconds to initiate the filter feature. This feature is a reminder to clean the Air Filter for more efficient operation. The LED (the light above the button) will illuminate after 250 hours of operation.

3. FAN Button

Press Fan button to select the Fan Speed in four steps - Auto, Low, Med or High. Each time the button is pressed, the fan speed mode is shifted. For some models, the fan speed can not be adjusted.

4. UP/DOWN Button

Press UP (^) or DOWN (v) button to change temperature setting.

NOTE

Press or hold either UP (^) or DOWN (v) button until the desired temperature is shown on the display. This temperature will be automatically maintained anywhere between 60°F (16°C) and 86°F (30°C). If you want the display to read the actual room temperature, see “To Operate on Fan Only” section.”

5. MODE Button

To choose operating mode, press the MODE button. Each time you press the button, a mode is selected in a sequence that goes from Heat, Auto, Cool, Dry and Fan. The indicator light beside the button will be illuminated and will remain on once that mode is selected. The unit will automatically initiate the Energy Saver function under Cool, Dry, and Auto (only Auto-Cooling and Auto-Fan) modes.

To operate on AUTO feature:

- When you set the air conditioner to Auto mode, it will automatically select cooling, heating or fan only operation, depending on what temperature you have selected and the current room temperature.
- The air conditioner will control the room temperature automatically based on then temperature you set.

- In this mode, the fan speed cannot be adjusted, it starts automatically at a speed according to the room temperature.

To operate on COOL mode:

- Choose Cool Mode to set the cooling function. Use the UP (^) and DOWN (v) buttons to choose the desired temperature. When Cool Mode is selected, the fan speed can be adjusted by pressing the fan button.

To operate on DRY mode:

- In this mode, the air conditioner will generally operate as a dehumidifier. Since the conditioned space is a closed or sealed area, some degree of cooling will continue. On Dry mode, the fan speed is not adjustable.

To operate on FAN Only:

- Use this function only when cooling is not desired, such as for room air circulation or to exhaust stale air (on some models). (Remember to open the vent during this function, but keep it closed during cooling for maximum cooling efficiency.) You can choose any fan speed you prefer.
- In Fan only mode, the temperature is not adjusted.

To operate on HEAT mode (Cooling models without):

- Choose Heat Mode to set the heating function. Use the UP (^) and DOWN (v) buttons to choose the desired temperature. When Heat Mode is selected, the fan speed can be adjusted by pressing the fan button.
- If the outdoor side temperature is below 41°F, the machine will shut off and display ‘LO’.

6. TIMER Button

- Press Timer button, the TIMER indicator light illuminates. It indicates the Auto Start or Auto Stop program is initiated. For some units, continuing to press the Timer button will cancel the timer settings.
- Press or hold the UP (^) or DOWN (v) button to change the Auto time by 0.5 hour increments, up to 10 hours, then at 1 hour increments up to 24 hours. The control will count down the time remaining until start.
- The selected time will register in 5 seconds, and the system will automatically revert back to display the previous temperature setting or room temperature when the unit is on. When the unit is off, there is no display.
- Turning the unit ON or OFF at any time or adjusting the timer setting to 0.0 will cancel the Auto Start/Stop timed program.

NOTE

To cancel timer operation, press and hold the timer button for 2 seconds until the beep/buzzer is heard.

7. SWING Button

Used to initiate the Auto swing feature. When the operation is ON, pressing the SWING button can stop the louver at the desired angle.

Wireless operation (on some models):

- For the first time to use Wifi function, press the SWING button for 3 seconds to initiate the Wifi connection mode. The LED DISPLAY shows 'AP' to indicate you can set Wifi connection. If connection (router) is successful within 8 minutes, the unit will exit Wifi connection mode automatically and the Wireless indicator illuminates. If connection is failure within 8 minutes, the unit exits Wifi connection mode automatically. After Wifi connection is successful, you can press and hold POWER and DOWN (∨) buttons at the same time for 3 seconds to turn off Wifi function and the LED DISPLAY shows 'OF' for 3 seconds, press POWER and UP (^) buttons at the same time to turn on Wifi function and the LED DISPLAY shows 'On' for 3 seconds.

FRESH operation (on some models):

- Press SWING and TIMER buttons at the same time for 3 seconds to initiate FRESH feature and the FRESH light illuminates on some models, the LED DISPLAY shows 'On' for 3 seconds. The ion generator is energized and will help to purify the air inside. Press it for 3 seconds again to stop the FRESH feature and the FRESH light turn dark on some models, the LED DISPLAY shows 'OF' for 3 seconds for some units.

Displays

LED Display:

Shows the set temperature in "°C" or "°F" and the Auto-timer settings. While on Fan Only mode, it shows the room temperature. If the room temperature is too high or low, it will display "HI" or "LO".

The control is capable of displaying temperature in degrees Fahrenheit or degrees Celsius. To convert from one to the other, press and hold the UP (^) or DOWN (∨) buttons at the same time for 3 seconds.



Error codes:

The unit may stop operation due to a malfunction with the unit. If this occurs, an error code may appear on the display like below.

Wait 10 minutes as the problem may resolve itself. If not, disconnect the power, then connect it again. Turn the unit on.

If the problem persists, disconnect the power and contact customer service.

Error code appears and begins with the letters as the following in the window display of indoor unit:

EH(xx), EL(xx), EC(xx), PH(xx), PL(xx), PC(xx)

NOTE

If the unit turns off unexpectedly due to the power being cut, it will automatically restart with the previous function setting when the power resumes.

Air Directional Louvers

The louvers will allow you to direct the air flow up or down (on some models) and left or right throughout the room as needed. Use the SWING button until the desired up/down direction is obtained.

Move the louvers from side to side until the desired left/right direction is obtained.

Use SWING button for up/down direction

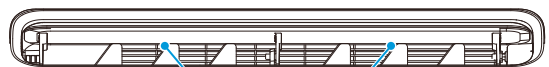
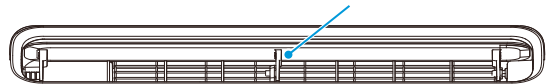

Adjust louvers for left/right direction



Air Direction

REMOTE CONTROL AND APP INSTRUCTIONS

Handling the Remote Control

Location of the remote control

Use the remote control within a distance of 26 ft. (8m) from the air conditioner, pointing it towards the unit. The unit will beep when it receives a signal.

CAUTION

- The air conditioner will not operate if curtains, doors or other materials block the signals from the remote control to the unit.
- Prevent any liquid from spilling onto the remote control. Do not expose the remote control to direct sunlight or heat.
- If the infrared signal receiver on the indoor unit is exposed to direct sunlight, the air conditioner may not function properly. Use curtains to prevent the sunlight from falling on the receiver.
- If other electrical appliances react to the remote control, either move these appliances or consult your local dealer.

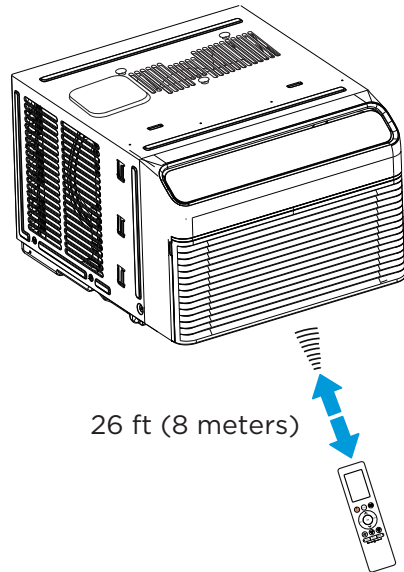

Inserting and Replacing Batteries

Your air conditioning unit may come with two batteries (some units). Put the batteries in the remote control before use.

1. Slide the back cover from the remote control downward, exposing the battery compartment.
2. Insert the batteries, paying attention to match up the (+) and (-) ends of the batteries with the symbols inside the battery compartment.
3. Slide the battery cover back into place.

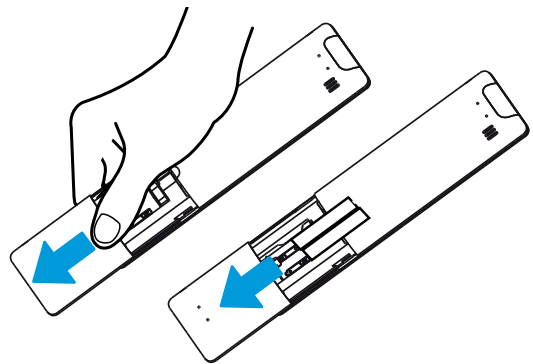

Remote Control Specifications

Rated Voltage	3.0V (Dry batteries R03/LR03x2)
Signal Receiving Range	26 ft (8 m)
Environment	-5 °C ~ 60 °C (23°F ~ 140°F)

Function Buttons

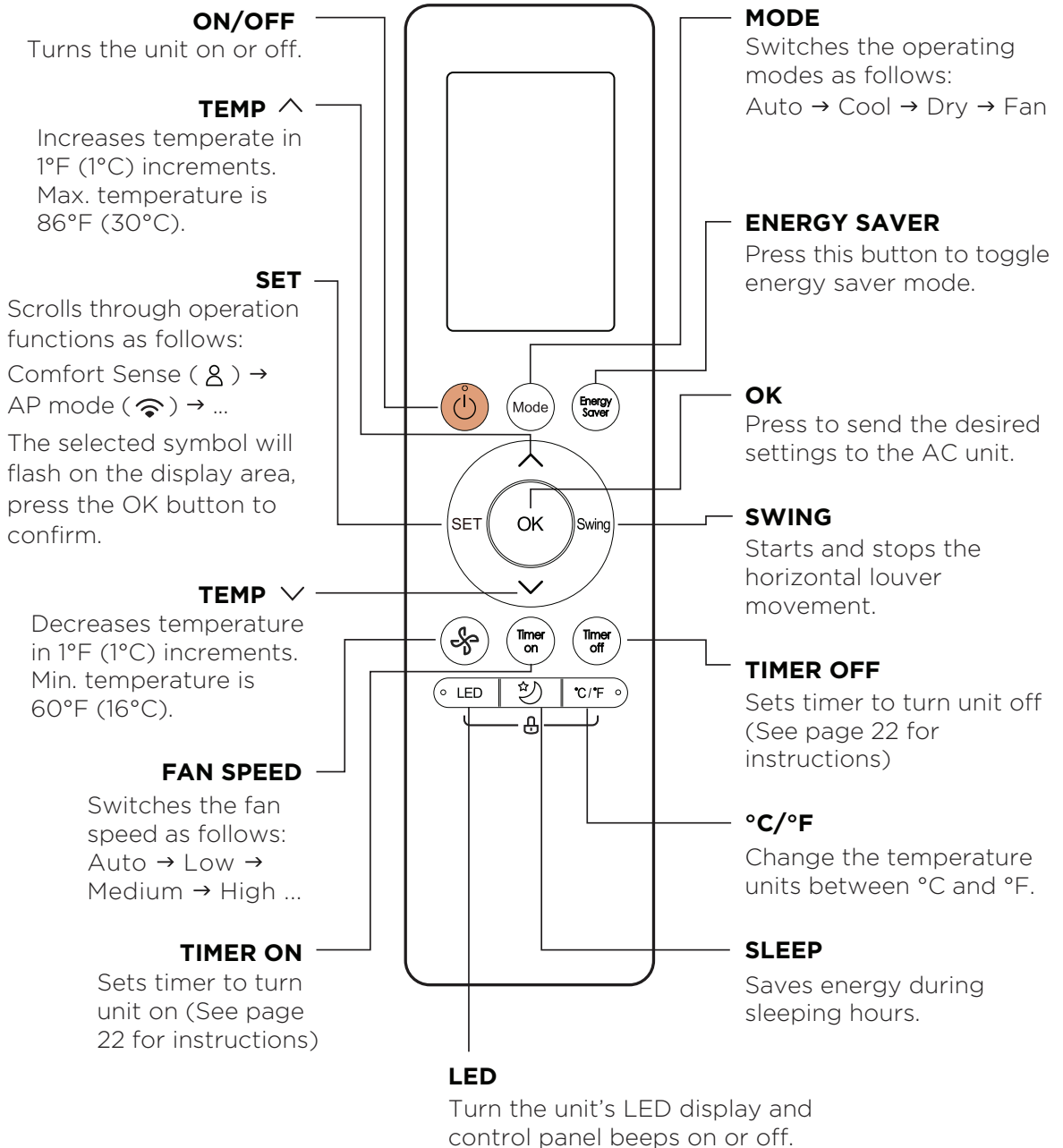

Remote Screen Indicators

Information is displayed when the remote control is powered on.

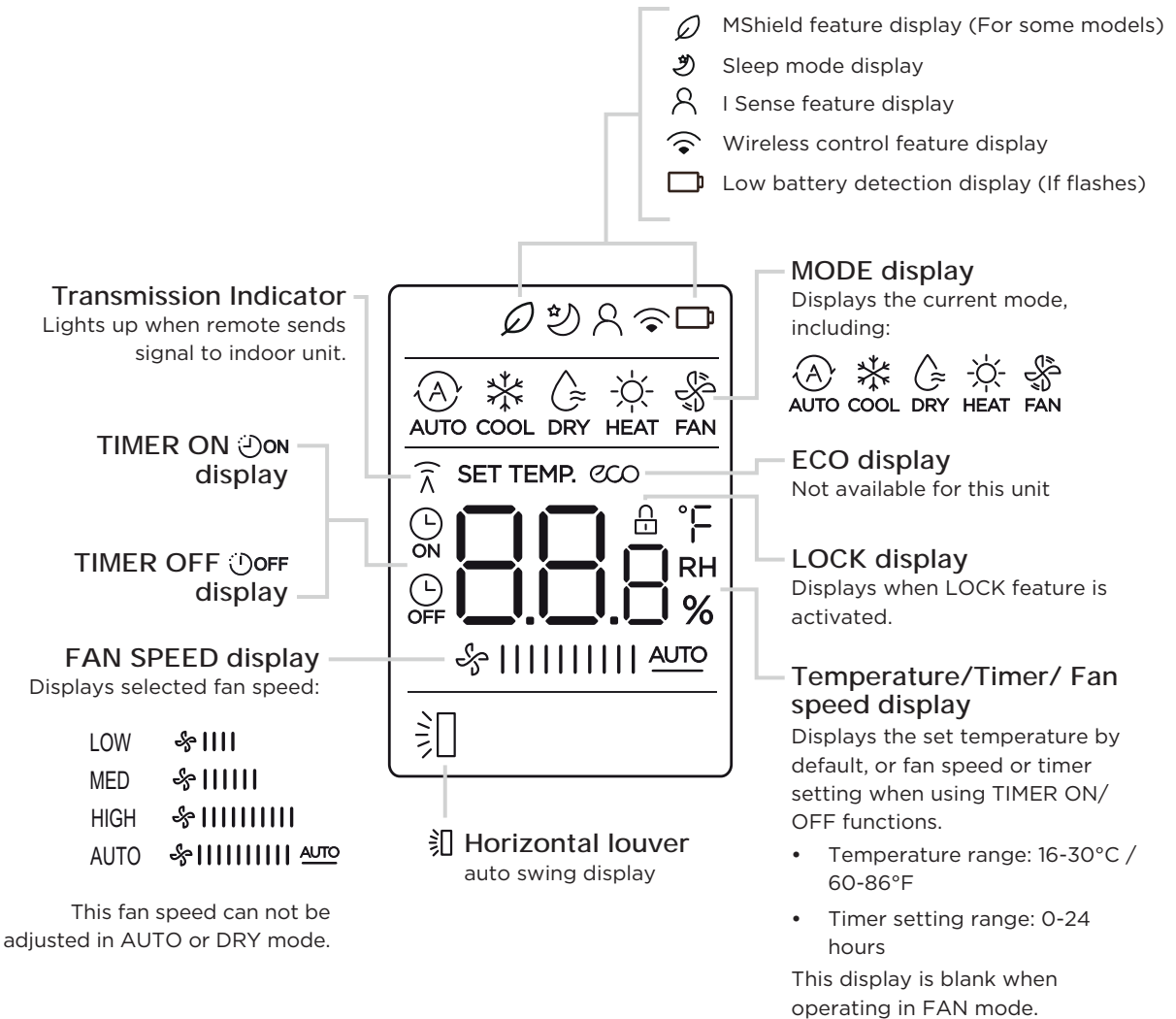

Supplier's Declaration of Conformity 47 CFR § 2.1077 Compliance Information

Unique Identifier: Midea RG10G2(B2)/BGEFU1

Responsible Party U.S. Contact Information

Midea America Corporation
300 Kimball Dr
Parsippany NJ
07054

Telephone number or internet contact information: Midea.com/us

FCC Compliance Statement (products subject to Part 15)

This device complies with Part 15 of the FCC Rules. Operation is subject to the following two conditions: (1) This device may not cause harmful interference, and (2) this device must accept any interference received, including interference that may cause undesired operation.

Setting the TIMER

TIMER ON/OFF

Set the amount of time after which the unit will automatically turn on/off.

TIMER ON SETTING

Press TIMER ON button to initiate the ON time sequence.

Press up or down button for multiple times to set the desired time to turn on the unit.

Point remote to unit and wait 1sec, the TIMER ON will be activated.

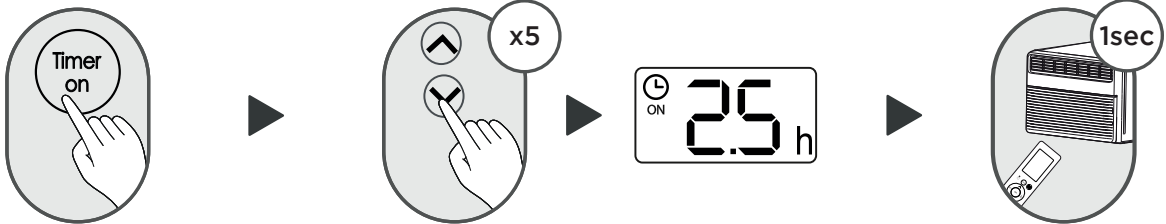

TIMER OFF SETTING

Press TIMER OFF button to initiate the OFF time sequence.

Press up or down button for multiple times to set the desired time to turn off the unit.

Point remote to unit and wait 1sec, the TIMER OFF will be activated.

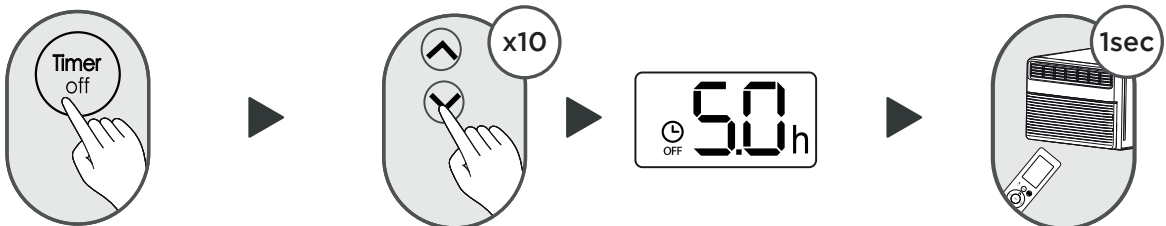

NOTE

1. When setting the TIMER ON or TIMER OFF, the time will increase by 30 minutes increments with each press, up to 10 hours. After 10 hours and up to 24, it will increase in 1 hour increments. (For example, press 5 times to get 2.5h, and press 10 times to get 5h,). The timer will revert to 0.0 after 24.
2. Cancel either function by setting its timer to 0.0h.

TIMER ON & OFF SETTING (example)

Keep in mind that the time periods you set for both functions refer to hours after the current time.

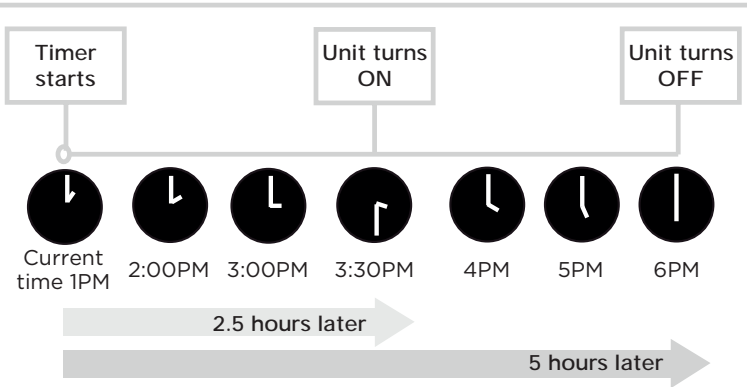
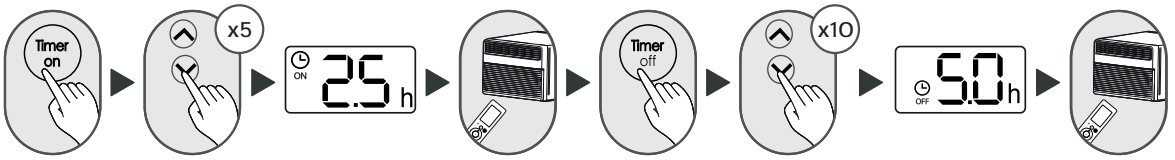

Example: If current time is 1:00PM, to set the timer as above steps, the unit will turn on 2.5h later (3:30PM) and turn off at 6:00PM.:

Declaration of Conformity

We hereby declare that this AC is in compliance with the essential requirements and other relevant provisions of Directive 1999/5/EC.

APP INSTRUCTIONS

Specification of Wireless Module

Model: MAW08HVICWT,MAW12HVICWT,MAW12HVICWT-A	Operation Temperature: 0°C ~ 45°C / 32°F ~ 113°F
Wireless Module Model: US-SK109	Operation Humidity: 10% ~ 85%
Antenna Type: Printed PCB Antenna	Power Input: DC 5V / 500 mA
Frequency Band: 2400 - 2483.5MHz	Maximum TX Power: < 20dBm

Precautions

1. Supports operating systems: iOS 10+ or Android 5+.
2. In the event of a OS update, there may be a delay between the update of the OS and a related software update during which your OS may or may not be supported until a new version is released. Your specific mobile phone or problems in your network may prevent the system from working and Midea will not be responsible for any problems that could be caused by incompatibility or network issues.
3. This Smart AC only supports WPA-PSK/WPA2-PSK (recommended) encryption.
4. To ensure proper scanning of the QR code, your smart phone must have at least a 5-megapixel camera.
5. Due to unstable network connectivity, requests may time out. If this happens, re-run the network configuration.
6. Due to unstable network connectivity, commands may time out. If this happens, the smartphone app and the actual product may display conflicting information. The information displayed on the actual product is always the most accurate available. Refresh the app to re-sync.

NOTE

Midea will not be responsible for any problems that could be caused by incompatibility or network issues, your wireless router and mobile phone.

1. How to Use SmartHome App

 Ensure that your mobile phone is connected to the wireless network. Bluetooth must be turned on. The device must also be powered up.

STEP 1: Download the SmartHome App

Scan the QR code below to download the SmartHome app from the app store or search for it directly on the Google Play Store or Apple's App Store.

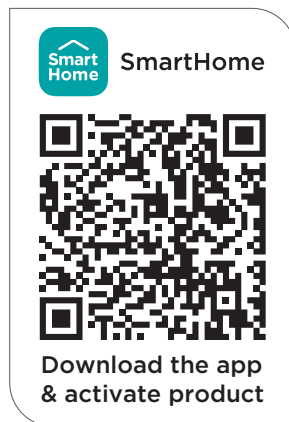

STEP 2: Log in

Open the SmartHome app. Log in directly if you have an existing SmartHome account or create a new account. Alternatively, you can also use a 3rd party login platform.

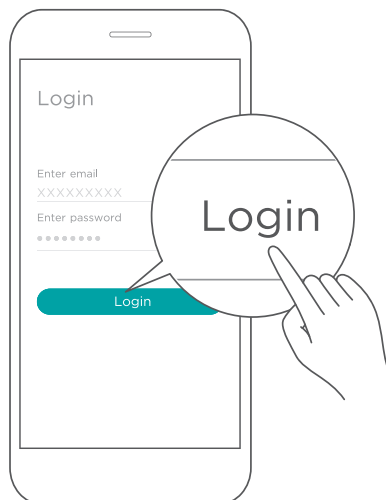

STEP 3: Connecting the Device

- 1) When you log in, you may see the message "Smart devices discovered nearby". Tap to add your device.

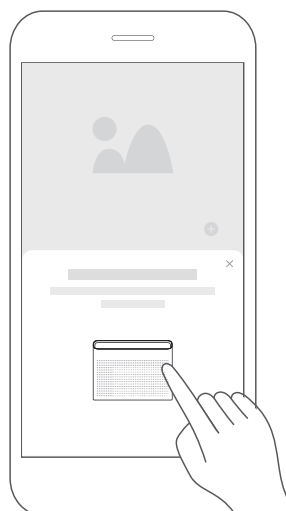

- 2) If no such message appears, proceed as follows: Tap on “+” and select your device in the list of nearby available devices.

If your device is not listed, please add your device manually, first selecting the device category e.g. Window AC.



- 3) Follow the steps in the app to connect your device to the wireless network. If your device fails to connect, follow the additional instructions in the app.

For Window AC

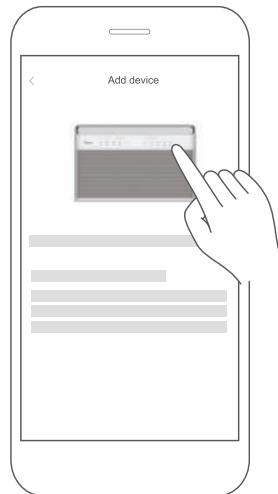

For Portable AC



STEP 4: Controlling the Device

After pairing successfully, a card will be created for the device in the SmartHome app.

Shortcuts for basic functions will appear on the card such as changing the temperature or switching the device on or off.

Tapping on the card, will reveal additional features and settings. The actual UI design may look different from examples due to app updates.

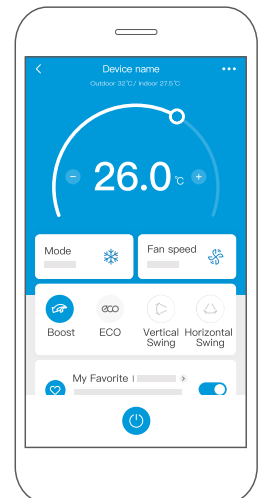
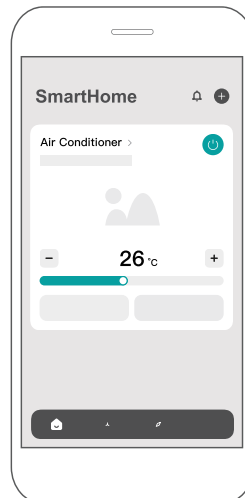

2. How to Use Matter

Matter is a connectivity technology that unifies the smart home by allowing devices and ecosystems (such as Alexa, Google Home and Apple Home) to speak the same language thus creating exciting new features and use cases.

To use Matter, you will need at least one Matter enabled smart speaker from Amazon, Google or Apple, and it's respective app.

- If you have a Matter enabled smart speaker, please proceed to the “How to use Matter” instructions on the following pages.
- If you don't have a Matter enabled smart speaker, you won't be able to use Matter right now. However, you can still achieve full functionality of the product by using our SmartHome app. To do this, proceed to the “How to use SmartHome app” section back on page 20.

Connect Your Air Conditioner Through Matter



Make sure your mobile device is connected to your wireless router.

Wireless router should support and turn on IPv6. Please make sure your smartphone connect to 2.4G but not 5G network.

STEP 1: Connect to Smart Speakers

Select your preferred ecosystems (Alexa, Google Home or Apple Home) and make sure you've got one of their Matter enabled products (such as their smart speakers) connected to your wireless router.

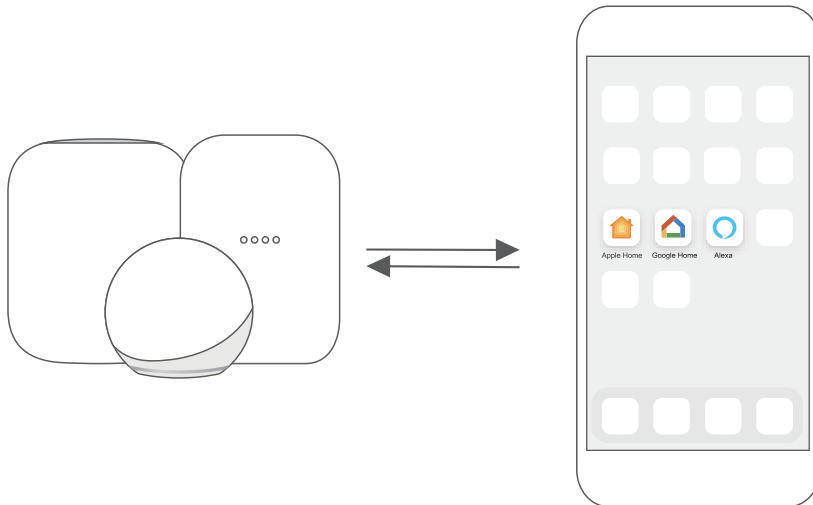

STEP 2: Turn On Bluetooth

Turn on Bluetooth on your mobile device.

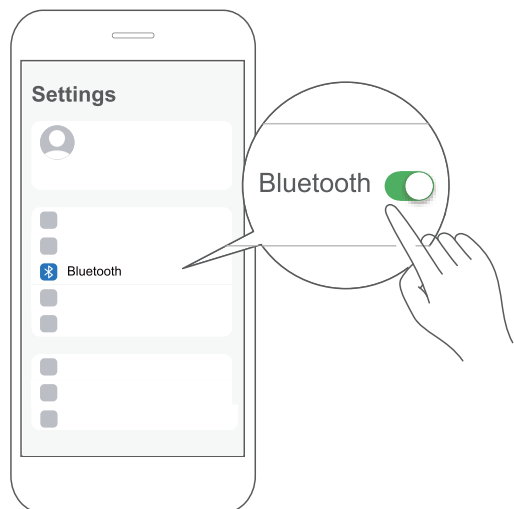

STEP 3: Enter AP Mode

Windows AC: Hold down the CONNECT / Power button for 3 seconds to begin the pairing process (“AP” will appear on the AC’s display).

Portable AC: Hold down the SWING / Power button for 3 seconds to begin the pairing process (“AP” will appear on the AC’s display).

NOTE

Entering AP pairing mode may vary between different AC models, please follow the instructions of the AC panel.

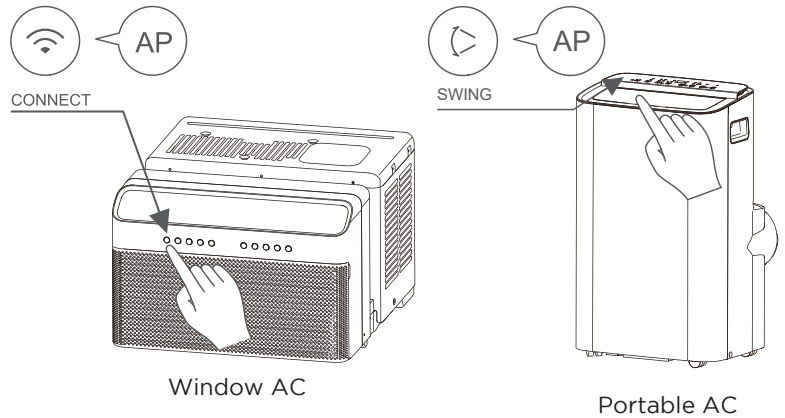

STEP 4: Open App

Open the Alexa, Google Home or Apple Home app on your mobile device.

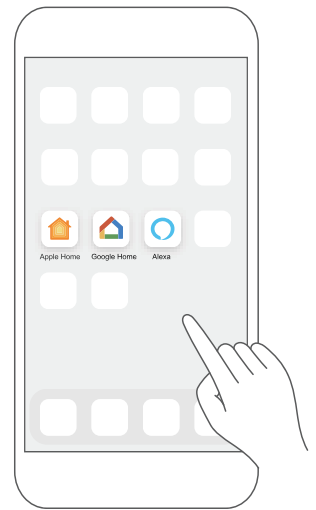

STEP 5: Scan Matter QR code

Tap the “+” and “Add Device/Accessory” or tap “+Add” in your app and then select Matter device and scan the Matter QR code found on the side of the AC device.

Follow the respective instructions in the Alexa, Google Home or Apple Home app to complete the pairing process.

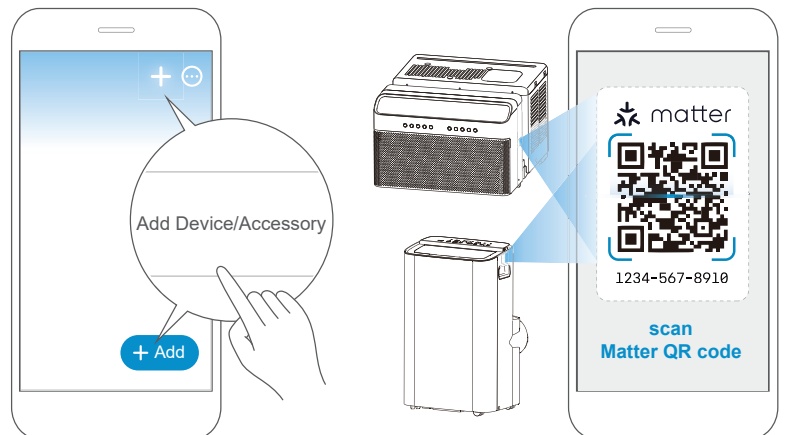

STEP 6: Control Device

After pairing is successful, you can control your AC's temperature and mode settings, etc. through the respective ecosystem app and smart speaker.

Due to a compatibility issue, the temperature value shown in the Alexa, Google Home or Apple Home app may be 1 degree different from that displayed on the air conditioner. However, this will not impact the device's ability to cool the room.

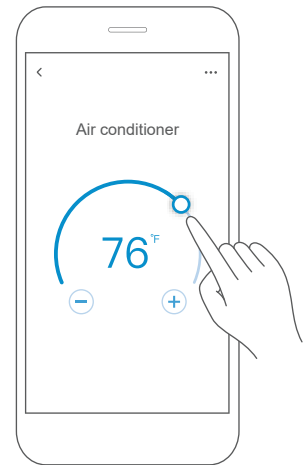
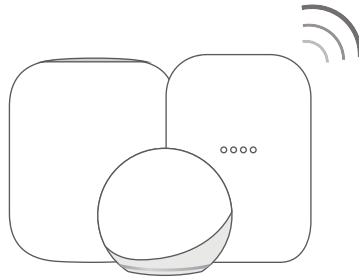

App & Smart Speakers can support Matter only when using these versions or above.

Device	Version
iPhone	iOS16.5
Apple Home Pod	16.5
Android	Google Play services min version: 22.36.15 Google Home app (GHA) min version: 2.58.24.1 - dogfood
Google Home Hub	Google Hub fi rmware min version: 1.56.324896 (appears on hub as Chromecast fi rmware version)
Alexa App	2.2.536317
Alexa Echo Device	9094439556

NOTE

- Setup processes and features may vary between ecosystems.
- The functions shown in the Alexa, Google Home or Apple Home apps may change with updates to their products or apps.
- Make sure the Matter enabled app is up to date to ensure the best experience.
- Periodically, we will update the device's software to improve the experience. Device software updates can be accomplished through the SmartHome app.
-  matter is developed by the Connectivity Standards Alliance TM. This brand, related logos, and marks are trademarks of the Alliance, all rights reserved.
- Use of the Works with Apple badge means that an accessory has been designed to work specifically with the technology identified in the badge and has been certified by the developer to meet Apple's performance standards. Apple is not responsible for the operation of this device or its compliance with safety and regulatory standards.

Declaration of Conformity

FCC ID: 2ADQOMDNA23

IC: 12575A-MDNA23

This device complies with Part 15 of the FCC Rules and Industry Canada's licence exempt RSSs.

Operation is subject to the following two conditions:

- (1) This device may not cause interference;
- (2) This device must accept any interference, including interference that may cause undesired operation of the device.

Only operate the device in accordance with the instructions supplied.

Changes or modifications to this unit not expressly approved by the party responsible for compliance could void the user's authority to operate the equipment.

This device complies with FCC radiation exposure limits set forth for an uncontrolled environment. In order to avoid the possibility of exceeding the FCC radio frequency exposure limits, human proximity to the antenna shall not be less than 20cm (8 inches) during normal operation.

NOTE

This equipment has been tested and found to comply with the limits for a Class B digital device, pursuant to part 15 of the FCC Rules. These limits are designed to provide reasonable protection against harmful interference in a residential installation.

This equipment generates, uses and can radiate radio frequency energy and, if not installed and used in accordance with the instructions, may cause harmful interference to radio communications. However, there is no guarantee that interference will not occur in a particular installation. If this equipment does cause harmful interference to radio or television reception, which can be determined by turning the equipment off and on, the user is encouraged to try to correct the interference by one or more of the following measures:

- Reorient or relocate the receiving antenna.
- Increase the separation between the equipment and receiver.
- Connect the equipment into an outlet on a circuit different from that to which the receiver is connected.
- Consult the dealer or an experienced radio/TV technician for help.

We, hereby declare that this device is in compliance with the relevant provisions of RE Directive 2014/53/EU. A copy of the full DoC is attached (European Union products only).

CLEANING AND MAINTENANCE

CAUTION

Clean your air conditioner occasionally to keep it looking new. Be sure to unplug the unit before cleaning to prevent shock or fire hazards.

Air Filter Cleaning

The air filter should be checked at least once every two weeks to see if cleaning is necessary. Trapped particles in the filter can build up and cause an accumulation of frost on the cooling coils and reduce performance.

- Grasp the filter by the center and pull up and out.
- Wash the filter using warm water. Rinse filter thoroughly.
- Gently shake excess water from the filter. Be sure the filter is thoroughly dry before replacing.
- Instead of washing, you may also vacuum the filter clean rather than washing.

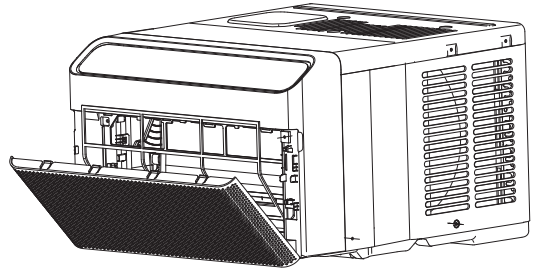

NOTE

Never use hot water over 104°F (40°C) to clean the air filter. Never attempt to operate the unit without the air filter.

Cabinet Cleaning

- Be sure to unplug the air conditioner to prevent shock or fire hazard. The cabinet and front may be dusted with an oil-free cloth or washed with a cloth dampened in a solution of warm water and mild liquid dishwashing detergent. Rinse thoroughly and wipe dry.
- Never use harsh cleansers, wax, or polish on the air conditioner.
- Be sure to wring excess water from the cloth before wiping around the controls. Excess water in or around the controls will cause damage to the air conditioner.
- Plug in air conditioner.

Winter Storage

If you plan to store the air conditioner during the winter, remove it carefully from the window according to the installation instructions. Be careful not to spill any potentially standing water from the unit's base pan. If water is present, carefully drain it. Cover the unit with plastic or return it to the original carton.

TROUBLESHOOTING TIPS

Before calling for service, review this list. It may save you time and expense. This list includes common occurrences that are not the result of defective workmanship or materials in this appliance.

Problem	Solution
Air conditioner does not start.	Wall plug disconnected. Push plug firmly into wall outlet.
	House fuse blown or circuit breaker tripped. Replace fuse with time delay type or reset circuit breaker.
	Plug Current Device Tripped. Press the RESET button.
	Power is OFF. Turn power ON.
Air from unit does not feel cold enough.	Room temperature below 60°F (16°C). Cooling may not occur until room temperature rises above 60°F (16°C).
	Temperature sensor behind the air filter is touching the cold coil. Try to move it so it does not contact the cold coil.
	Set to a lower temperature.
	Compressor stopped when changing modes. Wait 3 minutes after set to the COOL mode.
	Check for potential obstructions blocking the outdoor intake/exhaust. Clear any obstructions.
Air conditioner cooling, but room is too warm - ice forming on cooling coil behind air filter.	Outdoor temperature below 64°F (18°C). To defrost the coil, set to FAN ONLY mode.
	Air filter may be dirty. Clean filter. Refer to Care and Cleaning section. To defrost, set to FAN ONLY mode.
	Thermostat set too cold for night-time cooling. To defrost the coil, set to FAN ONLY mode. Then, set temperature to a higher setting.
Air conditioner cooling, but room is too warm - NO ice forming on cooling coil behind air filter.	Dirty or restricted air filter. Clean filter. Refer to Care and Cleaning section.
	Temperature is set too high, set temperature to a lower setting.
	Air directional louvers positioned improperly. Position louvers for better air distribution.
	Front of unit is blocked by drapes, blinds, furniture, etc. - restricts air distribution. Clear obstruction in front of unit.
	Any open doors, windows, or registers may allow cold air to escape. Close any doors, windows, or registers.
	The room may be too warm. Allow additional time to remove "stored heat" from walls, ceiling, floor and furniture.

Problem	Solution
Air conditioner turns on and off rapidly.	Dirty or restricted air filter. Clean air filter.
	Outside temperature extremely hot. Set FAN speed to a higher setting to bring air past cooling coils more frequently.
	Check for potential obstructions blocking the outdoor intake/exhaust. Clear any obstructions.
Noise when unit is cooling.	Air movement sound. It is normal to hear the airflow. If too loud, set to a slower FAN setting.
	Window vibration - poor installation. Refer to installation instructions or check with installer.
Water dripping INSIDE when unit is cooling.	Improper installation. Tilt air conditioner slightly to the outside to allow water drainage. Refer to installation instructions - check with installer.
Water dripping OUTSIDE when unit is cooling.	Unit removing large quantity of moisture from humid room. This is normal during excessively humid days.
Remote sensing deactivating prematurely (some models).	Remote control not located within range. Place remote control within 26 feet (8 m) and pointed in the general direction of the air conditioner unit.
	Remote control signal obstructed. Remove obstruction.
Room too cold.	Temperature setting too low. Increase temperature setting.
Noise when unit starts.	A “da-da” sound may occur for thirty seconds when the unit is turned on due to the compressor starting. It is normal.
Heat mode does not start or the machine displays ‘LO’	Wait for the outdoor temperature to rise above the minimum heat pump operating temperature.
Unit will not connect to WiFi or App does not work (some models).	For additional support and troubleshooting tips, visit the “Help” tab within the SmartHome app.

WARRANTY

Air Conditioner Limited Warranty

Your product is protected by this Limited Warranty:

Warranty service must be obtained from Midea Consumer Services or an authorized Midea servicer.

Warranty

- One Year Limited Warranty from the date of delivery or the purchase date, whichever is later.
- Five Year Limited Sealed System Warranty (includes components containing refrigerant) from the date of delivery or the purchase date, whichever is later.
- Three Year Limited Compressor Warranty from the date of delivery or the purchase date, whichever is later.
- The date of delivery establishes the warranty period, should service be required.

Midea, through its authorized servicers will:

- Pay all costs for repairing or replacing parts of this appliance which prove to be defective in materials or workmanship.

Consumer will be responsible for:

- Diagnostics, removal, transportation and reinstallation cost required because of service.
- Costs of service calls that are a result of items listed under NORMAL RESPONSABILITIES OF THE CONSUMER**

Midea replacement parts shall be used and will be warranted only for the original warranty.

NORMAL RESPONSABILITIES OF THE CONSUMER**

This warranty applies only to products in ordinary household use, and the consumer is responsible for the items listed below:

1. Proper use of the appliance in accordance with instructions provided with the product.
2. Routine maintenance and cleaning necessary to keep the good working condition.
3. Proper installation by an authorized service professional in accordance with instructions provided with the appliance and in accordance with all local plumbing, electrical and/or gas codes.
4. Proper connection to a grounded power supply of sufficient voltage, replacement of blown fuses, repair of loose connections or defects in house wiring.
5. Expenses for making the appliance accessible for servicing.
6. Damages to finish after installation.

EXCLUSIONS

This warranty does not cover the following:

- 1) Failure caused by damage to the unit while in your possession (other than damage caused by defect or malfunction), by its improper installation, or by unreasonable use of the unit, including without limitation, failure to provide reasonable and necessary maintenance or to follow the written installation and Operating Instructions.
- 2) Damages caused by service performed by persons other than those authorized by Midea customer service; or external causes such as abuse, misuse, inadequate power supply or acts of God.
- 3) If the unit is put to commercial, business, rental, or other use or application other than for consumer use, we make no warranties, express or implied, including but not limited to, any implied warranty of merchantability or fitness for use or purpose.
- 4) Products without original serial numbers or products that have serial numbers which have been altered or cannot be readily determined.

NOTICE: Some states do not allow the exclusions or limitation of incidental or consequential damages. So this limitation or exclusion may not apply to you.

IF YOU NEED SERVICE

Keep your bill of sale, delivery slip, or some other appropriate payment Record.

The date on the bill establishes the warranty period, should service be required.

If service is performed, it's your best interest to obtain and keep all receipts.

This written warranty gives you specific legal rights. You may also have other rights that vary from state to state.

Service under this warranty must be obtained by following these steps, in order:

- 1) Contact Midea Consumer Services or an authorized Midea services at 1 866 646 4332.
- 2) If there is a question as to where to obtain service, contact our consumer relations Department.



make yourself at home



www.midea.com

© Midea 2025 all rights reserved

CW010UI-QB

16120300A34501

20251023