

## WINDOW TYPE ROOM AIR CONDITIONER

# USER MANUAL

**MAW08HN1CWT**  
**MAW12HN1CWT**



Warning notices: Before using this product, please read this manual carefully and keep it for future reference. The design and specifications are subject to change without prior notice for product improvement. Consult with your dealer or manufacturer for details.

The diagram above is just for reference. Please take the appearance of the actual product as the standard.

## THANK YOU LETTER

Thank you for choosing Midea! Before using your new Midea product, please read this manual thoroughly to ensure that you know how to operate the features and functions that your new air conditioner offers in a safe way.

# CONTENTS

<b>THANK YOU LETTER</b> .....	2
<b>Safety Precautions</b> .....	3
<b>What is in the Box</b> .....	7
<b>Before you get start</b> .....	8
<b>Installation overview</b> .....	9
<b>Get to know your AC</b> .....	16
<b>Get to know the features</b> .....	18
<b>REMOTE CONTROL INSTRUCTIONS</b> .....	21
<b>Cleaning &amp; maintenance</b> .....	29
<b>TROUBLESHOOTING</b> .....	30
<b>CONNECTION INSTRUCTIONS</b> .....	32
<b>WARRANTY</b> .....	39

# Safety Precautions

## Must read the warning message.

Inside you will find many helpful hints on how to use and maintain your air conditioner properly. Just a little preventive care on your part can save you a great deal of time and money over the life of your air conditioner. You'll find many answers to common problems in the chart of troubleshooting tips. If you review our chart of Troubleshooting Tips first, you may not need to call for service at all.

To prevent injury to the user or other people and property damage, the following instructions must be followed. Incorrect operation due to ignoring of instructions may cause harm or damage. The seriousness is classified by the following indications.

## Explanation of Symbols



### Warning

The signal word indicates a hazard with a medium level of risk which, if not avoided, may result in death or serious injury.



### Caution

The signal word indicates a hazard with a low degree of risk which, if not avoided, may result in minor or moderate injury.

## WARNING

- Plug in power plug properly. Otherwise, it may cause electric shock or fire due to excess heat generation. Do not operate or stop the unit by inserting or pulling out the power plug. It may cause electric shock or fire due to heat generation. Do not damage or use an unspecified power cord. It may cause electric shock or fire. If the power cord is damaged, it must be replaced by the manufacturer or an authorised service centre or a similarly qualified person in order to avoid a hazard.
- Always install circuit breaker and a dedicated power circuit. Incorrect installation may cause fire and electric shock. Do not operate with wet hands or in damp environment. It may cause electric shock. Do not direct airflow at room occupants only. This could damage your health.
- Always ensure effective grounding. Incorrect grounding may cause electric shock. Do not allow water to run into electric parts. It may cause failure of machine or electric shock. Do not modify power cord length or share the outlet with other appliances. It may cause electric shock or fire due to heat generation.
- Unplug the unit if strange sounds, smell, or smoke comes from it. It may cause fire and electric shock. Do not use the socket if it is loose or damaged. It may cause fire and electric shock. Do not open the unit during operation. It may cause electric shock.
- Keep firearms away. It may cause fire. Do not use the power cord close to heating appliances. It may cause fire and electric shock. Do not use the power cord near flammable gas or combustibles, such as gasoline, benzene, thinner, etc. It

may cause an explosion or fire.

- Ventilate room before operating air conditioner if there is a gas leakage from another appliance. It may cause explosion, fire and, burns. Do not disassemble or modify unit. It may cause failure and electric shock.

## CAUTION

- When the air filter is to be removed, do not touch the metal parts of the unit. It may cause an injury.  
Ventilate the room well when used together with a stove, etc. An oxygen shortage may occur.
- Do not use strong detergent such as wax or thinner but use a soft cloth. Appearance may be deteriorated due to change of product color or scratching of its surface. Do not clean the air conditioner with water. Water may enter the unit and degrade the insulation. It may cause an electric shock. Do not use for special purposes. Do not use this air conditioner to preserve precision devices, food, pets, plants, and art objects. It may cause deterioration of quality, etc.
- Stop operation and close the window in storm or hurricane. Operation with windows opened may cause wetting of indoor and soaking of household furniture. When the unit is to be cleaned, switch off , and turn off the circuit breaker.
- Do not clean unit when power is on as it may cause fire and electric shock, it may cause an injury.
- Always insert the filters securely. It can be caused failure if operated without filters. Please clean filter once every two weeks.

## CAUTION

- Hold the plug by the head of the power plug when taking it out. It may cause electric shock and damage. Turn off the main power switch when not using the unit for a long time. It may cause failure of product or fire.
- Do not place obstacles around air-inlets or inside of air-outlet. It may cause failure of appliance or accident. Do not place heavy object on the power cord and ensure that the cord is not compressed. There is danger of fire or electric shock. Don't drink water drained from air conditioner. It contains contaminants and could make you sick.
- Use caution when unpacking and installing. Sharp edges could cause injury.
- If water enters the unit, turn the unit off at the power outlet and switch o the circuit breaker. Isolate supply by taking the power-plug out and contact a qualified service technician.
- This appliance is not intended for use by persons(including children) with reduced physical ,sensory or mental capabilities or lack of experience and knowledge, unless they have been given super vision or instruction concerning use of the appliance by a person responsible for their safety.
- Children should be supervised to ensure that they do not play with the appliance.
- If the supply cord is damaged, it must be replaced by the manufacturer, its service agent or similarly qualified persons in order to avoid a hazard.
- The appliance shall be installed in accordance with national wiring regulations.
- Installation must be performed in accordance with the requirement of NEC and CEC by authorized personnel only.
- Do not operate your air conditioner in a wet room such as a bathroom or laun-

dry room.

- The appliance with electric heater shall have at least 1 meter space to the combustible materials.
- Contact the authorised service technician for repair or maintenance of this unit.
- Contact the authorised installer for installation of this unit.

#### **NOTE**

This air conditioner is designed to be operated under the following conditions:

Cooling operation	Outdoor temp:	64-109°F/18-43°C (64-125°F/18-52°C for special tropical models)
	Indoor temp:	62-90°F/ 17-32°C
Heating operation	Outdoor temp:	23-76°F/-5-24°C
	Indoor temp:	32-80°F/0-27°C

**Note:** Performance may be reduced outside of these operating temperatures.

### **Operation of Current Device**

The power supply cord contains a current device that senses damage to the power cord. To test your power supply cord do the following:

- Plug in the Air Conditioner.
- The power supply cord will have TWO buttons on the plug head. Press the TEST button, you will notice a click as the RESET button pops out.
- Press the RESET button again, you will notice a click as the button engages.
- The power supply cord is now supplying electricity to the unit. (On some products this is also indicated by a light on the plug head).

#### **NOTE**

- The power supply cord with this air conditioner contains a current detection device designed to reduce the risk of fire.
- In the event that the power cord is damaged, it cannot be repaired – it must be replaced with a cord from the product manufacturer.
- Do not use this device to turn the unit on or off.
- Always make sure the RESET button is pushed in for correct operation.
- The power supply cord must be replaced if it fails to reset when either the TEST button is pushed or if it cannot be reset. A new one can be obtained from the product manufacturer.

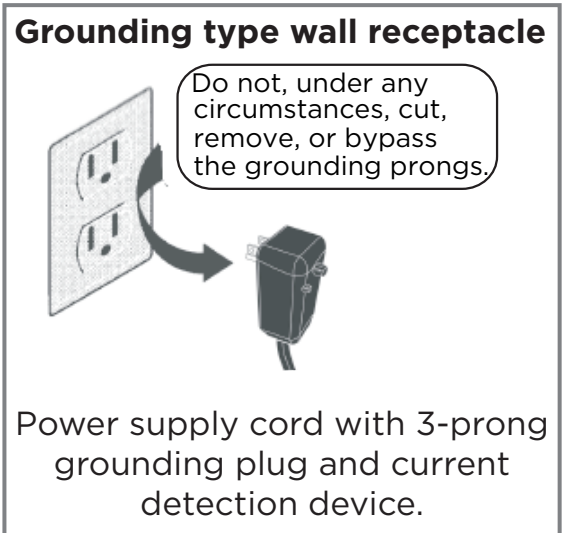

### **WARNING**

#### **Electrical Information**

The complete electrical rating of your new room air conditioner is stated on the serial plate. Refer to the rating when checking the electrical requirements.

- Be sure the air conditioner is properly grounded. To minimize shock and fire

hazards, proper grounding is important. The power cord is equipped with a three-prong grounding plug for protection against shock hazards.

- Your air conditioner must be used in a properly grounded wall receptacle. If the wall receptacle you intend to use is not adequately grounded or protected by a time delay fuse or circuit breaker, have a qualified electrician install the proper receptacle. Ensure the receptacle is accessible after the unit installation.
- Do not run air conditioner without side protective cover in place. This could result in mechanical damage within the air conditioner.
- Do not use an extension cord or an adapter plug.

Avoid fire hazard or electric shock. Do not use an extension cord or an adapter plug. Do not remove any prongs from the power cord.

## For Your Safety

Do not store or use gasoline or other flammable vapors and liquids in the vicinity of this or any other appliance.

## Prevent Accidents

To reduce the risk of fire, electrical shock, or injury to persons when using your air conditioner, follow basic precautions, including the following:

- Be sure the electrical service is adequate for the model you have chosen. This information can be found on the serial plate, which is located on the side of the the cabinet and behind the grille.
- If the air conditioner is to be installed in a window, you will probably want to clean both sides of the glass first. If the window is a triple-track type it has a screen panel included, remove the screen completely before installation.
- Be sure the air conditioner has been securely and correctly installed according to the installation instructions in this manual.

Save this manual for possible future use in removing or installing this unit.

When handling the air conditioner, be careful to avoid cuts from sharp metal fins on front and rear coils.

## Electronic Work



### WARNING:

BEFORE PERFORMING ANY ELECTRICAL OR WIRING WORK, TURN OFF THE MAIN POWER TO THE SYSTEM.

Electronic Type

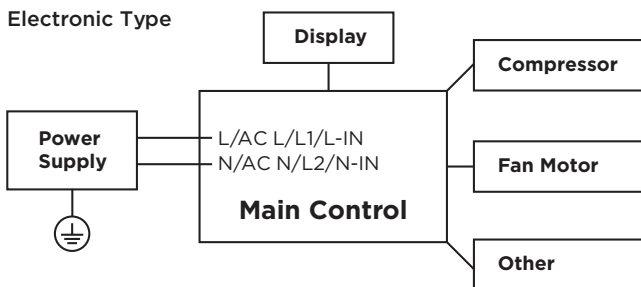

Mechanical Type

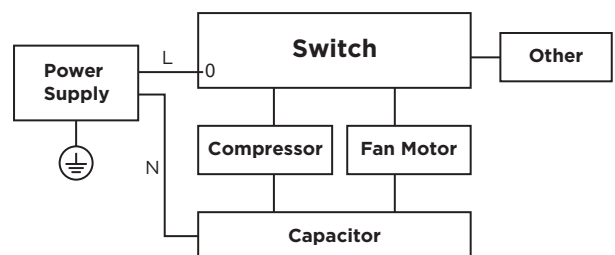

### NOTE:

Please strictly follow the wiring label attached to the machine for all wiring connections. The wiring diagram may vary for different unit. Please refer to the wiring diagram on the machine you have purchased. The above wiring diagram is a simplified version for preliminary illustration purposes only.

# What is in the Box

## Package content



5/8in Screws and  
Safety Lock(3 Types)



Top Rail



3/8in Screws

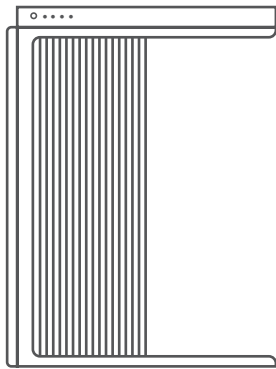

Frame Assembly(Left)

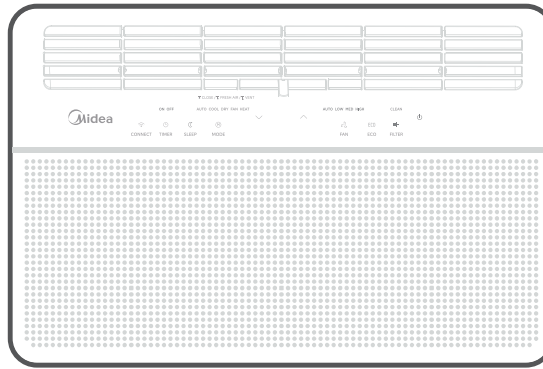

Window Type Room  
Air Conditioner unit

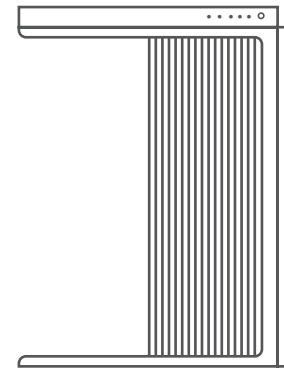

Frame Assembly(Right)



Window Sash Seal  
Foam (with glue)

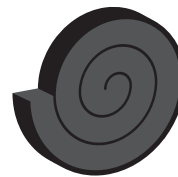

Window Sash Seal  
Foam (non glue)

## Prepare the following tools



Gloves



Screwdriver



Pencil



Scissors



Drill

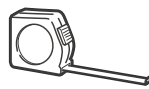

Ruler or tape measure

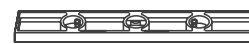

Level

\*Not Included

### NOTE

The unit you purchased may be look like something different, please refer to the material in kind.

# Before you get start

## Preparations before installation



The installation must be carried out in strict accordance with the instructions in this manual.



Installing your AC should take about 60 minutes.



We recommend doing this with a helper



We're here if you need us, please contact your local distributor for assistance.

### NOTE

Save Carton and these Installation Instructions for future reference. The carton is the best way to store unit during winter, or when not in use.

## ! WINDOW REQUIREMENTS

Your air conditioner is designed to install in standard double hung windows with opening widths of 23 to 36 inches (584mm to 914mm).

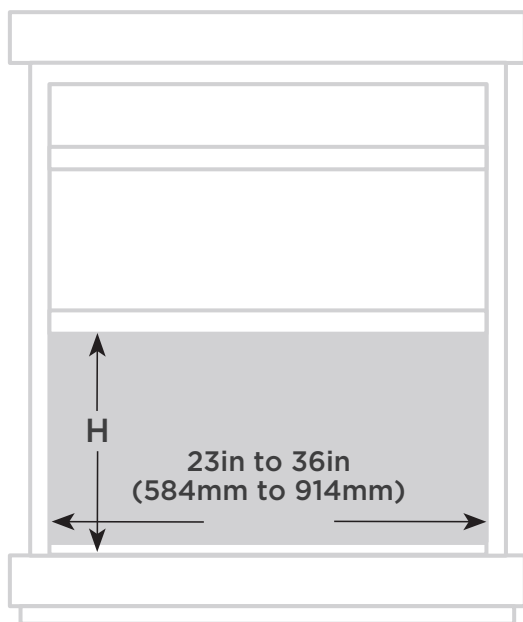

Window opening height	8000-12000Btu/h
H	15-1/2in(394mm)

### ! CAUTION

- Do not, under any circumstances, cut or remove the third (ground) prong from the power cord.
- Do not change the plug on the power cord of the air conditioner. Aluminum house wiring may present special problems consult a qualified electrician. When handling unit, be careful to avoid cuts from sharp metal edges and aluminum fins on front and rear coils.
- The rear of the unit must be outdoors, not inside a building or garage.

# Installation overview

## Installation Completion Display

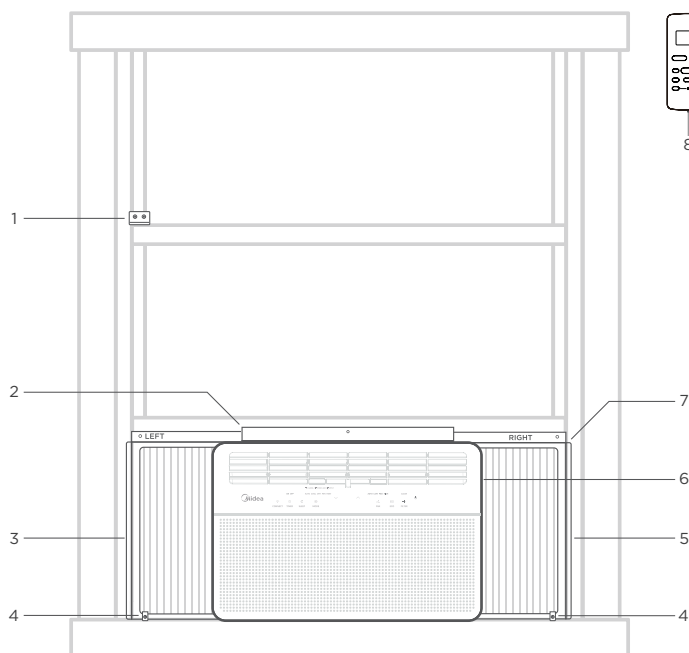

1. Safety Lock and 5/8in Screws
2. Top Rail and 3/8in Screws
3. Frame Assembly(Left)
4. Safety Lock and 5/8in Screw
5. Frame Assembly(Right)
6. Air Conditioner unit
7. Window Sash Seal Foam
8. Remote controller

### NOTE

Illustrations in this manual are for explanatory purposes. The actual shape of your indoor unit may be slightly different. The actual shape shall prevail.

## STEP 1: Install your AC unit.

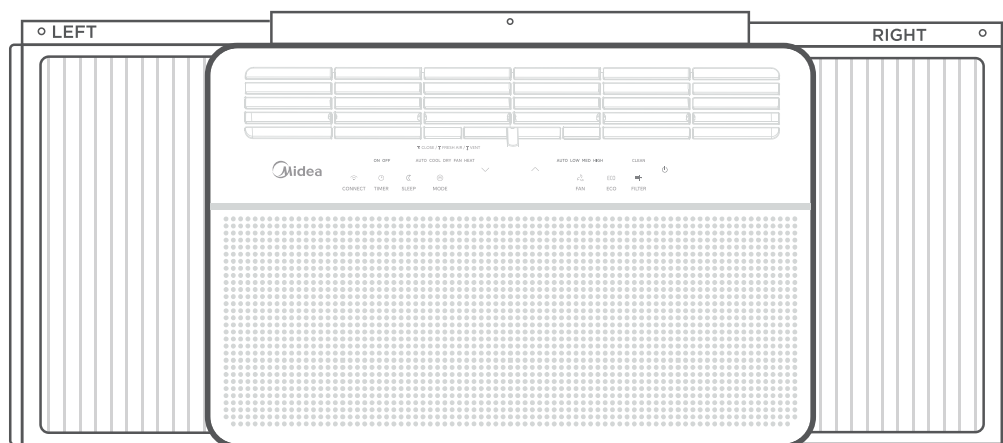

### What you need.

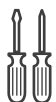

## Install you AC.

(1) Install the top rail on the AC.

Install the Top Rail on the AC with 4 Screws(3/8in), For safety reasons, all 4 screws MUST be securely fastened.

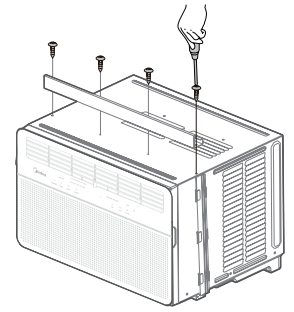

### The top rail maybe already installed.

(2) Pull the panels out around.

Pull the Left&Right Panels out half way around.

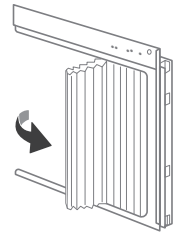

(3) Install the accordion panels.

Insert the card slot on the side of the AC, pay attention to the left and right differences of the Panel.

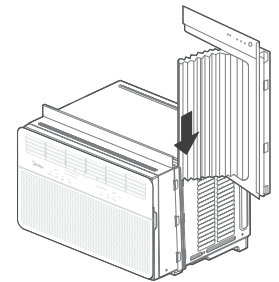

### NOTE:

Top rail and Sliding Panels at each side are offset to provide the proper pitch to the rear of (5/16"). This is necessary for proper condensed water utilization and drainage. If you are not using the Side Panels for any reason, this pitch to the rear must be maintained.

(4) Fasten the panels to the AC.

Stretch the wind screen outward and insert the upper and lower frame strips of the Panels into the AC card slot.

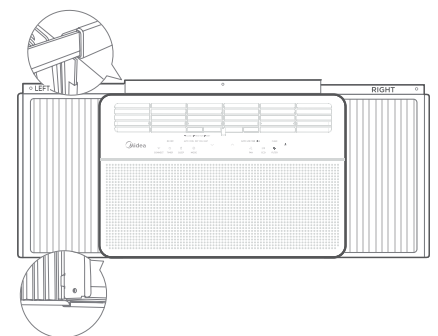

(5) The AC unit is done.

Before you rush to the next installation phase, please first confirm the following installation is in place.

- A. The upper and lower frame strips of the Panels into the AC card slot.
- B. Top Rail on the AC with 4 Screws.
- C. Insert the card slot on the side of the AC.

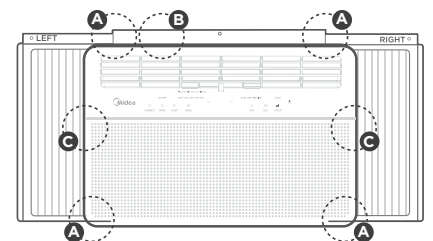

## STEP 2: Insulate your window.

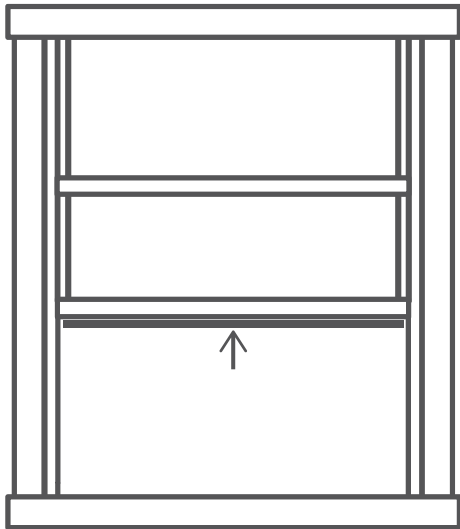

What you need.



### Insulate your window:

(1) Cut the seal foam to the width of your window, and stick it of the underside.

You should cut the foam to be the width of your window from the left to the right side. Make sure you're cutting the foam with the adhesive, and stick it of the underside.

(2) Insert the foam to the gaps.

In order to improve the operation of the equipment and reduce the noise generated during operation, you need to foam seal the gaps.

- If your window already has a liner or insulation strip, you can skip the above steps.

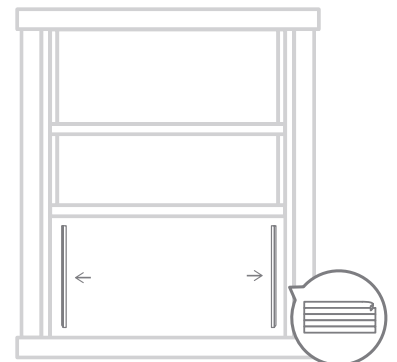
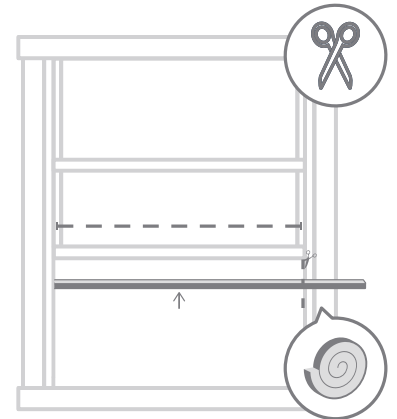

## STEP 3: Lift the AC into the window.

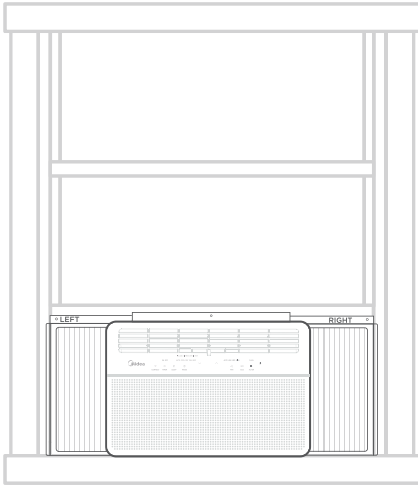

### What you need.



### Lift the AC into the window.

(1) Together with your helper, lift the assembled AC into the window frame.

Make sure you do this step with a helper. Very carefully, lift the assembled AC into the window frame. Make sure someone is holding the back of the unit securely.

- It's helpful to rest the unit on the inside window sill until you're ready to reposition it correctly. Injury (to you and others) and property damage can occur if not done correctly.

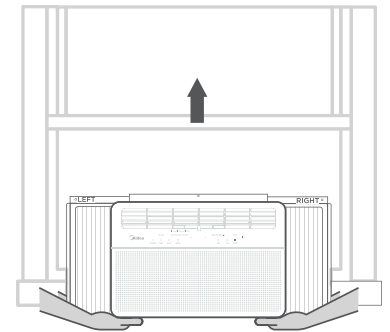

Wooden Windows

(2) Properly position the bottom bar BEHIND the inside window sill.

Properly position the bottom bar behind the inside window sill and into the bottom horizontal channel of the window frame. The front of the bottom bar should be pressing up against the back edge of the sill.

- Check that air conditioner is tilted back about 3° to 4° downward to the outside. After proper installation, condensate should not drain from the overflow drain hole during normal use. Correct the slope otherwise.

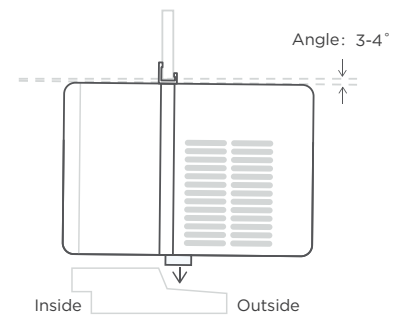

Vinyl-Clad Windows

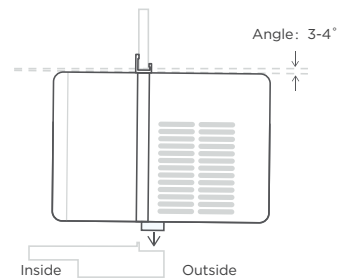

## Lift the AC into the window:

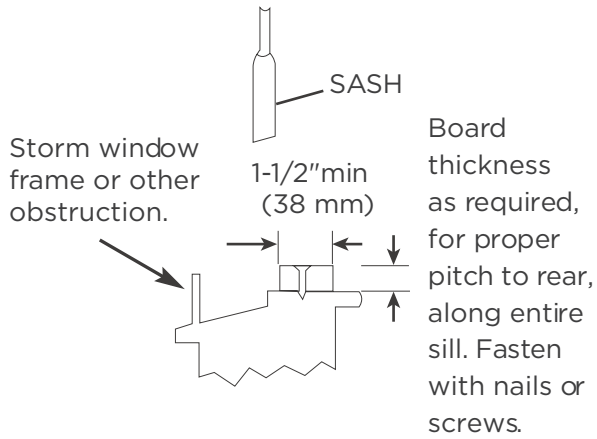

## ⚠ CAUTION

If storm window blocks AC, Please install according to the figure above.

(3) Close the window down onto the AC, and pull the panels to the side of the window.

Once the AC is centered and the bottom bar is successfully positioned, close the window down onto the AC, behind the top bar. See diagram above. Pull the panels to the side of the window.

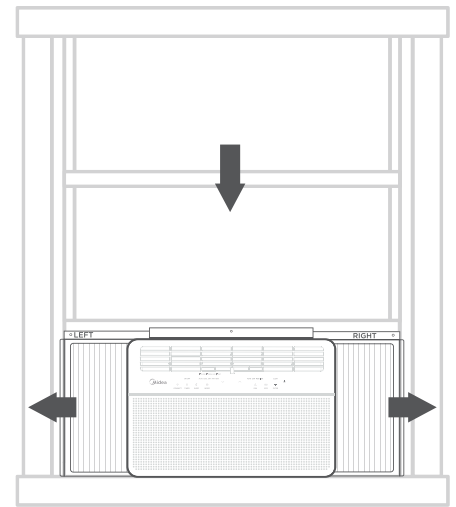

## STEP 4: Secure the AC.

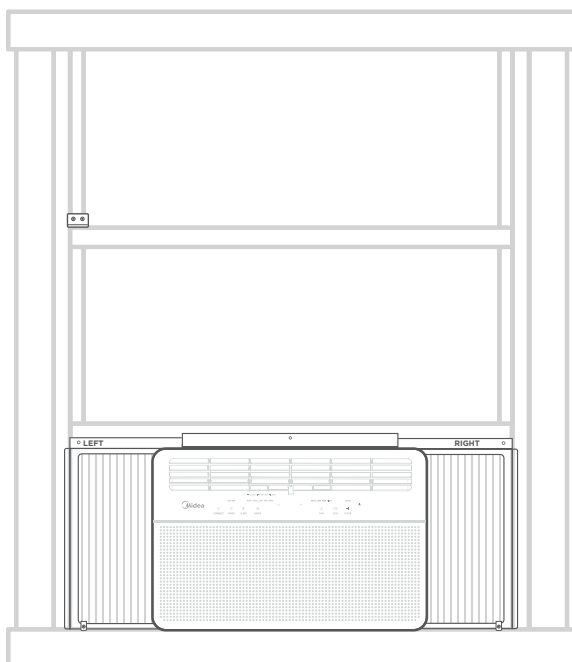

### What you need.



## Secure the AC:

(1) Drive locking screws.

Follow the above instructions and drive the screws.

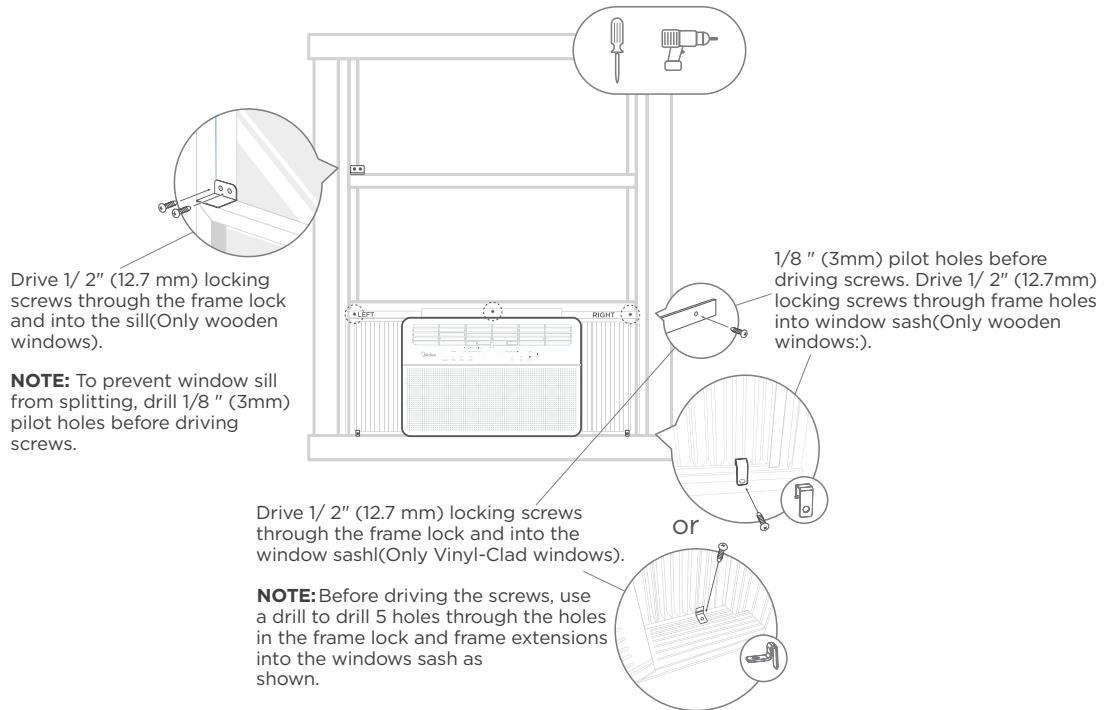

## The final details:

(1) Cut the non-adhesive insulation foam to fit the width of your window.

Make sure you are cutting the foam with the non-adhesive sides. Measure and cut the foam to be the width of your window from the left to right side.

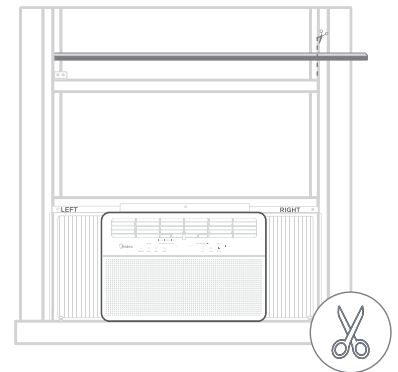

(2) Use the nonadhesive foam to fill the gaps in your window.

Stuff it between the gap of the upper and lower sashes of your window.

**This will plug any air gaps and help keep out bugs and draft.**

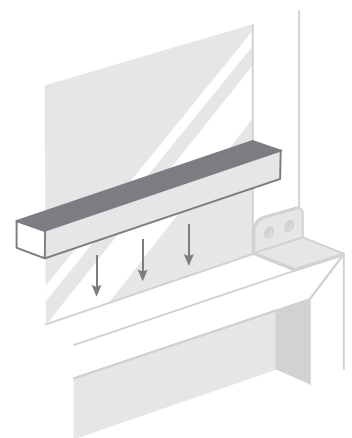

## One More Thing-Additional Notes

### 1. If AC is Blocked by Storm Window.

Add wood as shown in Caution illustration on page 16, or remove storm window before air conditioner is installed. If Storm Window Frame must remain, be sure the drain holes or slots are not caulked or painted shut. Accumulated Rain Water or Condensation must be allowed to drain out.

### Removing AC From Window

Turn AC off, and disconnect power cord. Remove sash seal from between windows, and unscrew safety sash lock. Remove screws installed through frame and frame-lock. Keeping a firm grip on air conditioner, raise sash and carefully remove. Be carefully not to spill any remaining water while lifting unit from window. Store parts with air conditioner.

### 2. Normal Sounds

#### High Pitched Chatter

High efficiency compressors may have a high pitched chatter during the cooling cycle.

#### Sound of Rushing Air

At the front of the unit, you may hear the sound of rushing air being moved by the fan.

#### Gurgle/Hiss

“Gurgling or hissing” noise may be heard due to refrigerant passing through evaporator during normal operation.

#### Vibration

Unit may vibrate and make noise because of poor wall or window construction or incorrect installation.

#### Pinging or Switching

Droplets of water hitting condenser during normal operation may cause “pinging or swishing” sounds. This noise can be reduced by removing the water plug at the bottom of unit’s rear as shown below. Removing this plug will lower the Energy Efficiency of your unit.

#### Note:

Don’t try to drill any holes on the base pan to eliminate the normal sounds, otherwise it will void the warranty.

# Get to know your AC

## AC unit overview

### NOTE

The following two types of product appearance for reference only, The machine you purchase may be a little different.

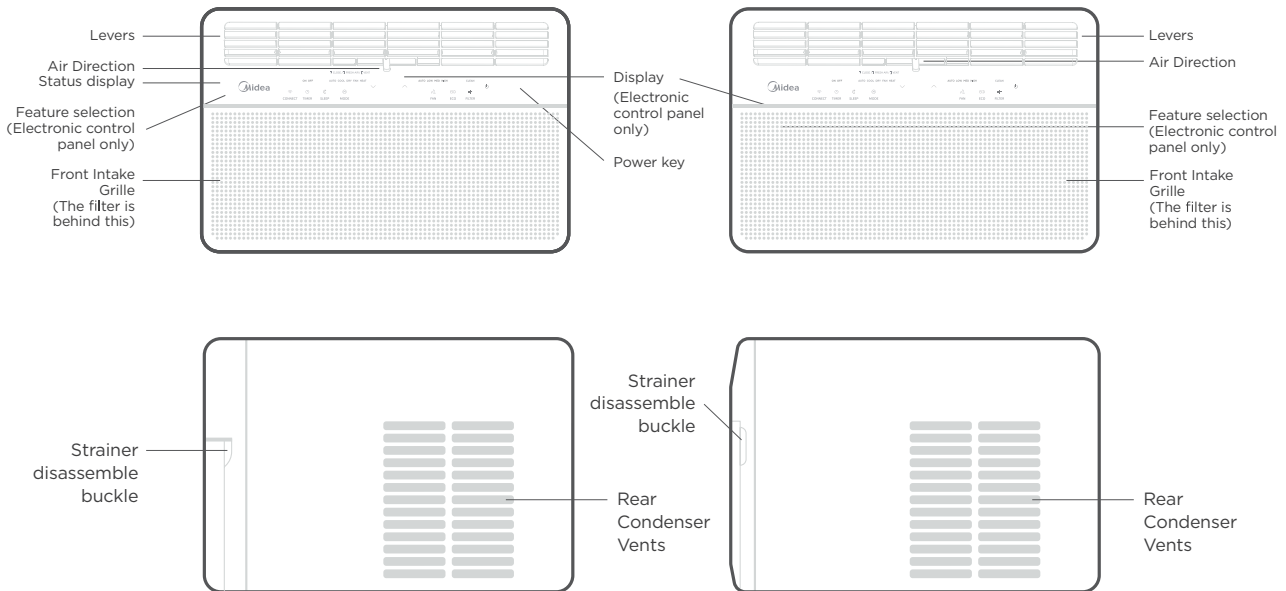

## Adjust your air conditioning direction.

### Air conditioning louvers:

### CAUTION

Do not stick your fingers in the air outlet, it may cause an injury.

### Four-way adjustment (up or down, left or right)

The louvers will allow you to direct the air flow Up or Down (on some models) and Left or Right throughout the room as needed. Pivot horizontal louvers until the desired Up/Down direction is obtained. Move the Lever(s) from side to side until the desired Left/Right direction is obtained.

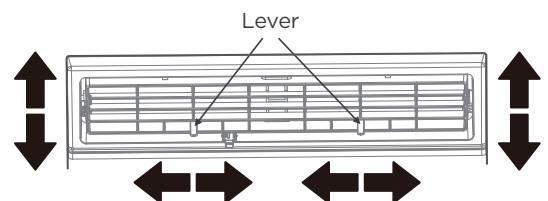

## Fresh air vent control

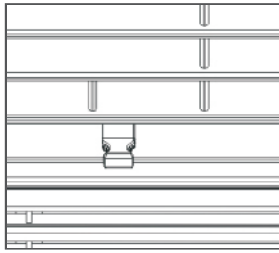

**Fig.A** (VENT CLOSED)

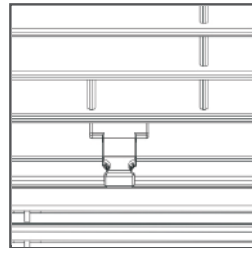

**Fig.B** (VENT OPEN)

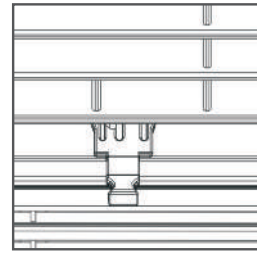

**Fig.C** (VENT & EXHAUST OPEN)

The Fresh Air Vent allows the air conditioner to:

1. Recirculate inside air - Vent Closed (See Fig.A)
2. Draw fresh air into the room- Vent Open (see Fig.B)
3. Exchange air from the room and draws fresh air into the room - Vent and Exhaust Open (see Fig.C)

# Get to know the features

## Air conditioner features

### ⚠ WARNING

- To reduce the risk of fire, electric shock, or injury to persons, read the IMPORTANT SAFETY INSTRUCTIONS before operating this appliance.
- Please always wait 3 minutes when turning unit off then on again, and when changing from cool to fan and back to cool. This prevents compressor from overheating & possible circuit breaker tripping.

### To begin operating the air conditioner, follow these steps:

1. Set the thermostat to the highest number (coldest or cooler setting).
2. Set the selector control to the highest COOL setting.
3. Adjust the louver for comfortable air flow (page 16).
4. Once the room has cooled, adjust the thermostat to the setting you find most comfortable.
5. Make sure that the air flow inside and outside are not obstructed by anything.

## Electronic control operating instructions

### ● NOTE

- Different models have different control buttons and indicator lights. Not all the control buttons and indicator lights describing below are available for the unit you purchased. Please check the control panel of the unit you purchased. The unit can be controlled by the unit control alone or with the remote.
- Ion or clear air may be instead of SMART or WIRELESS or CONNECT for some models. Heat, clean air, ion, smart, Wireless, Connect and follow me features are optional. Ion, clean air is not applicable for R32/R290 units. These features may not be available on some models. The outline of the operation panel is based on typical model, the function is the same with your air conditioner while some difference may exist in appearance.

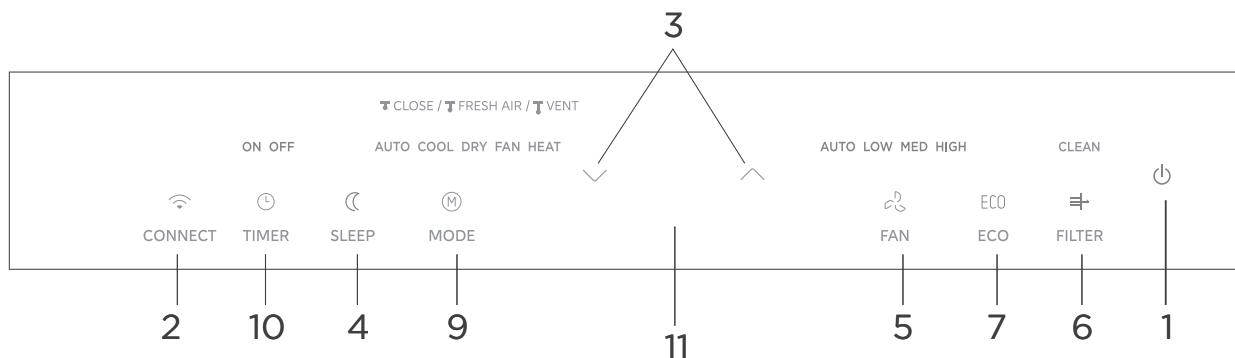

#### 1. TO TURN UNIT ON OR OFF:

Press POWER button to turn unit on or off.

#### ● NOTE:

The unit will initiate automatically the Energy Saver function under Cool, Dry and Auto modes.

#### 2. CONNECT FEATURE:

Connect button for 3 seconds to turn off the unit and initiate connection mode.

#### 3. TO CHANGE TEMPERATURE SETTING:

Press UP/DOWN button to change temperature setting.

**NOTE:**

Press or hold either UP or DOWN button until the desired temperature is shown on the display. This temperature will be automatically maintained anywhere between 62°F(17°C) and 86°F (30°C). If you want the display to read the actual room temperature, see“ To Operate on Fan Only ”section.

**4. SLEEP FEATURE:**

Press Sleep button to initiate the sleep mode. In this mode the selected temperature will increase (cooling) or decrease (heating) by 2°F/1°C 30 minutes after the mode is selected. The temperature will then increase (cooling) or decrease (heating) by another 2°F/1°C after an additional 30 minutes. This new temperature will be maintained for 6 or 7 hours before it returns to the originally selected temperature. This ends the Sleep mode and the unit will continue to operate as originally programmed. The Sleep mode program can be cancelled at any time during operation by pressing the Sleep button again.

**5. TO ADJUST FAN SPEEDS:**

Press Fan button to select the Fan Speed in four steps-Auto, Low, Med or High. Each time the button is pressed, the fan speed mode is shifted. For some models, the fan speed can't be adjusted.

**6. CHECK FILTER FEATURE:**

Press Check filter button to initiate this feature. This feature is a reminder to clean the Air Filter for more efficient operation. The LED(light) will illuminate after 250 hours of operation. To reset after cleaning the filter, press the Check Filter button and the light will go off.

**7. ENERGY SAVER FEATURE:**

Press Energy saver button to initiate this function. This function is available on COOL, DRY, AUTO (only AUTO-COOLING and AUTO-FAN) modes. The fan will continue to run for 3 minutes after the compressor shuts off. The fan then cycles on for 2 minutes at 10 minute intervals until the room temperature is above the set temperature, at which time the compressor turns back on and Cooling Starts.

**8. FOLLOW ME FEATURE:(Optional)**



Light flashes or illuminates

This feature can be activated from the remote control ONLY. The remote control serves as a remote thermostat allowing for the precise temperature control at its location.

To activate the Follow Me feature, point the remote control towards the unit and press the Follow Me button. The remote display is actual temperature at its location. The remote control will send this signal to the air conditioner every 3 minutes interval until press the Follow Me button

again.If the unit does not receive the Follow Me signal during any 7 minutes interval, the unit will beep to indicate the Follow Me mode has ended.

**9. TO SELECT THE OPERATING MODE:**

To choose operating mode, press Mode button. Each time you press the button, a mode is selected in a sequence that goes from Auto, Cool, Dry ,heat(cooling only models without)and Fan. The indicator light beside will be illuminated and remained on once the mode is selected.

The unit will initiate automatically the Energy Saver function under Cool, Dry, Auto(only Auto-Cooling and Auto-Fan) modes.

**To operate on COOL mode :**

- Choose Cool Mode to set the cooling function. Use the Up and Down buttons to choose the desired temperature. When Cool Mode is selected, the fan speed can be adjusted by pressing the fan button.

**To operate on HEAT mode(cooling only models without):**

- Choose Heat Mode to set the heating function. Use the Up and Down buttons to choose the desired temperature .When heat Mode is selected, the fan speed can be adjusted by pressing the fan button.

**NOTE:**

For some models, the fan speed can not be adjusted under HEAT mode.

**To operate on Auto feature:**

- When you set the air conditioner in AUTO mode, it will automatically select cooling, heating(cooling only models without), or fan only operation depending on what temperature you have selected and the room temperature.
- The air conditioner will control room temperature automatically round the temperature point set by you.
- In this mode, the fan speed cannot be adjusted, it starts automatically at a speed according to the room temperature.

**To operate on Fan Only:**

- Use this function only when cooling is not desired,such as for room air circulation or to exhaust stale air(on some models). (Remember to open the vent during this function, but keep it closed during cooling for maximum cooling efficiency.) You can choose any fan speed you prefer.
- During this function, the display will show the actual room temperature, not the set temperature as in the cooling mode.
- In Fan only mode ,the temperature is not adjusted.

**To operate on Dry mode:**

- In this mode, the air conditioner will generally operate in the form of a dehumidifier. Since the conditioned space is a closed or sealed area, some degree of cooling will continue. On Dry mode,the fan speed is controlled at Low automatically.

#### 10. TIMER: AUTO START/STOP FEATURE:

- Press Timer button, the TIMER ON or TIMER OFF indicator light illuminates. It indicates the Auto Start or Auto Stop program is initiated. For some units, keep pressing the Timer button will cancel the timer settings.
- Press or hold the UP or DOWN button to change the Auto time by 0.5 hour increments, up to 10 hours, then at 1 hour increments up to 24 hours. The control will count down the time remaining until start.
- The selected time will register in 5 seconds, and the system will automatically revert back to display the previous temperature setting or room temperature when the unit is on. (when the unit is off, there is no display.)
- Turning the unit ON or OFF at any time or adjusting the timer setting to 0.0 will cancel the Auto Start/Stop timed program.

#### 11. DISPLAYS:

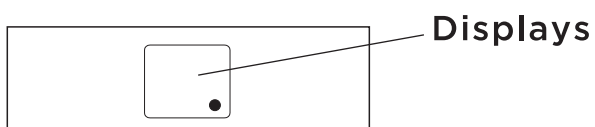

Shows the set temperature in "°C" or "°F" and the Auto-timer settings. While on Fan only mode, it shows the room temperature. If the room temperature is too high or low, it will display "HI" or "LO".

#### Error codes:

AS - Room temperature sensor error  
ES - Evaporator temperature sensor error  
HS - Electric heating sensor error;  
CS - Condenser temperature sensor error;  
OS - Outside temperature sensor error;  
E7 - Unit malfunction.

#### NOTE:

When error occurs, unplug the unit and plug it back in. If error repeats, call for service.

#### NOTICE

If the unit breaks off unexpectedly due to the power cut, it will restart with the previous function setting automatically when the power resumes.

#### ADDITIONAL THINGS YOU SHOULD KNOW

Now that you have mastered the operating procedure, here are more features in your control that you should become familiar with.

- The Cool circuit has an automatic 3 minutes time delayed start if the unit is turned off and on quickly. This prevents overheating of the compressor and possible circuit breaker tripping. The fan will continue to run during this time.
- The control is capable of displaying temperature in degrees Fahrenheit or degrees Celsius. To convert from one to the other, press and hold the Up and Down buttons at the same time for 3 seconds.

# REMOTE CONTROL INSTRUCTIONS

## Remote Controller Specifications

Model	RG51G5(1)/EU1
Rated Voltage	3.0V( Dry batteries R03/LR03×2)
Signal Receiving Range	8m
Environment	23°F-140°F (-5°C-60°C)

## Quick Start Guide

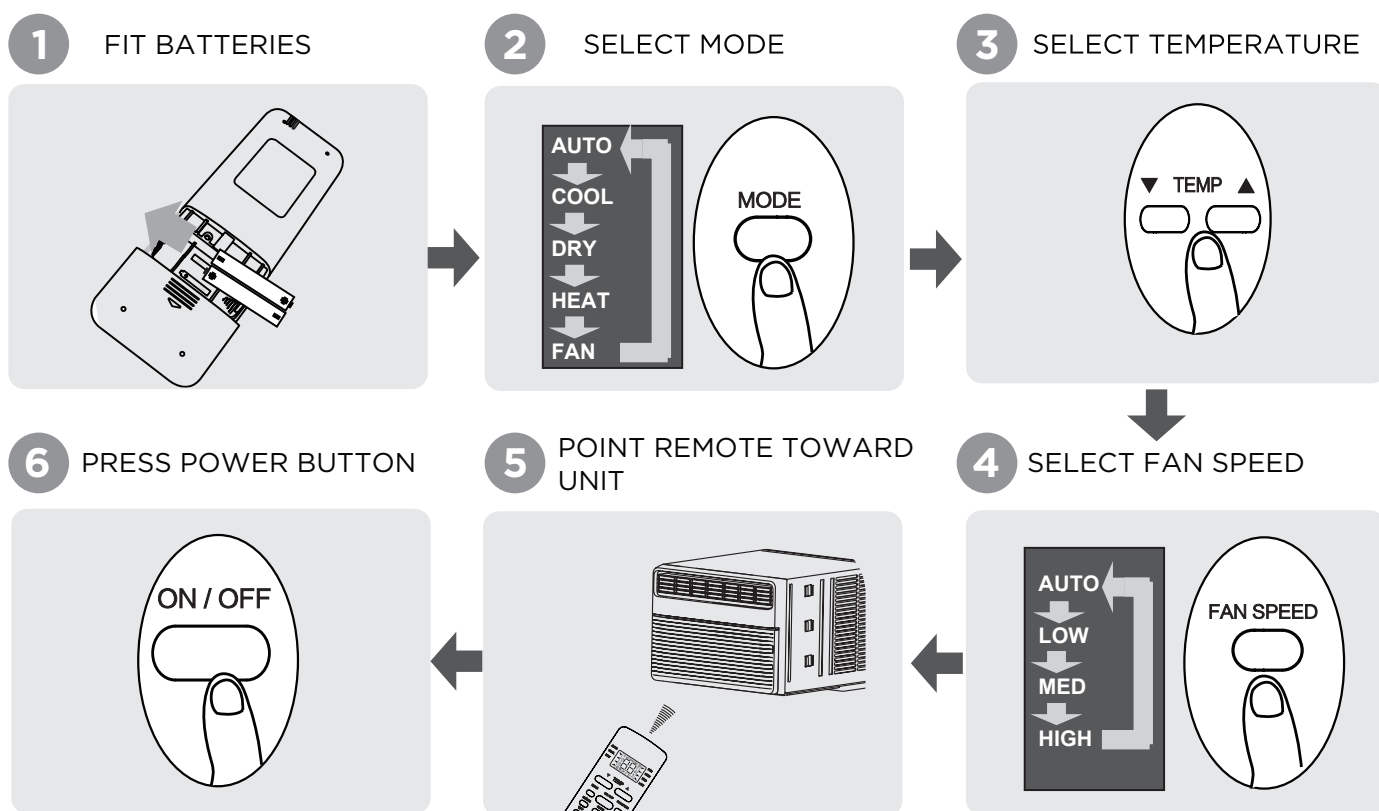

## NOT SURE WHAT A FUNCTION DOES?

Refer to the How to Use Basic Functions and How to Use Advanced Functions sections of this manual for a detailed description of how to use your air conditioner.

## ● SPECIAL NOTE

- Button designs on your unit may differ slightly from the example shown.
- If the indoor unit does not have a particular function, pressing that function's button on the remote control will have no effect.
- When there are wide differences between "Remote controller Manual" and "USER'S MANUAL" on function description, the description of "USER'S MANUAL" shall prevail.

## Handling the Remote Controller

### Inserting and Replacing Batteries

Your air conditioning unit may come with two batteries (some units). Put the batteries in the remote control before use.

1. Slide the back cover from the remote control downward, exposing the battery compartment
2. Insert the batteries, paying attention to match up the (+) and (-) ends of the batteries with the symbols inside the battery compartment.
3. Slide the battery cover back into place.

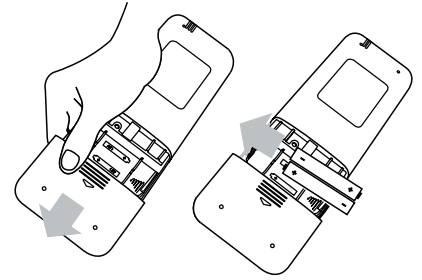

### BATTERY NOTES

For optimum product performance:

- Do not mix old and new batteries, or batteries of different types.
- Do not leave batteries in the remote control if you don't plan on using the device for more than 2 months.

### BATTERY DISPOSAL

Do not dispose of batteries as unsorted municipal waste. Refer to local laws for proper disposal of batteries.

### TIPS FOR USING REMOTE CONTROL

- The remote control must be used within 8 meters of the unit.
- The unit will beep when remote signal is received.
- Curtains, other materials and direct sunlight can interfere with the infrared signal receiver.
- Remove batteries if the remote will not be used more than 2 months

### NOTES FOR USING REMOTE CONTROL

The device could comply with the local national regulations.

- In Canada, it should comply with CAN ICES-3(B)/NMB-3(B).
- In USA, this device complies with part 15 of the FCC Rules. Operation is subject to the following two conditions:
  - (1) This device may not cause harmful interference, and
  - (2) This device must accept any interference received, including interference that may cause undesired operation.

This equipment has been tested and found to comply with the limits for a Class B digital device, pursuant to part 15 of the FCC Rules. These limits are designed to provide reasonable protection against harmful interference in a residential installation. This equipment generates, uses and can radiate radio frequency energy and, if not installed and used in accordance with the instructions, may cause harmful interference to radio communications. However, there is no guarantee that interference will not occur in a particular installation. If this equipment does cause harmful interference to radio or television reception, which can be determined by turning the equipment off and on, the user is encouraged to try to correct the interference by one or more of the following measures:

- Reorient or relocate the receiving antenna. Increase the separation between the equipment and receiver.
- Connect the equipment into an outlet on a circuit different from that to which the receiver is connected.
- Consult the dealer or an experienced radio/TV technician for help.
- Changes or modifications not approved by the party responsible for compliance could void user's authority to operate the equipment.

## Buttons and Functions

Before you begin using your new air conditioner, make sure to familiarize yourself with its remote control. The following is a brief introduction to the remote control itself. For instructions on how to operate your air conditioner, refer to the How to Use Basic Functions section of this manual.

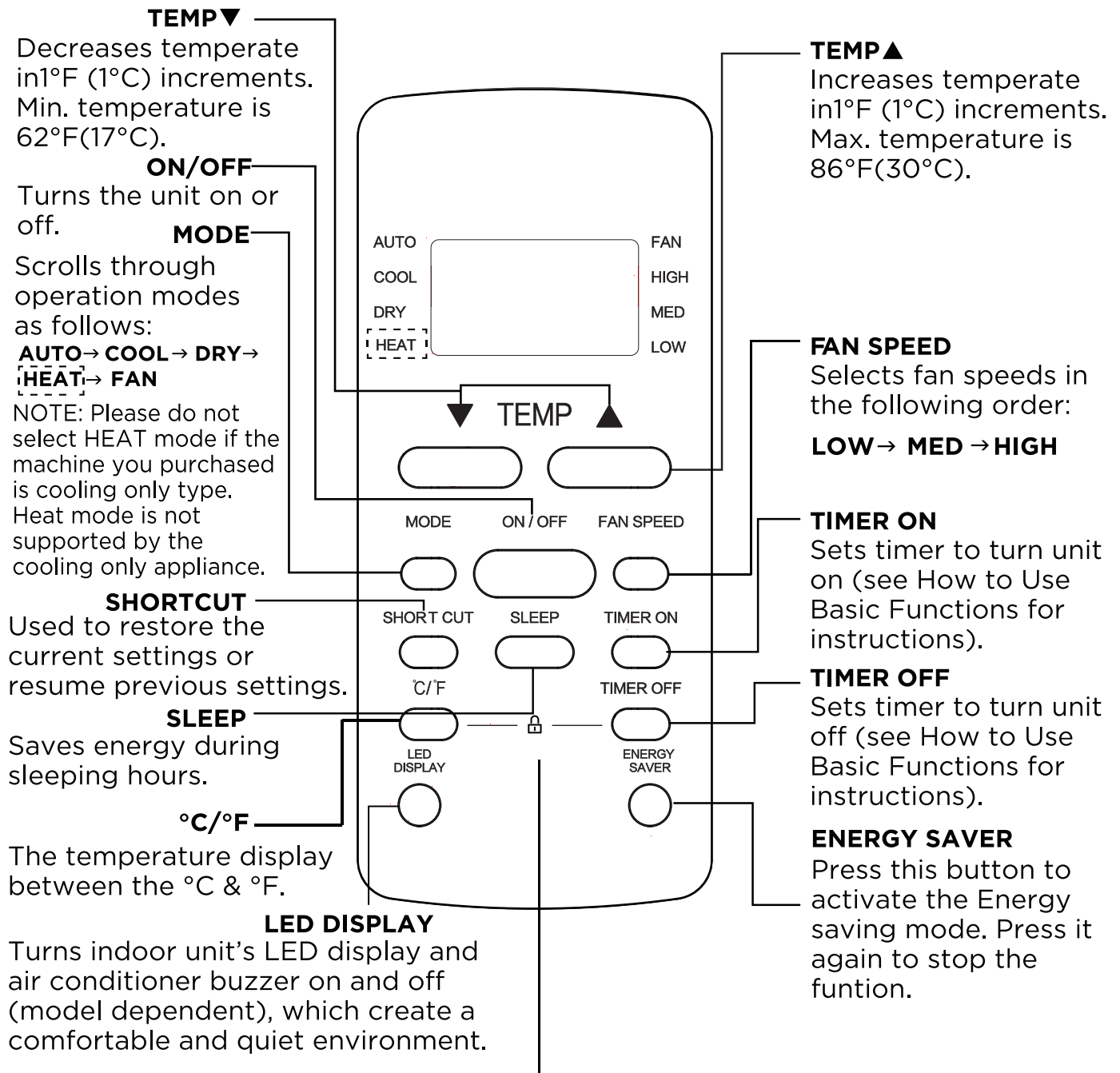

### LOCK

Press together °C/°F & TIMER OFF buttons simultaneously for 5 seconds to lock the keyboard. Press together the two buttons for 2 seconds to unlock the keyboard.

RG51G5(1)/EU1





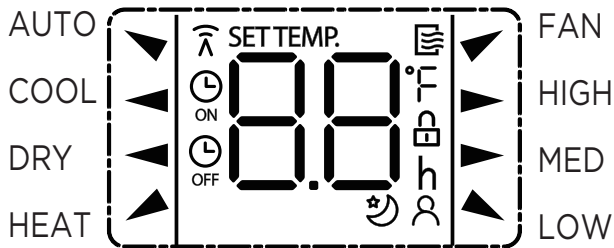



## Remote Screen Indicators

Information are displayed when the remote controller is power up.



### Mode display

AUTO ▼ COOL ◀ DRY ◀  
HEAT ▲ ▼ FAN

- 
-  Displayed when data transmitted.
  -  Displayed when remote controller is ON.
  -  Displayed when TIMER ON time is set
  -  Displayed when TIMER OFF time is set
  -  Shows set temperature or room temperature, or time under TIMER setting
  -  Indicated all the current settings are locked
  -  Displayed when Follow Me feature is activated(some units)
  -  Displayed when SLEEP feature is activated
- 

### Fan speed indication

- ▶ HIGH High speed
  - ▶ MED Medium speed
  - ▲ LOW Low speed
  - NO display Auto fan speed
- 

### Note:

All indicators shown in the figure are for the purpose of clear presentation. But during the actual operation, only the relative function signs are shown on the display window.

## How to Use Basic Functions

### Basic operation



#### ATTENTION

Before operation, please ensure the unit is plugged in and power is available.

### COOL Mode

1. Press the MODE button to select COOL mode.
2. Set your desired temperature using the TEMP ▲ or TEMP ▼ button.
3. Press FAN button to select the fan speed: AUTO, LOW, MED or HIGH.
4. Press the ON/OFF button to start the unit.

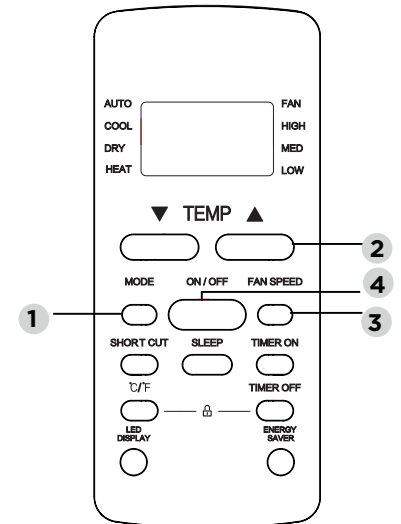

### SETTING TEMPERATURE

The operating temperature range for units is 62-86°F (17-30°C ). You can increase or decrease the set temperature 1 °F(1°C) increments.

### AUTO Mode

In AUTO mode, the unit will automatically select the COOL, FAN, or HEAT operation based on the set temperature.

1. Press the MODE button to select AUTO.
2. Set your desired temperature using the TEMP ▲ or TEMP ▼ button.
3. Press the ON/OFF button to start the unit.

#### NOTE:

FAN SPEED can't be set in AUTO mode.

In AUTO mode, the unit will automatically select the COOL, FAN, HEAT or DRY function based on the set temperature.

1. Press the MODE button to select AUTO.
2. Set your desired temperature using the TEMP ▲ or TEMP ▼ button.
3. Press the ON/OFF button to start the unit.

#### NOTE:

FAN SPEED can't be set in AUTO mode.

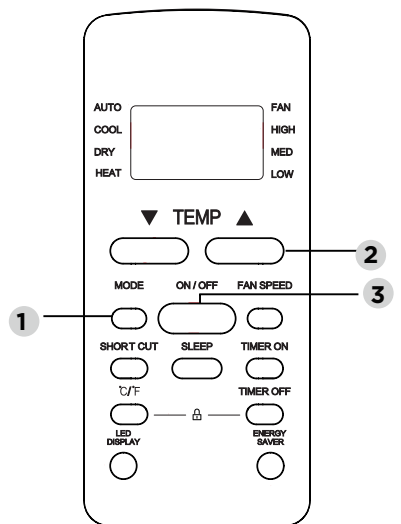

## FAN Mode

1. Press the MODE button to select FAN mode.
2. Press FAN button to select the fan speed: AUTO, LOW, MED or HIGH.
3. Press the ON/OFF button to start the unit.

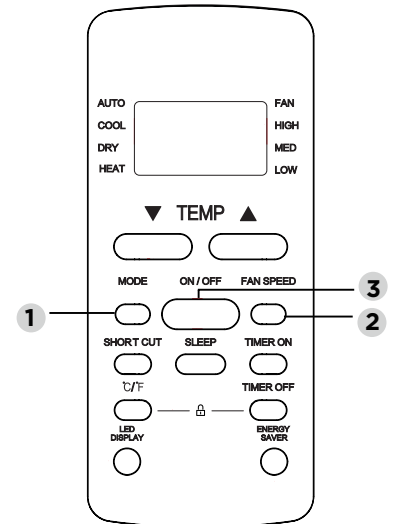

### NOTE:

You can't set temperature in FAN mode. As a result, your remote control's LCD screen will not display temperature.

## DRY Mode (dehumidifying)

1. Press the MODE button to select DRY.
2. Set your desired temperature using the TEMP ▲ or TEMP ▼ button.
3. Press the ON/OFF button to start the unit.

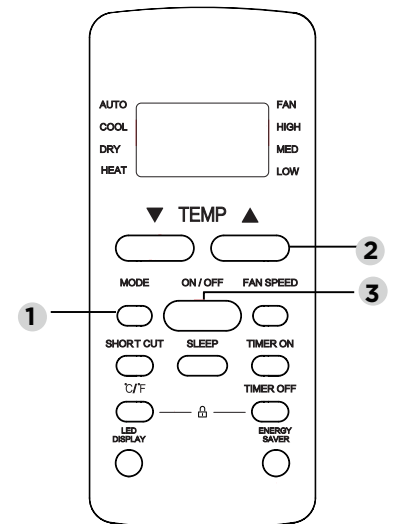

### NOTE:

FAN SPEED cannot be changed in DRY mode.

## HEAT Mode (some models)

1. Press the MODE button to select HEAT mode.
2. Set your desired temperature using the TEMP ▲ or TEMP ▼ button.
3. Press FAN button to select the fan speed: AUTO, LOW, MED or HIGH.
4. Press the ON/OFF button to start the unit.

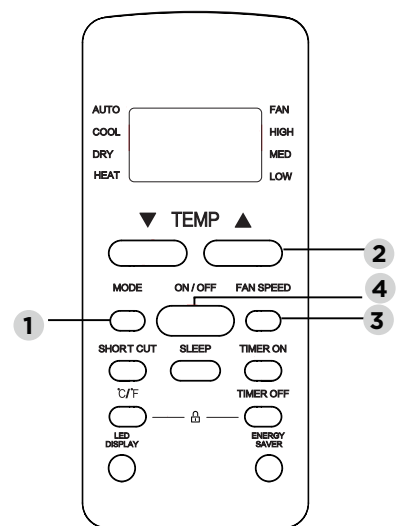

### NOTE:

As outdoor temperature drops, the performance of your unit's HEAT function may be affected. In such instances, we recommend using this air conditioner in conjunction with other heating appliances.

## Setting the TIMER

### TIMER ON/OFF

Set the amount of time after which the unit will automatically turn on/off.

#### TIMER ON setting

Press TIMER ON button to initiate the ON time sequence



Press Temp. up or down button for multiple times to set the desired time to turn on the unit.

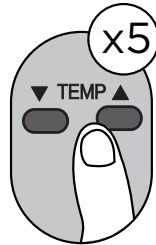

Point remote to unit and wait 1sec, the TIMER ON will be activated.

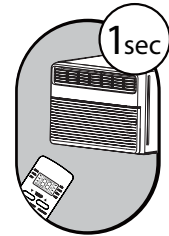

#### TIMER OFF setting

Press TIMER OFF button to initiate the OFF time sequence



Press Temp. up or down button for multiple times to set the desired time to turn off the unit.

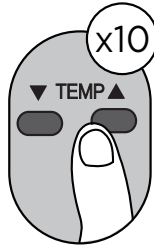

Point remote to unit and wait 1sec, the TIMER OFF will be activated.

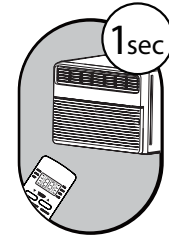

#### NOTE:

1. When setting the TIMER ON or TIMER OFF, the time will increase by 30 minutes increments with each press, up to 10 hours. After 10 hours and up to 24, it will increase in 1 hour increments. (For example, press 5 times to get 2.5h, and press 10 times to get 5h,) The timer will revert to 0.0 after 24.
2. Cancel either function by setting its timer to 0.0h.

#### TIMER ON & OFF setting(example)

Keep in mind that the time periods you set for both functions refer to hours after the current time.

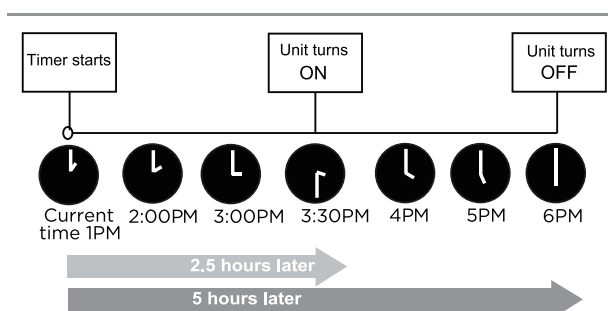
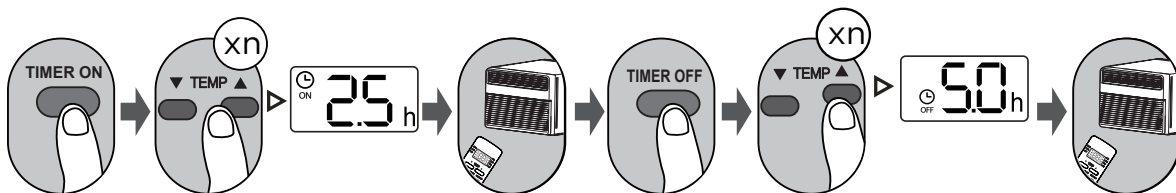

Example: If current timer is 1:00PM, to set the timer as above steps, the unit will turn on 2.5h later (3:30PM) and turn off at 6:00PM.

## How to Use Advanced Functions

### ENERGY SAVER function (some models)



Press Energy saver button to initiate this function. This function is available on COOL, DRY, AUTO (only AUTO-COOLING and AUTO-FAN) modes.

### °C/°F (some models)

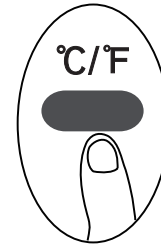

Press this button will alternate the temperature display between the °C & °F.

### SHORTCUT function(some models)

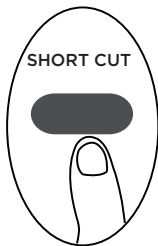

Used to restore the current settings or resume previous settings.(For some models). Push this button when remote controller is on, the system will automatically revert back to the previous settings including operating mode, setting temperature, fan speed level and sleep feature (if activated). If pushing more than 2 seconds, the system will automatically restore the current operation settings including operating mode, setting temperature, fan speed level and sleep feature (if activated ).

### LED DISPLAY

Press LED button

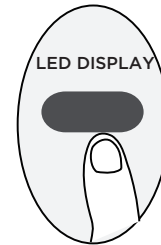

Press this button to turn on and turn off the display on the indoor unit.

### SLEEP function



The SLEEP function is used to decrease energy use while you sleep (and don't need the same temperature settings to stay comfortable). This function can only be activated via remote control. The sleep function is not available in Fan or Dry mode. Please refer to the OWNER'S MANUAL for more details.

# Cleaning & maintenance

## How to clean & change your filter.

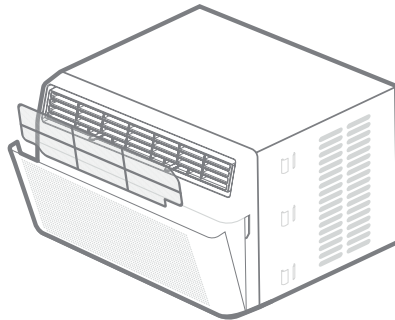

### Check the air filter once a month to see if cleaning is necessary.

The air filter should be checked at least once a month to see if cleaning is necessary. Trapped particles in the filter can build up and cause an accumulation of frost on the cooling coils.

- Push the vent handle to the Vent Closed position (where applicable). Open the front panel.
- Take the filter by the center and pull up and out.
- Wash the filter using liquid dishwashing detergent and warm water. Rinse filter thoroughly. Gently shake excess water from the filter. Be sure the filter is thoroughly dry before replacing. Instead of washing, you may vacuum the filter clean.

#### **Note:**

Never use hot water over 40°C(104°F) to clean the air filter. Never attempt to operate the unit without the air filter.

## Cabinet Cleaning

- Be sure to unplug the air conditioner to prevent shock or fire hazard. The cabinet and front may be dusted with an oil-free cloth or washed with a cloth dampened in a solution of warm water and mild liquid dishwashing detergent. Rinse thoroughly and wipe dry.
- Never use harsh cleaners, wax or polish on the cabinet front.
- Be sure to wring excess water from the cloth before wiping around the controls. Excess water in or around the controls may cause damage to the air conditioner.
- Plug in air conditioner.

### **WARNING**

Clean your air conditioner occasionally to keep it looking new. **Be sure to unplug the unit before cleaning to prevent shock or fire hazards.**

### **CAUTION:**

If you plan to store the air conditioner during the winter, remove it carefully from the window according to the installation instructions. Cover it with plastic or return it to the original carton.

# TROUBLESHOOTING

## Problem Solving

Before calling for service, review this list. It may save your time and expense. This list includes common occurrences that are not the result of defective workman-ship or materials in this appliance.

Problem	Solution
Air conditioner does not start.	Wall plug disconnected. Push plug firmly into wall outlet.
	House fuse blown or circuit breaker tripped. Replace fuse with time delay type or reset circuit breaker.
	Plug Current Device Tripped. Press the RESET button.
	Power is OFF. Turn power ON.
Air from unit does not feel cold enough.	Room temperature below 62°F(17°C). Cooling may not occur until room temperature rises above 62°F(17°C).
	Temperature sensing behind air filter element touching cold coil. Keep it from the cold coil.
	Set to a Lower temperature.
	Compressor stopped when changing modes. Wait for 3 minutes after set to the COOL mode.
Air conditioner cooling, but room is too warm-ice forming on cooling coil behind decorative front.	Outdoor temperature below 64°F(18°C). To defrost the coil, set FAN ONLY mode.
	Air filter may be dirty. Clean filter. Refer to Care and Cleaning section. To defrost, set to FAN ONLY mode.
	Thermostat set too cold for night-time cooling. To defrost the coil, set to FAN ONLY mode. Then, set temperature to a Higher setting.
Air conditioner cooling, but room is too warm-NO ice forming on cooling coil behind decorative front.	Dirty air filter- air restricted. Clean air filter. Refer to Care and Cleaning section.
	Temperature is set too High, set temperature to a Lower setting.
	Air directional louvers positioned improperly. Position louvers for better air distribution.
	Front of units is blocked by drapes, blinds, furniture, etc. - restricts air distribution. Clear blockage in front of unit.
	An open doors, windows,or register may allow cold air to escape. Close any doors, winows, or registers.
	The room may be too warm. Allow additional time to remove "Stored heat" from walls, ceiling, floor and furniture.
Air conditioner turns on and o rapidly	Dirty air filter- air restricted. Clean air filter.
	Outside temperature extremely hot. Set FAN speed to a Higher setting to bring air past cooling coils more frequently.
Noise when unit is cooling	Air movement sound. This is normal . If too loud, set to a slower FAN setting.
	Window vibration - poor installation. Refer to installation instructions or check with installer.

<b>Problem</b>	<b>Solution</b>
Water dripping INSIDE when unit is cooling.	Improper installation. Tilt air conditioner slightly to the outside to allow water drainage. Refer to installation instructions - check with installer.
Water dripping OUTSIDE when unit is cooling.	Unit removing large quantity of moisture from humid room. This is normal during excessively humid days.
Remote Sensing Deactivating Prematurely (Only remote models)	Remote control not located within range. Place remote control within 20 feet and pointed in the general direction of the air conditioner unit.
	Remote control signal obstructed. Remove obstruction.
Room too cold	Set temperature too low. Increase set temperature.

The design and specifications are subject to change without prior notice for product improvement. Any updates to the manual will be uploaded to the Midea website ([www.midea.com/us](http://www.midea.com/us)), please check for the current version.

# CONNECTION INSTRUCTIONS

## 1. How to Use Matter ✨

### Connect Your Air Conditioner Through Matter



Make sure your mobile device is connected to your wireless router. The wireless router should support and turn on IPv6. Please make sure your smartphone is connected to the 2.4G, not the 5G network. For the best Matter compatibility, connect the AC to the Alexa, Google Home or Apple Home ecosystems, along with at least one of their respective Matter-enabled smart speakers.

### STEP 1: Connect to Smart Speakers

Select your preferred ecosystems (Alexa, Google Home or Apple Home) and make sure you've got one of their Matter-enabled products (such as their smart speakers) connected to your wireless router.

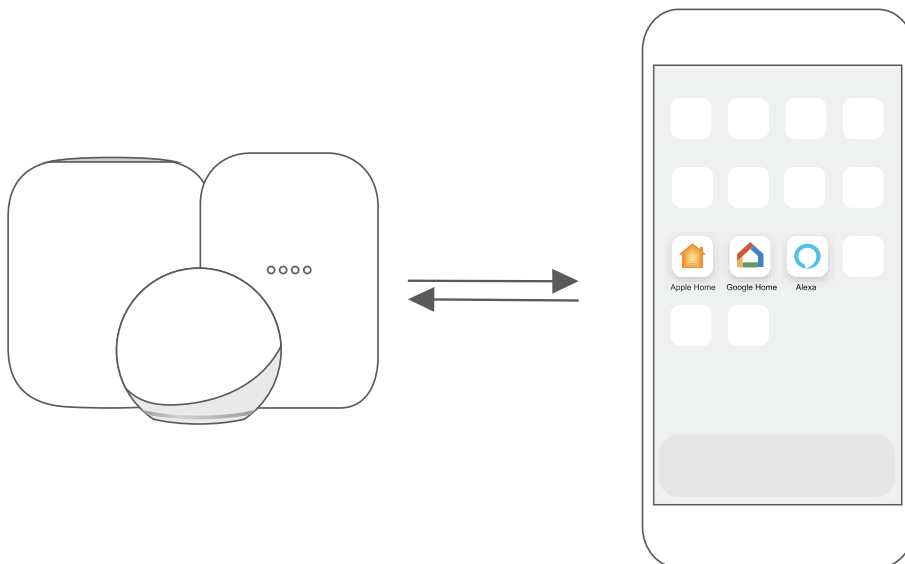

### STEP 2: Turn On Bluetooth

Turn on Bluetooth on your mobile device.

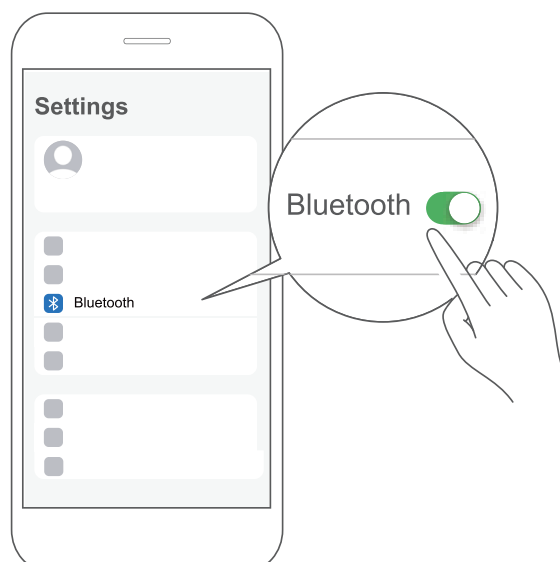

### STEP 3: Enter AP Mode

Hold down the CONNECT button for 3 seconds to begin the pairing process (“AP” will appear on the AC’s display).

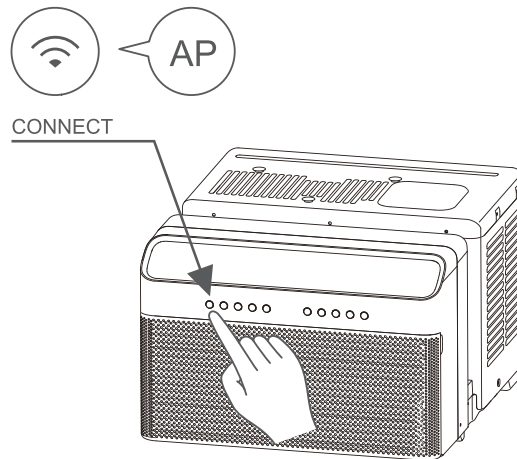

### STEP 4: Open App

Open the Alexa, Google Home or Apple Home app on your mobile device.

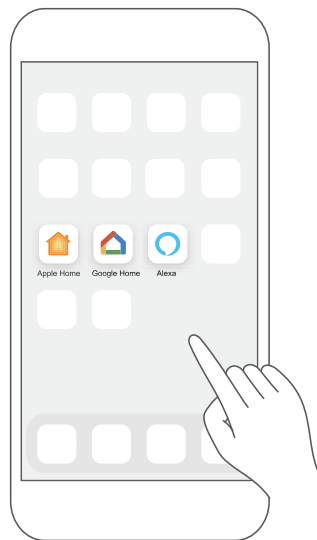

### STEP 5: Scan Matter QR code

Tap the “+” and “Add Device/ Accessory” or tap “+Add” in your app, select Matter device and scan the Matter QR code found on the side of the AC device. Follow the respective instructions in the Alexa, Google Home or Apple Home app to complete the pairing process.

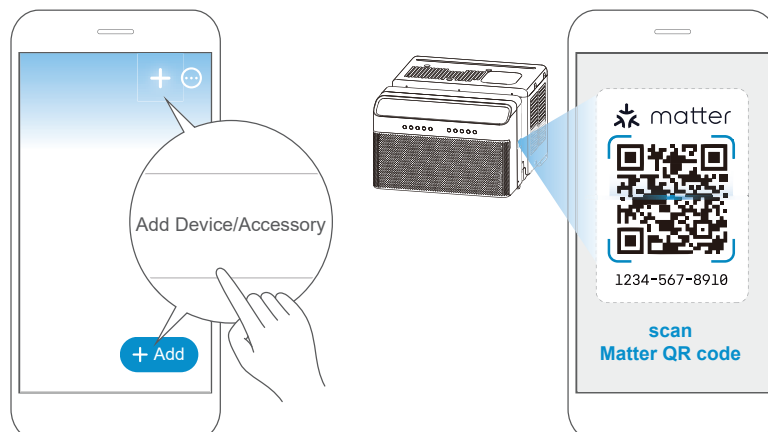

## STEP 6: Control Device

After pairing is successful, you can control your AC's temperature and mode settings, etc. through the respective ecosystem app and/or smart speaker.

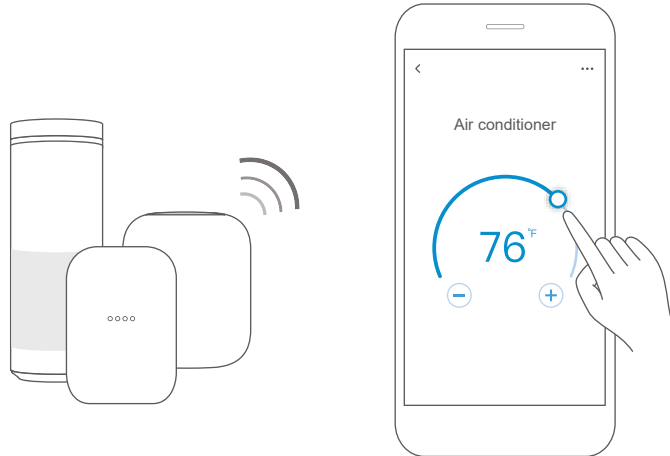

App & Smart Speakers can support Matter only when using these versions or above.

Device	Version
iPhone	iOS 16.5
Apple Home Pod	16.5
Android	Google Play services min version: 22.36.15 Google Home app (GHA) min version: 2.58.24.1 - dogfood
Google Home Hub	Google Hub firmware min version: 1.56.324896 (appears on hub as Chromecast firmware version)
Alexa App	2.2.536317
Alexa Echo Device	9094439556

### **NOTE**

- Setup processes and features may vary between ecosystems.
- Make sure the Matter-enabled app is up to date to ensure the best experience.
- Periodically, we will update the device's software to improve the experience. Device software updates can be accomplished through the SmartHome app.

## 2. How to Use SmartHome



Ensure that your mobile phone is connected to the wireless network. Bluetooth must be turned on. The device must also be powered on.

### STEP 1: Download the SmartHome App

Scan the QR code below to download the SmartHome app from the app store or search for it directly on the Google Play Store or Apple's App Store.

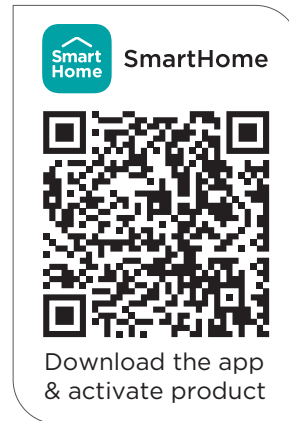

### STEP 2: Log in

Open the SmartHome app. Log in directly if you have an existing SmartHome account or create a new account. Alternatively, you can also use a 3rd party login platform.



### STEP 3: Connecting the Device

(1) When you log in, you may see the message "Smart devices discovered nearby". Tap to add your device.

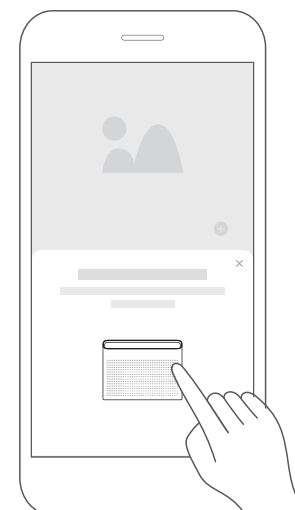

(2) If no such message appears, proceed as follows: Tap on “+” and select your device in the list of nearby available devices. If your device is not listed, please add your device manually. Select the device category (e.g. Window AC) and find your device model in the list.



(3) Follow the steps in the app to connect your device to the wireless network. If your device fails to connect, follow the additional instructions in the app.

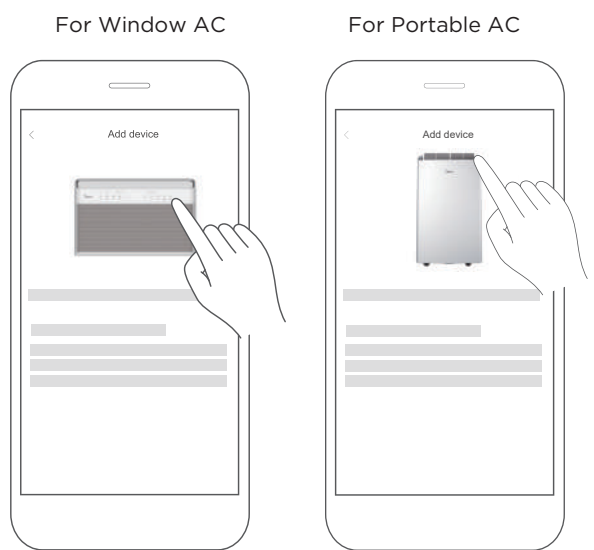

## STEP 4: Controlling the Device

After pairing successfully, a card will be created for the device in the SmartHome app. Shortcuts for basic functions will appear on the card, such as changing the temperature or switching the device on or off. Tapping on the card will reveal additional features and settings. The actual UI design may look different from examples due to app updates.

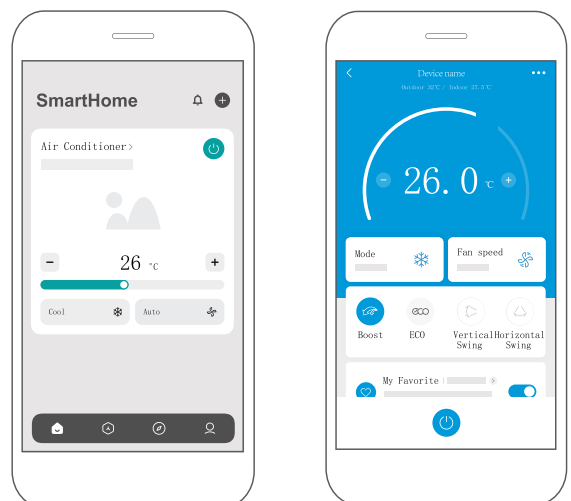

## Declaration of Conformity

FCC ID: 2ADQOMDNA23

IC: 12575A-MDNA23

This device complies with Part 15 of the FCC Rules and Industry Canada's licence exempt RSSs.

Operation is subject to the following two conditions:

- (1) This device may not cause interference;
- (2) This device must accept any interference, including interference that may cause undesired operation of the device.

Only operate the device in accordance with the instructions supplied.

Changes or modifications to this unit not expressly approved by the party responsible for compliance could void the user's authority to operate the equipment.

This device complies with FCC radiation exposure limits set forth for an uncontrolled environment. In order to avoid the possibility of exceeding the FCC radio frequency exposure limits, human proximity to the antenna shall not be less than 20cm (8 inches) during normal operation.

### NOTE

This equipment has been tested and found to comply with the limits for a Class B digital device, pursuant to part 15 of the FCC Rules. These limits are designed to provide reasonable protection against harmful interference in a residential installation.

This equipment generates, uses and can radiate radio frequency energy and, if not installed and used in accordance with the instructions, may cause harmful interference to radio communications. However, there is no guarantee that interference will not occur in a particular installation. If this equipment does cause harmful interference to radio or television reception, which can be determined by turning the equipment off and on, the user is encouraged to try to correct the interference by one or more of the following measures:

- Reorient or relocate the receiving antenna.
- Increase the separation between the equipment and receiver.
- Connect the equipment into an outlet on a circuit different from that to which the receiver is connected.
- Consult the dealer or an experienced radio/TV technician for help.

## Specifications

This device is in compliance with the essential requirements and other relevant provisions of Directive 2014/53/EU. In order to avoid the possibility of exceeding the radio frequency exposure limits, human proximity to the antenna shall not be less than 20cm during normal operation. (European Union products only)

Unit model: MAW08HN1CWT,MAW12HN1CWT	Operation Temperature: 0°C ~ 45°C / 32°F ~ 113°F
Wireless Module Model: US-SK109	Operation Humidity: 10% ~ 85%
Antenna Type: Printed PCB Antenna	Power Input: DC 5V/500 mA
Wireless: 2400 - 2483.5MHz, TX Power: < 20dBm	BLE: 2402 - 2480MHz, TX Power: < 10dBm

**Supplier's Declaration of Conformity  
Per FCC Part 2 Section 2.1077**

**Unique Identifier:** Midea brand, RG51G5(1)/EU1

**Responsible Party - U.S. Contact Information**

Midea America Corporation

300 Kimball Dr

Parsippany NJ

07054

Telephone number or internet contact information: [Midea.com/us](http://Midea.com/us)

**FCC Compliance Statement**

This device complies with Part 15 of the FCC Rules. Operation is subject to the following two conditions: (1) This device may not cause harmful interference, and (2) this device must accept any interference received, including interference that may cause undesired operation.

# WARRANTY

## Air Conditioner Limited Warranty

Your product is protected by this Limited Warranty:

Warranty service must be obtained from Midea Consumer Services or an authorized Midea servicer.

---

### Warranty

- Three Year Full warranty from the date of delivery or the purchase date, whichever is later.
- The date of delivery establishes the warranty period, should service be required.

### Midea, through its authorized servicers will:

- Pay all costs for repairing or replacing parts of this appliance which prove to be defective in materials or workmanship.

### Consumer will be responsible for:

- Diagnostics, removal, transportation and reinstallation cost required because of service.
- Costs of service calls that are a result of items listed under NORMAL RESPONSABILITIES OF THE CONSUMER\*\*

Midea replacement parts shall be used and will be warranted only for the original warranty.

---

### NORMAL RESPONSABILITIES OF THE CONSUMER\*\*

**This warranty applies only to products in ordinary household use, and the consumer is responsible for the items listed below:**

1. Proper use of the appliance in accordance with instructions provided with the product.
2. Routine maintenance and cleaning necessary to keep the good working condition.
3. Proper installation by an authorized service professional in accordance with instructions provided with the appliance and in accordance with all local plumbing, electrical and/or gas codes.
4. Proper connection to a grounded power supply of sufficient voltage, replacement of blown fuses, repair of loosen connections or defects in house wiring.
5. Expenses for making the appliance accessible for servicing.
6. Damages to finish after installation.

### EXCLUSIONS

**This warranty does not cover the following:**

- 1) Failure caused by damage to the unit while in your possession (other than damage caused by defect or malfunction), by its improper installation, or by unreasonable use of the unit, including without limitation, failure to provide reasonable and necessary maintenance or to follow the written installation and Operating Instructions.
- 2) Damages caused by services performed by persons other than those authorized by Midea customer service; or external causes such as abuse, misuse, inadequate power supply or acts of God.
- 3) If the unit is put to commercial, business, rental, or other use or application other than for consumer use, we make no warranties, express or implied, including but not limited to, any implied warranty of merchantability or fitness for use or purpose.
- 4) Products without original serial numbers or products that have serial numbers which have been altered or cannot be readily determined.

**NOTICE: Some states do not allow the exclusions or limitation of incidental or consequential damages. So this limitation or exclusion may not apply to you.**

### IF YOU NEED SERVICE

Keep your bill of sale, delivery slip, or some other appropriate payment Record.

The date on the bill establishes the warranty period, should service be required.

If service is performed, its your best interest to obtain and keep all receipts.

This written warranty gives you specific legal rights. You may also have other rights that vary from state to state.

Service under this warranty must be obtained by following these steps, in order:

- 1) Contact Midea Consumer Services or an authorized Midea services at 1 866 646 4332.
- 2) If there is a question as to where to obtain service, contact our consumer relations Departament.



*make yourself at home*



[www.midea.com](http://www.midea.com)

© Midea 2025 all rights reserved