

WINDOW TYPE ROOM AIR CONDITIONER

USER MANUAL

MAW10RV1CWT
MAW12RV1CWT
MAW14RV1CWT



Warning notices: Before using this product, please read this manual carefully and keep it for future reference. The design and specifications are subject to change without prior notice for product improvement. Consult with your dealer or manufacturer for details. The diagram above is just for reference. Please take the appearance of the actual product as the standard.

THANK YOU LETTER

Thank you for choosing Midea! Before using your new Midea product, please read this manual thoroughly to ensure that you know how to operate the features and functions that your new air conditioner offers in a safe way.

CONTENTS

TABLE OF CONTENTS	2
SAFETY INSTRUCTIONS	3
WHAT IS IN THE BOX	7
BEFORE YOU GET STARTED	8
INSTALLATION OVERVIEW	9
GET TO KNOW YOUR AC	16
GET TO KNOW THE FEATURES	17
REMOTE CONTROL INSTRUCTIONS	20
CONNECTION INSTRUCTIONS	28
CLEANING & MAINTENANCE	34
TROUBLESHOOTING TIPS	35
WARRANTY	38

SAFETY INSTRUCTIONS

Must Read The Warning Message

Inside you will find many helpful hints on how to use and maintain your air conditioner properly. Just a little preventive care on your part can save you a great deal of time and money over the life of your air conditioner. You'll find many answers to common problems in the chart of troubleshooting tips. If you review our chart of Troubleshooting Tips first, you may not need to call for service at all. To prevent injury to the user or other people and property damage, the following instructions must be followed. Incorrect operation due to ignoring of instructions may cause harm or damage. The seriousness is classified by the following indications.

Explanation of Symbols

Please read Safety Precautions before operation and installation. To prevent injury to the user or other people and property damage, the instructions shown here must be followed. Incorrect operation or installation due to ignoring instructions may cause harm or damage. The level of risk is shown by the following indications, which will be used throughout this user manual.



WARNING

The signal word indicates a hazard with a medium level of risk which, if not avoided, may result in serious injury or death.



CAUTION

The signal word indicates a hazard with a low degree of risk which, if not avoided, may result in minor or moderate injury.



NOTE

This signal word indicates important information (e.g. damage to property), but not danger.



WARNING

- Plug in power plug properly. Otherwise, it may cause electric shock or fire due to excess heat generation. Do not operate or stop the unit by inserting or pulling out the power plug. It may cause electric shock or fire due to heat generation. Do not damage or use an unspecified power cord, as that may cause electric shock or fire. If the power cord is damaged, it must be replaced by the manufacturer or an authorised service centre or a similarly qualified person in order to avoid a hazard.
- Always install a circuit breaker and a dedicated power circuit. Incorrect installation may cause fire and electric shock. Do not operate with wet hands or in a damp environment, as that may cause electric shock. Do not direct airflow at room occupants only, which could damage your health.
- Always ensure effective grounding. Incorrect grounding may cause electric shock. Do not allow water to run into electric parts, as that may cause failure of machine and electric shock. Do not modify power cord length or share the outlet with other appliances, as that may cause electric shock or fire due to heat generation.
- Unplug the unit if strange sounds, smells, or smoke comes from it, as that may cause fire and electric shock. Do not use the socket if it is loose or damaged. It may cause fire and electric shock. Do not open the unit during operation, as that may cause electric shock.
- Keep firearms away. It may cause fire. Do not use the power cord close to heating appliances. It may cause fire and electric shock. Do not use the power cord near flammable gas or combustibles, such as gasoline, benzene, thinner, etc. It may cause an explosion or fire.
- Ventilate room before operating air conditioner if there is gas leakage from another appliance, as that may cause explosion, fire, and burns. Do not disassemble or modify unit, as that may cause failure and electric shock.

WARNING

- When the air filter is to be removed, do not touch the metal parts of the unit, as that may cause an injury. Ventilate the room well when used together with a stove, etc, or an oxygen shortage may occur.
- Do not use strong detergents such as wax or thinner. Instead, use a soft cloth. Appearance may deteriorate due to change of product color or scratching of its surface. Do not clean the air conditioner with water. Water may enter the unit, degrade the insulation, and cause an electric shock. Do not use for special purposes. Do not use this air conditioner to preserve precision devices, food, pets, plants, and art objects, as that may cause deterioration of quality, etc.
- Stop operation and close the window in a storm or hurricane. Operation with windows opened may cause wetting of indoor areas and soaking of household furniture. When the unit is to be cleaned, switch it off and turn off the circuit breaker.
- Do not clean unit when the power is on, as that may cause fire, electric shock, and/or injury.
- Always insert the filters securely, as operating without filters can cause failure. Please clean the filters once every two weeks.
- Hold the plug by the head of the power plug when taking it out to prevent electric shock and damage. Turn off the main power switch when not using the unit for a long time to prevent failure of product or fire.
- Do not place obstacles around air-inlets or inside of air-outlet, as that may cause failure of appliance or accident. Do not place heavy objects on the power cord and ensure that the cord is not compressed. There is danger of fire or electric shock. Don't drink water drained from the air conditioner. It contains contaminants and could make you sick.
- Use caution when unpacking and installing. Sharp edges could cause injury.
- If water enters the unit, turn the unit off at the power outlet and switch off the circuit breaker. Isolate supply by taking the power plug out and contact a qualified service technician.
- This appliance is not intended for use by persons (including children) with reduced physical, sensory or mental capabilities or lack of experience and knowledge, unless they have been given supervision or instruction concerning use of the appliance by a person responsible for their safety.
- Children should be supervised to ensure that they do not play with the appliance.
- If the supply cord is damaged, it must be replaced by the manufacturer, its service agent or similarly qualified persons in order to avoid a hazard.
- The appliance shall be installed in accordance with national wiring regulations.
- Installation must be performed in accordance with the requirement of NEC and CEC by authorized personnel only.
- Do not operate your air conditioner in a wet room, such as a bathroom or laundry room.
- The appliance with electric heater shall have at least 1 meter of space from any combustible materials.
- Contact an authorised service technician for repair or maintenance of this unit.
- Contact an authorised installer for installation of this unit.

NOTE

This air conditioner is designed to be operated under the following conditions:

Cooling Operation	Outdoor temperature: 64-109°F/18-43°C
	Indoor temperature: 60-90°F/16-32°C

Note: Performance may be reduced outside of these operating temperatures.

Operation of Current Device

The power supply cord contains a current device that senses damage to the power cord. To test your power supply cord to the following:

- Plug in the Air Conditioner.
- The power supply cord will have TWO buttons on the plug head. Press the TEST button. You will notice a click as the RESET button pops out.
- Press the RESET button again. You will notice a click as the button engages.
- The power supply cord is now supplying electricity to the unit. (On some products, this is also indicated by a light on the plug head.)

NOTE

- The power supply cord with this air conditioner contains a current detection device designed to reduce the risk of fire.
- In the event that the power supply cord is damaged, it cannot be repaired - it must be replaced with a cord from the product manufacturer.
- Do not use this device to turn the unit on or off. Always make sure the RESET button is pushed in for correct operation.
- The power supply cord must be replaced if it fails to reset when the TEST button is pushed or if it cannot be reset. A new one can be obtained from the product manufacturer.

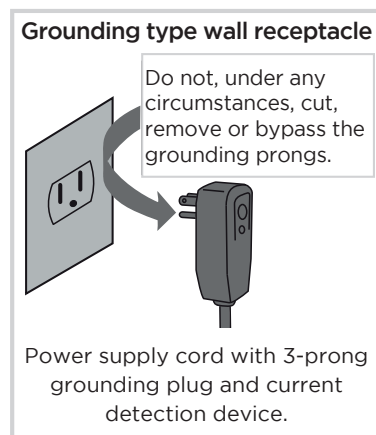

WARNING

Electrical Information

The complete electrical rating of your new room air conditioner is stated on the serial plate. Refer to the rating when checking the electrical requirements.

- Be sure the air conditioner is properly grounded. To minimize shock and fire hazards, proper grounding is important. The power cord is equipped with a three-prong grounding plug for protection against shock hazards.
- Your air conditioner must be used in a properly grounded wall receptacle. If the wall receptacle you intend to use is not adequately grounded or protected by a time delay fuse or circuit breaker, have a qualified electrician install the proper receptacle. Ensure the receptacle is accessible after the unit installation.
- Do not run air conditioner without side protective cover in place. This could result in mechanical damage within the air conditioner.
- Avoid fire hazard or electric shock. Do not use an extension cord or an adapter plug. Do not remove any prongs from the power cord.

For Your Safety

- Do not store or use gasoline or other flammable vapors and liquids in the vicinity of this or any other appliance.

Prevent Accidents

To reduce the risk of fire, electrical shock, or injury to persons when using your air conditioner, follow basic precautions, including the following:

- Be sure the electrical service is adequate for the model you have chosen. This information can be found on the serial plate, which is located on the side of the the cabinet and behind the grille.
- If the air conditioner is to be installed in a window, you will probably want to clean both sides of the glass first. If the window is a triple-track or it has a screen panel included, remove the screen completely before installation.
- Be sure the air conditioner has been securely and correctly installed according to the installation instructions in this manual. Save this manual for possible future use in removing or installing this unit. When handling the air conditioner, be careful to avoid cuts from sharp metal fins on front and rear coils.

Electronic Work



WARNING:

BEFORE PERFORMING ANY ELECTRICAL OR WIRING WORK, TURN OFF THE MAIN POWER TO THE SYSTEM.

Electronic Type

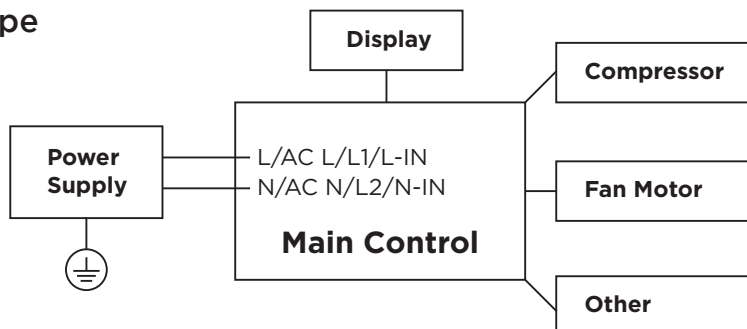

NOTE

Please strictly follow the wiring label attached to the machine for all wiring connections. The wiring diagram may vary for different units. Please refer to the wiring diagram on the machine you have purchased. The above wiring diagram is a simplified version for preliminary illustration purposes only.

WHAT IS IN THE BOX

Package Content

 X2  X2  X7

1/2" Screws and Safety
Lock (3 Types)



Top Rail

 X4

3/8" Screws

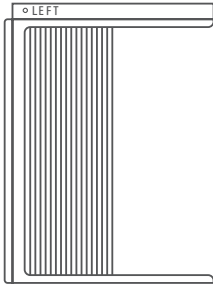

Sliding Frame (Left)

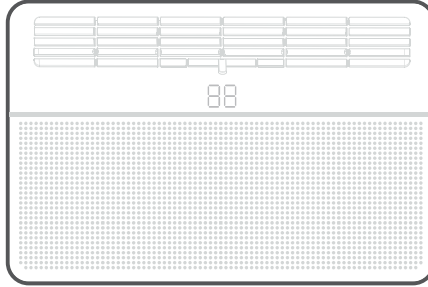

Window Type Room
Air Conditioner unit

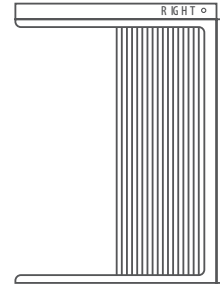

Sliding Frame (Right)

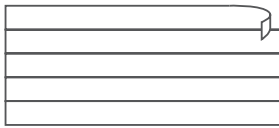

Foam insert (E-Star model only)



Window Sash Seal
Foam (with glue)



Window Sash Seal
Foam (non-glue)

Tools You Will Need

Phillips Screwdriver

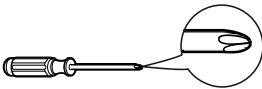

Level



Flathead Screwdriver



Pencil

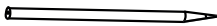

Ruler or tape measure

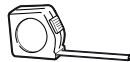

Scissors or knife



Drill

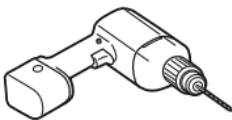

Proper PPE



NOTE

The unit you purchased may look different. Please refer to the actual product as the standard.

BEFORE YOU GET STARTED

Preparations Before Installation



The installation must be carried out in strict accordance with the instructions in this manual.



Installing your AC should take about 60 minutes.



We recommend doing this with a helper.



We're here if you need us. Please contact your local distributor for assistance.

NOTE

Save the carton and these Installation Instructions for future reference. The carton is the best way to store unit during winter or when not in use.

Window Requirements

Your air conditioner is designed to install in standard double hung windows with opening widths of 23 to 36 inches (584mm to 914mm).

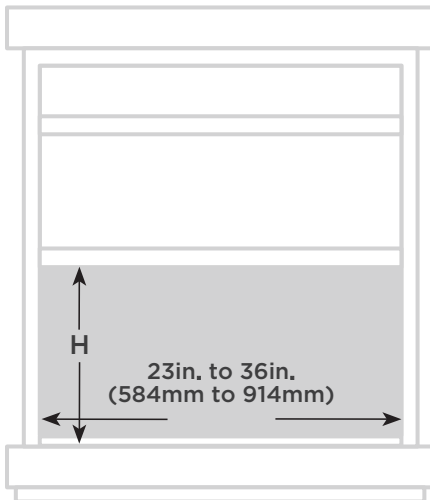

Window opening height	8000-10000Btu/h	12000-14500Btu/h
H	14in. (356mm)	15½in. (394mm)

CAUTION

- Do not, under any circumstances, cut or remove the third (ground) prong from the power cord.
- Do not change the plug on the power cord of the air conditioner.
- Aluminum house wiring may present special problems - consult a qualified electrician.
- When handling unit, be careful to avoid cuts from sharp metal edges and aluminum fins on front and rear coils.
- The rear of the unit must be outdoors, not inside a building or garage.

INSTALLATION OVERVIEW

Installation Completion Display

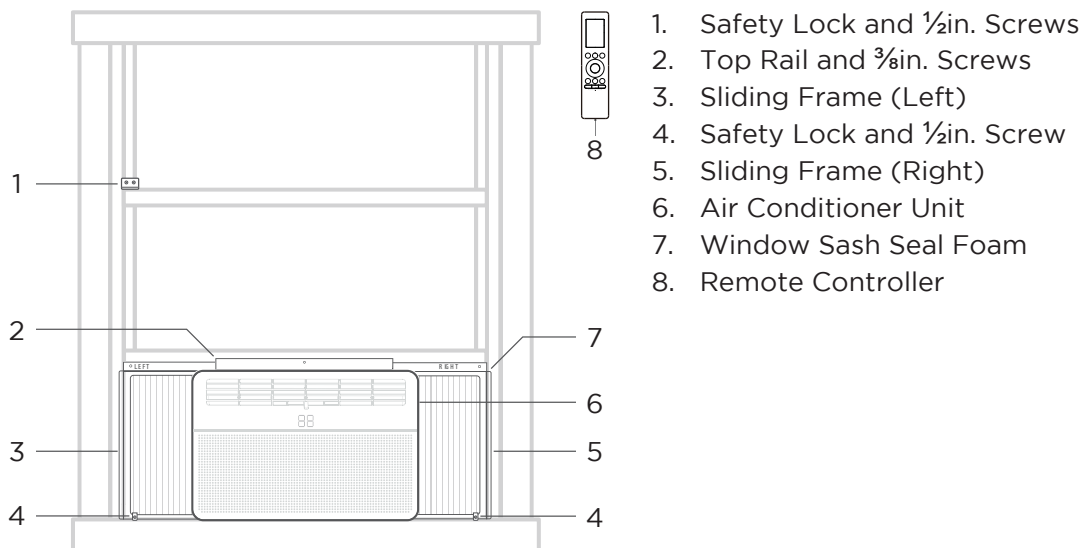

NOTE

Illustrations in this manual are for explanatory purposes. The actual shape of your indoor unit may be slightly different. The actual shape is the standard.

STEP 1: Install Your AC Unit

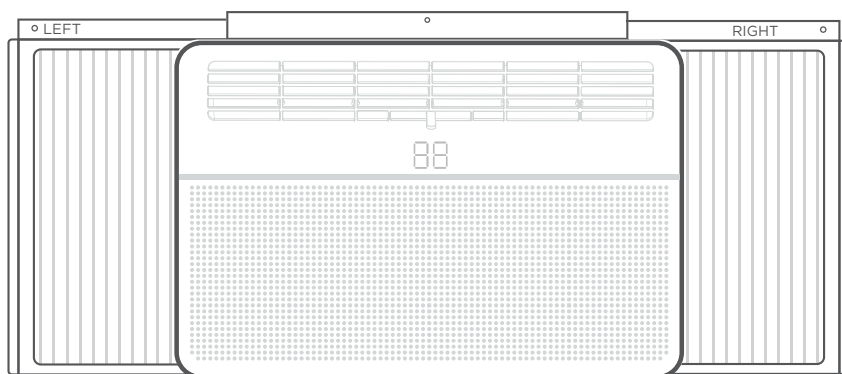

What you need.



Install your air conditioner:

(1) Install the top rail on the AC.

Install the top rail on the AC with the four $\frac{3}{8}$ in. screws. For safety reasons, all 4 screws MUST be securely fastened.

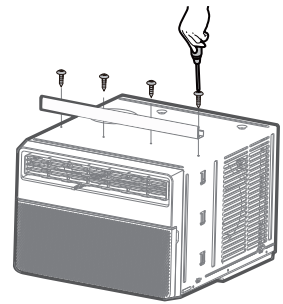

(2) Pull the accordion panels out.

Take one of the sliding frames. Pull the accordion panel halfway out of the track, leaving half of the panel still attached. Repeat with the other sliding frame.

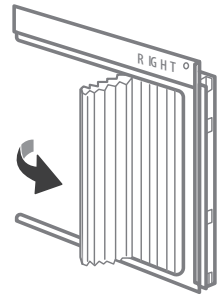

(3) Install the accordion panels.

Facing the air conditioner, take the sliding frame labeled RIGHT. Slide the outer edge of the accordion panel into the slot on the right side of the air conditioner. Repeat with the left sliding frame and the left side.

Pay attention to the differences between the left and right sliding frames. Make sure you slot them into the correct sides.

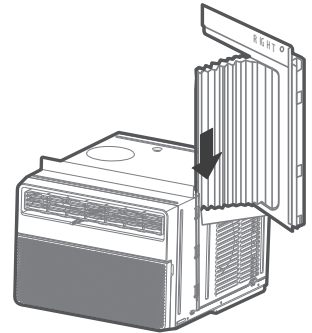

NOTE

Top rail and sliding frames at each side are offset to provide the proper pitch to the rear of $\frac{5}{16}$ in. This is necessary for proper condensed water utilization and drainage. If you are not using the sliding frames for any reason, this pitch to the rear must be maintained.

(4) Fasten the sliding frames into the air conditioner.

Stretch the sliding frames outward. Insert the top and bottom frame strips into the slots at the top and bottom of the air conditioner. Make sure that the accordion panels are securely inside the tracks.

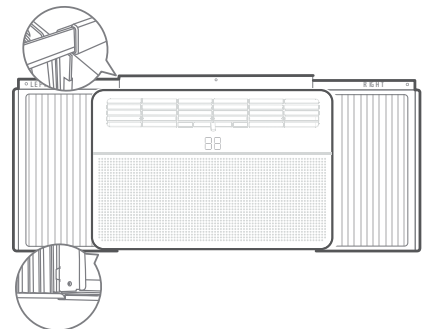

(5) Check the air conditioning unit.

Before you go to the next installation phase, please check that:

- The top and bottom sliding frame strips fit into the slots at the top and bottom of the air conditioner.
- The top rail has been screwed into the air conditioner with all four screws.
- The accordion panels are in the slots at the sides of the air conditioner, and the left and right panels are installed on the correct sides.

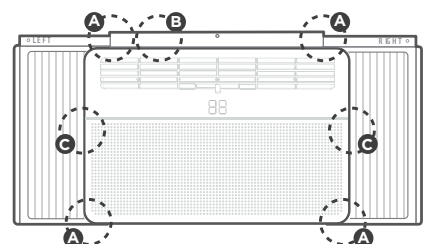

STEP 2: Insulate Your Window

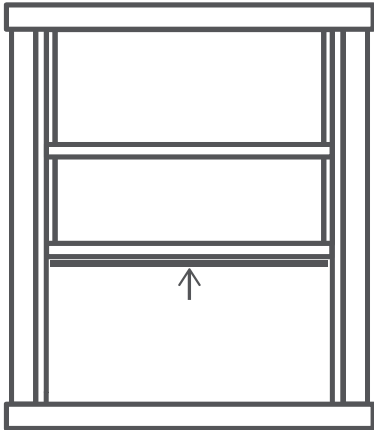

What you need.

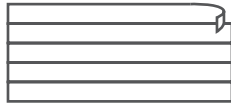

Insulate your window:

- (1) **Cut the adhesive foam to the width of your window, and stick it to the underside.**

Take the adhesive foam. Cut the foam to the width of your window (measured from the left to the right side). Stick the foam to the underside of the window.

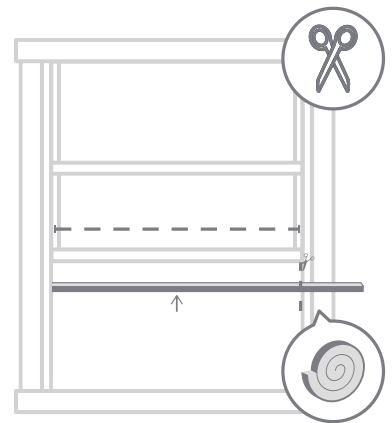

- (2) **Insert the foam into the gaps.**

Foam seal all remaining gaps to improve equipment operation and reduce noise. Measure the height of the window gap from top to bottom and cut two pieces of adhesive foam to match. Stick the foam on both sides of the gap.

- If your window already has a liner or insulation strip, you can skip the above steps.

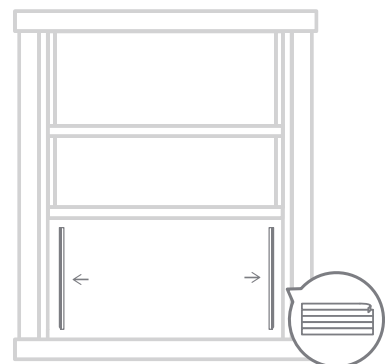

STEP 3: Lift The AC Into The Window

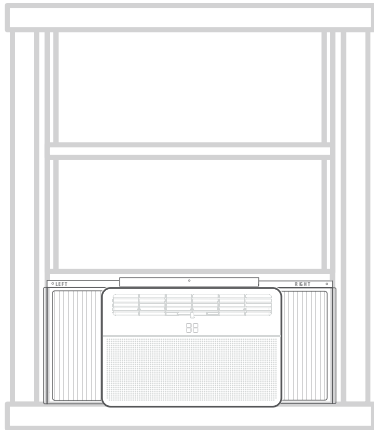

What you need.



Lift the AC into the window:

(1) Together with your helper, lift the assembled AC into the window frame.

Make sure you do this step with a helper. Very carefully, lift the assembled AC into the window frame. Make sure someone is holding the back of the unit securely.

- It's helpful to rest the unit on the inside window sill until you're ready to reposition it correctly. Injury (to you and others) and property damage can occur if installation is not done correctly.

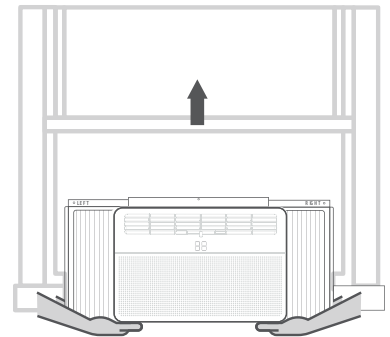

(2) Properly position the bottom bar BEHIND the inside window sill.

Properly position the bottom bar behind the inside window sill. Fit the bottom bar into the bottom horizontal channel of the window frame. The front of the bottom bar should be pressing up against the back edge of the sill.

- Check that air conditioner is tilted back about 3° to 4° downward to the outside. After proper installation, condensate should not drain from the overflow drain hole during normal use. If it does, correct the slope.

Wooden Windows

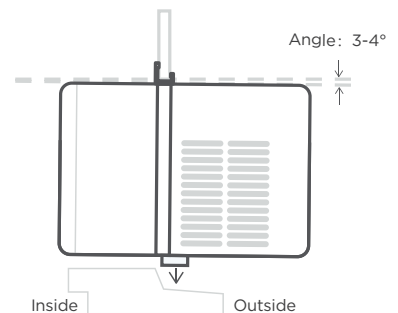

Vinyl-Clad Windows

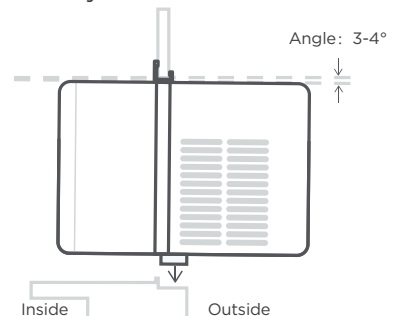

Lift the AC into the window:

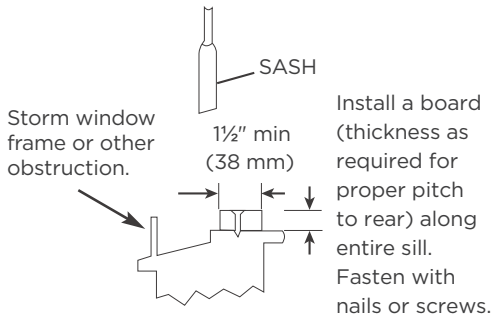

CAUTION

If a storm window or other obstruction blocks the air conditioner, please install according to the figure to the left.

(3) Close the window down onto the AC, and pull the sliding frames to the sides of the window.

Once the AC is centered and the bottom bar is successfully positioned, close the window down onto the AC, behind the top bar. See diagram to the right. Pull the sliding frames until they meet the sides of the window frame.

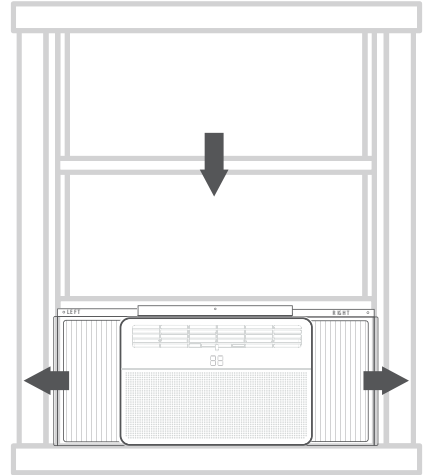

STEP 4: Secure The AC

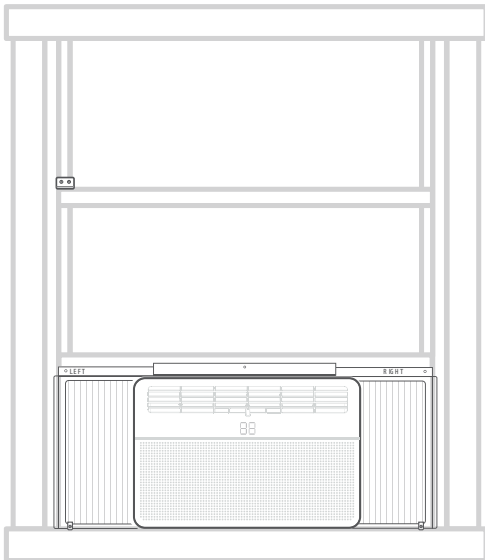

What you need.



Secure the AC:

(1) Drive locking screws.

Follow the above instructions and drive the screws.

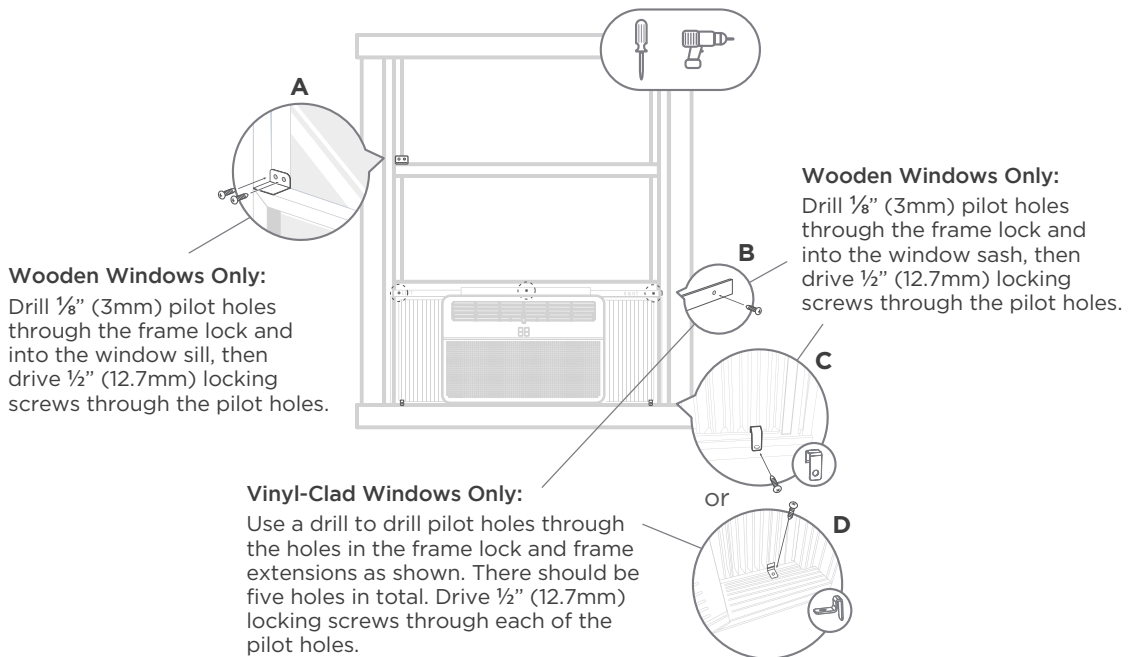

The final details:

(1) Cut the non-adhesive insulation foam to fit the width of your window.

Make sure you are cutting the non-adhesive foam. Measure and cut the foam to be the width of your window from the left to right side.

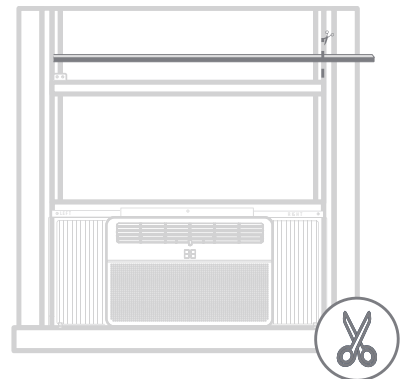

(2) Use the nonadhesive foam to fill the gaps in your window.

Stuff the foam in the gap between the upper and lower sashes of your window.

This will plug any air gaps and help keep out bugs and draft.

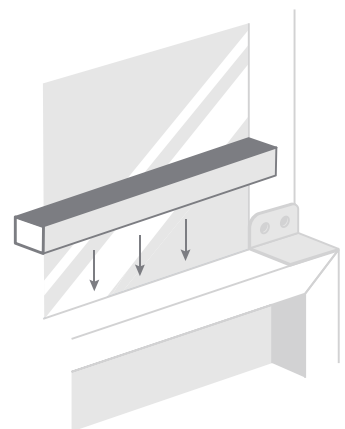

One More Thing - Additional Notes

1. If AC is Blocked by Storm Window:

Add a wooden block to the windowsill as shown in the Caution illustration on page 13, or remove the storm window before air conditioner is installed. If the storm window frame must remain, be sure the drain holes or slots are not caulked or painted shut. Accumulated rainwater or condensation must be allowed to drain out.

Removing AC From Window

Turn AC off, and disconnect power cord. Remove sash seal from between the windows and unscrew safety sash lock. Remove screws installed through frame and frame-lock. Keeping a firm grip on air conditioner, raise sash and carefully remove the air conditioner from the window. Be carefully not to spill any remaining water while lifting unit from window. Store parts with air conditioner.

2. Normal Sounds:

High Pitched Chatter

High-efficiency compressors may have a high pitched chattering sound during the cooling cycle.

Sound of Rushing Air

At the front of the unit, you may hear the sound of rushing air being moved by the fan.

Gurgle/Hiss

Gurgling or hissing noises may be heard due to refrigerant passing through evaporator during normal operation.

Vibration

Unit may vibrate and make noise because of poor wall or window construction or incorrect installation.

Pinging or Swishing

Droplets of water hitting condenser during normal operation may cause pinging or swishing sounds. This noise can be reduced by removing the water plug at the bottom of unit's rear. Removing this plug will lower the energy efficiency of the unit.

NOTE

Don't try to drill any holes on the base pan to eliminate normal sounds. Drilling additional holes will void the warranty.

Noise When Unit is Working

When you use mute mode to start the unit, the sound of the compressor may be more prominent for about 3 minutes. This is normal and due to the heat of the compressor.

A "da-da" sound may occur for thirty seconds when the unit is turned on due to the compressor starting. This is normal.

GET TO KNOW YOUR AC

Air Conditioner Unit Overview

NOTE

The actual functions of your machine may differ to the example shown here.

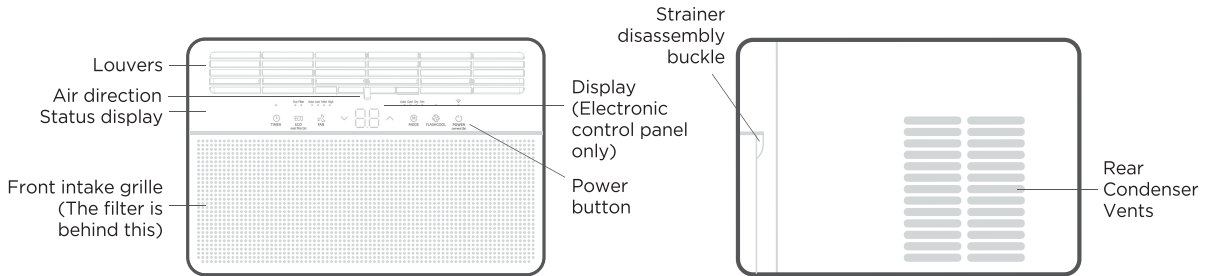

Adjust Your Air Conditioning Direction

Air Conditioning Louvers:

CAUTION

Do not stick your fingers in the air outlet, as that may cause an injury.

Four-Way Adjustment (Up or Down, Left or Right) - For 06K/08K/10K/12K/14K:

The louvers will allow you to direct the air flow Up or Down (on some models) and Left or Right throughout the room as needed. Pivot horizontal louvers until the desired Up/Down direction is obtained. Move the Lever(s) from side to side until the desired Left/Right direction is obtained.

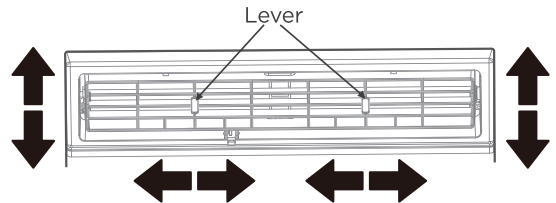

Fresh Air Vent Control - For 12/14K:

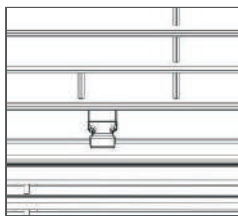

Fig.A (CLOSE)

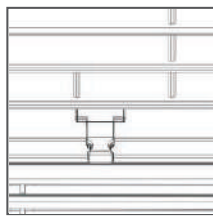

Fig.B (FRESH AIR)

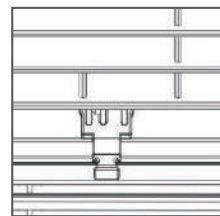

Fig.C (VENT)

The Fresh Air Vent allows the air conditioner to:

1. Recirculate inside air - Close (See Fig.A)
2. Draw fresh air into the room- Fresh air (see Fig.B)
3. Exhaust air from the room - Vent (see Fig.C)

GET TO KNOW THE FEATURES

Air Conditioner Features

⚠ WARNING

- To reduce the risk of fire, electric shock, or injury to persons, read the IMPORTANT SAFETY INSTRUCTIONS before operating this appliance.
- Please always wait 3 minutes when turning unit off then on again, and when changing from Cool to Fan Mode and back to Cool. This prevents compressor from overheating & possibly tripping a circuit breaker.

Electronic Control Operating Instructions

💡 NOTE

- Different models have different control buttons and indicator lights. Not all the control buttons and indicator lights describing below are available for the unit you purchased. Please check the control panel of the unit you purchased. The unit can be controlled by the unit control alone or with the remote controller.
- The function of the operation panel is based on a typical model. The functions should be the same on your air conditioner despite some variation in appearance.

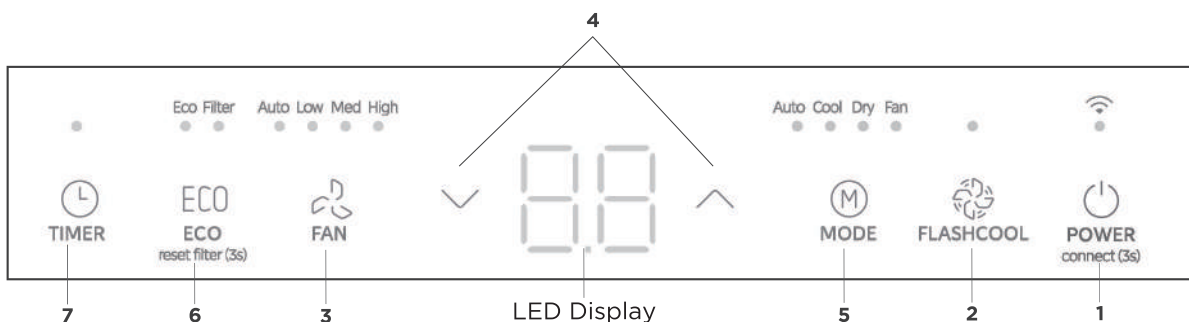

		Description
1	connect (3s)	<ul style="list-style-type: none"> • Press to turn unit on or off. • Press for 3 sec to initiate the wireless connection mode.
2	FLASHCOOL	<ul style="list-style-type: none"> • Press to activate FlashCool function.
3	FAN	<ul style="list-style-type: none"> • Press to select the Fan Speed, with four settings - Auto, Low, Med or High.
4		<ul style="list-style-type: none"> • Press to change temperature setting.
5	MODE	<ul style="list-style-type: none"> • Press to choose operating mode in a sequence that goes from Auto, Cool, Dry to Fan.
6	ECO ECO reset filter (3s)	<ul style="list-style-type: none"> • Press to initiate this feature, which will maintain comfort and save energy. • Press for 3 sec to turn off the cleaning filter reminder.
7	TIMER	<ul style="list-style-type: none"> • Press to turn unit on or off after a set time.

1. TO TURN UNIT ON OR OFF:

Press the ON/OFF button to turn unit on or off.

Wireless Button

Press and hold on the POWER button for 3 seconds to initiate the Wireless Connection Mode.

2. FLASHCOOL FUNCTION:

Press this button to initiate the FlashCool function. FlashCool provides maximum cooling and sets the fan to the highest speed. The unit will operate in this mode until the mode is changed, the fan speed is adjusted, or the function is turned off. The unit will then return to normal cooling operation with the fan speed set to high.

NOTE

If you use a remote to start the FlashCool function, you will need to use the remote to return the unit to a normal cooling mode.

3. TO ADJUST FAN SPEEDS:

Press the Fan button to select the Fan Speed with four settings. Press the button to cycle through the fan speeds in the following order:

Auto -> Low -> Medium -> High -> Auto

Some models cannot adjust the fan speed.

4. TO CHANGE TEMPERATURE SETTING:

Press the UP/DOWN button to change the temperature setting.

Press or hold either the UP or DOWN button until your desired temperature is shown on the display, with a range of 60°F (16°C) and 86°F (30°C).

If you want the display to show the actual room temperature instead, please refer to the **To Operate on Fan Only** section.

5. TO SELECT THE OPERATING MODE:

Press the Mode button to cycle through the different operating modes:

Auto -> Cool -> Dry -> Fan -> Auto

The indicator light beside the selected mode will illuminate and remain on when the mode is selected. The unit will automatically initiate the Energy Saver function under the Cool, Dry, and some Auto (Auto-Cooling and Auto-Fan only) modes.

Auto Mode:

- When you set the air conditioner in AUTO mode, it will automatically select Cool mode or Fan Only mode depending on the temperature you have selected and the room temperature.
- The air conditioner will control room temperature automatically to match your selected temperature.
- In this mode, the fan speed cannot be adjusted. The fan speed is determined automatically based on the room temperature.

Cool Mode:

Choose Cool Mode to set the cooling function. Use the Up and Down buttons to choose the desired temperature. When Cool Mode is selected, the fan speed can be adjusted by pressing the fan button.

Dry Mode:

In this mode, the air conditioner will generally operate as a dehumidifier. Since the conditioned space is a closed or sealed area, some degree of cooling will occur. In Dry mode, the fan speed will be set automatically.

Fan Only Mode:

- Use this function only when cooling is not desired. Fan Only can be used for room air circulation or to exhaust stale air (on some models). You can choose any fan speed using the fan button.
Remember to open the vent when using Fan Only and close it when cooling.
- During this function, the display will show the actual room temperature, not the set temperature (which is shown in Cool mode).
- In Fan Only mode, the temperature will not be adjusted.

6. ENERGY SAVER FEATURE (ECO):

Press ECO button to initiate this function. This function is available in Cool, Dry, and Auto (only Auto-Cooling and Auto-Fan) modes. Once the room reaches your selected temperature, the air conditioner will cycle the fan and cooling on and off to maintain your set temperature. The fan will continue to run for 3 minutes after the compressor shuts off. The fan then cycles on for 2 minutes at 10 minute intervals until the room temperature is above the set temperature, at which time the compressor turns back on and cooling starts.

Reset Filter

- Press and hold the ECO button for 3 seconds to activate the filter reset reminder.
- This feature is a reminder to clean the Air Filter for more efficient operation. The LED (light) will illuminate after 250 hours of operation. To reset after cleaning the filter, press the ECO button and the light will turn off.

7. TIMER: AUTO START/STOP FEATURE:

- Press Timer button. The TIMER ON or TIMER OFF indicator light will illuminate, which indicates that the Auto Start or Auto Stop feature is active. For some units, keep pressing the Timer button to cancel the timer settings.
- Press or hold the UP or DOWN button to change the Auto time by 0.5 hour increments, up to 10 hours, then at 1 hour increments from 10-24 hours. The unit will count down the time remaining until start.
- The selected time will register for 5 seconds, then the system will automatically revert back to display the previous temperature setting or room temperature when the unit is on. When the unit is off, there will be no display.
- Turning the unit ON or OFF at any time or adjusting the timer setting to 0.0 will cancel the Auto Start/Stop timed program.

Displays

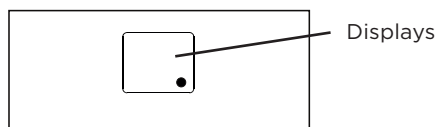

Shows the set temperature in “°C” or “°F” and the Auto-timer settings. While in Fan Only mode, it shows the room temperature. If the room temperature is too high or low, it will display “HI” or “LO”.

REMOTE CONTROL INSTRUCTIONS

Remote Controller Specifications

Model	RG10G5(B2)/BGCEFU1
Rated Voltage	3.0V (Dry batteries R03/LR03x2)
Signal Receiving Range	Maximum 8m (vertical distance)
Environment	-5 °C ~ 60 °C (23°F ~ 140°F)

Quick Start Guide

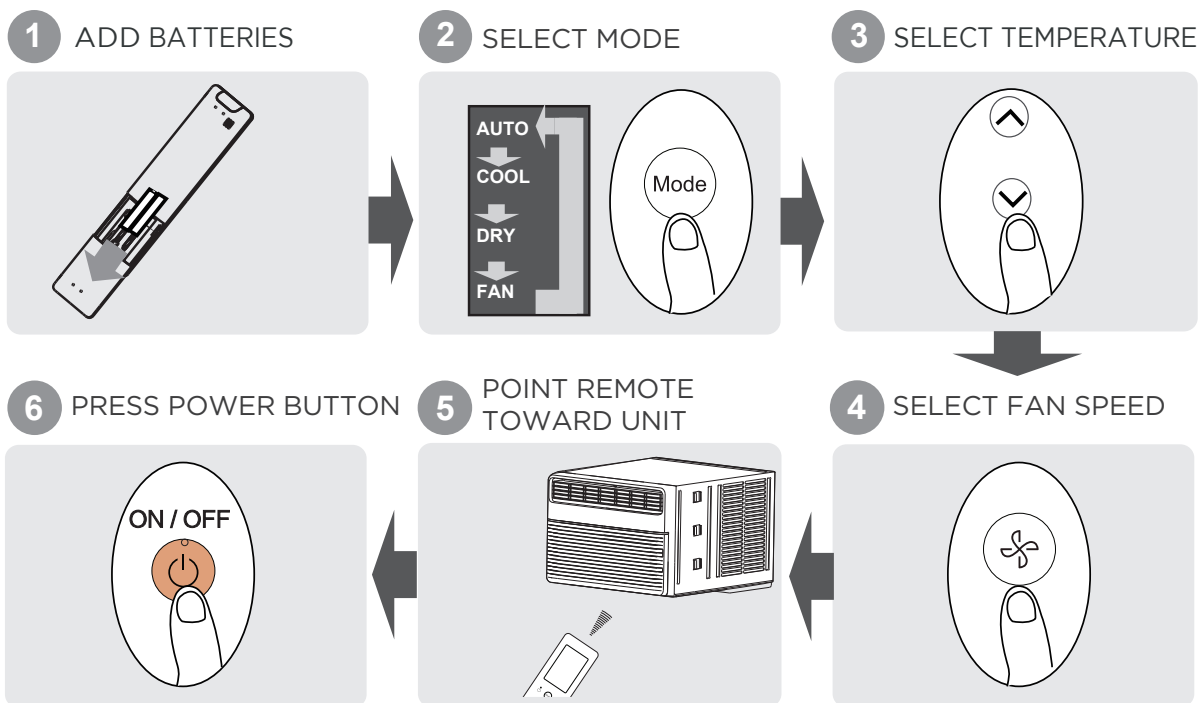

Not Sure What A Function Does?

Refer to the **How to Use Basic Functions** and **How to Use Advanced Functions** sections of this manual for a detailed description of how to use your air conditioner.

SPECIAL NOTE

- Button design on your unit may differ slightly from the example shown.
- If the indoor unit does not have a particular function, pressing that function's button on the remote control will have no effect.
- When there are wide differences in function description between the Remote Control Manual and the User's Manual, the description in the User's Manual shall prevail.

Handling The Remote Controller

INSERTING AND REPLACING BATTERIES

Your air conditioning unit may come with two batteries (some units only). Put the batteries in the remote control before use.

1. Slide the back cover downward, exposing the battery compartment.
2. Insert the batteries, carefully matching the (+) and (-) ends of the batteries with the symbols inside the battery compartment.
3. Slide the battery cover back into place.

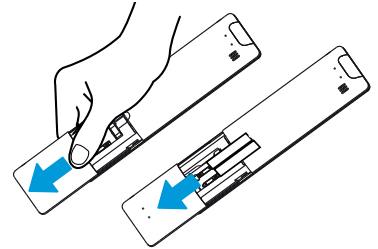

BATTERY NOTE

For optimum product performance:

- Do not mix old and new batteries, or batteries of different types.
- Do not leave batteries in the remote control if you don't plan on using the device for more than 2 months.

BATTERY DISPOSAL

Do not dispose of batteries as unsorted municipal waste. Refer to local laws for proper disposal of batteries.

TIPS FOR USING REMOTE CONTROL

- The remote control must be used within 8 meters of the unit.
- The unit will beep when remote signal is received.
- Curtains, other objects, and direct sunlight can interfere with the infrared signal receiver.
- Remove batteries if the remote will not be used for more than 2 months.

NOTES FOR USING REMOTE CONTROL

The device could comply with local and national regulations.

- In Canada, it should comply with CAN ICES-3(B)/NMB-3(B).
- In USA, this device complies with part 15 of the FCC Rules. Operation is subject to the following two conditions:
 - (1) This device may not cause harmful interference, and
 - (2) This device must accept any interference received, including interference that may cause undesired operation.

This equipment has been tested and found to comply with the limits for a Class B digital device, pursuant to part 15 of the FCC Rules. These limits are designed to provide reasonable protection against harmful interference in a residential installation. This equipment generates, uses and can radiate radio frequency energy and, if not installed and used in accordance with the instructions, may cause harmful interference to radio communications. However, there is no guarantee that interference will not occur in a particular installation. If this equipment does cause harmful interference to radio or television reception, which can be determined by turning the equipment off and on, the user is encouraged to try to correct the interference by one or more of the following measures:

- Reorient or relocate the receiving antenna.
- Increase the separation between the equipment and receiver.
- Connect the equipment into an outlet on a circuit different from that to which the receiver is connected.
- Consult the dealer or an experienced radio/TV technician for help.
- Changes or modifications not approved by the party responsible for compliance could void user's authority to operate the equipment.

Buttons and Function

Before you begin using your new air conditioner, make sure to familiarize yourself with its remote control. The following is a brief introduction to the remote control itself. For instructions on how to operate your air conditioner, refer to the How to Use Basic Functions section of this manual.

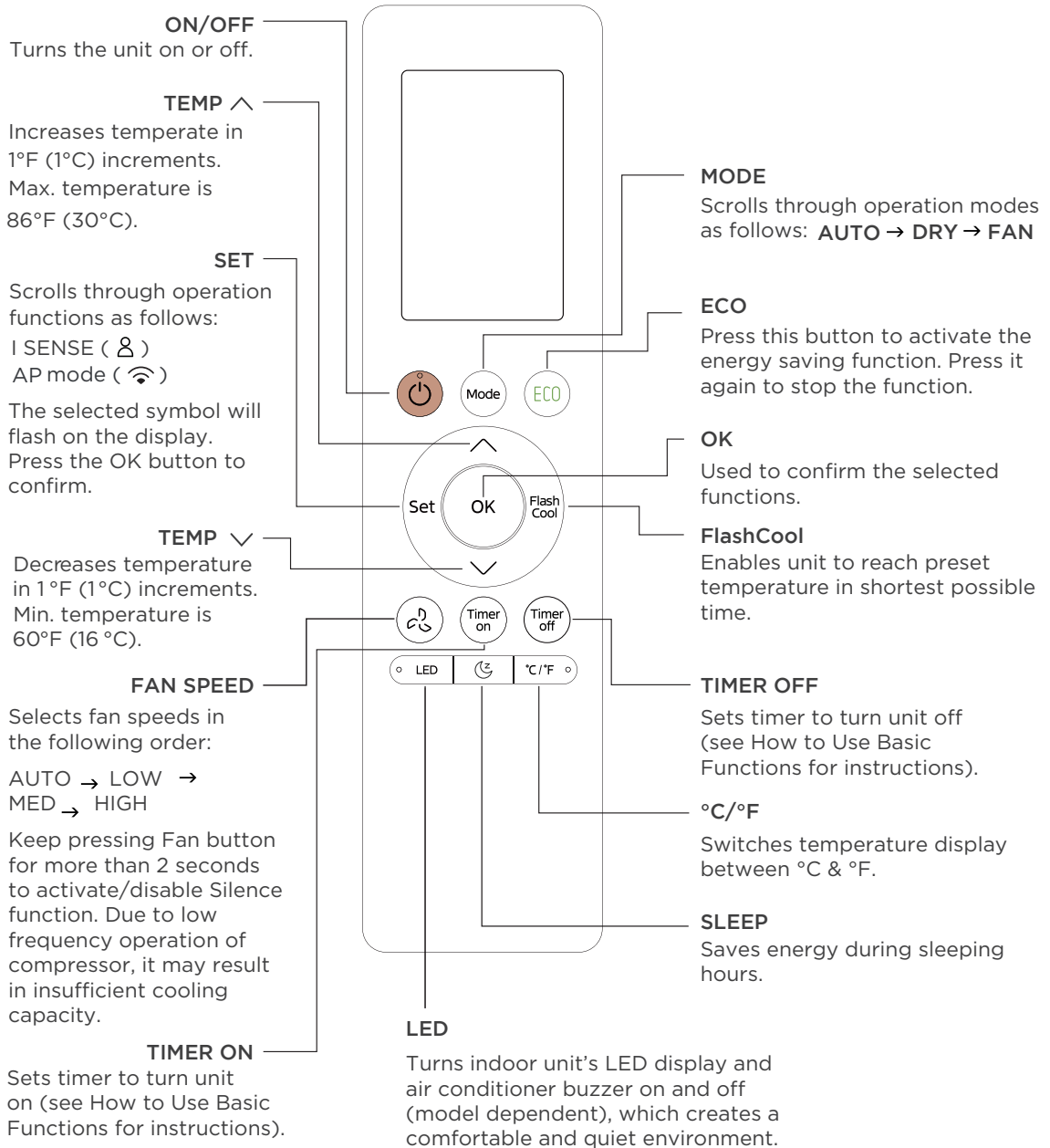

Buttons and Function

Information displayed when remote controller is powered on

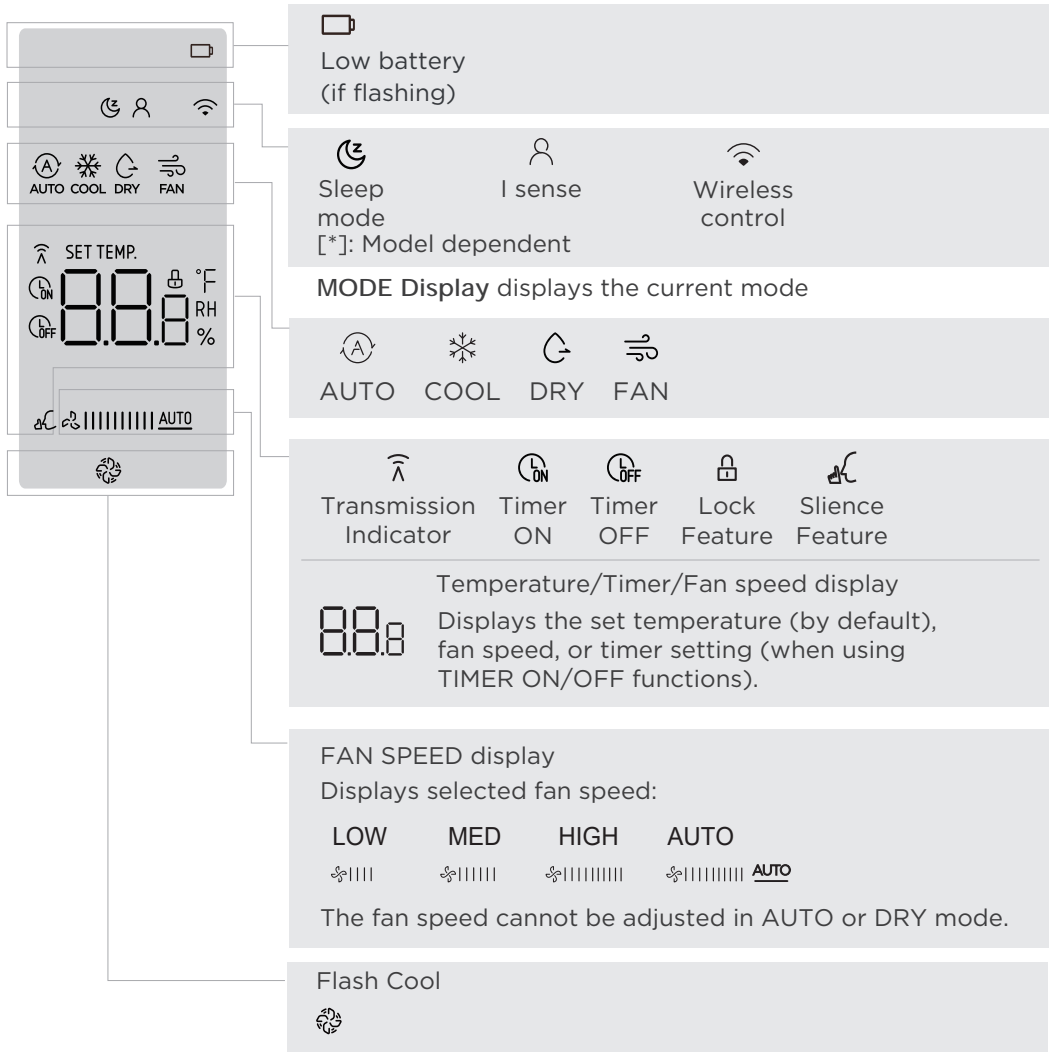

NOTE

All indicators shown above are for information purposes. During the actual operation, only the relevant indicators will be shown on the display.

How to Use Basic Functions



ATTENTION

Before operation, please ensure the unit is plugged in and power is available.

AUTO Mode

Select AUTO mode



Set your desired temperature



Turn on the air conditioner



NOTE

1. In AUTO mode, the unit will automatically select the COOL or FAN, function based on the set temperature.
2. In AUTO mode, fan speed cannot be set.

COOL Mode

Select COOL mode

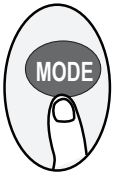

Set the temperature



Set the fan speed



Turn on the air conditioner



DRY Mode

Select DRY mode



Set your desired temperature



Turn on the air conditioner



NOTE

In DRY mode, fan speed cannot be set since it has already been automatically controlled.

FAN Mode

Select FAN mode

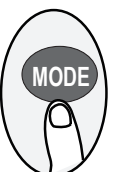

Set the fan speed



Turn on the air conditioner



NOTE

In FAN mode, you can't set the temperature. As a result, no temperature displays on the remote screen.

Setting the TIMER

TIMER ON/OFF

Set the amount of time after which the unit will automatically turn on/off.

TIMER ON Setting

Press TIMER ON button to initiate the ON time sequence.

Press Temp. up or down button multiple times to set the desired time until turning on the unit.

Point remote to unit and wait 1 sec. TIMER ON will be activated.

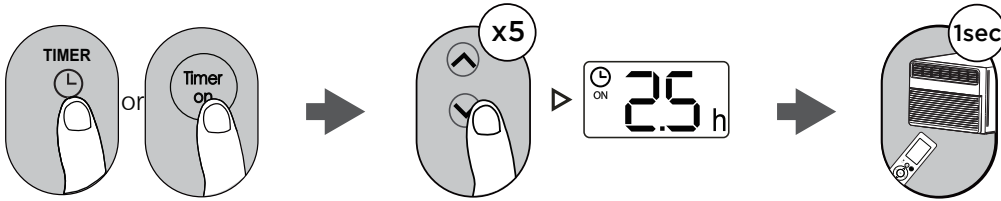

TIMER OFF Setting

Press TIMER OFF button to initiate the OFF time sequence.

Press Temp. up or down button multiple times to set the desired time until turning off the unit.

Point remote to unit and wait 1 sec. TIMER OFF will be activated.

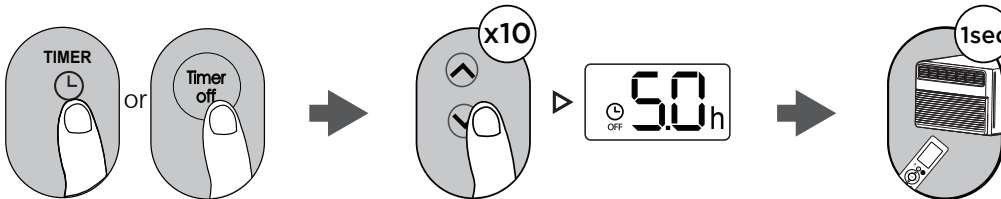

NOTE

- When setting TIMER ON or TIMER OFF, the time will increase by 30 minutes increments with each press, up to 10 hours. From 10 to 24 hours it will increase in 1 hour increments. (For example, press 5 times to get 2.5h, and press 10 times to get 5h,). The timer will revert to 0.0 if pressed after reaching 24 hours.
- Cancel either function by setting the timer to 0.0h.

TIMER ON & OFF Setting (example)

Keep in mind that the time periods you set for both functions refer to hours after the current time.

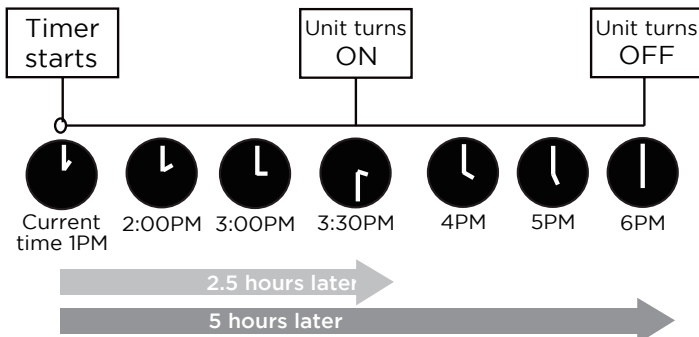
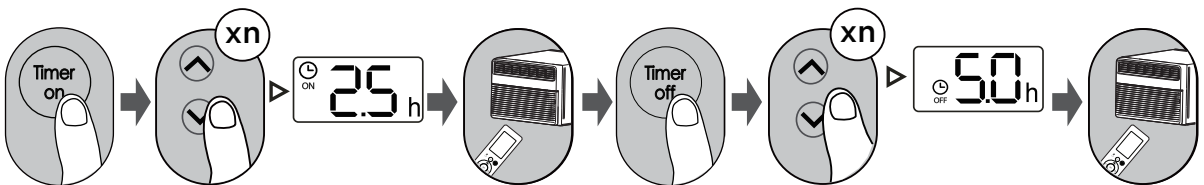

Example: If the current time is 1:00 PM and the timer is set as show above, the unit will turn on 2.5h later (3:30PM) and turn off at 6:00PM.

How to Use Advanced Functions

SWING Function

Press Swing button.

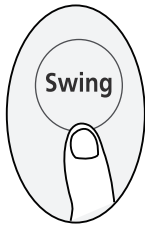

The horizontal louver will swing up and down automatically after pressing the Swing button. Press again to make it stop.

ECO Function



Press the ECO button to turn on this function. This function is available on COOL, DRY, and AUTO modes.

°C/°F

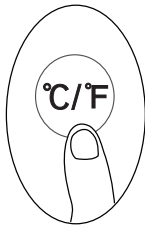

Press this button to alternate the temperature display between the °C & °F.

LED DISPLAY

Press LED button.

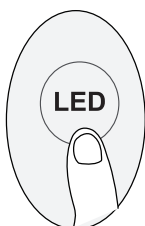

Press this button to turn on and turn off the display on the indoor unit.

LOCK Function

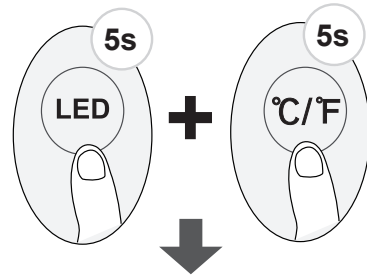

Press the LED button and °C/°F button at the same time for more than 5 seconds to activate the Lock function.

Once Lock is activated, buttons will not respond until you press these two buttons for two seconds again to disable locking.

SLEEP Function

Press SLEEP button.



The SLEEP function is used to decrease energy while you sleep (and don't need the same temperature settings to stay comfortable).

The User Manual doesn't say anything about the sleep function.

NOTE

The SLEEP function is not available in FAN or DRY mode.

SET Function

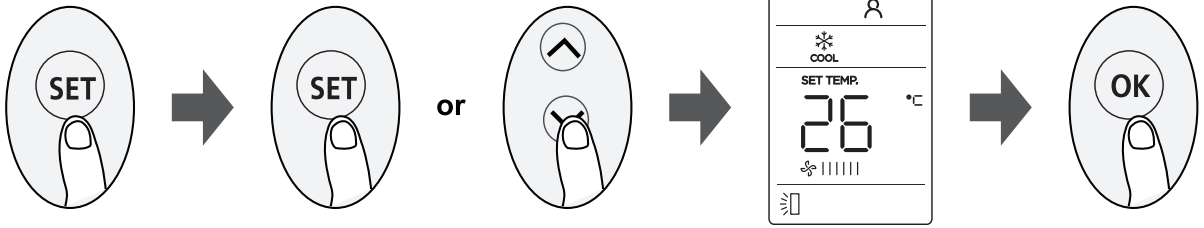

- Press the SET button to enter the function setting, then press the SET button or TEMP ^ or TEMP v button to select the desired function. The selected symbol will flash on the display area. Press the OK button to confirm.
- To cancel the selected function, just perform the same procedures as above and select your original function.
- Press the SET button to scroll through operation function as follow:
I SENSE (⊗) → AP mode (📶)*
[*]: Model-dependent.

I SENSE Function (⊗):

The I SENSE function enables the remote control to measure the temperature at its current location and send this signal to the air conditioner every 3 minutes. When using AUTO and COOL modes, measuring ambient temperature from the remote control (instead of from the indoor unit itself) will enable the air conditioner to optimize the temperature around you and ensure maximum comfort.

AP Function (📶):

Choose AP mode to configure the wireless network. For some units, AP mode cannot be selected with the SET button. Instead, press the LED button seven times in 10 seconds to enter AP mode.

CONNECTION INSTRUCTIONS

1. How to Use Matter ✨

Connect Your Air Conditioner Through Matter



Make sure your mobile device is connected to your wireless router.

The wireless router should support and turn on IPv6. Please make sure your smartphone is connected to the 2.4G, not the 5G network.

For the best Matter compatibility, connect the AC to the Alexa, Google Home or Apple Home ecosystems, along with at least one of their respective Matter-enabled smart speakers.

STEP 1: Connect to Smart Speakers

Select your preferred ecosystems (Alexa, Google Home or Apple Home) and make sure you've got one of their Matter-enabled products (such as their smart speakers) connected to your wireless router.

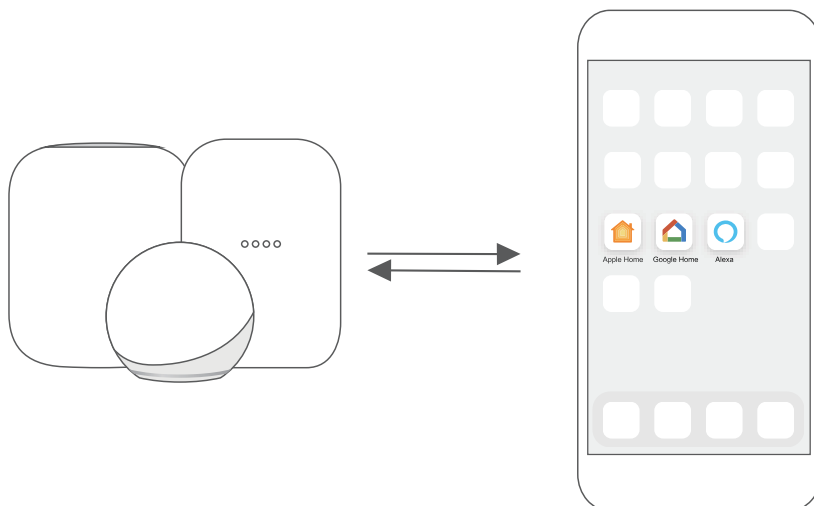

STEP 2: Turn On Bluetooth

Turn on Bluetooth on your mobile device.

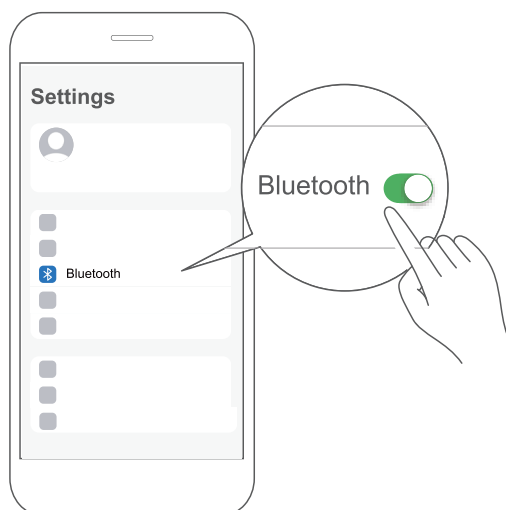

STEP 3: Enter AP Mode

Hold down the CONNECT button for 3 seconds to begin the pairing process (“AP” will appear on the AC’s display).

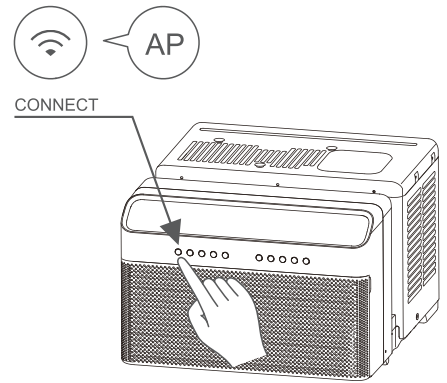

STEP 4: Open App

Open the Alexa, Google Home or Apple Home app on your mobile device.

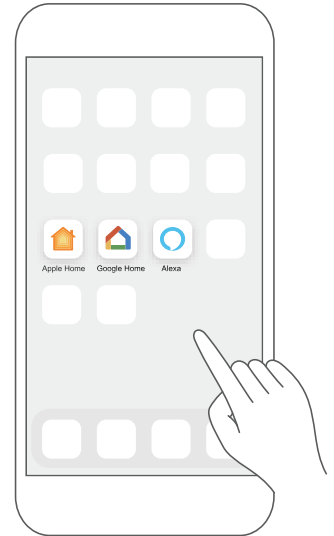

STEP 5: Scan Matter QR code

Tap the “+” and “Add Device/Accessory” or tap “+Add” in your app, select Matter device and scan the Matter QR code found on the side of the AC device.

Follow the respective instructions in the Alexa, Google Home or Apple Home app to complete the pairing process.

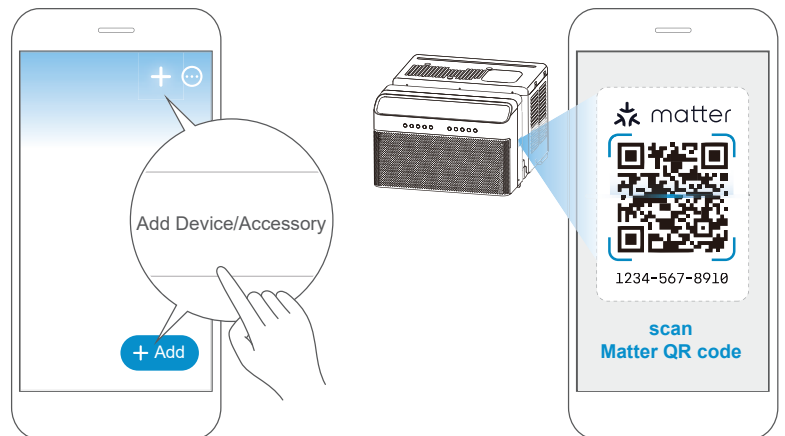

STEP 6: Control Device

After pairing is successful, you can control your AC's temperature and mode settings, etc. through the respective ecosystem app and/or smart speaker.

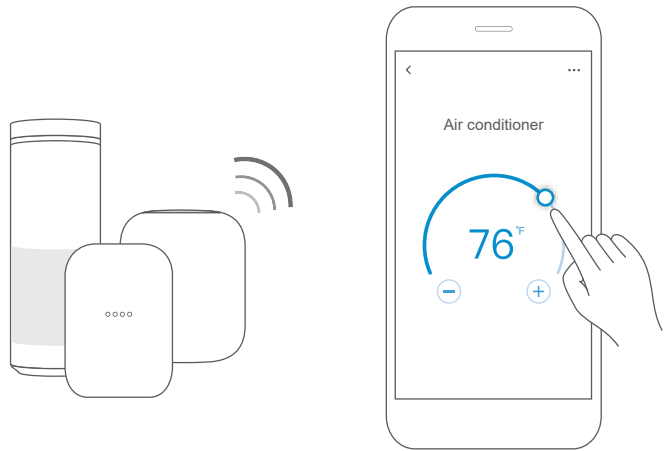

App & Smart Speakers can support Matter only when using these versions or above.

Device	Version
iPhone	iOS 16.5
Apple Home Pod	16.5
Android	Google Play services min version: 22.36.15 Google Home app (GHA) min version: 2.58.24.1 - dogfood
Google Home Hub	Google Hub firmware min version: 1.56.324896 (appears on hub as Chromecast firmware version)
Alexa App	2.2.536317
Alexa Echo Device	9094439556

NOTE

- Setup processes and features may vary between ecosystems.
- Make sure the Matter-enabled app is up to date to ensure the best experience.
- Periodically, we will update the device's software to improve the experience. Device software updates can be accomplished through the SmartHome app.

2. How to Use SmartHome

 Ensure that your mobile phone is connected to the wireless network. Bluetooth must be turned on. The device must also be powered on.

STEP 1: Download the SmartHome App

Scan the QR code below to download the SmartHome app from the app store or search for it directly on the Google Play Store or Apple's App Store.

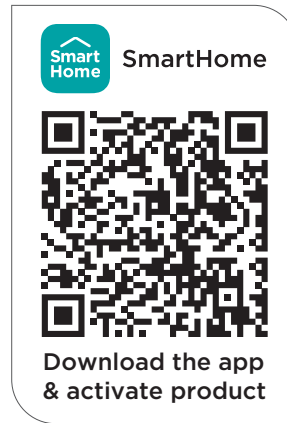

STEP 2: Log in

Open the SmartHome app. Log in directly if you have an existing SmartHome account or create a new account. Alternatively, you can also use a 3rd party login platform.

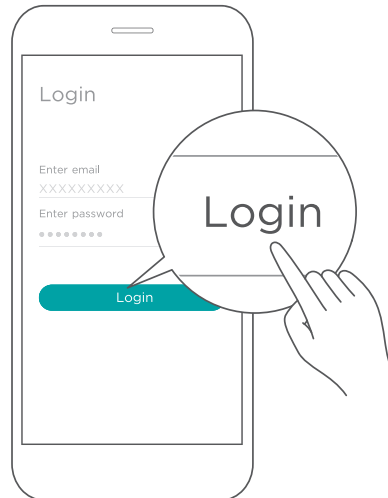

STEP 3: Connecting the Device

- 1) When you log in, you may see the message "Smart devices discovered nearby". Tap to add your device.

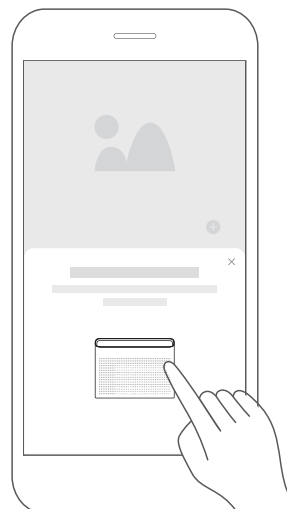

- 2) If no such message appears, proceed as follows: Tap on “+” and select your device in the list of nearby available devices.

If your device is not listed, please add your device manually. Select the device category (e.g. Window AC) and find your device model in the list.



- 3) Follow the steps in the app to connect your device to the wireless network. If your device fails to connect, follow the additional instructions in the app.

For Window AC

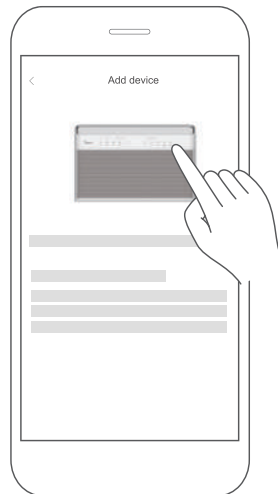

For Portable AC



STEP 4: Controlling the Device

After pairing successfully, a card will be created for the device in the SmartHome app.

Shortcuts for basic functions will appear on the card, such as changing the temperature or switching the device on or off.

Tapping on the card will reveal additional features and settings. The actual UI design may look different from examples due to app updates.

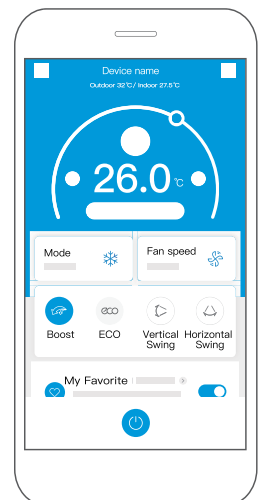
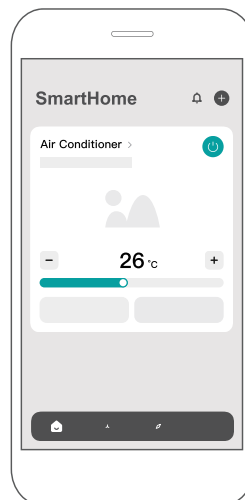

Declaration of Conformity

FCC ID: 2ADQOMDNA23

IC: 12575A-MDNA23

This device complies with Part 15 of the FCC Rules and Industry Canada's licence exempt RSSs.

Operation is subject to the following two conditions:

- (1) This device may not cause interference;
- (2) This device must accept any interference, including interference that may cause undesired operation of the device.

Only operate the device in accordance with the instructions supplied.

Changes or modifications to this unit not expressly approved by the party responsible for compliance could void the user's authority to operate the equipment.

This device complies with FCC radiation exposure limits set forth for an uncontrolled environment. In order to avoid the possibility of exceeding the FCC radio frequency exposure limits, human proximity to the antenna shall not be less than 20cm (8 inches) during normal operation.

NOTE

This equipment has been tested and found to comply with the limits for a Class B digital device, pursuant to part 15 of the FCC Rules. These limits are designed to provide reasonable protection against harmful interference in a residential installation.

This equipment generates, uses and can radiate radio frequency energy and, if not installed and used in accordance with the instructions, may cause harmful interference to radio communications. However, there is no guarantee that interference will not occur in a particular installation. If this equipment does cause harmful interference to radio or television reception, which can be determined by turning the equipment off and on, the user is encouraged to try to correct the interference by one or more of the following measures:

- Reorient or relocate the receiving antenna.
- Increase the separation between the equipment and receiver.
- Connect the equipment into an outlet on a circuit different from that to which the receiver is connected.
- Consult the dealer or an experienced radio/TV technician for help.

Specifications

This device is in compliance with the essential requirements and other relevant provisions of Directive 2014/53/EU. In order to avoid the possibility of exceeding the radio frequency exposure limits, human proximity to the antenna shall not be less than 20cm during normal operation. (European Union products only)

Unit model: MAW10RVICWT, MAW12RVICWT, MAW14RVICWT	Operation Temperature: 0°C ~ 45°C / 32°F ~ 113°F
Wireless Module Model: US-SK109	Operation Humidity: 10% ~ 85%
Antenna Type: Printed PCB Antenna	Power Input: DC 5V/500 mA
Wireless: 2400 - 2483.5MHz, TX Power: < 20dBm	BLE: 2402 - 2480MHz, TX Power: < 10dBm

CLEANING AND MAINTENANCE

How To Clean & Change Your Filter

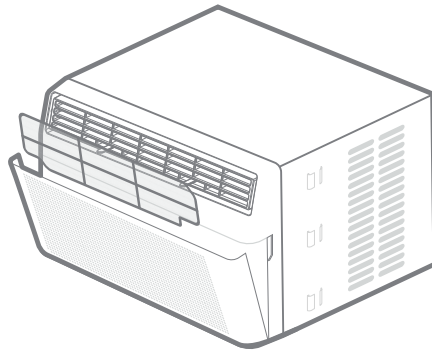

Check the air filter once a month to see if cleaning is necessary

The air filter should be checked at least once a month to see if cleaning is necessary. Trapped particles in the filter can build up and cause an accumulation of frost on the cooling coils.

- Push the vent handle to the Vent Closed position (where applicable). Open the front panel.
- Take the filter by the center and pull it up and out.
- Wash the filter using liquid dishwashing detergent and warm water. Rinse filter thoroughly. Gently shake excess water from the filter. Be sure the filter is thoroughly dry before replacing. Instead of washing, you may vacuum the filter clean.

NOTE

Never use hot water over 104°F (40°C) to clean the air filter. Never attempt to operate the unit without the air filter.

Cabinet Cleaning

- Be sure to unplug the air conditioner to prevent shock or fire hazard. The cabinet and front may be dusted with an oil-free cloth or washed with a cloth dampened in a solution of warm water and mild liquid dishwashing detergent. Rinse thoroughly and wipe dry.
- Never use harsh cleansers, wax or polish on the cabinet front.
- Be sure to wring excess water from the cloth before wiping around the controls. Excess water in or around the controls may cause damage to the air conditioner.
- Plug in air conditioner when finished cleaning.

WARNING

Clean your air conditioner occasionally to keep it looking new. **Be sure to unplug the unit before cleaning to prevent shock or fire hazards.**

CAUTION

If you plan to store the air conditioner during the winter, remove it carefully from the window according to the installation instructions. Cover it with plastic or return it to the original carton.

TROUBLESHOOTING TIPS

Before calling for service, save some time and money by reviewing this list. This list includes common occurrences that are not the result of defective workman-ship or materials in this appliance.

Problem	Solution
Air conditioner does not start.	Wall plug disconnected. Push plug firmly into wall outlet.
	House fuse blown or circuit breaker tripped. Replace fuse with a time-delay fuse or reset circuit breaker.
	Plug current device tripped. Press the RESET button.
	Power is OFF. Turn power ON.
Air from unit does not feel cold enough.	Room temperature below 60°F (16°C). Cooling may not occur until room temperature rises above 60°F (16°C).
	The temperature sensor behind the air filter is touching the cold coil. Return the temperature sensor to its original location on the front grille.
	The set temperature is too high. Set a lower temperature.
	Compressor stopped when changing modes. Wait for 3 minutes after selecting Cool mode for compressor to start.
Air conditioner cooling, but room is too warm - ice forming on cooling coil behind decorative front.	Outdoor temperature below 64°F (18°C). To defrost the coil, set to FAN ONLY mode.
	Air filter may be dirty. Clean filter. Refer to Cleaning and Maintenance section. To defrost, set to FAN ONLY mode.
	Thermostat set too cold for night-time cooling. To defrost the coil, set to FAN ONLY mode, then, set temperature to a higher setting.
Air conditioner cooling, but room is too warm - NO ice forming on cooling coil behind decorative front.	Dirty air filter - air restricted. Clean filter. Refer to Cleaning and Maintenance section.
	Temperature is set too high. Set temperature to a lower setting.
	Air directional louvers positioned improperly. Position louvers for better air distribution.
	Front of unit is blocked by drapes, blinds, furniture, etc, which restricts air distribution. Clear blockage in front of unit.
	Open doors or windows may be allowing cold air to escape. Close any doors or windows.
	The room may be too warm. Allow additional time to remove "stored heat" from walls, ceiling, floor and furniture.

Problem	Solution
Air conditioner turns on and off rapidly.	Dirty air filter - air restricted. Clean air filter.
	Outside temperature extremely hot. Set FAN speed to a higher setting to bring air past cooling coils more frequently.
Noise when unit is cooling.	Air movement sound. This is normal. If too loud, set to a slower FAN setting.
	Window vibration - poor installation. Refer to installation instructions or check with installer.
	For more effective cooling, the wind wheel outside the window may make splashing sounds. Remove the rear side drain plug to stop the sound. The standard installation angle should be 3-5 degrees.
Noise when unit is working.	When you use mute mode to start the unit, due to the compressor being hot, the sound of the compressor may be more prominent. This will last for about 3 minutes. It is normal. A “da-da” sound may occur for thirty seconds when the unit is turned on due to the compressor starting. This is normal.
Water dripping INSIDE when unit is cooling.	Improper installation. Tilt air conditioner slightly to the outside to allow water drainage. Refer to Installation Instructions or check with installer.
Water dripping OUTSIDE when unit is cooling.	Unit removing large quantity of moisture from humid room. This is normal during excessively humid days.
Remote sensing deactivating prematurely (only remote models).	Remote control not located within range. Place remote control within 20 feet and pointed in the general direction of the air conditioner unit.
	Remote control signal obstructed. Remove obstruction.
Room too cold.	Set temperature too low. Increase set temperature.

The design and specifications are subject to change without prior notice for product improvement. Any updates to the manual will be uploaded to the Midea website (www.midea.com/us). Please check for the current version.

**Supplier's Declaration of Conformity
Per FCC Part 2 Section 2.1077**

Unique Identifier: Midea brand, RG10G5(B2)/BGCEFU1

Responsible Party – U.S. Contact Information

Midea America Corporation
300 Kimball Dr
Parsippany NJ
07054

Telephone number or internet contact information: Midea.com/us

FCC Compliance Statement

This device complies with Part 15 of the FCC Rules. Operation is subject to the following two conditions: (1) This device may not cause harmful interference, and (2) this device must accept any interference received, including interference that may cause undesired operation.

WARRANTY

Air Conditioner Limited Warranty

Your product is protected by this Limited Warranty:

Warranty service must be obtained from Midea Consumer Services or an authorized Midea servicer.

Warranty

- Three Year Full warranty from the date of delivery or the purchase date, whichever is later.
- The date of delivery establishes the warranty period, should service be required.

Midea, through its authorized servicers will:

- Pay all costs for repairing or replacing parts of this appliance which prove to be defective in materials or workmanship.

Consumer will be responsible for:

- Diagnostics, removal, transportation and reinstallation cost required because of service.
- Costs of service calls that are a result of items listed under NORMAL RESPONSABILITIES OF THE CONSUMER**

Midea replacement parts shall be used and will be warranted only for the original warranty.

NORMAL RESPONSABILITIES OF THE CONSUMER**

This warranty applies only to products in ordinary household use, and the consumer is responsible for the items listed below:

1. Proper use of the appliance in accordance with instructions provided with the product.
2. Routine maintenance and cleaning necessary to keep the good working condition.
3. Proper installation by an authorized service professional in accordance with instructions provided with the appliance and in accordance with all local plumbing, electrical and/or gas codes.
4. Proper connection to a grounded power supply of sufficient voltage, replacement of blown fuses, repair of loosen connections or defects in house wiring.
5. Expenses for making the appliance accessible for servicing.
6. Damages to finish after installation.

EXCLUSIONS

This warranty does not cover the following:

- 1) Failure caused by damage to the unit while in your possession (other than damage caused by defect or malfunction), by its improper installation, or by unreasonable use of the unit, including without limitation, failure to provide reasonable and necessary maintenance or to follow the written installation and Operating Instructions.
- 2) Damages caused by services performed by persons other than those authorized by Midea customer service; or external causes such as abuse, misuse, inadequate power supply or acts of God.
- 3) If the unit is put to commercial, business, rental, or other use or application other than for consumer use, we make no warranties, express or implied, including but not limited to, any implied warranty of merchantability or fitness for use or purpose.
- 4) Products without original serial numbers or products that have serial numbers which have been altered or cannot be readily determined.

NOTICE: Some states do not allow the exclusions or limitation of incidental or consequential damages. So this limitation or exclusion may not apply to you.

IF YOU NEED SERVICE

Keep your bill of sale, delivery slip, or some other appropriate payment Record.

The date on the bill establishes the warranty period, should service be required.

If service is performed, it's your best interest to obtain and keep all receipts.

This written warranty gives you specific legal rights. You may also have other rights that vary from state to state.

Service under this warranty must be obtained by following these steps, in order:

- 1) Contact Midea Consumer Services or an authorized Midea services at 1 866 646 4332.
- 2) If there is a question as to where to obtain service, contact our consumer relations Department.



make yourself at home



www.midea.com

© Midea 2025 all rights reserved

CWS003IU-TYBPN8(WA)
16122000A82462
20250811