

## Window Air Conditioner MAW

# USER MANUAL

**MAW05R1JWT-B/MAW06R1JWT-B/  
MAW08S1JWT-B/MAW12S1JWT-B**

Warning notices: Before using this product, please read this manual carefully and keep it for future reference. The design and specifications are subject to change without prior notice for product improvement. Consult with your dealer or manufacturer for details. The diagram above is just for reference. Please take the appearance of the actual product as the standard.

## **THANK YOU LETTER**

Thank you for choosing Midea! Before using your new Midea product, please read this manual thoroughly to ensure that you know how to operate the features and functions that your new air conditioner offers in a safe way.

# CONTENTS





<b>THANK YOU LETTER .....</b>	<b>2</b>
<b>SAFETY INSTRUCTIONS .....</b>	<b>3</b>
<b>PRODUCT INSTALLATION .....</b>	<b>7</b>
<b>OPERATION INSTRUCTIONS .....</b>	<b>14</b>
<b>REMOTE CONTROL AND APP INSTRUCTIONS .....</b>	<b>19</b>
<b>CLEANING AND MAINTENANCE .....</b>	<b>33</b>
<b>TROUBLESHOOTING TIPS .....</b>	<b>34</b>
<b>WARRANTY .....</b>	<b>36</b>

# SAFETY INSTRUCTIONS

## Intended Use

The following safety guidelines are intended to prevent unforeseen risks or damage from unsafe or incorrect operation of the appliance. Please check the packaging and appliance on arrival to make sure everything is intact to ensure safe operation. If you find any damage, please contact the retailer or dealer. Please note modifications or alterations to the appliance are not allowed for your safety concern. Unintended use may cause hazards and loss of warranty claims.

## Explanation of symbols displayed on the unit

	WARNING	This symbol shows that this appliance used a flammable refrigerant. If the refrigerant is leaked and exposed to an external ignition source, there is a risk of fire.
	CAUTION	This symbol shows that the operation manual should be read carefully.
	CAUTION	This symbol shows that a service personnel should be handling this equipment with reference to the installation manual.
	CAUTION	This symbol shows that information is available such as the operating manual or installation manual.



Caution: Risk of fire/flammable materials  
(Required for R32 units only)

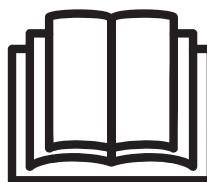

IMPORTANT NOTE: Read this manual carefully before installing or operating your new air conditioning unit. Make sure to save this manual for future reference.

Read these operating instructions carefully and attentively before using/commissioning the unit and keep them in the immediate vicinity of the installation site or unit for later use!

## CAUTION

- For support, please call the Service Center at 1-866-646-4332.
- This appliance is not intended for use by people (including children) with reduced physical, sensory, or mental capabilities or lack of experience and knowledge, unless they have been given supervision or instruction concerning use of the appliance by a person responsible for their safety.
- Children should be supervised to ensure that they do not play with the appliance.
- The appliance shall be installed in accordance with national wiring regulations.
- Do not operate your air conditioner in a humid room such as a bathroom or laundry room.

## **WARNING**

- Be sure the air conditioner has been securely and correctly installed according to the installation instructions in this manual. Save this manual for possible future use in removing or installing this unit.
- Plug in power cord plug properly.  
Otherwise, it may cause electric shock or fire due to excess heat generation.
- Do not modify power cord length or share the outlet with other appliances as it may cause electric shock or fire due to overheating.
- Always ensure effective grounding.  
Incorrect grounding may cause electric shock.
- Unplug the unit if you notice unusual sounds or smells or smoke coming from it.  
A damaged product may cause fire and electric shock.
- Ventilate room before operating the air conditioner if there is a gas leakage from another appliance.
- Do not operate or stop the unit by inserting or pulling out the power cord plug.
- Do not operate with wet hands or in very humid environments.  
It may cause electric shock.
- Do not allow water to come into contact with any electric parts.  
It may cause failure or electric shock.
- Do not use the socket if it is loose or damaged.  
It may cause fire and electric shock.
- Do not use or keep the power cord close to heating appliances.  
It may cause fire and electric shock.
- Do not use any devices or materials for installation that are not recommended in this manual.
- Do not disassemble or modify unit.  
It may cause failure and electric shock.
- Do not damage or use an alternate power cord.  
It may cause fire and electric shock.  
If the power cord is damaged, it must be replaced by the manufacturer or an authorized service center or a similarly qualified person in order to avoid a hazard.
- Do not direct airflow straight into persons to avoid possible health hazard.
- Do not open the unit during operation.  
It may cause electric shock.
- Do not use the power cord near flammable gas or combustibles, such as gasoline, benzene, thinner, etc.  
It may cause an explosion or fire.
- Do not let children hang on the air conditioner or bracket.  
A serious injury may occur.
- Avoid fire hazard or electric shock. Do not use an extension cord or an adaptor plug. Do not remove any prongs from the power cord.
- Be sure the air conditioner is properly grounded. To minimize shock and fire hazards, proper grounding is important. The power cord is equipped with a three-prong grounding plug for protection against shock hazards.
- Your air conditioner must be used in a properly grounded wall receptacle. If the wall receptacle you intend to use is not adequately grounded or protected by a time delay fuse or circuit breaker, have a qualified electrician install the proper receptacle. Ensure the receptacle is accessible after the unit installation.
- Be sure the electrical service is adequate for the model you have chosen. This information can be found on the serial plate, which is located on the side of the cabinet and behind the grille.
- Do not drink the drain water. It may contain mold and bacteria that can lead to death if ingested.



## CAUTION

- When the air filter is to be removed, do not touch the metal parts of the unit. It may cause injury.
- When the unit needs cleaning, switch off, and turn off the circuit breaker. Do not clean unit when power is on as it may cause fire, electric shock or injury.
- Do not place obstacles around air inlets or inside of air outlet. It may cause failure or accident.
- Clean with a soft cloth only. Do not use strong detergents that contain wax or thinners as it may damage the product.
- Use caution when unpacking and installing. Sharp edges could cause injury.
- Do not clean the air conditioner with water. Water may enter the unit and degrade the insulation which could lead to electric shock.
- Do not put a pet or house plant where it will be exposed to direct air flow. This could injure the pet or harm the plant.
- Hold the plug by the head of the power plug when taking it out. Otherwise, it may cause electric shock and damage.
- Ensure that the installation is properly secured to prevent the product from potentially falling.
- Do not place heavy objects on the power cord and ensure that the cord is not compressed. Otherwise, there is danger of fire or electric shock.
- If water is spilled on the unit, turn off the unit and switch off the circuit breaker. Isolate supply by taking the power-plug out and contact a qualified service technician.
- Do not use near gas stove or other gas burning appliances, as air flow may affect gas combustion.
- Do not use for any purpose other than room comfort.
- Do not use this air conditioner to preserve precision devices, food, pets, plants, and art objects. It may cause deterioration.
- Turn off the main power switch if the unit is not to be used for an extended time.
- Always insert the filters securely. Clean filter once every two weeks. Operation without filters may cause failure.



## WARNING

- Do not try to accelerate the defrosting process or methods of cleaning that are not recommended by the manufacturer.
- The appliance shall be stored in a room without a continuously operating ignition source (for example, open flames or an operating gas appliance) or an ignition source (for example, an operating electric heater) close to the appliance. The appliance shall also be stored in a room without ignition sources.
- Do not pierce or burn.
- Be aware that the refrigerants may not contain an odor.
- Keep ventilation openings clear of obstruction.
- Unit is only to be serviced by a Midea authorized servicer, please call Customer Service at 1-866-646-4332 for support.
- Flammable refrigerant R32 is used within air conditioner. Please follow the instructions carefully to handle, install, clean, and service the air conditioner to avoid damage or hazard. Do not dispose of air conditioner in regular trash. Contact qualified agency for proper disposal.
- No open fire or devices that generate spark/arc shall be around the air conditioner to avoid causing ignition of the flammable refrigerant used. Please follow the instructions carefully to store or maintain the air conditioner to prevent mechanical damage from occurring.

## Operation of Current Device

The power supply cord contains a current measuring device that detects damage to the power cord. Test your power supply cord as follows:

1. Plug in the air conditioner.
2. The power supply cord will have TWO buttons on the plug head. Press the TEST button. You will notice a click as the RESET button pops out.
3. Press the RESET Button. You will notice a click as the button engages.
4. The power supply cord is now supplying electricity to the unit. (On some products this is also indicated by a light on the plug head.)

### NOTE

The power supply cord with this air conditioner contains a current detection device designed to reduce the risk of fire.

In the event that the power supply cord is damaged, it can not be repaired. It must be replaced with a cord from the manufacturer.

### NOTE

- Do not use this device to turn the unit on or off.
- Always make sure the RESET button is pushed in for correct operation.
- The power supply cord must be replaced if it fails to reset when either the TEST button is pushed, or it can not be reset. Please contact Customer Service.

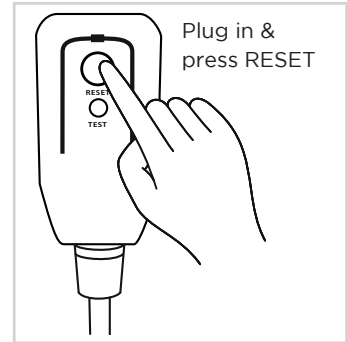

### Grounding type wall receptacle

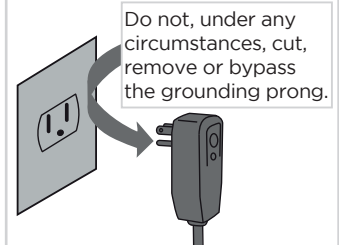

Power supply cord with 3-prong grounding plug and current detection device.

# PRODUCT INSTALLATION

## **⚠ WARNING - Before You Begin**

Read these instructions completely and carefully.

- **IMPORTANT** - Save these instructions.
- **IMPORTANT** - Observe all governing codes and ordinances.

We recommend that two people install this product.

Proper installation is the responsibility of the installer.

Product failure due to improper installation is not covered under the Limited Warranty.

You **MUST** use all supplied parts and use proper installation procedures as described in these instructions when installing this air conditioner.

Do not, under any circumstances, cut or remove the third (ground) prong from the power cord.

Do not change the plug on the power cord of the air conditioner.

Aluminum house wiring may present special problems - consult a qualified electrician.

When handling the air conditioner, be careful to avoid cuts from sharp metal edges and aluminum fins on front and rear coils. Please wear cut-resistant gloves.

## **🔦 NOTE**

Save carton and these Installation Instructions for future reference. The carton is the best way to store unit during winter, or when not in use.

## Window Requirements

Your air conditioner is designed to install in standard double hung windows with opening widths of 23 to 36 inches (584mm to 914mm).

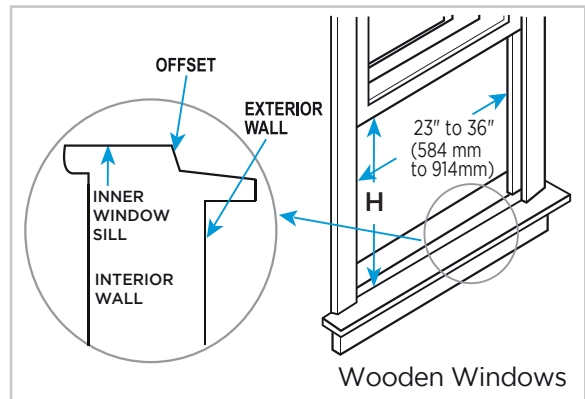

Model	5000 BTU/h	6000 ~ 8000 BTU/h	12000 BTU/h
H	13 in (330 mm)	14 in (356 mm)	15-1/2 in (394 mm)

Table 1

## Tools You Will Need

Phillips Screwdriver

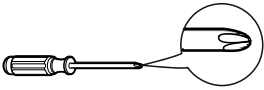

Level



Flathead Screwdriver



Pencil

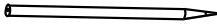

Ruler or tape measure



Scissors or knife





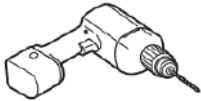

Drill and 1/8" drill bit

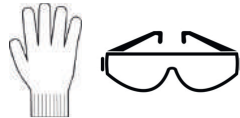

Proper PPE

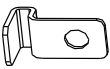
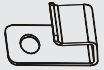
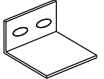

## Installation Hardware

Mounting Hardware			Top Rail Hardware		
	3/4" (1/2") Screws	7		3/8" Screws	4
	Window Sash Seal Foam	1		Top Rail	1
	Lock Frame (For Wooden Windows)	2	<p><b>NOTE</b> The MAW12 comes with its own top rail, so there is no additional top rail.</p>		
	Lock Frame (For Vinyl-Clad Windows)	2			
	Sash Lock	1			

## 1. Prepare the Window

Lower sash must open sufficiently to allow a clear vertical opening (see dimension H in Table 1). Side louvers and the rear of the AC must have clear air space to allow enough airflow through the condenser for heat removal. The rear of the unit must be outdoors, not inside a building or garage.

## 2. Prepare the Air Conditioner

Before installing the unit, the top rail must be assembled on the unit for some models with a capacity of less than 10,000Btu/h.

- A. Remove the air conditioner from the carton and place on a flat surface.
- B. Remove top rail from the packaging material as shown in Fig. A.

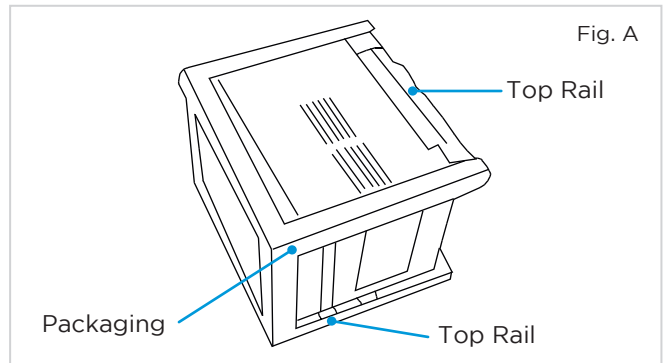

- C. Align the hole in the top rail with those in the top of the unit as shown in Fig. B.
- D. Secure the top rail to the unit with the 3/8" Screws as shown in Fig. C.

MAW05/06 Model

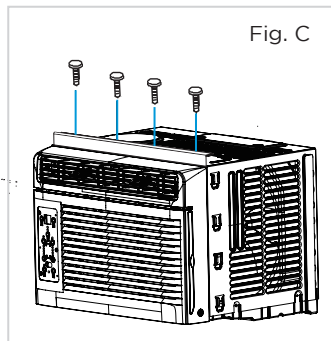
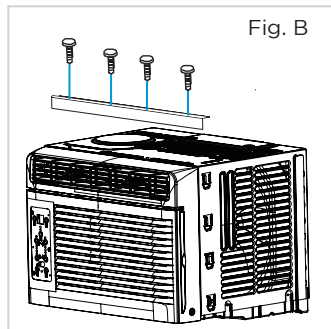

MAW08 Model

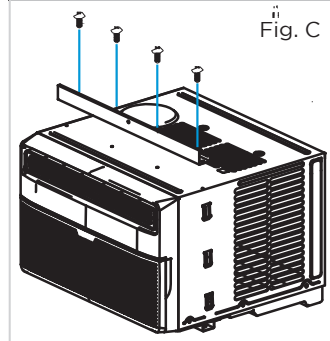
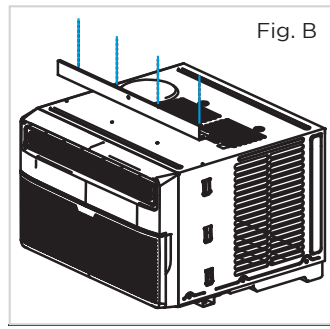

### NOTE

- For safety reasons, all four (4) screws MUST be securely fastened.
- Before installing unit, the top rail must be assembled on the unit.

### 3. Install Accordion Panels on Air Conditioner

**NOTE**

The Top rail and Sliding Panels on each side are offset to provide the proper pitch to the rear of the unit (5/16"). This is necessary for proper condensate management and drainage. If you are not using the Side Panels for any reason, this pitch to the rear must be maintained.

- A. Place unit on the floor, a bench or a table. Hold the Accordion Panel in one hand and gently pull back the center to free the open end. See Fig. 1.

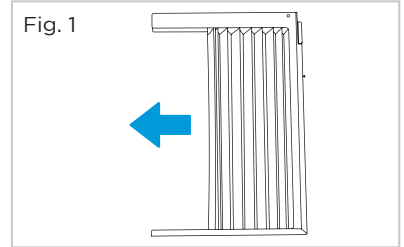

- B. Slide the free end "I" section of the panel directly into the cabinet as shown in Fig. 2. Slide the panel down. Be sure to leave enough space to slip the top and bottom of the frame into the rails on the cabinet.

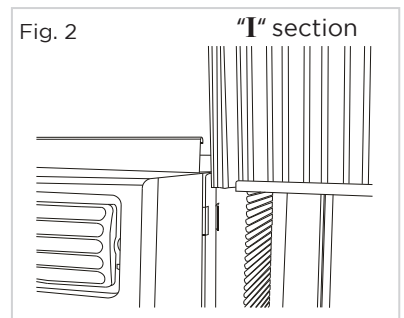

- C. Once the panel has been installed on the side of the cabinet, make sure it sits securely inside the frame channel by making slight adjustments.

Slide the top and bottom ends of the frame into the top and bottom rails of the cabinet. Fig. 3.

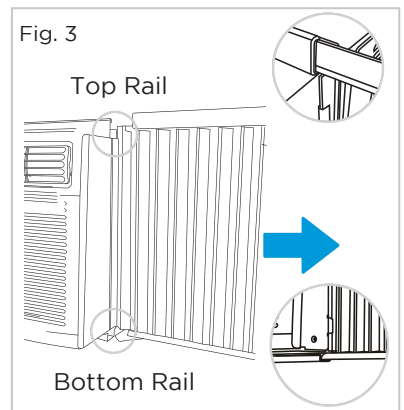

- D. Slide the panel all the way in and repeat on the other side.

**NOTE**

If storm window blocks AC, see Fig. 12.

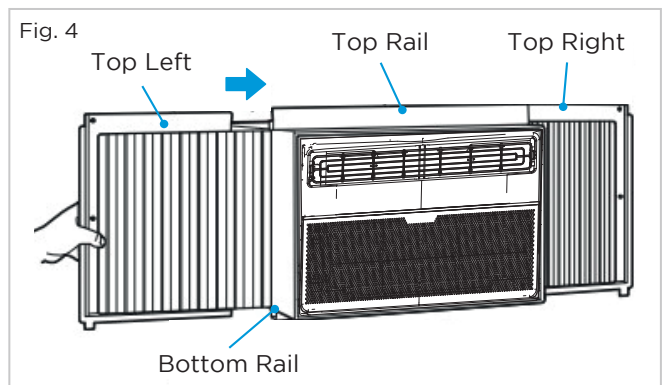

## 4. Install Air Conditioner

- A. Keep a firm grip on the air conditioner, carefully place the unit into the window opening so the bottom of the air conditioner frame is against the window sill (Fig. 5). Carefully close the window behind the top rail of the unit.

### NOTE

Check that air conditioner is tilted back per dimension H (Fig. 5) (tilted about 3° to 4° downward to the outside). After proper installation, condensate should not drain from the overflow drain hole during normal use. Adjust the slope if otherwise.

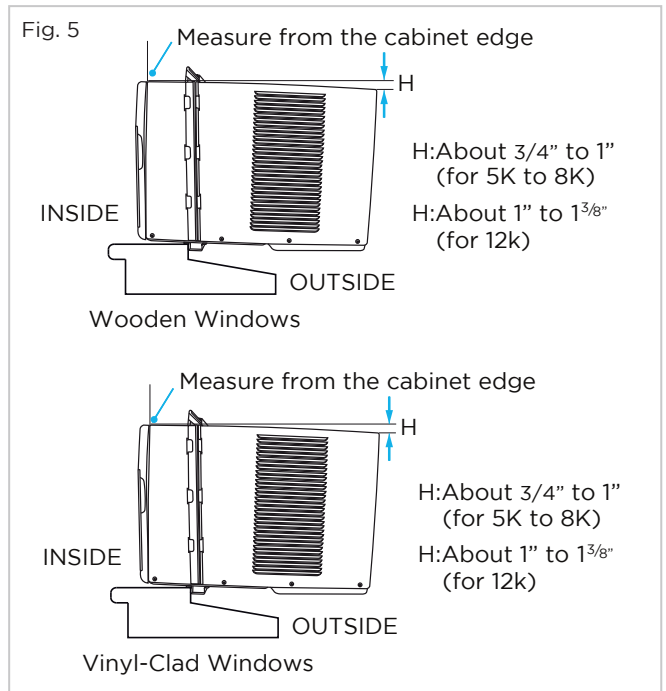

- B. Extend the side panels out against the window frame (Fig. 6).

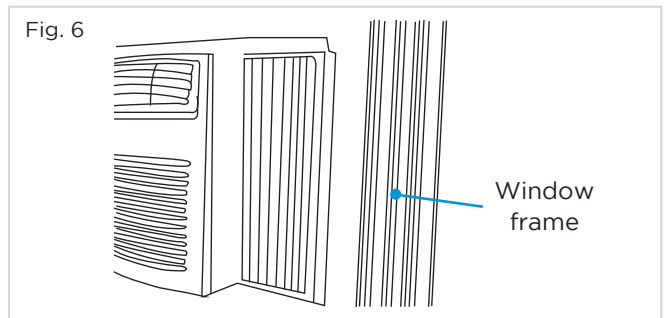

## 5. Secure Air Conditioner

- A. Place the frame lock between the frame extensions and the window sill as shown (Fig. 7A for Wooden windows), (Fig. 7B for Vinyl-Clad windows). Drive 3/4" (19 mm) or 1/2" (12.7 mm) locking screws through the frame lock and into the sill.

### NOTE

To prevent window sill from splitting, drill 1/8" (3 mm) pilot holes before driving screws.

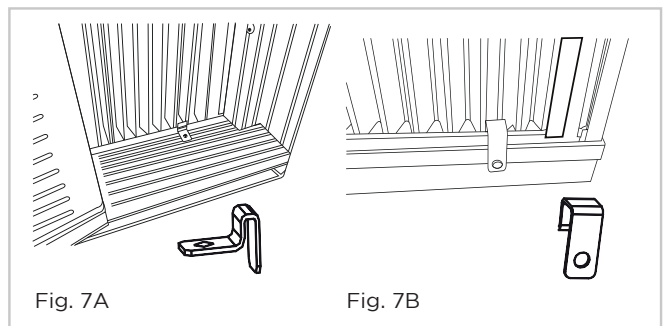

B1: For wooden windows:

Drive 1/2" (12.7 mm) locking screws through the top rail and into the window sash (Fig. 8A).

**NOTE**

To prevent window sill from splitting, drill 1/8" (3mm) pilot holes before driving screws. Drive 1/2" (12.7mm) locking screws through frame holes into window sash (Fig. 8B/8C).

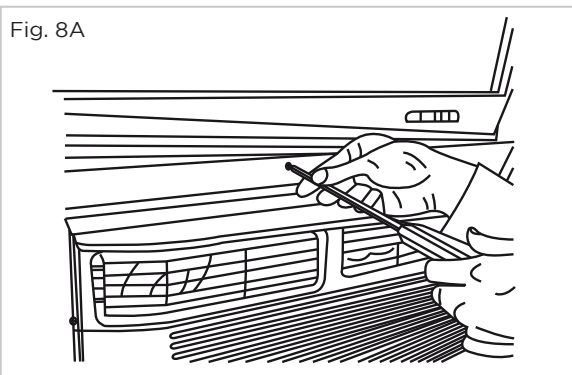

B2: For Vinyl-Clad windows:

Drive 1/2" (12.7 mm) locking screws through the top rail and into the window sash (Fig. 8B/8C).

**NOTE**

Before driving the screws, drill 5 holes into the window through the holes of the top rail and side panel frames as shown (Fig. 8B/8C).

**MAW05/06 Models**

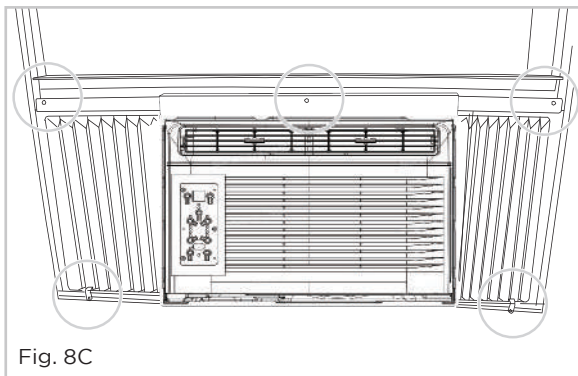

Fig. 8C

**MAW08/12 Models**

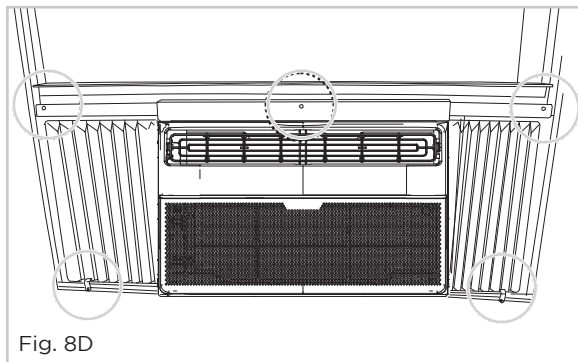

Fig. 8D

C. Secure lower sash in place by attaching the sash lock with the 3/4" (19 mm) or 1/2" (12.7 mm) screw as shown (Fig. 9).

D. Cut Window sash seal foam and insert it in the space between the upper and lower sashes (Fig. 10).



Fig. 9

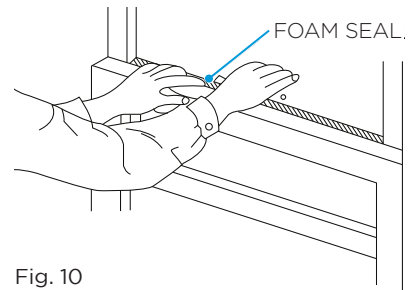
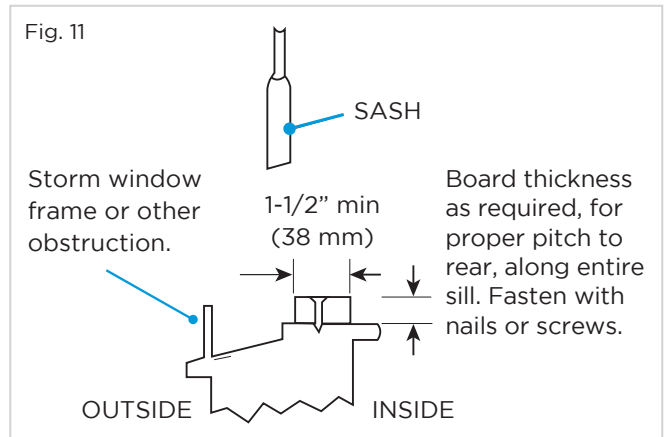

Fig. 10

## IF AC IS BLOCKED BY STORM WINDOW

Add wood as shown in Fig. 11, or remove storm window before air conditioner is installed.

If storm window frame must remain, be sure the drain holes or slots are not caulked or painted shut. Accumulated rain water or condensation must be allowed to drain out.



## REMOVING AC FROM WINDOW

- Turn AC off, and disconnect power cord.
- Remove sash seal from between windows, and unscrew sash lock.
- Remove screws installed through top rail and side panel frames.
- Slide the accordion panels into the rails to close.
- Keeping a firm grip on the air conditioner, raise the sash and carefully remove.
- Be careful not to spill any condensate while lifting unit from window. Store parts WITH air conditioner.

# OPERATION INSTRUCTIONS

## Normal Sounds

### MAW05/06 Models

#### Sound of Rushing Air

In front of the unit, you may hear the sound of rushing air being moved by the fan.

#### High Pitched Chatter

High efficiency compressors may have a high pitched sound during cooling cycle.

#### Trickling Sound

Droplets of water hitting condenser during normal operation may cause a trickling sound.

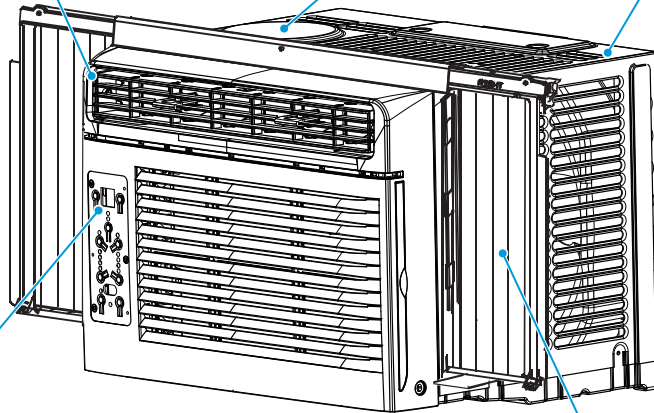

#### Gurgle/Hiss

Gurgling or hissing noises may be heard due to refrigerant flowing through evaporator during normal operation.

#### Vibration

Unit may vibrate and make noise because of poor wall or window construction or incorrect installation.

### MAW10/12 Models

#### Sound of Rushing Air

In front of the unit, you may hear the sound of rushing air being moved by the fan.

#### High Pitched Chatter

High efficiency compressors may have a high pitched sound during cooling cycle.

#### Trickling Sound

Droplets of water hitting condenser during normal operation may cause a trickling sound.

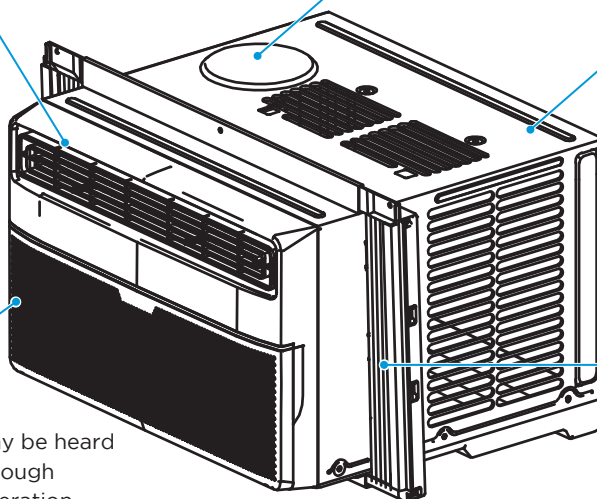

#### Gurgle/Hiss

Gurgling or hissing noises may be heard due to refrigerant flowing through evaporator during normal operation.

#### Vibration

Unit may vibrate and make noise because of poor wall or window construction or incorrect installation.

#### NOTE

All the illustrations in this manual are for explanation purpose only. The actual installation may vary.

## Air Conditioner Features (general)

### **⚠ WARNING**

To reduce the risk of fire, electrical shock, or injury to people or property, read the SAFETY PRECAUTIONS before operating this appliance.

This air conditioner is designed to be operated under the following conditions:

Cooling Operation	Outdoor temperature: 64°F - 109°F / 18°C - 43°C
	Indoor temperature: 62°F - 90°F / 17°C - 32°C

### **● NOTE**

- The relative humidity of the room should be less than 80%. If the unit is used in a condition with a relative humidity over 80%, there will be condensed water on the surface of the unit.
- Performance may be reduced outside of these operating temperatures.

## Air Conditioner Features

### **● NOTE**

Always wait 3 minutes when turning the unit off and then on again, or when changing from cool to fan and back to cool. This prevents damage from occurring to the compressor.

### To begin operating the air conditioner, follow these steps:

1. Plug in the air conditioner (be sure to follow the power cord instructions).
2. Turn the power on to the air conditioner, using the ON/OFF button.
3. Set the thermostat to the coldest temperature setting.
4. Select the Cool mode setting.
5. Adjust the louver for comfortable air flow (see Air Directional Louvers).
6. Once the room has cooled, adjust the thermostat to the setting you find most comfortable.
7. Make sure the air flow inside and outside is not obstructed by anything.

## Air Directional Louvers

The louvers will allow you to direct the air flow Left or Right, or Up and Down (optional on some models) throughout the room as needed.

Move the Levers from side to side until the desired Left/Right direction is obtained.

You can also move the LEFT lever to adjust air flow up/down as needed.

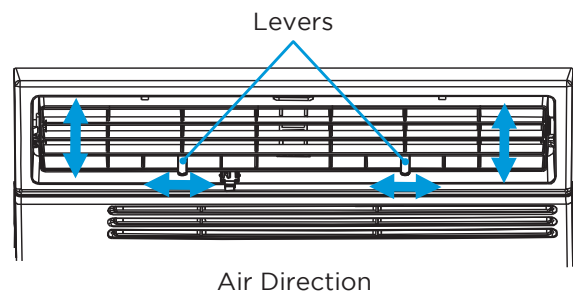

# Air Conditioner Features (MAW05/06 Models)

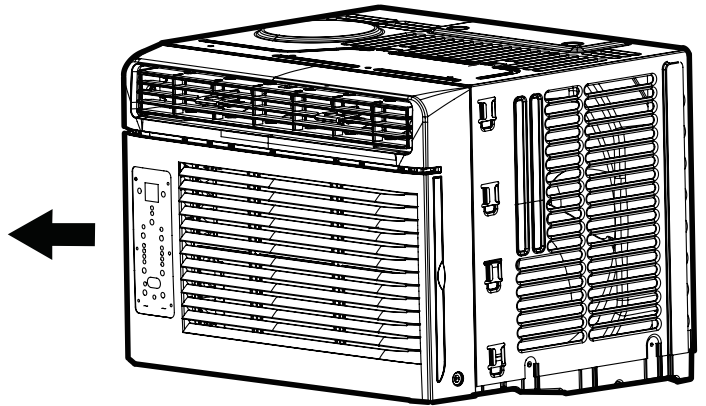
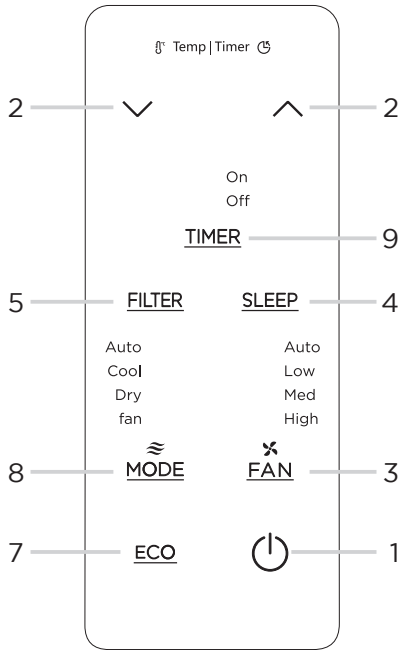

## Air Conditioner Features (MAW08/12 Models)

### ELECTRONIC CONTROL OPERATING INSTRUCTIONS

Before you begin, thoroughly familiarize yourself with the control panel as shown below and all its functions, then follow the symbol for the functions you desire. The unit can be controlled by the unit control alone or with the remote.

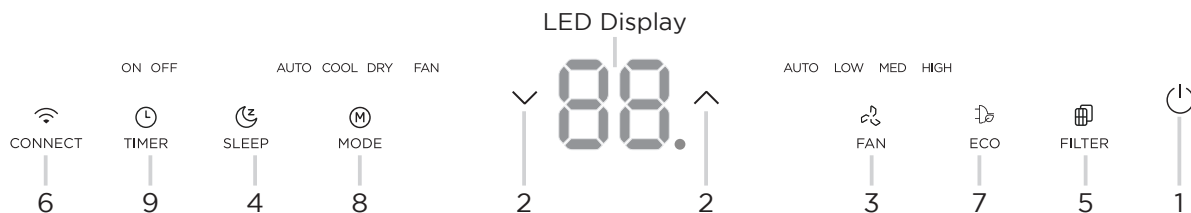

		Description
1		ON / OFF • Press to turn unit on or off.
2		UP / DOWN Button • Press to change temperature setting.
3		Fan Speed • Press to select the Fan Speed in four steps - Auto, Low, Med or High.
4		Sleep Function • Press to initiate the sleep mode.
5		Check Filter Feature • Press to turn off the cleaning filter reminder.
6		Connect Function • Press to initiate smart connection mode. (Smart models only)
7		Energy Saver Feature • Press to initiate this feature, which will maintain comfort and save energy.
8		Mode Functions • Press to choose operating mode in a sequence that goes from Auto, Cool, Dry and Fan.
9		Timer Feature • Press to turn unit Auto Start/Stop.

#### 1. TO TURN UNIT ON OR OFF:

Press Power button to turn unit on or off.

#### 2. TO CHANGE TEMPERATURE SETTING:

Press UP/DOWN button to change temperature setting.

#### NOTE

Press or hold either UP ( ^ ) or DOWN ( v ) button until the desired temperature is seen on the display.

This temperature will be automatically maintained anywhere between 62°F (17°C) and 86°F (30°C). If you want to display the actual room temperature, see To Operate on Fan Only section.

#### 3. TO ADJUST FAN SPEEDS:

Press to select the Fan Speed in four steps - Auto, Low, Med or High. Each time the button is pressed, the fan speed mode is changed. On Dry mode, the fan operates on Low speed automatically and cannot be changed. On Auto mode, the fan operates on Auto fan speed automatically and cannot be changed.

#### 4. SLEEP FEATURE:

Press Sleep button to initiate the sleep mode. In this mode the selected temperature will increase by 2°F (1°C) 30 minutes after the mode is selected. The temperature will then increase by another 2°F (1°C) after an additional 30 minutes.

This new temperature will be maintained for 7 hours before it returns to the originally programmed mode and the unit will continue to operate as originally programmed mode.

The Sleep mode program can be canceled at any time during operation by pressing the Sleep button again.

## 5. CHECK FILTER FEATURE:

The Clean Filter indicator light is a reminder to clean the air filter for more efficient operation. The light will illuminate after 250 hours of operation. After cleaning the air filter, reset by pressing the Clean Filter button. After resetting, the light will go off.

## 6. CONNECT FEATURE:

Press CONNECT button for 3 seconds to turn off the unit and initiate smart connection mode.

For detailed instruction on how to connect your device, see page 29

## 7. ENERGY SAVER FEATURE (ECO):

Press Energy Saver button to initiate this function. This function is available on COOL, DRY, AUTO (only AUTO-COOLING and AUTO-FAN) modes. The fan will continue to run for 3 minutes after the compressor shuts off. The fan then cycles on for 2 minutes at 10 minute intervals until the room temperature is above the set temperature, at which time the compressor turns back on and Cooling resumes.

### NOTE

The unit will automatically initiate the Energy Saver function under Cool, Dry, Auto modes.

## 8. TO SELECT THE OPERATING MODE:

To choose operating mode, press Mode button.

Each time you press the button, a mode is selected in a sequence that goes from Auto, Cool, Dry and Fan. The indicator light adjacent will be illuminated and remain on once the mode is selected.

When the unit is turned off and back on via the power button, the unit will automatically switch on the Energy Saver function for the following modes: Cool, Dry, Auto.

### To operate on AUTO feature:

- When you set the air conditioner to AUTO mode, it will automatically select cooling or fan only operation depending on what temperature you have selected and the current room temperature.
- The air conditioner will control room temperature automatically according to temperature you've set.
- In this mode, the fan speed cannot be adjusted as it's automatically controlled according to temperature setting and room temperature.

### To operate on Fan Only:

- Use this function only when cooling is not desired, such as for room air circulation or to exhaust stale air (on some models). (Remember to open the vent during this function, but keep it closed during cooling for maximum cooling efficiency.) You can choose any fan speed you prefer.
- During this function, the display will show the actual room temperature, not the set temperature as in the cooling mode.
- In Fan Only mode, the temperature is not adjusted.

### To operate on DRY mode:

- In this mode, the air conditioner will generally function as a dehumidifier. Since the conditioned space is a closed or sealed area, some degree of cooling will occur.

## 9. TIMER: AUTO START/STOP FEATURE:

- When the unit is on, press the Timer button. The "Timer off" LED indicator light will illuminate indicating the Auto stop feature has been activated.  
- When the unit is off, press the Timer button. The "Timer on" LED indicator light will illuminate indicating the Auto start feature has been activated.
- When the time of TIMER ON is displayed, press the Timer button again. The TIMER OFF indicator light illuminates. It indicates the Auto Stop program has initiated.
- Press or hold the UP or DOWN button to change the Auto time by 0.5 hour increments, up to 10 hours, then at 1 hour increments up to 24 hours. The control will count down the time remaining until start.
- The selected time will register in 5 seconds, and the system will automatically revert back to display the previous temperature setting or room temperature when the unit is on. (when the unit is off, there is no display.)
- The selected time indicates the amount of time after the current time which you want the unit to turn on or off. If you select Timer On and adjust the time to 2.0h, the unit will turn on 2 hours after the current time.
- Turning the unit ON or OFF at any time or adjusting the timer setting to 0.0 will cancel the Auto Start/Stop timed program.

### NOTE

To cancel timer operation, press and hold the timer button for 2 seconds until the beep/buzzer is heard.

## Displays

### LED Display:

Shows the set temperature in "°C" or "°F" and the Auto-timer settings. While on Fan Only mode, it shows the room temperature. If the room temperature is too high or low, it will display "HI" or "LO".



### Error codes:

- AS - Room temperature sensor error - Unplug the unit and plug it back in.  
If error repeats, call for service.
- ES - Evaporator temperature sensor error - Unplug the unit and plug it back in.  
If error repeats, call for service.

### NOTE

- To change the AC between Celsius and Fahrenheit scales, press the temperature control arrows at the same time for 5 seconds.
- If the unit shuts off unexpectedly due to the power outage, it will restart with the previous function setting automatically when the power resumes.

# REMOTE CONTROL AND APP INSTRUCTIONS

## Handling the Remote Control

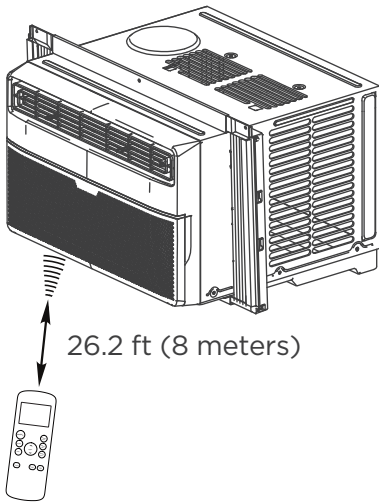

### Location of the remote control

Use the remote controller within a distance of 26.2 ft (8 meters) from the air conditioner, pointing it towards the receiver. Reception is confirmed by a beep.

### CAUTION

- The air conditioner will not operate if curtains, doors or other materials block the signals from the remote control to the unit.
- Prevent any liquid from spilling onto the remote control. Do not expose the remote control to direct sunlight or heat.
- If the infrared signal receiver on the indoor unit is exposed to direct sunlight, the air conditioner may not function properly. Use curtains to prevent the sunlight from falling on the receiver.
- If other electrical appliances react to the remote control, either move these appliances or consult your local dealer.

### NOTICE

- Button design is based on typical model and may vary slightly from the actual one you purchased.
- All the functions described are accomplished by the unit. If the unit is without a feature, the unit will not respond if the corresponding button on the remote is pressed.
- When there are significant differences between features or operation implied by the remote control illustration and the actual functions described in the USER'S MANUAL, the descriptions in the USER'S MANUAL shall prevail.

### Remote Controller Specifications

Rated Voltage: 3.0V (Dry batteries R03/LR03x2)

Environment: 23°F -140°F (-5°-60°)

## Function Buttons

Before you begin using your new air conditioner, make sure to familiarize yourself with its remote control. The following is a brief introduction to the remote control itself. For instructions on how to operate your air conditioner, refer to pages 22-25.

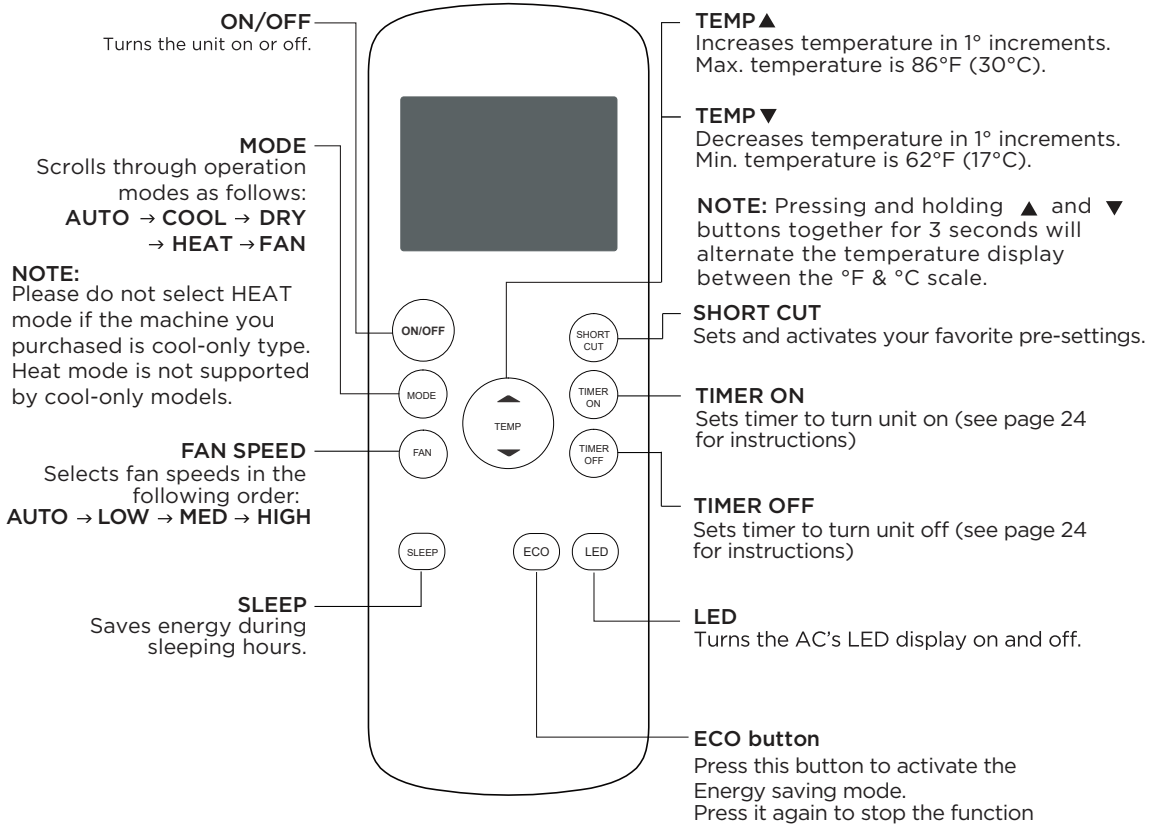



## How to Use the Buttons

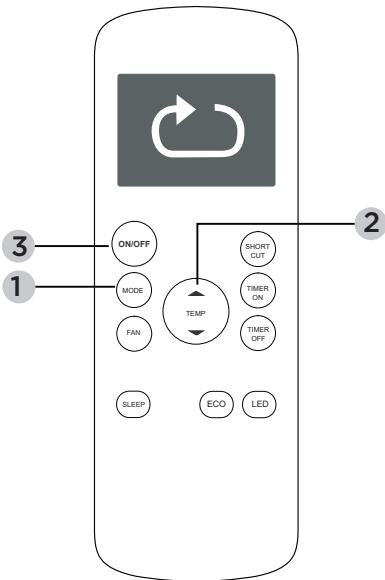

### SETTING THE DESIRED TEMPERATURE

The operating temperature range for this unit is 62°F-86°F (17-30°C). You can increase or decrease the set temperature in 1°F or 1°C increments.

### Changing the Mode

1. To change the operating mode, press the MODE button until the desired mode appears on the remote's display.
2. Set the desired temperature.

#### NOTICE

If the unit does not change when the button is pressed, check that the ON/OFF indicator is illuminated. If it is not, point the remote at the unit and press the ON/OFF button.

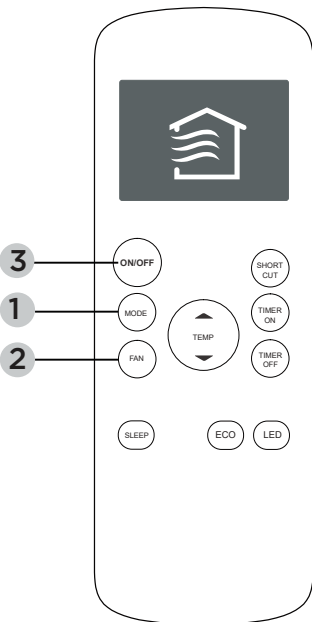

### Changing the Fan Speed

To change the fan speed, press the FAN button until the desired fan speed appears on the remote's display.

#### NOTICE

If the unit does not change when the button is pressed, check that the ON/OFF indicator is illuminated. If it is not, point the remote at the unit and press the ON/OFF button.

## How to Use the Advanced Functions

### SLEEP Function

The SLEEP function is used to decrease energy use while you sleep (and don't need the same temperature settings to stay comfortable).

Note: The SLEEP function is not available in FAN or DRY mode.

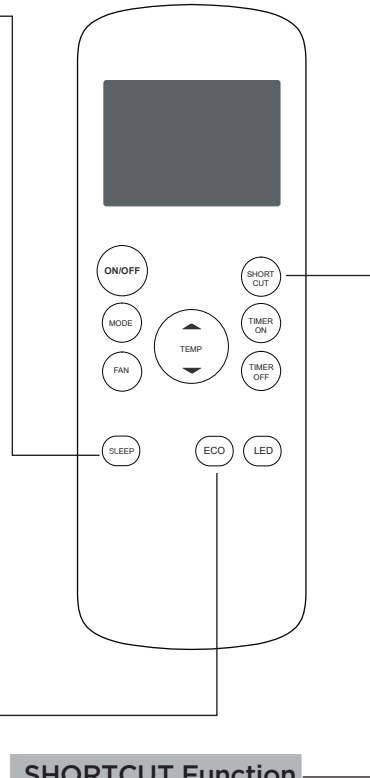

### ECO button

Press this button to activate the Energy saving mode.  
Press it again to stop the function

### SHORTCUT Function

- Used to restore the current settings or resume previous settings.
- Push this button when remote controller is on, the system will automatically revert back to the previous settings including operating mode, set temperature, fan speed level and sleep feature (if activated).
- By pressing for more than 2 seconds, the system will automatically store the current operation settings including operating mode, set temperature, fan speed level and sleep feature (if activated).

## Timer Functions

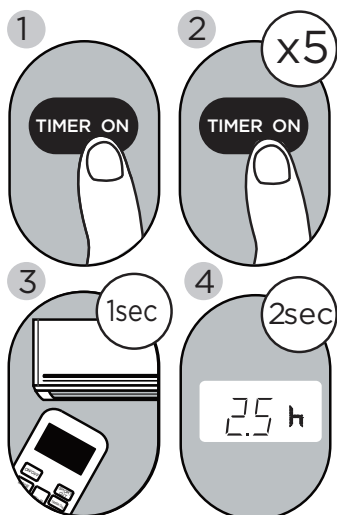

Example: Setting unit to turn on after 2.5 hours.

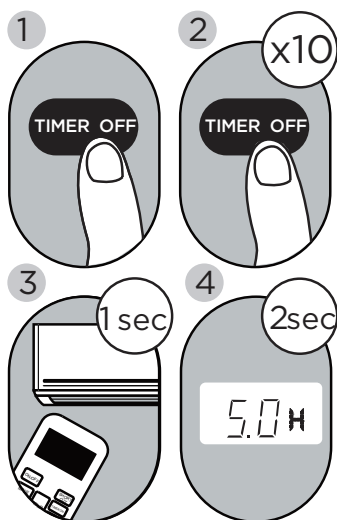

Example: Setting unit to turn off after 5 hours.

Your air conditioning unit has two timer-related functions:

**TIMER ON** - sets the amount of time after which the unit will automatically turn on.

**TIMER OFF** - sets the amount of time after which the unit will automatically turn off.

### TIMER ON function

The TIMER ON function allows you to set a period of time after which the unit will automatically turn on, such as when you come home from work.

1. Press the TIMER ON button. By default, the last time period that you set and an “h” (indicating hours) will appear on the display.

#### NOTICE

This number indicates the amount of time after the current time after which you want the unit to turn on.

For example, if you set TIMER ON for 2 hours, “2.0h” will appear on the screen, and the unit will turn on after 2 hours.

2. Press the TIMER ON button repeatedly to set the time that you want the unit to turn on.
3. Wait 2 seconds, then the TIMER ON function will be activated. The digital display on your remote control will then return to the temperature display.

### TIMER OFF function

The TIMER OFF function allows you to set a period of time after which the unit will automatically turn off, such as when you wake up.

1. Press the TIMER OFF button. By default, the last time period that you set and an “h” (indicating hours) will appear on the display.

#### NOTICE

This number indicates the amount of time after the current time after which you want the unit to turn off.

For example, if you set TIMER OFF for 2 hours, “2.0h” will appear on the screen, and the unit will turn off after 2 hours.

2. Press the TIMER OFF button repeatedly to set the time that you want the unit to turn off.

## Timer Functions (cont.)

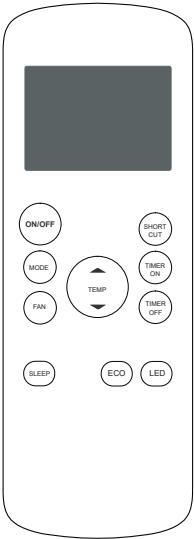

Continue to press **TIMER ON** or **TIMER OFF** until desired time is reached.

- Wait 2 seconds, then the **TIMER OFF** function will be activated. The digital display on your remote control will then return to the temperature display.

### NOTICE

When setting the **TIMER ON** or **TIMER OFF** functions, up to 10 hours, the time will increase in 30 minute increments with each press. After 10 hours and up to 24, it will increase in 1 hour increments. The timer will revert to zero after 24 hours.

You can turn off either function by setting the timer to "0.0h".

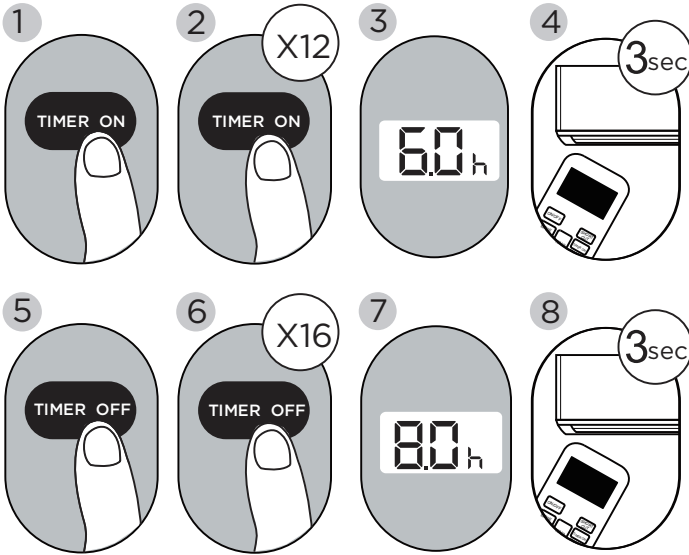

Setting both **TIMER ON** and **TIMER OFF** at the same time

Keep in mind that the time periods you set for both functions refer to hours after the current time. For example, say that the current time is 1:00 PM, and you want the unit to turn on automatically at 7:00 PM and want it to operate for 2 hours, then automatically turn off at 9:00 PM. Do the following (side figure):

Example: Setting the unit to turn on after 6 hours, operate for 2 hours, then turn off (see the figure below).

Your remote display

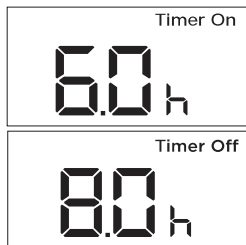

Timer is set To turn ON 6 hours from current time

Timer is set To turn OFF 8 hours from current time

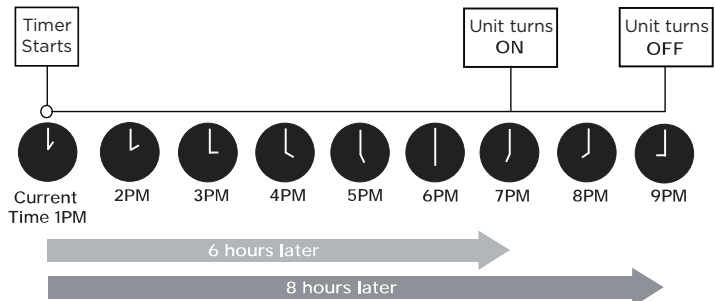

## NOTES

- Button design is based on a typical model and may slightly vary from the actual one you purchased.
- This device complies with part 15 of the FCC Rules. Operation is subject to the following two conditions: (1) This device may not cause harmful interference, and (2) this device must accept any interference received, including interference that may cause undesired operation.
- This equipment has been tested and found to comply with the limits for a Class B digital device, pursuant to part 15 of the FCC Rules. These limits are designed to provide reasonable protection against harmful interference in a residential installation. This equipment generates, uses and can radiate radio frequency energy and, if not installed and used in accordance with the instructions, may cause harmful interference to radio communications. However, there is no guarantee that interference will not occur in a particular installation. If this equipment does cause harmful interference to radio or television reception, which can be determined by turning the equipment off and on, the user is encouraged to try to correct the interference by one or more of the following measures:
  - Reorient or relocate the receiving antenna.
  - Increase the separation between the equipment and receiver.
  - Connect the equipment to an outlet on a circuit different from that to which the receiver is connected.
  - Consult the dealer or an experienced radio/TV technician for help.
  - Changes or modifications not approved by the party responsible for compliance could void users authority to operate the equipment.

### **Battery Warning:**

Do not mix old and new batteries and Do not mix alkaline, standard (carbon-zinc) or rechargeable (ni-cad, ni-mh, etc.) batteries

### **Supplier's Declaration of Conformity 47 CFR § 2.1077 Compliance Information**

**Unique Identifier:** Midea brand, RG57J4(B)/BGCEU1

#### **Responsible Party U.S. Contact Information**

Midea America Corporation  
300 Kimball Dr  
Parsippany NJ  
07054

Telephone number or internet contact information: [Midea.com/us](http://Midea.com/us)

#### **FCC Compliance Statement** ( products subject to Part 15)

This device complies with Part 15 of the FCC Rules. Operation is subject to the following two conditions: (1) This device may not cause harmful interference, and (2) this device must accept any interference received, including interference that may cause undesired operation.

## Declaration of Conformity

We hereby declare that this AC is in compliance with the essential requirements and other relevant provisions of Directive 1999/5/EC.

## Specification of Wireless Module

<b>Model:</b> US-SK105	<b>Dimensions:</b> 41 x 24 x 5 (mm)
<b>Antenna Type:</b> Printed PCB Antenna	<b>Operation Temperature:</b> 0°C - 45°C / 32°F - 113°F
<b>Frequency:</b> WLAN 2400-2483.5 MHz	<b>Operation Humidity:</b> 10% - 85%
<b>Maximum Transmitted Power:</b> <20 dBm Max	<b>Power Input:</b> DC 5V/500 mA

## PRECAUTIONS

1. Supports operating systems: Please refer to page 28
2. In the event of a OS update, there may be a delay between the update of the OS and a related software update during which your OS may or may not be supported until a new version is released. Your specific mobile phone or problems in your network may prevent the system from working and Midea will not be responsible for any problems that could be caused by incompatibility or network issues.
3. This Smart AC only supports WPA-PSK/WPA2-PSK (recommended) encryption.
4. To ensure proper scanning of the QR code, your smart phone must have at least a 5-megapixel camera.
5. Due to unstable network connectivity, requests may time out. If this happens, rerun the network configuration.
6. Due to unstable network connectivity, commands may time out. If this happens, the smartphone app and the actual product may display conflicting information. The information displayed on the actual product is always the most accurate available. Refresh the app to re-sync.

**App & Smart Speakers can support Matter only when using these versions or above.**

Device	Version
iPhone	iOS 16.5
Apple Home Pod	16.5
Android	Google Play services min version: 22.36.15 Google Home app (GHA) min version: 2.58.24.1-dogfood
Google Home Hub	Google Hub firmware min version: 1.56.324896 (appears on hub as Chromecast firmware version)
Alexa App	2.2.536317
Alexa Echo Device	9094439556

**NOTE:**

- Setup processes and features may vary between ecosystems.
- The functions shown in the Alexa, Google Home or Apple Home apps may change with updates to their products or apps.
- Periodically, we will update the device's software to improve the experience. Device software updates can be accomplished through the SmartHome app.

**NOTICE**

Midea will not be responsible for any problems that could be caused by incompatibility or network issues, your wireless router and mobile phone.

# 1 How to use SmartHome App (smart models only)

⚠️ Ensure that your mobile phone is connected to the wireless network. Bluetooth must be turned on. The device must also be powered up.

## ■ Step 1: Download the SmartHome app

Scan the QR code below to download the SmartHome app from app store or search for it directly on the Google Play Store or Apple's App Store.



## ■ Step 2: Log in

Open the SmartHome app. Log in directly if you have an existing SmartHome account or create a new account. Alternatively, you can also use a 3rd party login platform.

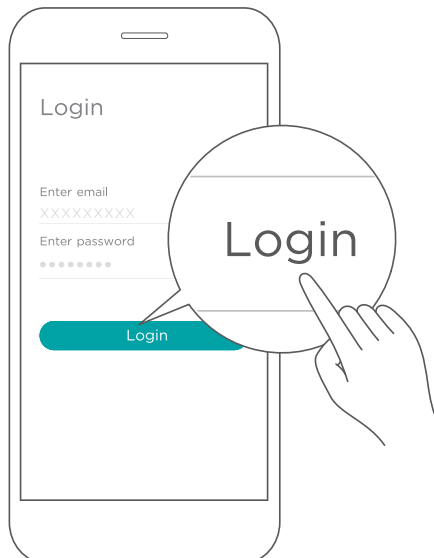

### ■ Step 3: Connecting the device

1) When you log in, you may see the message "Smart devices discovered nearby". Tap to add your device.

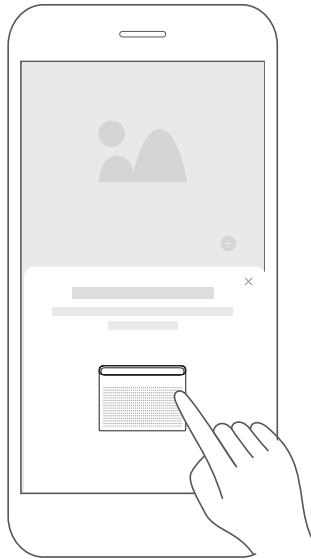

2) If no such message appears, proceed as follows: Tap on "+" and select your device in the list of nearby available devices.  
If your device is not listed, please add your device manually, first selecting the device category e.g. Window AC.

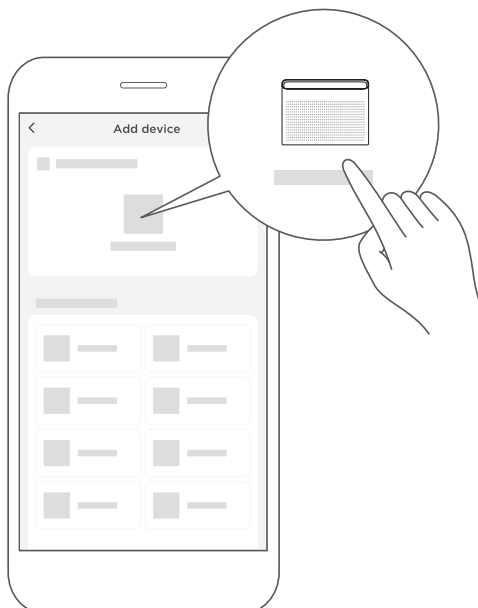

3) Follow the steps in the app to connect your device to the wireless network. If your device fails to connect, follow the additional instructions in the app.

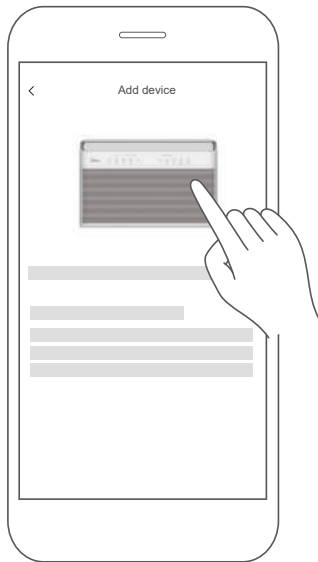

For Window AC



For Portable AC

#### ■ Step 4: Controlling the device

After pairing successfully, a card will be created for the device in the SmartHome app. Shortcuts for basic functions will appear on the card such as changing the temperature or switching the device on or off.

Tapping on the card, will reveal additional features and settings. The actual UI design may look different from examples due to app updates.

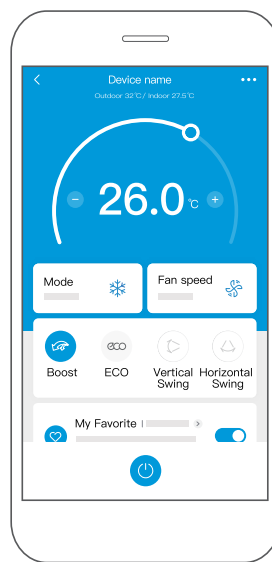
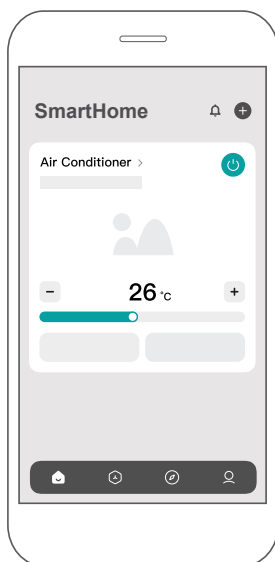

## ■ Declaration of conformity

**FCC ID: 2ADQOMDNA21**  
**IC: 12575A-MDNA21**

This device complies with Part 15 of the FCC Rules and Industry Canada's licence exempt RSSs.

Operation is subject to the following two conditions:

- (1) This device may not cause interference;and
- (2) This device must accept any interference,including interference that may cause undesired operation of the device.

Only operate the device in accordance with the instructions supplied. Changes or modifications to this unit not expressly approved by the party responsible for compliance could void the user's authority to operate the equipment.This device complies with FCC radiation exposure limits set forth for an uncontrolled environment. In order to avoid the possibility of exceeding the FCC radio frequency exposure limits, human proximity to the antenna shall not be less than 20cm (8 inches) during normal operation.

### **NOTE:**

This equipment has been tested and found to comply with the limits for a Class B digital device, pursuant to part 15 of the FCC Rules. These limits are designed to provide reasonable protection against harmful interference in a residential installation. This equipment generates, uses and can radiate radio frequency energy and, if not installed and used in accordance with the instructions, may cause harmful interference to radio communications. However, there is no guarantee that interference will not occur in a particular installation. If this equipment does cause harmful interference to radio or television reception, which can be determined by turning the equipment off and on, the user is encouraged to try to correct the interference by one or more of the following measures:

- Reorient or relocate the receiving antenna.
- Increase the separation between the equipment and receiver.
- Connect the equipment into an outlet on a circuit different from that to which the receiver is connected.
- Consult the dealer or an experienced radio/TV technician for help.

Hereby, we declare that this AC is in compliance with the essential requirements and other relevant provisions of RE Directive 2014/53/EU. A copy of the full DoC is attached (European Union products only).

# CLEANING AND MAINTENANCE

## CAUTION

Clean your air conditioner occasionally to keep it looking new. Be sure to unplug the unit before cleaning to prevent shock or fire hazards.

## Air Filter Cleaning

The air filter should be checked at least once every two weeks to see if cleaning is necessary. Trapped particles in the filter can build up and cause an accumulation of frost on the cooling coils and reduce performance.

- Grasp the filter by the center and pull up and out.
- Wash the filter using warm water. Rinse filter thoroughly.
- Gently shake excess water from the filter. Be sure the filter is thoroughly dry before replacing.
- Instead of washing, you may also vacuum the filter clean rather than washing.

### NOTE

Never use hot water over 104°F (40°C) to clean the air filter. Never attempt to operate the unit without the air filter.

### MAW05/06 Models

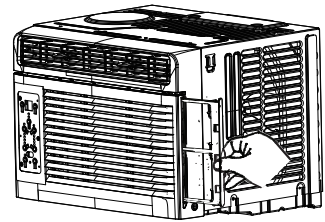

### MAW10/12 Models

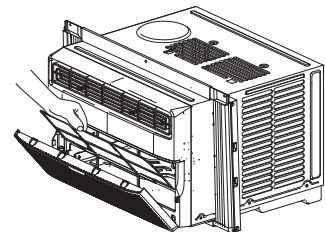

## Cabinet Cleaning

- Be sure to unplug the air conditioner to prevent shock or fire hazard. The cabinet and front may be dusted with an oil-free cloth or washed with a cloth dampened in a solution of warm water and mild liquid dishwashing detergent. Rinse thoroughly and wipe dry.
- Never use harsh cleansers, wax, or polish on the cabinet front.
- Be sure to wring excess water from the cloth before wiping around the controls. Excess water in or around the controls will cause damage to the air conditioner.

## Winter Storage

If you plan to store the air conditioner during the winter, remove it carefully from the window according to the installation instructions. Cover the unit with plastic or return it to the original carton.

# TROUBLESHOOTING TIPS

Before calling for service, review this list. It may save you time and expense. This list includes common occurrences that are not the result of defective workmanship or materials in this appliance.

Problem	Solution
Air conditioner does not start.	Wall plug disconnected. Push plug firmly into wall outlet.
	Circuit breaker tripped. Reset circuit breaker.
	Check if the light on the plug is on. If it is off, press the RESET button.
	Power is OFF. Turn power ON.
Air from unit does not feel cold enough.	Unit turned off and then on quickly. Turn unit off and wait 3 minutes before restarting.
	Room temperature below 62°F (17°C). Cooling may not occur until room temperature rises above 62°F (17°C).
	Temperature sensor behind the air filter is touching the cold coil. Try to move it so it does not contact the cold coil.
	Reset to a lower temperature.
	Compressor shut-off by changing modes. Wait approximately 3 minutes and listen for compressor to restart when set in the COOL mode.
Check for potential obstructions blocking the outdoor intake/exhaust. Clear any obstructions.	
Air conditioner cooling, but room is too warm - ice forming on cooling coil behind air filter.	Outdoor temperature below 64°F (18°C). To defrost the coil, set to FAN ONLY mode.
	Air filter may be dirty. Clean filter. Refer to Cleaning and Maintenance section. To defrost, set to FAN ONLY mode.
	Thermostat set too cold for night-time cooling. To defrost the coil, set to FAN ONLY mode. Then, set temperature to a higher setting.
Air conditioner cooling, but room is too warm - NO ice forming on cooling coil behind air filter.	Dirty or restricted air filter. Clean filter. Refer to Cleaning and Maintenance section. To defrost, set to FAN ONLY mode.
	Temperature is set too high, set temperature to a lower setting.
	Air directional louvers positioned improperly. Position louvers for better air distribution.
	Front of unit is blocked by drapes, blinds, furniture, etc. - restricts air distribution. Clear obstruction in front of unit.
	Any open doors, windows, or registers may allow cold air to escape. Close any doors, windows, or registers.
	The room may be too warm. Allow additional time to remove "stored heat" from walls, ceiling, floor and furniture.

Problem	Solution
Air conditioner turns on and off rapidly.	Dirty air filter - air restricted. Clean air filter.
	Outside temperature extremely hot. Set FAN speed to a higher setting to bring air past cooling coils more frequently.
	Check for potential obstructions blocking the outdoor intake/exhaust. Clear any obstructions.
Noise when unit is cooling.	Air movement sound. This is normal. If too loud, set to a slower FAN setting.
	Window vibration - poor installation. Refer to installation instructions or check with installer.
Water dripping INSIDE when unit is cooling.	Improper installation. Tilt air conditioner slightly to the outside to allow water drainage. Refer to installation instructions - check with installer.
Water dripping OUTSIDE when unit is cooling.	Unit removing large quantity of moisture from humid room. This is normal during excessively humid days.
Remote sensing deactivating prematurely (some models).	Remote control not located within range. Place remote control within 16.4 feet & 180°, radius of the front of the unit, and pointed in the general direction of the air conditioner unit.
	Remote control signal obstructed. Remove obstruction.
Room too cold.	Temperature setting too low. Increase temperature setting.
Noise when unit starts.	A “da-da” sound may occur for thirty seconds when the unit is turned on due to the compressor starting. It is normal.
Unit will not connect to Wireless or App does not work (some models).	For additional support and troubleshooting tips, visit the “Help” tab within the SmartHome app.

# WARRANTY

## Air Conditioner Limited Warranty

Your product is protected by this Limited Warranty:

Warranty service must be obtained from Midea Consumer Services or an authorized Midea servicer.

---

### Warranty

- Two Year Full Warranty from original purchase date.

### Midea, through its authorized services will:

- Pay all costs for repairing or replacing parts of this appliance which prove to be defective in materials or workmanship.

### Consumer will be responsible for:

- Diagnostics, removal, transportation and reinstallation cost required because of service.
- Costs of service calls that are a result of items listed under NORMAL RESPONSIBILITIES OF THE CONSUMER\*\*

Midea replacement parts shall be used and will be warranted only for the original warranty.

---

### NORMAL RESPONSIBILITIES OF THE CONSUMER\*\*

**This warranty applies only to products in ordinary household use, and the consumer is responsible for the items listed below:**

1. Proper use of the appliance in accordance with instructions provided with the product.
2. Routine maintenance and cleaning necessary to keep the good working condition.
3. Proper installation by an authorized service professional in accordance with instructions provided with the appliance and in accordance with all local plumbing, electrical and/or gas codes.
4. Proper connection to a grounded power supply of sufficient voltage, replacement of blown fuses, repair of loosen connections or defects in house wiring.
5. Expenses for making the appliance accessible for servicing.
6. Damages to finish after intallation.

### EXCLUSIONS

**This warranty does not cover the following:**

- 1) Failure caused by damage to the unit while in your possession (other than damage caused by defect or malfunction), by its improper installation, or by unreasonable use of the unit, including without limitation, failure to provide reasonable and necessary maintenance or to follow the written Installation and Operating Instructions.
- 2) Damages caused by serviced performed by persons other than those authorized by Midea customer service; or external causes such as abuse, misuse, inadequate power supply or acts of God.
- 3) If the unit is put to commercial, business, rental, or other use or application other than for consumer use, we make no warranties, express or implied, including but not limited to, any implied warranty of merchantability or fitness for use or purpose.
- 4) Products without original serial numbers or products that have serial numbers which have been altered or cannot be readily determined.

**NOTICE: Some states do not allow the exclusions or limitation of incidental or consequential damages. So this limitation or exclusion may not apply to you.**

### IF YOU NEED SERVICE

Keep your bill of sale, delivery slip, or some other appropriate payment Record.

The date on the bill establishes the warranty period, should service be required.

If service is performed, its your best interest to obtain and keep all receipts.

This written warranty gives you specific legal rights. You may also have other rights that vary from state to state.

Service under this warranty must be obtained by following these steps, in order:

- 1) Contact Midea Consumer Services or an authorized Midea services at 1 866 646 4332.
- 2) If there is a question as to where to obtain service, contact our consumer relations Department.









*make yourself at home*



[www.midea.com](http://www.midea.com)

© Midea 2023 all rights reserved

CWS002IU-TYN8(GF)

20231109