

ELECTRIC RANGE

30" width / 5 cu. ft. / Rear Control /
Ceramic Glass Top / with Air Fry and Convection

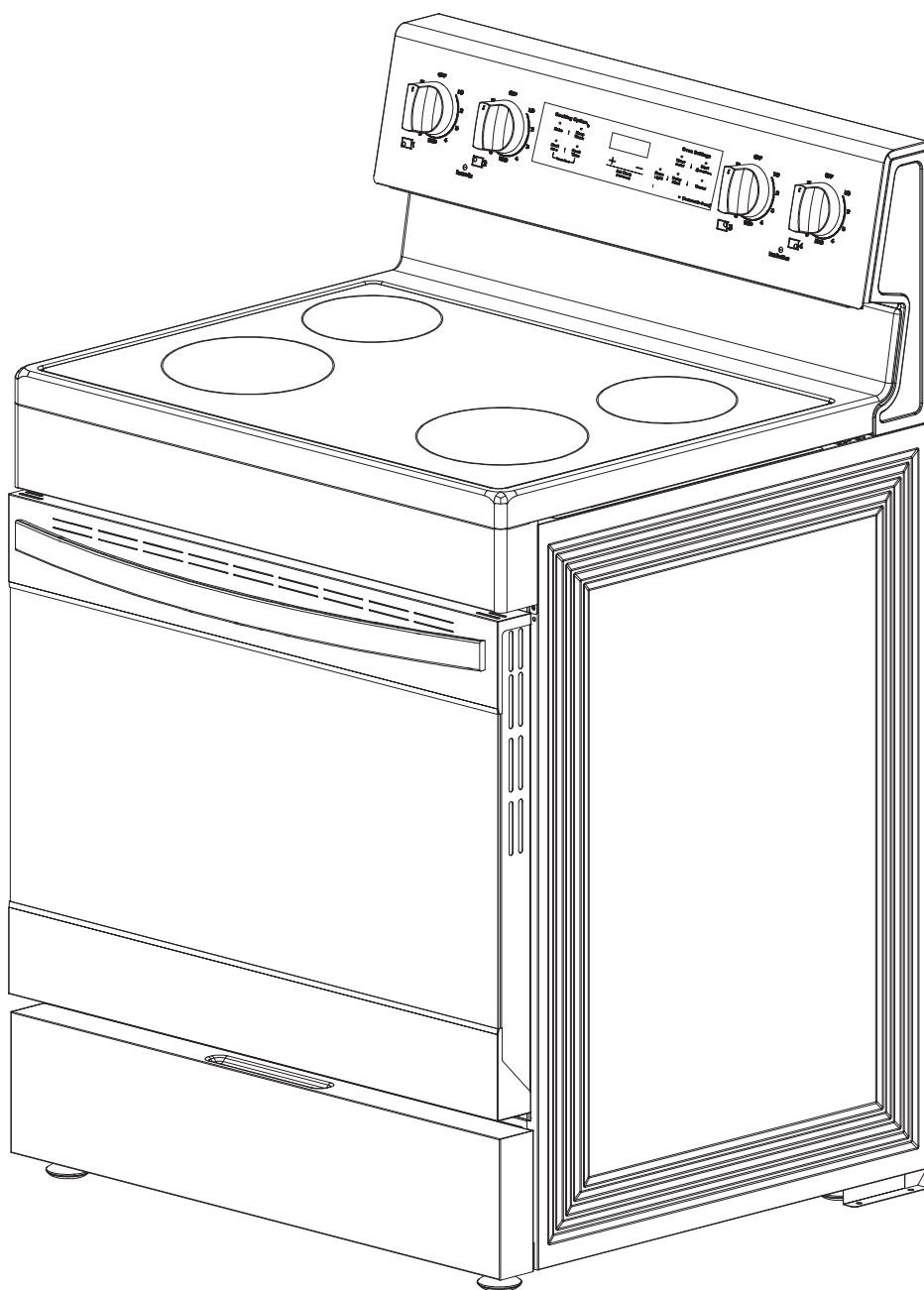

TABLE OF CONTENTS

IMPORTANT SAFETY PRECAUTIONS	4
Anti-tip device	4
IMPORTANT SAFETY INSTRUCTIONS	4
Specifications	10
PRODUCT OVERVIEW	11
Package contents	11
Main components	11
Oven control panel	11
INSTALLATION	13
Selecting a location	14
Clearances and dimensions	14
Electrical requirements	15
Installing your range	16
Tools you need (not included)	16
Items not included	16
Notes to the installer	16
Before installing your range	17
Connecting the power cord	17
Installing the anti-tip device	20
Placing your range and connecting to power	20
Leveling your range	21
Finishing the installation	21
Installing the oven door handle	21
Installing the plastic pads	22
OPERATING INSTRUCTIONS	23
Before you begin using your range	24
Tips for saving energy	24
Using the surface burners	24
Identifying the burners	25
Cooking areas	25
Using a surface element control knob	26
Using the correct cookware	26
Protecting the ceramic cooktop	27
Using the oven	27
Minimum and maximum settings	27
Positioning the oven racks	29

TABLE OF CONTENTS

Using the oven vent	30
Using the oven light	30
Tips for baking	30
Setting the clock	30
Selecting the 12-hour or 24-hour display setting ...	31
Using the timer	31
Baking	31
Adjusting the thermostat	32
Programming the cook time	32
Programming a delayed start time	33
Broiling	33
Air Fry	34
Keeping food warm	34
Switching between Fahrenheit and Celsius	34
Locking oven controls	34
MAINTENANCE	35
Cleaning and maintenance	36
Using the oven vent	36
Cleaning the control panel	36
Cleaning painted parts and decorative trim	36
Cleaning stainless steel surfaces	36
Cleaning the oven racks	37
Cleaning the oven door	37
Cleaning the surface element control knobs	37
Cleaning the cooktop	38
Removing and replacing the oven door	39
Removing and replacing the storage drawer	42
Steam cleaning the oven	43
TROUBLESHOOTING	44
Control panel display	44
Cooktop	45
Oven	46
Drawer	48
Error codes	49
WARRANTY	50

IMPORTANT SAFETY PRECAUTIONS

Read and follow all instructions before using your oven to prevent the risk of fire, electric shock, personal injury, or damage when using the range. This guide does not cover all possible conditions that may occur. Always contact your service agent or manufacturer about problems that you do not understand.

WHAT YOU NEED TO KNOW ABOUT SAFETY PRECAUTIONS

Anti-tip device

WARNING

To reduce the risk of tipping the range, the range must be secured by a properly installed Anti-Tip device.

AFTER THE RANGE HAS BEEN INSTALLED, CONFIRM THAT THE ANTI-TIP DEVICE HAS BEEN PROPERLY INSTALLED AND VERIFY THAT THE ANTI-TIP DEVICE IS PROPERLY ENGAGED.

- If the anti-tip device is not installed, a child or adult can tip the range and be killed.
- Verify that the anti-tip device has been properly installed and engaged at the rear right (or rear left) of the range bottom.
- If you move the range and then move it back into place, ensure the anti tip-device is re-engaged at the right or left rear of the range bottom.
- Do not operate the range without the anti-tip device in place and engaged.
- Failure to do so can result in death or serious burns to children or adults.

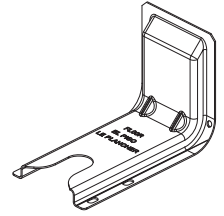

WARNING

- Do not step, lean, or sit on the doors of the range. You can cause the range to tip, resulting in burns or serious injuries.
- Confirm that the Anti-Tip device is installed properly. Then, to verify that the Anti-Tip device is engaged, grasp the top rear edge of the range and carefully attempt to tilt it forward. The Anti-Tip device should prevent the range from tilting forward more than a few inches.
- If you pull the range out from the wall for any reason, make sure the anti-tip device is properly engaged when you push the range back against the wall. If it is not, there is a risk of the range tipping over and causing injury if you or a child stand, sit, or lean on the open door.
- Never completely remove the leveling legs. If you remove the leveling legs, the range will not be secured to the antitip device properly.



IMPORTANT SAFETY INSTRUCTIONS

Read and follow all instructions before using your oven to prevent the risk of fire, electric shock, personal injury, or damage when using the range. This guide does not cover all possible conditions that may occur. Always contact your service agent or manufacturer about problems that you do not understand.

WHAT YOU NEED TO KNOW ABOUT SAFETY INSTRUCTIONS

Warnings and Important Safety Instructions in this manual do not cover all possible conditions and situations that may occur. It is your responsibility to use common sense, caution, and care when installing, maintaining, and operating your oven.

What the icons and signs in this user manual mean:

	CAUTION To reduce the risk of fire, explosion, electric shock, or personal injury when using your oven, follow these basic safety precautions.
 WARNING	Hazards or unsafe practices that may result in severe personal injury or death.
 CAUTION	Hazards or unsafe practices that may result in minor personal injury or property damage.

IMPORTANT SAFETY INSTRUCTIONS

CALIFORNIA PROPOSITION 65 WARNING

WARNING - Cancer and Reproductive Harm - www.P65Warnings.ca.gov.

FOR YOUR SAFETY

When using electrical appliances, you should follow basic safety precautions, including the following:



CAUTION

- Use this appliance only for its intended purpose as described in this User Guide.
- Potentially hot surfaces include the cooktop, areas facing the cooktop, oven vent opening, surfaces near the opening, and crevices around the oven door.
- Be sure your appliance is properly installed and grounded by a qualified technician.
- User servicing - Do not repair or replace any part of the appliance unless specifically recommended in this manual. All other servicing should be referred to a qualified technician.
- Always disconnect the power to the appliance before servicing by removing the fuse or switching off the circuit breaker.
- Do not store items of interest to children in cabinets above a range or on the back guard of a range. Children climbing on the range to reach items could be seriously injured.
- Do not leave children alone. Never leave children alone or unattended in an area where this appliance is in use. They should never be allowed to sit or stand on any part of the appliance.
- Never use your appliance for warming or heating the room.
- Do not use water on grease fires. Turn off the oven to avoid spreading the flames. Smother the fire or flames by closing the door or use a dry chemical, baking soda, or foam-type extinguisher.

ADDITIONAL SAFETY INSTRUCTIONS

- Do not store items in or on the appliance. Do not store flammable materials in the oven or near the surface elements. Be sure all packing materials are removed from the appliance before operating it. Keep plastics, clothes, and paper away from parts of the appliance that may become hot.
- Wear proper apparel. Never wear loose-fitting or hanging garments while using the appliance.
- Use only dry potholders. Placing moist or damp potholders on hot surfaces may result in burns from steam. Do not let the potholder touch hot heating elements. Do not use a towel or other bulky cloth.
- Teach children not to play with the controls or any other part of the range.
- For your safety, do not use high-pressure water cleaners or steam jet cleaners.
- If the power cord is damaged, it must be replaced by the manufacturer, its service agent, or similarly qualified persons to avoid creating a hazard.
- The appliance is not intended for use by persons (including children) with reduced physical, sensory, or mental capabilities, or lack of experience and knowledge, unless they have been given supervision or instruction concerning use of the appliance by a person responsible for their safety.

SURFACE COOKING ELEMENTS

- Never leave surface elements unattended at high heat settings. Boilovers cause smoking and greasy spillovers that may ignite.
- Protective Liners – Do not use aluminum foil to line surface element drip bowls or oven bottoms, except as suggested in the manual. Improper installation of these liners may result in a risk of electric shock or fire.
- To avoid oil spillover and fire, use a minimum amount of oil when shallow pan-frying and avoid cooking frozen foods with excessive amounts of ice.
- Do not lift the cooktop. Lifting the cooktop can damage the range and cause the range to malfunction.
- Do not operate the cooktop without cookware. If the cooktop operates without cookware, the control knobs will become hot.
- Never use the glass cooktop surface as a cutting board.

ADDITIONAL SAFETY INSTRUCTIONS

SURFACE COOKING ELEMENTS (cont.)

- Use care when touching the cooktop. The glass surface of the cooktop will retain heat after the controls have been turned off.
- Be careful when placing spoons or other stirring utensils on the glass cooktop surface when it is in use. They may become hot and could cause burns.
- Use proper pan sizes. This appliance is equipped with surface elements of different size. Select pots and pans that have flat bottoms large enough to cover the surface area of the heating element. Using undersized cookware will expose a portion of the heating element to direct contact and may result in the ignition of clothing. Matching the size of the pot or pan to the element will also improve efficiency.
- Utensil handles should be turned inward and not extended over adjacent surface elements – To reduce the risk of burns, ignition of flammable materials, or spillage due to unintentional contact with utensils, position utensil handles so that they are turned inward and do not extend over adjacent surface elements.
- Glazed cooking utensils – Only certain types of glass, glass/ceramic, ceramic, earthenware, or other glazed cookware can be used for range top service without breaking due to sudden changes in temperature.
- Cleaning – Read and follow all instructions and warnings on the cleaning cream labels.
- Be sure you know which control knob operates each surface element. Make sure you turned on the correct surface element.
- Always turn the surface elements off before removing cookware.
- When preparing flaming foods under the hood, turn the fan on.
- Keep an eye on foods being fried at high or medium high heat settings.
- Do not store heavy items above the cooktop surface that could fall and damage it.
- Do not use decorative surface element covers – If an element is accidentally turned on, the decorative cover will become hot and possibly melt. Burns will occur if the hot covers are touched. Damage may also be done to the cooktop.

ELECTRICAL SAFETY

- **PROPER INSTALLATION** - Be sure your appliance is properly installed and grounded by a qualified technician.
- Flush-mounted appliances may be operated only after they have been installed in cabinets and workplaces that conform to the relevant standards. This ensures that the appliances are installed in compliance with the appropriate safety standards.
- If your appliance malfunctions or if fractures, cracks, or splits appear:
 - Switch off all cooking zones
 - Unplug the range from the AC wall outlet
 - Contact your local service center.



WARNING

If the surface is cracked, switch off and unplug the appliance to avoid the possibility of electrical shock. Do not use your cooktop until the glass surface has been replaced.



WARNING

- Disconnect the range from AC power or turn off its breaker circuit before replacing the lamp to avoid the possibility of electric shock.
- The range should not be placed on a base.

CHILD SAFETY



WARNING

- This appliance is not intended for use by young children or infirm persons without the adequate supervision of a responsible adult.
- Young children should be supervised to ensure that they do not play with the appliance.

ADDITIONAL SAFETY INSTRUCTIONS

CHILD SAFETY (cont.)

- Keep children away from the door when opening or closing it as they may bump themselves on the door or catch their fingers in the door.
- The cooking zones will become hot when you cook. To keep small children from being burned, always keep them away from the appliance while you are cooking.



WARNING

- Accessible parts may become hot during use. To avoid burns, young children should be kept away.

OVEN

- **DO NOT TOUCH THE HEATING ELEMENTS OR INTERIOR SURFACES OF THE OVEN.** Heating elements may be hot even though they are dark in color. Interior surfaces of an oven become hot enough to cause burns. During and after use, do not touch or let clothing or other flammable materials contact the heating elements or interior surfaces of the oven until they have had sufficient time to cool. Other surfaces of the appliance may become hot enough to cause burns. Among these surfaces are oven vent openings and surfaces near these openings, the oven door, and the window of the oven door.
- Do not heat unopened food containers. The build-up of pressure may cause the container to burst and result in injury.
- Do not use the oven for a storage area. Items stored in an oven can ignite.
- Use care when opening the door. Let hot air or steam escape before you remove food from or put food into the oven.
- Protective liners. Do not use aluminum foil to line the oven bottoms. Improper installation of these liners may result in a risk of electric shock or fire.
- Keep oven vent ducts unobstructed. The oven vent is located above the right rear surface element. This area could become hot during oven use. Never block this vent or place plastic or heat-sensitive items on it.
- Placement of oven racks. Always place oven racks in the desired location while the oven is cool. If the rack must be moved while the oven is hot, use potholders. Do not let the potholders come in contact with the hot heating element in the oven.
- Do not allow aluminum foil or a meat probe to contact the heating elements.
- During use, the appliance becomes hot. Care should be taken to avoid touching heating elements inside the oven.
- Do not use harsh abrasive cleaners or sharp metal scrapers to clean the oven door glass. They can scratch the surface which may result in the glass shattering.

VENTILATING HOOD

- Clean ventilating hoods frequently. Do not let grease accumulate on the hood or filter.
- When flaming foods are under the hood, turn the hood fan on.

GLASS/CERAMIC COOKING SURFACES

- **DO NOT TOUCH SURFACE ELEMENTS OR AREAS NEAR ELEMENTS.** Surface elements may be hot even though they are dark in color. Areas near surface elements may become hot enough to cause burns. During and after use, do not touch, or let clothing or other flammable materials contact the surface elements or areas near the elements until they have had sufficient time to cool. Among these areas are the cooktop and areas directly facing the cooktop.
- Do not cook on a broken cooktop. If the cooktop should break, cleaning solutions and spillovers may penetrate the broken cook-top and create a risk of electric shock. Contact a qualified technician immediately.
- Clean the cooktop with caution. If a wet sponge or cloth is used to wipe spills on a hot cooking area, be careful to avoid steam burns. Some cleaners can produce noxious fumes if applied to a hot surface.

ADDITIONAL SAFETY INSTRUCTIONS

CRITICAL INSTALLATION WARNINGS



WARNING

- This appliance must be installed by a qualified technician or service company. - Failing to have a qualified technician install the range may result in electric shock, fire, an explosion, problems with the product, or injury.
- Unpack the oven, remove all packaging material and examine the oven for any damage such as dents on the interior or exterior of the oven, broken door latches, cracks in the door, or a door that is not lined up correctly. If there is any damage, do not operate the oven and notify your dealer immediately.
- Plug the power cord into a properly grounded outlet with the proper configuration. Your oven should be the only item connected to this circuit.
- Keep all packaging materials out of the reach of children. Children may use them for play and injure themselves.
- Install your appliance on a level and hard floor that can support its weight. - Failing to do so may result in abnormal vibrations, noise, or problems with the product.
- This appliance must be properly grounded.
- Do not ground the appliance to a gas pipe, plastic water pipe, or telephone line.
- This may result in electric shock, fire, an explosion, or problems with the product.
- Do not cut or remove the ground prong from the power cord under any circumstances.
- Connect the range to a circuit that provides the correct amperage.
- Do not install this appliance in a humid, oily, or dusty location, or in a location exposed to direct sunlight or water (rain drops). - This may result in electric shock or fire.
- Do not use a damaged power cord or loose wall socket. - This may result in electric shock or fire.
- Do not pull or excessively bend the power cord.
- Do not twist or tie the power cord.
- Do not hook the power cord over a metal object or insert the power cord between objects. - This may result in electric shock or fire.
- If the power cord is damaged, contact your nearest service center.



CAUTION

- If the appliance is flooded by any liquid, disconnect the appliance from power by turning off the circuit breaker that is powering it. Please contact your nearest service center. Failing to do so may result in electric shock or fire.
- If the appliance produces a strange noise, a burning smell, or smoke, unplug the power plug immediately and contact your nearest service center. - Failing to do so may result in electric shock or fire.
- Do not touch the power cord. Do not touch the appliance. - A spark may result in an explosion or fire.
- Do not touch the power cord. Do not touch the appliance. - A spark may result in an explosion or fire.
- Take care not to contact the oven door, heating elements, or any of the other hot parts with your body while cooking or just after cooking. - Failing to do so may result in burns.
- If materials inside the oven should ignite, keep the oven door closed, turn the oven off and disconnect the power cord, or shut off power at the fuse or circuit breaker panel. If the door is opened, the fire may spread.
- Always observe safety precautions when using your oven. Never try to repair the oven on your own - there is dangerous voltage inside. If the oven needs to be repaired, contact an authorized service center near you.
- If you use the appliance when it is contaminated by foreign substances such as food waste, it may result in a problem with the appliance.
- Take care when removing the wrapping from food taken out of the appliance. - If the food is hot, hot steam may be emitted abruptly when you remove the wrapping and this may result in burns.

ADDITIONAL SAFETY INSTRUCTIONS

CRITICAL INSTALLATION WARNINGS (cont.)

- Do not attempt to repair, disassemble, or modify the appliance yourself. - Since a high voltage current enters the product chassis, it may result in electric shock or fire. - When a repair is needed, contact your nearest service center.
- If any foreign substance such as water has entered the appliance, contact your nearest service center. - Failing to do so may result in electric shock or fire.
- Do not touch the power cord with wet hands. - This may result in electric shock.
- Keep all packaging materials well out of the reach of children, as packaging materials can be dangerous to children. - If a child places a plastic bag over their head, the child can suffocate.
- Do not let children or any person with reduced physical, sensory, or mental capabilities use this appliance unsupervised.
- Make sure that the appliance's controls and cooking areas are out of the reach of children. - Failing to do so may result in electric shock, burns, or injury.
- Do not touch the inside of the appliance immediately after cooking. The inside of the appliance will be hot. - Failing to do so may result in burns.
- Do not use or place flammable sprays or objects near the oven. - Flammable items or sprays can cause fires or an explosion.
- Do not insert fingers, foreign substances, or metal objects such as pins or needles into inlets, outlets, or holes. If foreign substances are inserted into any of these holes, contact your product provider or nearest service center.
- Any adjustments or repairs to the oven door must be done by a licensed professional.
- Do not tamper with or make any adjustments or repairs to the door. Under no circumstances should you remove the door or outer shell of the oven.
- Do not store or use the oven outdoors.
- Never use this appliance for purposes other than cooking. - Using the appliance for any purpose other than cooking may result in fire.
- Open the cap or stopper of sealed containers (herb tonic tea bottle, baby bottle, milk bottle and so on) before heating them. Make a hole in food items that have shells (eggs, chestnuts, etc) with a knife before cooking them. - Failing to do so may result in burns or injury.
- Never heat plastic or paper containers and do not use them for cooking. - Failing to do so may result in fire.
- Do not heat food wrapped in paper from magazines, newspapers, etc. - This may result in fire.
- Do not open the door when the food in the oven is burning. - If you open the door, it causes an inflow of oxygen and may cause the food to ignite.
- Do not apply excessive pressure to the door or the inside of the appliance. Do not strike the door or the inside or the appliance.
- Hanging on to the door may result in the product falling and cause serious injury.
- If the door is damaged, do not use the appliance. Contact a service center.
- Do not hold food in your bare hands during or immediately after cooking.
- Use cooking gloves. The food may be very hot and you could burn yourself.
- Handle and oven surfaces may be hot enough to cause burns after cooking.



CAUTION

USAGE CAUTIONS

- If the surface is cracked, turn the appliance off. - Failing to do so may result in electric shock.
- Dishes and containers can become hot. Handle with care.
- Hot foods and steam can cause burns. Carefully remove container coverings, directing the steam away your hands and face.
- Take care as beverages or food may be very hot after heating, especially when feeding a child. Check that it has cooled sufficiently.
- Take care when heating liquids such as water or other beverages.
 - Make sure to stir during or after cooking.
 - Avoid using a slippery container with a narrow neck.
 - Wait at least 30 seconds after heating before removing the heated liquid.

ADDITIONAL SAFETY INSTRUCTIONS

USAGE CAUTIONS (cont.)

- Failing to do so may result in an abrupt overflow of the contents and cause burns.
- Do not stand on top of the appliance or place objects (such as laundry, oven cover, lighted candles, lighted cigarettes, dishes, chemicals, metal objects, etc.) on the appliance.
 - Items, such as a cloth, may get caught in the door.
 - This may result in electric shock, fire, problems with the product, or injury.
- Do not operate the appliance with wet hands. - This may result in electric shock.
- Do not spray volatile substances such as insecticide onto the surface of the appliance. - As well as being harmful to humans, it may also result in electric shock, fire, or problems with the product.
- Do not put your face or body close to the appliance while cooking or when opening the door just after cooking.
- Take care that children do not come too close to the appliance. - Failing to do so may result in children burning themselves.
- Do not place food or heavy objects over the edge of the oven door. - If you open the door, the food or object may fall and this may result in burns or injury.
- Do not abruptly cool the door, the inside of the appliance, or a dish by pouring water over it during or just after cooking. - This may result in damage to the appliance. The steam or water spray may result in burns or injury.
- Do not operate while empty except for self-cleaning.
- Do not scratch the glass of the oven door with a sharp object. - This may result in the glass being damaged or broken.
- Do not store anything directly on top of the appliance when it is in operation.
- Do not use sealed containers. Remove seals and lids before cooking. Sealed containers can explode due to the build up of pressure even after the oven has been turned off.
- Take care that food you are cooking in the oven does not come into contact with the heating element. - This may result in fire.
- Do not overheat food. - Overheating food may result in fire.

CRITICAL CLEANING WARNINGS



CAUTION

- Do not clean the appliance by spraying water directly on to it.
- Do not use benzene, thinner, or alcohol to clean the appliance. - This may result in discoloration, deformation, damage, electric shock, or fire.
- Take care not to hurt yourself when cleaning the appliance (externally or internally). - You may hurt yourself on the sharp edges of the appliance.
- Do not clean the oven with a steam cleaner. Instead use the appliance's built-in steam cleaning function. - This may result in corrosion.
- Keep the inside of the oven clean. Food particles or spattered oils stuck to the oven walls or floor can cause paint damage and reduce the efficiency of the oven.

SAVE THESE INSTRUCTIONS

SPECIFICATIONS

Dimensions (H×W×D)	46.9 to 47.9 × 29.9 × 26.9 in. (119.1 to 121.7 × 75.9 × 68.3 cm)
Weight	GW: 175.8 lbs. (79.4 kg) / NW: 153.4 lbs. (69.6 kg)
Power requirements	208 ~ 240 VAC, 60 Hz, 43A
Cooktop elements	Right Front: 2100 W Left Front: 2100 W Right Rear: 1200 W Left Rear: 1200 W
Oven element	Hidden Bake Element: 3000W Broil Element: 3500W
Oven temperatures	Bake: 175 ~ 550° F (79 ~ 288° C)
Oven light	40 W Halogen type, designed for oven use

PRODUCT OVERVIEW

PACKAGE CONTENTS

- 1 x electric range
- 1 x anti-tip device
- 4 x ST 5x40 mm screws
- 1 x oven handle
- 1 x hex wrench
- 2 x oven racks
- 2 x back plastic pads
- 2 x ST 5x20 mm screws
- 1 x User Guide

MAIN COMPONENTS

- 1 Oven Control Panel
- 2 Glass Surface
- 3 Oven Door
- 4 Storage Drawer
- 5 Surface Control Knob
- 6 Oven Light
- 7 Thermocouple
- 8 Oven Layer
- 9 Gasket

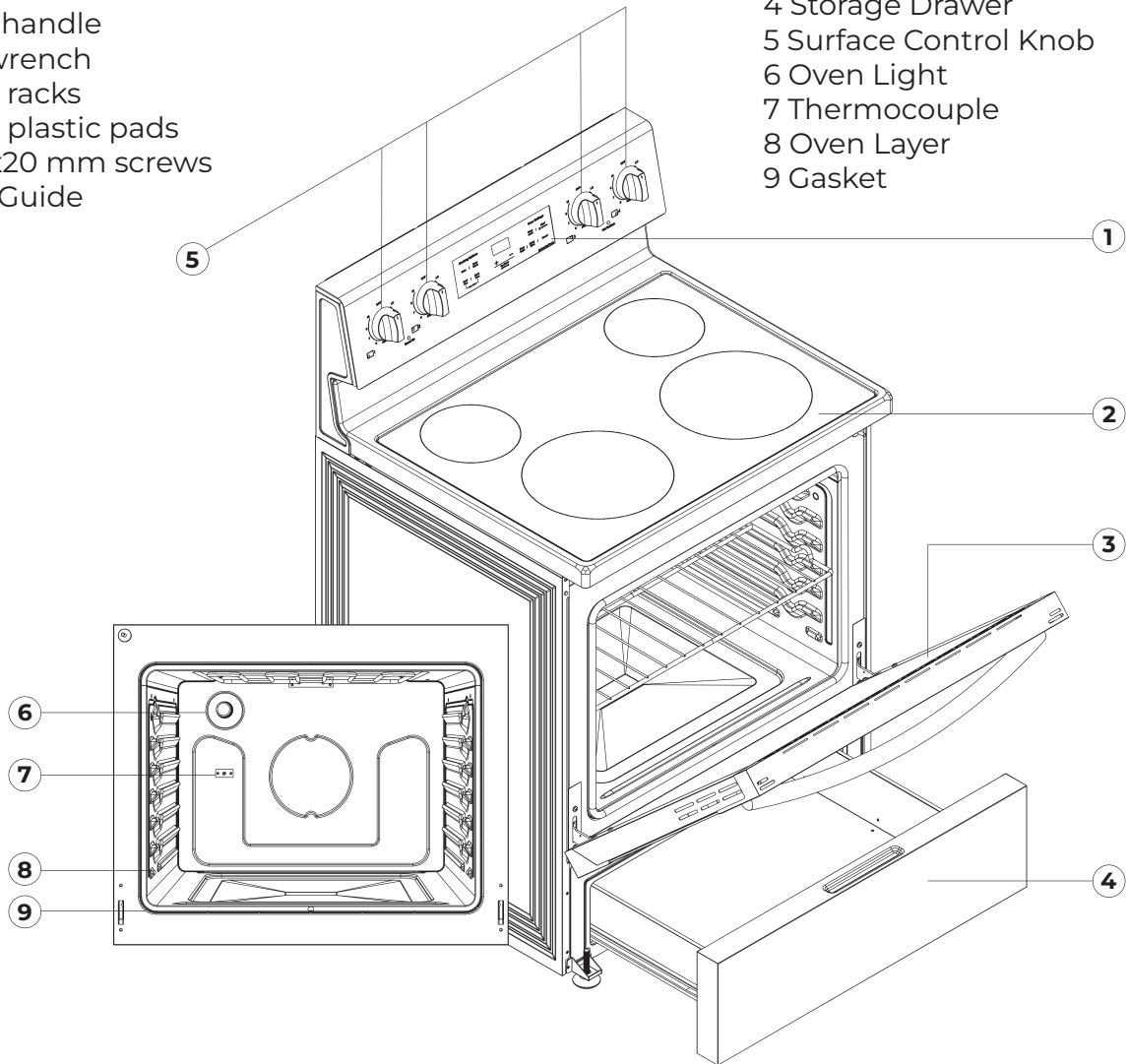



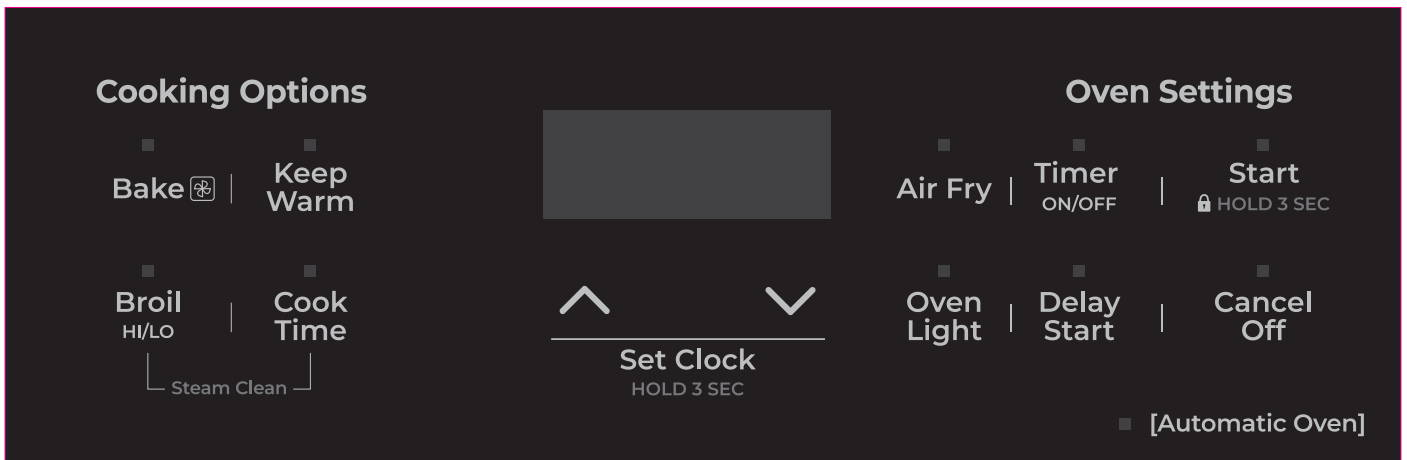

















OVEN CONTROL PANEL



PRODUCT OVERVIEW

OVEN CONTROL PANEL

TOUCHPAD	DESCRIPTION
Bake	Cooks food using the top and bottom oven heating elements. Press once to turn on BAKE mode. Use  and  to set the desired temperature from 150°F to 550°F (66°C to 288°C) and press START to begin preheating. Press and hold for 3 seconds to switch between Fahrenheit and Celsius and press START to confirm the change.
Broil	Cooks food using only the top oven heating element. Press once to enter Hi (high heat) mode, press again to change to Lo (low heat) mode, and press Start to begin broiling.
Keep Warm	Keeps cooked foods warm at a low baking temperature of 175°F(79°C) for up to three hours. Press once to turn on Keep Warm mode and press Start to begin preheating.
Cook Time	Preheats and cooks for a specified time and then turns off automatically. After setting the baking temperature, press once to enter timer cooking mode. Use  and  to enter the desired time from 1 minute to 10 hours and press START to begin preheating.
Delay Start	Delays the start of an automatic timer cooking program. Set the COOK TIME as above and then press DELAY START instead of START. Use  and  to enter the desired time from 1 minute to 10 hours and press START to begin the countdown.
Timer on/off	The kitchen timer sounds an alert after a specified amount of time but does not turn off the oven. Press once to turn on the kitchen timer, use  and  to enter the desired time, and press START to begin the countdown.
	Press to increase the value when setting a time or temperature.
	Press to decrease the value when setting a time or temperature.
Set Clock	Press  and  simultaneously to set the clock. The hours value will flash and you can use  and  to change it. Press  and  simultaneously again to switch to the minutes value and repeat. Press  and  simultaneously once more to confirm and exit the clock setting state. Press and hold  and  simultaneously for 3 seconds to switch between 12- and 24-hour format.
Oven Light	Press to turn the oven light on or off.
Start	Press to start the oven cooking, cleaning, or timing functions.
Cancel	Press to cancel the current operation.
Lock	Locks the oven control panel to prevent accidental or unauthorized operation. Press and hold for three seconds to disable the control panel and press and hold again to unlock.
Air Fry	Uses a convection fan to circulate hot air for faster cooking. Press once to turn on and press again to turn off.
Automatic Oven	Lights up when a cooking timer or delay start function is operating.
Steam Clean	Heats a small amount of water into steam to deep clean inside the oven. Press and hold BROIL and COOK TIME simultaneously for 3 seconds to enter STEAM CLEAN mode and then press START to begin. After 20 minutes, press CANCEL and wipe up any remaining water.

INSTALLATION

Selecting a location	14
Clearances and dimensions	14
Electrical requirements	15
Installing your range	16
Tools you need (not included)	16
Items not included	16
Notes to the installer	16
Before installing your range	17
Connecting the power cord	17
Installing the anti-tip device	20
Placing your range and connecting to power ..	20
Leveling your range	21
Finishing the installation	21
Installing the oven door handle	21
Installing the plastic pads	22

INSTALLATION

SELECTING A LOCATION

CLEARANCES AND DIMENSIONS

BEFORE YOU BEGIN to install your range, refer to the following information, dimensions, and clearances.

- Do not locate your range where it may be subject to strong drafts.
- Provide adequate clearances between your range and adjacent combustible surfaces.
- These dimensions must be met for safe use of your range.
- The location of the electrical outlet may be adjusted to meet the following dimensions and clearances.

For installation in Canada, a free-standing range is not to be installed closer than 4.7 in. (12 cm) from any adjacent surface.



CAUTION

- Your range has been designed to comply with the maximum allowable wood cabinet temperature of 194° F (90 °C).
- Make sure that the wall covering, counter tops, and cabinets around your range can withstand the heat (up to 194° F (90° C)) generated by your range. If not, discoloration, de-lamination, or melting may occur.

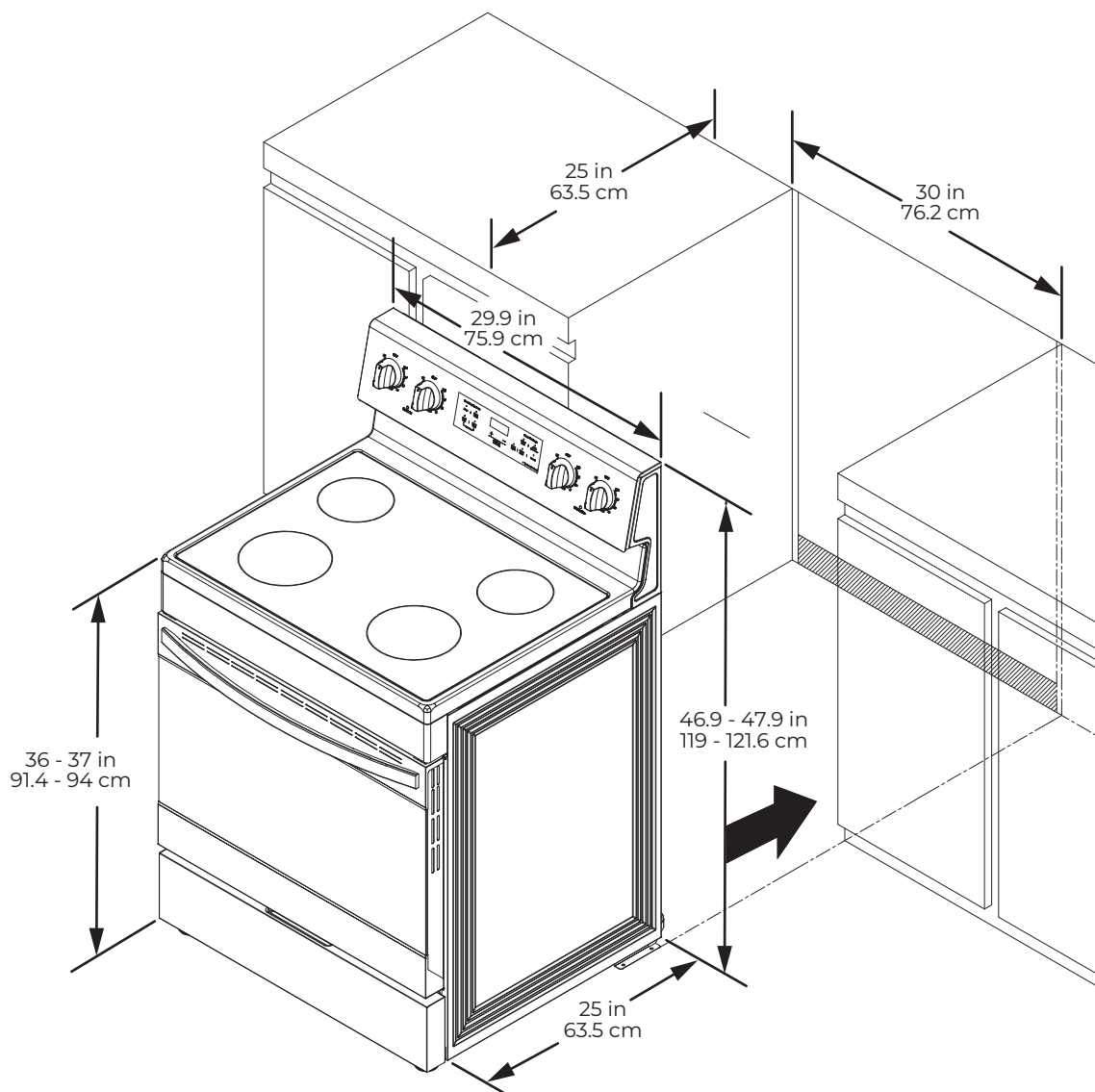

INSTALLATION

MINIMUM DIMENSIONS

- Make sure that the wall covering, countertop, flooring, and cabinets around your range can withstand the heat up to the 194° F (90° C) that your range generates.
- Allow a 30 in. (76.2 cm) minimum clearance between the surface elements and the bottom of unprotected wood or metal cabinets, or allow a 24 in. (61 cm) minimum when the bottom of the wood or metal cabinet is protected by no less than .25 in. (.6 cm) thick flame retardant mill board covered with not less than No. 28 MSG sheet steel, .015 in. (.038 cm) stainless steel, .024 in. (.061 cm) aluminum, or .020 in. (.051 cm) copper.
- Your range has been approved for 0 in. (0 cm) spacing to adjacent surfaces above the cooktop. However, we recommend a 6 in. (15.2 cm) minimum spacing to surfaces less than 15 in. (38.1 cm) above the cooktop and adjacent cabinet to reduce exposure to steam, grease splatter, and heat.
- To reduce the risk of burns or fire when reaching over hot surface elements, cabinet storage space above the cooktop should be avoided. If cabinet storage space is above the cooktop, the risk can be reduced by installing a range hood that projects at least 5 in. (12.7 cm) beyond the front of the cabinets. Cabinets installed above the cooktop must be no deeper than 16 in. (40.6 cm).

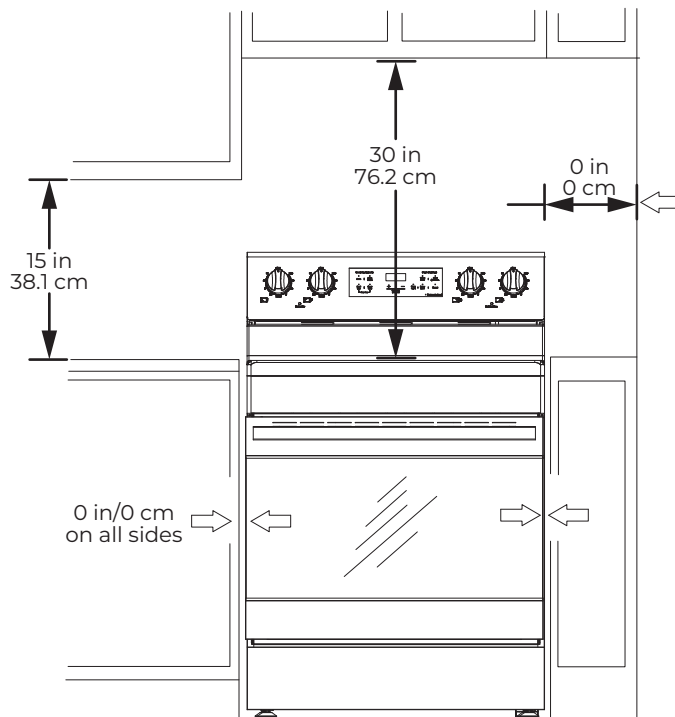

ELECTRICAL REQUIREMENTS

WARNING! To reduce the risk of fire, electric shock, or personal injury:

- Remove the house fuse or open the circuit breaker before beginning installation.
- Your range must be supplied with the correct voltage and frequency, and must be connected to an individual, correctly grounded branch circuit, protected by a circuit breaker or fuse having the amperage as specified on the rating plate located above the top panel of the bottom drawer.
- We recommend you have the electrical wiring and hookup of your range connected by a qualified electrician. After installation, have the electrician show you where your main range disconnect is located.
- Check with your local utilities for electrical codes which apply in your area. Failure to wire your oven according to governing codes could result in a hazardous condition. If there are no local codes, your range must be wired and fused to meet the requirements of the National Electrical Code, ANSI/NFPA No. 70–Latest Edition.

INSTALLATION

ELECTRICAL REQUIREMENTS (cont.)

Effective January 1, 1996, the National Electrical Code requires that new construction (non-existing) utilize a 4-conductor connection to an electric range.

- When installing an electric range in new construction, follow the instructions in Connect a 4-wire power cord on page 18.
- You must use a 3-wire or 4-wire, single-phase A.C. 208Y/120 volt or 240/120 volt, 60 hertz electrical system.
- If the electrical service provided does not meet the above specifications, have a licensed electrician install an approved outlet.
- Use only a 3-conductor or 4-conductor UL-listed range cord. These cords may be provided with ring terminals on the wires and a strain relief device.
- A range cord rated at 40 amps with a 125/250 minimum volt range is required. We do not recommend a 50 amp range cord, but if used, it should be marked for use with nominal 13.8 in. (35 cm) diameter connection openings. Make sure that you center the cable and strain relief within the knockout hole to keep the edge from damaging the cable.
- Because range terminals are not accessible after the range is in position, a flexible service conduit or cord must be used.

INSTALLING YOUR RANGE

WARNING! We recommend that a professional installer install your range.

If your range is not installed correctly, incorrect electrical grounding can cause a fire or explosion which can lead to injury or death.

TOOLS YOU NEED (not included)

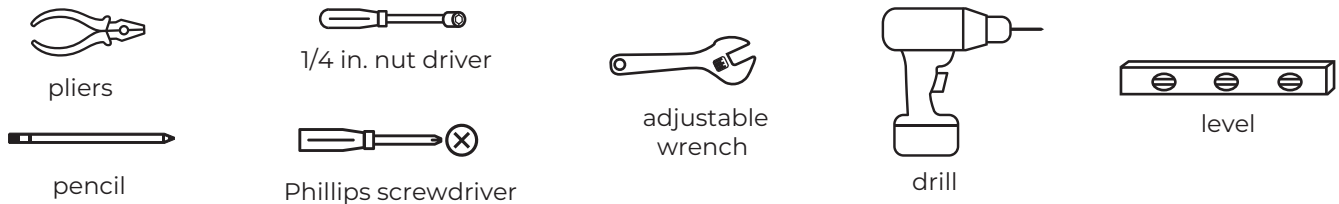

ITEMS NOT INCLUDED

- 4-wire or 3-wire power cord
- Strain relief

NOTES TO THE INSTALLER

1. Read this manual before installing your range.
2. Observe all governing codes and ordinances.
3. Make sure that you keep these instructions with your range.
4. Before installing your range in an area covered with linoleum or any synthetic floor covering, make sure that the floor covering can withstand temperatures of at least 180°F (82°C) without shrinking, warping, or discoloring.
5. Do not install your range over carpeting unless you place an insulating pad or sheet of 0.25 in. (0.6 cm) thick plywood between your range and carpeting.

INSTALLATION

BEFORE INSTALLING YOUR RANGE

1. Remove the exterior and interior packing.
2. Wipe the surfaces of your range with a damp cloth or sponge, then wipe them dry with a clean, dry cloth.

Range rating*		Specified rating of power supply cord kit and circuit protection
120/240 Volts	120/208 Volts	Amps
8.8 – 16.5 KW	7.8 – 12.5 KW	40 or 50**
16.6 – 22.5 KW	12.6 – 18.5 KW	50

- This range can be connected directly to the circuit breaker box (or fused disconnected) through flexible or nonmetallic sheathed, copper cable.
- Allow 2 to 3 ft (61 cm to 91.4 cm) of slack in the line so that the range can be moved if servicing is ever necessary.
- A UL listed conduit connector must be provided at each end of the power supply cable (at the range and at the junction box).
- Wire sizes and connections must conform with the rating of the range.
- The wiring diagram is located on the rear panel.

CONNECTING THE POWER CORD

WARNING!

- Electrical ground is required on your range.
- Do not connect to the electrical supply until your range is permanently grounded.
- Your range must be connected to a grounded, metallic, permanent wiring system, or a grounding connector should be connected to the grounding terminal or wire lead on your range.
- Failure to do any of the above could result in a fire, personal injury, or electrical shock.

REMOVE THE TERMINAL BLOCK COVER

1. Remove the two screws that secure the terminal block cover to the back of your range. Don't discard the screws. You need them to reinstall the cover.

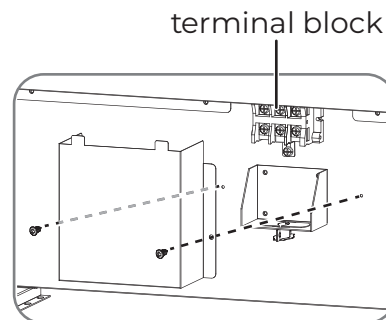
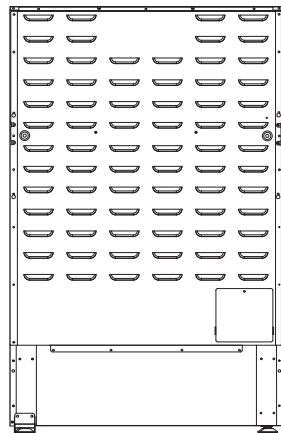

INSTALLATION

REMOVE THE TERMINAL BLOCK COVER (cont.,)

2. For the power cord installation, hook the strain relief over the 1-3/8 in. (3.5 cm) power cord hole located below the rear of the oven. Insert the power cord through the strain relief, then tighten the relief.

NOTE - You must install the power cord with a strain relief. Attach the strain relief to the opening in the conduit connection plate.

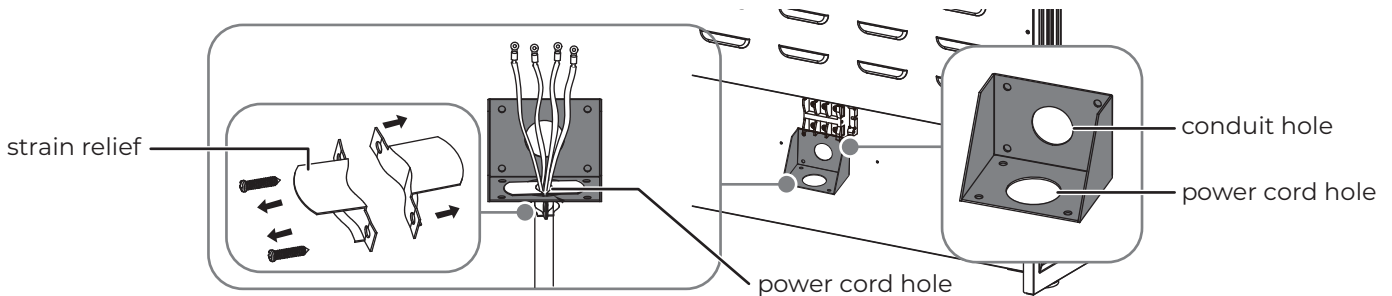

3. For the conduit installation, insert the conduit strain relief in the 1-1/8 in. (2.8 cm) conduit hole, then install the conduit through the body of the strain relief and fasten the strain relief with its ring.

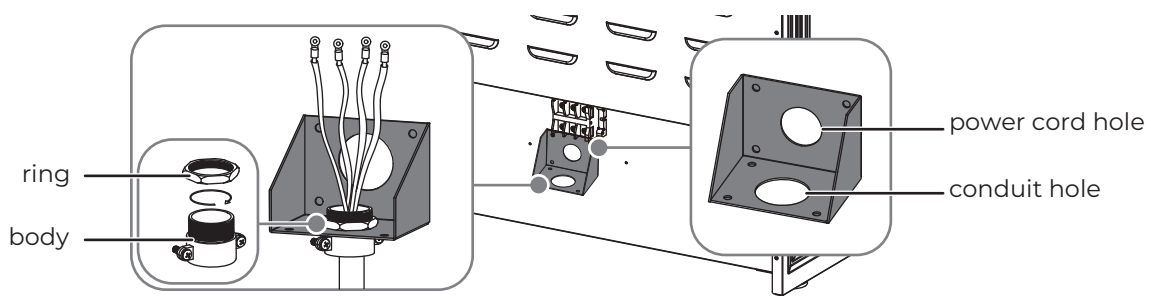

CONNECT A 4-WIRE POWER CORD

1. Disconnect power to the circuit breaker or fuse box before making the electrical connection.

2. Remove the three lower terminal screws from the terminal block and remove the ground screw.

3. Remove and discard the ground strap located between the middle terminal screw and the ground screw. Do not discard any screws.

4. Insert the ground screw into the power cord ground wire terminal ring and into the frame of the range.

5. Insert the three terminal screws (removed earlier) through each power cord terminal ring and into the lower terminals of the terminal block. Be certain that the center wire (white/neutral) is connected to the center position of the terminal block.

6. Reinstall and tighten screws securely to the terminal block.

7. **CAUTION!** Check the voltage after connecting the power cord.

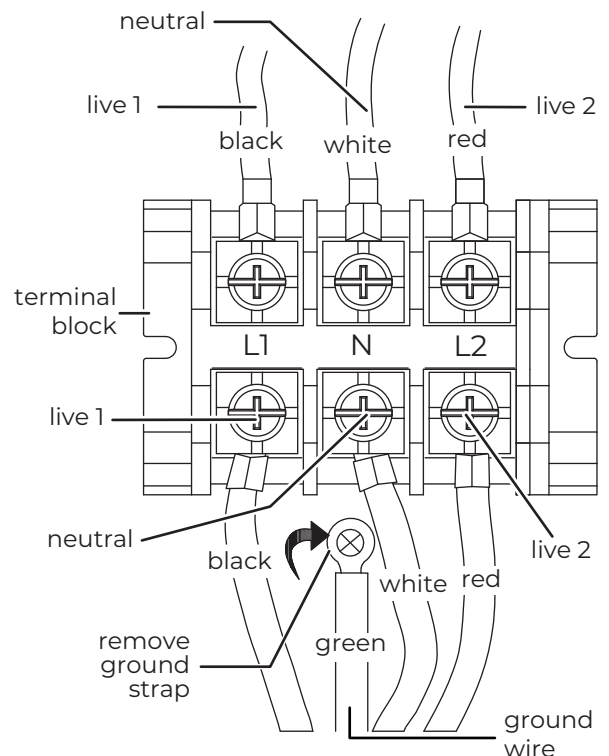

INSTALLATION

CONNECT A 4-WIRE POWER CORD (cont.)

Live 1 - Neutral	120 V
Live 2 - Neutral	120 V
Live 1 - Live 2	208 V / 240 V

8. Replace the terminal block cover. See below.

CONNECT A 3-WIRE POWER CORD

1 Remove the three lower terminal screws from the terminal block.

2 Insert the three terminal screws through each power cord terminal ring and into the lower terminals of the terminal

block. Be certain that the center wire (white/neutral) is connected to the center lower position of the terminal block.

3 Tighten screws securely to the terminal block. DO NOT remove the ground strap connection.

4 **CAUTION!** Check the voltage after connecting the power cord.

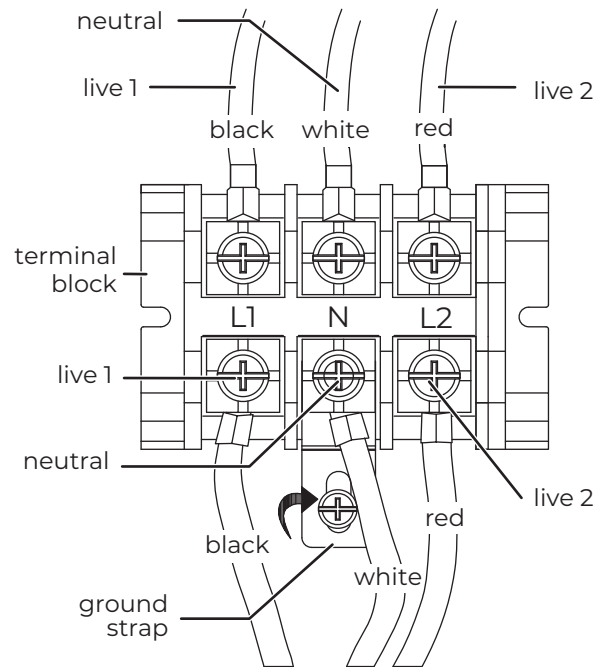

Live 1 - Neutral	120 V
Live 2 - Neutral	120 V
Live 1 - Live 2	208 V / 240 V

5. Replace the terminal block cover. See below.

REPLACE THE TERMINAL BLOCK COVER

1. Make sure that the cable is tightened in place using the strain relief.

2. Align the terminal block cover with the screw holes on the back of your range.

3. Insert the two screws you removed earlier through the holes in the cover and into the holes on the back of your range.

4. Tighten the screws.

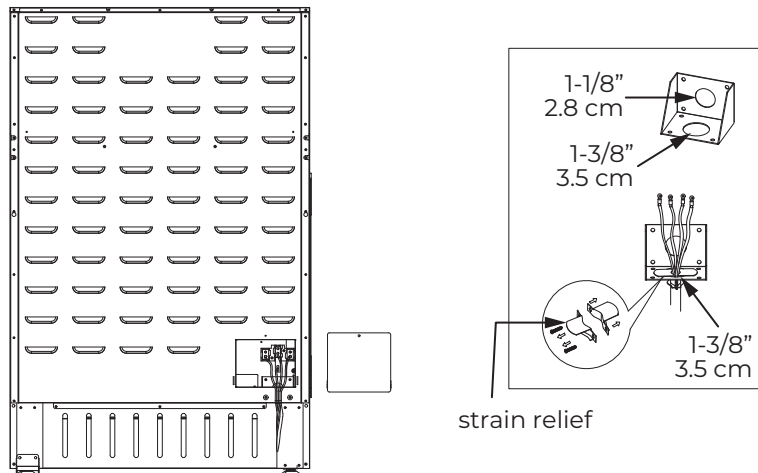

INSTALLATION

INSTALLING THE ANTI-TIP DEVICE

WARNING!

To reduce the risk of tipping, your range must be secured by the provided anti-tip device.

- All ranges can tip and cause personal injury.
- A child or adult can tip your range and be killed.
- Install the anti-tip device to your range and structure by following the installation instructions.
- Make sure that your range is connected to the anti-tip device installed to the structure.
- If you pull your range away from the wall for cleaning, service, or any other reason, make sure that the anti-tip device is correctly reengaged when you push your range back against the wall. In the event of abnormal usage (such as a person standing, sitting, or leaning on an open door), failure to take this precaution can result in tipping of your range. Personal injury might result from spilled hot liquids or from your range itself.
- Failure to follow these instructions can result in death or serious burns to children or adults.

An anti-tip bracket and screws with installation instructions came with your range. If the bracket is not installed correctly, your range could be tipped by you or a child standing, sitting, or leaning on an open oven door.

1. Release and extend the leveling leg to a minimum clearance of .7 in. (1.8 cm) between the range bottom and the floor.
2. Follow the instructions that came with the anti-tip device.

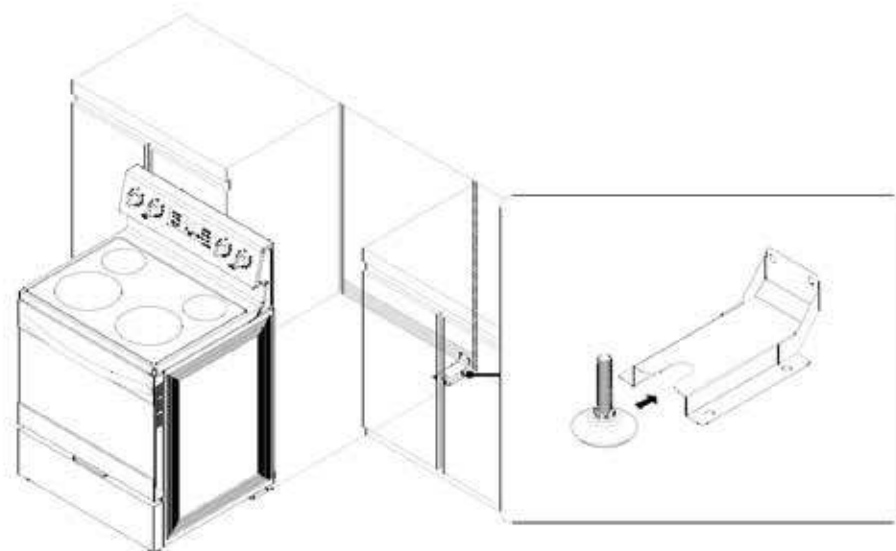

3. Remove the storage drawer and look underneath your range to make sure that the leveling leg is engaged in the bracket. See Removing and replacing the storage drawer on page 44.
4. Carefully tip your range forward. The bracket should stop your range within 4 in. (10.2 cm) of tipping. If it does not, you need to re-install the bracket.

PLACING YOUR RANGE AND CONNECTING TO POWER

1. Plug in the power cord. Make sure that the outlet meets local or national electrical codes.
2. Slide your range into place.
3. Make sure that the back leg of your range slid into the anti-tip bracket. Carefully tip your range forward to make sure that the anti-tip bracket prevents a tip-over.

INSTALLATION

LEVELING YOUR RANGE

Your range should be level. If your range is not level, the door may not close or seal correctly which can cause uneven heating and electric wastage problems.

NOTE

- To make it easier to adjust the feet, have someone push against the top of your range to tilt it slightly.
- Adjusting the two front legs is usually sufficient, but all four legs adjust if necessary.

1. Make sure that your range is positioned where you want it.
2. Using a wrench, level your range by turning the front leveling legs if necessary. Counterclockwise shortens the leg and lowers your range. Clockwise lengthens the leg and raises your range.

Adjust the leveling legs only as far as necessary to level your range. Extending the leveling legs more than necessary or removing the legs can make your range unstable.

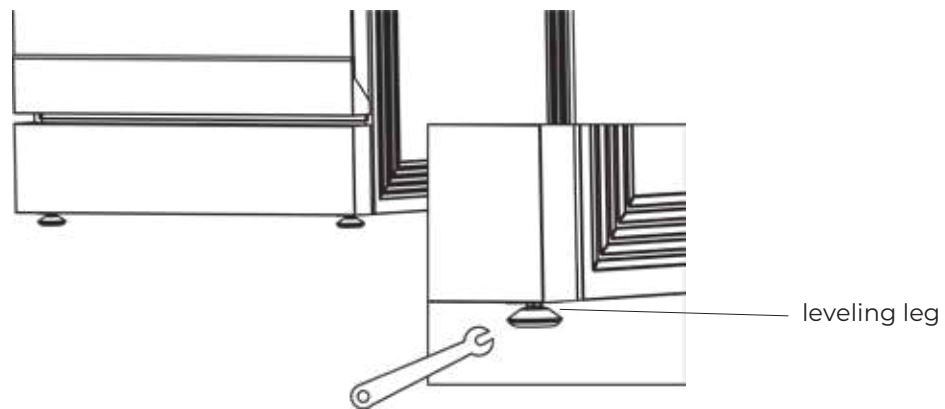

3. If your range is next to or between cabinets, make sure that the cooktop is level with the counter tops.

FINISHING THE INSTALLATION

1. Move your range close enough to the power outlet you plan to use, then plug in the power cord.
2. Slide your range into position. Make sure that the rear left (or rear right) leg slides under the anti-tip bracket. Your range should sit 0.8 in. (2 cm) away from the back wall when correctly installed.
3. Carefully tip your range forward to make sure that the anti-tip bracket is installed correctly and prevents a tip-over.
4. Turn on the electrical power. Make sure that your range is working correctly. For more information, see OPERATING INSTRUCTIONS.

INSTALLING THE OVEN DOOR HANDLE

Your range may have a “KD handle” that you need to install.

1. Check your installation kits for the handle and hex wrench.

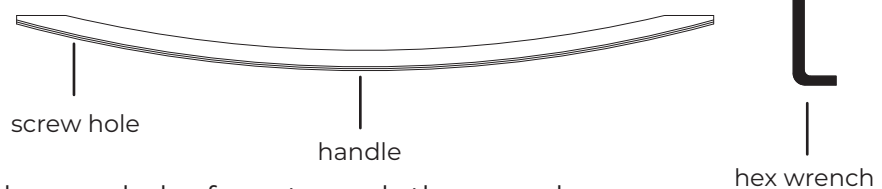

2. Make sure that the side with screw holes faces towards the oven door.

INSTALLATION

3. Place the door handle against to the oven door and fit it on the connection part.

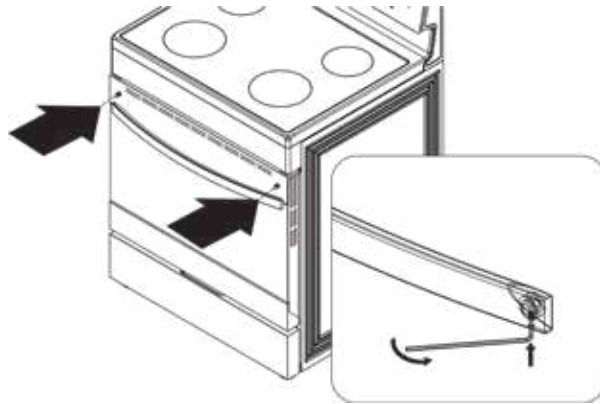

4. Use the Allen wrench to tighten both sides of the door handle.

INSTALLING THE PLASTIC PADS

To prevent your range from getting too close to the wall behind the range, install the included plastic pads.

1. Locate the plastic pad kit. It includes:

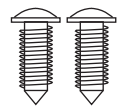

2 x screws



2 x plastic pads

2 Align the holes in the plastic pads with the holes on the top, back of your range, then secure the pads to your range with the provided screws.

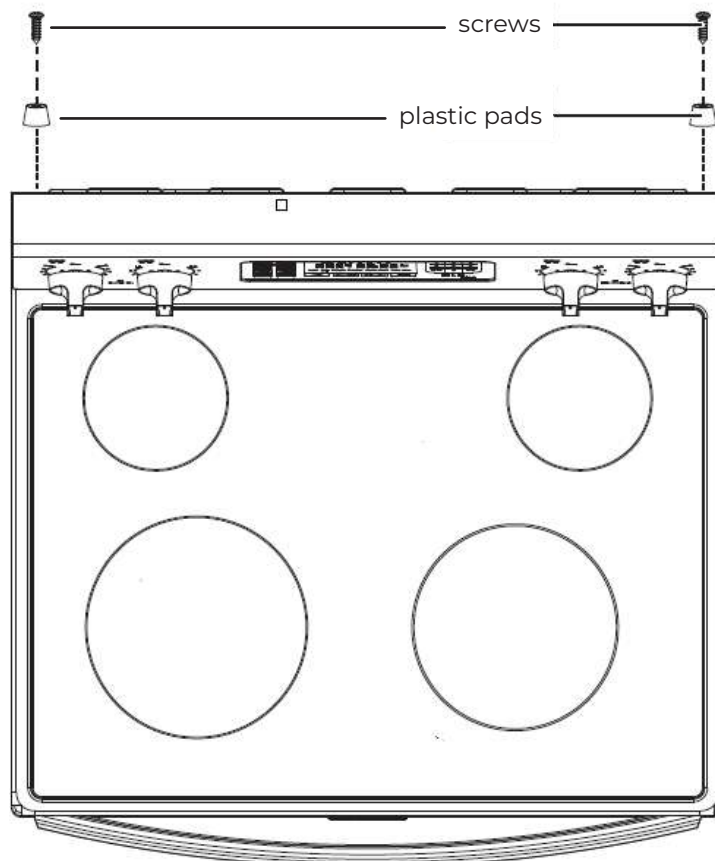

OPERATING INSTRUCTIONS

Before you begin using your range	24
Tips for saving energy	24
Using the surface burners	24
Identifying the burners	25
Cooking areas	25
Using a surface element control knob	26
Using the correct cookware	26
Protecting the ceramic cooktop	27
Using the oven	28
Minimum and maximum settings	28
Positioning the oven racks	29
Using the oven vent	30
Using the oven light	30
Tips for baking	30
Setting the clock	30
Selecting the 12-hour or 24-hour display setting	31
Using the timer	31
Baking	31
Adjusting the thermostat	32
Programming the cook time	32
Programming a delayed start time	33
Broiling	33
Air Fry	34
Keeping food warm	34
Switching between Fahrenheit and Celsius	34
Locking oven controls	34

OPERATING INSTRUCTIONS

BEFORE YOU BEGIN USING YOUR RANGE

WARNING! All electrical equipment with moving parts can be dangerous. Make sure that you read and understand all safety information. See IMPORTANT SAFETY PRECAUTIONS.

Before turning on the burners or oven:

- Remove all packaging materials.
- Wipe the surfaces of your range with a damp cloth or sponge, then dry with a clean, dry cloth.

CAUTION! Do not use harsh detergents, scouring powder, or any sharp objects to clean your range. These items can damage the surfaces of your range.

When you turn on an element or the oven for the first time, smoke and odors may be emitted. This is normal. Make sure that the room is well ventilated.

WARNING!

- Do not touch any hot surface on your range. Use oven gloves or potholders.
- Do not let children near your range.

TIPS FOR SAVING ENERGY

- During cooking, keep the oven door closed except when you turn food over.
- To maintain the oven temperature, do not open the door frequently during cooking.
- If cooking time is more than 30 minutes, switch the oven off 5 to 10 minutes before the end of the cooking time. The residual heat completes the cooking process.
- To reduce the time needed for re-heating the oven, plan oven use to avoid turning the oven off between cooking one item and the next.
- Whenever possible, cook more than one item at a time.

USING THE SURFACE BURNERS

WARNING!

- Before using the surface burners, make sure that you follow all the safety warnings and precautions as listed. Failure to do so could result in product damage, personal injury, or death.
- When you want to move a pot or pan onto another element, lift it up and place it on the other element. Do not slide a pot or pan from one element to another. Sliding can scratch surfaces.

CAUTION! Before cooking

- Do not use the glass cooktop surface as a cutting board.
- Do not place or store items that can melt or catch fire on the glass cooktop, even when it is not being used.
- Turn the surface burners on only after placing cookware on them.
- Do not store heavy items above the cooktop surface. They could fall and damage it.

CAUTION! While cooking

- Do not place aluminum foil or plastic items such as salt and pepper shakers, spoon holders, or plastic wrappings on your range when it is in use. The hot air from the vent could melt plastics or ignite flammable items.
- Make sure that you turn on the correct element.
- Never cook directly on the glass. Always use cookware.
- Always place a pan in the center of the surface element you are cooking on.
- Never leave surface burners unattended while using a high heat setting. Boilovers cause smoking and greasy spillovers that may catch on fire.

OPERATING INSTRUCTIONS

USING THE SURFACE BURNERS

CAUTION! While cooking (cont.)

- Turn the surface burners off before removing cookware.
- Do not use plastic wrap to cover food. Plastic may melt onto the surface and be difficult to remove

CAUTION: After cooking

- Do not touch the surface burners until they cool down.
- The surface may still be hot and burns may occur if you touch the glass surface before it has cooled down sufficiently.
- Immediately clean spills on the cooking area to prevent tough cleanup chores later.
- If cabinet storage is directly above the cooking surface, make sure that the items in the cabinet are used infrequently, and that they can be safely stored in an area subjected to heat. Temperatures may be unsafe for items such as volatile liquids, cleaners, or aerosol sprays.

The cooktop burners are radiant surface elements. When you turn on an element, the temperature rises gradually and evenly. As the temperature rises, the radiant element glows red.

To maintain the selected setting, the element cycles on and off. The heating element retains enough heat to help provide a more uniform and consistent heat during the off cycle. For efficient cooking, turn off the element several minutes before cooking is complete. This lets residual heat complete the cooking process.

NOTE

A radiant element has a limiter that lets the element cycle on and off, even at the HI setting. This is normal and helps prevent damage to the ceramic cooktop. Excessive cycling at the HI setting can occur if the cookware is too small for the radiant element or if the cookware bottom is not flat.

IDENTIFYING THE BURNERS

Your range cooktop has four surface burner. The different element sizes make sure that you have the correct heat source for each cooking job.

No.	Item	Description
1	Left Front	2100W
2	Left Rear	1200W
3	Right Rear	1200W
4	Right Front	2100W



COOKING AREAS

- The cooking areas on your range are identified by permanent circles on the glass cooking surface. For the most efficient cooking, fit the pan size to the element size.
- Pans should not extend more than .5 to 1 in. (1.3 to 2.5 cm) beyond the cooking area.
- When a control is turned on, you can see a glow through the glass cooking surface. The element cycles on and off to maintain the preset heat setting, even at high settings.
- For more information about the correct types of cookware, see USING THE CORRECT COOKWARE.

OPERATING INSTRUCTIONS

USING A SURFACE ELEMENT CONTROL KNOB

1. Push the knob in.
2. For the left and right burners, turn knob in either direction to the setting you want.

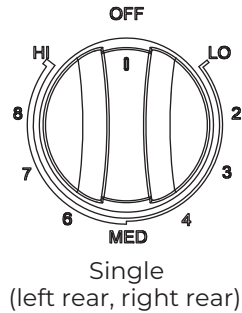

SETTING	TYPE OF COOKING
HIGH	Starting most foods, bringing water to a boil, or pan broiling
MEDIUM HIGH	Continuing a rapid boil, frying, deep fat frying, or steaming vegetables
MEDIUM	Maintaining a slow boil or thickening sauces and gravies
MEDIUM LOW	LOW Keeping foods cooking, poaching, or stewing
LOW	Keeping food warm or melting

USING THE CORRECT COOKWARE

Using the correct cookware can prevent many problems, such as uneven cooking or extended cooking times. Look for the following pan characteristics:

- Flat bottom and straight sides
- Tight-fitting lid
- Weight of handle does not tilt pan
- Pan is well-balanced
- Pan size matches the amount of food being prepared and the size of the surface element.
- Made of material that conducts heat well. See TYPES OF COOKWARE.

TYPES OF COOKWARE

What your cookware is made of determines how evenly and quickly heat is transferred from the surface element to the pan bottom.

MATERIAL	DESCRIPTION
Aluminum	Excellent heat conductor. Some types of food cause aluminum to darken.(Anodized aluminum cookware resists staining and pitting.) If you slide aluminum pans across the ceramic cooktop, they may leave metal marks that resemble scratches. Remove these marks as soon as the cook top cools down.
Copper	Excellent heat conductor, but discolors easily. If you slide copper pans across the ceramic cooktop, they may leave metal marks that resemble scratches. Remove these marks as soon as the cooktop cools down.
Stainless Steel	Slow heat conductor with uneven cooking results. It is durable, easy to clean, and resists staining.
Cast-iron	A poor conductor, but retains heat well. Cooks evenly once cooking temperature is reached. Not recommended for use on ceramic cooktops.
Enamelware	Heating characteristics vary depending on base material. Porcelain enamel coating must be smooth to avoid scratching ceramic cooktops.
Glass	Slow heat conductor. Not recommended for ceramic cooktops because it may scratch the glass.

OPERATING INSTRUCTIONS

PROTECTING THE CERAMIC COOKTOP

CLEANING

- Clean the cooktop before using it for the first time.
- Clean your cooktop daily or after each use. This helps keep your cooktop looking good and can prevent damage.
- If a spillover occurs while you are cooking, turn off the burner elements and immediately clean the spill from the cooking area while it is hot to prevent a tough cleaning chore later. Using extreme care, wipe the spill with a clean dry towel. Wear protective gloves or mitts to avoid burning yourself.
- Do not let spills remain on the cooking area or the cooktop trim for a long period of time.
- Do not use abrasive cleansing powders or scouring pads because they can scratch the cooktop.
- Do not use chlorine bleach, ammonia, or other cleansers not specifically recommended for use on a glass ceramic surface.

PREVENTING MARKS AND SCRATCHES

- Do not use glass cookware. It may scratch the cooktop.
- Do not place a trivet or wok ring between the cooktop and the pan. These items can mark or scratch the cooktop.
- Make sure that the cooktop and the pan bottoms are clean.
- Do not slide metal pans across the cooktop.

PREVENTING STAINS

- Do not use a soiled dish cloth or sponge to clean the cooktop surface. They may leave a film, which may cause stains on the cooking surface after the area is heated.
- Continuously cooking on a soiled surface can result in a permanent stain.

PREVENTING OTHER DAMAGE

- Do not let plastic, sugar, or foods with high sugar content melt onto the hot cooktop. Should this happen, clean immediately.
- Do not let a pan boil dry. This may damage the cooktop and the pan.
- Do not use the cooktop as a work surface or cutting board.

USING THE OVEN

MINIMUM AND MAXIMUM SETTINGS

WARNING! Stand away from the oven when opening the oven door. Escaping hot air or steam can burn your hands, face, or eyes. Let hot air or steam escape before removing or replacing food.

NOTE - Always bake or broil with the oven door closed. If you open the oven door while the oven is operating and leave it open, the oven element stops in one minute. This is not a product failure. The oven automatically starts again when you close the door.

OPERATING INSTRUCTIONS

MINIMUM AND MAXIMUM SETTINGS

FUNCTION PARAMETER LIST						
FUNCTION	TEMPERATURE			TIME		
	Default	Range	Unit	Default	Range	Unit
Bake	350	175-550	°F	10:00	00:01-10:00	HR/MIN
	177	79-288	°C			
Keep Warm	175	Not adjustable	°F	03:00	Not adjustable	HR/MIN
	79	Not adjustable	°C			
Steam Clean	150	Not adjustable	°F	00:25	Not adjustable	HR/MIN
	66	Not adjustable	°C			
Broil Hi	550	Not adjustable	°F	03:00	Not adjustable	HR/MIN
	288	Not adjustable	°C			
Broil Lo	400	Not adjustable	°F	03:00	Not adjustable	HR/MIN

OPERATING INSTRUCTIONS

POSITIONING THE OVEN RACKS

You can remove and reposition the oven racks in any of the six rack positions. Each oven rack has a built-in stop to prevent it from accidentally being pulled completely out. Correct positioning of the oven racks provides the best cooking results.

WARNING! Stand away from the oven when opening the oven door. Escaping hot air or steam can burn your hands, face, or eyes. Let hot air or steam escape before removing or replacing food.

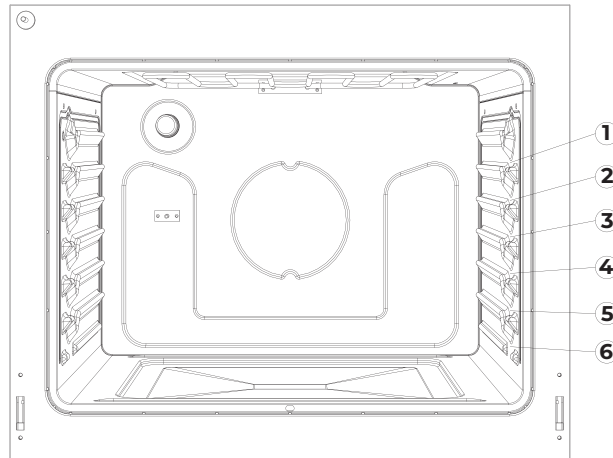

- Centering the baking pans in the oven produces better cooking results.
- When baking multiple items, make sure that you leave a 1 to 1.5 in. (2.5 to 3.8 cm) space around each item.
- When baking or fan baking on a single rack, place the oven rack in position 3 or 4.
- When baking or fan baking on multiple racks, place the oven racks in positions 3 and 5. Place two pans in the rear of the top rack and the other two pans in the front of the bottom rack.

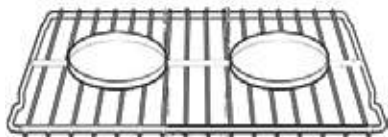

single rack pan placement

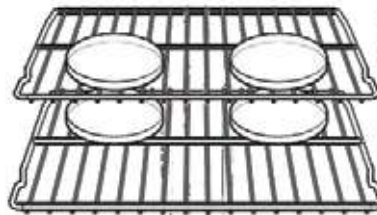

multi rack pan placement

CAUTION

- Do not cover an oven rack with aluminum foil. This disturbs the heat circulation and results in poor baking.
- Do not place aluminum foil on the oven bottom because it could cause damage.
- Arrange the oven racks only when the oven is cool.
- When placing an oven rack in the top most rack position, make sure that the rack is stably situated on the embossed stop.

REMOVING AN OVEN RACK

1. Pull the rack straight out until it stops.
2. Lift the front of the oven rack and pull to remove it from the oven.

REPLACING AN OVEN RACK

1. Place the back edge of the rack on the a rack support.
2. Lift the front of the rack and slide it into the oven.

OPERATING INSTRUCTIONS

USING THE OVEN VENT

- The oven vent is located above the right-rear surface element.
- The vent area can become hot during oven use.
- Steam coming out of the vent is normal.
- The vent is important for correct air circulation. Never block this vent.

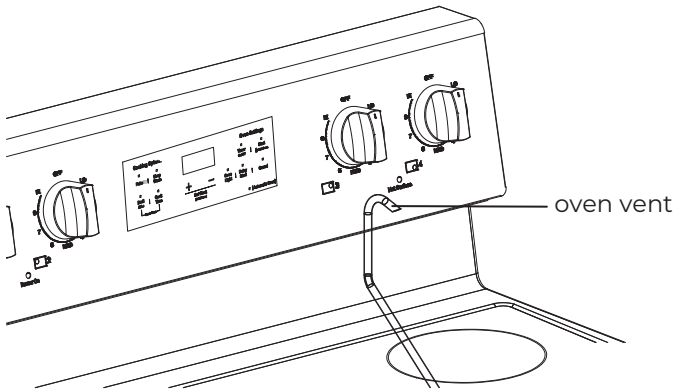

- Do not block or place items in front of the oven vent. Proper air circulation helps prevent combustion issues with the oven's heating element and ensures optimal cooking results.
- Because the oven vent and surrounding area can become hot, use care when placing items near the vent. Hot steam could heat or melt items placed in front of the vent.

USING THE OVEN LIGHT

The oven has a light that is located on the rear oven wall in the upper left rear corner.



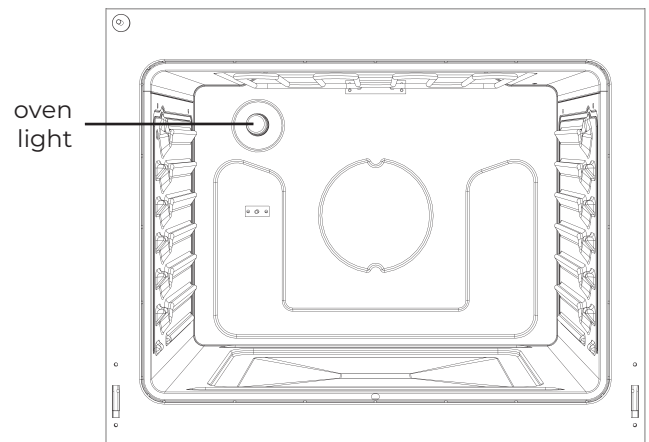











- Touch the OVEN LIGHT pad to turn the light on or off. The oven light lets you check the cooking progress without opening the oven door.



TIPS FOR BAKING



- Use appropriate non-stick coated metal sheets or aluminum containers or use heat-resistant silicone molds.
- Make the best use of the space on the rack. We recommend placing the baking pan in the middle of the rack.
- Select the correct rack position before turning the oven on.
- Do not move oven racks when hot. If you must move a rack while the oven is hot, do not let the potholder contact the hot oven element.
- Keep the oven door closed as much as possible.

SETTING THE CLOCK





- 1) In standby mode, short press  and  at the same time to enter the hour setting state. The hours will flash, and the minutes will stay on. Short press  or  to adjust by 1 hour and long press  or  to adjust by 10.
- 2) Once the hour is correct, short press  and  at the same time to change to the minute setting state. The hours will stay on and the minutes will flash. Short press  or  to adjust by 1 minute and long press  or  to adjust by 10.
- 3) When the minutes are correct, press  and  simultaneously to confirm the clock setting and return to standby mode.
- 4) The 12-hour time setting range is 1:00--12:59, and the 24-hour time setting range is 0:00--23:59.

OPERATING INSTRUCTIONS

SELECTING THE 12-HOUR OR 24-HOUR DISPLAY SETTING



- 1) In standby mode, press and hold  and  at the same time for 3 seconds to enter the clock 12/24 hour switching function. When the setting is successful, the buzzer will beep once.
- 2) Every time the clock enters the 12/24 hour switching state, switching between 12 and 24, the screen displays "12" or "24". Time synchronization is converted according to the current hour format.
- 3) After the clock switches to 12/24 hour format for 3 seconds, it enters standby mode.

USING THE TIMER

- 1) When the timer is not running, short press TIMER to enter the timing setting state. At this time, the TIMER indicator light is always on and the screen flashes "00:00". Short press  or  to adjust for 1 minute, long press  or  to adjust for 10 minutes.
- 2) In the timer setting state, short press TIMER to confirm the setting. The TIMER indicator light is always on, the screen is always on to display the time, and the countdown starts. If there is no operation within 60 seconds, exit the scheduled state. If the confirmation time is "00:00", exit the scheduled state.
- 3) When the timer is running, other cooking functions are also running. At this time, short press TIMER to switch to the timer time display, and after 3 seconds, it will switch to the other cooking function display.
- 4) When the timer ends, the buzzer will beep 10 times and the screen will flash and display "00:00". You can click any key to exit the timer state.
- 5) When the timer is running, press and hold TIMER for 3 seconds to exit the timer state, and the TIMER indicator light goes out.

BAKING

The BAKE function lets you program the oven to bake to any temperature between 150°F (66°C) and 550°F (288°C).

1. Position the oven rack where you want it.
2. Press the BAKE pad. The display blinks bake icon and shows of 350°. If the default temperature is the cooking temperature you want, skip to step 4.
3. (Optional) Press the  or  to enter the cooking temperature you want. The display blinks the temperature.
4. Press the START pad. The oven automatically turns on and starts preheating. Place food in the oven after preheating is complete. Preheating is important for good baking results. The display shows PRE, 100°, and BAKE icons until the oven reaches 100°. Then, the display shows the actual oven temperature. When the oven reaches the temperature you set, it beeps three times.
5. When baking is complete, remove the food from the oven, close the oven door, then press CANCEL. The oven shuts off and the display shows the time of day.
6. To change a programmed baking temperature, press BAKE, enter the new baking temperature, then press START. The oven completes cooking at the new temperature.

SELECTING BAKE or BAKE WITH CONVECTION

Bake = standard heat from top and bottom elements.

Conv-Bake = fan circulates hot air for faster, more even cooking.





- Make sure the oven is on.
- Press [Bake] to switch between Bake and Conv-Bake. The display will blink while switching.
- Check the [Bake] light:
 - Solid = Bake
 - Blinking = Conv-Bake
- Press [Bake] again to set the temperature.
- Set temperature.
- Set time (if needed).
- The oven starts in the selected mode.

OPERATING INSTRUCTIONS

ADJUSTING THE THERMOSTAT

If your baking results are not what you are used to, the present oven cooking thermostat can be adjusted by up to $\pm 35^{\circ}\text{F}$ ($\pm 19^{\circ}\text{C}$).

NOTE - This temperature adjustment is retained in memory after a power failure. This adjustment will be used in all future baking including Bake, Broil, and Keep Warm. Adjusting the thermostat does not affect steam-cleaning.

1) In standby mode, press and hold [Bake] and [Broil] at the same time for 3 seconds to enter the temperature adjusting setting. The screen flashes to display the compensation temperature, and the temperature unit remains consistent with the system temperature. Temperature setting range: $\pm 35^{\circ}\text{F}$ ($\pm 19^{\circ}\text{C}$). Short press  or  to adjust 1 value, and long press  or  to adjust 5 values. When the compensation temperature is $+5^{\circ}\text{F}$, "5F" is displayed, and when the compensation temperature is -5°F , "-5F" is displayed.

2) In the setting state, short press START to confirm and return to standby. If you do not press START within 30 seconds after setting, it will return to standby mode.

3) The compensation temperature does not affect the setting and display of the original operating temperature, but the temperature control is handled according to the compensation temperature. Compensation temperature is valid for all heating modes.

PROGRAMMING THE COOK TIME



The COOK TIME function lets you program the oven to cook food at a set temperature for a specified length of time. At the end of the set time, the oven automatically shuts off.

CAUTION - Use caution when using the COOKING TIME function. This function is best used when cooking cured or frozen meats and most fruits and vegetables. Foods that can easily spoil, like milk, eggs, fish, poultry, and meats, should be chilled in a refrigerator before they are placed in the oven. Even when chilled, they should not stand for more than one hour before cooking begins and should be removed promptly when cooking is completed. Eating spoiled food can result in sickness from food poisoning.

1. Position the oven rack in the location you want, then place the food in the oven and close the oven door.

NOTE - Place food in the oven after preheating if the recipe calls for it. Preheating is important for good baking results.

2. Press BAKE. The display shows the default temperature and the bake icon blinks. If the default temperature is the temperature you want, skip to step 4.



3. (Optional) Press COOK TIME pad and adjust the temperature by pressing  or  for the temperature you want. Preheating is important for good baking results.



4. Press the COOK TIME pad. The display will show 00:00.

5. Press the  or  for the cooking time you want. The display shows the selected time. You can set the time to any duration from 1 minute to 10 hours.

6. Press the START pad. The oven automatically turns on and starts preheating.

The display shows the default or selected temperature, BAKE, and selected cook time, until the oven reaches the temperature you set. When the oven reaches that temperature, it beeps three times. The oven starts cooking for the set amount of time, and the display shows the remaining cooking time.

7. To change the programmed baking temperature, press the BAKE pad, press  or  for new baking temperature, then press the START pad. The oven completes cooking at the new temperature.







8. To change the cooking time, press the COOK TIME pad, press  or , then press the START pad. The oven continues cooking for the remaining time you set.

OPERATING INSTRUCTIONS

PROGRAMMING A DELAYED START TIME

The DELAY START function lets you use the kitchen timer to automatically start and stop another cooking program.

CAUTION - Use caution when using the DELAY TIME function. This function is best used when cooking cured or frozen meats and most fruits and vegetables. Foods that can easily spoil, like milk, eggs, fish, poultry, and meats, should be chilled in a refrigerator before they are placed in the oven. Even when chilled, they should not stand for more than one hour before cooking begins and should be removed promptly when cooking is completed. Eating spoiled food can result in sickness from food poisoning.

1. Position the oven rack in the location you want, then place the food in the oven and close the oven door.
2. Press the pad for the baking operation you want. The display blinks the function icon and shows the default temperature (350°). If the default temperature is the temperature you want, skip to step 4.
3. (Optional) Press the  or  for the temperature you want. The display shows the temperature you set.
4. Press the COOK TIME pad. The display shows the cooking temperature, BAKE, and 00:00.
5. Press the  or  for the cooking duration you want. The display blinks the cooking duration you set. You can set the duration to any amount of time from 1 minute to 10 hours.
6. Press DELAY START. The display shows DELAY and 00:00 blinks.
7. Press  or  to enter the duration of time you want, duration to any amount of time from 1 minute to 10 hours.
8. Press START. The oven automatically turns on and starts preheating.
9. To change the programmed baking temperature, press BAKE, enter the new baking temperature, then press START. The oven completes cooking at the new temperature.
10. To change the cooking time, press COOK TIME, enter the new cooking time, then press START. The oven continues cooking for the remaining time you set.

BROILING





The BROIL function lets you cook and brown foods using only a top heat source. The oven door must remain closed during broiling. Meat or fish should always be placed on a broiling grid in a broiling pan.

WARNING! If an oven fire occurs, close the oven door and turn the oven off. If the fire continues, throw baking soda on the fire or use a foam-type fire extinguisher. Do not put water or flour on the fire. Flour may explode and water can cause a grease fire to spread. Both can cause personal injury or property damage.

1. Position the oven rack so that the top of the food is at least 3 to 5 inches (7.6 to 12.7 cm)
2. Place the food on a broiling pan with an insert grid and into the oven. Close the oven door.
3. Press BROIL once for Hi and twice for Lo. Use Lo to cook foods such as poultry or thick cuts of meat thoroughly without over browning them.
4. Press START. The oven automatically lights the top oven burner and starts cooking. The display shows the broil setting (Hi or Lo) you selected and BROIL. Broil on one side until food is browned, then turn and broil on the other side.
5. When broiling is completed, press OFF/CLEAR to shut off the oven. The display shows the time of day.
6. To change a programmed broiling setting, press BROIL to change the setting between Hi and Lo, then press START. The oven changes the broil setting and completes cooking at the new temperature.

OPERATING INSTRUCTIONS

AIR FRY

1. When not in operation, short press AIR FRY to enter this mode. The AIR FRY indicator light is always on and the screen flashes "425F". Press the ,  to enter the cooking temperature you want.
2. Short press START to confirm the temperature and enter the time setting state. At this time, the COOK TIME indicator light is always on, and the screen flashes "--:--" (indicating that the time is not set). At this time, you can adjust time by , .
3. After setting the time, short press START to enter the heating state. At this time, the COOK TIME indicator light is always on, the AUTOMATIC OVEN indicator light is always on, the START indicator light is always on, the countdown starts, and the screen is always on to display the time.
4. In the working state, short press AIR FRY to set the temperature or short press COOK TIME to set the time. In this setting state, the heating will continue, and the screen will flash to display the temperature or time. After adjustment, short press START to confirm and continue working, and the screen will always display the temperature or time.
5. When baking is complete, remove the food from the oven, close the oven door, then press CANCEL to enter standby mode.

KEEPING FOOD WARM

The KEEP WARM function lets you keep cooked foods warm at a low baking temperature for up to three hours.

- 1 Position the oven rack in the location you want, then place the food in the oven and close the oven door.
- 2 Press the KEEP WARM pad, then press the START pad. The oven automatically turns on and heats to 175°F (79°C). The display shows Warm and the time of day.
- 3 When warming is complete, press the CANCEL pad. The display shows the time of day.



SWITCHING BETWEEN FAHRENHEIT OR CELSIUS

You can program the oven control to display temperatures in Fahrenheit or Celsius. The oven was preset at the factory to display in Fahrenheit.

- 1 Press and hold the BAKE pad for three seconds. The display shows F or C. The default is F.
- 2 Press and hold the BAKE pad for three seconds to change between F and C.
- 3 Press the Start pad to save the temperature selection.

LOCKING OVEN CONTROLS

The LOCK function turns off the control panel touch pads to prevent the oven from accidentally being turned on. Touch pads stay locked until you turn this function off.

1. Press and hold the  and START for three seconds. The oven beeps and the display shows LOC, the time of day, and the lock icon.
2. To unlock the controls, press and hold the  and START for three seconds.

MAINTENANCE

Cleaning and maintenance	36
Using the oven vent	36
Cleaning the control panel	36
Cleaning painted parts and decorative trim	36
Cleaning stainless steel surfaces	36
Cleaning the oven racks	37
Cleaning the oven door	37
Cleaning the surface element control knobs	37
Cleaning the cooktop	38
Removing and replacing the oven door	39
Removing and replacing the storage drawer	42
Steam cleaning the oven	43
Troubleshooting	44
Control panel display	44
Cooktop	44
Oven	46
Drawer	48
Error codes	49

MAINTENANCE

CLEANING AND MAINTENANCE

WARNING

- Always make sure that the controls are off and all surfaces are cool before removing or cleaning any of the range parts. This will prevent you from getting burned.
- If your range is pulled out from the wall for any reason, make sure that the anti-tip device is reengaged after your range has been pushed back into place. Failure to take this precaution could result in your range tipping and personal injury.

CLEANING THE CONTROL PANEL

CAUTION

- Never use steel wool or abrasive cleansers.
 - Protect the surface from sharp objects. These items can damage the surface.
1. Lock the oven controls. See LOCKING OVEN CONTROLS.
 2. Clean spatters with a damp cloth or glass cleaner. You can use warm, soapy water to clean heavily soiled areas.
 3. When cleaning is done, unlock the oven controls.

CLEANING PAINTED PARTS AND DECORATIVE TRIM

- For general cleaning, use a cloth with hot, soapy water, then dry with a clean, dry, soft cloth.
- For more difficult residue and built-up grease, apply a liquid detergent directly onto the area and leave for 30 to 60 minutes. Wipe with a damp cloth and dry with a clean, dry, soft cloth.

CAUTION - Do not use a steel-wool pad or abrasive cleaners on stainless steel surfaces. Abrasive pads and cleaners will scratch the surface and damage the finish.

CLEANING STAINLESS STEEL SURFACES

CAUTION - Do not use a steel-wool pad or abrasive cleaners on stainless steel surfaces. Abrasive pads and cleaners will scratch the surface and damage the finish.

NOTE - To prevent any discolorations or grease stains, we recommend that you clean and remove any spills, spots, and grease from your range after each use.

1. Place a small amount of a stainless steel cleaner designed for use with appliances on a damp cloth or damp paper towel.
2. Clean a small area, rubbing with the grain of the stainless steel, if applicable.
3. Dry and buff with a clean, dry paper towel or soft cloth.
4. Repeat as necessary.

NOTE - If you previously used a mineral oil-based stainless steel appliance cleaner, wash the surface with dish washing liquid and water before using the stainless steel cleaner.

MAINTENANCE

CLEANING THE OVEN RACKS

CAUTION - Make sure that the oven racks ha dishwasher. They are not dishwasher-safe.

- 1 Pull a rack straight out until it stops.
- 2 Lift the front of the oven rack and pull to remove it from the oven.
- 3 Clean by hand in hot, soapy water with a plastic or soap-filled scouring pad or sponge, then dry with a soft cloth. Do not use steel wool,
- 4 To replace the rack, place the back edge of the rack on the a rack support, then lift the front of the rack and slide it into the oven. If a rack becomes difficult to slide, rub the side rails with wax paper or a cloth containing a small amount of cooking oil. This helps the rack slide more easily in the tracks.

CLEANING THE OVEN DOOR

CAUTION

- DO NOT clean the oven door gasket. The oven door gasket is made of a woven material which is essential for a good seal. Care should be taken not to rub, damage, or remove this gasket.
- DO NOT immerse the door in water.
- DO NOT spray or let water or the glass cleaner to enter the door vents.
- DO NOT use oven cleaners, cleaning powders, or any harsh abrasive cleaning materials on the outside of the oven door.

The oven door has multiple surfaces that require different cleaning techniques. The gasket on the oven door frame should never be cleaned or moved to clean other surfaces. The gasket is made of woven material which is essential for a good heat seal.

1. Clean the inside door surface by hand with hot, soapy water and a soapy plastic scouring pad. Do not let moisture get inside the door assembly.

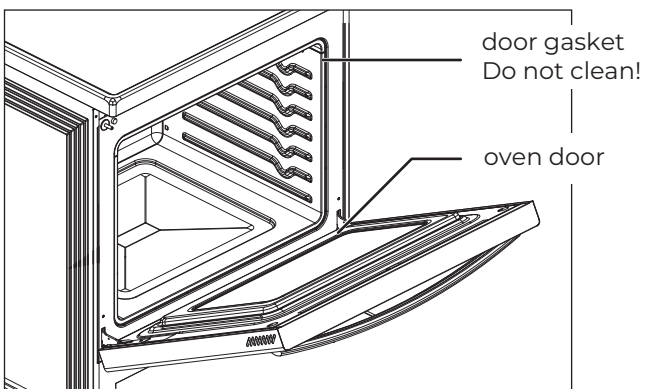

- 2 Rinse and dry thoroughly with a clean, soft cloth.
- 3 Clean the outside door stainless steel surfaces by following the instructions in **CLEANING STAINLESS STEEL SURFACES**.
- 4 Clean the glass window with glass cleaner or warm, soapy water with a thorough rinse. Do not let moisture get inside the door assembly.

CLEANING THE SURFACE ELEMENT CONTROL KNOBS

WARNING!

- Do not use spray cleaners on the surface element control panel. Spray entering the valve holes could contact electrical components resulting in death, personal injury, or product damage.
- The knobs and the valve stems must be completely dry before you reinstall them.

1. Make sure that all surface element knobs are in the OFF position.
2. Pull the control knobs straight off the surface element control valve stems. Do not clean the control knobs in a dishwasher. They are not dishwasher-safe.

MAINTENANCE

CLEANING THE SURFACE ELEMENT CONTROL KNOBS (cont.)

3. Clean the knobs in warm, soapy water. Rinse and completely dry all surfaces including back and stem hole.
4. Clean stainless steel surfaces with a stainless steel cleaner on a damp, soft cloth.
5. Replace the control knobs in the OFF position by pushing them straight onto the control valve stems.

CLEANING THE COOKTOP

The cooktop surface is a porcelain-enamel surface. To prevent this surface from becoming dull, wipe up and clean spills as they happen. Foods with a lot of acid (for example, tomatoes, sauerkraut, and fruit juices) or foods with high sugar content can cause dull spots if allowed to set.

CAUTION

- Do not use a steel-wool pad or abrasive cleaners on stainless steel surfaces. Abrasive pads and cleaners will scratch the surface and damage the finish.
- Carefully check the bottoms of pans for roughness that may scratch the cooktop.

NORMAL DAILY USE CLEANING

NOTE - Daily use of a ceramic cooktop cleaner helps keep the cooktop looking new.

Use only a ceramic cooktop cleaner. Other creams may not be as effective. By following these steps, you can maintain and protect the surface of the glass cooktop.

Before using the cooktop for the first time, clean it with a ceramic cooktop cleaner. This helps protect the top and makes cleanup easier.

1. Shake the cleaning cream well, then apply a few drops of cleaner directly on the cooktop.
2. Use a paper towel or a cleaning pad for ceramic cooktops to clean the entire cooktop surface.
3. Use a dry cloth or paper towel to remove all cleaning residue. You do not need to rinse.

CLEANING SUGARY SPILLS AND MELTED PLASTICS

NOTE

- If pitting or indentations in the glass surface have already occurred, they can't be repaired. The cooktop glass will have to be replaced.
- Sugary spillovers (such as jellies, fudge, candy, and syrups) or melted plastics can cause pitting of the cooktop surface. This is not covered under the warranty.
- You should clean the spill while it is still hot. Take special care when removing hot substances.
- When using a scraper, make sure that it is new and the razor blade is still sharp. Do not use a dull or nicked blade.

1. Turn off all surface burners. Remove hot pans.
2. Wearing an oven mitt, use a single-edge, razor-blade scraper to move the spill to a cool area of the cooktop. Remove the spill with paper towels.
3. Wait until the cooktop has cooled, then remove any remaining spillover. Don't use the surface burners again until all of the residue has been completely removed.

REMOVING BURNED-ON RESIDUE

1. Make sure that all surface burners are turned off, then let the cooktop cool.
2. Spread a few drops of ceramic cooktop cleaner on the entire burned residue area.

MAINTENANCE

REMOVING BURNED-ON RESIDUE (cont.)

3. Using a cleaning pad for ceramic cooktops, rub the residue area. Apply pressure as needed.
4. If any residue remains, repeat the steps listed above as needed.
5. For additional protection, after all residue has been removed, polish the entire surface with a ceramic cooktop cleaner and a paper towel.

REMOVING HEAVY, BURNED-ON RESIDUE

1. Make sure that all surface burners are turned off, then let the cooktop cool.
2. Use a single-edge, razor-blade scraper at approximately a 45° angle against the glass surface and scrape the residue. You need to apply pressure to remove the residue. Do not scrape the seal.
3. After scraping with the scraper, spread a few drops of ceramic cooktop cleaner on the entire burned residue area. Use the cleaning pad to remove any remaining residue.
4. For additional protection, after all residue has been removed, polish the entire surface with a ceramic cooktop cleaner and a paper towel.

CLEANING THE COOKTOP SEAL

- Lay a wet cloth on the seal for a few minutes, then wipe clean with a nonabrasive cleaner.

REMOVING AND REPLACING THE OVEN DOOR

WARNING

- We recommend that you do not remove the door unless directed to do so by Criterion Customer Service.
- The oven door is heavy. Do not lift the door by its handle. Be careful not to drop the door during removal. Incorrect handling could result in personal injury.
- Disconnect the electrical power to your range before removing the oven door. This prevents the oven from accidentally being turned on while the door is removed.

REMOVING THE DOOR

1. Completely open the oven door.

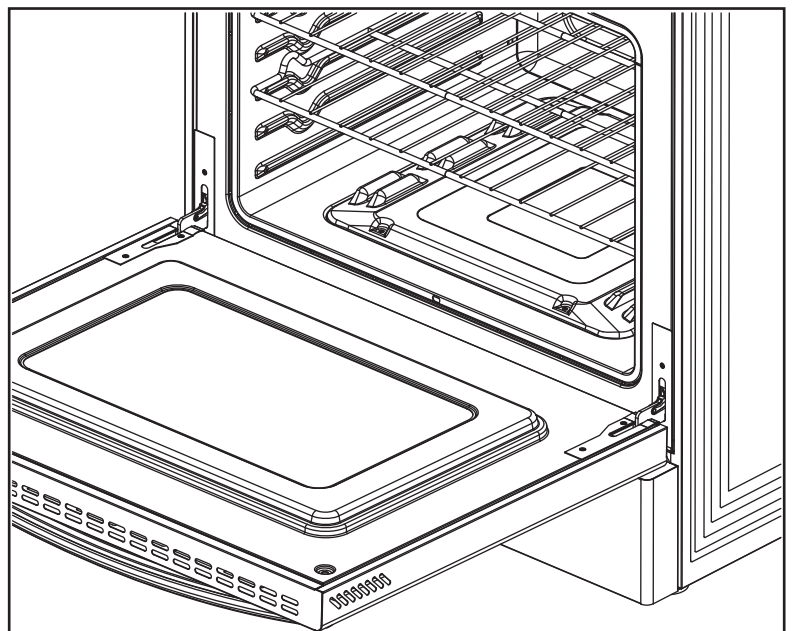

MAINTENANCE

REMOVING THE DOOR (cont.)

2. Open the levers fully on both sides.

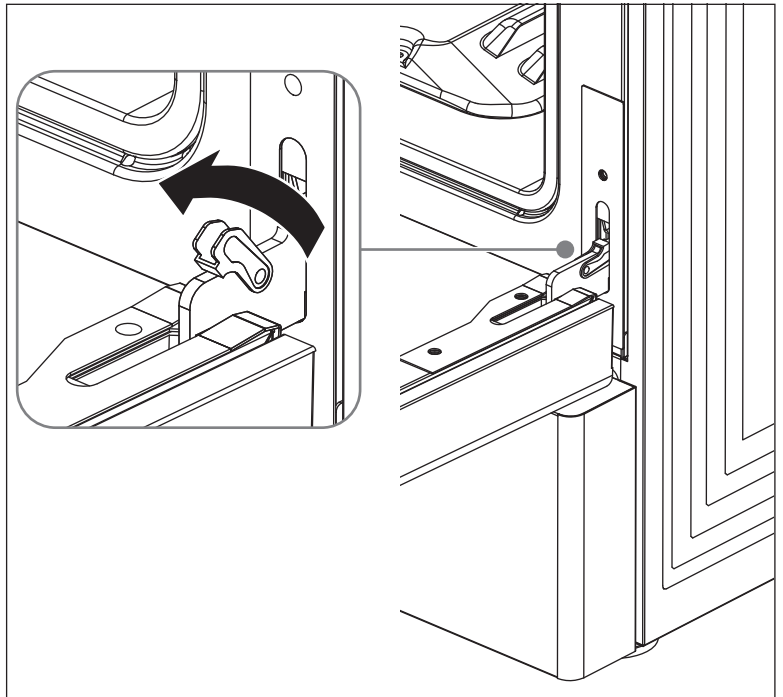

3. Hold the door firmly on both sides.

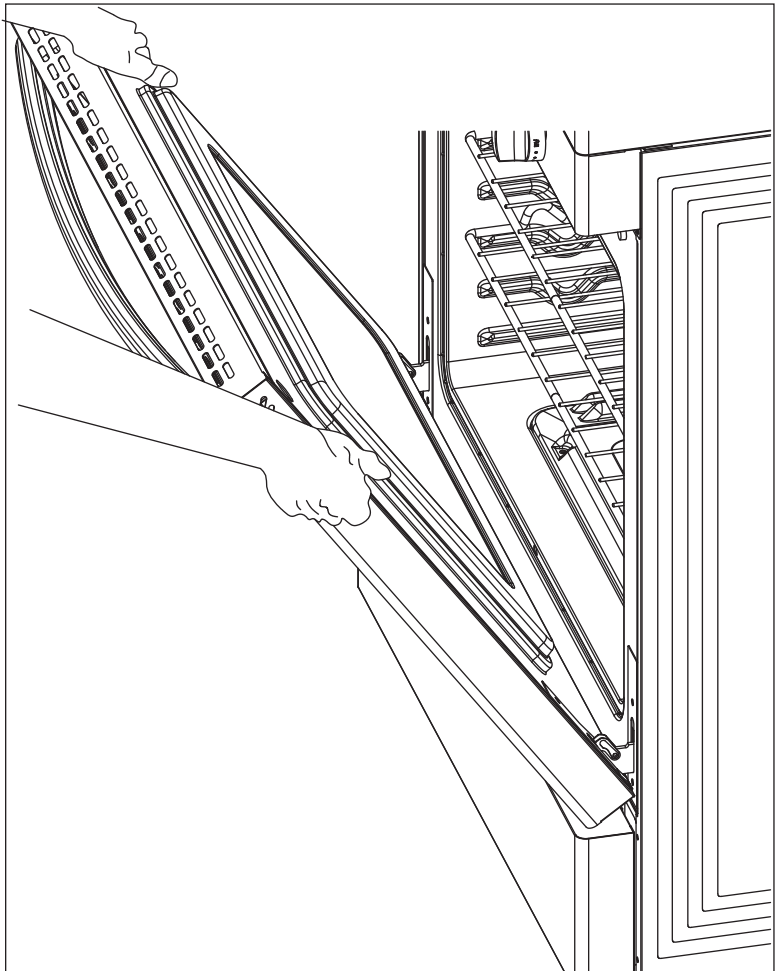

MAINTENANCE

REMOVING THE DOOR (cont.)

4. Disengage the hinges and remove the door gently with a 30° angle between the door and the oven. Place the door on a protected surface.

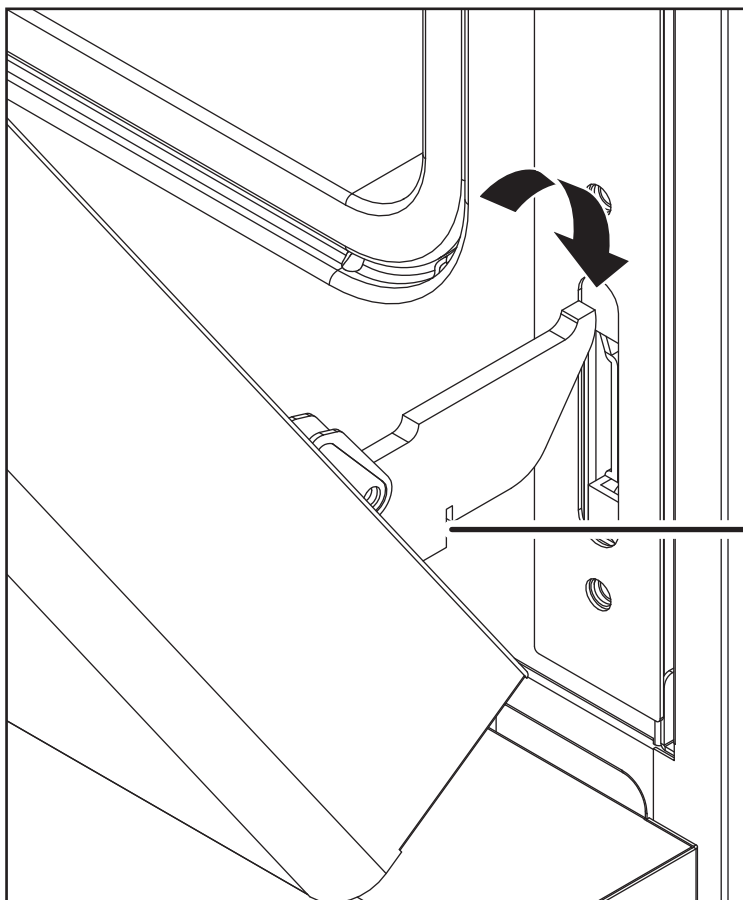
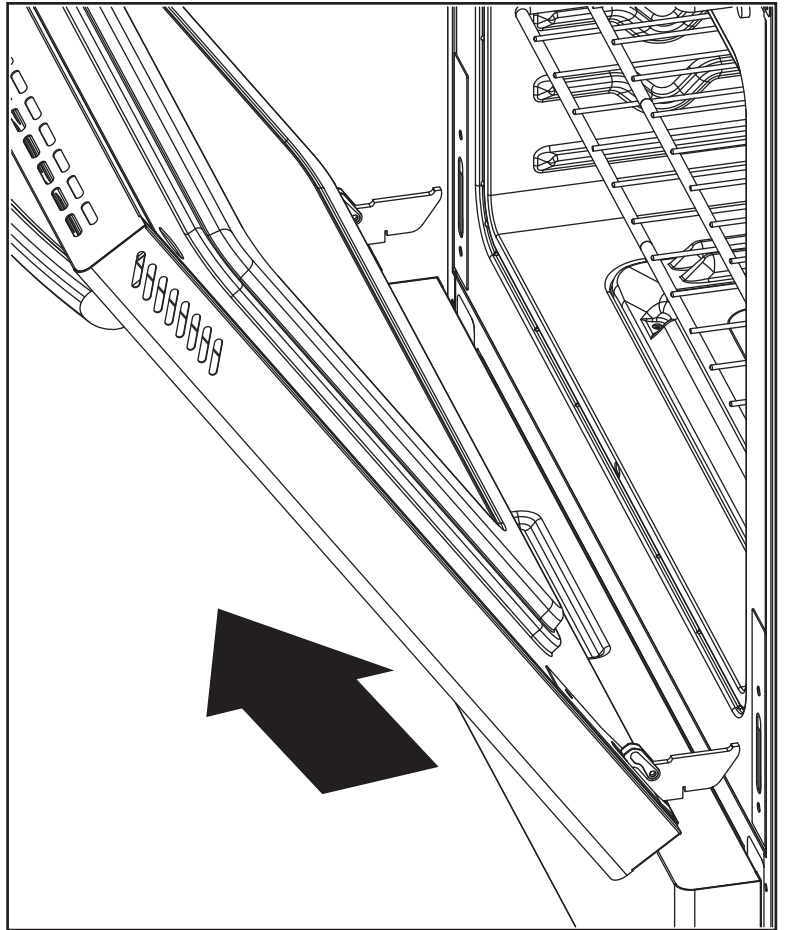

REPLACING THE DOOR

1. Hold the door firmly in almost half open position.

notch

MAINTENANCE

REPLACING THE DOOR (cont.)

2. Insert the hinge tongues into the slots making sure that the notches on both sides drop into place.

3. Open the door fully.

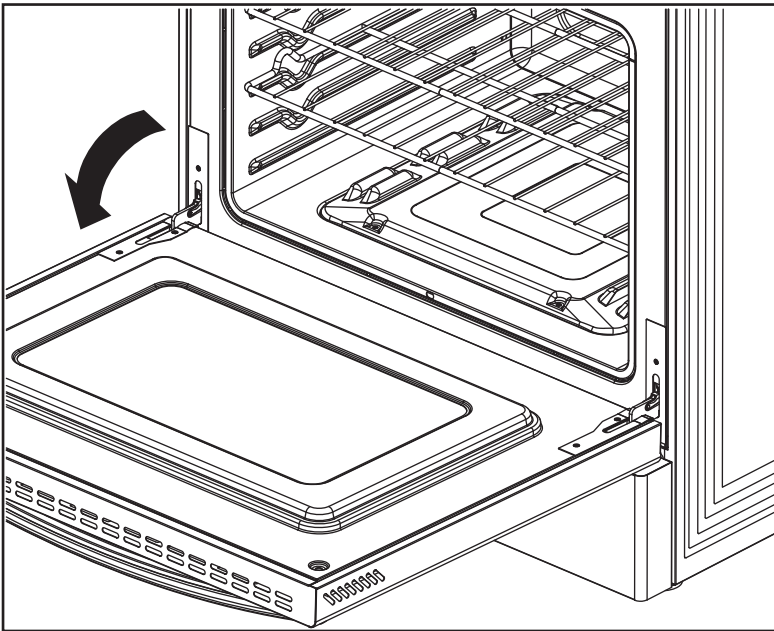
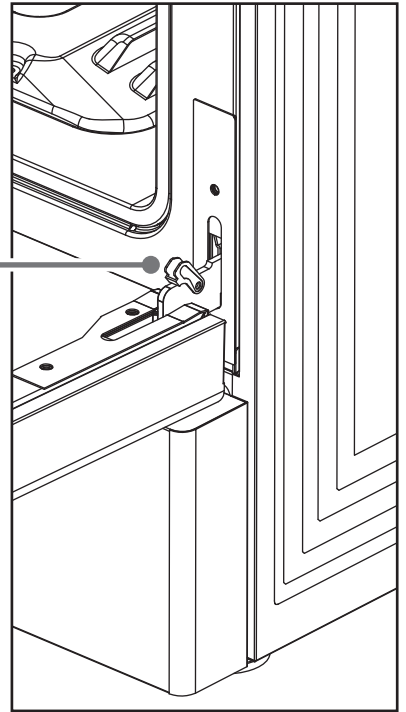
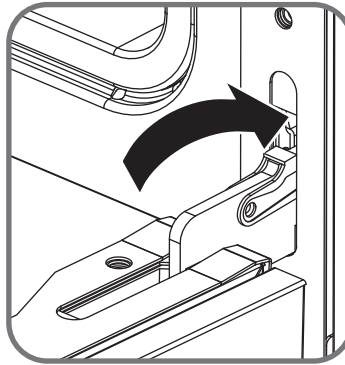

4. Fully close the levers on the left and right hinges, then close the door.

REMOVING AND REPLACING THE STORAGE DRAWER

The storage drawer is a good place to store cookware and bakeware. Do not store plastics or flammable material in the drawer. Clean the storage drawer with a damp cloth or sponge. Never use harsh abrasives or scouring pads.

1. Open storage drawer fully, lift the storage drawer, then remove the drawer.

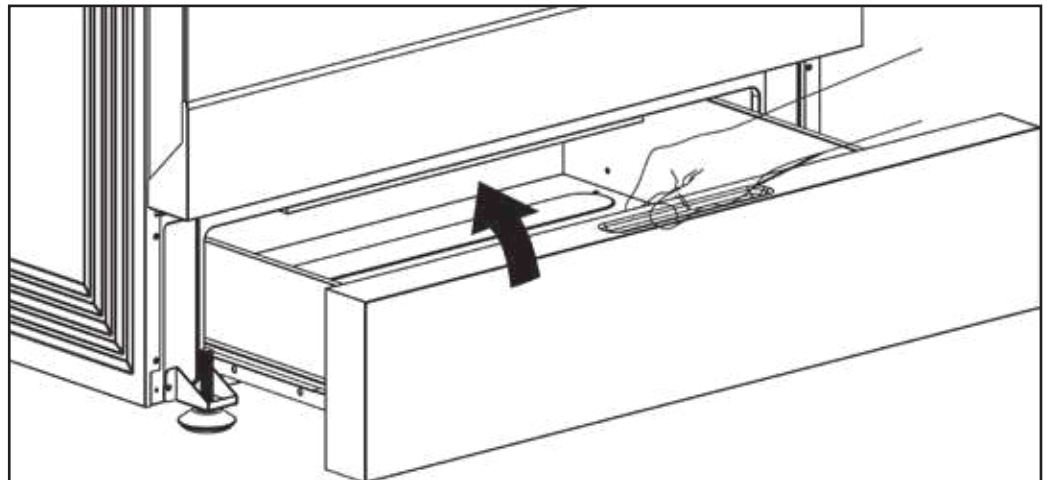

MAINTENANCE

REMOVING AND REPLACING THE STORAGE DRAWER (cont.)

2. To replace the drawer, make sure that the white wheel on the drawer aligns with the rails well, then slide the drawer back into your range.

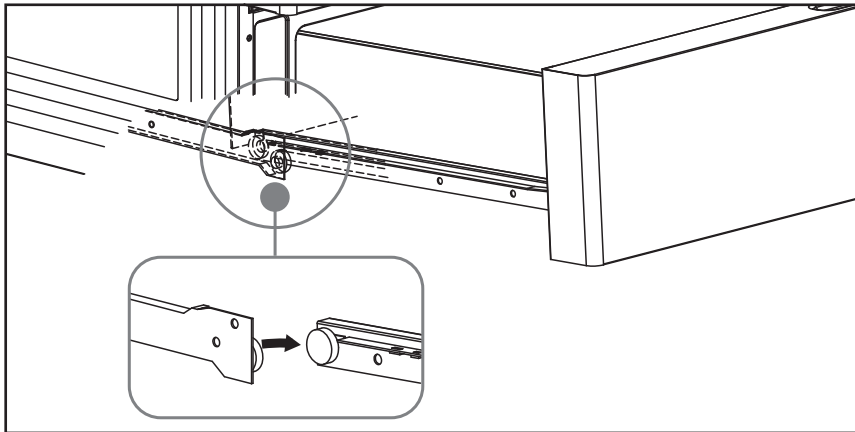

STEAM CLEANING THE OVEN

NOTE - Steam cleaning the oven takes about 20 minutes and is automatically controlled by the oven.

1. Remove all accessories from the oven.

2. Pour 10 oz. (300 ml) of water onto the bottom of the empty oven and close the oven door. Use normal water only, not distilled water. When steam-cleaning, use exactly 10 oz. of water because this produces the best results.

NOTE - For heavy residue, such as grease left over from roasting, we recommend that you rub detergent into the residue before activating the steam-cleaning function.

3. Press both BROIL and COOK TIME pads at the same time and hold for 3 seconds to get STEAM CLEAN, then press the START pad.

NOTE - If you press the STEAM CLEAN pad when the oven temperature is above 150° F (65° C), HOT appears in the display. Because this function produces the best results when started while the oven is cool, we recommend that you wait until the oven has cooled down and HOT disappears from the display.

4. Press the CANCEL pad.

WARNING - Be careful when opening the door before a steam-cleaning procedure has ended. The water on the bottom is hot.

5. Open the oven door and remove the remaining water with a sponge. Do not leave the residual water in the oven for any length of time. A significant amount of water remains on the bottom of the oven after a steam-cleaning cycle.

6. Use a detergent-soaked sponge, a soft brush, or a nylon scrubber to wipe the oven interior. Remove stubborn residue with a nylon scourer. You can remove lime deposits with a cloth soaked in vinegar. If the oven remains dirty, repeat the procedure after the oven has cooled.

7. After cleaning, leave the oven door ajar at a 15° angle to let the interior enamel surface dry thoroughly.

TROUBLESHOOTING

If the solutions in this section do not solve a problem, contact a qualified service technician or Koolatron Customer Assistance.

PROBLEM	POSSIBLE CAUSE	SOLUTION
My range is not level.	Your range has been installed incorrectly.	<ul style="list-style-type: none"> • Place an oven rack in the center of the oven. • Place a level on the oven rack. • Adjust the leveling legs at the base of your range until the oven rack is level. • Make sure that the floor is level and strong and stable enough to adequately support your range.
	The floor is sagging or sloping.	Contact a carpenter to correct the situation.
	The kitchen cabinets are not correctly aligned and make your range appear to not be level.	Make sure that the cabinets are square and provide sufficient room for installation.
My range needs to be accessed for servicing and can't be moved easily.	The oven leg is inside the anti-tip device.	Slide your range forward until the leg is out of the anti-tip device, then move your range as needed. Make sure that you reinstall the range leg into the anti-tip device when you are through.
	The kitchen cabinets are not square and too close to your range.	Contact a builder or installer to make your range accessible.
	Carpet is interfering with movement of your range.	Provide sufficient space so your range can be lifted over the carpet.

CONTROL PANEL DISPLAY

PROBLEM	POSSIBLE CAUSE	SOLUTION
The display goes blank.	A fuse in your home may be blown or the circuit breaker tripped.	Replace the fuse or reset the circuit breaker.
The display flashes.	There was a power failure.	Reset the clock.
I turned off the beeper, but it still beeps.	Some beep tones can't be turned off.	The clock and beep warning tones stay on even when you turn the beeper off. This is normal.

TROUBLESHOOTING

COOKTOP

PROBLEM	POSSIBLE CAUSE	SOLUTION
The surface burners do not produce a rolling boil or do not cook fast enough.	You may be using inappropriate cookware.	Use pans which are flat and match the diameter of the surface element you selected.
	In some areas, the power (voltage) may be low.	Cover the pan with a lid until the desired heat is obtained.
	If your range was recently installed, its power cord connection may be incorrect causing the burners and oven to receive half the normal voltage.	Disconnect the circuit breaker to cut power to the range and follow instructions on pages 18 or 19 to make sure the power cord wires are connected in the correct order and that the wire colors match the diagram shown, or contact Koolatron Customer Assistance for support.
The surface burners do not turn on.	A fuse in your home may be blown or the circuit breaker tripped.	Replace the fuse or reset the circuit breaker.
	The cooktop controls are set incorrectly.	Make sure that you have selected the correct control for the element you are using.
The cooktop has areas of discoloration.	Food spillover was not cleaned up.	See CLEANING THE COOKTOP .
	The surface is hot and the model features a light-colored cooktop.	This is normal. The surface may appear discolored when it is hot. This is temporary and disappears as the glass cools.
The surface element frequently cycles on and off. The surface element stops glowing when changed to a lower setting.	The element cycles on and off to maintain the power setting.	This is normal and not a system failure. Use the cooktop as usual.
Scratches or abrasions on the cooking surface.	The cooktop is being cleaned incorrectly.	Scratches are not removable. Tiny scratches become less visible in time as a result of cleaning. Use a ceramic glass top cleaning cream. Do not use chemical or corrosive agents. These agents may damage the surface of the product.

TROUBLESHOOTING

COOKTOP (cont.)

PROBLEM	POSSIBLE CAUSE	SOLUTION
Scratches or abrasions on the cooking surface.	Cookware with rough bottoms was used on the cooktop or there were coarse particles (for example, salt or sand) between the cookware and the surface of the cooktop.	To avoid scratches, use the recommended cleaning procedures. Make sure that cookware bottoms are clean before use, and use cookware with smooth bottoms.
	Cookware has been slid across the cooktop surface.	
The cooktop has brown streaks or specks.	Boilovers have been cooked onto the surface.	Wait until the surface cools down. Then, use a scraper to remove those impurities. Use a blade scraper to remove soil. See CLEANING THE COOKTOP .
Cooktop areas have discoloration with a metallic sheen.	Mineral deposits from water and food have been left on the surface of the cooktop.	<ul style="list-style-type: none"> • Remove using a ceramic-glass cooktop cleaning cream. • Use cookware with clean, dry bottoms. • Clean the cooktop with a ceramic cleaning agent regularly every week.
I hear a “cracking” or “popping” sound.	This is the sound of the metal heating and cooling during both the cooking and self-cleaning functions.	This is normal operation, and not a system failure. Use the cooktop as usual.

OVEN

PROBLEM	POSSIBLE CAUSE	SOLUTION
The oven does not turn on.	Your range is not completely plugged into the electrical outlet.	Make sure that the electrical plug is inserted into a live, correctly grounded outlet.
	A fuse in your home may be blown or the circuit breaker tripped.	Replace the fuse or reset the circuit breaker.
	The oven controls have been set incorrectly.	See USING THE OVEN .
	The oven is too hot.	Let the oven cool.
	Incomplete service wiring.	Call for service.
	Power outage.	Check to see if the house lights turn on. If required, call your local electric company for service.

TROUBLESHOOTING

OVEN (cont.)

PROBLEM	POSSIBLE CAUSE	SOLUTION
The oven does not turn on.	A delayed start time has been set.	Press the Cancel pad to cancel the delayed start time.
	The oven door doesn't close correctly.	Open the oven door and make sure that an item, like a baking dish, is not too big for the oven or is not placed correctly on the oven shelf.
The oven light does not turn on.	The light bulb is loose or defective.	Tighten or replace the bulb.
	The switch operating the light is broken.	Call for service.
Oven smokes excessively during broiling.	The control has not been set correctly.	See BROILING.
	The meat has been placed too close to the element.	Reposition the rack to provide the correct clearance between the meat and the element. Preheat the broil element for searing.
	The meat has not been correctly prepared.	Remove the excess fat from the meat. Cut away fatty edges that may curl, leaving the lean intact.
	Grease has built up on oven surfaces.	Regular cleaning is necessary when broiling frequently.
Food does not bake or roast correctly.	The oven controls have not been set correctly.	See USING THE OVEN.
	The oven rack has been positioned incorrectly or is not level.	See POSITIONING THE OVEN RACKS.
	Incorrect cookware or cookware of incorrect size is being used.	
	The oven sensor needs to be adjusted.	See ADJUSTING THE THERMOSTAT.
Food does not broil correctly.	The serving size may not be appropriate.	Refer to the cooking guide on the food packaging for serving sizes and try again.
	The rack has not been correctly positioned.	See MINIMUM AND MAXIMUM SETTINGS.
	Cookware not suited for broiling.	Use suitable cookware.

TROUBLESHOOTING

OVEN (cont.)

PROBLEM	POSSIBLE CAUSE	SOLUTION
Food does not broil correctly.	In some areas, the power (voltage) may be low.	Preheat the broil element for 10 minutes. See MINIMUM AND MAXIMUM SETTINGS.
The oven temperature is too hot or too cold.	The oven sensor needs to be adjusted.	See ADJUSTING THE THERMOSTAT.
Steam is coming out of the vent.	When using the fan feature, it is normal to see steam coming out of the oven vent.	This is normal operation, and not a system failure. Use the oven as usual.
	As the number of racks or amount of food being cooked increases, the amount of visible steam increases.	
A burning or oily odor is coming from the vent.	This is normal in a new oven and disappears in time.	
Strong odor.	An odor coming from the insulation around the inside of the oven is normal for the first few times the oven is used.	Operate the oven at the BAKE setting at 400 °F (204° C) for one hour.
Oven racks are difficult to slide.	The shiny, silver-colored racks were cleaned in a self-cleaning cycle.	Apply a small amount of vegetable oil to a paper towel and wipe the edges of the oven racks with the paper towel.

DRAWER

PROBLEM	POSSIBLE CAUSE	SOLUTION
The drawer does not slide smoothly or drags.	The drawer is out of alignment	Fully extend the drawer and push it all the way in. See REMOVING AND REPLACING THE STORAGE DRAWER.
	The drawer is over-loaded or the load is unbalanced.	Reduce weight. Redistribute drawer contents.

TROUBLESHOOTING

ERROR CODES

ERROR CODE	POSSIBLE CAUSE	SOLUTION
F1E1	Communication failure	<ol style="list-style-type: none"> 1. Enter standby state after fault recovery. 2. Make a judgment after 20 consecutive communication abnormalities.
F3E1	Cavity sensor open/short circuit	<ol style="list-style-type: none"> 1. A short-circuit fault can only be determined if the box sensor is detected to be short-circuited for 5 consecutive seconds under normal conditions. If the box sensor is detected to be normal for 5 consecutive seconds under a short-circuited state, the sensor can be judged to be back to normal. 2. After the machine has been running for 5 minutes, it can be judged as an open-circuit fault only if the cabinet sensor is open-circuited for 5 consecutive seconds. If the cabinet sensor is detected to be normal for 5 consecutive seconds with the cabinet sensor open-circuited state, the sensor can be judged to be back to normal. 3. After a fault occurs, the machine needs to stop heating, exit the current state, enter the fault state, and display the fault code. 4. If the fault is eliminated, you need to press the cancel button to return to the standby state and clear the fault code. If you press the cancel button in the fault state, the machine returns to the standby mode and clears the fault code. When re-testing determines that there is a fault, proceed to step 2.
F3E3	Cavity high temperature protection	<ol style="list-style-type: none"> 1. In working mode, if the temperature exceeds 310°C for 10 consecutive seconds, the oven temperature is deemed to be overheated. 2. After a fault occurs, the machine needs to stop heating, exit the current state, enter the fault state, and display the fault code. 3. If the fault is eliminated, you need to press the cancel button to return to the standby state and clear the fault code. If you press the cancel button in the fault state, the machine returns to the standby mode and clears the fault code.
F3E2	Oven heating failure	<ol style="list-style-type: none"> 1. $25^{\circ}\text{C} \leq \text{cavity temperature} \leq \text{set temperature} - 30^{\circ}\text{C}$; 2. Set temperature $\geq 85^{\circ}\text{C}$; 3. Temperature rise rate $\leq 3^{\circ}\text{C}$ within 7 minutes; 4. Only judge during the heating state (Judge when starting, and only judge once During the judgment process, if there is a door opening, malfunction, etc. to stop the heating operation, the judgment will be suspended.); 5. No judgment is made for special menus (such as fermentation, heat preservation, no requirement for the heating stage time...)

WARRANTY

Year Limited Warranty

WITH PROOF OF ORIGINAL SALE, the following warranty coverage applies when this appliance is correctly installed, operated and maintained according to all supplied instructions.

One Year Limited Warranty on Appliance

FOR ONE YEAR from the date of original sale this appliance is warranted against defects in material or workmanship. A defective appliance will receive free repair. If the appliance cannot be repaired, it will be replaced free of charge.

All warranty coverage applies for only 90 DAYS from date of original sale if this appliance is ever used for other than private household purposes.

This warranty covers **ONLY** defects in material and workmanship, and will **NOT** pay for the exclusions to repair service listed as follows:

1. A service technician to clean or maintain the product.
2. A service technician to instruct the user in correct appliance installation, operation or maintenance.
3. Expendable items that can wear out from normal use within the warranty period, including but not limited to filters, belts, bags or screw-in base light bulbs.
4. Cracks in a ceramic glass cooktop that are not a result of thermal shock.
5. Stains and scratches on a ceramic glass cooktop resulting from accident or improper operation or maintenance, nor for discoloration of any cooktop surface resulting from normal use.
6. Service calls to correct appliance installation not performed by Kenmore authorized service agents, or to repair problems with house fuses, circuit breakers, house wiring, and plumbing or gas supply systems resulting from such installation.
7. Damage to or failure of this appliance resulting from installation not performed by Kenmore authorized service agents, including installation that was not in accord with electrical, gas or plumbing codes.
8. Damage to or failure of this appliance, including discoloration or surface rust, if it is not correctly operated and maintained according to all supplied instructions.
9. Damage to or failure of this appliance, including discoloration or surface rust, resulting from accident, alteration, abuse, misuse or use for other than its intended purpose.
10. Damage to or failure of this appliance, including discoloration or surface rust, caused by using detergents, cleaners, chemicals or utensils other than those recommended in all instructions supplied with the product.
11. Damage to or failure of this appliance resulting from natural or other catastrophe, such as flood, fire or storm.
12. Damage to or failure of parts or systems resulting from unauthorized modifications made to this appliance.
13. Service to an appliance if the model and serial plate is missing, altered, or cannot easily be determined to have the appropriate certification logo.

The Kenmore brand is used under license. Direct all claims for warranty service to Kenmore Customer Assistance, call 1-800-265-8456 or email service@koolatron.com

Koolatron Corporation
4320 Federal Drive, Batavia, NY 14020 U.S.A.
139 Copernicus Blvd., Brantford, ON N3P1N4 Canada

Kenmore and the Kenmore logo are registered trademarks to Transform SR Brands LLC and are used under license by Koolatron Corporation

HIS443
10/2025-v3