



Air Fryer

use & care

Introduction.....	2
Important Safety Information	3
Features.....	5
Controls & Operation.....	6

Care & Cleaning	11
Troubleshooting.....	12
Warranty.....	13

2

INTRODUCTION

Welcome to our family

This manual is your resource for the use and care of your product. Please read it before using your Air Fryer. Keep it handy for quick reference. If something doesn't seem right, the troubleshooting section will help you with common issues.

Visit Owner Support on www.frigidaire.com for access to FAQs, how-to videos and articles, accessories and cleaning products.

We are here for you! Visit our website, chat with an agent, or call us if you need help. If you do need service, we can get that started for you.

For Peace of Mind Protection, register your product. Locate your registration card and/or label on your product with the photo register icon.

Keep your product info here so it's easy to find.

Model Number: _____

Serial Number: _____

Purchase Date: _____

Definitions

 This is the safety alert symbol. It is used to alert you to potential personal injury hazards. Obey all safety messages that follow this symbol to avoid possible injury or death.

 **DANGER**

DANGER indicates an imminently hazardous situation which, if not avoided, will result in death or serious injury.

 **WARNING**

WARNING indicates a potentially hazardous situation which, if not avoided, could result in death or serious injury.

Conforms to UL Std. 1026

Certified to CSA Std. CSA C22.2
No. 60335-1&60335-2-9



ATTENTION

Please read all instructions related to your product and keep this manual for your future reference. Follow all the warnings and instructions described in this manual to better use your product and get better results.

ENVIRONMENT

Frigidaire is committed to offering products that have less impact on the environment, thus contributing to the sustainable development. Electronic equipment, cells and batteries must be disposed of separately from ordinary waste. If your equipment has cells or batteries, when they are replaced or discarded, they must be sent to an Frigidaire Authorized Service so that they have a suitable destination. Environmentally sound preparation of packaging and products at the end of life is everyone's responsibility.

 **CAUTION**

CAUTION indicates a potentially hazardous situation which, if not avoided, may result in minor or moderate injury.

 **IMPORTANT**

IMPORTANT indicates installation, operation or maintenance information which is important but not hazard-related.

IMPORTANT SAFEGUARDS

SAFETY PRECAUTIONS

Read all instructions before using the electric appliance. The following basic precautions should always be followed.

- Children shall not play with the appliance. Cleaning and user maintenance shall not be performed by children without supervision. Close supervision is necessary when the air fryer is being used by or near children.
- Please keep the air fryer and the power cord out of the reach of children.
- After unpacking the product, keep the packaging material out of reach of children.
- This appliance is intended for normal household use only. Not for commercial use.
- Check that the supply voltage is the same as the product label before connecting it.
- Unplug the air fryer and allow it to cool before cleaning
- Do not use the appliance if the plug, the main cord or the appliance itself is damaged. Always make sure that the plug is inserted properly into a wall outlet.
- Regularly inspect the appliance and power cord. If the power cord is damaged or broken, it must be replaced by a service agent or similarly qualified persons to avoid safety hazards.
- Always return the appliance to an authorized service center for examination or repair. Do not attempt to repair the appliance yourself.
- Keep the power cord away from hot surfaces or sharp objects to avoid damage. Do not use an extension cord. Do not use an outlet under the counter.
- Do not excessively pinch, bend, twist or place heavy objects on the power cord to prevent from exposing or breaking its shielding. Do not use the electrical cord to pull or drag the product.
- Do not let cord hang over edge of table or counter, or touch hot surfaces.
- Always attach plug to appliance first, then plug cord into the wall outlet. To disconnect, turn the unit off, then remove plug from wall outlet.
- The accessible surfaces may become hot during use. Do not touch hot surfaces. Use handles. Keep hair and clothing away from heated parts of the product.
- Do not cover the air inlet and the air outlet openings while the appliance is operating.
- Never unplug the product from the outlet by pulling on the electrical cable, use the plug.
- Do not place the appliance on or near a hot gas or electric burner, or in a heated oven. Do not use outdoors.
- Never put anything flammable, explosive or corrosive in the basket. Never place paper, cardboard, non-heat-resistant plastic or similar combustible materials into your air fryer. Never put baking or parchment paper into the air fryer without food on top. Air circulation can cause paper to lift and touch heating coils.
- Do not pour oil into the cooking basket.
- Be extremely cautious when moving your air fryer (or removing the basket) if it contains hot oil or other hot liquids.
- Never start cooking without the basket being in place.
- Do not fill up the basket above the MAX line in order to prevent food contact with the heating element.

4

IMPORTANT SAFETY INFORMATION

IMPORTANT SAFEGUARDS

- Do not touch the basket directly with your hands during or after use to avoid burns. Always use the handle to remove the basket.
- Do not insert pins, wires or other objects into any of the openings of the air fryer to avoid an electrical shock or injury.
- To protect against electric shock, do not immerse the air fryer cord, plug, or housing in water or other liquids.
- Do not move or shake the air fryer during use.
- Do not insert any foreign objects into the safety switch to avoid any danger. This switch is designed to shut down the unit when the door is opened.
- Should the unit emit black smoke, unplug immediately and wait for smoking to stop before removing the cooking basket.
- Do not leave your air fryer unattended while in use.
- Do not store items on top of the air fryer when it is turned on.
- Do not use the air fryer for any purpose other than its intended use.
- When cooking, DO NOT place the appliance against a wall or against other appliances. Leave at least 5"/13 cm of free space on the back, sides, and above the appliance. DO NOT operate the appliance on or near combustible materials. DO NOT block any ventilation openings as hot steam is released through them. DO NOT place anything on top of the appliance.
- The use of accessory attachments is not recommended by the appliance manufacturer and may cause injuries.
- Respect the minimum distances around the product: 5"/13 cm sides; 5"/13 cm rear.



CAUTION

- Objects in the direct path of the hot air vent may suffer damage such as deformation or staining.
- The appliance is not intended for use as a barbecue. The use of coal inside the over presents a high risk of fire.



WARNING

FIRE/ELECTRICAL SHOCK HAZARD

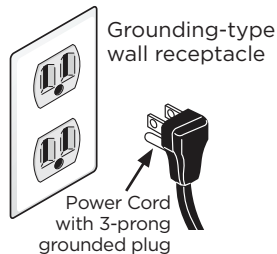

DO NOT, under any circumstances, cut, remove, or bypass the grounding prong.



WARNING

CALIFORNIA RESIDENTS ONLY:

For cancer and reproductive harm information visit:
www.P65Warnings.ca.gov

FOR HOUSEHOLD USE ONLY
SAVE THESE INSTRUCTIONS FOR FUTURE REFERENCE.

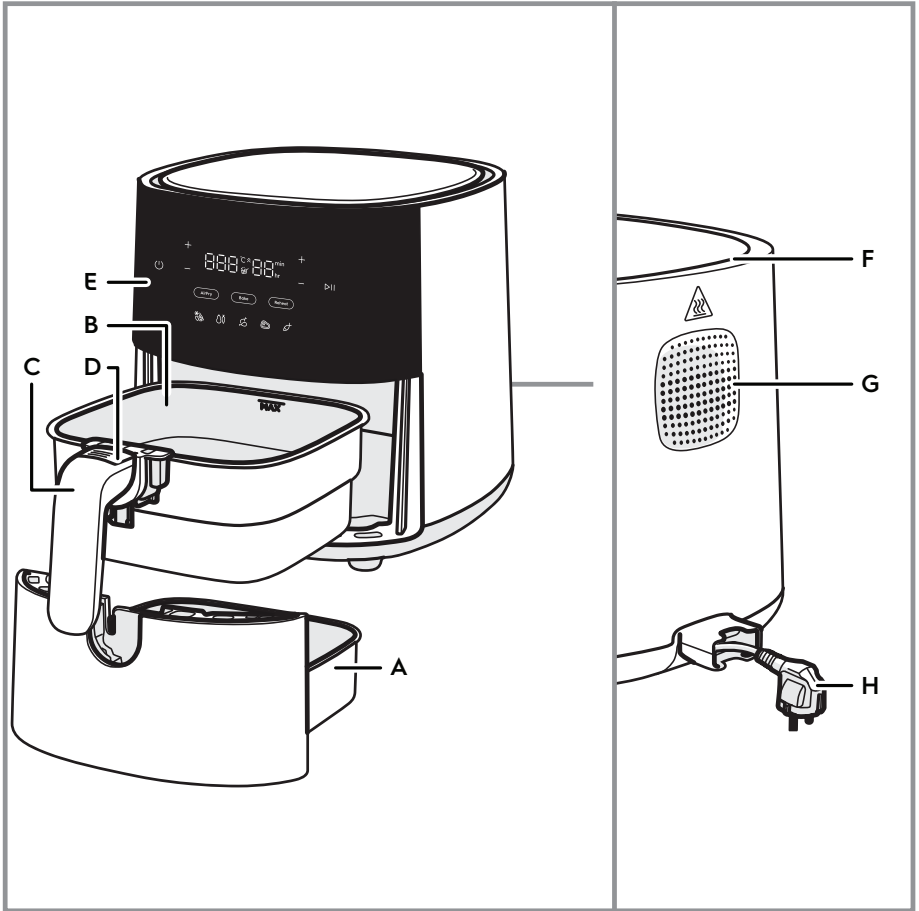

A. Pan	E. Control Panel
B. Basket	F. Air Inlet
C. Basket Handle	G. Air Outlet
D. Basket Release Button	H. Main Cord

6

CONTROLS & OPERATION

Before First Use

1. Remove all packaging and protective materials from the inside and outside of the Air Fryer.

NOTE

Please ensure that you have removed the cardboard insert between the basket and pan.

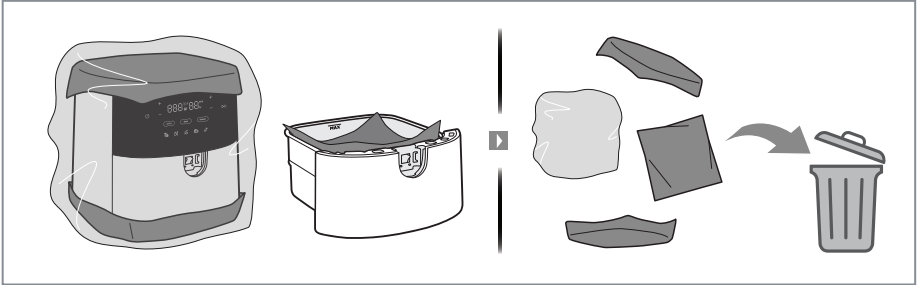

2. Clean the basket and pan with warm water and dish soap. Wipe inside and outside of the appliance with a soft cloth.
3. Heat the Air Fryer for 10 min using the Air Fry function.

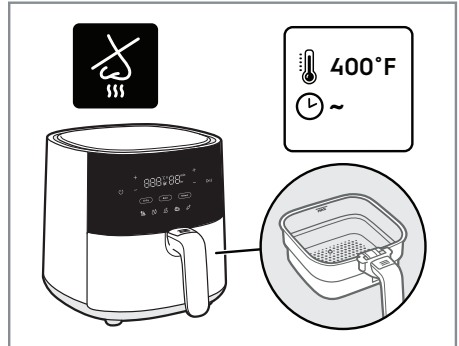
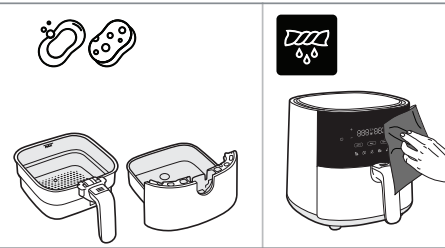

Control Panel

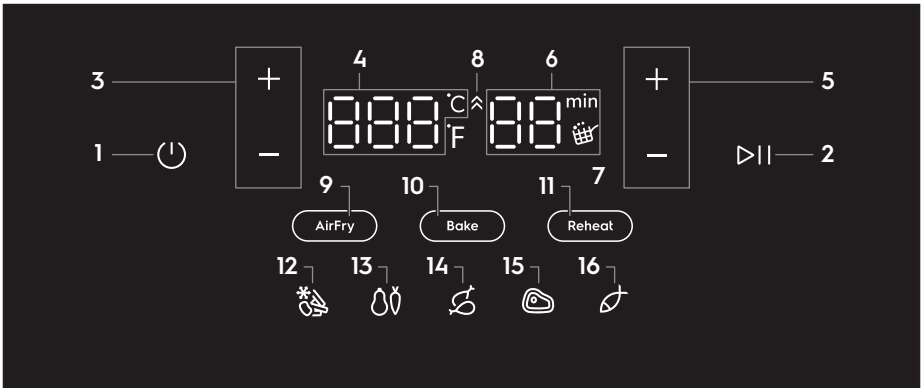

1. On/Off	9. Air Fry Function
2. Play/Pause	10. Bake Function
3. Temperature Control	11. Reheat Function
4. Temperature Indicator	12. French Fries/ Frozen Snacks
5. Time Control	13. Vegetables
6. Time Indicator (0-90 min.)	14. Chicken
7. Shake Reminder	15. Steak
8. Preheat Indicator	16. Fish

Using Your Air Fryer

1. Place the appliance on a flat, stable and heat-resistance surface.
2. Pull out the pan and place it on a stable surface.

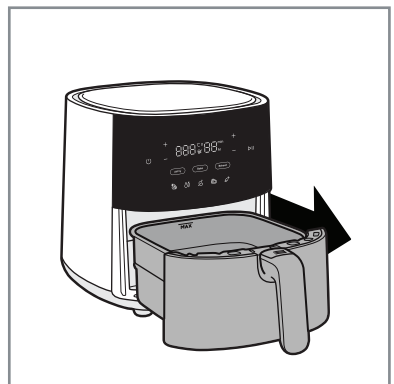
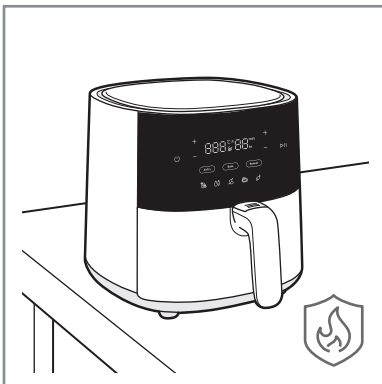

8

CONTROLS & OPERATION

- Put the food in the basket, observing the MAX capacity indicator.

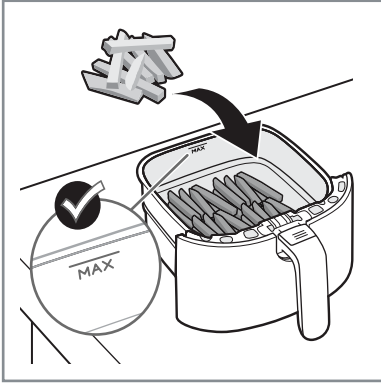

- Push the full pan into the appliance.

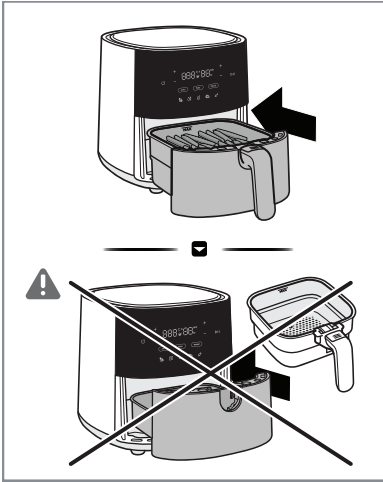

CAUTION

Do not use the appliance without the inner basket.

- Plug in the appliance.

- Press the On button.



- Select the desired cooking method. For example, Air Fry function.



- Adjust the time and temperature as desired or select one of the preset recipes. (See Preset Recipes.)



NOTE

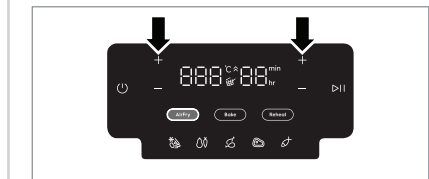

Press the temperature and time + button for 5 seconds to change the temperature units between Fahrenheit and Celsius.

- Press the Play button.



10. Some foods require flipping or shaking per every 7 minutes of cook time. Use a heat-resistant tool or carefully shake the food inside the basket. (See Preset Recipes.)

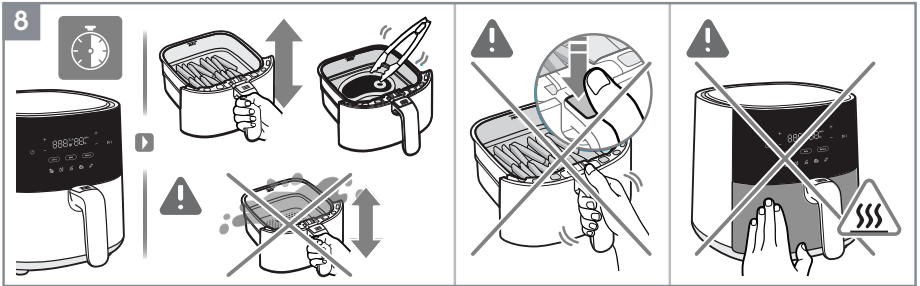

CAUTION

- Be careful not to press the "Basket Release Button" when shaking the food.
- Be careful of hot surfaces when the appliance is in use.

11. The Air Fryer beeps at the end of the cook time.
 12. Carefully remove the pan and place it on a heat-resistant surface.
 13. Follow the instructions below to remove the inner basket from the pan.

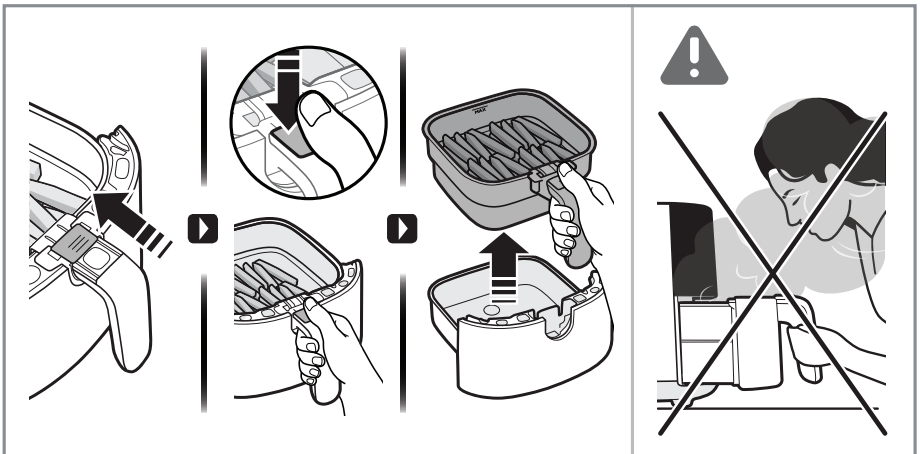

- Slide the button cover
- Press the "Basket Release Button"
- Lift the basket from the pan

14. Unplug the appliance after using it.

















CAUTION

Hot steam can come out of the basket when it is opened mid or at the end of cooking. Make sure your face, arms and hands are away from the steam when opening it.

10 CONTROLS & OPERATION

Preset Recipes

Food 	Portion (g) 	Time 	Temp. 	Shake or turn at half time elapsed? 
	300-700g	10-20 min	360°F	Yes
	300-800g	15 min	360°F	Yes
	100-400g	10-20 min	340°F	Yes
	100-400g	10 min	400°F	
	100-400g	10 min	400°F	
	100-400g	20-30 min	360°F	Yes
 Max 1kg	800-1000g	45-60 min	360°F	Yes
	200-500g	10-15 min	280°F	
	100-400g	6-10 min	360°F	
	150-300g	10-15 min	340°F	



IMPORTANT

The temperature and preparation times listed in the table are guidelines and vary depending on the recipes and the amount of ingredients, shape and texture of the foods. You can adjust the cooking temperature and time as desired.

Cleaning

1. Always unplug the appliance and wait until it cools down before cleaning it.
2. Wipe the outside of the appliance with a soft cloth.

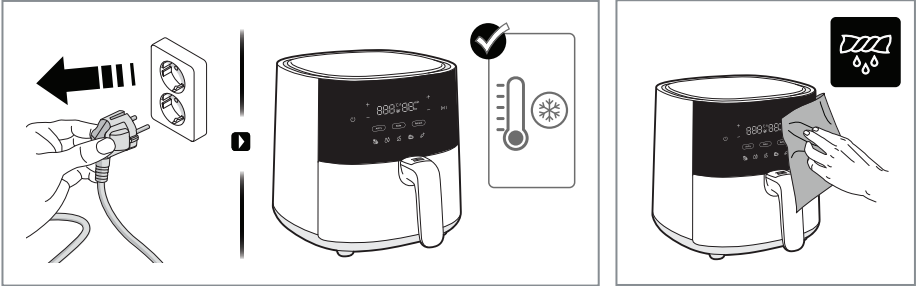

3. Clean the basket and pan with warm water and dish soap, or place them in the dishwasher.

NOTE

Abrasive cleaning products or metal tools will damage the non-stick coating.

CAUTION

Never submerge the product, its cord or plug in water or any other liquid.

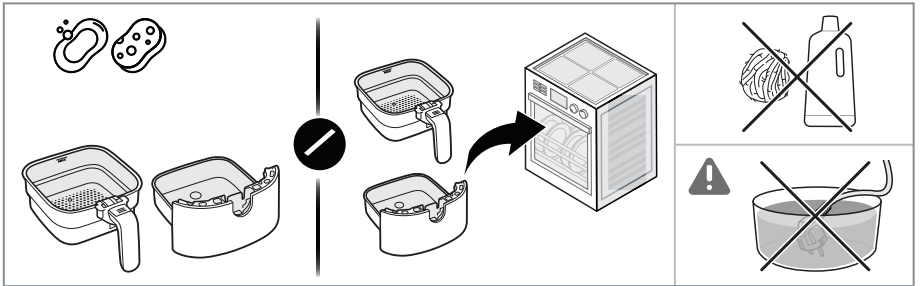

4. Clean the heating element with a cleaning brush.

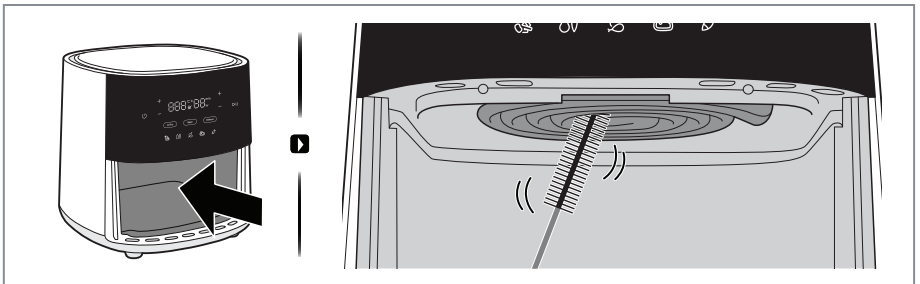

Storage

1. Turn off the Air Fryer and allow it to cool completely.
2. Ensure that all components and accessories are clean and dry.
3. Store your Air Fryer in a flat, dry, safe place away from children.

12 TROUBLESHOOTING

Use this guide to help with common issues that may interfere with the performance of the product. If this does not help improve the issue, please contact Customer Service.

Problem	Possible Cause	Solution
Air Fryer does not turn on or heat up	The Air Fryer is not plugged into the outlet	Place the power plug into the socket
	The safety lock is not engaged	Engage the safety lock
	The basket and pot are in the incorrect position	Remove and replace the basket and pot until they click into place
	The cooking time is not set	Set a cooking time, or choose a cooking preset
The pan will not slide into place	The basket is over filled with food	Reduce the amount of food in the basket
	The basket is not in the correct position	Remove and replace the basket until it clicks into place
White smoke coming from Air Fryer	The food in the basket is excessively greasy	The oil released during the preparation of some foods may splash on the super hot face of the Air Fryer and produce a white smoke. This behavior is normal and does not affect the final result
	Residue from previous use	Be sure to clean the Air Fryer correctly after each use
The display reads E1	The temperature sensor has disconnected	Contact Customer Service
The display reads E2	The temperature sensor has malfunctioned	Contact Customer Service

Model	FRAFM100B
Voltage	120V
Frequency	60Hz
Power	1500W
Capacity	5.3Qt
Color	Black

Your appliance is covered by a one year limited warranty. For one year from your original date of delivery, Electrolux will pay all costs for repairing or replacing any parts of this appliance that prove to be defective in materials or workmanship when such appliance is installed, used and maintained in accordance with the provided instructions.

Exclusions

This warranty does not cover the following:

1. Products with original serial numbers that have been removed, altered or cannot be readily determined.
2. Product that has been transferred from its original owner to another party or removed outside the USA or Canada.
3. Rust on the interior or exterior of the unit.
4. Products purchased "as-is" are not covered by this warranty.
5. Products used in a commercial setting.
6. Service calls which do not involve malfunction or defects in materials or workmanship, or for appliances not in ordinary household use or used other than in accordance with the provided instructions.
7. Service calls to correct the installation of your appliance or to instruct you how to use your appliance.
8. Expenses for making the appliance accessible for servicing, such as removal of trim, cupboards, shelves, etc., which are not a part of the appliance when it is shipped from the factory.
9. Service calls to repair or replace appliance light bulbs, air filters, other consumables, or knobs, handles, or other cosmetic parts.
10. Pickup and delivery costs; your appliance is designed to be repaired in the home.
11. Surcharges including, but not limited to, any after hour, weekend, or holiday service calls, tolls, ferry trip charges, or mileage expense for service calls to remote areas, including the state of Alaska.
12. Damages to the finish of appliance or home incurred during transportation or installation, including but not limited to floors, cabinets, walls, etc.
13. Damages caused by: services performed by unauthorized service companies; use of parts other than genuine Electrolux parts or parts obtained from persons other than authorized service companies; or external causes such as abuse, misuse, inadequate power supply, accidents, fires, or acts of God.

DISCLAIMER OF IMPLIED WARRANTIES; LIMITATION OF REMEDIES

CUSTOMER'S SOLE AND EXCLUSIVE REMEDY UNDER THIS LIMITED WARRANTY SHALL BE REPAIR OR REPLACEMENT AS PROVIDED HEREIN. CLAIMS BASED ON IMPLIED WARRANTIES, INCLUDING WARRANTIES OF MERCHANTABILITY OR FITNESS FOR A PARTICULAR PURPOSE, ARE LIMITED TO ONE YEAR OR THE SHORTEST PERIOD ALLOWED BY LAW, BUT NOT LESS THAN ONE YEAR. ELECTROLUX SHALL NOT BE LIABLE FOR CONSEQUENTIAL OR INCIDENTAL DAMAGES SUCH AS PROPERTY DAMAGE AND INCIDENTAL EXPENSES RESULTING FROM ANY BREACH OF THIS WRITTEN LIMITED WARRANTY OR ANY IMPLIED WARRANTY. SOME STATES AND PROVINCES DO NOT ALLOW THE EXCLUSION OR LIMITATION OF INCIDENTAL OR CONSEQUENTIAL DAMAGES, OR LIMITATIONS ON THE DURATION OF IMPLIED WARRANTIES, SO THESE LIMITATIONS OR EXCLUSIONS MAY NOT APPLY TO YOU. THIS WRITTEN WARRANTY GIVES YOU SPECIFIC LEGAL RIGHTS. YOU MAY ALSO HAVE OTHER RIGHTS THAT VARY FROM STATE TO STATE.

If You Need Service

Keep your receipt, delivery slip, or some other appropriate payment record to establish the warranty period should service be required. If service is performed, it is in your best interest to obtain and keep all receipts. Service under this warranty must be obtained by contacting Electrolux at the addresses or phone numbers below.

This warranty only applies in the USA, Puerto Rico and Canada. In the USA and Puerto Rico, your appliance is warranted by Electrolux Major Appliances North America, a division of Electrolux Home Products, Inc. In Canada, your appliance is warranted by Electrolux Canada Corp. Electrolux authorizes no person to change or add to any obligations under this warranty. Obligations for service and parts under this warranty must be performed by Electrolux or an authorized service company. Product features or specifications as described or illustrated are subject to change without notice.

USA & Puerto Rico
1-800 374 4432
Electrolux Home Products, Inc.
10200 David Taylor Drive
Charlotte, NC 28262

FRIGIDAIRE

Canada
1-800 265 8352
Electrolux Canada Corp.
5855 Terry Fox Way
Mississauga, Ontario,
Canada L5V 3E4

FRIGIDAIRE®

welcome **home.**

Our home is your home. Visit us if you need help with any of these things:



owner support



accessories



service



registration

(See your registration card for more information.)

Frigidaire.com
1-800-374-4432

Frigidaire.ca
1-800-265-8352