



EN User Manual | Wall Oven



## Welcome to our family

Thank you for bringing Frigidaire into your home! We see your purchase as the beginning of a long relationship together. This manual is your resource for the use and care of your product. Please read it before using your appliance. Keep it handy for quick reference. If something doesn't seem right, the troubleshooting section will help you with common issues. FAQ, helpful tips and videos, cleaning products, and kitchen and home accessories are available at <http://www.frigidaire.com>. We are here for you! Visit our website, chat with an agent, or call us if you need help. We may be able to help you avoid a service visit. If you do need service, we can get that started for you. Let's make it official! Be sure to register your product.

## CONTENTS

1. IMPORTANT SAFETY INFORMATION.....	2
2. COOKING RECOMMENDATIONS.....	5
3. BEFORE USING THE OVEN.....	7
4. SETTING OVEN CONTROLS.....	9
5. CARE AND CLEANING.....	20
6. TROUBLESHOOTING.....	23
7. LIMITED WARRANTY.....	24

# 1. IMPORTANT SAFETY INFORMATION

## 1.1 Keep a record for quick reference

Model number

.....

Serial number

.....

Purchase date

.....

Serial Number Location

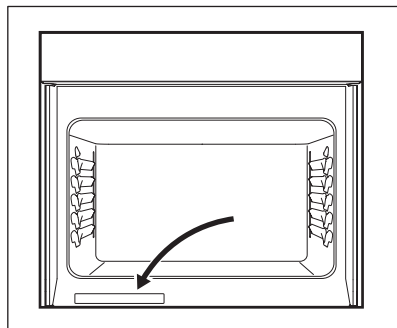

Read all instructions before using this appliance. This manual contains important safety symbols and instructions. Please pay attention to these symbols and follow all instructions given. Read safety precautions in this manual before installing or using your appliance. Safety items throughout this manual are labeled with a WARNING or CAUTION statement based on the risk type. Warnings and important instructions appearing in this guide are not meant to cover all possible conditions and situations that may occur. Common sense, caution, and care must be exercised with installing, maintaining, or operating your appliance.

## 1.2 ✓ Installation checklist

- Read all the safety instructions in the front of your user manual.
- Remove all packaging materials from your appliance before cooking.
- Confirm that the electrical power to the appliance is turned on.
- Wipe out the inside of the oven cavity with a damp cloth.

- Apply a thin layer of cooking oil to the sides of the oven racks to keep them gliding smoothly.
- Set the clock. Refer to the Setting Oven Controls chapter.
- Test all surface elements/burners to make sure they are working properly.
- Before cooking, set the oven to bake at 350°F (177°C) for 30 minutes. Some noise and odors are normal on the first cooking cycle.
- Remember to complete your product registration.

## 1.3 Safety definitions



This is the safety alert symbol. It is used to alert of potential personal injury hazards. Follow all safety messages that follow this symbol to avoid possible injury or death.

### ⚠ WARNING!

Indicates a potentially hazardous situation which, if not avoided, may result in death or serious injury.

### ⚠ CAUTION!

Indicates a potentially hazardous situation which, if not avoided, may result in minor or moderate injury.

### 📌 IMPORTANT

Indicates installation, operation, or maintenance information which is important but not hazard-related.

### 📌 NOTE

Indicates a short, informal reference – something written down to assist the memory or for future reference.

## **⚠ WARNING!**

### **Tip over hazard**

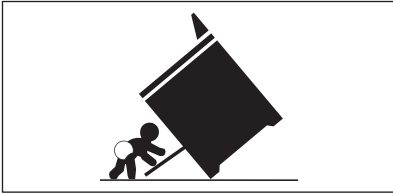

- A child or adult can tip the oven and be killed.
- Install the anti-tip device to oven and/or structure per installation instructions.
- Ensure the anti-tip device is re-engaged when the oven is moved.
- Do not operate the oven without the anti-tip device in place and engaged.
- Failure to follow these instructions can result in death or serious burns to children and adults.

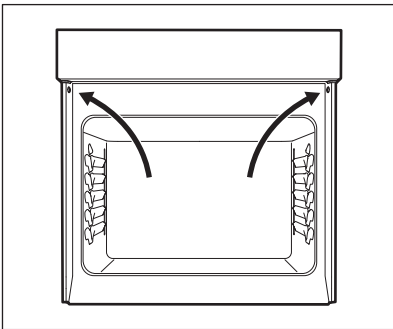

#### **Anti-tip mounting holes.**

Refer to the installation instructions supplied with your appliance for proper installation.

Check for proper installation with a visual check that the anti-tip screws are present. Test the installation with light downward pressure on the open oven door. The oven should not tip forward.

## **1.4 Important instructions for unpacking and installation**

### **📌 IMPORTANT**

Read and follow the below instructions and precautions for unpacking, installing, and servicing your appliance.

Remove all tape and packaging before using the appliance. Destroy the carton and plastic bags after unpacking the appliance. Never allow children to play with packaging material. Do not remove the wiring label and other literature attached to the appliance. Do not remove model/serial number plate.

Cold temperatures can damage the electronic control. When using this appliance for the first time, or when the appliance has not been used for an extended period of time, be sure the appliance has been in temperatures above 32°F (0°C) for at least 3 hours before turning on the power to the appliance.

All materials used in construction of cabinets, enclosures, and supports surrounding the product must have a temperature rating above 194°F (90°C).

Never modify or alter the construction of the appliance by removing the leveling legs, panels, wire covers, anti-tip brackets/ screws, or any other part of the appliance.

Be sure to have an appropriate foam-type fire extinguisher available, visible, and easily accessible located near the appliance.

## **1.5 Grounding instructions**

### **⚠ WARNING!**

- Avoid fire hazard or electrical shock. Failure to follow this warning may cause serious injury, fire, or death.
- Avoid fire hazard or electrical shock. Do not use an adapter plug, use an extension cord, or remove grounding prong from the power cord. Failure to follow this warning may cause serious injury, fire, or death.

**Proper Installation** - Be sure your appliance is properly installed and grounded by a qualified technician. In the United States, install in accordance with the National Fuel Gas Code ANSI Z223.1/NPFA No. 54, latest edition and National Electrical Code NFPA No. 70 latest edition, and local electrical code requirements. In Canada, install in accordance with CAN/CGA B149.1 and CAN/CGA B149.2 and CSA Standard C22.1, Canadian Electrical code, Part 1- latest editions and local electrical code requirements. Install only per installation instructions provided in the literature package for this appliance.

For personal safety, this appliance must be properly grounded. For maximum safety, the power cord must be securely connected to an electrical outlet or junction box that is the correct voltage, is correctly polarized and properly grounded, and protected by a circuit breaker in accordance with local codes.

It is the personal responsibility of the consumer to have the appropriate outlet or junction box with the correct, properly grounded wall receptacle installed by a qualified electrician. Contact a qualified installer to assure that the electrical installation is adequate and is in conformance with all local codes and ordinances.

See the installation instructions packaged with this appliance for complete installation and grounding instructions.

## 1.6 Important instructions for using the appliance

### **WARNING!**

- Do not store flammable materials in ovens, microwaves, near surface burners or elements, or in the storage or warming drawer (if equipped). This includes paper, plastic, and cloth items, such as cookbooks, plastic ware, and towels, as well as flammable liquids. Do not store explosives, such as aerosol cans, on or near the appliance.
- Do not leave children alone - Children should not be left alone or unattended in the area where appliance is in use. They should never be allowed to sit or stand on any part of the appliance, including the storage drawer, lower broiler drawer, warmer drawer, or lower double oven.
- Do not store items of interest to children in the cabinets above the appliance or on the backguards of ranges. Children climbing on or near the appliance to reach items could be seriously injured.
- Do not allow children to climb or play around the appliance. The weight of a child on an open oven door may cause the appliance to tip, resulting in serious burns or other injury. An open drawer when hot may cause burns.
- Stepping, leaning, or sitting on the door or drawers of this appliance can result in serious injuries and also cause damage to the appliance.
- Never cover any slots, holes, or passages in the oven bottom or cover an entire rack with materials such as aluminum foil. Doing so blocks airflow through the oven and may cause carbon monoxide poisoning. Aluminum foil linings may also trap heat, causing a fire hazard.
- Do not use oven or warmer drawer (if equipped) for storage.
- Never use your appliance as a space heater to heat or warm the room. Doing so may result in carbon monoxide poisoning and overheating of the appliance.

### **CAUTION!**

- When heating fat or grease, watch it closely. Grease may catch fire if it becomes too hot.
- Do not use water or flour on grease fires. Smother fire or flame or use dry chemical or foam-type extinguisher. Cover the fire with a pan lid or use baking soda.
- Use dry potholders. Moist or damp potholders on hot surfaces may result in burns from steam. Do not let potholders touch hot cooking areas. Do not use towels or other bulky cloths.
- Do not heat unopened food containers - Build-up of pressure may cause container to burst and result in injury.
- Wear proper apparel - Loose-fitting or hanging garments should never be worn while using the appliance. Do not let clothing or other flammable materials contact hot surfaces.
- Do not touch surface burners or elements, or areas near these burners or elements, interior surfaces of the oven, or the warmer drawer (if equipped). Surface burners and elements may be hot even though they appear cool. Areas near surface burners and elements may become hot enough to cause burns. During and after use, do not touch, or let clothing or other flammable materials touch these areas until they are cool. These areas may include the cooktop, surfaces facing the cooktop, oven vent areas, oven door, and oven window.
- Do not attempt to operate the appliance during a power failure. If the power fails, always turn off the appliance. If the appliance is not turned off and the power resumes, electric surface elements may resume operation when power is restored. Once the power resumes, reset the clock and the oven function.

## 1.7 Important instructions for using your oven

Protective liners: Do not use aluminum foil, aftermarket oven liners, or any other materials or devices to line oven bottom, oven racks, or any other part of the appliance. Only use aluminum as recommended for baking, such as lining

cookware or as a cover placed on food. Any other use of protective liners or aluminum foil may result in a risk of electric shock or fire or a short circuit.

Use care when opening oven door, lower oven door, or warmer drawer (some models). Stand to the side of the appliance when opening the door of a hot oven. Let hot air or steam escape before you remove or replace food in the oven.

Keep oven vent ducts unobstructed. Touching surfaces in this area when the oven is on may cause severe burns. Do not place plastic or heat-sensitive items on or near the oven vent. These items can melt or ignite.

Placement of oven racks: Always place oven racks in desired location while oven is cool. If rack must be moved while oven is hot, do not let potholder contact hot burner or element in oven. Use potholders and grasp the rack with both hands to reposition. Remove all cookware and utensils before moving the rack.

Do not use a broiler pan without its insert. Broiler pans and inserts allow dripping fat to drain away from the high heat of the broiler. Do not cover the broiler insert with aluminum foil; exposed fat and grease could ignite.

Do not cook food on the oven bottom. Always cook in proper cookware and always use the oven racks.

## 1.8 Important instructions for cleaning the appliance

### **CAUTION!**

Before manually cleaning any part of the appliance, be sure all controls are turned off and the appliance is cool. Cleaning a hot appliance can cause burns.

Clean the appliance regularly to keep all parts free of grease that could catch fire. Do not allow grease to accumulate.

Greasy deposits in the fan could catch fire.

Always follow the manufacturer's recommended directions for use of kitchen cleaners and aerosols. Be aware that excess residue from cleaners and aerosols may ignite causing damage and injury.

Clean ventilating hoods frequently - Grease should not be allowed to accumulate on hood or filter. Follow the manufacturer's instructions for cleaning vent hoods.

## 1.9 Important instructions for self cleaning the appliance

### **CAUTION!**

Before using self clean, remove the broiler pan, any food, utensils, and cookware from the oven, storage drawer or warming drawer (if equipped). Remove oven racks unless otherwise instructed.

Do not clean the oven door gasket. The door gasket is essential for a good seal. Care should be taken not to rub, damage, or move the gasket.

Do not use oven cleaners. No commercial oven cleaner or oven liner protective coating of any kind should be used in or around any part of the appliance.

Use the self clean cycle to clean only the parts listed in this manual.

Some birds are extremely sensitive to the fumes given off during the self clean cycle of any oven. Move birds to another well-ventilated room.

## 1.10 Important instructions for service and maintenance

Do not repair or replace any part of the appliance unless specifically recommended in the manuals. All other servicing should be done only by a qualified technician. This reduces the risk of personal injury and damage to the appliance. Always contact your dealer, distributor, service agent, or manufacturer about problems or conditions you do not understand.

Ask your dealer to recommend a qualified technician and an authorized repair service. Know how to disconnect the

power to the appliance at the circuit breaker or fuse box in case of an emergency.

Remove the oven door from any unused oven if it is to be stored or discarded.

Do not touch a hot oven light bulb with a damp cloth. Doing so could cause the bulb to break. Handle halogen lights (if equipped) with paper towels or soft gloves. Disconnect the appliance or shut off the power to the appliance before removing and replacing the bulb.

### **WARNING!**

California Residents: for cancer and reproductive harm information, visit [www.P65Warnings.ca.gov](http://www.P65Warnings.ca.gov)

## 2. COOKING RECOMMENDATIONS

### 2.1 Special Features

Use the special features of your oven to get the best baking and roasting results.

Goal	Feature
<ul style="list-style-type: none"> <li>Steaks perfectly cooked to your preference.</li> <li>Juicy pork and poultry.</li> <li>Eggs just as hard or soft as you like them.</li> <li>Vegetables that remain firm and crisp.</li> </ul>	<b>Air Sous Vide</b> The precisely-controlled heat and air flow give you sous vide results without the water bath, preserving natural flavors and locking in moisture.
<ul style="list-style-type: none"> <li>Breads and pastries that rise higher with a crispy, golden crust and a light and flaky interior.</li> </ul>	<b>Steam Bake</b> Steam baking slows the formation of the crust, allowing your dough to grow longer before the crust forms.
<ul style="list-style-type: none"> <li>Moist and tender meats with a golden, crispy skin on the outside.</li> </ul>	<b>Steam Roast</b> The humidity of steam roasting prevents meats from drying out during the cooking process.
<ul style="list-style-type: none"> <li>Golden, crispy chicken wings.</li> <li>Crunchy vegetable chips.</li> <li>Juicy chicken Parmesan.</li> <li>Perfectly crisp tempura shrimp, samosas, and more.</li> </ul>	<b>Air Fry</b> The hot air convection makes crisp, golden fried foods without the splatter. For even heating on all sides and large capacity, use the Air Fry tray.
<ul style="list-style-type: none"> <li>Fresh Neapolitan or New York Style Pizza.</li> </ul>	<b>Stone-Baked Pizza</b> High heat will deliver your pizza with delightful charring in approximately 2 minutes.
<ul style="list-style-type: none"> <li>Airy breads and balanced pizza dough.</li> </ul>	<b>Bread Proof</b> Bread proofing keeps your oven at the best temperature and humidity for yeast to cause your dough to rise.
<ul style="list-style-type: none"> <li>Prepare convenience foods without delay.</li> <li>Frozen, partially baked, deli, or premade crust pizzas.</li> </ul>	<b>No Preheat</b> Get your culinary delights on the table faster.
<ul style="list-style-type: none"> <li>Healthy, flavorful fruit snacks.</li> <li>Lean meat jerky.</li> <li>Dried herbs.</li> </ul>	<b>Dehydrate</b> The dehydrate feature keeps the oven on low humidity and low heat to dry foods without cooking them.
<ul style="list-style-type: none"> <li>Perfectly browned baked goods.</li> <li>Evenly cooked roasts and braises.</li> </ul>	<b>Advanced Convection</b> Even your most challenging recipes turn out delicious with the precisely-controlled heat and air circulation of Advanced Convection.
<ul style="list-style-type: none"> <li>Roast turkey that is crispy on the outside and juicy on the inside.</li> </ul>	<b>Turkey Option</b> Precisely times your convection roast for turkey that is perfectly done.
<ul style="list-style-type: none"> <li>Perfectly browned baked goods.</li> <li>Evenly cooked roasts and braises.</li> </ul>	<b>Convection Cooking</b> Even your most challenging recipes turn out delicious with the precisely-controlled heat and air circulation of Advanced Convection.
<ul style="list-style-type: none"> <li>No more guessing how to get the perfect temperature.</li> </ul>	<b>Food Probe</b> Cook your meat to the internal temperature you desire, avoiding cooking insufficient or excessive.
<ul style="list-style-type: none"> <li>Move food easily in and out of the oven.</li> </ul>	<b>Luxury-Glide® Oven Racks</b> Oven racks are so smooth they extend effortlessly.

Goal	Feature
<ul style="list-style-type: none"> <li>See clearly what's happening inside the oven.</li> </ul>	Luxury-Design® Lighting Get full visibility into the oven's interior with our ramp-up halogen Luxury-Design® Lighting
<ul style="list-style-type: none"> <li>Prevent build-up of burned, spilled food in the bottom of the oven.</li> </ul>	Steam Clean Keep your oven looking its best with the Steam Clean cycle that is chemical and odor free.

## 2.2 Bakeware

The material of bakeware affects how evenly and quickly it transfers heat from the pan to the food.

Material	Attributes	Recommendation
Shiny metal bakeware	Shiny, aluminum, and non-coated bakeware is the best for even heating. It is suitable for all baked goods.	Recommended cooking temperatures and times are based on shiny metal bakeware.
Dark metal bakeware	Dark bakeware cooks hotter than shiny bakeware.	Reduce the cooking temperature by 25°F / 13-14°C when you use a dark bakeware.
Glass bakeware	Glass bakeware cooks hotter than shiny bakeware. Glass is convenient, you can use the same piece of bakeware for cooking, serving, and storing food.	Reduce the cooking temperature by 25°F / 13-14°C when you use a glass bakeware.
Insulated bakeware	Insulated bakeware cooks cooler than shiny bakeware. Insulated bakeware is designed for baking in gas oven.	When you use insulated bakeware, the recipe baking time may be longer than usual.

## 2.3 Cooking Conditions

Conditions in your kitchen can affect the performance of your appliance when cooking food.

Condition	Attributes	Recommendation
Aging cookware	As pans age and become discolored, you may need to slightly reduce a cooking time.	If food is too dark or overcooked, use the minimum cook time in the recipe or packaging. If food is too light or undercooked, use the middle to maximum cook time recommended in the recipe or on the packaging.
High altitude	Air is drier and air pressure is lower. Water boils at a lower temperature, and liquids evaporate faster. Foods may take longer to bake. Doughs may rise faster.	Adjust cooking temperature, cooking time or recipes as needed. Increase amount of liquid in baking recipes. Increase cook time on cooktop. Cover dishes to reduce evaporation. Increase bake time or oven temperature. Reduce the amount of baking soda or baking powder in recipe. Reduce rising time or punch down dough and allow it to rise twice.

## 2.4 Cooking Results

Small adjustments may help you achieve the best results.

Result	Recommendation
Food too light	Use the middle to maximum cook time recommended on packaging or recipe.
Food too dark	Use the minimum cook time recommended on packaging or recipe.

## 2.5 Cooking Tips

Use these additional tips to get the best results from your appliance.

Situation	Recommendation
<b>Baking</b>	
Rack placement	Refer to Setting Oven Controls.
Preheat	Insert food immediately after the beep. Fully preheat the oven before baking items like cookies, cakes, biscuits, and breads.
Checking food	Use the window and oven light when you check the food. Opening the door may reduce baking performance.
Bake or Convection Bake	Convection bake is the best function to use for baking on multiple racks. For best performance, refer to Setting Oven Controls.
Steam Bake	For directions, tips, and benefits, refer to Setting Oven Controls.
Food placement	Allow at least 2 inches / 5 cm of space between bakeware for proper air circulation.
<b>Broiling / Roasting</b>	

Situation	Recommendation
Broiling pan	If the accessory is not included with your appliance, you can purchase it on the website <a href="http://www.frigidaire.com">www.frigidaire.com</a> . For best results when broiling, use a broil pan with an insert designed to drain the fat from the food, help avoid spatter, and reduce smoke. The broiler pan catches grease spills, and insert helps prevent grease splatters.
<b>Convection cooking</b>	
Convection attributes	Convection cooking uses a fan to circulate hot air around the oven and food. It browns food more evenly and reduces hot spots in the oven. Convection saves time when you use multiple racks or cook several food items at once.
Convection bake	Reduce cooking temperature by 25°F / 13-14°C from the recipe unless the recipe is written for convection baking. Preheat the oven for best result.
Convection roast	Convection roast is best for meats and does not require preheating for most meats and poultry. Reducing the cooking temperature for convection roast is not recommended. Carefully follow your recipe's temperature and time recommendations, adjusting the cooking time if the recipe does not specify convection roasting time. Since convection roast cooks faster, cook time may be reduced by 25% to 40% depending on food type. You can reduce cook times by 25% from the recommended time of your recipe, and check the food at this time. If needed, continue cooking until the desired doneness is obtained. If the food probe is included with your appliance, use it. If not, you can buy it in most grocery and home goods stores. Arrange oven racks so large cuts of meat and poultry are on the lowest rack of the oven. Do not cover foods when dry roasting - covering will prevent the meat from browning properly. When cooking meats, use the broiler pan and insert or a roasting rack. The broiler pan will catch grease spills and the insert helps prevent grease splatters.

### 3. BEFORE USING THE OVEN

#### **⚠ WARNING!**

Refer to Safety chapters.

#### 3.1 Oven Vent Location

The oven air vents are located behind the door, on its upper side. When the oven is on, warm air is released through the vent. This venting is necessary for proper air circulation in the oven and good baking results.

Steam or moisture may appear near the oven vent. This is normal.

#### **🚫 IMPORTANT**

Do not block oven vent or cover the openings with aluminium foil or any other material.

#### **⚠ WARNING!**

**Protective Liners** — Do not use aluminum foil (or any other material) or liners to line the oven bottom, walls, racks or any other part of the range. Doing so will alter the heat distribution, produce poor baking results, and possibly cause permanent damage to the oven interior. Improper installation of these liners may result in risk of electric shock or fire. During self clean, temperatures in the oven will be hot enough to melt foil.

#### **⚠ CAUTION!**

Always use pot holders or oven mitts when using the oven. When cooking, the oven interior, oven exterior and oven racks will become very hot which can cause burns.  
Remove all oven racks before starting a self clean cycle. If oven racks are left inside the oven during a cleaning cycle, the slide ability of the oven racks may be damaged and all of the oven racks will lose their shiny finish.  
To prevent possible damage to the oven, do not attempt to close the oven door until all the oven racks are fully positioned back inside the oven cavity.

#### 3.2 Types of Oven Rack

##### Flat Oven Rack

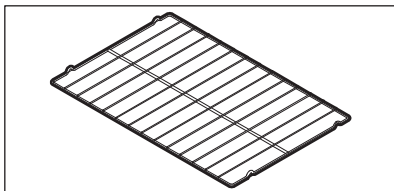

Flat oven racks may be used for most cooking needs and may be placed in most oven rack positions.

##### Glide racks

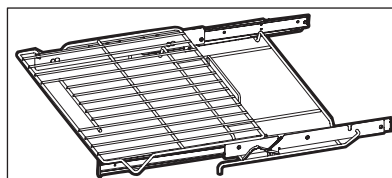

The fully extendable glide rack makes food preparation easier. This oven rack has glide tracks that allow the rack to be pulled away from the oven without rubbing the sides of the oven wall.

#### **🚫 IMPORTANT**

Before using the accessories, remove and clean them according to the instructions in the chapter: "Care and Cleaning".

#### 3.3 Removing and Arranging Oven Racks

#### **🚫 IMPORTANT**

Always arrange the oven racks when the oven is cool.

##### To remove oven racks

1. Pull the rack straight forward until it reaches the stop position.
2. Slightly lift up front of the oven rack and slide it out.

##### To replace oven racks

1. Place oven rack on the rack guides on both sides of oven walls.
  2. Lift the front of the oven rack slightly upward and slide it back into place.
- Ensure that oven rack is level before using it.

#### 3.4 Removing and Replacing the Glide Racks

##### To remove:

1. Make sure the baking rack is in the closed position.
2. Using one hand, reach through handle opening and grasp both the upper and lower bars of the glide rack.
3. While holding both sections, pull the glide rack out of the oven until the stop position is reached.

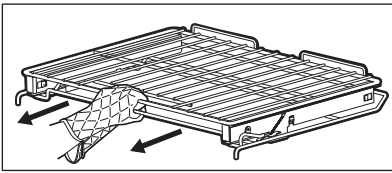

- Using both hands, lift up the front of the rack slightly and continue to pull the rack away from the oven. Be sure to grasp both upper and lower rack portions together when removing or handling the glide rack.

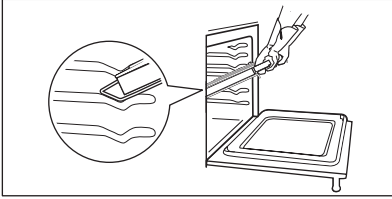

To replace:

- Make sure the baking rack is in the closed position.
- Grasp both upper and lower portions of glide rack.
- Lift and hold the rack level between the oven cavity walls.
- Tilt the front of the rack upward slightly and slide the rack completely into position.

### **IMPORTANT**

To prevent possible damage to the oven, do not attempt to close the oven door until all the oven racks are fully positioned back inside the oven cavity.

### 3.5 Using Menu Options to Customize Your Cooking Experience

When you first install your appliance, the screen will prompt you to set your preferences. You can always change them later using the menu .

- Touch the **Menu Options** bars and scroll to find the desired option.
- Select option and set your preference.
- Save and go back or **Save & Close**.

You can press the **X** to close without saving changes.

### 3.6 Oven Light

To activate the oven light, open the **Menu Options** and slide  to choose the setting for **Oven Light**.

### 3.7 Clock

When the appliance is first plugged in or when the power supply to the appliance has been interrupted, the display will show 12:00. It is recommended to always set the clock for the correct time of day before using the appliance.

To set the clock:

- Touch **Menu Options** bars and scroll to **Clock**.

#### **Clock options**

Turn off the clock display when the oven is off

Change from 12- hour to 24-hour time

Set the clock

- Touch **Set Clock** and set time using graph.
- Set AM or PM.
- Save & Close**.

### 3.8 Energy Saving Mode

The oven control has a factory preset built-in 12- hour Energy Saving feature that will turn off the oven if it is left on for more than 12 hours.

You can program the appliance to override this function and allow continuous baking for more than 12 hours.

- Scroll to **Energy Saving Mode** and touch.

- Follow the information to override the Energy Saving Mode if necessary.
- Save & Close**.

### 3.9 General Settings

You can change some settings of your appliance.

To do this:

- Scroll to **General Settings** and touch.
- Choose one of the settings you would like to change.

Setting	Description
Temperature Unit	To change from °F (default) to °C.
Volume Level	To choose oven control to operate with loud, quiet or no tones.
Screen Brightness Level	To choose display brightness level from: high, medium and low.
Language	Available languages: English, French Canadian, Spanish.
Cooking Tips	To choose if the Cooking Tips are displayed on the screen or not.

### 3.10 Favorites

Scroll to Favorites and touch.

**Quick Start Options** > Oven 350°F (can change the default when Quick Start is selected).

- Change temperature if desired.
- Save.

**Temperature Options** > Adjust Custom Preheat default.

- 325°F / 163°C
- 375°F / 191°C
- 400°F / 204°C



These temperature options are also available in Custom Preheat menu on the main screen.

### 3.11 Oven Temperature Calibration

Your appliance has been factory calibrated and tested to ensure an accurate baking temperature. For the first few uses, follow your recipe times and temperature recommendations carefully. If you think the oven is cooking too hot or too cool for your recipe times, you can adjust the control so the oven cooks hotter or cooler than the temperature displayed.

### **IMPORTANT**

Do not use oven thermometers such as those found in grocery stores to check the temperature settings inside your oven. These oven thermometers may vary by 20 to 40 degrees from actual temperatures.

To change the temperature setting:

- Scroll to **Oven Temperature Control** and touch.
- Use slide to increase or decrease default oven temperature.
- Save and go back or **Save & Close**.

The oven temperature may be changed by +/-35°F from the factory settings. You can also adjust the temperature if the control is set to display temperatures in Celsius (+/-19°C).

### 3.12 Sabbath Mode

- Scroll to **Sabbath Mode**.
- Read and follow all instructions to set and when finished cancel. Refer to Setting Oven Controls.

### 3.13 Factory Reset

Your appliance was set with default oven control settings. You can change the following settings while using the appliance over time:

- 12 or 24 hour display mode

- Screen Brightness
- Language
- Favorites
- Show Clock
- Food Probe settings
- Continuous bake or 12 hour energy savings mode
- Silent or audible control
- Oven temperature display (°F or °C)
- Oven temperature adjustments

To restore oven control to factory default settings:

1. Scroll to **Factory Reset** and touch.
  2. Follow screen prompts.
- Remember:** If Reset is touched, all the settings will return to the default.
3. Confirm your choice by pressing **RESET**, followed by **OKAY**.

### 3.14 Food Probe

Food Probe options can be found in the Settings menu and the Oven Modes menu. Select Food Probe from the Settings menu to select whether the oven turns off or stays on when the specified temperature is reached during cooking.

Scroll to **Food Probe**, touch and follow instructions on the display.

For setting the oven to use the Food Probe, see section "Cooking with Food Probe" in chapter Setting Oven Controls.

### 3.15 Lock Screen

As a safety measure the oven doors and controls can be locked. Follow screen directions to lock and unlock.

1. Go to **Menu Options** and select **Lock Screen**.
2. Touch and hold **LOCK** for 3 seconds.

When the doors and controls are locked the screen will show the time of day, a note that the oven is locked, and an **UNLOCK** key. Once the controls and door are locked, there is no access to any cooking functions. This ensures that the oven will remain locked and safe.

To unlock the oven door and control, press **UNLOCK** and follow directions on the screen.

### 3.16 Connecting Your Oven to Your Smartphone

Read the information in the Get Connected Card first before setting up your smartphone to connect to the oven. Download the FrigidaireApp to your smartphone to connect and to program your oven for remote cooking.

To set up the Connectivity in you oven:

1. Go to **Menu Options** and select **Connectivity**. Follow the instructions on the display.
2. Once the App is downloaded you have options to connect to your home network. Be sure to read instructions and tips on using the App to set oven modes.
3. You can set the App to control some oven modes and functions remotely.

Using your smartphone to control some of the oven functions requires some care on your part. Be sure to follow all the Frigidaire App instructions for mobile use.

### 3.17 About the Appliance

Important information about the appliance such as the software version number and contact information for support is listed here.

1. Scroll to **About the Appliance** and touch.
2. Touch headings to see information.





## 4. SETTING OVEN CONTROLS

### **WARNING!**

Refer to Safety chapters.

### 4.1 Oven Controls



Oven Control	Description
 <b>ON/OFF</b>	To open display and the Quick Start Screen. You can also activate the screen by touching it. If you touch <b>ON/OFF</b> while the oven operates, it will turn off completely, cancelling all the running functions.
 <b>BACK</b>	To return to the previous screen without implementing any changes you may selected.
 <b>TIMER</b>	To set the countdown time (you can set from 1 min to 11 h and 59 min). You can pause or cancel the countdown. You can also add or subtract time by pressing + or -.
 <b>LIGHT</b>	To turn the oven light on or off.

#### Minimum and maximum control settings

Feature	Mode	Min.Temp/Time	Max.Temp/Time
No Preheat		170°F (77°C)	550°F (288°C)
Bake		170°F (77°C)	550°F (288°C)
Broil		400°F (204°C)	500°F (260°C)
Air Fry		170°F (77°C)	550°F (288°C)

Feature	Mode	Min.Temp/Time	Max.Temp/Time
Air SousVide		100°F (38°C)	205°F (94°C)
Steam Bake		170°F (77°C)	550°F (288°C)
Steam Roast		170°F (77°C)	550°F (288°C)
Conv Bake		170°F (77°C)	550°F (288°C)
Convection Roast		170°F (77°C)	550°F (288°C)
Food Probe		140°F (60°C)	210°F (99°C)
Keep Warm		140°F (60°C)	200°F (93°C)
Bread Proof		100°F (38°C)	11:59 h/min
Dehydrate		95°F (35°C)	170°F (77°C)
Timer		0:01 min	11:59 h/min
Cook Time	12 h	0:01 min	11:59 h/min
	24 h	0:01 min	11:59 h/min
Clock	12 h	1:00 h./min	11:59 h/min
	24 h	0:00 min	23:59 h/min
Delay Start		0:01 min	1 h/min
Self Clean		2 h	4 h
Steam Clean		30 min	30 min
Slow Cooker	Low	4 h	12 h
	Medium	4 h	10 h
	High	2 h	6 h

### 4.2 Quick Start

From this view you can set the temperature and immediately start the Bake function.

To select other function touch **Oven Modes** and use the scroll bar to browse the list to search for the desired function.

## NOTE

Valuable tips to help you get the best results are included in the display and also can be found in this User Manual.

### 4.3 Setting Cook Time

Use this feature to set the amount of time needed for most oven functions. The oven will turn on immediately (or after a specified delay) and stop automatically after the set cook time ends.

## NOTE

The maximum cook time setting is 11 h and 59 min unless the oven is set for continuous cooking.

In most cases you will see a cooking tip suggesting to set Cook Time after the oven is preheated.

To change the oven temperature or cook time after baking has started:

1. Touch **+** or **-** on either side of the set temperature.
2. Touch **TEMP** to access the keypad.
3. When the set Cook Time ends **Off** will appear on the display, a tone will sound and the oven will turn off automatically..
4. Touch **OKAY**.

### 4.4 Delay Start

Delay Start allows you to delay the start of cooking by the desired amount of time. It can be used with functions: Bake, Conv Bake, No Preheat, Convection Roast, Steam Roast, Steam Clean, Self Clean. Prior to setting a delay start, be sure the time of day is set correctly. The maximum delay for a Delay Start is one hour (12 hours for:Self Clean,Steam Clean).

To set Delay Start:

1. Press **ON/OFF**.
2. Touch **Oven Modes** and touch **Delay Start**.
3. Follow the information on the screen to set delay time, temperature, and cook time.
4. When the time runs out, the chosen cooking function will start. The screen will show the oven temperature.
5. When the Cook Time (if set) is off, **Off** appears on the display and the oven will turn off.
6. A signal will sound to remind you about the finished cooking process. To cancel the alarm press **OKAY**.

## WARNING!

**Food Poisoning Hazard.** Do not let food sit in the oven for more than one hour before or after cooking. Doing so can result in food poisoning or sickness.

### 4.5 Setting Bake

Bake may be set for any oven temperature between 170°F (77°C) to 550°F (288°C). A tone will sound indicating when the set bake temperature is reached and to place the food in the oven.

## CAUTION!

Always use pot holders or oven gloves when using the oven. When cooking the oven interior, oven racks, and cooktop will become very hot. There is a risk of burns!

Baking tips:

- Fully preheat the oven before baking items like cookies, cakes, biscuits and breads.
- Use the convection bake function for best results when baking cookies on multiple racks.
- Bake is the best function to use for baking cakes.
- For best results when baking layer cakes using two oven racks, place racks like shown on the picture below.

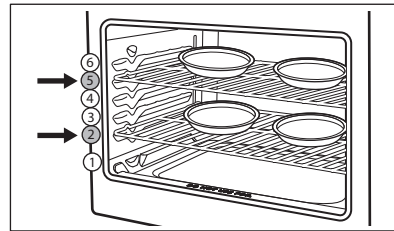

- When using any single rack for baking cookies, cakes, biscuits, or muffins use rack position 3.
- For two rack baking, use rack position 2 (flat) and 5 (glide).
- Allow at least 2 inches (5 cm) of space between bakeware for proper air circulation.
- Dark or dull bakeware absorbs more heat than shiny bakeware, resulting in dark or overbrowned foods. It may be necessary to reduce oven temperature or cook time to prevent overbrowning of some foods.
- Dark pans are recommended for pies. Shiny pans are recommended for cakes, cookies, and muffins.
- Do not open oven door often. Opening the door will reduce the temperature in the oven and may increase cook time.
- Do not leave oven light on while baking.

To set **Bake**:

1. Press **ON/OFF**.
2. Touch **Oven Modes** and touch **Bake**. You can also activate this function from the Quick Start Screen.
3. Set the desired temperature or use default of 350°F.
4. Touch **START**.

The screen shows current temperature and a **Cook Time** button.

5. Set Cook Time, if desired.  
If a Cook Time is set the oven will turn off automatically when the time expires.
6. Touch **START**.
7. When the cooking time is off, **Off** appears on the display.
8. Press **ON/OFF** to return display to show the time of day.

To cancel cooking at any time touch **CANCEL**.

### 4.6 Setting Conv Bake

Convection Bake uses a fan to circulate the oven's heat uniformly around the oven. This improved heat distribution allows for even cooking and browning results. Heated air flows around the food from all sides. Convection Bake may be set for any oven temperature between 170°F (77°C) and 550°F (288°C).

## CAUTION!

Always use pot holders or oven gloves when using the oven. When cooking the oven interior, oven racks, and cooktop will become very hot. There is a risk of burns!

Benefits of convection cooking include:

- Multiple rack baking.
- Foods may cook faster, saving time and energy.

Baking tips:

- Use Convection Bake for best results when baking cookies on 2 racks.
- Fully preheat the oven before baking items like cookies, cakes, biscuits and breads.
- When baking cakes using two oven racks, place bakeware like shown on the picture below.

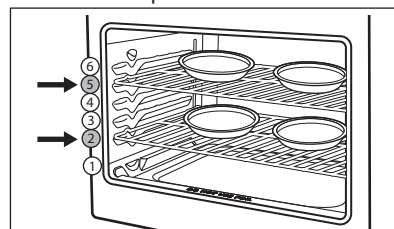

- For single rack baking, use rack position 3.
- For two rack baking, use rack position 2 (flat) and 5 (glide).

- If your recipe is not written for convection baking, reduce the oven temperature by 25° or use Convection Convert option.
- Cookies and biscuits should be baked on pans with no sides or very low side to allow heated air to circulate around the food. Food items baked on pans with a dark finish will cook faster.
- Do not open oven door often. Opening the door will reduce the temperature in the oven and may increase cook time.
- Do not leave oven light on while baking.



**Convection Convert** automatically reduces the oven temperature from what is specified in most baking recipes, to compensate for the increased cooking efficiency of convection baking. Use it to lower the oven temperature by 25°.

To set Convection Bake with a default oven set temperature of 325°F (163°C):

1. Touch **Conv Bake**.  
Default oven temperature of 325°F appears on the display.
2. Select **Convection Convert**, if needed.
3. Touch **START**.
4. Set the **Cook Time**.
5. Touch **START**.
6. When the Cook Time is complete, **Off** appears on the display and oven will turn off.
7. Press **ON/OFF** to return display to show the time of day.

#### 4.7 Setting Air Fry

The Air Fry function works best for single rack baking. It works well with most recipes and can be programmed for temperatures between 170°F and 550°F. Follow the instructions on the food packaging regarding quantity, time, and cooking temperature.

Frigidaire offers an optional Air Fry Tray specifically designed to deliver superior performance.

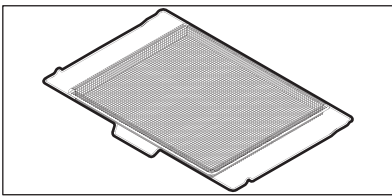

Some benefits of the optional Air Fry tray:

- Tray optimized for oven space.
- Fits in the dishwasher for easy clean-up.
- Higher yield than countertop models.
- Frees up countertop space.
- Compatible with convection ovens.
- If the Air Fry Tray is not supplied with your appliance, you can purchase one from [www.frigidaire.com](http://www.frigidaire.com).

Air Fry tips:

- Food should be arranged in single layers on the Air Fry tray or pan and placed on rack position 3 for best results.
- When using the Air Fry tray, place a large cookie sheet on rack position 1 to catch any crumbs or drippings.
- Leave oven light off when cooking.
- Food may need to be removed early and should be checked at the minimum recommended bake time. However, frozen dense foods and items with cook times less than 15 minutes may require additional time.

To set the Air Fry function:

1. Arrange food on tray/pan as suggested.
2. Select **Air Fry** from Oven Modes.
3. Follow screen prompts.
4. Enter the suggested temperature for particular food.
5. Touch **START**.
6. When preheat tone sounds, place the tray/pan on rack position 3. If using the Air Fry Tray, place baking sheet on rack position 2 to reduce smoke.
7. If you want to set the **Cook Time**, do it after the oven is preheated. Cook Time turns off Air Fry function when the time is finished.

It is recommended to set the timer for the minimum suggested time after preheating and check if the food is ready.

8. When the **Cook Time** is complete, **Off** appears on the display and oven will turn off.
9. Press **ON/OFF** to return display to show the time of day.

Food Type	Quantity (oz.)	Temperature	Cook Time (min.)
Frozen Tater Tots	48	450°F (232°C)	29-33
Frozen Golden Fries	48	425°F (218°C)	25-35
Frozen Chicken Nuggets	48	400°F (205°C)	13-15
Frozen Crispy Chicken Strips	48	400°F (205°C)	20-22
Frozen Hot Wings Bone-In	48	450°F (232°C)	25-28
Frozen Chicken Wings	48	375°F (190°C)	60-65
Fresh Chicken Wings	48	450°F (232°C)	30-40

#### 4.8 Setting Stone-Baked Pizza

Your oven is equipped with the following accessories required for Stone-Baked Pizza:

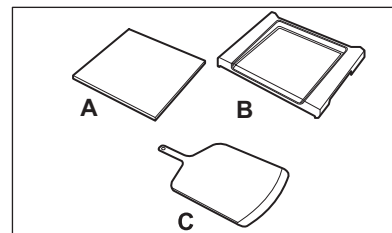

- A. Pizza Stone
- B. Pizza Shield
- C. Pizza Peel

To start the Stone-Baked Pizza function:

1. Press **ON/OFF**.
2. Touch **Stone-Baked Pizza**.
3. Place Pizza Shield (B) with Pizza Stone (A) on the oven rack at the rack position 5. Check the rack position number on the left side of the oven's front frame.

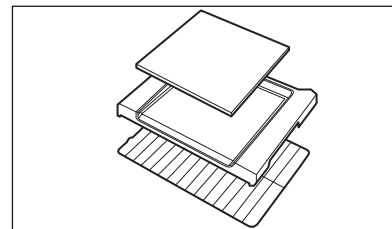

4. Touch **NEXT**.
5. Touch **START** to preheat the oven.  
Preheat will take approximately 30 minutes. Preheat with door closed to avoid extending the preheating time.
6. Place the fresh pizza on the Pizza Peel (C) dusted with cornmeal. This will prevent pizza from sticking to the Peel.
7. When the display shows a message to insert the pizza, slide the pizza from the Peel onto the Pizza Stone with a swift, smooth motion.

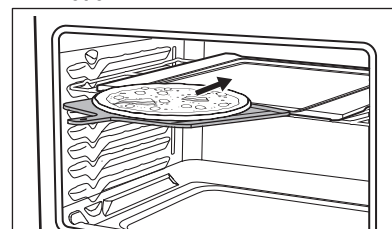

8. Close the oven door and touch **CONFIRM** to start the cooking process.

If you do not confirm the start of the baking process, your pizza may not bake properly.

The baking process will last only 2 minutes.

9. Check if the pizza is ready. If not, press **+15s** to extend the cooking time.

Remember to keep the door closed.

10. When the pizza is ready, remove it by sliding the peel under the pizza, until it touches the backstop on the Pizza Shield. Remove the peel with your pizza from the oven.

11. Press **DONE**.

12. If you would like to prepare another pizza, touch **CONTINUE** on the screen to reheat the Pizza Stone.

If you completed the pizza cooking, press **CANCEL** to stop the function. If you press **CANCEL**, you will need to wait 30 min to cook another pizza.

#### Before using Stone-Baked Pizza:

- Wipe the Pizza Shield, Stone, and Peel with a soft, dry cloth to remove debris. Do not use water on the Pizza Shield.
- To hear timing alerts during the cooking process, touch , go to General Settings and select Volume Level.

#### Prepping and Assembling:

- Select **Stone-Baked Pizza** on the control panel and follow instructions. The oven will preheat for 30 min.
- Prepare your pizzas while the oven is preheating. Stretch your fresh, room-temperature dough on a flat, floured surface - a cutting board or on the countertop).
- Do not stretch or roll out your dough on the Peel.
- Once you have rolled out your dough, sprinkle ½ tsp of cornmeal on the Peel before placing the dough on the peel, ensuring it stays within the 14 inch circular marks.
- Place dough on the cornmeal dusted peel and add your sauce, cheese and toppings. All proteins should be pre-cooked.
- Before placing the pizza into the oven, gently shake the peel to ensure the pizza is not sticking. If needed, lift edges and add more cornmeal.

#### Pro tips for making pizzas:

- Store-bought fresh pizza dough is usually 16 oz (450 g) - enough for two pizzas.
- Let refrigerated dough sit at room temperature for at least 1 h before baking. Frozen dough with vary, follow packaged instructions.
- To shape by hand, press from the center outward avoiding the edges for a lighter, puffier crust.
- If the dough keeps shrinking back, let it rest for 5-10 minutes.
- If the dough tears, pinch it back together or let it rest for a few minutes.
- A pizza roller creates a more uniform shape but may result in a less puffy crust.
- Too many toppings or too much sauce can make the crust soggy and difficult to cook evenly.
- Add fresh ingredients like basil and arugula after cooking for the best flavor.
- Fresh, high-moisture mozzarella works better than shredded mozzarella cheese.

#### CAUTION!

The Pizza Stone is very hot, may cause serious burns! Wait at least one hour before removing it from the oven. Always use protective gloves or mittens.

To clean the Pizza Stone, run the Stone-Baked Pizza Function with just Shield and Stone in place. Once the Stone and the Shield has cooled down, sweep out the ashes and discard.

#### WARNING!

- Remove and dispose of all packaging materials from pizza kit.
- Only use pizza kit with original appliance, do not use in other cooking devices.
- Do not leave Pizza Peel on Stone to cook pizza.
- Do not use hands to push pizza onto Stone.
- Do not touch hot Stone with bare hands.
- Do not submerge the Stone in the water or clean it in dishwasher.
- Do not cook other meals with the Pizza Shield and stone inside the oven cavity.
- Some toppings may need to be pre-cooked if they cannot cook in 2 minutes.
- Do not use this stone baking system in other ranges.
- Do not take Pizza Stone or Shield out while hot.
- Do not use Stone-Baked Pizza mode for Frozen Pizza. It is designed for Fresh Pizza only. Placing a frozen pizza on the Pizza Stone may cause the Stone to crack.

#### IMPORTANT

The Pizza Shield and Pizza Stone may discolor over time, due to cooking. This does not affect the use of the stone baking system.

#### 4.9 No Preheat

The function is available for single-rack baking with packaged and convenience foods. You can also use it with regular recipes. Use the function with temperatures between 170°F (77°C) and 550°F (288°C). Follow the recipe or package directions for food preparation time and temperature.

During the function:

- The oven elements cycle on and off.
  - The convection fan turns on until you cancel the function.
- Cooking times may vary depending on your preference for doneness. Watch the food closely.

#### CAUTION!

Always use pot holders or oven mitts when using the oven. The oven interior, oven racks, and cooktop become very hot during cooking. These hot surfaces can cause burns.

Important:

- Always place food on rack position 3.
- When using the function, use bakeware with low or no sides. This allows the air to circulate around the food evenly.
- Follow the package directions for food preparation time and temperature.
- Food may need to be removed early. Check it at the minimum recommended cook time.
- The function works best when cooking foods longer than 10 minutes. If directions call for a shorter cooking time, a few extra minutes may be required for optimal cooking results.
- Do not open the oven door often. Opening the door reduces the temperature in the oven and may increase cook time.

To set the function temperature for 350°F:

1. Arrange the interior oven racks.
2. Position bakeware in the oven.
3. Press **ON/OFF** key.
4. Select **No Preheat** from Oven Modes.
5. Follow the tips and set the temperature, or use the default 350°F.
6. Touch **START**.
7. Set **Cook Time** if needed.
8. Touch **START**.

#### NOTE

If you set a Cook Time, the oven turns off automatically when the time expires. Foods with a Cook Time under 10 minutes may need extra time.

9. When cooking has ended, the display will show **Off**.
10. Press **ON/OFF** to return display to show the time of day. To cancel cooking at any time, touch **CANCEL**.

## 4.10 Air SousVide Tips

Sous Vide is ideal for cooking meats to achieve tenderness without overcooking.

How Sous Vide Works:

Sous Vide is a French term meaning "under vacuum". It involves vacuum-sealing food in plastic pouches and then cooking it using hot water or air. The appliance uses hot air circulating around sealed pouches to cook food slowly at relatively low temperatures: 100°F to 205°F (38°C to 94°C).

Benefits of Sous Vide:

- Food does not lose flavor or aroma due to evaporation.
- Vitamins and minerals do not escape during cooking.
- The low cooking temperature leaves meat and fish more tender.
- Less spice is needed, as food keeps more of its natural flavor.
- The low cooking temperature greatly reduces the risk of overcooking. The food never gets hotter than the intended serving temperature.
- Timing is less critical. If different dishes are finishing at different times, food that has reached serving temperature can wait, since it stays at serving temperature in the cooking medium.

Food Safety:

Because Sous Vide cooks at relatively low temperatures, safe food handling is especially important:

- Always keep raw food in safe conditions before you start cooking.
- Clean the raw food before you start cooking.
- Use Sous Vide Table below to find the recommended cooking time and temperature for the food.
- Food should be between 34°F and 37°F (normal refrigerator temperatures) when preparing to place food in Sous Vide vacuum pouch.
- Sous Vide dishes are best served immediately after cooking. If food is not served immediately, use an ice bath to chill it quickly and then keep it refrigerated for up to 3 days.
- Do not use Sous Vide to reheat leftovers.
- Do not allow raw food to contact cooked food during preparation. Do not use the same tools on different food items without washing them.
- If the recipe includes raw eggs, keep the whites and yolks from touching the outsides of the shells.
- Blanching in boiling water or searing in a pan before Sous Vide cooking can destroy surface bacteria to improve food safety.
- Do not use Delay Start with the Sous Vide function.
- Do not use a meat probe with the Sous Vide function. Food needs to be sealed air-tight in a pouch for Sous Vide cooking.

Sous Vide Table:

Food	Doneness	Temperature	Cooking Time		
			Minimum	Target	Maximum
<b>Beef</b>					
Steak	Rare	130°F / 54°C-55°C	2 h	3 h	4h
Steak	Medium Rare	135°F / 57°C-58°C	2 h	3 h	4 h
Steak	Medium	145°F / 62°C-63°C	2 h	3h	4h
Steak	Medium Well	150°F / 65°C-66°C	2 h	3 h	4 h
Steak	Well	160°F / 71°C-72°C	2 h	3h	4 h
Roast	Rare	135°F / 57°C-58°C	6 h	7h	16 h
Roast	Medium Rare	140°F / 60°C	6 h	7h	16 h
Roast	Medium	150°F / 65°C-66°C	6 h	7h	16 h
Roast	Medium Well	155°F / 68°C-69°C	6 h	7h	16 h
Roast	Well	160°F / 71°C-72°C	6 h	7 h	16 h
Chuck/Brisket	Rare	140°F / 60°C	20 h	24h	48 h
Chuck/Brisket	Medium Rare	150°F / 65°C-66°C	20 h	24h	48 h
Chuck/Brisket	Well	180°F / 82°C-83°C	20 h	24 h	48 h
<b>Pork</b>					
Chop	Medium	150°F / 65°C-66°C	2 h	3h	4 h
Chop	Well	160°F / 71°C-72°C	2 h	3 h	4 h
Roast	Medium	150°F / 65°C-66°C	2 h	3h	4 h
Roast	Well	180°F / 82°C-83°C	2 h	3h	4 h
Shoulder/Belly	Medium	150°F / 65°C-66°C	10 h	24h	48 h
Shoulder/Belly	Well	180°F / 82°C-83°C	10 h	24h	48h
<b>Chicken</b>					
Parts	Tender	170°F / 76°C-77°C	2 h	2-1/2 h	4h
<b>Fish</b>					
Steak	Tender	105°F / 40°C-41°C	1 h	1-1 1/2h	2h
Steak	Flaky	125°F / 51°C-52°C	1 h	1-1 1/2h	2 h
Steak	Well	145°F / 62°C-63°C	1 h	2 h	2 h
Fillet	Tender	105°F / 40°C-41°C	45 min	1h	1-1 1/2h
Fillet	Flaky	125°F / 51°C-52°C	45 min	1 h	1-1 1/2 h

Food	Doneness	Temperature	Cooking Time		
			Minimum	Target	Maximum
Fillet	Well	145°F / 62°C-63°C	45 min	1h	1-1 1/2 h
<b>Vegetables</b>					
Squash	Cubes	180°F / 82°C-83°C	1 h	1-1 1/2h	4 h
Roots	Sliced/Cubes	180°F / 82°C-83°C	1 h	1-1 1/2 h	4 h
Potatoes	Sliced/Cubes	200°F / 93°C-94°C	1 h	1-1 1/2 h	4 h
<b>Fruits</b>					
Warm/Ripe	Sliced/Cubes	155°F / 68°C-69°C	45 h	105min	2 1/2 h
Soft	Purees	180°F / 82°C-83°C	15 min	30 min	90 min

Steak thickness based on 1.5". Thicker cuts may require longer times.

#### 4.11 Vacuum Sealing for Sous Vide

Sous Vide cooking in your oven requires a vacuum sealer and vacuum pouches. The pouch needs to be sealed so no air or liquid can leak out. A pouch that leaks will produce poor cooking results and may produce smoke and residue that can burn during future cooking, or when using Self Clean. Follow the instructions that come with your sealer and pouches.

- Use pouches that are specified for your sealer and for Sous Vide cooking.
- Do not reuse vacuum pouches.
- Put food in one layer in the pouch for even cooking.
- It is recommended to use one food portion per vacuum pouch.
- For most Sous Vide cooking, use the highest vacuum setting for best cooking results.
- Make sure that the closure of the pouch is clean to get a good seal. If cooking at higher temperatures (above 160°F / 71°C), double-seal the pouch.
- Vacuum pouches are solely for Sous Vide cooking and should not be used for regular baking or broiling.

#### 4.12 Sous Vide Cooking

##### NOTE

If cooking multiple items at once, you may want to write the contents on the outside of the pouches before filling and sealing them.

1. Prepare the food and cut all of the ingredients.
2. Place the ingredients in the plastic pouch for your vacuum sealer. Add seasonings for cooking.
3. Vacuum seal the pouch, ensuring all air is removed and the seal is air-tight. If not cooking immediately, store the pouch in a refrigerator until it is ready to cook.

#### Setting Sous Vide

##### IMPORTANT

Since Sous Vide cooking allows for a suggested minimum cooking time and a target time, it is recommended to set the timer to at least the minimum time or to any time up to the target suggested time. With Sous Vide cooking, there is a maximum cooking time which allows the user more flexibility when cooking with no specific end time.

##### NOTE

Use the settings recommended for the type of food in Sous Vide table.

##### CAUTION!

Even though Sous Vide cooks at relatively low temperatures, use care when handling the pouch and its contents, which will be hot to the touch. Only use temperatures below 140°F (60°C) for cooking foods that can be safely eaten raw.

##### IMPORTANT

The U.S. Department of Agriculture states, "Rare fresh beef is popular, but you should know that cooking it to only 140°F (60°C) means some food poisoning organisms may survive." (Source: Safe Food Book, Your Kitchen Guide, USDA) The lowest temperature recommended by the USDA is 145°F (63°C) for medium rare fresh beef. For beef medium 160°F, well done 170°F (77°C). Visit the USDA Food Safety and Inspection website at [www.fsis.usda.gov](http://www.fsis.usda.gov).

To set Air SousVide:

1. Select **Slow Cook** from Oven Modes and choose **Air SousVide** from the submenu.
  2. Touch **Air SousVide**.
- Display shows the default temperature 130°F (54°C).
3. Set the temperature or use the default setting.
  4. Touch **START**.
- To cancel cooking at anytime press **OFF**.
5. Open the plastic pouch, remove the food.
  6. Finish with a final searing or grilling for a nice crust and roast flavor.
  7. Add final seasonings or sauces if needed, and serve.

#### 4.13 Setting Dehydrate

For best results when dehydrating food use the Air Fry Tray which allows air to circulate all around the food for faster preservation.

The optional Air Fry tray may be purchased from [www.frigidaire.com](http://www.frigidaire.com).

Tips:

- Always use clean equipment and utensils.
- Keep meat and poultry refrigerated below 40°F (4°C) before dehydrating.
- Cut food in evenly sized pieces. Slices should be even and ¼ to ½ inch thick. This will ensure all pieces are dehydrated at the same time.
- Use good quality fruits, vegetables, and meats. Overripe or bruised fruits and vegetables may turn black while dehydrating.
- Use lean cuts of meat or trim off excess fat.
- Use a paper towel to dry meat before dehydrating.
- Store dehydrated foods in airtight containers. If moisture appears in containers, the food was not dehydrated properly.
- Follow USDA (U.S. Department of Agriculture) recommendation when dehydrating.

To set Dehydrate:

1. Arrange food in a single layer on the Air Fry Tray.
2. Select **Slow Cook** from Oven Modes and choose **Dehydrate** from the submenu.
3. Set the temperature.
4. Touch **START**.
5. Press **ON/OFF** to end cooking and return display to show the time of day.

##### i

Check food for doneness. If any moisture is present, allow food to dehydrate longer.

## Dehydration Temperature and Time Suggestions

Food	Temperature	Hours
Herbs, flowers	95°F - 35°C	6 - 10
Vegetables	125°F - 52°C	
• Tomatoes		8 - 20
• Peppers		6 - 12
• Mushrooms		6 - 12
Meat	165°F - 74°C	6 - 18
Root Vegetables	165°F - 74°C	
• Carrots		6 - 10
• Potatoes		10 - 15
Citrus Peel	135°F - 57°C	8 - 15
Fruit	145°F - 63°C	
• Apples		5 - 7
• Bananas		8 - 20
• Strawberries		8 - 20
• Peaches		12 - 18
Fish	145°F - 63°C	8 - 12
Fruit Rolls/Leather	165°F - 74°C	8 - 18
Nuts and Seeds	150°F - 66°C	8 - 20

### 4.14 Setting Bread Proof

Bread proofing creates the best conditions for yeast to multiply and cause your dough to rise.

To set Bread Proof:

1. Select **Slow Cook** from Oven Modes and choose **Bread Proof** from the submenu.
  2. Touch **Bread Proof**.
- Bread Proof** and 100°F appears on the display.
3. Touch **START**.



Check your food often, to prevent over-proofing.

### 4.15 Setting Slow Cooker

Use this function for foods that will cook or braise at low temperature for a long period of time.

For best results when using Slow Cooker:

- Completely thaw all frozen foods before cooking.
- When using a single oven rack, place in oven rack position 2 or 3. Position racks to accommodate the size of various bakeware when cooking multiple food items.
- Do not open the oven door often or leave the door open when checking foods. If the oven heat escapes often, the cooking time may need to be extended.
- Cover the food to keep it moist or use a loose or vented type cover.

### Convection roasting recommendations:

Meat	Weight	Oven Temp	Internal Temp	Mins per lb
Beef	Standing rib roast	350°F (177°C)	160°F (71°C) <b>1</b>	25 - 30
	Rib eye roast	350°F (177°C)	160°F (71°C) <b>1</b>	25 - 30
	Tenderloin roast	400°F (204°C)	160°F (71°C) <b>1</b>	15 - 25

- Cook times will vary depending on the weight, fat content, bone, and the shape of the roast. Preheating the oven will not be necessary when using the Slow Cooker feature.
  - Add any cream or cheese sauces during the last hour.
- Slow cooking meats may result in the outside of the meat turning dark; this is normal.

To set Slow Cooker:

1. Select **Slow Cook** from Oven Modes and choose **Slow Cooker** from the submenu.
  2. The display shows: Low, Medium and High options.
  3. Select one of the modes and follow the instruction on the display.
  4. Touch **START**.
  5. Set the **Cook Time**, if needed.
  6. Touch **START**.
  7. When the **Cook Time** is complete, **Off** appears on the display and oven will turn off.
  8. Press **ON/OFF** to return display to show the time of day.
- To cancel cooking at anytime press **CANCEL**.

### 4.16 Setting Convection Roast

Convection roast combines a cook cycle with the convection fan and elements to rapidly roast meats and poultry. Hot air circulates around the meat from all sides, sealing in juices and flavors. Meats cooked with this feature are crispy and brown on the outside while staying moist inside.

#### **WARNING!**

Should an oven fire occur, close the oven door and turn the oven off. If the fire continues, use a fire extinguisher. Do not put water or flour on the fire. Flour may be explosive and water can cause a grease fire to spread and cause personal injury.

#### **CAUTION!**

Always use pot holders or oven mitts when using the oven. When cooking, the oven interior, oven exterior and oven racks will become very hot which can cause burns.

To use convection roast at a temperature of 350°F (177°C):

1. Touch **Oven Modes**, scroll to **Convection Roast** and touch.
2. Set the desired temperature or use default of 350°F.
3. Touch **START**.
4. Set Cook Time, if desired.
5. Touch **START**. Preheating the oven is not necessary.
6. When cooking is completed or to cancel Convection Roast at any time, press **ON/OFF**.

Convection Roasting Tips:

- Preheating for convection roast is not necessary for most meats and poultry.
- Arrange oven racks so large cuts of meat and poultry are on the lowest rack of the oven.
- Since convection roast cooks faster, may be able to reduce cook times as much as 25% from the recommended time of your recipe (check the food at this time). Then if needed, increase cook time until the desired doneness is obtained.
- Do not cover foods when dry roasting - covering will prevent the meat from browning properly.
- When cooking meats use a broiler pan and insert. The broiler pan will catch grease spills and the insert helps prevent grease splatters.

	Meat	Weight	Oven Temp	Internal Temp	Mins per lb
Poultry	Turkey whole <sup>2)</sup>	12 - 16 lb	325°F (163°C)	180°F (82°C)	8 - 10
	Turkey whole <sup>2)</sup>	16 - 20 lb	325°F (163°C)	180°F (82°C)	10 - 15
	Turkey whole <sup>2)</sup>	20 - 24 lb	325°F (163°C)	180°F (82°C)	12 - 16
	Chicken	3 - 4 lb	350°F - 375°F (177°C - 191°C)	180°F (82°C)	12 - 16
Pork	Ham roast, fresh	4 - 6 lb	325°F (163°C)	160°F (71°C)	30 - 40
	Shoulder blade roast	4 - 6 lb	325°F (163°C)	160°F (71°C)	20 - 30
	Loin	3 - 4 lb	325°F (163°C)	160°F (71°C)	20 - 25
	Pre-cooked ham	5 - 7 lb	325°F (163°C)	160°F (71°C)	30 - 40

<sup>1)</sup> The U.S. Department of Agriculture states, "Rare fresh beef is popular, but you should know that cooking it to only 140°F (60°C) means some food poisoning organisms may survive." (Source: Safe Food Book, Your Kitchen Guide) The lowest temperature recommended by the USDA is 145°F (63°C) for medium rare fresh beef. For well done 170°F (77°C).

<sup>2)</sup> Stuffed turkey requires additional roasting time. Shield legs and breast with foil to prevent over browning and drying of the skin.

#### 4.17 Setting Broil

Use the Broil function to cook foods that require direct exposure to radiant heat for optimum browning results. Broiling may produce smoke. If smoke is excessive, place food further away from the heating element.

#### WARNING!

Should an oven fire occur, leave the oven door closed and turn off the oven. If the fire continues, use a fire extinguisher. Do not put water or flour on the fire. Flour may be explosive and water can cause a grease fire to spread and cause personal injury.

#### CAUTION!

Always use pot holders or oven gloves when using the oven. When cooking the oven interior, oven racks, and cooktop will become very hot. There is a risk of burns!

#### IMPORTANT

Broiler pans and inserts allow the grease to drain away from the high heat of the broiler. Do not use the pan without the insert. Do not cover the insert with foil – the exposed grease could ignite.

To set broil with the default broil temperature of 550°F (288°C):

1. Place the racks in the oven while they are still cold.
2. For optimum browning results, preheat oven for 2 minutes before adding food. Broil with oven door closed.
3. Place the bakeware in the oven.
4. Touch **Oven Modes** and touch **Broil**.
5. Set the desired temperature or use default of 550°F (288°C).
6. Touch **START**.
7. Broil on one side until food is browned; turn and broil other side until done to your satisfaction.
8. When finished broiling, press **ON/OFF**.

#### 4.18 Notes for Broiling

- Always arrange oven racks when the oven is cool.
- Broil with oven door closed. If broiling with door open, an alarm will sound alerting you to close the door. If left open, the Broil function will be canceled.
- For best results, use a broil pan with broil pan insert designed to drain the fat from the food, help avoid spatter and reduce smoking.
- When broiling, always pull the oven rack out to the stop position before turning or removing food.
- If a broiler pan and insert are not supplied with this appliance, they may be purchased from [www.frigidaire.com](http://www.frigidaire.com).

#### NOTE

Broiling is direct heat cooking and will produce some smoke. If smoke is excessive, place food further away from element. Always watch foods carefully to prevent burning.

#### 4.19 Setting Multi Racks

This function can be used for baking on up to two racks while following recommended time and temperature. The oven will make adjustments for best results.

Useful tips:

- Follow recipe for time and temp and the oven will make needed adjustments for best performance.
- Fully preheat the oven for best results.
- Allow at least 2 inches (5 cm) of space between bakeware for proper air circulation.
- Use flat rack in position 2 and glide rack in position 5.
- Leave oven lights off while baking.

To use Multi Racks:

1. Arrange the oven racks when cool.
2. Touch **Oven Modes** and touch **Multi Racks**.
3. Set the desired temperature or use default of 350°F.
4. Touch **START**.
5. Set Cook Time, if desired.
6. Touch **START**.
7. When the **Cook Time** is complete, **Off** appears on the display and oven will turn off.
8. Press **ON/OFF** to return display to show the time of day.

#### 4.20 Cooking with Steam Tips

#### NOTE

More moisture presents than during conventional baking or roasting. Moisture could condense on the handle or in the door. Depending on the conditions in your kitchen, it may drip onto the floor.

#### Oven Positioning

- Use the flat rack in the lowest position in the oven for most foods when using Steam Roast.

#### Preparing

- Use 2.5 cups of water for Steam Bake and Steam Roast. If you frequently use steam functions, use distilled water.
- Using a water container, pour water slowly onto the bottom of the oven cavity while it is still cool.
- Never add water if the oven is warm.
- Never add water during a Steam Bake or Steam Roast cycle.

#### While in Use

- When using Steam, follow the recipe for preheating, cook time, and cook temperature.
- Always start with a cold oven.
- Preheating is not necessary when using Steam Roast.

#### Cleaning

- With a paper towel lightly soaked in distilled white vinegar, wipe out the bottom of the oven cavity after the oven cools or before each use.
- Use the Self Clean function to clean heavily soiled areas.

- If residue remains after self-clean, pour a thin layer of distilled white vinegar onto the bottom of the oven cavity. Allow it to sit for 30 minutes. Wipe out the vinegar.

#### Setting Steam Bake

Steam creates the best conditions for baking bread on a single rack. Baked goods have improved browning and texture. Steam is recommended for baking moist and flavorful breads and pastries such as baguettes and croissants.

Use the flat rack in position 3 for the best results with Steam Bake.

To set the function:

1. Touch **Oven Modes** and touch **Steam Bake**.
2. Add 2.5 cups of water to the oven bottom as directed.

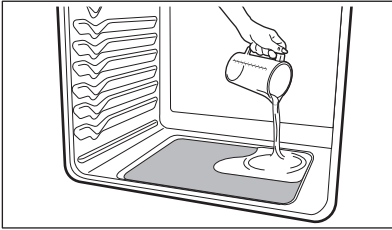

3. Touch **NEXT** and follow Steam Bake instruction for setting temperature.
4. Touch **START**.
5. Set Cook Time if desired. It is suggested to wait to set Cook Time until the oven preheats.
6. When the cooking time is off, **Off** appears on the display and oven will turn off.
7. Press **ON/OFF** to return display to show the time of day.

#### Setting Steam Roast

Steam creates the best conditions for roasting proteins. Meats are crisp outside and juicy inside. Steam Roast is recommended for meat or poultry.

Use the flat rack in position 1 for the best results with Steam Roast.

To set the function:

1. Touch **Oven Modes** and touch **Steam Roast**.
2. Add 2.5 cups of water to the oven bottom as directed.

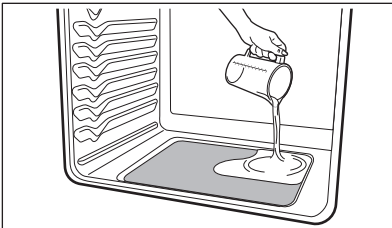

3. Touch **NEXT** and follow Steam Roast instruction for setting temperature.
4. Touch **START**.
5. Set Cook Time if desired. It is suggested to wait to set Cook Time until the oven preheats.
6. When the cooking time is off, **Off** appears on the display and oven will turn off.
7. Press **ON/OFF** to return display to show the time of day.

#### ⚠ CAUTION!

Do not set Steam Bake or Steam Roast for cooking at temperatures below 325°F (163°C).

#### 📌 IMPORTANT

Stand to the side of the oven when opening it to allow any steam to escape.

#### 4.21 Keep Warm

Keep Warm should only be used with foods that are fully cooked and at serving temperatures. Keep Warm will keep foods warm and ready for serving at 140° F - 200° F (60°C - 93°C). If needed, arrange oven racks and place cooked food in oven.

To set Keep Warm:

1. Touch **Oven Modes** and touch **Keep Warm**.

If no other keys are touched within 25 seconds, the request for Warm will clear.

2. Set the desired temperature.

3. Touch **START**.

To cancel this function at any time touch **CANCEL**.

#### 4.22 Self Clean

This function cleans the oven interior with very high temperatures (well above normal cooking temperatures), eliminating soils completely or reducing them to very fine powdered ashes you can wipe away afterwards with a damp cloth.

A self clean cycle runs for 2-4 hours.

Before starting a Self Clean cycle, read all following caution and important statements.

#### ⚠ CAUTION!

- Do not leave small children unattended near appliance. During Self Clean cycle, the outside of the oven can become very hot and cause burns if touched.
- Do not line the oven walls, racks, oven bottom, or any part of the appliance with aluminum foil. It will melt causing permanent damage to the oven interior and disrupt heat distribution.
- Do not force the oven door open. This will damage the automatic door locking system. Be careful when opening the oven door after the Self Clean cycle ends. The oven may still be very hot and cause burns. To avoid possible burns, stand to side of oven when opening door to allow steam or hot air to escape.
- The health of some birds is extremely sensitive to fumes given off during the Self Clean cycle of any range. Move birds to a well ventilated room.

#### 📌 IMPORTANT

- Completely remove all oven racks and any accessories from oven cavity to avoid damage to oven racks. If the oven racks are not removed they may discolor.
- Remove all items from the oven, including cookware, utensils, and any aluminum foil. Aluminum foil will melt when exposed to very hot temperatures.
- Do not spray oven cleaners or oven protective coatings in or around any part of the oven interior. Clean any soil from the oven frame, the door liner outside the oven door gasket, and the small area at the front center of the oven bottom. These areas heat sufficiently to burn soil on. Clean using soap and water prior to starting Self Clean.
- Remove any excessive spills. Any spills on the oven bottom should be wiped up and removed before starting a Self Clean cycle. To clean use hot, soapy water and a cloth. Large spills can cause heavy smoke or fire when subjected to high temperatures.
- Do not allow food spills with high sugar or acid content (such as milk, tomatoes, sauerkraut, fruit juices, or pie fillings) to remain on the surface, as they may leave a dull spot, even after cleaning.
- Do not clean the oven door gasket. The woven material in the gasket is essential for a good seal. Do not rub, damage, or remove the oven door gasket. This may compromise the performance of the oven.
- The kitchen area should be well ventilated using an open window, ventilation fan, or exhaust hood during the first Self Clean cycle. This will help eliminate the odors typical for Self Clean.
- Do not attempt to open the oven door when light is flashing. Allow about 15 seconds for the motorized door latch mechanism to completely lock or unlock the oven door.
- When the clean time finishes, the door will remain locked until the oven has cooled sufficiently. Wait one hour before opening the oven door.

#### 4.23 Setting Self Clean

Remove all items from the oven, including oven racks. Be sure oven door is completely closed.

To set the function:

1. Touch **Oven Modes** and touch **Self Clean**.
2. Select Self Clean duration: 2, 3 or 4 hours.
3. Press  to start the Self Clean cycle. When the Self Clean cycle is on, the door will be locked in about 15 seconds and **CLEAN** will appear on the display. Do not force the door open as it can damage the automatic door locking system.
4. When Self Clean is finished, **CLEAN** message will disappear, and **Hot** will appear on the display.
5. Once the oven has cooled down and **Hot** is no longer displayed, you can open the oven door.

### **CAUTION!**

Be careful when opening the oven door after the Self Clean cycle. There is a risk of burns! Stand to the side of the oven when opening the door to allow hot steam and air to escape.

When the oven interior has completely cooled, wipe away any residue or powdered ash with a damp cloth or paper towel.

### Self Clean with Delayed Start

You can delay start of the Self Clean function (available only for default 3 hours cleaning cycle).

To do this:

1. Press **ON/OFF**.
2. Touch **Oven Modes** and touch **Delay Start**.
3. Touch **NEXT**.
4. Scroll **Oven Modes** to **Self Clean** and touch.
5. Follow the information on the screen to set delay time and Self Clean duration.
6. Press  to start the Self Clean cycle.

If you need to cancel the Self Clean cycle before its end:

- Press **OFF**.
- If self clean has heated the oven to a high temperature, allow enough time for the oven to cool.
- If a power failure occurs during a cleaning cycle or if the function is canceled before the oven was thoroughly cleaned, it may be necessary to run another Self Clean cycle.
- If the oven temperature was high enough when Self Clean was interrupted, the oven control may not allow another Self Clean cycle to be set for up to 4 hours.

### 4.24 Steam Clean

The Steam Clean feature offers a chemical free and time saving method to assist in the routine cleaning of small and light soils. For heavier baked on soils use the Self Clean feature.

Be sure the oven is level and cool before starting Steam Clean. If the oven temperature is above room temperature, a triple beep will be heard, and the function will not start. Steam Clean produces best results when started with a cool oven.

### **CAUTION!**

Do not add bleach, ammonia, oven cleaner, or any other abrasive household cleaners to the water used for Steam Clean. Before cleaning any part of the oven, be sure all controls are turned off and the oven is cool. There is a risk of burns!

To set a Steam Clean cycle:

1. Remove all racks and oven accessories.
2. Scrape or wipe loose debris and grease from the oven bottom.
3. Pour 1 cup of tap water onto the oven bottom. Close oven door.

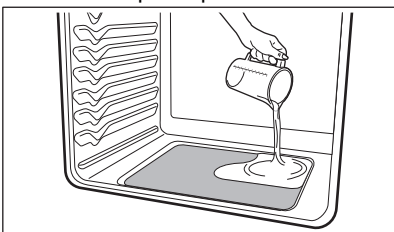

4. Touch **Oven Modes** and touch **Steam Clean**

5. Touch **START**.
6. The time left for the Steam Clean cycle is shown on the display. Do not open the door during this time. If door is open while in Steam Clean, "**d-O**" will appear on the display after a few minutes.
7. When the Steam Clean cycle is complete, an alert will sound, and the **Off** message will show on the display.
8. Press **OFF** to return display to show the time of day.
9. Carefully open the door when the Steam Clean is finished. Stand to the side of the oven, hot air will come out from inside the oven.
10. Wipe oven cavity and bottom. Do not clean oven door gasket. Avoid leaning or resting on the oven door glass while cleaning the cavity.

Notes:

- Opening the oven door during the Steam Clean cycle prevents the water from reaching the temperature needed to clean.
- For best results, clean oven immediately after the cycle is complete. Steam Clean works best for soils on the oven bottom.
- A non-abrasive scouring pad, stainless steel sponge, plastic scraper, or eraser style cleaning pad (without cleaner) can be used for difficult soils. Moisten pads with water before use.
- Place a paper towel or cloth in front of the oven to capture any water that may spill while wiping out.
- Do not leave the residual water in the oven for any length of time.
- Some condensation or water vapor may appear close to the oven vent and the oven door glass. This is normal. The oven gasket may become damp, do not wipe them dry.
- Local water sources often contain minerals (hard water). If hard water deposits occur, wipe cavity with a 50/50 solution of water and vinegar or 50/50 solution of water and lemon juice.
- Steam Clean cannot be programmed with a Delay Start feature.
- If the Steam Clean results are not satisfactory, run a Self Clean feature.

### 4.25 Cooking with Food Probe

Use the probe feature for best results when cooking foods such as roasts, hams, or poultry.

The Food Probe works with the following functions: Bake, Convection Bake, Air Fry, Convection Roast, and Steam Roast.

The probe function, when set correctly, will signal an alert when the internal food temperature reaches the desired set target temperature. The probe settings for how the oven behaves should be set first in the settings menu.

When active, the probe displays the internal food temperature which is visible in the display during the cooking process. This eliminates any guesswork or the need to open the oven door to check the thermometer. For meats like poultry and roasts, using a probe to check internal temperature is the safest method to ensure properly cooked food.

For meats like poultry and roasts, using a probe to check internal temperature is the safest method to ensure properly cooked food.

Proper placement of probe in food:

### **CAUTION!**

Do not use kitchen utensils to pull on the probe cable or handles. Always insert and remove the probe using the provided handles and always use a pot holder to protect hands from possible burns.

Insert the probe so that the probe tip rests inside the center of the thickest part of meat or food. For best results, do not allow the probe temperature sensor to contact bone, fat, gristle, or the cookware.

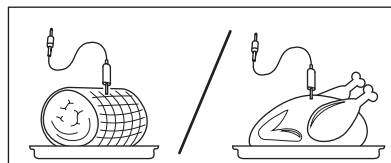

- For bone-in ham or lamb, insert the probe into the center of lowest large muscle or joint.
- For meat loaf or casseroles, insert the probe into center of food.
- When cooking fish, insert meat probe just above the gill.

- For whole poultry or turkey, fully insert the probe sensor into the thickest part of the breast.

**USDA recommended minimum internal cooking temperatures:**

Food Type	Internal Temp.
Ground meat and meat mixtures	
Beef <sup>1)</sup> , Pork, Veal, Lamb	160 °F (71°C)
Turkey, Chicken	165 °F (74°C)
Fresh beef, veal, lamb	
Medium rare +	145 °F (63°C)
Medium	160 °F (71°C)
Well Done	170 °F (77°C)
Chicken and Turkey, whole	165 °F (74°C)
Poultry Breasts, Roasts	165 °F (74°C)
Poultry Thighs, Wings	165 °F (74°C)
Stuffing (cooked alone or in bird)	165 °F (74°C)
Ham Fresh (raw)	160 °F (71°C)
Ham Pre-cooked (to reheat)	140 °F (60°C)
Eggs dishes	160 °F (71°C)
Leftovers and Casseroles	165 °F (74°C)

<sup>1)</sup> The U.S. Department of Agriculture states, "Rare fresh beef is popular, but you should know that cooking it to only 140°F (60°C) means some food poisoning organisms may survive." (Source: Safe Food Book, Your Kitchen Guide, USDA) Visit the USDA Food Safety and Inspection website at [www.fsis.usda.gov](http://www.fsis.usda.gov)

#### 4.26 Setting Food Probe



During cooking, the internal food temperature will display in the center of the screen, while the oven temperature will be displayed at the bottom of the screen.

To assure accuracy, do not remove the probe from the food or receptacle until the desired internal temperature is reached. If the probe is removed from the receptacle only, the probe feature will cancel and the oven will turn off. If the probe is only removed from the food, the probe feature will remain active and may eventually generate a "probe too hot" message. To change the target (internal food) temperature or the set oven temperature touch the one you want to change and use the number keys to adjust the temperature.

#### IMPORTANT

- Do not store the probe inside the oven.
- Use only the original probe provided. Connecting any other probe or device could result in damage to the oven control, electronics, and the receptacle.
- Before starting Self Clean, double check that the probe is removed from the oven interior.
- Defrost frozen foods completely before inserting the probe.

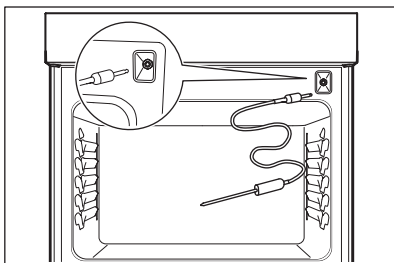

To set Food Probe for turkey:

- Touch **Oven Modes** and scroll to **Food Probe**.
- The display will remind you to insert the probe into the turkey and place in oven on rack position 1.
- Display reminds you to connect the food probe to the receptacle before setting oven mode.

- Touch **NEXT**.
- Touch **Turkey** in **Oven Modes**.
- Set target food temperature after pressing **NEXT**.
- Set oven temperature and touch **START**.

When the target temperature of the turkey (internal temperature) is reached, the oven will turn off if set for cooking to stop in the Oven Menu settings.

To set Food Probe for any other dish:

- Touch **Oven Modes** and scroll to **Food Probe**.
- Follow the directions visible on the display.

#### 4.27 Setting the Sabbath Feature for the Jewish Sabbath and Holidays (some models)



For further assistance, guidelines for proper usage, and a complete list of models with the Sabbath feature, please visit the web at [www.star-k.org](http://www.star-k.org).

This appliance provides special settings for use when observing the Jewish Sabbath/Holidays. Sabbath mode disables all audible tones or visual display changes on the oven control. Bake is the only cooking feature available while in the Sabbath mode. Most oven controls are locked during Sabbath mode.

To set Sabbath Mode:

- Touch the **Menu Options** bar and scroll to **Sabbath Mode**.
- Touch **Sabbath Mode** and follow the instructions on the display.
- Select delay (if needed), baking temperature and Cook Time (if needed).

Cooking will start after the set delay time.

- To exit Sabbath Mode, press and hold **EXIT** for three seconds.
- If Cook Time was set, once the time has elapsed, the cooking will end and the display will show Idle to indicate that the cook time has ended.

#### IMPORTANT

The Sabbath mode will override the factory preset 12 hour energy saving mode, and the appliance will stay on until the cooking features are canceled. If cooking is canceled when the appliance is in the Sabbath mode, no audible or visual indicators will be available to verify the cancellation.

If the oven interior lights are needed, be sure to activate them prior to setting the Sabbath mode. Once the oven light is turned on and the Sabbath mode is active, the oven light will remain on until the Sabbath mode is turned off and the oven lights are turned off. The oven door will not activate the interior oven lights when the oven door is opened or closed.

It is recommended that any oven temperature modification made within an active Sabbath mode press + or - keys. Each press of the key will change the temperature by 5°F (1°C) and the change will be accepted automatically.

#### WARNING!

**Food poisoning hazard.** Do not let food sit for more than one hour before or after cooking. Doing so can result in food poisoning or sickness. Foods that can easily spoil such as milk, eggs, fish, meat or poultry, should be chilled in the refrigerator first. Even when chilled, they should not stand in the oven for more than 1 hour before cooking begins, and should be removed promptly when finished cooking.

Important:

- Do not attempt to activate any other oven function except Bake while the Sabbath feature is active. When the Sabbath feature is active, only + and - keys and **OFF** will function. All other keys should not be used once the Sabbath feature is active.
- You may change the oven temperature once baking has started. Use the + and - keys to adjust the oven temperature. Each press of the key will change the temperature by 5°F (1°C).

- Remember that the oven control will no longer provide audible tones or display any further changes when the Sabbath feature is active.
- The oven will shut-off automatically after completing a bake time and therefore may only be used once during the Sabbath/Jewish Holidays.

## 5. CARE AND CLEANING

### **WARNING!**

Refer to Safety chapters.

### 5.1 General Information

Remove spills and any heavy soiling as soon as possible. Regular cleaning reduces the difficulty of major cleaning later.

### **CAUTION!**

Before cleaning any part of the appliance, make sure all controls are turned off and the appliance is cool.

If you use ammonia or appliance cleaners, remove them and thoroughly rinse the appliance before operating. Follow manufacturer's instructions and provide adequate ventilation.

### **WARNING!**

Do not use bleach to clean the appliance.

### **CAUTION!**

Use scouring pads, oven cleaners, abrasive cleaners and ammonia with special caution while cleaning the appliance.

Surface or Area	Cleaning Recommendation
Aluminum and vinyl	Use a soft cloth and clean with mild dish detergent and water. Rinse with clean water, dry and polish with a soft, clean cloth.
Painted body parts Painted decorative trims	Use a soft cloth and clean with mild dish detergent and water or a 50/50 solution of vinegar and water. Rinse with clean water, dry and polish with a soft, clean cloth. Do not apply glass cleaners directly to the surface, spray onto cloth and wipe.
Touch display	Use a soft cloth and clean with mild dish detergent and water or a 50/50 solution of vinegar and water. Do not spray liquids directly on the display area. Do not use large amounts of water on the display, excess water may cause damage to the appliance. Do not use other liquid cleaners, abrasive cleaners, scouring pads or paper towels, they may damage the finish.
Control panel	Use a soft cloth and clean with mild dish detergent and water or a 50/50 solution of vinegar and water. Do not spray liquids directly on the oven control and display area. Do not use large amounts of water on the control panel. Excess water on the control area may cause damage to the appliance. Do not use other liquid cleaners, abrasive cleaners, scouring pads, or paper towels, they damage the finish.
Stainless Steel	Use a soft cloth and clean with mild dish detergent and water or a 50/50 solution of vinegar and water. Rinse with clean water, and dry with a soft clean cloth. Do not use abrasive cleaners such as chlorides, chlorines, or ammonia.
Coated Stainless Steel	Use a soft cloth and clean with mild dish detergent and water or a 50/50 solution of vinegar and water. Rinse with clean water, and dry with a soft clean cloth. Do not use appliance cleaner, stainless steel cleaner or cleaners containing abrasives, chlorides, chlorine, or ammonia. They may damage the finish.
Porcelain-enameled broiler pan and insert Porcelain door liner Porcelain body parts	Rinse with clean water and a damp cloth. Scrub gently with a soapy non-abrasive scouring pad to remove most spots. Rinse with a 50/50 solution of clean water and ammonia. If necessary, cover difficult spots with an ammonia soaked paper towel for 30 to 40 minutes. Rinse and wipe dry with a clean cloth. Remove all cleaners to avoid damage to the porcelain caused by heating. Do not allow food spills with a high sugar or acid content such as milk, tomatoes, sauerkraut, fruit juices, or pie filling to remain on porcelain surfaces. They may cause a dull spot even after cleaning.
Manual clean oven interior	The interior of the oven is porcelain coated and safe to clean with oven cleaner. Always follow manufacturer's instructions for cleaners. After cleaning, remove all cleaners to avoid damage to the porcelain caused by heating. Do not spray oven cleaner on any electrical controls or switches. Do not spray or allow oven cleaner to build up on the oven temperature sensing probe. Do not spray cleaner on oven door trim, door gasket, plastic drawer glides, handles or any exterior surfaces of the appliance.
Self-cleaning oven interior	Before setting a self-clean cycle, clean soils from the oven frame, areas outside the oven door gasket, and the small area at the front center of the oven bottom.
Oven door	Use mild dish detergent and water or a 50/50 solution of vinegar and water to clean the top, sides, and front of the oven door and rinse well. You can use a glass cleaner on the outside glass of the door. You can use ceramic smoothtop cleaner or polish on the interior door glass. Do not immerse the door in water. Do not spray or allow water or cleaners to enter the door vents. Do not use oven cleaners, cleaning powders, or any harsh abrasive cleaning materials on the outside of the oven door. Do not clean the oven door gasket. The oven door gasket is made of a woven material which is essential for a good seal. Do not rub, damage, or remove oven door gasket.

Surface or Area	Cleaning Recommendation
Pizza Stone	<p>Minor residue do not require special cleaning, they can simply be removed with a brush.</p> <p>To remove heavy buildup, soak the room temperature Pizza Stone in clear water. After a while scrape off softened debris with a plastic tool. To dry the stone, place it on a center rack of the oven (without the shield) and heat up the oven to 200°F (93°C) until you no longer see steam in the oven.</p> <p>Do not season the pizza stone with oil.</p> <p>Do not use any chemicals to clean the stone, as the stone absorbs them and may release them when heated.</p> <p>Do not wash the stone in the dishwasher.</p>

## 5.2 General Cleaning

Refer to the table at the beginning of this chapter for more information about cleaning specific parts of the oven.

### Follow these cleaning precautions:

- Allow the oven to cool before cleaning.
  - Wear rubber gloves when cleaning the appliance manually.
- Remove soils using hot, soapy water. Do not allow food spills with a high sugar or acid content (such as milk, tomatoes, sauerkraut, fruit juices or pie filling) to remain on the surface as they may cause a dull spot even after cleaning. Remove spillovers and heavy soiling as soon as possible. Regular cleaning will reduce the effort required for major cleaning later.

### ⚠ CAUTION!

Before manually cleaning any part of the oven, be sure all controls are turned off and the oven is cool. The oven may be hot and can cause burns. Remove all racks and accessories from the oven before cleaning. Ammonia must be rinsed before operating the oven. Provide adequate ventilation.

### Cleaning Porcelain Enamel Oven

The oven interior is porcelain on steel.

To clean the interior use oven cleaners.

#### To remove heavy soil:

1. Place the dish of ammonia in the oven. Let it sit overnight or for several hours with the oven door closed. Clean softened dirt spots using hot, soapy water. Rinse thoroughly with water and a clean cloth.
2. If soil remains, use a nonabrasive scouring pad or nonabrasive cleaner. If necessary, apply an oven cleaner following the manufacturer's instructions. Do not mix ammonia with other cleaners.
3. Clean any soil from the oven frame, the door liner outside the oven door gasket, and the small area at the front center of the oven bottom. Use hot, soapy water for cleaning. Rinse well with clean water and a cloth.

### Aluminum Foil, Aluminum Utensils, and Oven Liners

### ⚠ WARNING!

Never cover any slots, holes, or passages in the oven bottom or cover an entire oven rack with materials such as aluminum foil. Doing so blocks airflow through the oven and may cause carbon monoxide poisoning. Aluminum foil linings may trap heat, causing a fire hazard.

- Protective liners- Do not use aluminum foil to line the oven bottom. High heat can melt it, damaging the oven and reducing air circulation, leading to poor baking results. Only use aluminum foil as recommended in the manual to avoid electric shock or fire risks
- Aluminum utensils- Aluminum utensils have a lower melting point than other metals. Use aluminum pots and pans with care.
- Oven racks- Do not cover oven racks with aluminum foil. It restricts heat and airflow, affecting cooking results.

## 5.3 Replacing the Oven Light

### ⚠ CAUTION!

Be sure the oven is unplugged and all parts are cool before replacing the oven light.

The interior oven light is located at the rear of the oven cavity and is covered by a glass shield. The glass shield must be in place whenever the oven is in use.

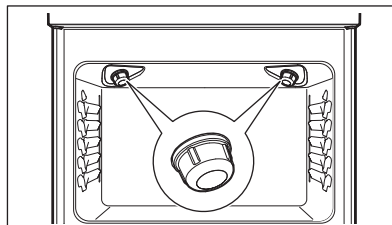

### ⚠ NOTE

Wear a cotton glove or use a paper towel when installing a new bulb. Do not touch the new bulb with your fingers when replacing. This will shorten the life of the bulb.

To replace the oven interior light bulb:

1. Turn electrical power off at the main source or unplug the appliance.
2. Remove interior oven light shield by turning a quarter turn counter-clockwise.
3. Replace bulb with a new T-4 type Halogen 25 watt appliance bulb.
4. Replace glass oven light shield by rotating clockwise.
5. Turn power back on again at the main source (or plug the appliance back in).

Be sure to reset the time of day on the clock.

## 5.4 Caring for Your Glide Racks

### ⚠ CAUTION!

Handle oven racks only when they are cool. After cooking or after the fresh-clean cycle, racks will be very hot and cause burns.

### 📌 IMPORTANT

- Remove all oven racks, including ladder racks, before starting a clean cycle.
- Do not use cooking oil, cooking spray, or other oil-based lubrication products on the glide rack extension tracks. Use only the graphite lubrication in this area. To order graphite lubrication, contact your installer, servicer or dealer.
- It is important that the parts of the rack that contact the oven sides always have a light coating of vegetable oil. Apply a thin layer of vegetable oil to the sides of the rack after every fresh-clean cycle and when the rack becomes difficult to reposition in the oven.

To lubricate the glide rack:

1. Remove the rack from the oven and place the rack on a large flat surface covered with newspaper or scrap cloth. Fully extend the rack.
2. Wipe away debris and crumbs from the glide track using a cloth or sponge.

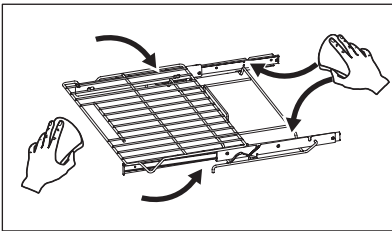

3. Shake graphite lubrication very well before applying. Apply to loading guides, and rotation pin. Repeat on both sides of the glide rack.

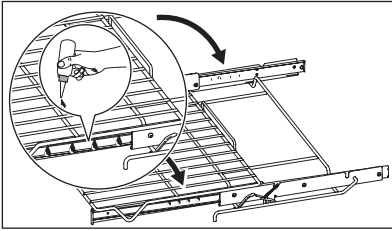

4. Extend and return the glide rack several times along the tracks to distribute the lubrication.

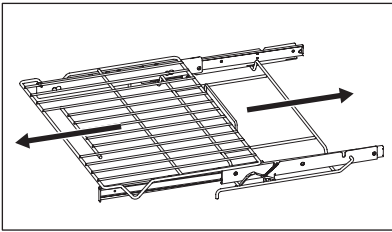

5. Turn the rack upside down and apply graphite lubrication to the insides of the loading guides.

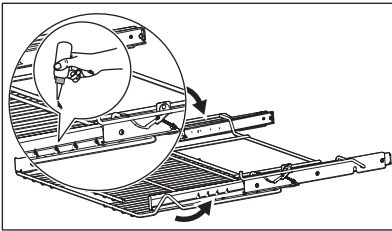

6. Extend and return the glide rack several times along the tracks to distribute the lubrication.
7. Apply a thin layer of cooking oil to the bottom of the "V" and the glide channels. Keeping the frame sides lightly lubricated allows the entire rack to slide easily when changing rack positions.
8. Replace rack in oven right-side up.

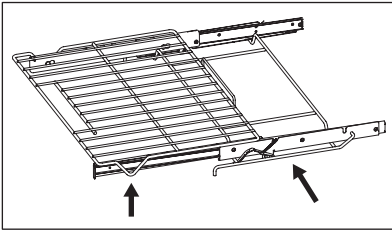

## 5.5 Removing and Replacing the Oven Door

### ⚠ CAUTION!

The door is heavy. For safe, temporary storage, lay the door flat with the inside of the door facing down.

### 📌 IMPORTANT

Most oven doors contain glass that can break. Do not hit the glass with pots, pans, or any other object. Scratching, hitting, jarring, or stressing the glass may weaken its structure, causing an increased risk of breakage at a later time. Do not close the oven door until all of the oven racks are fully in place.

## To remove the oven door

1. Open oven door completely, horizontal with floor.

Figure A

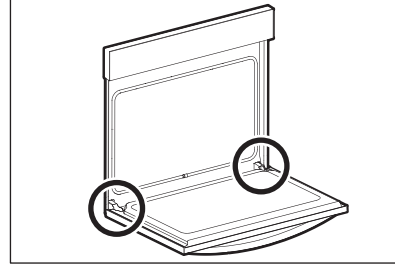

2. Pull up the lock located on each hinge support toward front of the oven until the lock stops. You may have to apply a little upward pressure on the lock to pull it up.

Figure B

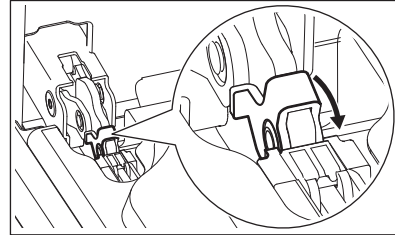

3. Grasp the door by the sides, and close the door until the door frame makes contact with the unlocked hinges.

Figure C

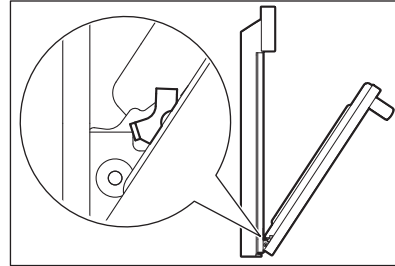

4. Pull the bottom of the door toward you while rotating the top of the door toward the appliance to completely disengage the hinge levers.

Figure D

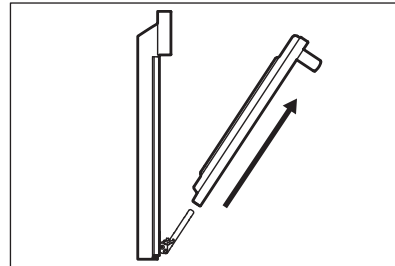

## To replace the oven door

1. Firmly grasp both sides of oven door along the door sides. Do not use the oven door handle (Figure D).
2. Hold the oven door at the same angle as the removal position (Figure C). Carefully insert the hinge levers into the oven frame until you feel the hinge levers are seated into the hinge notches. The hinge arms must be fully seated into the hinge notches before the oven door can be fully opened.
3. Fully open the oven door, horizontal with floor (Figure A).
4. Push the door hinge locks up toward and into the oven frame on both left and right oven door hinges to the locked position (Figure B).
5. Close the oven door.

## 6. TROUBLESHOOTING

### **WARNING!**

Refer to Safety chapters.

### 6.1 Oven Baking

For best cooking results, preheat the oven before baking cookies, breads, cakes, pies, pastries, etc.

There is no need to preheat the oven for roasting meat or baking casseroles.

The cooking time and temperature need to bake a product may vary from the previously owned appliance.

Baking Problems	Possible Cause	Solution
Cookies and biscuits burn on the bottom.	Cookies and biscuits put into oven before oven is preheated.	Allow oven to preheat to desired temperature before placing food in oven. Choose pan size that permits at least 2" of air space.
Cakes too dark on top or bottom.	Cakes put in oven before oven is preheated. Rack position too high or too low. Oven too hot.	Allow oven to preheat to selected temperature before placing food in the oven. Use proper rack position for baking needs. Set oven temperature 25°F / 13°C lower than recommended.
Cakes not done in center.	Oven too hot. Incorrect pan size. Pan not centered in oven. Glass cookware slow heat conductor.	Set oven temperature 25°F / 13°C lower than recommended. Use pan size suggested in recipe. Use proper rack position and place pan with the space on all sides of pan at least 2" / 5.1 cm. Reduce temperature and increase cook time or use shiny bakeware.
Cakes not level.	Oven not level. Pan too close to oven wall or rack overcrowded. Pan warped. Oven light left on while baking.	Place a marked glass measuring cup filled with water on the center of the oven rack. If the level is uneven, refer to installation instructions for leveling the oven. Use proper rack position and place pan with the space on all sides of pan at least 2" / 5.1 cm. Do not use dented or warped pans. Do not leave the oven light on while baking.
Foods not done when cooking time is over.	Oven too cool. Oven overcrowded. Oven door opened too frequently.	Set oven temperature 25°F / 13°C higher than suggested and bake for the recommended time. Make sure to remove all pans from the oven except the ones that you use for baking. Open oven door only after the shortest recommended baking time.

### 6.2 Before you Call (Solutions to Common Problems)

Let us help you troubleshoot your concern! This section will help you with common issues. If you need us, visit our website, chat with an agent, or call us. We may be able to help you avoid a service visit. If you do need service, we can get that started for you!

**Frigidaire.com** (United States)  
1-800-374-4432

**Frigidaire.ca** (Canada)  
1-800-265-8352

Occurrence	Possible cause	Solution
Entire appliance does not operate.	Appliance not connected.	Make sure power cord is plugged properly into outlet. Check your fuse box or breaker box to make sure the circuit is active.
	Electrical power outage.	Check the house light to be sure. Call your local electric company for service outage information.

#### Oven Problems

Occurrence	Possible cause	Solution
Poor baking results.	Many factors affect baking results.	Use proper oven rack position. Center food in the oven and space pans to allow air to circulate. Preheat the oven to the set temperature before placing food in the oven. Adjust the temperature and baking time recommended in the recipe.
Flames inside oven or smoking from oven vent.	Excessive spills in oven. Grease of food spilled onto the oven bottom or oven cavity.	Wipe up excessive spills before turning on the oven. If flames or excessive smoke are present when using broil, refer to Setting Oven Controls.
Oven smokes excessively when boiling.	Incorrect setting.	Refer to Setting Oven Controls.
	Meat too close to the broil element or burner.	Reposition the broil pan to provide proper clearance between the meat and broil element or burner. Remove excess fat from meat. Cut remaining fatty edges to prevent curling, do not cut into lean.
	Grease build up on oven surfaces.	Regular cleaning is necessary when you broil frequently. Grease or food splatters cause excessive smoking.
Convection fan does not rotate.	Oven door is open.	The convection fan turns off if the oven door is open when convection is active. Close the oven door. On gas models, the convection fan begins to rotate about 6 minutes into the preheating process.

## Self-Clean Problems

Occurrence	Possible cause	Solution
Self-clean does not work.	Oven control not set properly.	Refer to Setting Oven Controls.
Oven racks discolored or do not slide properly.	Oven racks left in oven during self-clean.	Remove oven racks from the oven cavity before starting self-clean cycle. Clean by using a mild abrasive cleaner following manufacturer's instructions. Rinse with clean water, dry, and replace in oven.
Soil not completely removed after self-clean.	Self-clean cycle interrupted.	Refer to Setting Oven Controls.
	Excessive spills on oven bottom.	Remove excessive spills before starting self-clean.
	Areas such as oven frame, the door liner outside the oven door gasket, and the small area at the front center of the oven bottom are not in the self-clean area, but get hot enough to burn on residue.	Clean these areas before starting self-clean cycle. Clean burned-on residue with a stiff nylon brush and water or a nylon scrubber. Be careful not to damage the oven gasket.

## Other Problems

Occurrence	Possible cause	Solution
Appliance is not level.	Poor installation.	Place the oven rack in the center of the oven. Place a level on the oven rack. Adjust the leveling legs at the base of the appliance until the rack is level.
	Kitchen cabinet alignment may make range appear not level.	Make sure cabinets are square and have sufficient room for appliance clearance.
Cannot move appliance easily. Appliance must be accessible for service.	Cabinets not square or built in too tightly. Carpet interferes with appliance.	Contact the builder or installer to make the appliance accessible. Provide sufficient space so the appliance can be lifted over carpet. Installation over carpet is not advised. Refer to Installation Instructions for guidelines specific to your appliance.
Oven light does not work.	The oven light is not secured in the socket.	Make sure the oven light is secure in the socket. Refer to Care and Cleaning.

## 7. LIMITED WARRANTY

Your appliance is covered by a one year limited warranty. For one year from your original date of purchase, Electrolux will pay all costs for repairing or replacing any parts of this appliance that prove to be defective in materials or workmanship when such appliance is installed, used and maintained in accordance with the provided instructions.

### Exclusions

This warranty does not cover the following:

1. Products with original serial numbers that have been removed, altered or cannot be readily determined.
2. Product that has been transferred from its original owner to another party or removed outside the USA or Canada.
3. Rust on the interior or exterior of the unit.
4. Products purchased "as-is" are not covered by this warranty.
5. Food loss due to any refrigerator or freezer failures.
6. Products used in a commercial setting.
7. Service calls which do not involve malfunction or defects in materials or workmanship, or for appliances not in ordinary household use or used other than in accordance with the provided instructions.
8. Service calls to correct the installation of your appliance or to instruct you how to use your appliance.
9. Expenses for making the appliance accessible for servicing, such as removal of trim, cupboards, shelves, etc., which are not a part of the appliance when it is shipped from the factory.
10. Service calls to repair or replace appliance light bulbs, air filters, water filters, other consumables, or knobs, handles, or other cosmetic parts.
11. Surcharges including, but not limited to, any after hour, weekend, or holiday service calls, tolls, ferry trip charges, or mileage expense for service calls to remote areas, including the state of Alaska.
12. Damages to the finish of appliance or home incurred during installation, including but not limited to floors, cabinets, walls, etc.
13. Damages caused by: services performed by unauthorized service companies; use of parts other than genuine Electrolux parts or parts obtained from persons other than authorized service companies; or external causes such as abuse, misuse, inadequate power supply, accidents, fires, or acts of God.

### Disclaimer of implied warranties; Limitation of remedies

CUSTOMER'S SOLE AND EXCLUSIVE REMEDY UNDER THIS LIMITED WARRANTY SHALL BE PRODUCT REPAIR OR REPLACEMENT AS PROVIDED HEREIN. CLAIMS BASED ON IMPLIED WARRANTIES, INCLUDING WARRANTIES OF

MERCHANTABILITY OR FITNESS FOR A PARTICULAR PURPOSE, ARE LIMITED TO ONE YEAR OR THE SHORTEST PERIOD ALLOWED BY LAW, BUT NOT LESS THAN ONE YEAR. ELECTROLUX SHALL NOT BE LIABLE FOR CONSEQUENTIAL OR INCIDENTAL DAMAGES SUCH AS PROPERTY DAMAGE AND INCIDENTAL EXPENSES RESULTING FROM ANY BREACH OF THIS WRITTEN LIMITED WARRANTY OR ANY IMPLIED WARRANTY. SOME STATES AND PROVINCES DO NOT ALLOW THE EXCLUSION OR LIMITATION OF INCIDENTAL OR CONSEQUENTIAL DAMAGES, OR LIMITATIONS ON THE DURATION OF IMPLIED WARRANTIES, SO THESE LIMITATIONS OR EXCLUSIONS MAY NOT APPLY TO YOU. THIS WRITTEN WARRANTY GIVES YOU SPECIFIC LEGAL RIGHTS. YOU MAY ALSO HAVE OTHER RIGHTS THAT VARY FROM STATE TO STATE.

### If You Need Service

Keep your receipt, delivery slip, or some other appropriate payment record to establish the warranty period should service be required. If service is performed, it is in your best interest to obtain and keep all receipts. Service under this warranty must be obtained by contacting Electrolux at the addresses or phone numbers below.

This warranty only applies in the USA and Canada. In the USA, your appliance is warranted by Electrolux Major Appliances North America, a division of Electrolux Consumer Products, Inc. In Canada, your appliance is warranted by Electrolux Canada Corp. Electrolux authorizes no person to change or add to any obligations under this warranty. Obligations for service and parts under this warranty must be performed by Electrolux or an authorized service company. Product features or specifications as described or illustrated are subject to change without notice.

### USA

**1-800-374-4432**

Frigidaire

10200 David Taylor Drive  
Charlotte, NC 28262

### Canada

**1-800-265-8352**

Electrolux Canada Corp.  
5855 Terry Fox Way







