



REFRIGERATOR

use & care

Introduction.....	2	Controls and Settings	10
Important Safety information.....	3	Care and Cleaning	12
Features	5	Troubleshooting	14
Installation	6	Limited Warranty	15
Door Reversal.....	7		

2

INTRODUCTION

Welcome to our family

Thank you for bringing Frigidaire into your home! We see your purchase as the beginning of a long relationship together.

This manual is your resource for the use and care of your product. Please read it before using your appliance. Keep it handy for quick reference. If something doesn't seem right, the troubleshooting section will help you with common issues.

FAQs, helpful tips and videos, cleaning products, and kitchen and home accessories are available at www.frigidaire.com.

We are here for you! Visit our website, chat with an agent, or call us if you need help. We may be able to help you avoid a service visit. If you do need service, we can get that started for you.

Let's make it official! Be sure to register your product.

Keep your product info here so it's easy to find.

Model Number _____
Serial Number _____
Purchase Date _____



Installation Checklist

Doors

- Door seals completely to cabinet on all sides

Leveling

- Refrigerator is level side-to-side and front-to-back
- Cabinet is set solid on all corners

Electrical Power

- House power turned on
- Refrigerator plugged in

Final Checks

- Shipping material removed
- Refrigerator and freezer temperatures set
- Registration card sent in



WARNING

Please read all instructions before using this appliance.

Safety Definitions

 This is the safety alert symbol. It is used to alert of potential personal injury hazards. Obey all safety messages that follow this symbol to avoid possible injury or death.



DANGER

DANGER indicates an imminently hazardous situation which, if not avoided, will result in death or serious injury.



WARNING

WARNING indicates a potentially hazardous situation which, if not avoided, could result in death or serious injury.



CAUTION

CAUTION indicates a potentially hazardous situation which, if not avoided, may result in minor or moderate injury.



IMPORTANT

IMPORTANT indicates installation, operation or maintenance information which is important but not hazard-related.



DANGER



DANGER Risk of fire or explosion. Flammable refrigerant used. Do not use mechanical devices to defrost refrigerator. Do not puncture refrigerant tubing.

DANGER Risk of fire or explosion. Flammable refrigerant used. To be repaired only by trained service personnel. Use only manufacturer-authorized service parts. Any repair equipment used must be designed for flammable refrigerants. Follow all manufacturer repair instructions. Do not puncture refrigerant tubing.



CAUTION



CAUTION Risk of fire or explosion. Dispose of refrigerator properly in accordance with the applicable federal or local regulations. Flammable refrigerant used.

CAUTION Risk of fire or explosion due to puncture of refrigerant tubing. Follow handling instructions carefully. Flammable refrigerant used.



WARNING

Do not use electrical appliances inside the food storage compartments of the appliance unless they are of the type recommended by the manufacturer.



WARNING

CALIFORNIA RESIDENTS ONLY
Cancer and Reproductive Harm
www.P65Warnings.ca.gov

Child Safety

This appliance is not intended for use by persons (including children) with reduced physical, sensory or mental capabilities, or lack of experience and knowledge, unless they have been given supervision or instruction concerning use of the appliance by a person responsible for their safety.

Destroy or recycle the carton, plastic bags, and any exterior wrapping material immediately after you unpack the refrigerator. Children should **NEVER** use these items to play. Cartons covered with rugs, bedspreads, plastic sheets or stretch wrap may become airtight chambers, and can quickly cause suffocation.

Safety Instructions

- DO NOT store or use gasoline, or other flammable liquids in the vicinity of this or any other appliance. Read product labels for warnings regarding flammability and other hazards.
- DO NOT operate the refrigerator in the presence of explosive fumes.
- Avoid contact with any moving parts of automatic ice maker.
- Remove all staples from the carton. Staples can cause severe cuts, and also destroy finishes if they come in contact with other appliances or furniture.

4

IMPORTANT SAFETY INFORMATION

Proper Disposal of your Appliance

Risk of child entrapment

Child entrapment and suffocation are not problems of the past. Junked or abandoned appliances are still dangerous – even if they will sit for “just a few days”. If you are getting rid of your old unit, please follow the instructions below to help prevent accidents.

We strongly encourage responsible appliance recycling/disposal methods. Check with your utility company or visit www.energystar.gov/recycle for more information on recycling your old appliance.

Before you throw away your old unit:

- Remove doors.
- Leave shelves in place so children may not easily climb inside.
- Have refrigerant removed by a qualified service technician.

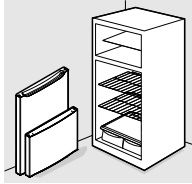

Electrical information

- Plug the unit into its own dedicated 115 Volt, 60 Hz., 15 Amp, AC only electrical outlet. The power cord of the appliance is equipped with a 3-prong grounding plug for your protection against electrical shock hazards. Plug it directly into a properly grounded 3-prong receptacle. You must install the receptacle in accordance with local codes and ordinances. Consult a qualified electrician. Do not use an extension cord or adapter plug.
- If the power cord is damaged, an authorized service technician should replace it to prevent any risk.
- Never unplug the refrigerator by pulling on the power cord. Always grip the plug firmly, and pull it straight out from the receptacle to prevent damaging the power cord.
- Unplug the appliance before cleaning and before replacing the AC LED light bulb to avoid electrical shock. Use only a 5-watt or less AC LED light bulb.
- Performance may be affected if the voltage varies by 10% or more.

Operating the refrigerator with insufficient power can damage the compressor. Such damage is not covered under your warranty.

- Do not plug the unit into an electrical outlet controlled by a wall switch or pull cord to prevent the unit from being turned off accidentally.



WARNING

- When positioning the appliance, ensure the supply cord is not trapped or damaged.
- Do not locate multiple portable socket-outlets or portable power supplies at the rear of the appliance.



IMPORTANT

Turning the Refrigerator controls to “OFF” will disable your refrigerator’s cooling system, but does not disconnect the power to the light bulb and other electrical components. To turn off power to your refrigerator you must unplug the power cord from the electrical outlet.

Grounding type wall receptacle

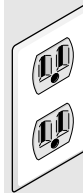

Do not, under any circumstances, cut, remove, or bypass the grounding prong.

Power cord with 3-prong grounded plug



*Features may vary according to model

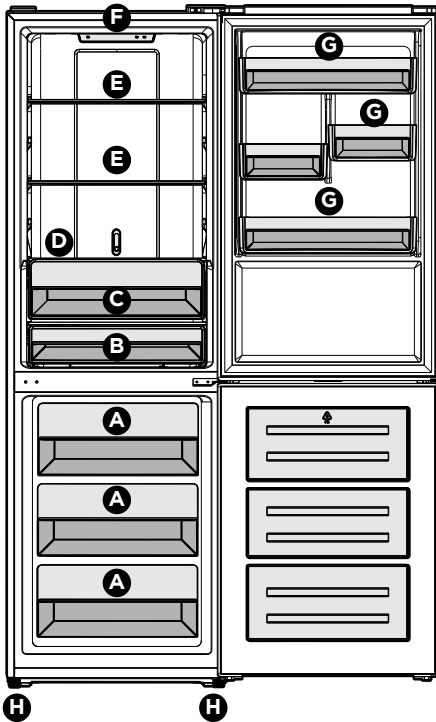

A	Freezer Drawers
B	Chiller
C	Crisper
D	Crisper Cover
E	Refrigerator Shelves
F	Thermostat and Light
G	Door Bins
H	Leveling Feet



IMPORTANT

Cleaning your Refrigerator

Remove tape and glue residue from surfaces before turning the refrigerator on. Rub a small amount of liquid dish soap over the adhesive with your fingers. Rinse with warm water and dry with a soft cloth.

Do not use sharp instruments, rubbing alcohol, flammable fluids, or abrasive cleaners to remove tape or glue. These products can damage the surface of your refrigerator.

After you remove all of the package materials, clean the inside of your refrigerator before using it. See the **CARE AND CLEANING** section in this manual.

See important information about cleaning glass shelves and covers in the **STORAGE FEATURES** section of this manual.



IMPORTANT

Moving your Refrigerator

Your refrigerator is heavy. When moving the refrigerator for cleaning or service, be sure to cover the floor with cardboard or hardboard to avoid floor damage. Always pull the refrigerator straight out when moving it. Do not wiggle or “walk” the refrigerator when trying to move it as you could damage the floor.

6

INSTALLATION

This Use & Care Guide provides general operating instructions for your model. Use the appliance only as instructed in this Use & Care Guide. Before starting the unit, follow these important first steps.

Location

- Choose a place that is near a grounded electrical outlet. Do Not use an extension cord or an adapter plug.
- When first locating unit, it is advisable to wait at least 4 hours to connect unit to electrical outlet to allow the oil to flow back into the compressor.
- If possible, place the refrigerator out of direct sunlight and away from the range, dishwasher or other heat sources.
- The refrigerator must be installed on a floor that is level and strong enough to support a fully loaded refrigerator.



WARNING

This appliance is intended for use in residential household and similar interior applications such as:

- Kitchen / Kitchenette
- Pantry Room
- Basement
- Enclosed Garage
- Other interior residential type environments

Installation



WARNING

Installation clearances

Allow the following clearances for ease of installation, proper air circulation, and plumbing and electrical connections:

Top	4"	100 mm
Side/Back	2"	50 mm

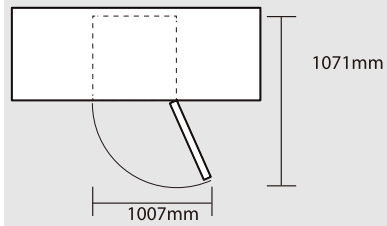

CAUTION

Do not install the refrigerator where the temperature will drop below 38°F (-3°C) or rise above 110°F (43°C). The compressor will not be able to maintain proper temperatures inside the refrigerator.

Guidelines for final positioning of your refrigerator:

- All 4 corners of the cabinet must rest firmly on the floor.
- The cabinet should be level at the front and rear.
- To level unit, adjust the two leveling feet at the front of the unit.

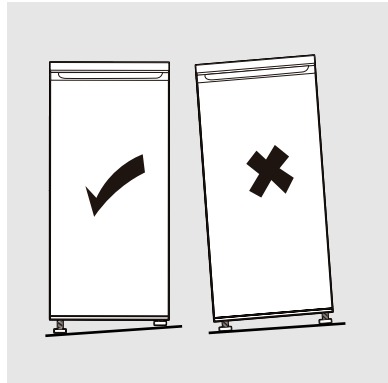

Tools Needed

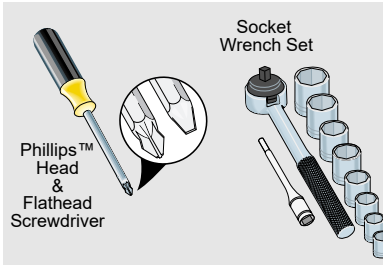

Accessory Bag Door Reversal Components

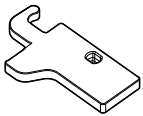

Left Door Hinge Cover
x1

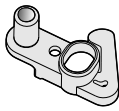

Left Aid-Closer on Upper Door
x1

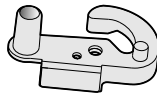

Left Aid-Closer on Lower Door
x1



NOTE

The direction in which your refrigerator doors open (door swing) can be reversed, from left to right or right to left, by moving the door hinges from one side to the other. Reversing the door swing should be performed by a qualified person.



IMPORTANT

Before you begin, turn the refrigerator temperature control to **OFF** and remove the electrical power cord from the wall outlet. Remove any food from door shelves.

Door Reversal:

1. Unplug your refrigerator.
2. Unscrew top hinge cover and disconnect connectors from door switch.

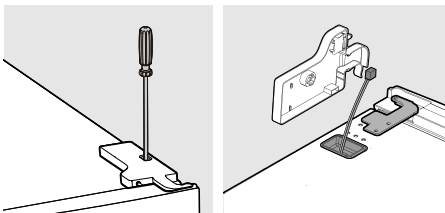

3. Remove top hinge with socket wrench.

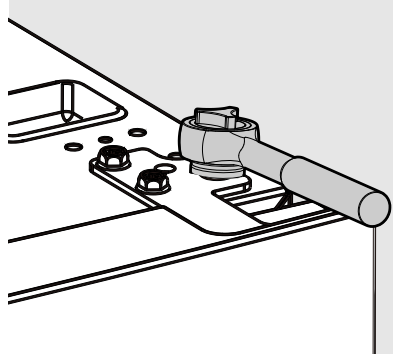

4. Remove pin with adjustable wrench. Flip hinge bracket over, attach pin to opposite side of bracket.

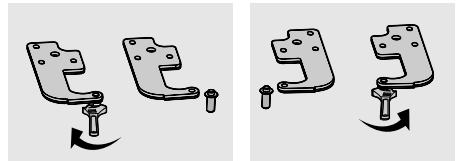

5. Move door switch from right hinge cover to left hinge cover (accessory bag).

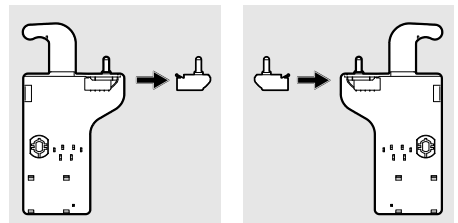

6. Move top left cover to right side.

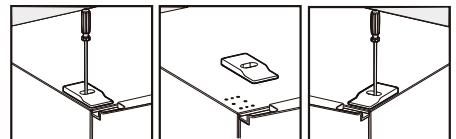

8

DOOR REVERSAL

7. Take off the upper door. Using a Phillips screw driver, take out the screw from the middle hinge. Take off the lower door.

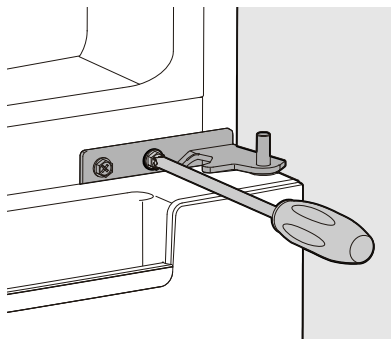

8. Move the hinge hole covers from left side to right side.

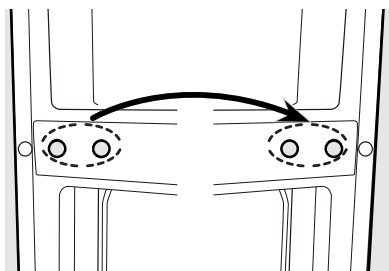

9. Remove the adjustable feet from both sides. (See Figure A.) Remove the bottom hinge. (See Figure B.)

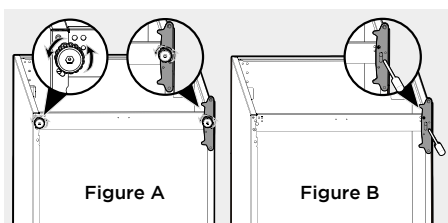

10. Remove the bottom hinge pin with adjustable wrench, turn bracket over and replace on opposite side.

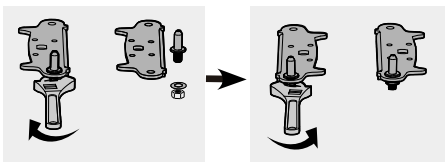

11. Attach the bottom hinge bracket to the unit. (See Figure A.) Replace both adjustable feet. See Figure B.)

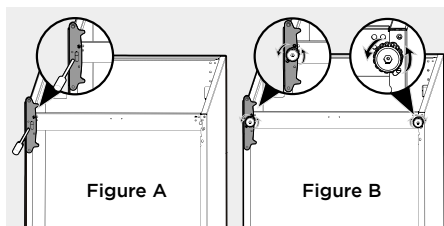

12. Remove aid-closers from bottom of upper and lower doors, then take new aid-closers from accessory bag and install them to left side.

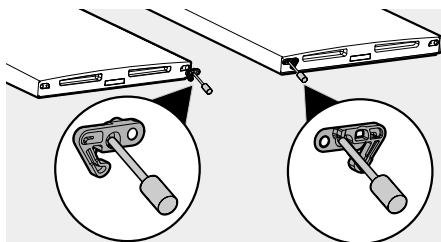

13. Detach the refrigerator and freezer door gaskets and then attach them after rotating.

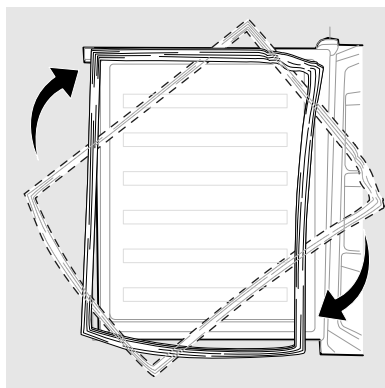

14. Install the lower door, adjust and fix the middle hinge onto the cabinet.

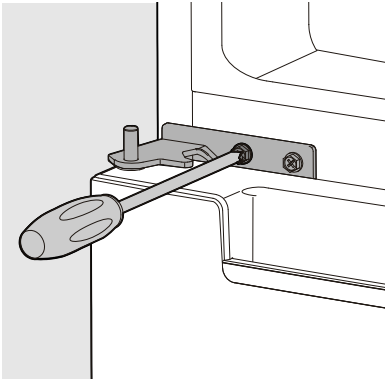

16. Connect door switch terminals to top hinge cover. Screw top hinge cover in place.

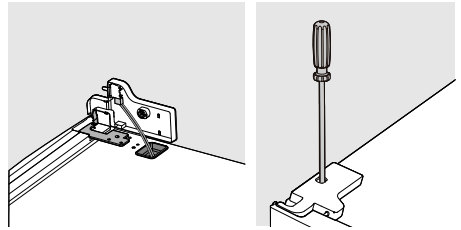

15. Replace upper door. Place door on middle hinge and align with cabinet ensuring that the door gasket seals tightly with cabinet. Secure the top hinge tightly to the cabinet.

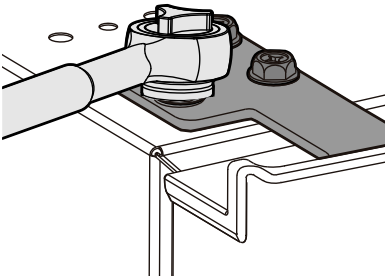

10 CONTROLS AND SETTINGS

Control Panel Display

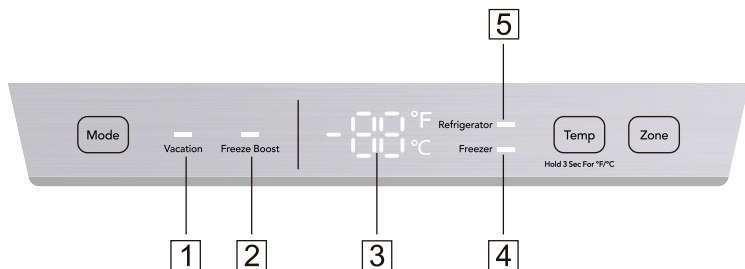

Buttons and Temperature Settings

Mode: Press **Mode** to select **Vacation Mode** or **Freeze Boost Mode** and wait until the flash turns to continuous light, then the **Mode** is selected successfully.

Zone: Under **Normal Mode**, press **Zone** to select the compartment for which you plan to adjust the temperature.

Temp: Under **Normal Mode**, press **Temp** to adjust temperature of refrigerator or freezer compartments. Press **Temp** and hold longer than 3 seconds to switch between Fahrenheit and Celsius. The set temperature of the refrigerator and freezer compartments cycles as follows:

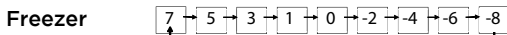
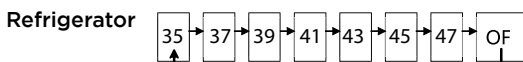

Display and Light

- 1 It will illuminate when **Vacation Mode** is selected using the **Mode** button.
- 2 It will illuminate when **Freeze Boost Mode** is selected using the **Mode** button.
- 3 It shows set temperature of refrigerator and freezer compartments in Fahrenheit or Celsius.
- 4 It will illuminate when the freezer compartment is selected using the **Mode** button.
- 5 It will illuminate when the refrigerator compartment is selected using the **Mode** button.

Running Modes

Vacation Mode

In this mode, the temperature of the refrigerator and freezer is automatically set at 41°F (5 °C) and 0°F (-18°C). The temperature of the 2 compartments are not adjustable. The appliance will run with lower energy consumption.

Freeze Boost Mode

In this mode, the temperature of the freezer is automatically set at -13°F (-25°C). The temperature in the freezer compartment will be reduced quickly.

If you plan to freeze a large amount of food at one time, please select Freeze Boost Mode. In this mode, the temperature of Refrigerator compartment is still adjustable. The appliance will go back to previous mode automatically after 50 hours.

Normal Mode

The default mode is Normal Mode. In this mode, you can set the temperatures of both Refrigerator and Freezer compartments.

Door Open Alarm

If door is left open for more than 60 seconds, alarm will sound. Close door immediately to conserve energy.

Error Codes

If there is a fault, the display will show ERROR codes.

Error Fault	Codes
Signal transmission between control board and main board. Probably defects of harness (wire and connectors), main board or control board	E0
Temperature sensor of refrigerator compartment	E1
Temperature sensor of freezer compartment	E2
Defrost temperature sensor in freezer compartment	E3
Defrost heater or the fuse connected with heater	E5

Call service to report error codes.

CHILLDRAWER Temperature Control

- Temperatures in the CHILLDRAWER can be adjusted based on the type of food to be stored.
- To decrease the temperature, push the knob upward from the bottom.
- When the knob is placed at the “Cold” position, the CHILLDRAWER can be functioned as a crisper zone and maintain the appropriate temperature and humidity for fruits and vegetables.
- When the knob is placed at the “Coldest” position, it is suitable for short-term storage of fish or other fresh food. The food will be kept fresh but not frozen which makes it the best choice for storing fresh food.
- Tip: When you choose “Coldest” position, it is recommended to set the refrigerator temperature below 4 °C in order to keep food the freshest.

CHILLDRAWER

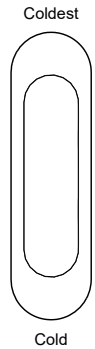

12

CARE AND CLEANING

Protecting your investment

Keeping your refrigerator clean maintains appearance and prevents odor build-up. Wipe up any spills immediately and clean the freezer and refrigerator compartments at least twice a year. When cleaning, take the following precautions:

- Never use CHLORIDE or cleaners with bleach to clean stainless steel.
- Do not wash any removable parts in a dishwasher.
- Always unplug the electrical power cord from the wall outlet before cleaning.
- Remove adhesive labels by hand. Do not use razor blades or other sharp instruments which can scratch the appliance surface.
- Do not remove the serial plate.

Do not use abrasive cleaners such as window sprays, scouring cleansers, brushes, flammable fluids, cleaning waxes, concentrated detergents, bleaches or cleansers containing petroleum products on plastic parts, interior doors, gaskets or cabinet liners. Do not use paper towels, metallic scouring pads, or other abrasive cleaning materials or strong alkaline solutions.



NOTE

If you set your temperature controls to turn off cooling, power to lights and other electrical components will continue until you unplug the power cord from the wall outlet.



CAUTION

Pull the refrigerator straight out to move it. Shifting it from side to side may damage flooring. Be careful not to move the refrigerator beyond the plumbing connections.

Care and Cleaning Tips		
Part	What To Use	Tips and Precautions
Interior & Door Liners	<ul style="list-style-type: none">• Soap and water• Baking soda and water	Use 2 tbsp of baking soda in 1 qt of warm water. Be sure to wring excess water out of sponge or cloth before cleaning around controls, light bulb or any electrical part.
Door Gaskets	<ul style="list-style-type: none">• Soap and water	Wipe gaskets with a clean soft cloth.
Drawers & Bins	<ul style="list-style-type: none">• Soap and water	Use a soft cloth to clean drawer runners and tracks.
Glass Shelves	<ul style="list-style-type: none">• Soap and water• Glass cleaner• Mild liquid sprays	Allow glass to warm to room temperature before immersing in warm water.
Exterior	<ul style="list-style-type: none">• Soap and water• Non Abrasive Glass Cleaner	Do not use commercial household cleaners containing ammonia, bleach or alcohol to clean handles. Use a soft cloth to clean smooth handles. DO NOT use a dry cloth to clean smooth doors.
Replacing LED Lights	<ul style="list-style-type: none">• LED lights	The internal light is LED. To replace the light, please contact a qualified technician.

14 TROUBLESHOOTING

Let us help you troubleshoot your concern! This section will help you with common issues. If you need us, visit our website, chat with an agent, or call us. We may be able to help you avoid a service visit. If you do need service, we can get that started for you!

1-800-374-4432 (United States)
Frigidaire.com

1-800-265-8352 (Canada)
Frigidaire.ca

Common Occurrences	
Refrigerator does not run.	<ul style="list-style-type: none">• Ensure the plug is tightly pushed into an electrical outlet.• Check/replace the fuse with a 15-amp time-delay fuse. Reset the circuit breaker.
Appliance freezes or cools too much.	<ul style="list-style-type: none">• Temperature is set too cold.• Turn the temperature control to a warmer setting temporarily.
The food is not frozen enough.	<ul style="list-style-type: none">• Temperature is not properly adjusted. Please look in the initial Temperature Setting section.• Door was open for an extended period. Open the door only as long as necessary• A large quantity of warm food was placed in the appliance within the last 24 hours. Turn the temperature control to a colder setting temporarily.• The appliance is near a heat source. Do not locate near any heat source.
Side panel is hot.	<ul style="list-style-type: none">• The condenser is in the panel, this is normal.
Refrigerator is noisy or vibrates.	<ul style="list-style-type: none">• The cabinet is not level.• The appliance is touching the wall or other objects, move the appliance slightly.
Odors in the refrigerator.	<ul style="list-style-type: none">• The interior needs to be cleaned.• Foods that produce odors should be covered or wrapped.
Cabinet light is not working.	<ul style="list-style-type: none">• Ensure the plug is tightly pushed into an electrical outlet.• The internal light is LED. To replace the light, please contact a qualified technician.

Your appliance is covered by a one year limited warranty. For one year from your original date of delivery, Electrolux will pay all costs for repairing or replacing any parts of this appliance that prove to be defective in materials or workmanship when such appliance is installed, used and maintained in accordance with the provided instructions.

Exclusions

This warranty does not cover the following:

1. Products with original serial numbers that have been removed, altered or cannot be readily determined.
2. Product that has been transferred from its original owner to another party or removed outside the USA or Canada.
3. Rust on the interior or exterior of the unit.
4. Products purchased "as-is" are not covered by this warranty.
5. Food loss due to any refrigerator or freezer failures.
6. Products used in a commercial setting.
7. Service calls which do not involve malfunction or defects in materials or workmanship, or for appliances not in ordinary household use or used other than in accordance with the provided instructions.
8. Service calls to correct the installation of your appliance or to instruct you how to use your appliance.
9. Expenses for making the appliance accessible for servicing, such as removal of trim, cupboards, shelves, etc., which are not a part of the appliance when it is shipped from the factory.
10. Service calls to repair or replace appliance light bulbs, air filters, water filters, other consumables, or knobs, handles, or other cosmetic parts.
11. Surcharges including, but not limited to, any after hour, weekend, or holiday service calls, tolls, ferry trip charges, or mileage expense for service calls to remote areas, including the state of Alaska.
12. Damages to the finish of appliance or home incurred during installation, including but not limited to floors, cabinets, walls, etc.
13. Damages caused by: services performed by unauthorized service companies; use of parts other than genuine Electrolux parts or parts obtained from persons other than authorized service companies; or external causes such as abuse, misuse, inadequate power supply, accidents, fires, or acts of God.

DISCLAIMER OF IMPLIED WARRANTIES; LIMITATION OF REMEDIES

CUSTOMER'S SOLE AND EXCLUSIVE REMEDY UNDER THIS LIMITED WARRANTY SHALL BE PRODUCT REPAIR OR REPLACEMENT AS PROVIDED HEREIN. CLAIMS BASED ON IMPLIED WARRANTIES, INCLUDING WARRANTIES OF MERCHANTABILITY OR FITNESS FOR A PARTICULAR PURPOSE, ARE LIMITED TO ONE YEAR OR THE SHORTEST PERIOD ALLOWED BY LAW, BUT NOT LESS THAN ONE YEAR. ELECTROLUX SHALL NOT BE LIABLE FOR CONSEQUENTIAL OR INCIDENTAL DAMAGES SUCH AS PROPERTY DAMAGE AND INCIDENTAL EXPENSES RESULTING FROM ANY BREACH OF THIS WRITTEN LIMITED WARRANTY OR ANY IMPLIED WARRANTY. SOME STATES AND PROVINCES DO NOT ALLOW THE EXCLUSION OR LIMITATION OF INCIDENTAL OR CONSEQUENTIAL DAMAGES, OR LIMITATIONS ON THE DURATION OF IMPLIED WARRANTIES, SO THESE LIMITATIONS OR EXCLUSIONS MAY NOT APPLY TO YOU. THIS WRITTEN WARRANTY GIVES YOU SPECIFIC LEGAL RIGHTS. YOU MAY ALSO HAVE OTHER RIGHTS THAT VARY FROM STATE TO STATE.

If You Need Service

Keep your receipt, delivery slip, or some other appropriate payment record to establish the warranty period should service be required. If service is performed, it is in your best interest to obtain and keep all receipts. Service under this warranty must be obtained by contacting Electrolux at the addresses or phone numbers below.

This warranty only applies in the USA and Canada. In the USA, your appliance is warranted by Electrolux Major Appliances North America, a division of Electrolux Home Products, Inc. In Canada, your appliance is warranted by Electrolux Canada Corp. Electrolux authorizes no person to change or add to any obligations under this warranty. Obligations for service and parts under this warranty must be performed by Electrolux or an authorized service company. Product features or specifications as described or illustrated are subject to change without notice.

USA
1-800-374-4432
 Frigidaire
 10200 David Taylor Drive
 Charlotte, NC 28262



Electrolux

Canada
1.800.265.8352
 Electrolux Canada Corp.
 5855 Terry Fox Way
 Mississauga, Ontario, Canada
 L5V 3E4

FRIGIDAIRE®

welcome *home*

Our home is your home. Visit us if you need help with any of these things:



owner support



accessories



service



registration

(See your registration card for more information.)

Frigidaire.com
1-800-374-4432

Frigidaire.ca
1-800-265-8352