



Portable Air Conditioner *use & care*

Introduction.....	2	Air Conditioner Features.....	17
Important Safety Instructions.....	3	Operating Instructions.....	18
FCC Statement.....	11	Care and Cleaning.....	26
Unit Description.....	12	Before You Call.....	28
Accessories Included.....	13	Major Appliance Limited Warranty.....	30
Installation Instructions.....	13		

2

INTRODUCTION

Welcome to our *family*

Thank you for bringing Frigidaire into your home! We see your purchase as the beginning of a long relationship together.

This manual is your resource for the use and care of your product. Please read it before using your appliance. Keep it handy for quick reference. If something doesn't seem right, the troubleshooting section will help you with common issues.

FAQs, helpful tips and videos, cleaning products, and kitchen and home accessories are available at www.frigidaire.com.

We are here for you! Visit our website, chat with an agent, or call us if you need help. We may be able to help you avoid a service visit. If you do need service, we can get that started for you.

Let's make it official! Be sure to register your product.

Keep your product info here so it's easy to find.

Model Number _____

Serial Number _____

Purchase Date _____



WARNING

For Your Safety

Do not store or use gasoline or other flammable vapors and liquids in the vicinity of this or any other appliance. Read product labels for flammability and other warnings.



WARNING

Prevent Accidents

To reduce the risk of fire, electrical shock, or injury to persons when using your air conditioner, follow basic precautions, including the following:

- Be sure the electrical service is adequate for the model you have chosen. This information can be found on the serial plate, which is located on the side of the cabinet.
- If the air conditioner is to be installed in a window, you will probably want to clean both sides of the glass first.
- Be sure the air conditioner has been securely and correctly installed according to the installation instructions in this manual. Save this manual for possible future use in removing or reinstalling this unit.



WARNING

Electrical Information

The complete electrical rating of your new portable air conditioner is stated on the serial plate. Refer to the rating when checking the electrical requirements.

- Be sure the air conditioner is properly grounded. To minimize shock and fire hazards, proper grounding is important. The power cord is equipped with a three-prong grounding plug for protection against shock hazards.

- Your air conditioner must be used in a properly grounded wall receptacle. If the wall receptacle you intend to use is not adequately grounded or protected by a time delay fuse or circuit breaker, have a qualified electrician install the proper receptacle.
- Do not run air conditioner without outside protective cover in place. This could result in mechanical damage within the air conditioner.
- **Do not use an extension cord or an adapter plug.**



WARNING

Avoid fire hazard or electric shock. Do not use an extension cord or an adaptor plug. Do not remove any prong from the power cord.

Grounding type wall receptacle

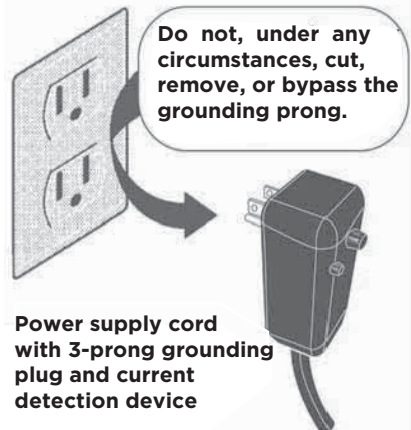

Power supply cord with 3-prong grounding plug and current detection device

NOTE: The power supply cord with this air conditioner contains a current detection device designed to reduce the risk of fire.

Please refer to the section 'Operation of Current Device' for details.

In the event that the power supply cord is damaged, it cannot be repaired. It must be replaced with a cord from the product manufacturer.

4

IMPORTANT SAFETY INSTRUCTIONS



SAFETY PRECAUTIONS

DANGER! Avoid Serious Injury or Death

- This air conditioner contains no user-serviceable parts. Always call an authorized Electrolux servicer for repairs.
- Do not insert or place fingers or objects into the air discharge area in the front of the unit.
- Do not start or stop the air conditioner by unplugging the power cord or turning off the power at the electrical box.
- Do not cut or damage the power cord.
- If the power cord is damaged, it should only be replaced by an authorized Electrolux servicer.
- In the event of a malfunction (sparks, burning smell, etc.), immediately stop the operation, disconnect the power cord, and call an authorized Electrolux servicer.
- Do not operate the air conditioner with wet hands.
- Do not pull on the power cord.
- Do not drink any water that is drained from the air conditioner.
- This appliance is not intended for use by persons (including children) with reduced physical, sensory or mental capabilities or lack of experience and knowledge, unless they have been given supervision or instruction concerning use of the appliance by a person responsible for their safety.
- Children should be supervised to ensure that they do not play with the appliance.
- If the supply cord is damaged, it must be replaced by the manufacturer, its service agent or similarly qualified persons in order to avoid a hazard.
- The appliance shall be installed in accordance with national wiring regulations.



SAFETY PRECAUTIONS

CAUTION! Avoid Injury or damage to the unit or other property

- Provide ventilation per installation instructions.
- Do not direct airflow at fireplaces or other heat related sources as this could cause flare ups or make units run excessively.
- Do not climb on or place objects on the unit.
- Do not hang objects off the unit.
- Do not place containers with liquids on the unit.
- Turn off the air conditioner at the power source when it will not be used for an extended period of time.
- Periodically check the condition of the unit's installation accessories for any damage.
- Do not apply heavy pressure to the radiator fins of the unit.
- Operate the unit with air filter in place.
- Do not block or cover the intake grille, discharge area and outlet ports.
- Ensure that any electrical/electronic equipment is one yard away from the unit.
- Do not use or store flammable gases near the unit.
- Do not touch the metal parts of the unit when removing the filter. Injuries can occur when handling sharp metal edges.
- Do not use water to clean inside the air conditioner. Exposure to water can destroy the insulation, leading to possible electric shock.
- When cleaning the unit, first make sure that the power and circuit breaker are turned off.
- Improper use may cause hands to be pinched.



WARNING

FOR FLAMMABLE REFRIGERANT

- Servicing shall only be performed as recommended by the equipment manufacturer. Maintenance and repair requiring the assistance of other skilled personnel shall be carried out under the supervision of the person competent in the use of flammable refrigerants.

- DO NOT modify the length of the power cord or use an extension cord to power the unit.
- DO NOT share a single outlet with other electrical appliances. Improper power supply can cause fire or electrical shock.
- Please follow the instruction carefully to handle, install, clear, service the air conditioner to avoid any damage or hazard.
- Flammable Refrigerant R32 is used within appliance. When maintaining or disposing the appliance, the refrigerant (R32) shall be recovered properly, shall not discharge to air directly.
- Compliance with national gas regulations shall be observed.
- Keep ventilation openings clear of obstruction.
- The appliance shall be stored so as to prevent mechanical damage from occurring.
- The appliance shall be store in a well-ventilated area where the room size corresponds to the room area as specified for operation.
- Any person who is involved with working on or breaking into a refrigerant circuit should hold a current valid certificate from an industry-accredited assessment authority, which authorises their competence to handle refrigerants safely in accordance with an industry recognised assessment specification. All training shall follow the ANNEX HH requirements of UL 60335-2-40 4th Edition.

Examples for such working procedures are:

- breaking into the refrigerating circuit;
- opening of sealed components;
- opening of ventilated enclosures.
- No any open fire or device like switch which may generate spark/arcing shall be around air conditioner to avoid causing ignition of the flammable refrigerant used. Please follow the instruction carefully to store or maintain the air conditioner to prevent mechanical damage from occurring.
- Do not use means to accelerate the

defrosting process or to clean, other than those recommended by the manufacturer.

- The appliance shall be stored in a room without continuously operating ignition sources (for example: open flames, an operating gas appliance) and ignition sources or (for example: an operating electric heater) close to the appliance.
- Do not pierce or burn.
- Be aware that the refrigerants may not contain an odour.

1. Transport of equipment containing flammable refrigerants.

See transport regulations.

2. Marking of equipment using signs

See local regulations.

3. Disposal of equipment using flammable refrigerants

See national regulations.

4. Storage of equipment/appliances

The storage of the appliance should be in accordance with the applicable regulations or instructions, whichever is more stringent.

5. Storage of packed (unsold) equipment

Storage package protection should be constructed such that mechanical damage to the equipment inside the package will not cause a leak of the refrigerant charge. The maximum number of pieces of equipment permitted to be stored together will be determined by local regulations.

6. Information on servicing

a) Checks to the area

Prior to beginning work on systems containing flammable refrigerants, safety checks are necessary to ensure that the risk of ignition is minimised. For repair to the refrigerating system, the following precautions shall be complied with prior to conducting work on the system.

b) Work procedure

Work shall be undertaken under a controlled procedure so as to minimise the risk of a flammable gas or vapour being present while the work is being performed.

6

IMPORTANT SAFETY INSTRUCTIONS

c) General work area

All maintenance staff and others working in the local area shall be instructed on the nature of work being carried out. Work in confined spaces shall be avoided. The area around the workspace shall be sectioned off. Ensure that the conditions within the area have been made safe by control of flammable material.

d) Checking for presence of refrigerant

The area shall be checked with an appropriate refrigerating detector prior to and during work, to ensure the technician is aware of potentially flammable atmospheres. Ensure that the leak detection equipment being used is suitable for use with flammable refrigerants, i.e. non-sparking, adequately sealed or intrinsically safe.

e) Presence of fire extinguisher

If any hot work is to be conducted on the refrigeration equipment or any associated parts, appropriate fire extinguishing equipment shall be available to hand. Have a dry powder or CO₂ fire extinguisher adjacent to the charging area.

f) No ignition sources

No person carrying out work in relation to a refrigerating system which involves exposing any pipe work that contains or has contained flammable refrigerant shall use any sources of ignition in such a manner that it may lead to the risk of fire or explosion. All possible ignition sources, including cigarette smoking, should be kept sufficiently far away from the site of installation, repairing, removing and disposal, during which flammable refrigerant can possibly be released to the surrounding space. Prior to work taking place, the area around the equipment is to be surveyed to make sure that there are no flammable hazards or ignition risks. No Smoking signs shall be displayed.

g) Ventilated area

Ensure that the area is in the open or that it is adequately ventilated before breaking into the system or conducting

any hot work. A degree of ventilation shall continue during the period that the work is carried out. The ventilation should safely disperse any released refrigerant and preferably expel it externally into the atmosphere.

h) Checks to the refrigerating equipment

Where electrical components are being changed, they shall be fit for the purpose and to the correct specification. At all times the manufacturer's maintenance and service guidelines shall be followed. If in doubt consult the manufacturer's technical department for assistance. The following checks shall be applied to installations using flammable refrigerants: The actual refrigerant charge is in accordance with the room size within which the refrigerant containing parts are installed; The ventilation machinery and outlets are operating adequately and are not obstructed; If an indirect refrigerating circuit is being used, the secondary circuit shall be checked for the presence of refrigerant; Marking to the equipment continues to be visible and legible. Markings and signs that are illegible shall be corrected; Refrigerating pipe or components are installed in a position where they are unlikely to be exposed to any substance which may corrode refrigerant containing components, unless the components are constructed of materials which are inherently resistant to being corroded or are suitably protected against being so corroded.

i) Checks to electrical devices

Repair and maintenance to electrical components shall include initial safety checks and component inspection procedures. If a fault exists that could compromise safety, then no electrical supply shall be connected to the circuit until it is satisfactorily dealt with. If the fault cannot be corrected immediately but it is necessary to continue operation, an adequate temporary solution shall be used. This shall be reported to the owner of the equipment so all parties are advised. Initial safety checks shall include:

That capacitors are discharged: this shall be done in a safe manner to avoid possibility of sparking; That there no live electrical components and wiring are exposed while charging, recovering or purging the system; That there is continuity of earth bonding.

7. Sealed electrical components shall be replaced.

8. Intrinsically safe components must be replaced.

9. Cabling

Check that cabling will not be subject to wear, corrosion, excessive pressure, vibration, sharp edges or any other adverse environmental effects. The check shall also take into account the effects of aging or continual vibration from sources such as compressors or fans.

10. Detection of flammable refrigerants

Under no circumstances shall potential sources of ignition be used in the searching for or detection of refrigerant leaks. A halide torch (or any other detector using a naked flame) shall not be used.

The following leak detection methods are deemed acceptable for systems containing flammable refrigerants. Electronic leak detectors shall be used to detect flammable refrigerants, but the sensitivity may not be adequate, or may need re-calibration. (Detection equipment shall be calibrated in a refrigerant-free area). Ensure that the detector is not a potential source of ignition and is suitable for the refrigerant used. Leak detection equipment shall be set at a percentage of the LFL of the refrigerant and shall be calibrated to the refrigerant employed and the appropriate percentage of gas (25 % maximum) is confirmed. Leak detection fluids are suitable for use with most refrigerants but the use of detergents containing chlorine shall be avoided as the chlorine may react with the refrigerant and corrode the copper pipe-work. If a leak is suspected, all naked flames shall be removed/extinguished. If a leakage of

refrigerant is found which requires brazing, all of the refrigerant shall be recovered from the system, or isolated (by means of shut off valves) in a part of the system remote from the leak. Removal of refrigerant shall be according to Removal and evacuation.

11. Removal and evacuation

When breaking into the refrigerant circuit to make repairs – or for any other purpose–conventional procedures shall be used. However, for flammable refrigerants it is important that best practice be followed, since flammability is a consideration. The following procedure shall be adhered to:

- a) Safely remove refrigerant following local and national regulations;
- b) Evacuate;
- c) Purge the circuit with inert gas (optional for A2L);
- d) Evacuate (optional for A2L);
- e) continuously flush or purge with inert gas when using flame to open circuit; and;
- f) open the circuit.

The refrigerant charge shall be recovered into the correct recovery cylinders if venting is not allowed by local and national codes. For appliances containing flammable refrigerants, the system shall be purged with oxygen-free nitrogen to render the appliance safe for flammable refrigerants. This process might need to be repeated several times. Compressed air or oxygen shall not be used for purging refrigerant systems. For appliances containing flammable refrigerants, refrigerants purging shall be achieved by breaking the vacuum in the system with oxygen-free nitrogen and continuing to fill until the working pressure is achieved, then venting to atmosphere, and finally pulling down to a vacuum (optional for A2L). This process shall be repeated until no refrigerant is within the system (optional for A2L). When the final oxygen-free nitrogen charge is used, the system shall be vented down to atmospheric pressure to enable

work to take place. Ensure that the outlet for the vacuum pump is not close to any potential ignition sources and that ventilation is available.

12. Charging procedures

In addition to conventional charging procedures, the following requirements shall be followed. Ensure that contamination of different refrigerants does not occur when using charging equipment. Hoses or lines shall be as short as possible to minimise the amount of refrigerant contained in them. Cylinders shall be kept in an appropriate position according to the instructions. Ensure that the refrigeration system is earthed prior to charging the system with refrigerant. Label the system when charging is complete (if not already). Extreme care shall be taken not to overfill the refrigeration system. Prior to recharging the system it shall be pressure tested with OFN. The system shall be leak tested on completion of charging but prior to commissioning. A follow up leak test shall be carried out prior to leaving the site.

13. Decommissioning

Before carrying out this procedure, it is essential that the technician is completely familiar with the equipment and all its detail. It is recommended good practice that all refrigerants are recovered safely. Prior to the task being carried out, an oil and refrigerant sample shall be taken in case analysis is required prior to re-use of reclaimed refrigerant. It is essential that electrical power is available before the task is commenced.

- a) Become familiar with the equipment and its operation.
- b) Isolate system electrically.
- c) Before attempting the procedure ensure that: Mechanical handling equipment is available, if required, for handling refrigerant cylinders; All personal protective equipment is available and being used correctly; The recovery process is supervised at all times by a competent person; Recovery equipment and cylinders conform to the appropriate

standards.

- d) Pump down refrigerant system, if possible.
- e) If a vacuum is not possible, make a manifold so that refrigerant can be removed from various parts of the system.
- f) Make sure that cylinder is situated on the scales before recovery takes place.
- g) Start the recovery machine and operate in accordance with instructions.
- h) Do not overfill cylinders. (No more than 80% volume liquid charge).
- i) Do not exceed the maximum working pressure of the cylinder, even temporarily.
- j) When the cylinders have been filled correctly and the process completed, make sure that the cylinders and the equipment are removed from site promptly and all isolation valves on the equipment are closed off.
- k) Recovered refrigerant shall not be charged into another refrigeration system unless it has been cleaned and checked.

14. Labelling

Equipment shall be labelled stating that it has been de-commissioned and emptied of refrigerant. The label shall be dated and signed. Ensure that there are labels on the equipment stating the equipment contains flammable refrigerant.

15. Recovery

When removing refrigerant from a system, either for servicing or decommissioning, it is recommended good practice that all refrigerants are removed safely. When transferring refrigerant into cylinders, ensure that only appropriate refrigerant recovery cylinders are employed. Ensure that the correct number of cylinders for holding the total system charge is available. All cylinders to be used are designated for the recovered refrigerant and labelled for that refrigerant (i.e. special cylinders for the recovery of refrigerant). Cylinders shall be complete with pressure relief valve and associated shut-off valves in good working order. Empty recovery

cylinders are evacuated and, if possible, cooled before recovery occurs.

The recovery equipment shall be in good working order with a set of instructions concerning the equipment that is at hand and shall be suitable for the recovery of flammable refrigerants. If in doubt, the manufacturer should be consulted. In addition, a set of calibrated weighing scales shall be available and in good working order. Hoses shall be complete with leak-free disconnect couplings and in good condition.

The recovered refrigerant shall be processed according to local legislation in

the correct recovery cylinder, and the relevant waste transfer note arranged.

Do not mix refrigerants in recovery units and especially not in cylinders.

If compressors or compressor oils are to be removed, ensure that they have been evacuated to an acceptable level to make certain that flammable refrigerant does not remain within the lubricant. The compressor body shall not be heated by an open flame or other ignition sources to accelerate this process. When oil is drained from a system, it shall be carried out safely.



A2L

CAUTION:
Risk of fire flammable materials

IMPORTANT NOTE: Read this manual carefully before installing or operating your new appliance unit. Make sure to save this manual for future reference.

	<p>CAUTION</p>	<p>This symbol shows that the operation manual should be read carefully.</p>
	<p>CAUTION</p>	<p>This symbol shows that information is available such as the operating manual or installation manual.</p>
	<p>CAUTION</p>	<p>This symbol shows that a service personnel should be handling this equipment with reference to the installation manual.</p>

10

IMPORTANT SAFETY INSTRUCTIONS

READ THIS SECTION BEFORE ATTEMPTING TO OPERATE AIR CONDITIONER.

Unit must be upright for one hour prior to operating.

The unit should be operated in a temperature range of 41°F - 95°F (5°C - 35°C). Performance may be reduced outside of these operating temperatures.

Operation of Current Device

The power supply cord contains a current device that senses damage to the power cord. To test your power supply cord do the following:

1. Plug in the Air Conditioner.
2. The power supply cord will have TWO buttons on the plug head. Press the TEST button. You will notice a click as the RESET button pops out.
3. Press the RESET button. Again you will notice a click as the button engages.
4. The power supply cord is now supplying electricity to the unit. (This is also indicated by a light on the plug head).

Plug in & press RESET

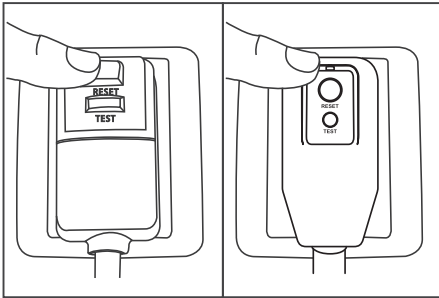

- Do not use this device to turn the unit on or off.
- Always make sure the RESET button is pushed in for correct operation.
- The power supply cord must be replaced if it fails to reset when either the TEST button is pushed, or it cannot be reset. A new one can be obtained from the product manufacturer.
- If power supply cord is damaged, it CANNOT be repaired. It MUST be replaced by one obtained from the product manufacturer.

Normal Sounds

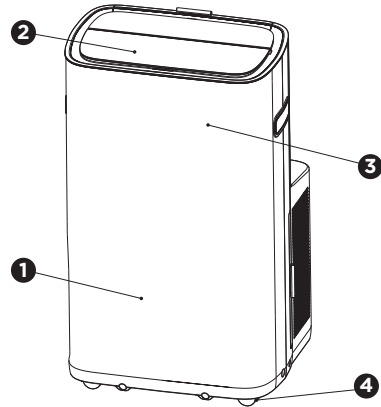

1 High pitched Chatter

Today's high efficiency compressors may have a high pitched chatter during the cooling cycle.

2 Sound of Rushing Air

At the top of the unit, you may hear the sound of rushing air being moved by the fan.

3 Gurgle/Hiss

"Gurgling or hissing" noise may be heard due to refrigerant passing through evaporator during normal operation.

4 Vibration

Unit may vibrate and make noise because of uneven floor.

FCC Interference Statement

This equipment has been tested and found to comply with the limits for a Class B digital device, pursuant to part 15 of the FCC Rules. These limits are designed to provide reasonable protection against harmful interference in a residential environment. This equipment generates, uses, and can radiate radio frequency energy and, if not installed and used in accordance with the instructions, may cause harmful interference to radio communications. However, there is no guarantee that interference will not occur in a particular installation. If this equipment does cause harmful interference to radio or television reception, which can be determined by tuning the device off and on, the user is encouraged to try to correct the interference by one or more of the following measures:

- Reorient or relocate the receiving antenna.
- Increase the separation between the device and receiver.
- Connect the equipment into an outlet other than the one used for the receiver.
- Consult the dealer or an experienced radio/TV technician for assistance.

This device complies with Part 15 of the FCC Rules. Operation is subject to the following two conditions: (1) This device may not cause harmful interference, and (2) This device must accept any interference received, including interference that may cause undesired operation.

FCC CAUTION: Any changes or modifications not expressly approved by the party responsible for compliance could void the user's authority to operate the equipment.

Host device Labeling

This device includes the following module. Contains FCC ID: 2ATEV-5027-P

RF exposure statement

This equipment complies with FCC radiation exposure limits set forth for an uncontrolled environment. This equipment should be installed and operated with minimum 20 cm between the radiator and your body. This transmitter must not be collocated or operating in conjunction with any other

antenna or transmitter unless authorized to do so by the FCC.

INDUSTRY CANADA (IC) STATEMENT

This Class B digital apparatus complies with Canadian ICES-003.

This device complies with Industry Canada license-exempt RSS standard(s). Operation is subject to the following two conditions: (1) this device may not cause interference, and (2) this device must accept any interference, including interference that may cause undesired operation of the device.

Le présent appareil est conforme aux CNR d'Industrie Canada applicables aux appareils radio exempts de licence. L'exploitation est autorisée aux deux conditions suivantes : (1) l'appareil ne doit pas produire de brouillage, et (2) l'utilisateur de l'appareil doit accepter tout brouillage radioélectrique subi, même si le brouillage est susceptible d'en compromettre le fonctionnement.

RF Exposure

The antenna (or antennas) must be installed so as to maintain at all times a distance minimum of at least 20 cm between the radiation source (antenna) and any individual. This device may not be installed or used in conjunction with any other antenna or transmitter.

l'exposition aux RF

L'antenne (ou les antennes) doit être installée de façon à maintenir à tout instant une distance minimum de au moins 20 cm entre la source de radiation (l'antenne) et toute personne physique.

Host device Labeling

This device includes the following module. Contains IC: 25062-5027P

Host dispositif d'étiquetage

Ce dispositif inclut le module suivant. Contient module émetteur IC: 25062-5027P

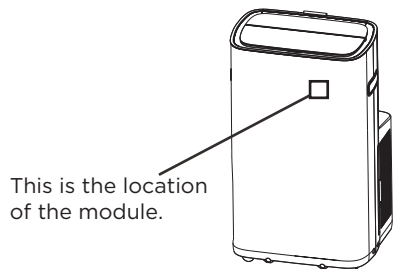

12 UNIT DESCRIPTION



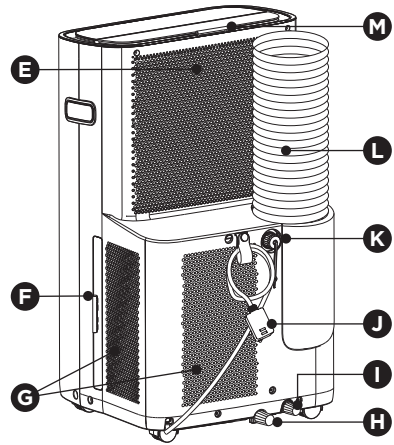
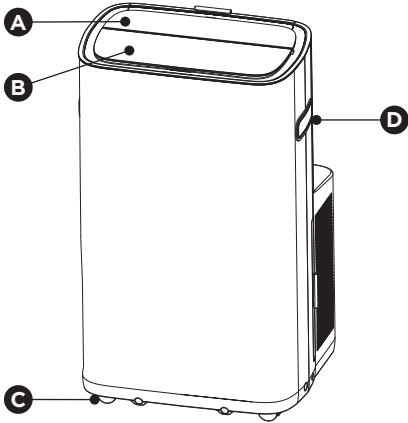







Unit Description

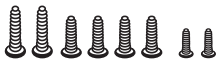

A	Control Panel
B	Air Outlet Louver
C	Casters
D	Handles
E	Indoor Air Inlet
F	Lower Filter
G	Lower Air Inlet

H	Bottom Drain Outlet
I	Heat Pump Drain Outlet (for heat pump model only)
J	Power Cord
K	Continuous Drain Outlet
L	Exhaust Hose
M	Upper Filter Handle

Accessories Included

PARTS:	PARTS NAME:	QUANTITY:
	Window Kit Connector A	1 pc
	Main Panel & Screws Pack 1	1 pc & 4pcs
	Telescopic Panel	1 pc
	Extender Panel	1 pc
	Screws Pack 2	2 pcs (5/8" screws) 4 pcs (1/2" screws) 2 pcs (2/5" screws)
	Safety Lock	1 pcs
	Sealing Strip	2 pcs
	Window Foam	1 pc
	Drain hose	1 pc
	Drain hose and connector (for heat pump model)	1 set(78.7"(2m))

Note: Some part are spare ones. Select them according to the actual situation.

Installation Instructions

EXHAUSTING HOT AIR

In the Cool Mode the appliance must be placed close to a window or opening so that the warm exhaust air can be ducted outside.

First position the unit on a flat surface, and make sure it is within the vicinity of a single circuit outlet power source. Make sure there's a minimum of 19.7" clearance in the front/back of the unit, and a minimum of 19.7" clearance in the left/right sides of the unit.

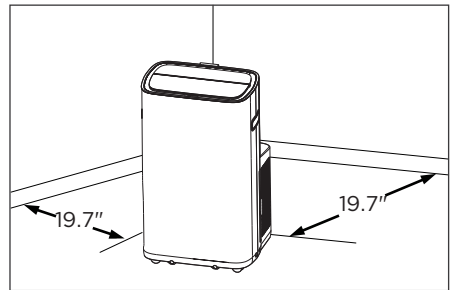

14 INSTALLATION INSTRUCTIONS

Select a suitable window.

Window slider kit can be install in a double-hung sash window or a sliding sash window with a dimension of 18.5" to 51".

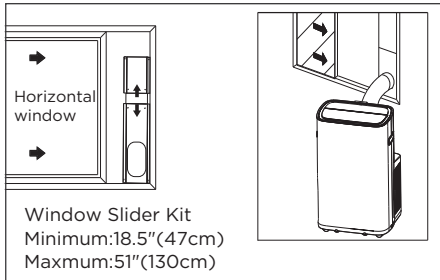
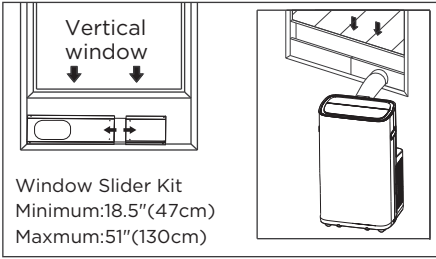

If the window's width/Height is between 18.5" to 28.3", cut the telescopic panel accordingly to fit your window.

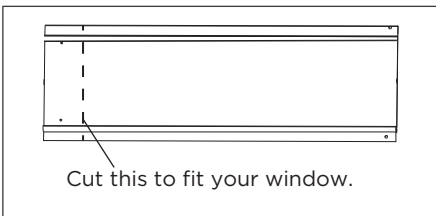

The hose can be extended from its original length of 15" up to 59", but try to maintain the minimum required length. Also make sure that the hose does not have any sharp bends or sags.

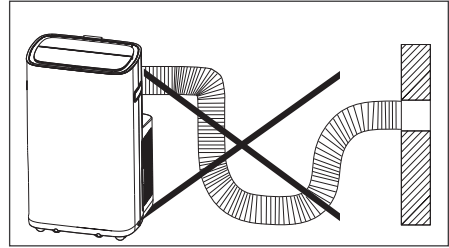

Installation in a double-hung sash window

1. Cut the adhesive sealing strip to the proper lengths and attach them to the window and sill.

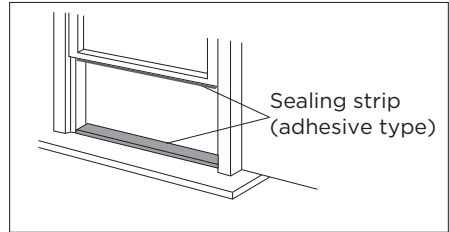

2. Open the window sash and place the window slider kit on the window stool. Adjust the length of the window slider kit according to the width of window. Use the four screws that packed with the window slider kit panels to fix the length of the window slider kit.

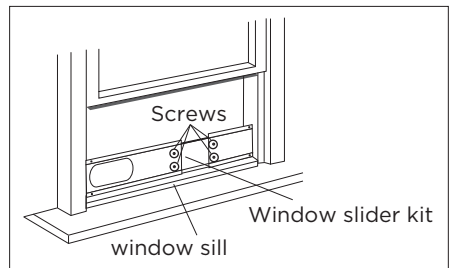

Note: Not all installations require all 3 window kit panels and four screws. Select according to the actual situation.

INSTALLATION INSTRUCTIONS 15

3. Close the window sash securely against the window slider kit.

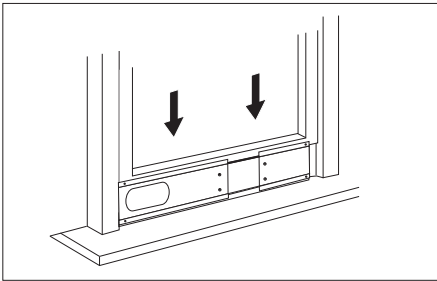

4. Drive four 1/2" screws to secure the window slider kit to the window.

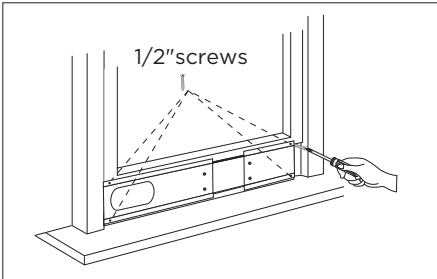

5. To secure lower sash in place, attach Safety lock with 5/8" (16mm) screws as shown.

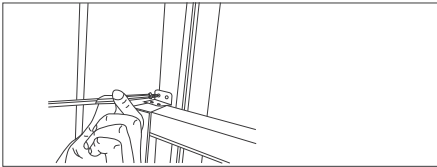

6. Cut the non-adhesive window foam to an appropriate length and seal the open gap between the upper window sash and lower window sash.

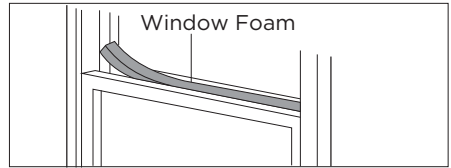

Installation in a sliding sash window

1. Cut the adhesive sealing strip to the proper lengths and attach them to the window frame.

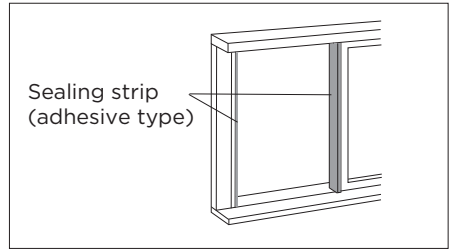

2. Open the window sash and place the window slider kit on the window stool. Attach the window slider kit to the window stool. Adjust the length of the window slider kit according to the height of window. Use the four screws that packed with the window slider kit panels to fix the length of the window slider kit.

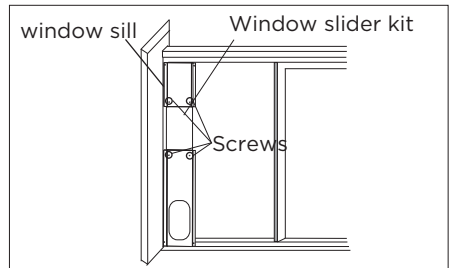

Note: Not all installations require all 3 window kit panels and four screws. Select according to the actual situation.

16

INSTALLATION INSTRUCTIONS

3. Close the window sash securely against the window slider kit.

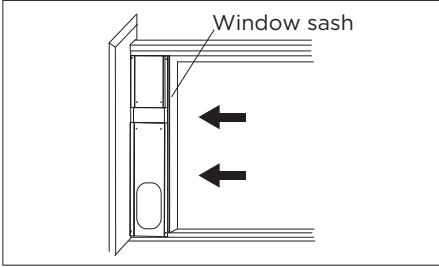

6. Cut the window foam to an appropriate length and seal the open gap between the sliding sash and outer window sash.

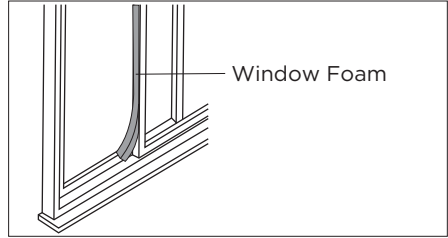

4. Drive four 1/2" screws to secure the window slider kit to the window.

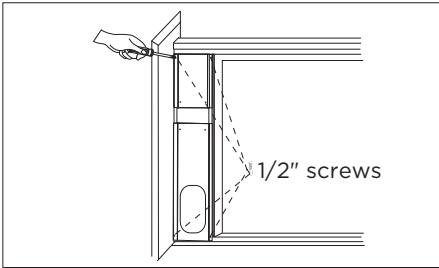

Installation of exhaust hose

1. Extend the exhaust hose, then turn the connector anticlockwise into the exhaust hose.

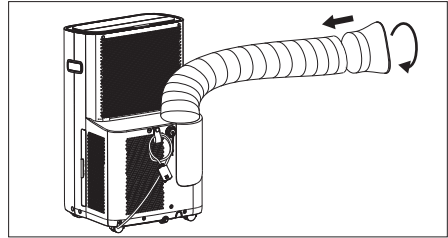

5. To secure sliding sash in place, attach Safety lock with 5/8" (16mm) screws as shown.

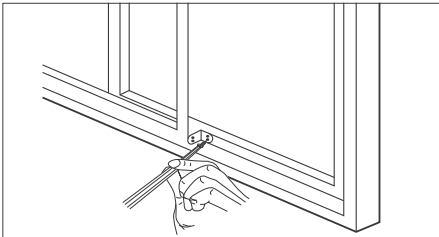

2. Insert the connector to the window slider board.

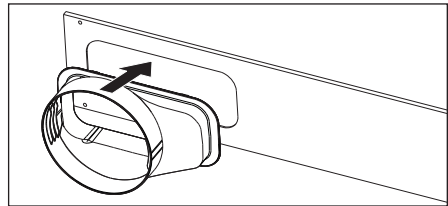

AIR CONDITIONER FEATURES

Control Panel

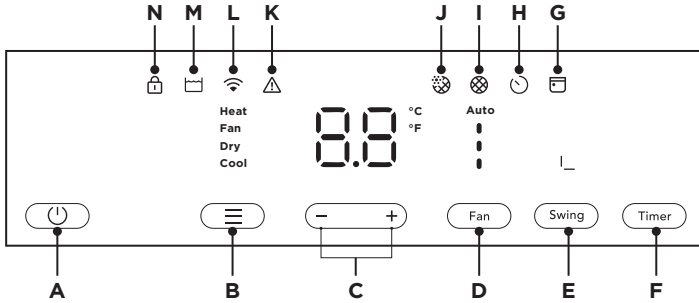

A	Power on/off Button
B	Function Selection Button
C	Adjust Temperature
D	Fan Speed Button
E	Swing Button
F	Timer Button
G	Scheduler Indicator

H	Timer Indicator
I	Dust Filter Indicator
J	PureAir™ Filter Indicator
K	Error Indicator
L	WIFI Indicator*
M	Water Full Indicator
N	Child Lock Indicator

*Refer to the Quick Start Guide that came with your Smart Air Conditioner for detailed instructions on setting up your air conditioner for connected operation from your smart phone or tablet.

Note: Heat function is for heat pump model only.

The software in the <PRODUCT/appliance> is partly based on free and open source software.

To see the full copyright information and applicable license terms, please visit:

<https://emtech.delta.electrolux.com/license>

18

OPERATING INSTRUCTIONS

OPERATING INSTRUCTION

Standby status

After plugging in, unit will be in standby status. Only “⏻” and Timer buttons are available.

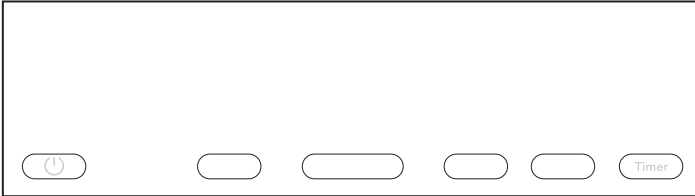

To change temperature setting

Press the “⏻” button to turn the unit ON.

Press the “-” or “+” button to choose the temperature in a range of 60°F - 90°F (16°C - 32°C).

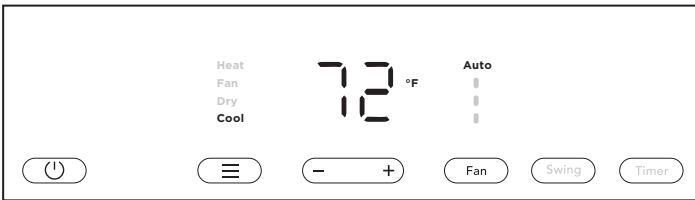

Note: In Dry or Fan function, temperature setting is disabled.

Cool mode

Press the “☰” button until the Cool mode indicator lights up.

Press the “Fan Speed” button to choose the fan speed according to the illumination of the fan speed indicator.

You can choose the “Auto”, “Low”, “Med”, or “Hi” fan speed setting.

Press the “-” or “+” button to choose the temperature you want.

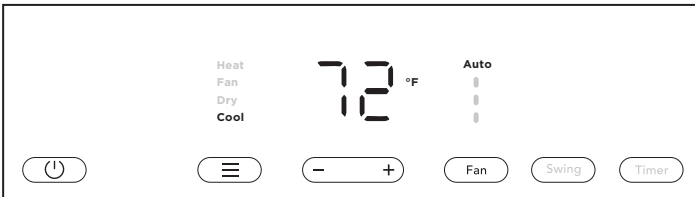

Dry mode

Press the “≡” button until the Dry mode indicator lights up.

In this mode, the “-” or “+” button is disabled and the screen displays will be off. The unit will continuously drain moisture from the room.

Note: In this mode, the fan speed will be automatically set to “Low”, which cannot be changed.

In this mode, condensate drainage is required, refer to the “Drainage Instructions” for more instructions to drain the excess condensate.

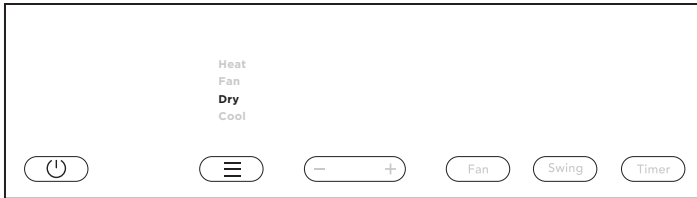

Fan mode

Press the “≡” button until the Fan mode indicator lights up.

In this mode, you can select fan speed “Auto”, “Low”, “Med”, or “Hi”.

In this mode, the “-” or “+” button is disabled and the screen displays will be off.

Note: If PureAir™ filter(sold separately) is not installed, Auto fan speed will be disabled.

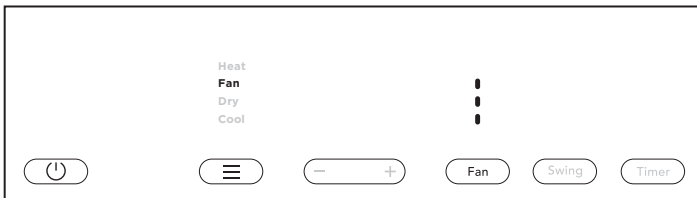

Heat Mode(For heat pump models only)

Press the “≡” button until the Heat mode indicator lights up.

Press the “-” or “+” button to choose the temperature you want.

Press the Fan button to choose the fan speed according to the illumination of the fan speed indicator. You can choose the “Hi”, “Med”, “Low”, or “Auto” fan speed setting.

Note: In this mode, the air exhaust hose needs to be connected.

The unit has a built-in condensate pump to pump out the excess condensate during heating mode. Condensate drainage is required, refer to the “Drainage Instructions” for more instructions to drain the excess condensate.

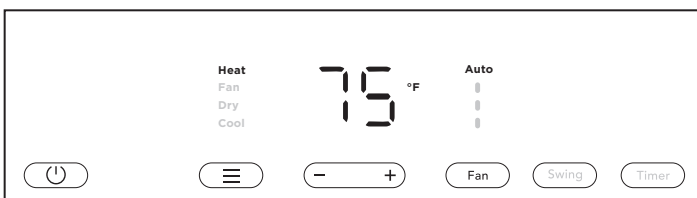

20 OPERATING INSTRUCTIONS

Louver Swing Function

Auto swing

Press the “Swing” button to enable louver swing function, the swing button will illuminate and the louver on the top panel will swing up and down. Press this button again to disable the louver swing function.

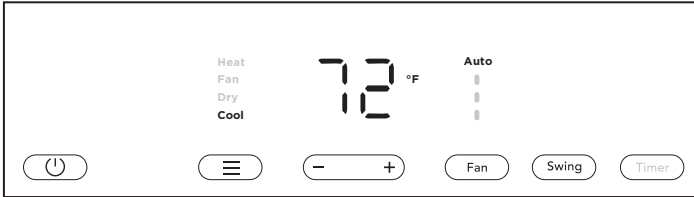

Indirect airflow

Press and hold the “Swing” button for 3 seconds to set the louver as indirect airflow. The louver will move to the maximum opening position. The indirect icon will light up. Press this button again to cancel.

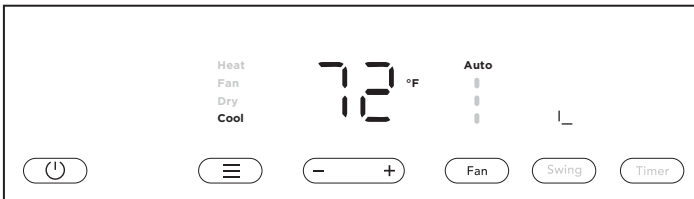

How to delay startup

Plug in the unit, so the unit turns to standby. Press the “Timer” button, when the unit is off. The Timer button will be activated, the screen will display “00” and “Timer indicator” will flash. Press the “-” or “+” to change delay start timer at 0.5 hour increments up to 10 hours, then at 1 hour increments up to 24 hours. After 5 seconds, the timer function is enabled, then “Timer indicator” will stop flashing, the display will be off. Once the timer function is enabled, adjust the desired settings using the buttons on the display. If no changes are made, the unit will start with the previous settings.

To cancel the setting, press the “timer” button again. You can also cancel the setting by pressing the “⏻” button.

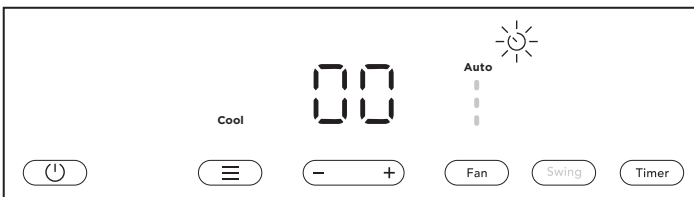

How to delay shutdown

You can delay shutdown when the unit is on. Press the “timer” button, when the unit is on. The Timer button will be activated, the screen will display “00” and “Timer indicator” will flash. Press the “-” or “+” to change delay start timer at 0.5 hour increments up to 10 hours, then at 1 hour increments up to 24 hours. After 5 seconds, the timer function is enabled, then “Timer indicator” will stop flashing, the display will back to original status. The unit will turn off.

To cancel the setting, press the “timer” button again. You can also cancel the setting by pressing the “(U)” button.

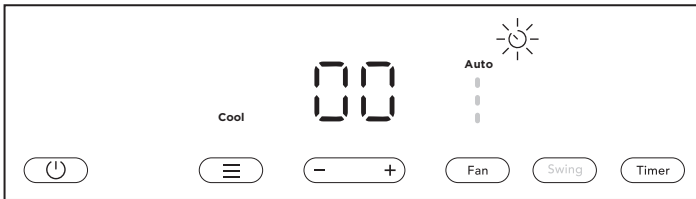

Dust filter reset

This feature is a reminder to clean the Air Filter (See Care and Cleaning) for more efficient operation.

The “Dust Filter” indicator will illuminate after 250 hours of fan operation. Press and hold the “Fan” button for 3 seconds to reset, after cleaning the filter.

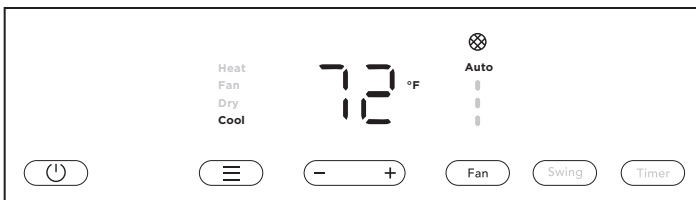

PureAir™ filter indicator

This feature is a reminder to replace the PureAir™ Filter(sold separately) for more efficient operation.

If the PureAir™ filter(sold separately) is installed, the “PureAir™ Filter” indicator will illuminate after service life of the PureAir™ Filter end. Press and hold the “Fan” button for 3 seconds to reset, after replacing the advanced filter.

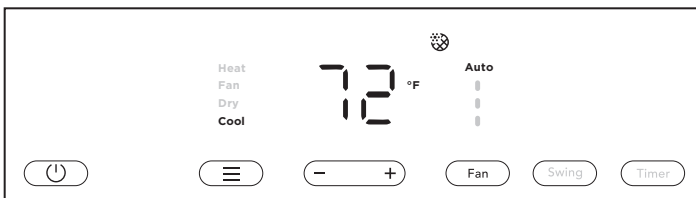

Note: If both dust filter indicator and PureAir™ filter indicator illuminate, Long press the Fan button will reset the dust filter indicator first. Do it again to reset PureAir™ filter indicator.

22 OPERATING INSTRUCTIONS

Child Lock

Press and hold the “⏻” and “☰” button for 5 seconds to activate the Child Lock mode. In this mode, the unit’s setting cannot be changed by pressing the buttons on control panel. The display will show “LC” for 5 seconds then return to the normal display. Press and hold the Power and “☰” button for another 5 seconds to quit this mode.

Note: After the child lock feature activated the setting can still be changed by app.

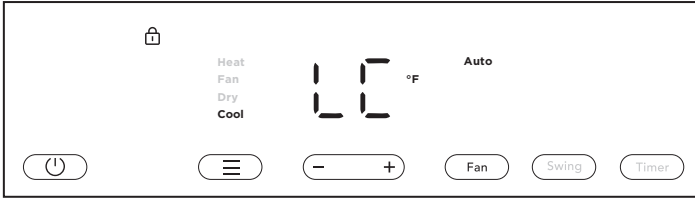

°F/°C function

Press the “-” and “+” button at the same time for more than 3 seconds to switch between degrees Fahrenheit and degrees Celsius.

Note: °F/°C can only be change during cool or heat(for heat pump models) function.

Dimming Display

After 20 seconds of control inactivity the active icon and button will reduce the brightness, and the inactive icon and button will turn off. Press any button on the control panel and the display will resume.

Sleep mode

In this mode, the fan speed will automatically set to “Auto”, which cannot be changed.

In Cool mode the selected temperature will increase by 2 °F 30 minutes after the mode is selected. The temperature will then increase by another 2 °F for an additional 30 minutes. This new temperature will be maintained for 7 hours before it returns to the originally selected temperature. This ends the “Sleep” mode and the unit will continue to operate as originally programmed.

The Sleep mode program can be cancelled at any time during operation by pressing the “Mode”, “Fan speed” or “⏻” button.

Note: Sleep mode can only be activated by app.

Sleep mode only available in cool or heat function.

In Sleep mode, air quality light will be off.

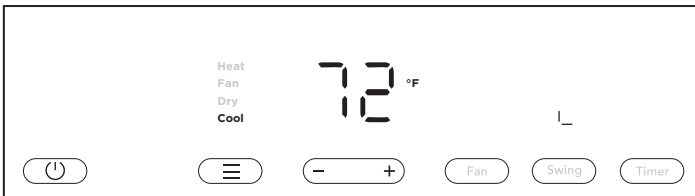

Water full indicator

When the condensate is full, the water full indicator will turn on and display will show P1. Emptying the condensate residue inside the unit to reset. Refer to the "Drainage Instructions" more instructions to drain the successive condensate.

If error repeats more than 4 times in one day, contact your Authorized Frigidaire Service Center.

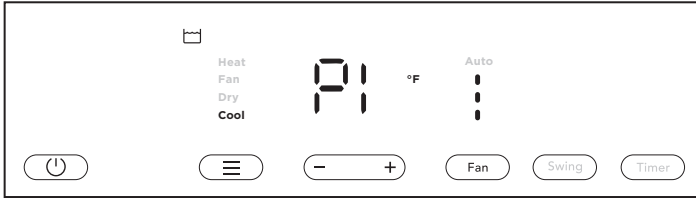

Error code

When the unit detect error, the screen will display error code and the error indicator will be on. Turn off the unit and restart. If the error persists, contact your authorized Frigidaire Service Center.

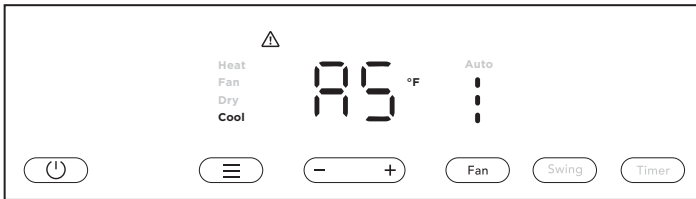

Error code	Possible reason
"AS", "ES"	A temperature sensor has failed.
"FB"	The upper fan motor has failed.
"E4"	Communication between display PCB and main control PCB is faulty.

24 OPERATING INSTRUCTIONS

Drainage Instructions

Continuous Drainage

During the Dry mode, you will need a garden hose (sold separately) to drain the condensed water from the unit. Follow the steps below:

- Unscrew the drain cap of continuous drain outlet.

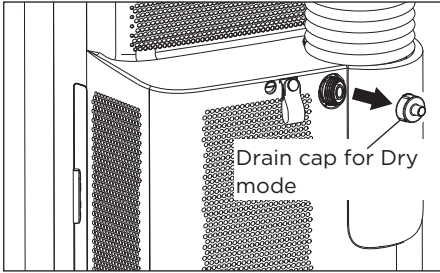

- Connect one end of the garden hose (sold separately) to the drain outlet then lead the other end into a drain that is lower than the unit.

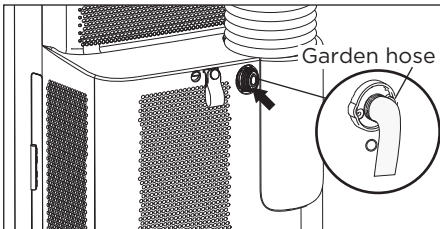

NOTE:

- Condensate may flow out after removing the drain cap, if the unit is running in Cool, Dry function. When you want to remove the garden hose, prepare a drip tray (not supplied) to collect the condensate from the drain outlet.
- Please be sure that the height and section of the drain hose should not be higher than that of the drain outlet, or the continuous drainage may not work properly.
- During Cool function, it is recommended to disable continuous drainage by replacing the drain cap to the drain outlet, to reach the maximum performance.

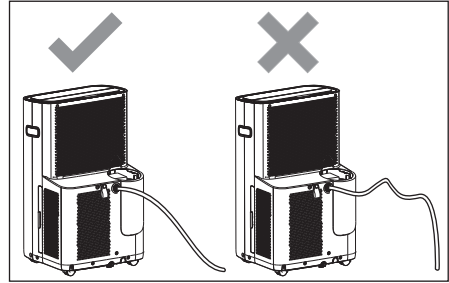

Heat pump Drainage(For heating & cooling model only)

During the Heat mode, you will need a 1/4" drainage hose (packed with the unit) to drain the condensate from the unit.

Follow the steps below:

- Unscrew the heat pump drain cap then pull off the rubber plug of heat pump drain outlet.

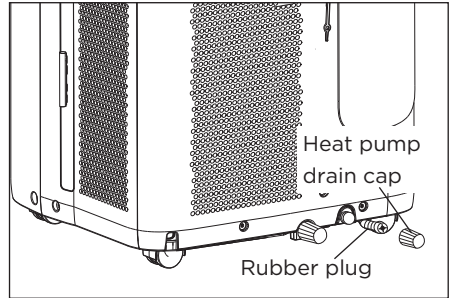

- Insert the rubber head into the outlet. Then screw the sealing cap into the heat pump drain outlet.

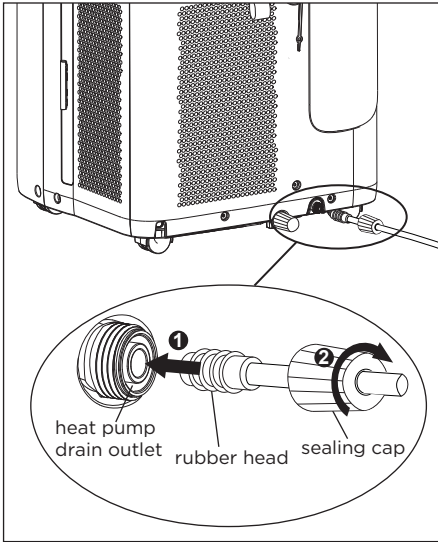

- Lead the other end of the 1/4" drainage hose to a drain that is not 16ft(5m) higher than the heat pump drain outlet.

Note:

Do not drain condensate outside when outside temperature is below 32°F (0°C).

Emptying the condensate residue inside the unit during winter storage.

Put a drip tray (not supplied) under the continuous drain outlet, then unscrew the drain cap to allow the condensate to flow into the drip tray. Replace the drain cap to the continuous drain outlet when no condensate flows out.

Put the drip tray under the bottom drain outlet, then remove the rubber stopper from the drain outlet, to allow the condensate to flow into the drip tray. If your drip tray can't hold all the condensate, a number of fills will be needed.

Replace the drain cap to the bottom drain outlet when no condensate flows out.

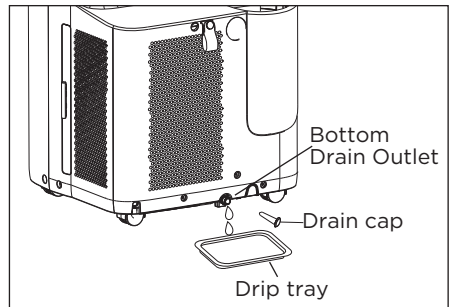

Note: To ensure all condensate residue has been removed, tilt the unit by lifting it slightly upwards from the front until no more condensate comes out from the drain outlet.

26 CARE AND CLEANING

Cleaning

Clean your air conditioner every 2 weeks to keep it looking new. Be sure to unplug the unit before cleaning to prevent shock or fire hazards.

CLEANING THE UNIT

The cabinet and front may be dusted with an oil-free cloth or washed with a cloth dampened in a solution of warm water and mild liquid dishwashing detergent.

Never use harsh cleaners, wax or polish on the cabinet front.

Be sure to wring excess water from the cloth before wiping around the controls. Excess water in or around the controls may cause damage to the air conditioner.

CLEANING THE FILTERS

To keep your air conditioner working efficiently, you should clean the Dust filters every 2 weeks of operation.

Grasp the handle of the upper filter and pull up to take off the upper filter.

Grasp the handle of the lower filter and pull towards to the front panel direction to take off the filter.

Wash the dust filters using liquid dishwashing detergent and warm water. Rinse Dust filters thoroughly. Gently shake excess water from the Dust filter. Be sure Dust filter is thoroughly dry before replacing.

Note: If PureAir™ filter(sold separately) is installed, take off the PureAir™ filter before cleaning the upper dust filter.

Note:

Use vacuum cleaner to clean the lower filter area before taking out the filter can avoid dust popping out when taking out the filter.

When pulling out the lower filter, pull it slightly to the side.

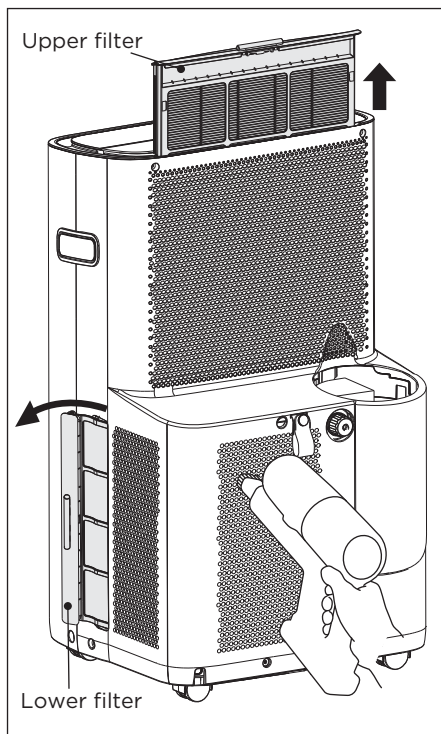

PureAir™ filter

This unit has available space for use with a PureAir™ Filters (sold separately). Different types of PureAir™ Filters can be purchased by scanning the QR code on the air inlet grille, by visiting Frigidaire.com, or by calling Frigidaire Customer Service Center 1-800-944-9044(US) / 1-800-265-8352 (Canada).

To install PureAir™ filter:

1. Take out the upper filter.
2. Put the PureAir™ filter in reserved space on the upper filter grille.
3. Replace the upper filter together with the PureAir™ filter.

The PureAir™ filter can not be clean by water.

Air quality sensor cleaning

Air quality sensor need to be clean every 2 weeks. Open the air quality sensor door and clean the sensor by vacuum cleaner.

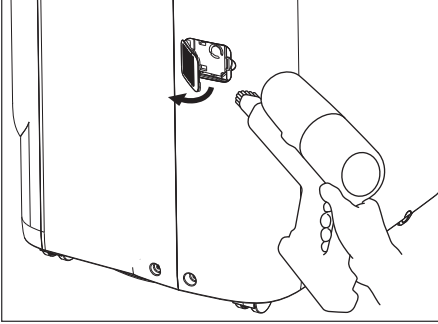

Note: The evaporator contains sharp part, user should not clean it by themselves. Always wear gloves before touching any sharp part.

Power cord storage

When unit is not in use or need to move the unit, pull out the plug and store the power cord as show below.

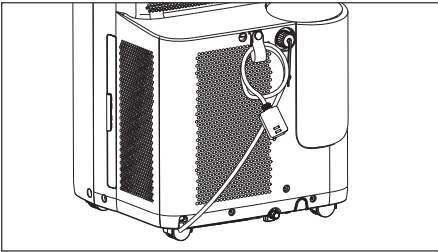

Winter Storage

If the air conditioner will not be used for an extended period of time:

- 1.Drain the water collection tank completely and leave the bottom drain cap and rubber plug off for an extended period of time to allow any residual. Once the tank is completely drained and no more water flows out, reinstall the rubber plug and cap.
- 2.Remove and clean the filter, allow it to dry completely, then reinstall it.
- 3.Remove the batteries from the remote control(If applicable).
- 4.Store the air conditioner in a cool, dry location, away from direct sunlight, extreme temperature, and excessive dust.

Before using the air conditioner again:

- 1.Make sure the filter and drain cap are in place.
- 2.Check the cord to make sure it is in good condition, without cracks or damage.
- 3.Place new batteries in the remote control. (If applicable)
- 4.Install the air conditioner as described in the Installation Instructions.

28 BEFORE YOU CALL

Before calling for service, review this list. It may save you time and expense. This list includes common occurrences that are not the result of defective workmanship or materials in this appliance.

OCCURRENCE	SOLUTION
Air conditioner will not operate.	<ul style="list-style-type: none"> • Wall plug disconnected. Push plug firmly into wall outlet. • Plug Current Device Tripped. Press the RESET button. • House fuse blown or circuit breaker tripped. Replace fuse with time delay type or reset circuit breaker. • Control is OFF. Turn Control ON and set to desired setting. • P1 appears in the display window. Drain water as described in Drainage Section. • Room Temperature lower than the set temperature. Reset the temperature.
Air from unit does not feel cold enough.	<ul style="list-style-type: none"> • Room temperature below 60°F (16°C). Cooling may not occur until room temperature rises above 60°F (16°C). • Reset to a lower temperature. • Compressor shut-off by changing modes. Wait approximately 4 minutes and listen for compressor to restart when set in the COOL mode.
Air conditioner cooling, but room is too warm - ice forming on cooling coil behind decorative front	<ul style="list-style-type: none"> • Outdoor temperature below 60°F (16°C). To defrost the coil, set FAN ONLY mode. • Air filter may be dirty. Clean filter. Refer to Care and Cleaning section. To defrost, set to FAN ONLY mode. • Temperature is set too low for night-time cooling. To defrost the coil, set to FAN ONLY mode. Then, set temperature to a higher setting. • Exhaust duct not connected or blocked. See EXHAUSTING HOT AIR Section.
Air conditioner cooling, but room is too warm - NO ice forming on cooling coil behind decorative front.	<ul style="list-style-type: none"> • Dirty air filter - air restricted. Clean air filter. Refer to Care and Cleaning section. • Temperature is set too high. Set temperature to a lower setting. • Air directional louvers positioned improperly. Position louvers for better air distribution. • Front of unit is blocked by drapes, blinds, furniture, etc. - restricts air distribution. Clear blockage in front of unit. • Doors, windows, registers, etc. open - cool air escapes. Close doors, windows, registers, etc. • Unit recently turned on in hot room. Allow additional time to remove "stored heat" from walls, ceiling, floor and furniture.
Air conditioner turns on and off rapidly.	<ul style="list-style-type: none"> • Dirty air filter - air restricted. Clean air filter. • Outside temperature extremely hot. Set FAN speed to a faster setting to bring air through cooling coils more frequently.
Noise when unit is cooling.	<ul style="list-style-type: none"> • Air movement sound. This is normal. If too loud, set to lower FAN setting. • Vibration from uneven floor. Move or support appliance correctly on even surface.

OCCURRENCE	SOLUTION
Room too cold.	• Set temperature too low. Increase set temperature.
Room too hot.	• Set temperature too high. Lower setting.

**If These Solutions Fail, Call 1-800-944-9044(US)/1-800-265-8352(Canada)
For Frigidaire Service.**

30 MAJOR APPLIANCE LIMITED WARRANTY

Your appliance is covered by a limited one-year warranty for functional repairs only. For one year from your original date of purchase, Electrolux will pay all costs for repairing or replacing any parts of this appliance that prove to be defective in materials or workmanship when such appliance is installed, used and maintained in accordance with the provided instructions. After one year from your original date of purchase, the consumer will be responsible for diagnostic, labor and parts costs as well as any removal, transportation and reinstallation expenses which are incurred during service on components.

Exclusions

This warranty does not cover the following:

1. Products with original serial numbers that have been removed, altered or cannot be readily determined.
2. Product that has been transferred from its original owner to another party or removed outside the USA or Canada.
3. Rust on the interior or exterior of the unit.
4. Products purchased "as-is" are not covered by this warranty.
5. Food loss due to any refrigerator or freezer failures.
6. Products used in a commercial setting.
7. Service calls which do not involve malfunction or defects in materials or workmanship, or for appliances not in ordinary household use or used other than in accordance with the provided instructions.
8. Service calls to correct the installation of your appliance or to instruct you how to use your appliance.
9. Expenses for making the appliance accessible for servicing, such as removal of trim, cupboards, shelves, etc., which are not a part of the appliance when it is shipped from the factory.
10. Service calls to repair or replace appliance light bulbs, air filters, water filters, other consumables, or knobs, handles, or other cosmetic parts.
11. Surcharges including, but not limited to, any after hour, weekend, or holiday service calls, tolls, ferry trip charges, or mileage expense for service calls to remote areas, including the state of Alaska.
12. Damages to the finish of appliance or home incurred during installation, including but not limited to floors, cabinets, walls, etc.
13. Damages caused by: services performed by unauthorized service companies; use of parts other than genuine Electrolux parts or parts obtained from persons other than authorized service companies; or external causes such as abuse, misuse, inadequate power supply, accidents, fires, or acts of God.

DISCLAIMER OF IMPLIED WARRANTIES; LIMITATION OF REMEDIES

CUSTOMER'S SOLE AND EXCLUSIVE REMEDY UNDER THIS LIMITED WARRANTY SHALL BE PRODUCT REPAIR OR REPLACEMENT AS PROVIDED HEREIN. CLAIMS BASED ON IMPLIED WARRANTIES, INCLUDING WARRANTIES OF MERCHANTABILITY OR FITNESS FOR A PARTICULAR PURPOSE, ARE LIMITED TO ONE YEAR OR THE SHORTEST PERIOD ALLOWED BY LAW, BUT NOT LESS THAN ONE YEAR. ELECTROLUX SHALL NOT BE LIABLE FOR CONSEQUENTIAL OR INCIDENTAL DAMAGES SUCH AS PROPERTY DAMAGE AND INCIDENTAL EXPENSES RESULTING FROM ANY BREACH OF THIS WRITTEN LIMITED WARRANTY OR ANY IMPLIED WARRANTY. SOME STATES AND PROVINCES DO NOT ALLOW THE EXCLUSION OR LIMITATION OF INCIDENTAL OR CONSEQUENTIAL DAMAGES, OR LIMITATIONS ON THE DURATION OF IMPLIED WARRANTIES, SO THESE LIMITATIONS OR EXCLUSIONS MAY NOT APPLY TO YOU. THIS WRITTEN WARRANTY GIVES YOU SPECIFIC LEGAL RIGHTS. YOU MAY ALSO HAVE OTHER RIGHTS THAT VARY FROM STATE TO STATE.

If You Need Service Keep your receipt, delivery slip, or some other appropriate payment record to establish the warranty period should service be required. If service is performed, it is in your best interest to obtain and keep all receipts. Service under this warranty must be obtained by contacting Electrolux at the addresses or phone numbers below.

This limited warranty only applies in the USA and Canada. In the USA, your appliance is warranted by Electrolux Major Appliances North America, a division of Electrolux Home Products, Inc. In Canada, your appliance is warranted by Electrolux Canada Corp. Electrolux authorizes no person to change or add to any obligations under this warranty. Obligations for service and parts under this warranty must be performed by Electrolux or an authorized service company. Product features or specifications as described or illustrated are subject to change without notice.

USA
1.800.944.9044
Electrolux Major Appliances
10200 David Taylor Drive
Charlotte, NC 28262



Canada
1.800.265.8352
Electrolux Canada Corp.
5855 Terry Fox Way
Mississauga, Ontario, Canada
LSV 3E4

FRIGIDAIRE®

welcome *home*

Our home is your home. Visit us if you need help with any of these things:



owner support



accessories



service



registration

(See your registration card for more information.)

Frigidaire.com
1-800-944-9044

Frigidaire.ca
1-800-265-8352