

INDUCTION COOKTOP

use & care

Introduction	2	Care and Cleaning	20
Important Safety Instructions	3	Before You Call	23
Before Setting Surface Controls	9	Warranty	24
Setting Surface Controls	15		

2

INTRODUCTION

Welcome to our *family*

Thank you for bringing Frigidaire into your home! We see your purchase as the beginning of a long relationship together.

This manual is your resource for the use and care of your product. Please read it before using your appliance. Keep it handy for quick reference. If something doesn't seem right, the troubleshooting section will help you with common issues.

FAQs, helpful tips and videos, cleaning products, and kitchen and home accessories are available at www.frigidaire.com.

We are here for you! Visit our website, chat with an agent, or call us if you need help. We may be able to help you avoid a service visit. If you do need service, we can get that started for you.

Let's make it official! Be sure to register your product.

Keep your product info here so it's easy to find.

Model Number: _____

Serial Number: _____

Purchase Date: _____

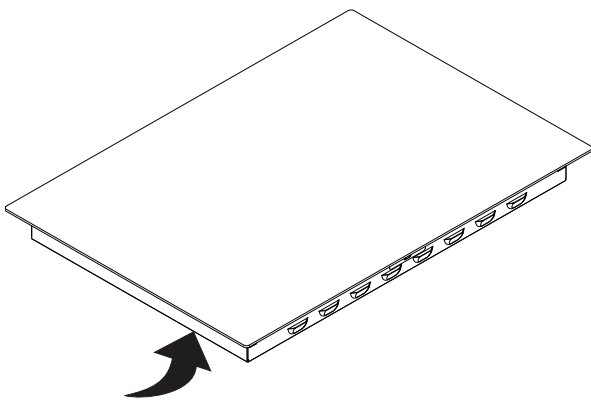

Serial Number Location



Installation Checklist

- Read all the safety instructions in the front of your Use & Care Manual.
- Remove all packaging materials from your appliance before cooking.
- Confirm that the electrical power to the appliance is turned on.
- Test all cooking zones to make sure they are working properly (page ref).
- Remember to complete your product registration!

Read all instructions before using this appliance.

This manual contains important safety symbols and instructions. Please pay attention to these symbols and follow all instructions given.

Do not attempt to install or operate your appliance until you have read the safety precautions in this manual. Safety items throughout this manual are labeled with a WARNING or CAUTION statement based on the risk type.

Warnings and important instructions appearing in this guide are not meant to cover all possible conditions and situations that may occur. Common sense, caution, and care must be exercised with installing, maintaining, or operating your appliance.

DEFINITIONS



This is the safety alert symbol. It is used to alert of potential personal injury hazards. Obey all safety messages that follow this symbol to avoid possible injury or death.



WARNING

Indicates a potentially hazardous situation which, if not avoided, may result in death or serious injury.



CAUTION

Indicates a potentially hazardous situation which, if not avoided, may result in minor or moderate injury.



IMPORTANT

Indicates installation, operation or maintenance information which is important but not hazard-related.



NOTE

Indicates a short, informal reference - something written down to assist the memory or for future reference.

IMPORTANT INSTRUCTIONS FOR UNPACKING AND INSTALLATION



IMPORTANT

Read and follow the below instructions and precautions for unpacking, installing, and servicing your appliance.

Remove all tape and packaging before using the appliance. Destroy the carton and plastic bags after unpacking the appliance. Never allow children to play with packaging material. Do not remove the wiring label and other literature attached to the appliance. Do not remove model/serial number plate.

Cold temperatures can damage the electronic control. When using this appliance for the first time, or when the appliance has not been used for an extended period of time, be sure the appliance has been in temperatures above 32°F (0°C) for at least 3 hours before turning on the power to the appliance.

Never modify or alter the construction of the appliance by removing the leveling legs, panels, wire covers, anti-tip brackets/screws, or any other part of the appliance.

Be sure to have an appropriate foam-type fire extinguisher available, visible, and easily accessible located near the appliance.

4

IMPORTANT SAFETY INSTRUCTIONS

GROUNDING INSTRUCTIONS

WARNING

- Avoid fire hazard or electrical shock. Failure to follow this warning may cause serious injury, fire, or death.
- Avoid fire hazard or electrical shock. Do not use an adapter plug, use an extension cord, or remove grounding prong from the power cord. Failure to follow this warning may cause serious injury, fire, or death.

Proper Installation—Be sure your appliance is properly installed and grounded by a qualified technician. In the United States, install in accordance with the National Fuel Gas Code ANSI Z223.1/NPFA No. 54, latest edition and National Electrical Code NFPA No. 70 latest edition, and local electrical code requirements. In Canada, install in accordance with CAN/CGA B149.1 and CAN/CGA B149.2 and CSA Standard C22.1, Canadian Electrical code, Part 1-latest editions and local electrical code requirements. Install only per installation instructions provided in the literature package for this appliance.

For personal safety, this appliance must be properly grounded. For maximum safety, the power cord must be securely connected to an electrical outlet or junction box that is the correct voltage, is correctly polarized and properly grounded, and protected by a circuit breaker in accordance with local codes.

It is the personal responsibility of the consumer to have the appropriate outlet or junction box with the correct, properly grounded wall receptacle installed by a qualified electrician. It is the responsibility and obligation of the consumer to contact a qualified installer to assure that the electrical installation is adequate and is in conformance with all local codes and ordinances.

See the installation instructions packaged with this appliance for complete installation and grounding instructions.

IMPORTANT INSTRUCTIONS FOR USING THE APPLIANCE

WARNING

- Storage In or On Appliance—Flammable materials should not be stored in an oven or microwave, near surface burners or elements, or in the storage or warmer drawer (if equipped). This includes paper, plastic, and cloth items, such as cookbooks, plastic ware, and towels, as well as flammable liquids. Do not store explosives, such as aerosol cans, on or near the appliance.
- Do not leave children alone - Children should not be left alone or unattended in the area where appliance is in use. They should never be allowed to sit or stand on any part of the appliance, including the storage drawer, lower broiler drawer, warmer drawer, or lower double oven.

! WARNING

- Do not store items of interest to children in the cabinets above the appliance or on the backguards of ranges. Children climbing on or near the appliance to reach items could be seriously injured.
- Do not allow children to climb or play around the appliance. The weight of a child on an open oven door may cause the appliance to tip, resulting in serious burns or other injury. An open drawer when hot may cause burns. Stepping, leaning, or sitting on the door or drawers of this appliance can result in serious injuries and also cause damage to the appliance.
- Never cover any slots, holes or passages in the oven bottom or cover and entire rack with materials such as aluminum foil. Doing so blocks air flow through the oven and may cause carbon monoxide poisoning. Aluminum foil linings may also trap heat, causing a fire hazard.
- Do not use oven or warmer drawer (if equipped) for storage.
- Never use your appliance as a space heater to heat or warm the room. Doing so may result in carbon monoxide poisoning and overheating of the appliance.

! CAUTION

- When heating fat or grease, watch it closely. Grease may catch fire if it becomes too hot.
- Do not use water or flour on grease fires. Smother fire or flame or use dry chemical or foam-type extinguisher. Cover the fire with a pan lid or use baking soda.

! CAUTION

- Use dry potholders. Moist or damp potholders on hot surfaces may result in burns from steam. Do not let potholders touch hot cooking areas. Do not use towels or other bulky cloths.
- Do not heat unopened food containers - Build-up of pressure may cause container to burst and result in injury.
- Wear proper apparel - Loose-fitting or hanging garments should never be worn while using the appliance. Do not let clothing or other flammable materials contact hot surfaces.
- Do not touch surface burners or elements, areas near these burners or elements, interior surfaces of the oven, or the warmer drawer (if equipped). Surface burners and elements may be hot even though they appear cool. Areas near surface burners and elements may become hot enough to cause burns. During and after use, do not touch, or let clothing or other flammable materials touch these areas until they are cool. These areas may include the cooktop, surfaces facing the cooktop, oven vent areas, oven door, and oven window.
- Do not attempt to operate the appliance during a power failure. If the power fails, always turn off the appliance. If the appliance is not turned off and the power resumes, electric surface elements may resume operation when power is restored. Once the power resumes, reset the clock and the oven function.

6

IMPORTANT SAFETY INSTRUCTIONS

IMPORTANT INSTRUCTIONS FOR USING YOUR INDUCTION COOKTOP

WARNING

If an oven installed underneath is performing self-clean, then the surface cooking unit must be turned off.

CAUTION

Persons with a pacemaker or similar medical device should exercise caution using or standing near an induction unit while it is in operation, as the electromagnetic field may affect the working of the pacemaker or similar medical device. It would be advisable to consult your doctor or the pacemaker or similar medical device manufacturer about your particular situation.

Know which knob or key controls each surface heating area. Place cookware with food on the cooking area before turning it on. Turn the cooking area off before removing the cookware.

Cookware handles should be turned inward and not extend over adjacent surface elements. — To reduce the risk of burns, ignition of flammable materials, and spillage due to unintentional contact with the utensil, the handle of the cookware should be positioned so that it is turned inward, and does not extend over other cooking areas.

Glazed cooking utensils — Only certain types of cookware are suitable for cooktop service and must be magnetic to work properly on the induction zones. Check the manufacturer's recommendations for cooktop use to ensure that the cookware is compatible with induction cooking.

Improper cookware may break due to sudden changes in temperature. Check the cookware manufacturer's recommendations for cooktop use.

Use proper pan size - This appliance is equipped with one or more surface units of different sizes. Select cookware with flat bottoms that match the surface unit size. Using the proper cookware on the cooking area will improve efficiency.

Never leave surface elements unattended. Boil-overs may cause smoking and greasy spills that may ignite. A pan that has boiled dry could be damaged and may damage the cooktop.

When you are flaming foods under a ventilating hood, turn on the fan.

IMPORTANT INSTRUCTIONS FOR GLASS AND CERAMIC COOKTOPS

Do Not Clean or Operate a Broken Cooktop. If cooktop should break, cleaning solutions and spillovers may penetrate the broken cooktop and create a risk of electric shock. Contact a qualified technician immediately.

Clean cooktop glass with caution. If a wet sponge or cloth is used to wipe spills on a hot cooking area, be careful to avoid a steam burn. Some cleaners can produce harmful fumes if applied to a hot surface.

Avoid scratching the cooktop glass with sharp objects.

IMPORTANT INSTRUCTIONS FOR CLEANING YOUR APPLIANCE

CAUTION

Before manually cleaning any part of the appliance, be sure all controls are turned off and the appliance is cool. Cleaning a hot appliance can cause burns.

Clean the appliance regularly to keep all parts free of grease that could catch fire. Do not allow grease to accumulate. Greasy deposits in the fan could catch fire.

Always follow the manufacturer's recommended directions for use of kitchen cleaners and aerosols. Be aware that excess residue from cleaners and aerosols may ignite causing damage and injury.

Clean ventilating hoods frequently - Grease should not be allowed to accumulate on hood or filter. Follow the manufacturer's instructions for cleaning vent hoods.

IMPORTANT INSTRUCTIONS FOR SERVICE AND MAINTENANCE

Do not repair or replace any part of the appliance unless specifically recommended in the manuals. All other servicing should be done only by a qualified technician. This reduces the risk of personal injury and damage to the appliance.

Always contact your dealer, distributor, service agent, or manufacturer about problems or conditions you do not understand.

Ask your dealer to recommend a qualified technician and an authorized repair service. Know how to disconnect the power to the appliance at the circuit breaker or fuse box in case of an emergency.

Remove the oven door from any unused oven if it is to be stored or discarded.

Do not touch a hot oven light bulb with a damp cloth. Doing so could cause the bulb to break. Handle halogen lights (if equipped) with paper towels or soft gloves. Disconnect the appliance or shut off the power to the appliance before removing and replacing the bulb.

WARNING

California Residents: for cancer and reproductive harm information, visit www.P65Warnings.ca.gov

8

IMPORTANT SAFETY INSTRUCTIONS

Important: This appliance has been tested and found to comply with the limits for a class B digital device, pursuant to Part 18 of the FCC rules (United States) and ICES-001 (Canada). These limits are designed to provide reasonable protection against harmful interference in a residential installation. This unit uses and can radiate radio frequency energy and, if not installed and used in accordance with the instructions, may cause harmful interference to radio communications. However there is no guarantee that interference will not occur in a particular installation. If this unit does cause harmful interference to radio or television reception, which can be determined by turning the unit off and on, the user is encouraged to try to correct the interference by one or more of the following measures:

- Reorient or relocate the receiving antennae.
 - Increase distance between unit and receiver.
 - Connect the unit into an outlet or a circuit different from that to which the receiver is connected.
-

How does induction work?

Most cooking uses radiant heat that must pass through the cookware to get food hot. Induction is a process that induces heat with an energy reaction. When each cooking zone is turned on, power goes to a coil under the cooktop. The powered coil creates an electromagnetic field. The electromagnetic field reacts with compatible materials in cookware, creating heat in the cookware itself. The power level controls the heating level, delivering precise results.

Induction Benefits

Because heat starts in the cookware instead of the cooktop, induction offers several advantages.

Cleaner cooking: Because induction works by heating the cookware and not the cooktop, spills don't cook or stick to the surface.

Cooler Cooktop: An induction cooktop will be cooler when you remove cookware than a conventional cooktop would be. The only radiant heat produced in induction is from the cookware itself, so the kitchen stays cooler, too.

Fast Heating: Cookware will heat up faster than on a conventional electric cooktop. Pay close attention to avoid scorching food when starting to cook. You may need to use a lower setting for cooking food than you are used to.

Precise Control: The heat going into the cookware will change immediately when you change the setting of the cooking zone.

Even Heating: Cookware will typically heat more evenly on an induction cooktop, so you are less likely to have hot or cool spots in the cookware.

Energy Efficiency: Because induction creates heat directly in the pan, it uses less electricity than a conventional cooktop.

Before Using Your Cooktop

Before using your cooktop for the first time, apply a ceramic cooktop cleaning cream (available in most hardware, grocery, and department stores) to the ceramic surface. Clean and buff with a clean paper towel. Cooktop cleaning creams leave a protective finish on the glass that will make cleaning easier when the cooktop is soiled from cooking and help prevent scratches and abrasions.

CAUTION

Although induction cooking zones do not produce heat, **they can become hot from contact with hot cookware**. Burns may occur if a cooking zone or the surrounding area is touched before it has cooled to a safe temperature.

Sounds

The magnetic field over the induction cooking zone may cause cookware to vibrate, creating a buzzing or humming noise. These sounds are not unusual, especially at high settings.

Cookware that is not perfectly flat on the bottom may vibrate slightly against the cooktop.

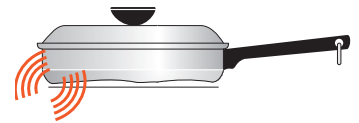

A loose handle may vibrate in its socket.

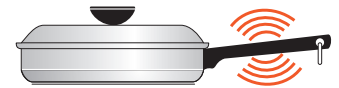

Multi-material cookware may allow small vibrations in its structure.



Figure 1: Induction sounds

Sounds are less likely to occur with heavier, higher quality cookware.

An induction cooktop may also produce faint clicking sounds from the electronic switches that maintain the desired cooking temperature. You may also hear a fan that cools the electronics inside the cooktop.

NOTE

Be sure to read detailed instructions for induction cooktop cleaning in the "Care and Cleaning" section and "Before You Call" checklist section of this Use and Care Manual.

10 BEFORE SETTING SURFACE CONTROLS

Using Proper Cookware

The size and type of cookware used will influence the heat setting needed for best cooking results. Be sure to follow the recommendations for using proper cookware as illustrated in Figure 2.

Check for flatness by rotating a ruler across the bottom of the cookware (see Figure 1). Cookware should have flat bottoms that make good contact with the entire surface of the heating element (see Figure 2).

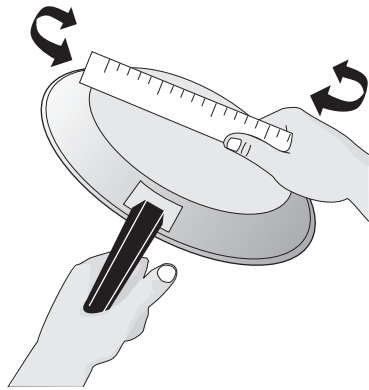

Figure 2: Testing cookware

Cookware Material Types

Cookware material is especially important when using an induction cooktop. The cookware must contain magnetic iron or steel to work on an induction cooktop. Common materials for induction cookware include the following:

- **Stainless Steel** - Slow heat conductor. Durable, easy to clean, and resists staining. Some types of stainless steel will not work on an induction cooktop. Use the magnet test (see “Figure 4: Magnet test”) to check stainless steel cookware.
- **Cast Iron** - A slow heat conductor that retains heat very well. Cooks evenly once cooking temperature is reached.
- **Porcelain-enamel on metal** - Heating characteristics will vary depending on the base material. Porcelain-enamel on a compatible metal will work on an induction cooktop. Use the magnet test to check porcelain-enamel cookware.

To see if a piece of cookware will work on your induction cooktop, try to stick a magnet to it. If the magnet clings firmly to the bottom of the cookware, the cookware will work on your induction cooktop.

Cookware sold as induction-ready will often have a symbol printed on the bottom by the manufacturer.

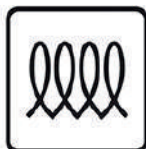

Figure 3: Induction symbol

The Magnet Test

To see if a piece of cookware will work on your induction cooktop, try to stick a magnet to it (see Figure 2).

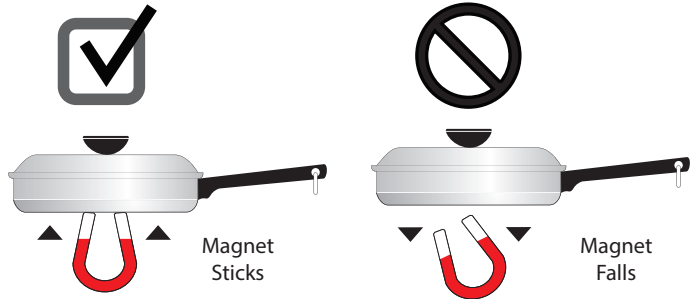

Figure 4: Magnet test

If the magnet clings firmly to the bottom of the cookware, it will work on your induction cooktop. If the magnet clings weakly or not at all, the cookware will not heat up on your induction cooktop.

CAUTION

Proper cookware on an operating induction cooking zone will heat up very quickly. If an empty piece of cookware is left on an operating induction cooking zone, the rapid change in temperature may warp or damage the cookware.

Do NOT place hot cookware on the control panel. The heat may damage the electronic parts.

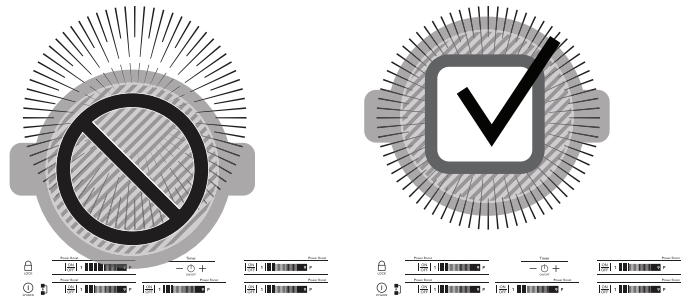

Figure 5: Keep hot cookware away from controls

BEFORE SETTING SURFACE CONTROLS

Pan Sensing

When the cooktop is on, the cooking zones automatically detect when cookware is placed on the zone. The control for that zone will light up, making it easy to know which section of the control to use for that cooking zone.

Figure 6 shows conditions that can prevent pan detection.

If you remove a pan from an active cooking zone, the zone will turn off after 30 seconds.

If the cooktop does not detect cookware in any zone for 30 seconds, the whole cooktop will turn off.

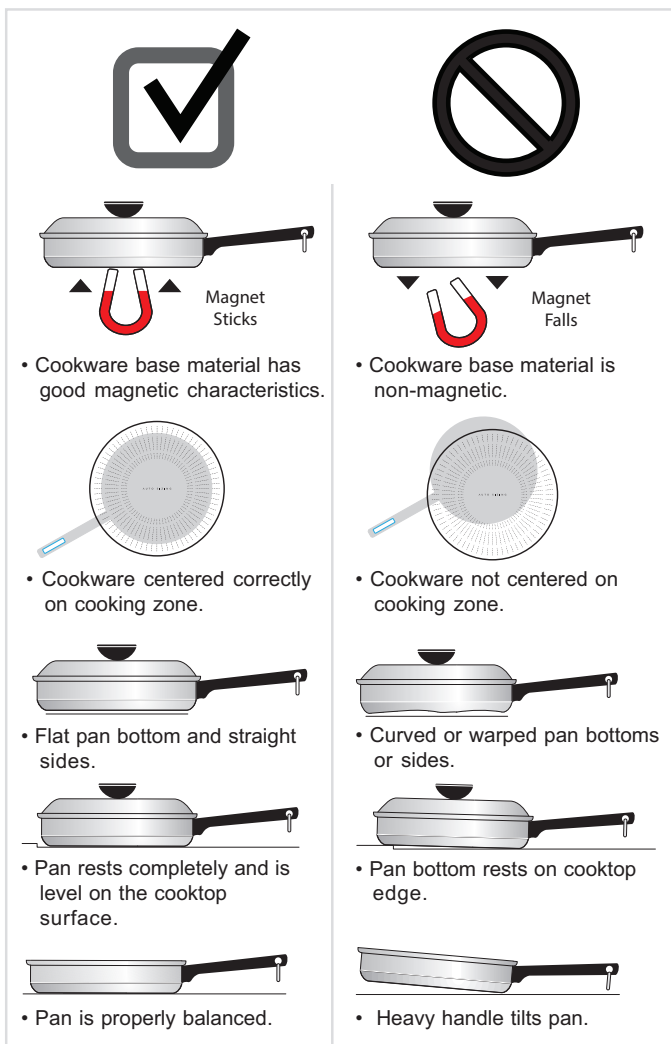

Figure 6: Pan sensing conditions

Minimum and Maximum Pan Size

The cooktop graphics are guides to minimum and maximum pan size for each cooking zone. For best results, use cookware that matches the size of the cooking zone.

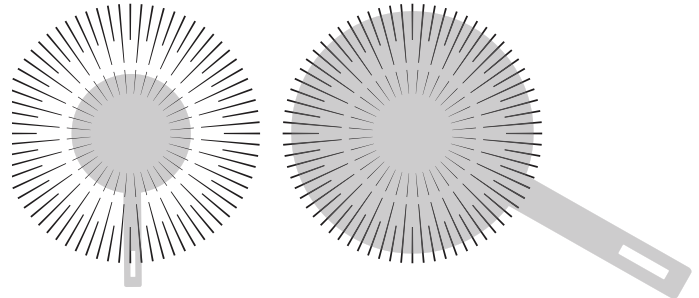

Figure 7: Min / max pan size

The inner ring on each cooking zone indicates the smallest pan size for the zone (Figure 8).

The outer ring on the cooktop graphic indicates the largest pan size for that zone (Figure 9).

Cookware that is too small for a zone may not activate the cookware detection sensor. Cookware that is much larger than a cooking zone will still cook, but may be slower and uneven. If your cookware is not a perfect match, it is best to use a zone a little smaller than the bottom of the cookware.

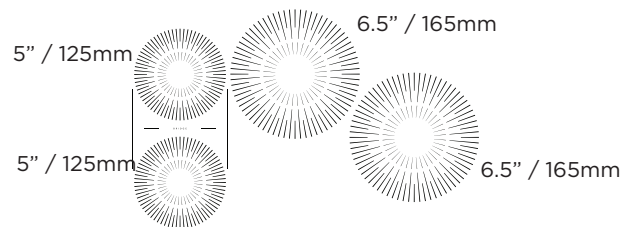

Figure 8: Cookzone sizes, 4 zones

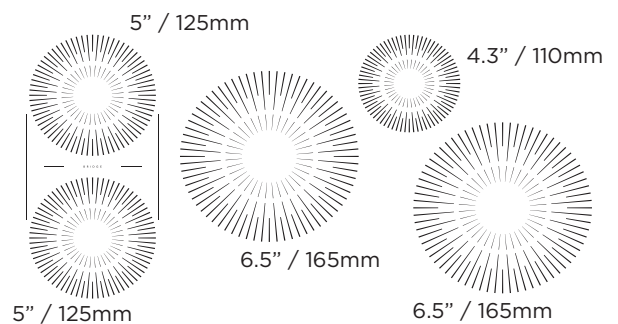

Figure 9: Cookzone sizes, 5 zones

12 BEFORE SETTING SURFACE CONTROLS

Hot Surface Indicator

When a cooking zone is turned off, it may remain hot due to contact with hot cookware. The Hot Surface Indicator (H) will come on and remain visible until the cooking zone cools to a safe temperature.



Figure 10: Hot Surface indicator

Key-Stuck Function

If a control key is held for more than 10 seconds, the cooktop will sound an alert of 5 tones. If the key is still held after the alert sound, the cooktop will switch off. This function will also activate if the a zone slider is continually held or adjusted for 10 seconds.

Key-Stuck could be activated by such things as leaving objects on the cook zone controls, some spills on the controls, or resting hands on the controls.

Lock or Unlock the Cooktop

The lock function deactivates most of the controls on the cooktop to keep cooking zones from being changed by accident.



LOCK
Figure 11: Lock key

To lock the controls while cooking:

1. Set the cooking zones to the desired settings.
2. Press the **Lock** key.

To unlock the controls, press the **Lock** key again.

Even with the controls locked, you can turn a cooking zone off by pressing its **On/Off** key.

To set the lock for child safety:

1. Press the **Power** key to turn the cooktop on.
2. Press the **Lock** key and hold it for 4 seconds. The lock icon will turn red.
3. Press the **Power** key to turn the cooktop off.

When the cooktop is locked for safety, two options are available to unlock it:

Complete unlock:

1. Press the **Power** key to turn the cooktop on.
2. Press the **Lock** key and hold it for 4 seconds. The lock will deactivate.
3. Press the **Power** key to turn the cooktop off.

Temporary unlock:

1. Press the **Power** key to turn the cooktop on.
2. Hold the **lock** key for 4 seconds.
3. Set the cooking zones.

When the cooking process is finished and the cooktop is turned off, the Lock function will be still active.

CAUTION

- Although induction cooking zones do not directly generate heat, **they can become hot from contact with hot cookware**. Burns may occur if a cooking zone or the surrounding area is touched before it has cooled to a safe temperature.
- **Do not** place flammable items such as plastic salt and pepper shakers, spoon holders, or plastic wrapping on top of the range when it is in use. Heat radiating from cookware could cause these items to melt or ignite. Potholders, towels, or wooden spoons could catch fire if placed too close to hot cookware.
- **Do not** use aluminum foil to line any part of the cooktop. Improper installation of these liners may result in risk of electric shock or fire. If these items melt on the cooktop, they will damage the cooktop.

Moving Cookware on a Smooth Cooktop

It's best to lift cookware before moving it on the ceramic glass cooktop. Cookware that has a rough or dirty bottom can mark and scratch the ceramic glass surface. Always start with clean cookware.

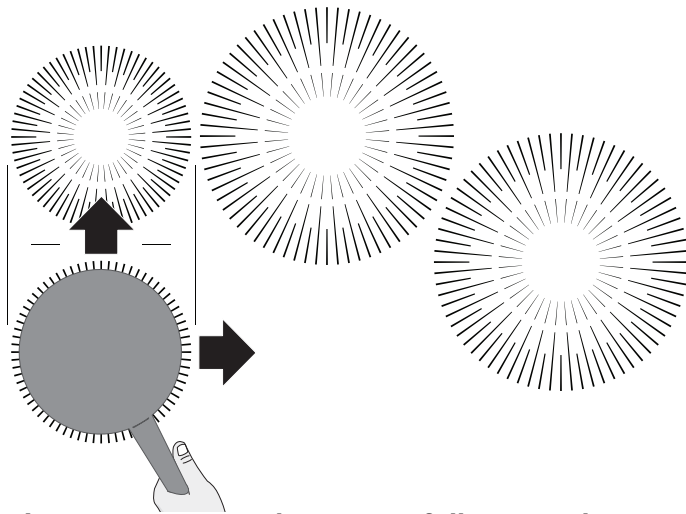

Figure 12: Move cookware carefully on cooktop

Power Management

Your induction cooktop has 2 or 3 generators and 4 or 5 cooking zones, depending on the model. A generator may power 1 or 2 cooking zones. If you use more than one cooking zone on high power at the same time and they are on the same generator, the cooktop may need to manage power to the two cooking zones.

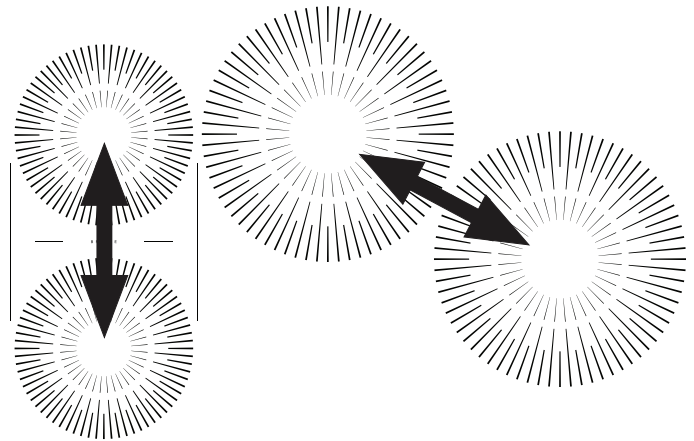

Figure 13: Power management, 4 cook zones

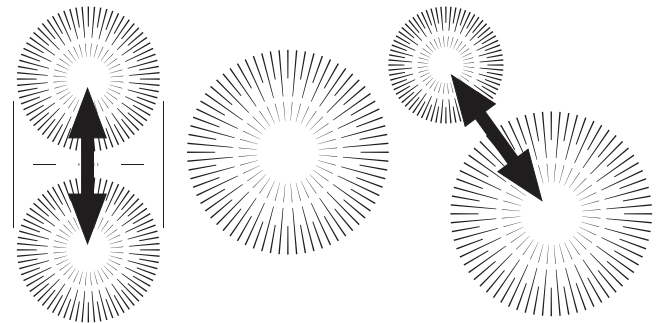

Figure 14: Power management, 5 cook zones

To get the best performance from your cooktop, start cooking on only one cooking zone. After the first piece of cookware has reached cooking temperature, then start cooking on the second cooking zone.

14 BEFORE SETTING SURFACE CONTROLS

Home Canning

Be sure to read and observe all the following points when home canning with your appliance. Check with the USDA (United States Department of Agriculture) Web site and be sure to read all the information they have available as well as follow their recommendations for home canning procedures.

- Use only a completely flat bottom canner with no ridges that radiate from the bottom center when home canning. Heat is spread more evenly when the bottom surface is flat. Use a straight-edge to check canner bottom.
- Make sure the diameter of the canner does not exceed 1 inch beyond the surface element markings or burner.
- It is recommended to use smaller diameter canners on electric coil and ceramic glass cooktops and to center canners on the burner grates.
- Start with hot tap water to bring water to boil more quickly.
- Use the highest heat setting when first bringing the water to a boil. Once boiling is achieved, reduce heat to lowest possible setting to maintain that boil.
- Use tested recipes and follow instructions carefully. Check with your local Cooperative Agricultural Extension Service or a manufacturer of glass jars for the latest canning information.
- It is best to can small amounts and light loads.

Do not leave water bath or pressure canners on high heat for an extended amount of time.

Cooktop Controls

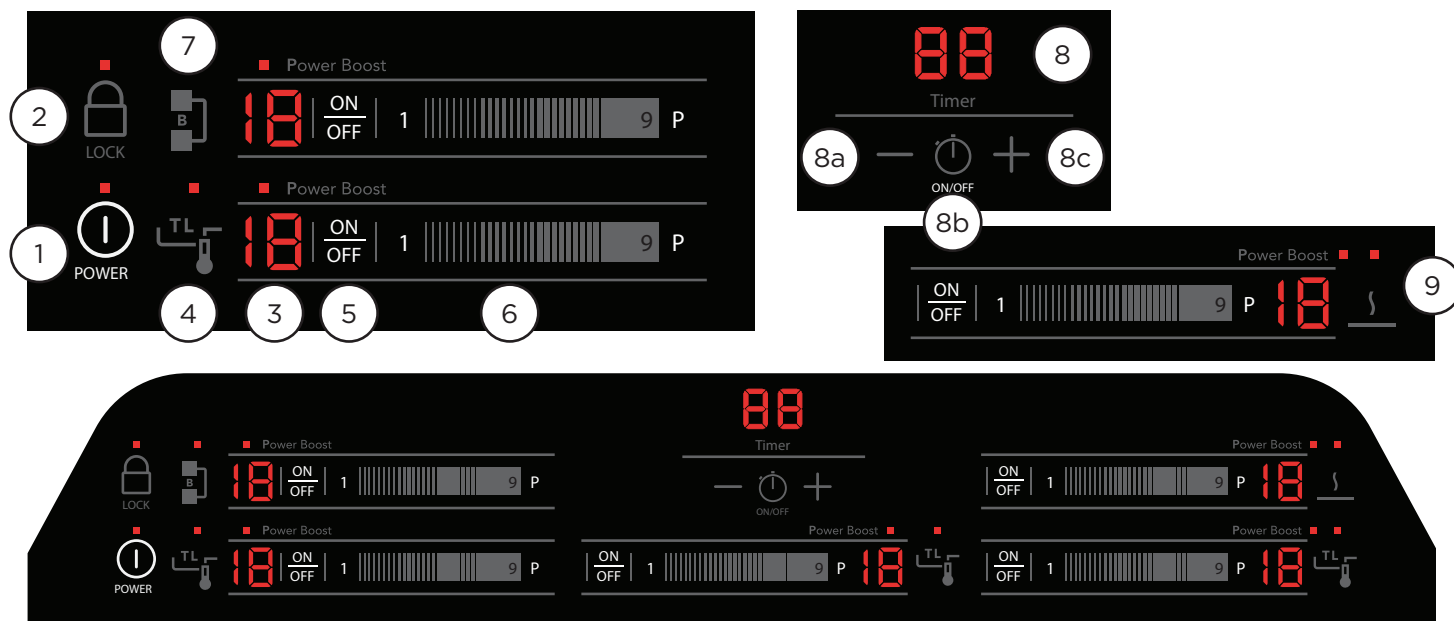

1. **Power:** Press to turn on or turn off the cooktop.
2. **Lock:** Lock the cooktop controls to prevent accidental activation of cooking zones.
3. **Cooking Zone Indicator:** The LEDs (4 or 5 depending on the model) indicate cook zones. The one corresponding to the control's cook zone turns red.
4. **TempLock:** Activates TempLock feature. When pressed, this feature uses a temperature sensor to monitor heat and adjust the power to maintain a consistent temperature during cooking. See page 17.
5. **Cooking Zone On/Off:** When cookware is on the cooking zone, press to turn the zone ON/OFF.
6. **Cooking Zone Power Level:** Slide a finger across or press a number to set the power level. Level 1 is low, level 9 is high, and P is the most powerful setting.
7. **Bridge:** The Bridge indicator is visible on Zone 1 if both left cooking zones detect cookware. The Bridge function makes the two left cooking zones work together to heat a long piece of cookware, like a griddle.
8. **Timer Indicator:** Shows the time currently left on the timer.
 - a. **Reduce Time (-):** Press to reduce the amount of time on the timer.
 - b. **Timer On/Off:** Press to turn the countdown timer on or off.
 - c. **Increase Time (+):** Press to increase the amount of time on the timer.
9. **Serve Warm:** Activates the Serve Warm feature. Serve Warm will set all of the cooking zones to a low power level to keep foods warm.

16 SETTING SURFACE CONTROLS

Setting induction cooking zones

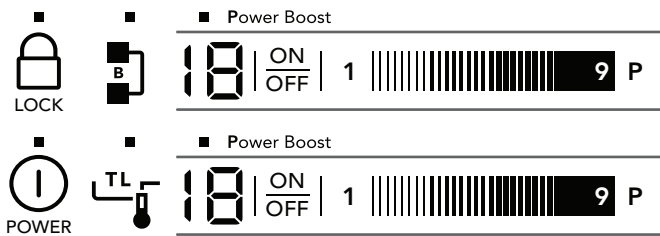

Figure 15: Induction cooking zone control

To operate an induction cooking zone:

1. Turn the cooktop on by pressing the **Power** key.
2. Place correctly sized cookware on the cooking zone. The controls for a zone won't activate unless cookware is detected.
3. Press the **On/Off** key for the active cooking zone. The indicator will turn red.
4. Set the cooking zone to the desired level (refer to Table 1) by pressing the number of the desired setting or **P**.
5. When cooking is complete, turn the induction cooking zone OFF by pressing its **On/Off** key or the **Power** key before removing the cookware. If all of the zones are off, the cooktop will automatically power off in 30 seconds.

At any time, you can change the setting for an active cook zone by pressing the number of the new setting.

➔ IMPORTANT

Do not leave empty cookware on an operating cooking zone. Cookware will heat very quickly and may be damaged or warped if left on the cooking zone empty.

ⓘ NOTE

A cooking zone will not become active without proper cookware in position. See "Key-Stuck Function" on page 12page 11.

If the cooktop does not detect cookware within 30 seconds, it will turn off.

Suggested induction cooking zone settings

Start most cooking operations on a higher setting and then turn to a lower setting to finish cooking.

The suggested settings found in Table 1 below are based on cooking with medium-weight stainless steel pans with lids. Settings may vary when using other types of pans.

Electrolux Induction Recommendations

	Temp Range	Power Level	Description
Keep Warm 145°-160°F	Low	1	Keep foods warm
	Medium Low	2-4	Continue cooking, poach, stew
Simmer 185 - 200°F	Medium	5-6	Maintain a slow boil, thicken sauces and gravies, steaming, cooking
	Medium High	7-8	Continue a rapid boil, fry, or deep fry
	High	9	Start most foods, maintain water at a boil, pan cooking, searing
	Power Boil	P	Start heating pans that contain large amounts of food or to bring pots of water to boil

Table 1: Suggested induction cooking zone settings

NOTE:

- The size and type of the cookware used and the amount and type of food being cooked will influence the setting needed for best cooking results.
- The Max setting is available after activating a cooking zone by pressing the **MAX** key. The cooktop will remain on Max for up to 10 minutes. After 10 minutes, the cooking zone will automatically change to the high (9) setting.
- The Hot Surface indicator (Hot) will show in the setting indicator when heat is detected in a cook zone that has been turned off. The indicator will remain on until the heated surface area has cooled sufficiently.

■ **TempLock**

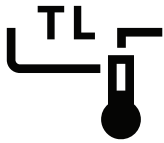

TempLock uses a temperature sensor to maintain a consistent temperature when cooking. When cool batter, liquid, or food is added to a hot pan, the pan cools down a little.

TempLock senses this change and will use extra power to maintain the desired temperature setting. The feature also lets you know when your cookware is preheated, so making pancakes or sautéing fresh food has better results.

The temperature of your cookware will depend on the level you select and the material of the cookware you use. Experiment a little to determine what works for you for cooking various dishes. Different pots and pans will hold at different temperatures, so you will need to learn how your cookware works with this feature.

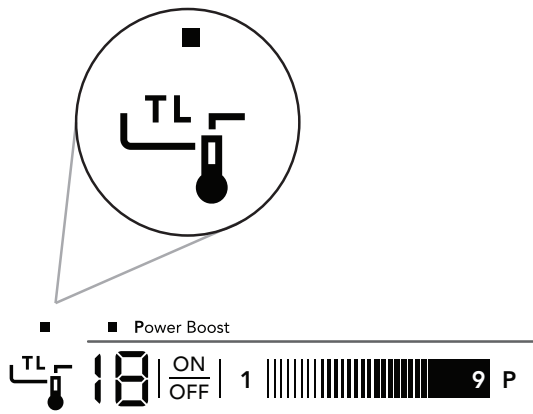

Figure 16: TempLock Indicator

TempLock is available for some cooking zones when they are active.

Press the **TempLock Indicator** to activate the TempLock function. The indicator turns red. Press a number key to select one of the 9 preset cooking levels.



Figure 17: TempLock Set

NOTE

To get an idea of how hot a piece of cookware will get at a particular setting, try the Magnet Test (page 10). The more strongly a magnet clings to the cookware, the hotter that cookware will get at any particular setting on the cooktop.

To get consistent results, use the same piece of cookware for particular cooking tasks.

When using small amounts of oil for frying or sautéing, add the oil after the pan is preheated.

Keep an eye on your cookware during preheat. Induction is powerful, and letting cookware get too hot while empty may warp or damage it.

Preheat Indicators

While the cooking zone is heating, the square above the TempLock Indicator will flash. When the temperature is reached, the square will stay lit steadily.

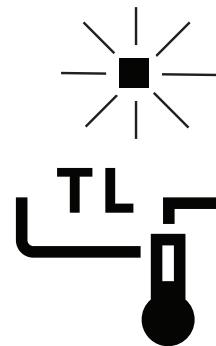

Figure 18: TempLock heating indicator

You can change the TempLock setting at any time by pressing another number key. The animated sequence of squares will start again until the new temperature is reached.

To deactivate the TempLock function, press the **TempLock Indicator**.

18

SETTING SURFACE CONTROLS

■ Bridge Function



The Bridge function allows you to use an extra-long piece of cookware such as a griddle on the left side of your cooktop.

If one of the left cook zones is active and cookware is detected in both of the left zones, the bridge function becomes available and the **Bridge Indicator** will light up.

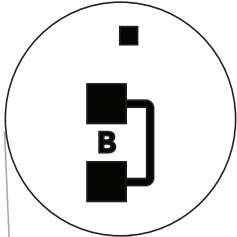

Figure 19: Bridge Indicator

Touch the **Bridge Indicator** to activate the bridge function. The **Bridge Indicator** will turn red. The cook zone indicator for the other bridge cook zone will also turn red, and the cook zone setting for both of the bridged zones will match. The setting controls for the front left zone will control both of the bridged zones as long as the bridge function is active.

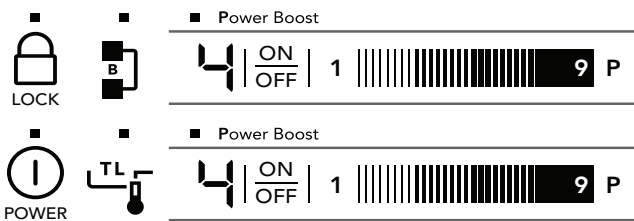

Figure 20: Active bridge function

At any time, you can change the setting for the bridged cook zones by pressing the number of the new setting on the active control.

To deactivate the bridge function, press the **Bridge Indicator** or deactivate one of the bridged cooking zones by pressing its **On/Off** key.

■ Serve Warm



Serve Warm allows you to keep cooked food warm for serving. When you activate Serve Warm, all active cooking zones will be set to a low setting.

To activate Serve Warm, press the **Serve Warm Indicator**. The indicator will turn red, and you will see the settings change on the active cooking zones.

To deactivate Serve Warm, press the **Serve Warm Indicator** again. All of the active cooking zones will turn off. You can also press the main **Power** key to turn the cooktop off.

! CAUTION

Serve Warm is not intended to cook food. Only use Serve Warm with food that is already cooked. Cover pots with lids to maintain proper serving temperature.

Setting the Timer (36" Model Only)

The cooktop has a timer function to remind you when food has been cooking for a specified amount of time.

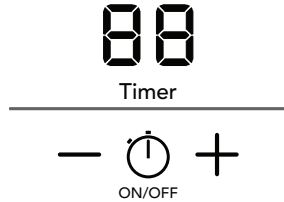

Figure 21: Cooktop Timer

To set the timer:

1. Press the Timer On/Off key (⌚) to activate the timer. The countdown timer and the + and - keys will become visible. The timer will show 00.
2. Press + and - to set the desired number of minutes. You can press and hold the + or - key to change the number of minutes faster.

The timer will start counting down a few seconds after you have finished setting it, when the specified time has elapsed, the timer will flash, and a tone will sound. Press the +, the -, or the Timer On/Off key (⌚) to stop the signal.

At any time, you can adjust the remaining time with the + and - keys.

At any time, you can deactivate the timer by pressing the Timer On/Off key (⌚).

Important: When the timer stops or the tone sounds, the cooking zones will continue to operate. The timer does not affect the cooking zone settings in any way.

20 CARE AND CLEANING

Remove spills and any heavy soiling as soon as possible. Regular cleaning will reduce the difficulty of major cleaning later.

CAUTION

Before cleaning any part of the appliance, be sure all controls are turned off and the appliance is cool.

If ammonia or appliance cleaners are used, they must be removed and the appliance must be thoroughly rinsed before operating. Follow manufacturer's instructions and provide adequate ventilation.

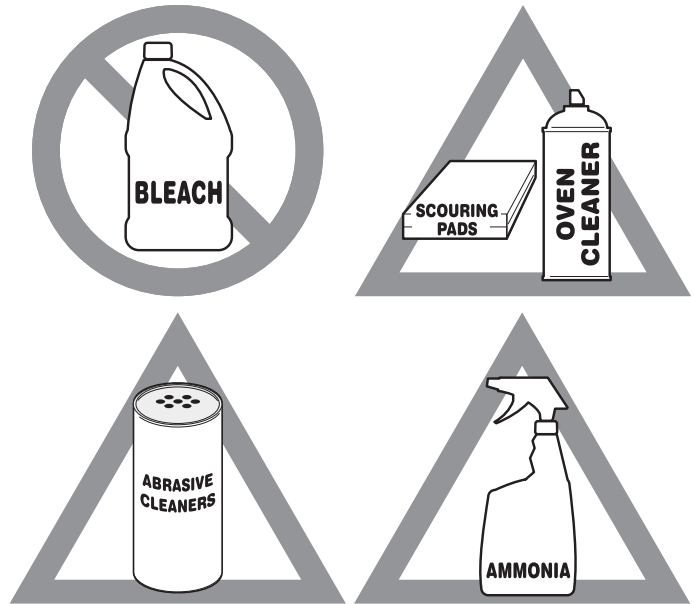

Figure 24: Use cleaners with caution

Surface or Area	Cleaning Recommendation
Aluminum and vinyl	Using a soft cloth, clean with mild dish detergent and water. Rinse with clean water, dry and polish with a soft, clean cloth.
Painted and plastic control knobs Painted body parts Painted decorative trims	Using a soft cloth, clean with mild dish detergent and water or a 50/50 solution of vinegar and water. Rinse with clean water, dry and polish with a soft, clean cloth. Glass cleaners may be used, but do not apply directly to surface; spray onto cloth and wipe.
Control panel	Using a soft cloth, clean with mild dish detergent and water or a 50/50 solution of vinegar and water. Do not spray liquids directly on the oven control and display area. Do not use large amounts of water on the control panel - excess water on the control area may cause damage to the appliance. Do not use other liquid cleaners, abrasive cleaners, scouring pads, or paper towels - they will damage the finish.
Control knobs	Using a soft cloth, clean with mild dish detergent and water or a 50/50 solution of vinegar and water. To remove control knobs: turn to the OFF position, grasp firmly, and pull off the shaft. To replace knobs after cleaning, line up the OFF markings and push the knobs into place.
Stainless Steel	Using a soft cloth, clean with mild dish detergent and water or a 50/50 solution of vinegar and water. Rinse with clean water, dry with a soft clean cloth. Do not use cleaners containing abrasives, chlorides, chlorine, or ammonia.
Smudge Proof™ Stainless Steel Black Stainless Steel	Using a soft cloth, clean with mild dish detergent and water or a 50/50 solution of vinegar and water. Rinse with clean water, dry with a soft clean cloth. Do not use appliance cleaner, stainless steel cleaner, or cleaner containing abrasives, chlorides, chlorine, or ammonia. These cleaners may damage the finish.

Surface or Area	Cleaning Recommendation
Porcelain-enameled broiler pan and insert Porcelain door liner Porcelain body parts	Rinse with clean water and a damp cloth. Scrub gently with a soapy, non-abrasive scouring pad to remove most spots. Rinse with a 50/50 solution of clean water and ammonia. If necessary, cover difficult spots with an ammonia-soaked paper towel for 30 to 40 minutes. Rinse and wipe dry with a clean cloth. Remove all cleaners or future heating could damage the porcelain. Do not allow food spills with a high sugar or acid content (milk, tomatoes, sauerkraut, fruit juices or pie filling) to remain on porcelain surfaces. These spills may cause a dull spot even after cleaning.
Manual clean oven interior	The oven interior is porcelain coated and safe to clean using oven cleaners. Always follow manufacturer's instructions for cleaners. After cleaning, remove any oven cleaner or the porcelain may become damaged during future heating. Do not spray oven cleaner on any electrical controls or switches. Do not spray or allow oven cleaner to build up on the oven temperature sensing probe. Do not spray cleaner on oven door trim, door gasket, plastic drawer glides, handles or any exterior surfaces of the appliance.
Self-cleaning oven interior	Before setting a self-clean cycle, clean soils from the oven frame, areas outside the oven door gasket, and the small area at the front center of the oven bottom. See "Self Clean" on page 23.
Oven door	Use mild dish detergent and water or a 50/50 solution of vinegar and water to clean the top, sides, and front of the oven door. Rinse well. Glass cleaner may be used on the outside glass of the door. Ceramic smoothtop cleaner or polish may be used on the interior door glass. Do not immerse the door in water. Do not spray or allow water or cleaners to enter the door vents. Do not use oven cleaners, cleaning powders, or any harsh abrasive cleaning materials on the outside of the oven door. Do not clean the oven door gasket. The oven door gasket is made of a woven material which is essential for a good seal. Do not rub, damage, or remove this gasket.
Ceramic cooktop	See "Cooktop Cleaning" on page 22.

22 CARE AND CLEANING

Cooktop Maintenance

Consistent and proper cleaning is essential to maintaining your ceramic glass cooktop.

Prior to using your cooktop for the first time, apply a ceramic cooktop cleaning cream (available in most hardware, grocery, and department stores) to the ceramic surface. Clean and buff with a clean paper towel. This will make cleaning easier when soiled from cooking. Cooktop cleaning creams leave a protective finish on the glass to help prevent scratches and abrasions.

Sliding pans on the cooktop can cause metal markings on the cooktop surface. These marks should be removed immediately after the cooktop has cooled using cooktop cleaning cream. Metal marks can become permanent if not removed prior to future use.

Cookware (cast iron, metal, ceramic, or glass) with rough bottoms can mark or scratch the cooktop surface.

Do not:

- Slide anything metal or glass across the cooktop.
- Use cookware with dirt or dirt build up on the bottom; always use clean cookware.
- Use your cooktop as a cutting board or work surface in the kitchen.
- Cook foods directly on the cooktop surface without a pan.
- Drop heavy or hard objects on the ceramic glass cooktop; they may cause it to crack.

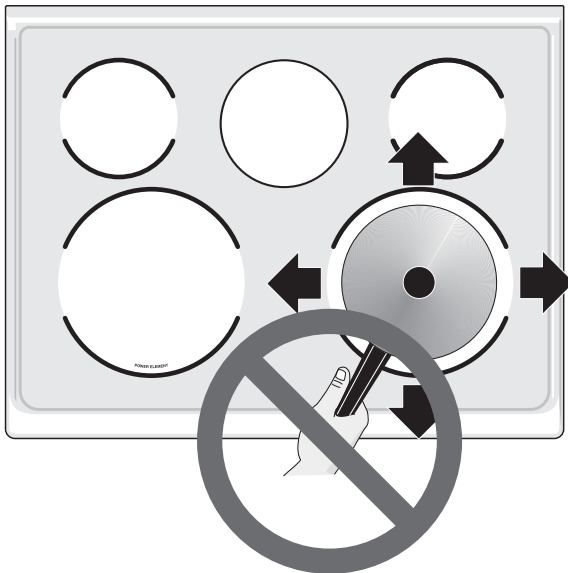

Figure 25: Cooktop care

Cooktop Cleaning

CAUTION

Before cleaning the cooktop, be sure the controls are turned to OFF and the cooktop is cool. The glass surface could be hot from contact with hot cookware, and burns may occur if the glass surface is touched before it has cooled sufficiently.

WARNING

Do not use a cooktop cleaner on a hot cooktop. The fumes can be hazardous to your health, and can chemically damage the ceramic-glass surface.

For light to moderate soil:

For light to moderate soil: Apply a few drops of cooktop cleaning cream directly to the cooktop. Use a clean paper towel to clean the entire cooktop surface. Make sure the cooktop is cleaned thoroughly, leaving no residue. Do not use the towel you use to clean the cooktop for any other purpose.

For heavy, burned on soil:

Apply a few drops of cooktop cleaning cream directly to the soiled area. Rub the soiled area using a non-abrasive cleaning tool, applying pressure as needed. Do not use the pad you use to clean the cooktop for any other purpose.

If soils remain, carefully scrape soils with a metal razor blade scraper held at a 30 degree angle to the surface. Finish cleaning with cooktop cleaning cream.

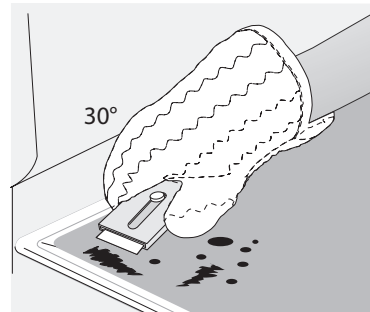

Figure 26: Cooktop cleaning

IMPORTANT

Damage to the ceramic glass cooktop may occur if you use an abrasive type cleaning pad. Only use cleaning products that have been specifically designed for ceramic glass cooktops.

Let us help you troubleshoot your concern! This section will help you with common issues. If you need us, visit our website, chat with an agent, or call us. We may be able to help you avoid a service visit. If you do need service, we can get that started for you!

1-800-374-4432 (United States)
Frigidaire.com

1-800-265-8352 (Canada)
Frigidaire.ca

Problem	Cause / Solution
Entire appliance does not operate	Appliance not connected. Make sure power cord is plugged properly into outlet. Check your fuse box or breaker box to make sure the circuit is active. Electrical power outage. Check house lights to be sure. Call your local electric company for service outage information.

Cooktop Problems	
Problem	Cause / Solution
Cooking zone does not heat or does not heat evenly.	Be sure the correct surface control knob is turned on for the element needed. Be sure to use the correct cookware material type for induction cooking. Use cookware specifically identified by the manufacturer to use for induction cooking. If you're not sure, use a magnet to test whether the cookware type will work. If a magnet sticks to the bottom of the cookware, the material type is correct for induction cooking. Be sure to read about pan-sensing in the Induction Cooking section and correct any pan-sensing issues in the checklist provided.
Control for the cooking zone does not work.	Incorrect cookware used. See "Using Proper Cookware" on page 10. Cookware is the wrong size or incorrectly positioned in the cooking zone. See "Pan Sensing" on page 11 More than one control was pressed at a time. Make sure that when you try to configure the control, nothing is touching another control.
Areas of discoloration with metallic sheen on cooktop surface.	Mineral deposits from water and food. Remove them using cooktop cleaning creme applied to the ceramic surface. Buff with a non-abrasive cloth or sponge.
Scratches or abrasions on cooktop surface.	Coarse particles such as salt or hardened soils between cooktop and utensils can cause scratches. Be sure the cooktop surface and bottoms of utensils are clean before use. Small scratches do not affect cooking and will become less visible with time. Cleaning materials not recommended for ceramic-glass cooktop have been used. Apply cooktop cleaning creme to the ceramic surface. Buff with a non-abrasive cloth or sponge. Cookware with a rough bottom was used. Use smooth, flat-bottomed cookware.
Metal marks on the cooktop.	Sliding or scraping of metal utensils on cooktop surface. Do not slide metal utensils on the cooktop surface. Apply cooktop cleaning creme to the ceramic surface. Buff with a non-abrasive cloth or sponge. For more information, see "Cooktop Maintenance" on page 22.
Brown streaks or specks on cooktop surface.	Boil overs are cooked onto the surface. When cooktop is cool, use a razor blade scraper to remove soil. For more information see "Cooktop Maintenance" on page 21.

24 WARRANTY

WARRANTY

Your appliance is covered by a one year limited warranty. For one year from your original date of purchase, Electrolux will pay all costs for repairing or replacing any parts of this appliance that prove to be defective in materials or workmanship when such appliance is installed, used and maintained in accordance with the provided instructions.

Exclusions

This warranty does not cover the following:

1. Products with original serial numbers that have been removed, altered or cannot be readily determined.
2. Product that has been transferred from its original owner to another party or removed outside the USA or Canada.
3. Rust on the interior or exterior of the unit.
4. Products purchased "as-is" are not covered by this warranty.
5. Food loss due to any refrigerator or freezer failures.
6. Products used in a commercial setting.
7. Service calls which do not involve malfunction or defects in materials or workmanship, or for appliances not in ordinary household use or used other than in accordance with the provided instructions.
8. Service calls to correct the installation of your appliance or to instruct you how to use your appliance.
9. Expenses for making the appliance accessible for servicing, such as removal of trim, cupboards, shelves, etc., which are not a part of the appliance when it is shipped from the factory.
10. Service calls to repair or replace appliance light bulbs, air filters, water filters, other consumables, or knobs, handles, or other cosmetic parts.
11. Surcharges including, but not limited to, any after hour, weekend, or holiday service calls, tolls, ferry trip charges, or mileage expense for service calls to remote areas, including the state of Alaska.
12. Damages to the finish of appliance or home incurred during installation, including but not limited to floors, cabinets, walls, etc.
13. Damages caused by: services performed by unauthorized service companies; use of parts other than genuine Electrolux parts or parts obtained from persons other than authorized service companies; or external causes such as abuse, misuse, inadequate power supply, accidents, fires, or acts of God.

DISCLAIMER OF IMPLIED WARRANTIES; LIMITATION OF REMEDIES

CUSTOMER'S SOLE AND EXCLUSIVE REMEDY UNDER THIS LIMITED WARRANTY SHALL BE PRODUCT REPAIR OR REPLACEMENT AS PROVIDED HEREIN. CLAIMS BASED ON IMPLIED WARRANTIES, INCLUDING WARRANTIES OF MERCHANTABILITY OR FITNESS FOR A PARTICULAR PURPOSE, ARE LIMITED TO ONE YEAR OR THE SHORTEST PERIOD ALLOWED BY LAW, BUT NOT LESS THAN ONE YEAR. ELECTROLUX SHALL NOT BE LIABLE FOR CONSEQUENTIAL OR INCIDENTAL DAMAGES SUCH AS PROPERTY DAMAGE AND INCIDENTAL EXPENSES RESULTING FROM ANY BREACH OF THIS WRITTEN LIMITED WARRANTY OR ANY IMPLIED WARRANTY. SOME STATES AND PROVINCES DO NOT ALLOW THE EXCLUSION OR LIMITATION OF INCIDENTAL OR CONSEQUENTIAL DAMAGES, OR LIMITATIONS ON THE DURATION OF IMPLIED WARRANTIES, SO THESE LIMITATIONS OR EXCLUSIONS MAY NOT APPLY TO YOU. THIS WRITTEN WARRANTY GIVES YOU SPECIFIC LEGAL RIGHTS. YOU MAY ALSO HAVE OTHER RIGHTS THAT VARY FROM STATE TO STATE.

If You Need Service

Keep your receipt, delivery slip, or some other appropriate payment record to establish the warranty period should service be required. If service is performed, it is in your best interest to obtain and keep all receipts. Service under this warranty must be obtained by contacting Electrolux at the addresses or phone numbers below.

This warranty only applies in the USA and Canada. In the USA, your appliance is warranted by Electrolux Major Appliances North America, a division of Electrolux Home Products, Inc. In Canada, your appliance is warranted by Electrolux Canada Corp. Electrolux authorizes no person to change or add to any obligations under this warranty. Obligations for service and parts under this warranty must be performed by Electrolux or an authorized service company. Product features or specifications as described or illustrated are subject to change without notice.

USA
1-800-374-4432
Frigidaire
10200 David Taylor Drive
Charlotte, NC 28262



Electrolux

Canada
1.800.265.8352
Electrolux Canada Corp.
5855 Terry Fox Way
Mississauga, Ontario, Canada
L5V 3E4

FRIGIDAIRE®

A01704804 A 10/2021

welcome *home*

Our home is your home. Visit us if you need help with any of these things:



owner support



accessories



service



registration

(See your registration card for more information.)

Frigidaire.com
1-800-374-4432

Frigidaire.ca
1-800-265-8352