

**DAIKIN**

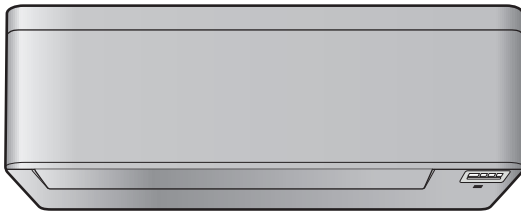

# User reference guide

## Daikin room air conditioner



**CTXA15A2V1BW  
FTXA20A2V1BW  
FTXA25A2V1BW  
FTXA35A2V1BW  
FTXA42A2V1BW  
FTXA50A2V1BW**

**CTXA15(A)(B)2V1BS  
FTXA20(A)(B)2V1BS  
FTXA25(A)(B)2V1BS  
FTXA35(A)(B)2V1BS  
FTXA42(A)(B)2V1BS  
FTXA50(A)(B)2V1BS**

**CTXA15(A)(B)2V1BT  
FTXA20(A)(B)2V1BT  
FTXA25(A)(B)2V1BT  
FTXA35(A)(B)2V1BT  
FTXA42(A)(B)2V1BT  
FTXA50(A)(B)2V1BT**

**CTXA15B2V1BB  
FTXA20B2V1BB  
FTXA25B2V1BB  
FTXA35B2V1BB  
FTXA42B2V1BB  
FTXA50B2V1BB**

## Table of Contents

<b>1</b>	<b>General safety precautions</b>	<b>2</b>
1.1	About the documentation	2
1.1.1	Meaning of warnings and symbols	2
1.2	For the user	3
<b>2</b>	<b>About the documentation</b>	<b>3</b>
2.1	About this document	3
2.2	User reference guide at a glance	3
<b>3</b>	<b>About the system</b>	<b>4</b>
3.1	Indoor unit	4
3.2	About the user interface	4
3.2.1	Components: User interface	4
3.2.2	Status: User interface LCD	5
3.2.3	To operate the user interface	5
<b>4</b>	<b>Before operation</b>	<b>5</b>
4.1	Overview: Before operation	5
4.2	To fix the user interface to the wall	6
4.3	To insert the batteries	6
4.4	About the clock	6
4.4.1	To set the clock	6
4.5	Brightness of the indoor unit display	6
4.5.1	To set the brightness of the indoor unit display	6
4.6	To turn on the power supply	7
4.7	To change indoor unit position setting	7
<b>5</b>	<b>Operation</b>	<b>7</b>
5.1	Operation range	7
5.2	When to use which feature	7
5.3	Operation mode and temperature setpoint	8
5.3.1	To start/stop operation mode and to set the temperature	8
5.4	Airflow rate	8
5.4.1	To adjust the airflow rate	8
5.5	Airflow direction	8
5.5.1	To adjust vertical airflow direction	9
5.5.2	To adjust horizontal airflow direction	9
5.5.3	To use 3-D airflow direction	9
5.6	Comfort airflow and Intelligent eye operation	9
5.6.1	Comfort airflow operation	9
5.6.2	Intelligent eye operation	10
5.6.3	To start/stop Comfort and Intelligent eye operation	10
5.7	Powerful operation	10
5.7.1	To start/stop Powerful operation	10
5.8	Econo and Outdoor unit quiet operation	10
5.8.1	Econo operation	10
5.8.2	Outdoor unit quiet operation	10
5.8.3	To start/stop Econo and Outdoor unit quiet operation	11
5.9	Streamer (air cleaning) operation	11
5.9.1	To start/stop Streamer (air cleaning) operation	11
5.10	OFF/ON timer operation	11
5.10.1	To start/stop OFF timer operation	11
5.10.2	To start/stop ON timer operation	11
5.10.3	To combine OFF timer and ON timer	12
5.11	Weekly timer operation	12
5.11.1	To set Weekly timer operation	12
5.11.2	To copy reservations	13
5.11.3	To confirm reservations	13
5.11.4	To deactivate and reactivate Weekly timer operation	13
5.11.5	To delete reservations	13
5.12	Wireless LAN connection	13
5.12.1	Precautions when using the wireless adapter	14
5.12.2	To install the Daikin Online Controller application	14
5.12.3	To set the wireless connection	14





<b>6</b>	<b>Energy saving and optimum operation</b>	<b>15</b>
<b>7</b>	<b>Maintenance and service</b>	<b>16</b>
7.1	Overview: Maintenance and service	16
7.2	To clean the indoor unit and user interface	16
7.3	To clean the front panel	16
7.4	To open the front panel	17
7.5	About the air filters	17
7.6	To clean the air filters	17
7.7	To clean the titanium apatite deodorizing filter and the silver particle filter (Ag-ion filter)	17
7.8	To replace the titanium apatite deodorizing filter and the silver particle filter (Ag-ion filter)	18
7.9	To close the front panel	18
7.10	To remove the front panel	18
7.11	To take following items into account before a long idle period	18
<b>8</b>	<b>Troubleshooting</b>	<b>18</b>
8.1	Symptoms that are NOT system malfunctions	20
8.1.1	Symptom: A sound like water flowing is heard	20
8.1.2	Symptom: A blowing sound is heard	20
8.1.3	Symptom: A ticking sound is heard	20
8.1.4	Symptom: A whistling sound is heard	20
8.1.5	Symptom: A clicking sound during operation or idle time is heard	20
8.1.6	Symptom: A clapping sound is heard	20
8.1.7	Symptom: White mist comes out of a unit (Indoor unit, outdoor unit)	20
8.1.8	Symptom: The units can give off odours	20
8.1.9	Symptom: The outdoor fan rotates while the air conditioner is not in operation	20
8.2	Solving problems based on error codes	20
8.3	Troubleshooting for wireless connection adapter	21
<b>9</b>	<b>Disposal</b>	<b>21</b>
<b>10</b>	<b>Glossary</b>	<b>21</b>





## 1 General safety precautions



### 1.1 About the documentation

- The original documentation is written in English. All other languages are translations.
- The precautions described in this document cover very important topics, follow them carefully.
- The installation of the system, and all activities described in the installation manual and in the installer reference guide MUST be performed by an authorised installer.

#### 1.1.1 Meaning of warnings and symbols

	<b>DANGER</b> Indicates a situation that results in death or serious injury.
	<b>DANGER: RISK OF ELECTROCUTION</b> Indicates a situation that could result in electrocution.
	<b>DANGER: RISK OF BURNING</b> Indicates a situation that could result in burning because of extreme hot or cold temperatures.
	<b>DANGER: RISK OF EXPLOSION</b> Indicates a situation that could result in explosion.

	<b>WARNING</b> Indicates a situation that could result in death or serious injury.
	<b>WARNING: FLAMMABLE MATERIAL</b>
	<b>CAUTION</b> Indicates a situation that could result in minor or moderate injury.
	<b>NOTICE</b> Indicates a situation that could result in equipment or property damage.
	<b>INFORMATION</b> Indicates useful tips or additional information.

Symbol	Explanation
	Before installation, read the installation and operation manual, and the wiring instruction sheet.
	Before performing maintenance and service tasks, read the service manual.
	For more information, see the installer and user reference guide.

### 1.2 For the user

- If you are NOT sure how to operate the unit, contact your installer.
- This appliance can be used by children aged from 8 years and above and persons with reduced physical, sensory or mental capabilities or lack of experience and knowledge if they have been given supervision or instruction concerning use of the appliance in a safe way and understand the hazards involved. Children shall NOT play with the appliance. Cleaning and user maintenance shall NOT be made by children without supervision.

	<b>WARNING</b> To prevent electric shocks or fire: <ul style="list-style-type: none"> <li>▪ Do NOT rinse the unit.</li> <li>▪ Do NOT operate the unit with wet hands.</li> <li>▪ Do NOT place any objects containing water on the unit.</li> </ul>
---	---

	<b>NOTICE</b> <ul style="list-style-type: none"> <li>▪ Do NOT place any objects or equipment on top of the unit.</li> <li>▪ Do NOT sit, climb or stand on the unit.</li> </ul>
---	--

- Units are marked with the following symbol:



This means that electrical and electronic products may NOT be mixed with unsorted household waste. Do NOT try to dismantle the system yourself: the dismantling of the system, treatment of the refrigerant, of oil and of other parts must be done by an authorized installer and must comply with applicable legislation. Units must be treated at a specialized treatment facility for reuse, recycling and recovery. By ensuring this product is disposed of correctly, you will help to prevent potential negative consequences for the environment and human health. For more information, contact your installer or local authority.

- Batteries are marked with the following symbol:



This means that the batteries may NOT be mixed with unsorted household waste. If a chemical symbol is printed beneath the symbol, this chemical symbol means that the battery contains a heavy metal above a certain concentration. Possible chemical symbols are: Pb: lead (>0.004%). Waste batteries must be treated at a specialized treatment facility for reuse. By ensuring waste batteries are disposed of correctly, you will help to prevent potential negative consequences for the environment and human health.

## 2 About the documentation

### 2.1 About this document

Thank you for purchasing this product. Please:

- Keep the documentation for future reference.

#### Target audience

End users



#### INFORMATION

This appliance is intended to be used by expert or trained users in shops, in light industry, and on farms, or for commercial and household use by lay persons.

#### Documentation set

This document is part of a documentation set. The complete set consists of:

- **General safety precautions:**
  - Safety instructions that you must read before operating your system
  - Format: Paper (in the box of the indoor unit)
- **Operation manual:**
  - Quick guide for basic usage
  - Format: Paper (in the box of the indoor unit)
- **User reference guide:**
  - Detailed step-by-step instructions and background information for basic and advanced usage
  - Format: Digital files on <http://www.daikineurope.com/support-and-manuals/product-information/>

Latest revisions of the supplied documentation may be available on the regional Daikin website or via your installer.

The original documentation is written in English. All other languages are translations.

### 2.2 User reference guide at a glance

Chapter	Description
General safety precautions	Safety instructions that you MUST read before operation
About the documentation	What documentation exists for the user
About the system	<ul style="list-style-type: none"> <li>▪ Operation range</li> <li>▪ Description of indoor unit and user interface</li> </ul>
Before operation	What to do before starting operation
Operation	How and when to use certain features

### 3 About the system

Chapter	Description
Energy saving and optimum operation	How to save energy
Maintenance and service	How to maintain and service the unit
Troubleshooting	What to do in case of problems
Disposal	How to dispose of the system
Glossary	Definition of terms

### 3 About the system



#### WARNING: FLAMMABLE MATERIAL

The refrigerant inside this unit is mildly flammable.



#### CAUTION

The indoor unit contains radio equipment, minimum separation distance between the radiating part of the equipment and the user is 10 cm.

#### 3.1 Indoor unit



#### CAUTION

Do NOT insert fingers, rods or other objects into the air inlet or outlet. When the fan is rotating at high speed, it will cause injury.



#### INFORMATION

The sound pressure level is less than 70 dBA.



#### WARNING

- Do not modify, disassemble, remove, reinstall or repair the unit yourself as incorrect dismantling or installation may cause an electric shock or fire. Contact your dealer.
- In case of accidental refrigerant leaks, make sure there are no naked flames. The refrigerant itself is entirely safe, non-toxic and mildly flammable, but it will generate toxic gas when it accidentally leaks into a room where combustible air from fan heaters, gas cookers, etc. is present. Always have qualified service personnel confirm that the point of leakage has been repaired or corrected before resuming operation.

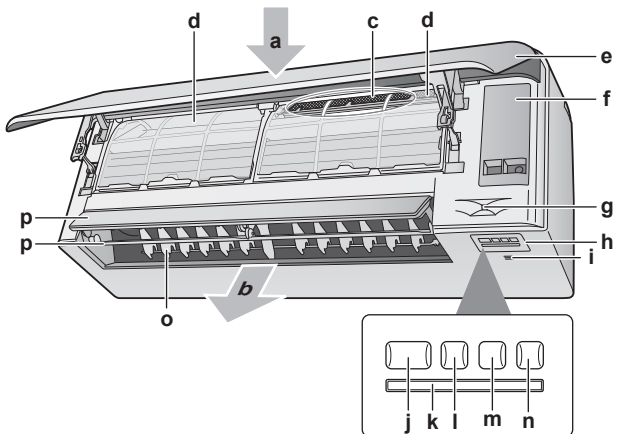

- a Air inlet
- b Air outlet
- c Titanium apatite deodorizing filter and silver particle filter (Ag-ion filter)
- d Air filter
- e Front panel
- f Service cover
- g Intelligent eye sensor
- h Display
- i Room temperature and humidity sensor
- j ON/OFF button and operation lamp (green)
- k Signal receiver
- l Timer lamp (orange)
- m Intelligent eye lamp (green)
- n Wireless adapter ON/OFF button
- o Louvers (vertical blades)
- p Flaps (horizontal blades)

- j ON/OFF button and operation lamp (green)
- k Signal receiver
- l Timer lamp (orange)
- m Intelligent eye lamp (green)
- n Wireless adapter ON/OFF button
- o Louvers (vertical blades)
- p Flaps (horizontal blades)

**Note:** Position of titanium apatite deodorizing filter and silver particle filter is interchangeable.

#### ON/OFF button

If the user interface is missing, you can use the ON/OFF button on the indoor unit to start/stop operation. When operation is started using this button, the following settings are used:

- Operation mode = Automatic
- Temperature setting = 25°C
- Airflow rate = Automatic

#### 3.2 About the user interface

- Direct sunlight.** Do NOT expose the user interface to direct sunlight.
- Dust.** Dust on the signal transmitter or receiver will reduce sensitivity. Wipe off dust with a soft cloth.
- Fluorescent lights.** Signal communication might be disabled if fluorescent lamps are in the room. In that case, contact your installer.
- Other appliances.** If the user interface signals operate other appliances, move the other appliances, or contact your installer.
- Curtains.** Make sure that the signal between the unit and the user interface is NOT blocked by curtains or other objects.



#### NOTICE

- Do NOT drop the user interface.
- Do NOT let the user interface get wet.

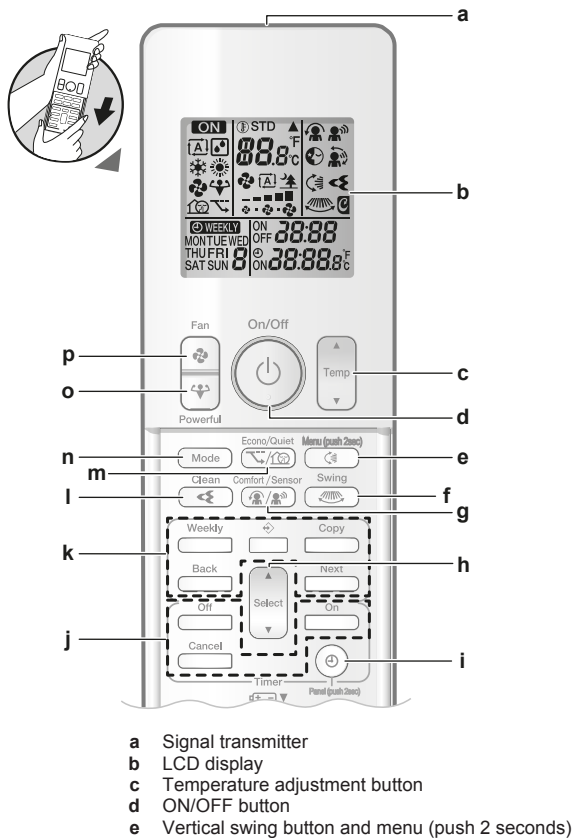

#### 3.2.1 Components: User interface



- a Signal transmitter
- b LCD display
- c Temperature adjustment button
- d ON/OFF button
- e Vertical swing button and menu (push 2 seconds)
- j ON/OFF button and operation lamp (green)
- k Signal receiver
- l Timer lamp (orange)
- m Intelligent eye lamp (green)
- n Wireless adapter ON/OFF button
- o Louvers (vertical blades)
- p Flaps (horizontal blades)

- f Horizontal swing button
- g Comfort airflow and Intelligent eye operation button
- h Select button
- i Clock button and open panel (push 2 seconds)
- j Buttons for ON/OFF timer operation
- k Buttons for Weekly timer operation
- l Streamer
- m Econo and Outdoor unit quiet operation button
- n Mode button
- o Powerful button
- p Fan button

## **i** INFORMATION

Use  (hold for 2 seconds) to open the front panel when you clean the air filters. See "7.4 To open the front panel"  17].

### 3.2.2 Status: User interface LCD

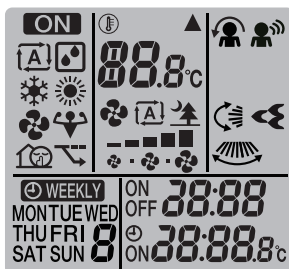

Icon	Description
	Operation is active
	Operation mode = Automatic
	Operation mode = Drying
	Operation mode = Heating
	Operation mode = Cooling
	Operation mode = Fan only
	Powerful operation is active
	Econo operation is active
	Outdoor unit quiet operation is active
	The indoor unit receives a signal from the user interface
	Current temperature setting
	Airflow rate = Automatic
	Airflow rate = Indoor unit quiet
	Airflow rate = High
	Airflow rate = Medium high
	Airflow rate = Medium
	Airflow rate = Medium low
	Airflow rate = Low

Icon	Description
	Comfort operation is active
	Intelligent eye is active
	Automatic vertical swing is active
	Automatic horizontal swing is active
	Streamer is active
	ON timer is active
	OFF timer is active
	Weekly timer is active
	Day of the week
	Current time

### 3.2.3 To operate the user interface

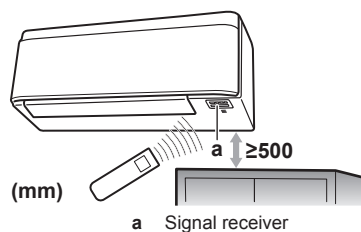

**Note:** Make sure that there are no obstacles within 500 mm under the signal receiver. They may influence reception performance of the user interface.

- 1 Aim the signal transmitter at the signal receiver on the indoor unit (maximum distance for communication is 7 m).

**Result:** When the indoor unit receives a signal from the user interface, you will hear a sound:

Sound	Description
Beep-beep	Operation starts.
Beep	Setting changes.
Long beep	Operation stops.

## 4 Before operation

### 4.1 Overview: Before operation

This chapter describes what you have to do before operating the unit.

#### Typical workflow

Before operation usually consist of the following stages:

- Fixing the user interface to the wall.
- Inserting the batteries in the user interface.
- Setting the brightness of the user interface display.
- Setting the clock.
- Setting the indoor unit position.
- Turning on the power supply.

## 4 Before operation

### 4.2 To fix the user interface to the wall

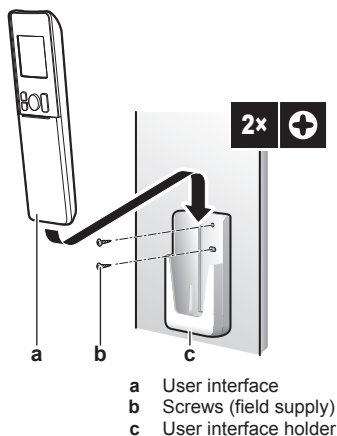

- 1 Choose a place where the signals reach the unit.
- 2 Attach the holder with screws to the wall or a similar location.
- 3 Hang the user interface on the user interface holder.

### 4.3 To insert the batteries

The batteries will last for about 1 year.

- 1 Remove the front cover.
- 2 Insert both batteries at once.
- 3 Put back the front cover.

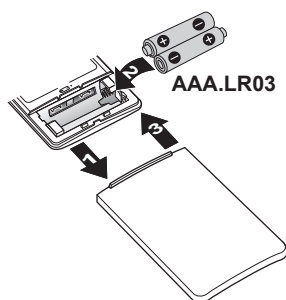

#### INFORMATION

- Low energy of battery is indicated by flashing of LCD display.
- ALWAYS replace both batteries at once.

### 4.4 About the clock

If the indoor unit's internal clock is NOT set to the correct time, the ON timer, OFF timer and weekly timer will NOT operate correctly. The clock must be set again:

- After a circuit breaker has turned the unit OFF.
- After a power failure.
- After replacing batteries in the user interface.

#### 4.4.1 To set the clock

**Note:** If the time is NOT set, MON, ☉, and 0:00 blink.

- 1 Press ☉.

**Result:** MON and ☉ blink

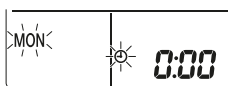

- 2 Press or to set the current day of the week.

**Note:** Holding down or increases or decreases the time setting rapidly.

Display	Day of the week
MON	Monday
TUE	Tuesday
WED	Wednesday
THU	Thursday
FRI	Friday
SAT	Saturday
SUN	Sunday

- 3 Press ☉.

**Result:** ☉ blinks.

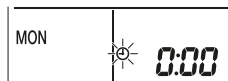

- 4 Press or to set the correct time.

- 5 Press ☉.

**Result:** Setting is complete. ☉ blinks.

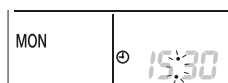

### 4.5 Brightness of the indoor unit display

Adjust the brightness of the indoor unit display as desired, or turn OFF the display.

#### 4.5.1 To set the brightness of the indoor unit display

- 1 Press for at least 2 seconds.

**Result:** The menu appears on the display. is blinking.

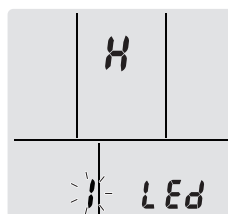

- 2 Press .

- 3 Press or to change the setting as follows:



...is blinking	Brightness is...
H	High
L	Low
of	Off

- 4 To confirm the selected setting, press .

**Result:** The brightness setting is changed.

**Note:** The display automatically returns to the default screen after 60 seconds. To return to the default screen sooner, press .

## 4.6 To turn on the power supply

- 1 Turn the circuit breaker on.

**Result:** The flap of the indoor unit will open and close to set the reference position.

## 4.7 To change indoor unit position setting

Set the indoor unit position to avoid direct airflow to walls.

- 1 Press for at least 2 seconds.

**Result:** The menu **1** appears on the display.

- 2 Press or to change the menu to **3**.

**Result:** The menu **3** appears on the display. **3** blinks.



- 3 Press to select the menu.

**Result:** **1** blinks.

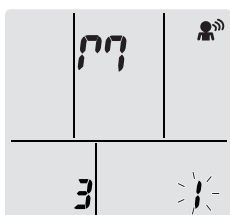

- 4 Press or to change the setting as follows:



If the unit is...	Symbol	Blinks	Result
In the middle of the wall (factory default setting)	<b>1</b>	<b>1</b>	
≤500 mm from the wall on right	<b>2</b>	<b>2</b>	
≤500 mm from the wall on left	<b>3</b>	<b>3</b>	

**Result:** The airflow range will be adjusted to avoid direct contact with the wall.

# 5 Operation

## 5.1 Operation range

Use the system in the following temperature and humidity ranges for safe and effective operation.

Operation mode	Operation range
Cooling <sup>(a),(b)</sup>	<ul style="list-style-type: none"> <li>Outdoor temperature: -10~46°C</li> <li>Indoor temperature: 18~32°C</li> <li>Indoor humidity: ≤80%</li> </ul>
Heating <sup>(a)</sup>	<ul style="list-style-type: none"> <li>Outdoor temperature: -15~24°C</li> <li>Indoor temperature: 10~30°C</li> </ul>
Drying <sup>(a)</sup>	<ul style="list-style-type: none"> <li>Outdoor temperature: -10~46°C</li> <li>Indoor temperature: 18~32°C</li> <li>Indoor humidity: ≤80%</li> </ul>

If operated outside the operation range:

- (a) A safety device might stop the operation of the system.
- (b) Condensation might occur on the indoor unit and drip.

## 5.2 When to use which feature

You can use the following table to determine which features to use:

Feature	Tasks
<b>Basic features</b>	
Operation modes and temperature	To start/stop the system and to set the temperature: <ul style="list-style-type: none"> <li>In Heating and Cooling mode, heat up or cool down a room.</li> <li>In Fan only mode, blow air in a room without heating or cooling.</li> <li>In Drying mode, decrease the humidity in a room.</li> <li>In Automatic mode, an appropriate temperature and operation mode is automatically selected.</li> </ul>
+  Airflow direction	To adjust the airflow direction (swing or fixed position).
Airflow rate	To adjust the amount of air blown into the room. To run more quietly.
<b>Advanced features</b>	
Streamer	To remove airborne allergens such as mold, pollen, adjuvant substances, viruses, bacteria...
Econo	To use the system when you are also using other power-consuming appliances. To save energy.
Outdoor unit quiet	To decrease the noise level of the outdoor unit. Example: At night.
Comfort	To automatically adjust the airflow direction to cool down or heat up the room more effectively.
Intelligent eye	To prevent the air from coming in direct contact with people. To save energy when nobody is in the room.
Powerful	To cool down or heat up the room quickly.
ON timer +  OFF timer	To automatically turn ON or OFF the system.
Weekly timer	To automatically turn ON or OFF the system on a weekly basis.
<b>Additional features</b>	

## 5 Operation





Feature	Tasks
Wireless LAN connection	To operate the unit using smart appliances.

### 5.3 Operation mode and temperature setpoint

**When.** Adjust the system operation mode and set the temperature when you want to:

- Heat up or cool down a room
- Blow air in a room without heating or cooling
- Decrease the humidity in a room

**What.** The system operates differently, depending on the user selection.

Setting	Description
 Automatic	The system cools down or heats up a room to the temperature setpoint. It automatically switches between cooling and heating if necessary.
 Drying	The system decreases the humidity in a room without changing the temperature.
 Heating	The system heats up a room to the temperature setpoint.
 Cooling	The system cools down a room to the temperature setpoint.
 Fan	The system only controls the airflow (airflow rate and airflow direction). The system does NOT control the temperature.

**Additional info:**

- **Outside temperature.** The system's cooling or heating effect decreases when the outside temperature is too high or too low.
- **Defrost operation.** During heating operation, frost might occur on the outdoor unit and decrease the heating capacity. In that case, the system automatically switches to defrosting operation to remove the frost. During defrosting operation, hot air is NOT blown from the indoor unit.
- **Humidity sensor.** Control the humidity by decreasing the humidity during cooling process.

#### 5.3.1 To start/stop operation mode and to set the temperature





 **ON**: Unit is operating.

 **A**: Operation mode = Automatic

 **D**: Operation mode = Drying

 **C**: Operation mode = Cooling

 **H**: Operation mode = Heating

 **F**: Operation mode = Fan only

 **88.8**: Shows the set temperature.



- 1 Press  one or more times to select the operation mode.

**Result:** The mode will be set as follows:



- 2 Press  to **start** operation.

**Result:**  and the selected mode are displayed on the LCD.

- 3 Press  or  one or more times to lower or raise the temperature.

Cooling operation	Heating operation	Automatic operation	Drying or Fan only operation
18~32°C	10~30°C	18~30°C	—



**Note:** When using **drying** or **fan only** mode, you cannot adjust the temperature.

- 4 Press  to **stop** operation.

**Result:**  disappears from the LCD. The operation lamp goes off.

### 5.4 Airflow rate

- 1 Press  to choose:

	5 airflow rate levels, from "—" to "■"
	Automatic operation
	Indoor unit quiet operation. When the airflow is set to "■", the noise from the unit will be reduced.

#### INFORMATION

- If the unit reach the temperature setpoint in cooling, heating or automatic mode. Fan will stop operating.
- When using drying operation mode, you CANNOT adjust the airflow rate setting.

#### 5.4.1 To adjust the airflow rate





- 1 Press  to change the airflow setting as follows:



### 5.5 Airflow direction

**When.** Adjust the airflow direction as desired.

**What.** The system directs the airflow differently, depending on the user selection (swinging or fixed position). It does so by moving horizontal blades (flaps) or vertical blades (louvers).

Setting	Airflow direction
 Vertical automatic swing	Moves up and down.
 Horizontal automatic swing	Moves from side to side.
 3-D airflow direction	Moves alternately up and down and from side to side
 [—]	Stays in a fixed position.

#### CAUTION

ALWAYS use a user interface to adjust the position of the flaps and louvers. When the flaps and louvers are swinging and you move them forcibly by hand, the mechanism will break.

The movable range of the flap varies according to the operation mode. The flap will stop at the upper position when the airflow rate is changed to low during the up and down swing setting.

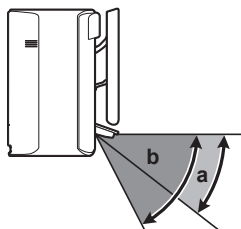

- a Flap range in cooling or drying operation
- b Flap range in heating or fan only operation

### 5.5.1 To adjust vertical airflow direction

- 1 Press .  
**Result:** appears on the LCD. The flaps (horizontal blades) will begin to swing.
- 2 To use fixed position, press when the flaps reach the desired position.  
**Result:** disappears from the LCD. The flaps will stop moving.

### 5.5.2 To adjust horizontal airflow direction

- 1 Press .  
**Result:** appears on the LCD. The louvers (vertical blades) will begin to swing.
- 2 To use fixed position, press when the louvers reach the desired position.  
**Result:** disappears from the LCD. The louvers will stop moving.



#### INFORMATION

When the unit is installed in a corner of a room, the direction of the louvers should be facing away from the wall. Efficiency will drop if a wall blocks the air.

### 5.5.3 To use 3-D airflow direction

- 1 Press and .  
**Result:** and appear on the LCD. The flaps (horizontal blades) and louvers (vertical blades) will begin to swing.
- 2 To use fixed position, press and when the flaps and louvers reach the desired position.  
**Result:** and disappear from the LCD. The flaps and the louvers will stop moving.

## 5.6 Comfort airflow and Intelligent eye operation

You can use Comfort and Intelligent eye operation separately, or combine them.

### 5.6.1 Comfort airflow operation

The unit will automatically change the direction of the airflow to heat up or cool down the room more effectively. Direct airflow from the unit will be less noticeable.

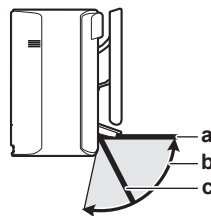

- a Flap position in cooling and dry operation
- b Flap range in heating operation (vertical airflow ON)
- c Flap position in heating operation (vertical airflow OFF)

### In cooling and drying

The airflow direction will change to spread the air along the ceiling.

Comfort airflow ON	Comfort airflow OFF

### In heating

The airflow direction will change to spread the air along the floor. The unit detects the room and floor temperature and automatically selects 1 of the 3 airflow directions.

Warming up	Downward direction	Vertical airflow direction



#### INFORMATION

If you want to deactivate the Vertical airflow function (e.g. in case there is furniture or another object under the unit), refer to "To turn ON/OFF vertical airflow function" [p 9]. If the Vertical airflow function is deactivated, the airflow will be set to downward direction.



#### INFORMATION

Powerful and Comfort airflow operation CANNOT be used at the same time. The last selected function takes priority. If the vertical automatic swing is selected, Comfort airflow operation will be cancelled.

### To turn ON/OFF vertical airflow function

- 1 Press for at least 2 seconds.  
**Result:** The menu appears on the display.
- 2 Press or to change the menu screen.  
**Result:** The menu appears on the display.

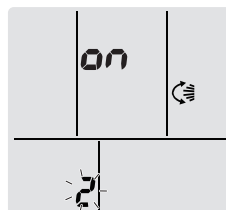

- 3 Press to change the setting.
- 4 Press or to change the setting.

...is blinking	Vertical airflow function is...
	turned ON
	turned OFF

## 5 Operation

- 5 To confirm the selected setting press .

**Note:** The display automatically returns to the default screen after 60 seconds. To return to the default screen sooner, press  twice.

### 5.6.2 Intelligent eye operation

The system detects movement in the room and automatically adjusts the airflow direction and temperature in order to avoid direct contact with people. If no movement is detected for 20 minutes, the system switches to energy saving operation:

Operation	Energy saving operation
Heating	Temperature is lowered by 2°C.
Cooling and drying	If the temperature in the room is: <ul style="list-style-type: none"> <li>▪ &lt;30°C, the temperature is raised by 2°C</li> <li>▪ ≥30°C, the temperature is raised by 1°C</li> </ul>
Fan only	Decreases airflow rate.

#### About the Intelligent eye sensor

##### NOTICE

- Do NOT hit or push the Intelligent eye sensor. Doing so may lead to malfunction.
- Do NOT place large objects near the Intelligent eye sensor.

##### INFORMATION

Powerful or Night set operation CANNOT be used at the same time with Intelligent eye operation. The last selected function takes priority.



- **Detection range.** Up to 9 m.
- **Detection sensitivity.** Changes according to location, the number of persons in the room, temperature range, etc.
- **Detection mistakes.** The sensor may mistakenly detect pets, sunlight, moving curtains, etc.

### 5.6.3 To start/stop Comfort and Intelligent eye operation

- 1 Press  one or more times.

**Result:** The setting will change as follows:



Display	Operation
	Comfort airflow
	Intelligent eye
	Comfort airflow and Intelligent eye
—	Both deactivated

**Note:** If there are people close to the front of the indoor unit or there are too many people, use both operations at the same time.

- 2 To stop operation, press  until both symbols disappear from the LCD.

## 5.7 Powerful operation

This operation quickly maximizes the cooling/heating effect in any operation mode. You can get the maximum capacity.

##### INFORMATION

Powerful operation CANNOT be used together with Econo, Comfort airflow, Intelligent eye and Outdoor unit quiet operation. The last selected function takes priority.

Powerful operation will NOT increase the capacity of the unit if it already operates at maximum capacity.

### 5.7.1 To start/stop Powerful operation



- 1 Press  to start.

**Result:**  is displayed on the LCD. Powerful operation runs for 20 minutes; after that, operation returns to the previously set mode.

Mode	Airflow rate
Cooling/Heating/Automatic	<ul style="list-style-type: none"> <li>▪ To maximize the cooling/heating effect, the capacity of outdoor unit is increased.</li> <li>▪ The airflow rate is fixed to the maximum setting and CANNOT be changed.</li> <li>▪ The temperature can be set only in Automatic mode.</li> </ul>
Drying	<ul style="list-style-type: none"> <li>▪ The temperature setting is lowered by 2.5°C.</li> <li>▪ The airflow rate is slightly increased.</li> </ul>
Fan only	The airflow rate is fixed to the maximum setting.

- 2 Press  to stop.

**Result:**  disappears from the LCD.

**Note:** Powerful operation can be set only when the unit is running. If you press , operation will be cancelled;  disappears from the LCD.

## 5.8 Econo and Outdoor unit quiet operation

### 5.8.1 Econo operation

This is a function which enables efficient operation by limiting the maximum power consumption value. This function is useful for cases in which attention should be paid to ensure a circuit breaker will not trip when the product runs alongside other appliances.

##### INFORMATION

- Powerful and Econo operation CANNOT be used at the same time. The last selected function takes priority.
- Econo operation reduces power consumption of the outdoor unit by limiting the rotation speed of the compressor. If power consumption is already low, Econo operation will NOT further reduce power consumption.

### 5.8.2 Outdoor unit quiet operation

Use Outdoor unit quiet operation when you want to decrease the noise level of the outdoor unit. **Example:** At night.

**i** INFORMATION



- Powerful and Outdoor unit quiet operation CANNOT be used at the same time. The last selected function takes priority.
- This function is only available in Automatic, Cooling, and Heating operation.
- Outdoor unit quiet operation limits the rotation speed of the compressor. If the rotation speed of compressor is already low, Outdoor unit quiet operation will NOT further reduce the compressor rotation speed.

**5.8.3 To start/stop Econo and Outdoor unit quiet operation**



- Press  one or more times.

**Result:** The setting will change as follows.



Display	Operation
	Econo
	Outdoor unit quiet
	Econo and Outdoor unit quiet
—	Both deactivated

- To stop operation, press  until both symbols disappear from the LCD.

**Note:** Econo operation can be only set when the unit is running. Pressing  cancels the setting and  disappears from the LCD.

**Note:**  remains on the LCD, even if you turn off the unit using the user interface or indoor unit ON/OFF switch.

**5.9 Streamer (air cleaning) operation**

Streamer generates a high-speed electron stream with a high oxidizing power, reducing bad odours and viruses. Together with the titanium apatite deodorizing filter and the air filters, this function cleans the air in the room.

**i** INFORMATION

- The high-speed electrons are generated and go away inside the unit to ensure safe operation.
- The Streamer discharge may generate a fizzing sound.
- If the airflow becomes weak, the Streamer discharge may stop temporarily to prevent ozone smell.

**5.9.1 To start/stop Streamer (air cleaning) operation**

- Press .

**Result:**  is displayed on the LCD and the air in the room is cleaned.

- To stop operation, press .

**Result:**  disappears from the LCD and operation stops.

**5.10 OFF/ON timer operation**

Timer functions are useful for automatically switching the air conditioner on/off at night or in the morning. You can also use OFF timer and ON timer in combination.

**i** INFORMATION

Program the timer again in case of:



- A breaker has turned the unit off.
- A power failure.
- After replacing batteries in the user interface.

**i** INFORMATION

The clock MUST be set correctly before using any timer functions. Refer to "4.4.1 To set the clock" [p. 6].

**5.10.1 To start/stop OFF timer operation**

- Press  to start.

**Result:**  is displayed on the LCD, the timer lamp lights up, and OFF blinks.  and the day of the week disappear from the LCD.





- Press  or  to change the time setting.
- Press  again.



**Result:** OFF and the set time are displayed on the LCD.

**Result:** The timer lamp lights up.

**i** INFORMATION

Each time  or  is pressed, the time setting advances by 10 minutes. Holding the button down will change the setting rapidly.

- To stop operation, press .

**Result:**  and OFF disappear from the LCD and the timer lamp goes off.  and the day of the week are displayed on the LCD.

**i** INFORMATION



When you set the ON/OFF timer, the time setting is stored in the memory. The memory will be reset when the user interface batteries are replaced.

**Use of night set mode in combination with OFF timer**



The air conditioner automatically adjusts the temperature setting (0.5°C up in cooling, 2.0°C down in heating) to prevent excessive cooling/heating and ensure a comfortable sleeping temperature.

**5.10.2 To start/stop ON timer operation**

- Press  to start.

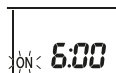

**Result:**  is displayed on the LCD, the timer lamp lights up, and ON blinks.  and the day of the week disappear from the LCD.



- Press  or  to change the time setting.
- Press  again.

**Result:** ON and the set time are displayed on the LCD. The timer lamp lights up.

**i** INFORMATION

Each time  or  is pressed, the time setting advances by 10 minutes. Holding the button down will change the setting rapidly.

## 5 Operation

- 4 To stop operation, press **Cancel**.

**Result:** **6:00** and **ON** disappear from the LCD and the timer lamp goes off. **WEEKLY** and the day of the week are displayed on the LCD.

### 5.10.3 To combine OFF timer and ON timer

- 1 To set the timers, refer to "5.10.1 To start/stop OFF timer operation" [p 11] and "5.10.2 To start/stop ON timer operation" [p 11].

**Result:** **OFF** and **ON** are displayed on the LCD.

**Example:**

Display	Current time	Set while...	Operation
OFF <b>7:00</b> ON <b>14:00</b>	6:00	the unit is operating.	Stops at 7:00 and starts at 14:00.
		the unit is NOT operating.	Starts at 14:00.

**Note:** If the timer setting is active, the current time is NOT displayed on the LCD.

## 5.11 Weekly timer operation

With this operation, you can save up to 4 timer settings for each day of the week.

**Example:** Create a different setting from Monday to Friday and a different setting for weekends.

Day of the week	Setting example
<b>Monday</b> ▪ Make up to 4 settings.	
<b>Tuesday~Friday</b> ▪ Use the copy mode if the settings are the same as for Monday.	
<b>Saturday</b> ▪ No timer setting	—
<b>Sunday</b> ▪ Make up to 4 settings.	

- **ON-ON-ON-ON setting.** Enables scheduling the operation mode and set temperature.
- **OFF-OFF-OFF-OFF setting.** Only the turn off time can be set for each day.

**Note:** Be sure to aim the user interface at the indoor unit and check for a receiving tone when setting the Weekly timer operation.

### **i** INFORMATION

The clock **MUST** be set correctly before using any timer functions. Refer to "4.4.1 To set the clock" [p 6].

### **i** INFORMATION

- Weekly timer and ON/OFF timer operation **CANNOT** be used at the same time. The ON/OFF timer operation takes priority. Weekly timer will be in standby, **WEEKLY** disappears from the LCD. When the ON/OFF timer is completed, the Weekly timer becomes active.
- The day of the week, ON/OFF timer mode, time and temperature (only for ON timer) can be set with the Weekly timer. Other settings are based on previous ON timer setting.

### 5.11.1 To set Weekly timer operation

- 1 Press **WEEKLY**.

**Result:** The day of the week and the reservation number of the current day are displayed.



- 2 Press **Select** or **Select** to select the day of the week and the reservation number.

- 3 Press **Next**.

**Result:** The day of the week is set. **WEEKLY** and **ON** blink.

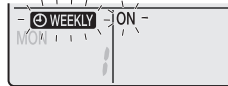

- 4 Press **Select** or **Select** to select the mode.

**Result:** The setting will change as follows:



Display	Feature
ON	ON timer
OFF	OFF timer
Blank	Deletes reservation

- 5 Press **Next**.

**Result:** The ON/OFF timer mode is set. **WEEKLY** and the time blink.



**Note:** Press **Back** to return to the previous screen. If blank is selected, continue to step 9.

- 6 Press **Select** or **Select** to select the time. The time can be set between 0:00~23:50 in 10-minute intervals.

- 7 Press **Next**.

**Result:** The time is set and **WEEKLY** and the temperature blink.



**Note:** Press **Back** to return to the previous screen. If OFF timer is selected, continue to step 9.

- 8 Press **Select** or **Select** to select the desired temperature.

**Note:** The set temperature for the weekly timer is displayed only when setting the weekly timer mode.

### **i** INFORMATION

The temperature can be set between 10~32°C on the user interface, however:

- in cooling and automatic operation mode, the unit will operate at minimum 18°C even if is set at 10~17°C;
- in heating and automatic operation mode, the unit will operate at maximum 30°C even if is set at 31~32°C.

- 9 Press **Next**.

**Result:** The temperature and time are set for the ON timer. The time is set for the OFF timer. The timer lamp lights orange.

**Result:** A new reservation screen will appear.





- Repeat the previous procedure to set another reservation or press  to complete the setting.

**Result:**  is displayed on the LCD.

**Note:** A reservation can be copied with the same settings to another day. Refer to "5.11.2 To copy reservations" [p 13].



### 5.11.2 To copy reservations

A reservation can be copied to another day. The complete reservation of the selected day of the week will be copied.

- Press .
- Press  or  to select the day of the week to be copied.
- Press .

**Result:** The reservation of the selected day of the week will be copied.



- Press  or  to select the destination day.
- Press .

**Result:** The whole reservation is copied to the selected day and the timer lamp lights orange.

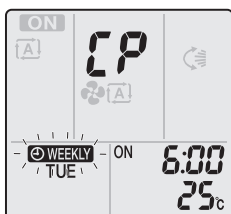

**Note:** To copy to another day, repeat the procedure.

- Press  to complete the setting.

**Result:**  is displayed on the LCD.

**Note:** To change the reservation setting after copying, refer to "5.11.1 To set Weekly timer operation" [p 12].



### 5.11.3 To confirm reservations

You can confirm if all reservations are set to your needs.

- Press .

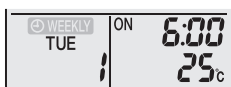
**Result:** The day of the week and the reservation number of the current day are displayed.





- Press  or  to select the day of the week and reservation number to be confirmed and check the reservation details.

**Note:** To change the reservation setting, refer to "5.11.1 To set Weekly timer operation" [p 12].

- Press  to exit the confirmation mode.

### 5.11.4 To deactivate and reactivate Weekly timer operation

- To deactivate the Weekly timer, press  while  is displayed on the LCD.

**Result:**  disappears from the LCD and the timer lamp goes off.

- To reactivate the Weekly timer, press  again.

**Result:** The last set reservation mode will be used.



### 5.11.5 To delete reservations

#### To delete individual reservations

Use this function if you want to delete a single reservation setting.

- Press .

**Result:** The day of the week and the reservation number are displayed.

- Press  or  to select the day of the week to be deleted.
- Press .

**Result:** , ON, and OFF blink.

- Press  or  and select "blank".

**Result:** The setting will change as follows:



- Press .



**Result:** The selected reservation is deleted.

- Press  to exit.

**Result:** Remaining reservations will be active.

#### To delete a reservation for each day of the week

Use this function if you want to delete all reservation settings for one day of the week. This can be used in confirmation or setting mode.

- Press  or  to select the day of the week to be deleted.
- Hold  for about 5 seconds.

**Result:** All reservations for the selected day will be deleted.

#### To delete all reservations

Use this function if you want to delete all reservations for all days of the week in one go. This procedure CANNOT be used in the setting mode.

- Hold  for about 5 seconds while in the default display.

**Result:** All reservations will be deleted.

## 5.12 Wireless LAN connection

The customer is responsible for providing:

- Smartphone or tablet with minimum supported version of Android or iOS, specified on <http://www.onlinecontroller.daikin-europe.com>
- Internet line and communication device, such as a modem, router, etc.
- Wireless LAN access point
- Installed free **Daikin Online Controller** application

**Note:** If needed, the SSID number and the KEY are located on the unit or can be found in the accessory bag.

## 5 Operation

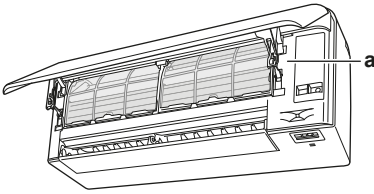

a Label with SSID number and password

### 5.12.1 Precautions when using the wireless adapter

Do NOT use near:

- **Medical equipment.** E.g. persons using cardiac pacemakers or defibrillators. This product may cause electromagnetic interference.
- **Auto-control equipment.** E.g. automatic doors or fire alarm equipment. This product may cause faulty behaviour of the equipment.
- **Microwave oven.** It may affect wireless LAN communications.

### 5.12.2 To install the Daikin Online Controller application

- 1 Open:
  - Google Play for appliances using Android.
  - App Store for appliances using iOS.
- 2 Search for **Daikin Online Controller**.
- 3 Follow the directions on the screen to install.

### 5.12.3 To set the wireless connection

There are two options to connect the wireless adapter with your smart device.

- **Connect the wireless adapter to your smart device directly.**
- **Connect the wireless adapter to your home network.** The wireless adapter will communicate with your smart device in your home network using a modem, router or a similar device.

For more information and FAQ refer to:

<http://www.onlinecontroller.daikineurope.com/>.

- 1 Stop the operation before setting the wireless connection.
- 2 Use the user interface to choose the wireless adapter setting menu.

Menu	Description
1	—
2	WPS setting
3	AP mode
4	RUN mode (SSID + KEY)
R	Reset to factory default
oFF	Wireless adapter OFF

### To connect the wireless adapter to your device directly

- 1 Hold for at least 5 seconds in the default screen.  
**Result:** The confirmation display (menu 1) appears.
- 2 Press repeatedly or until the AP mode display (menu 3) appears.

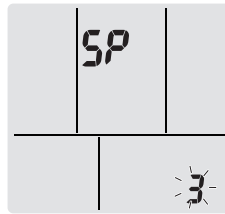

- 3 Press to confirm the selection.  
**Result:** 3 is blinking. The operation and timer LEDs are blinking alternately.
- 4 Connect your smart device to the access point in the same way as to a standard wireless network.
- 5 Enter the SSID number and password located on the unit or in the accessory set.
- 6 Press to exit the menu.

**Result:** The display will return to the default screen.

### To connect the wireless adapter to your home network

The wireless adapter can be connected to your home network using the:

- **WPS** button on the router (if present),
- **SSID** and **KEY** number located on the unit.

#### To connect using the WPS button

- 1 Hold for at least 5 seconds in the default screen.  
**Result:** The confirmation display (menu 1) appears.
- 2 Press repeatedly or until the WPS setting display (menu 2) appears.

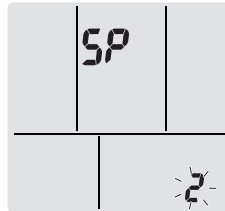

- 3 Press to confirm the selection.  
**Result:** 2 is blinking. The timer LED is blinking.
- 4 Press the WPS button on your communication device (e.g. router) within approximately 1 minute. Refer to the manual of your communication device.

#### INFORMATION

If the connection with your router is not possible, try procedure "To connect using SSID and KEY number" ▶ 14].

- 5 Press to exit the menu.

**Result:** The display will return to the default screen.

#### To connect using SSID and KEY number

- 1 Hold for at least 5 seconds in the default screen.  
**Result:** The confirmation display (menu 1) appears.
- 2 Press repeatedly or until the AP mode display (menu 3) appears.

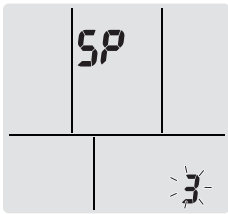

- 3 Press to confirm the selection.

**Result:** 3 is blinking. The operation and timer LEDs are blinking alternately.

- 4 Connect your smart device to the access point in the same way as to a standard wireless network.
- 5 Enter the SSID number and password located on the unit or in the accessory set.
- 6 Open the Daikin Online Controller application and follow the steps on the screen.

**Result:** Wireless adapter mode will automatically change from the AP mode to the RUN mode, the timer LED is blinking.

- 7 Press to exit the menu.

**Result:** The display will return to the default screen.

### To reset the connection setting to the factory default

Reset the connection setting to the factory default in case you want to:

- switch between the WPS and the AP connection option,
- disconnect the Wi-Fi adapter and the communication device (e.g. router) or smart device,
- repeat the setting if the connection was unsuccessful.

- 1 Hold for at least 5 seconds in the default screen.

**Result:** The confirmation display(menu ) appears.

- 2 Press repeatedly or until the A display (menu ) appears.

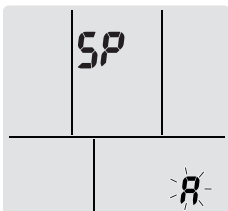

- 3 Hold for at least 2 seconds to confirm the selection.

**Result:** A is blinking. The setting is reset to the factory default.

- 4 Press to exit the menu.

**Result:** The display will return to the default screen.

### To turn off the wireless connection

You can turn off the wireless connection using:

- the wireless adapter ON/OFF button on the unit,
- the user interface.

#### To use the wireless adapter ON/OFF switch

- 1 Press the wireless adapter ON/OFF switch.

**Result:** The wireless adapter communication is OFF.

**Note:** Press the ON/OFF switch again to turn on the wireless adapter.

#### To use the user interface

- 1 Hold for at least 5 seconds in the default screen.

**Result:** The confirmation display (menu ) appears.

- 2 Press repeatedly or until the OFF menu appears.

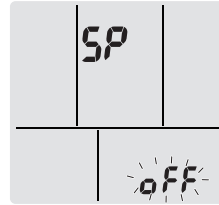

- 3 Hold for at least 2 seconds to confirm the selection.

**Result:** OFF is blinking. Communication is OFF.

- 4 Press to exit the menu.

**Result:** The display will return to the default screen.

## 6 Energy saving and optimum operation



#### INFORMATION

- Even if the unit is turned OFF, it consumes electricity.
- When the power turns back on after a power break, the previously selected mode will be resumed.



#### CAUTION

NEVER expose little children, plants or animals directly to the airflow.



#### WARNING

Do NOT place objects below the indoor and/or outdoor unit that may get wet. Otherwise condensation on the unit or refrigerant pipes, air filter dirt or drain blockage may cause dripping, and objects under the unit may get dirty or damaged.



#### WARNING

Do NOT place a flammable spray bottle near the air conditioner and do NOT use sprays near the unit. Doing so may result in a fire.

Observe the following precautions to ensure the system operates properly.

- Prevent direct sunlight from entering a room during cooling operation by using curtains or blinds.
- Make sure the area is well ventilated. Do NOT block any ventilation openings.
- Ventilate often. Extended use requires special attention to ventilation.
- Keep doors and windows closed. If the doors and windows remain open, air will flow out of your room causing a decrease in the cooling or heating effect.
- Be careful NOT to cool or heat too much. To save energy, keep the temperature setting at a moderate level.
- NEVER place objects near the air inlet or the air outlet of the unit. Doing so may cause a reduced heating/cooling effect or stop operation.

## 7 Maintenance and service

- Turn off the main power supply switch to the unit when the unit is NOT used for longer periods of time. If the main power supply switch is on, the unit consumes electricity. Before restarting the unit, turn on the main power supply switch 6 hours before operation to ensure smooth running.
- Condensation may form if the humidity is above 80% or if the drain outlet gets blocked.
- Adjust the room temperature properly for a comfortable environment. Avoid excessive heating or cooling. Notice that it may take some time for the room temperature to reach the set temperature. Consider using the timer setting options.
- Adjust the air flow direction to avoid cool air from gathering on the floor or warm air against the ceiling. (Up during cooling or dry operation to the ceiling and down during heating operation.)
- Avoid direct air flow to room inhabitants.
- Operate the system within the recommended temperature range (26~28°C for cooling and 20~24°C for heating) to save energy.

## 7 Maintenance and service

### 7.1 Overview: Maintenance and service

The installer has to perform a yearly maintenance.

#### About the refrigerant

This product contains fluorinated greenhouse gases. Do NOT vent gases into the atmosphere.

Refrigerant type: R32

Global warming potential (GWP) value: 675

#### NOTICE

Applicable legislation on **fluorinated greenhouse gases** requires that the refrigerant charge of the unit is indicated both in weight and CO<sub>2</sub> equivalent.

**Formula to calculate the quantity in CO<sub>2</sub> equivalent tonnes:** GWP value of the refrigerant × total refrigerant charge [in kg] / 1000

Please contact your installer for more information.

#### WARNING

The refrigerant inside the unit is mildly flammable, but normally does NOT leak. If the refrigerant leaks in the room and comes in contact with fire from a burner, a heater, or a cooker, this may result in fire, or the formation of a harmful gas.

Turn off any combustible heating devices, ventilate the room, and contact the dealer where you purchased the unit.

Do NOT use the unit until a service person confirms that the part from which the refrigerant leaked has been repaired.

#### WARNING

- Do NOT pierce or burn refrigerant cycle parts.
- Do NOT use cleaning materials or means to accelerate the defrosting process other than those recommended by the manufacturer.
- Be aware that the refrigerant inside the system is odourless.

#### WARNING

The appliance shall be stored in a room without continuously operating ignition sources (example: open flames, an operating gas appliance or an operating electric heater).

#### NOTICE

Maintenance MUST be done by an authorized installer or service agent.

We recommend performing maintenance at least once a year. However, applicable legislation might require shorter maintenance intervals.

#### DANGER: RISK OF ELECTROCUTION

To clean the air conditioner or air filter, be sure to stop operation and turn all power supplies off. Otherwise, an electric shock and injury may result.

#### WARNING

To prevent electric shocks or fire:

- Do NOT rinse the unit.
- Do NOT operate the unit with wet hands.
- Do NOT place any objects containing water on the unit.

#### CAUTION

After a long use, check the unit stand and fitting for damage. If damaged, the unit may fall and result in injury.

#### CAUTION

Do NOT touch the heat exchanger fins. These fins are sharp and could result in cutting injuries.

#### WARNING

Be careful with ladders when working in high places.

### 7.2 To clean the indoor unit and user interface

#### NOTICE

- Do NOT use gasoline, benzene, thinner polishing powder or liquid insecticide. **Possible consequence:** Discoloration and deformation.
- Do NOT use water or air of 40°C or higher. **Possible consequence:** Discoloration and deformation.
- Do NOT use polishing compounds.
- Do NOT use a scrubbing brush. **Possible consequence:** The surface finishing peels off.

#### DANGER: RISK OF ELECTROCUTION

Before cleaning, be sure to stop the operation, turn the breaker off or pull out the supply cord. Otherwise, an electric shock and injury may result.

- 1 Clean with a soft cloth. If it is difficult to remove stains, use water or a neutral detergent.

### 7.3 To clean the front panel

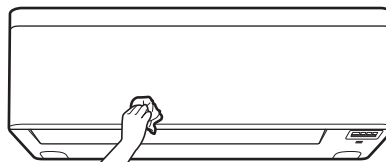

- 1 Clean the front panel with a soft cloth. If it is difficult to remove stains, use water or a neutral detergent.

### 7.4 To open the front panel

Open the front panel using the user interface.

- 1 Stop operation.
- 2 Hold  on the user interface for at least 2 seconds.

**Result:** The front panel will open.

**Note:** Press and hold  again for at least 2 seconds to close the front panel.

- 3 Turn the power supply off.
- 4 Pull down both locks on the back of the front panel.
- 5 Open the front panel until the support fits into the fixing tab.

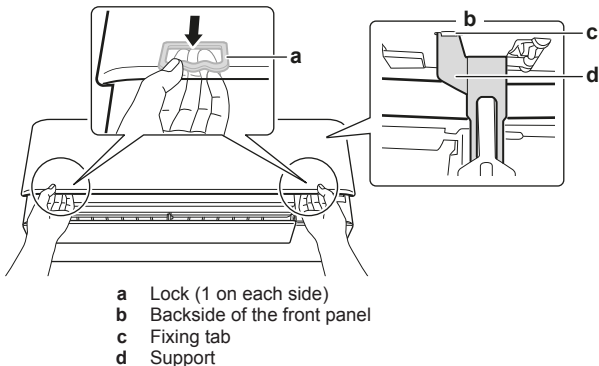

#### INFORMATION

If you CANNOT find the user interface or you use another optional controller. Pull the front panel carefully up by hand as shown in the following figure.

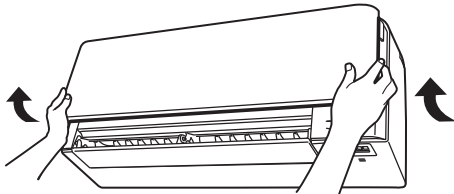

### 7.5 About the air filters

Operating the unit with dirty filters means that the filter:

- CANNOT deodorize the air,
- CANNOT clean the air,
- poor heating/cooling,
- causes odour.

### 7.6 To clean the air filters

- 1 Push the tab at the centre of each air filter, then pull it down.
- 2 Pull out the air filters.

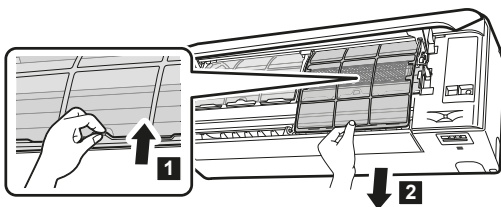

- 3 Remove the titanium apatite deodorizing filter and silver particle filter from the tabs.

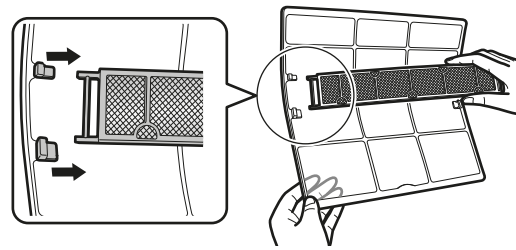

- 4 Wash the air filters with water or clean them with a vacuum cleaner.

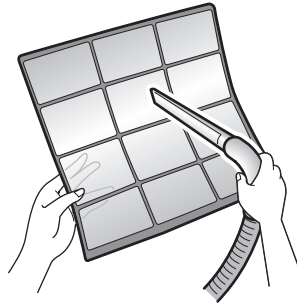

- 5 Soak in lukewarm water for about 10 to 15 minutes.



#### INFORMATION

- If the dust does NOT come off easily, wash the air filters with a neutral detergent diluted in lukewarm water. Dry the air filters in the shade.
- Be sure to remove the titanium apatite deodorizing and silver particle filters.
- It is recommended to clean the air filters every 2 weeks.

### 7.7 To clean the titanium apatite deodorizing filter and the silver particle filter (Ag-ion filter)

#### INFORMATION

Clean the filter with water every 6 months.

- 1 Remove the dust from the filter with a vacuum cleaner.

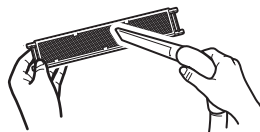

- 2 Soak the filter for 10 to 15 minutes in warm water. Do NOT remove the filter from the frame.



- 3 After washing, shake off remaining water and dry the filter in the shade. Do NOT wring out the filter when removing water.

## 8 Troubleshooting

### 7.8 To replace the titanium apatite deodorizing filter and the silver particle filter (Ag-ion filter)

#### **i** INFORMATION

Replace the filter every 3 years.

- 1 Remove the tabs on the filter frame and replace the filter with a new one.

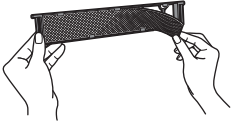

#### **i** INFORMATION

- Do NOT throw away the filter frame, but use it again.
- Dispose of the old filter as non-flammable waste.

### 7.9 To close the front panel

- 1 Set the filters as they were.
- 2 Lift the front panel slightly and remove the support from the fixing tab.

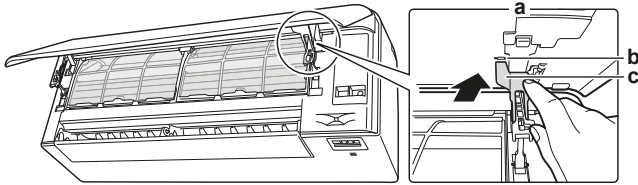

- a Backside of the front panel
- b Fixing tab
- c Support

- 3 Close the front panel.

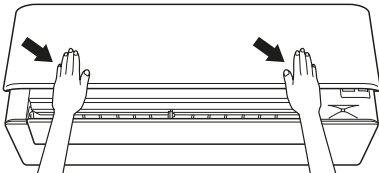

- 4 Gently press the front panel down until it clicks.

### 7.10 To remove the front panel

#### **i** INFORMATION

Remove the front panel only in case it MUST be replaced.

- 1 Open the front panel. See "7.4 To open the front panel" [p. 17].
- 2 Open the panel locks located on the back side of the panel (1 on each side).

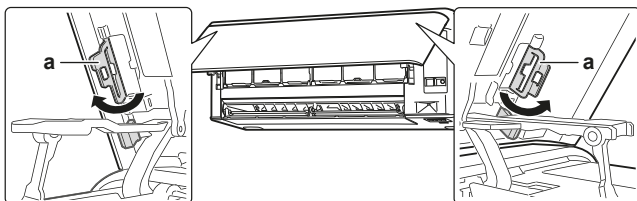

- a Panel lock

- 3 Push the right arm lightly to the right to disconnect the shaft from the shaft slot on the right side.

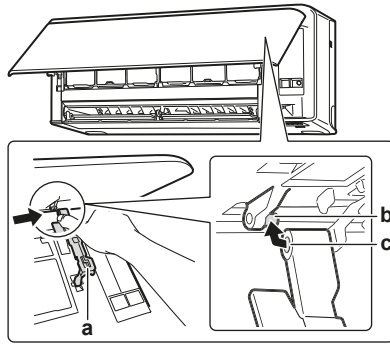

- a Arm
- b Shaft
- c Shaft slot

- 4 Disconnect the front panel shaft from the shaft slot on the left side.

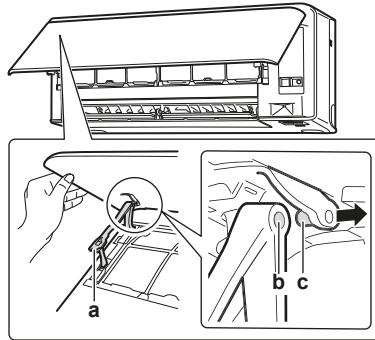

- a Arm
- b Shaft slot
- c Shaft

- 5 Remove the front panel.

- 6 To re-install the front panel perform the steps in the opposite order.

### 7.11 To take following items into account before a long idle period

Operate the unit several hours in **fan only** mode to dry the inside of the unit.

- 1 Press **Mode** and select operation.
- 2 Press and start operation.
- 3 After operation stops, turn the breaker off.
- 4 Clean the air filters and replace them in their original position.
- 5 Remove the batteries from the user interface.

#### **i** INFORMATION

It is recommended to have periodical maintenance performed by a specialist. For specialist maintenance, contact your dealer. Maintenance costs shall be borne by the customer.

In certain operating conditions the inside of the unit may get dirty after several seasons of use. This results in poor performance.

## 8 Troubleshooting

If one of the following malfunctions occur, take the measures shown below and contact your dealer.



### WARNING

**Stop operation and shut off the power if anything unusual occurs (burning smells etc.).**

Leaving the unit running under such circumstances may cause breakage, electric shock or fire. Contact your dealer.

The system **MUST** be repaired by a qualified service person.

Malfunction	Measure
If a safety device such as a fuse, a breaker or an earth leakage breaker frequently actuates or the ON/OFF switch does NOT properly work.	Turn OFF the main power switch.
If water leaks from the unit.	Stop the operation.
The operation switch does NOT work well.	Turn OFF the power supply.
If the user interface display indicates the unit number, the operation lamp flashes and the malfunction code appears.	Notify your installer and report the malfunction code.

If the system does NOT operate properly except for the above mentioned cases and none of the above mentioned malfunctions is evident, investigate the system according to the following procedures.

Malfunction	Measure
If the system does NOT operate at all.	<ul style="list-style-type: none"> <li>▪ Check if there is no power failure. Wait until power is restored. If a power failure occurs during operation, the system automatically restarts immediately after power is restored.</li> <li>▪ Check if the front panel is opened during operation. Stop operation and restart the indoor unit using the user interface.</li> <li>▪ Check if no fuse has blown or breaker is activated. Change the fuse or reset the breaker if necessary.</li> <li>▪ Check the batteries of the user interface.</li> <li>▪ Check the timer setting.</li> </ul>
The system suddenly stops operating.	<ul style="list-style-type: none"> <li>▪ Check if the air inlet or outlet of the outdoor or indoor unit is NOT blocked by obstacles. Remove any obstacles and make sure the air can flow freely.</li> <li>▪ The air conditioner may stop operating after sudden large voltage fluctuations to protect the system. It automatically resumes operation after about 3 minutes.</li> </ul>
The fan will stop during airflow operation.	If the set temperature is reached, the airflow rate is reduced and operation stops. Operation will resume automatically when the indoor temperature rises or falls.
The flaps do NOT start to swing immediately.	The indoor unit is adjusting the position of the flaps. The flaps will start moving soon.
Operation does NOT start soon.	In case the ON/OFF button was pressed right after operation was stopped or if the mode was changed. Operation will start after 3 minutes to protect the system.

Malfunction	Measure
The system operates, but cooling or heating is insufficient.	<ul style="list-style-type: none"> <li>▪ Check the airflow rate setting. Refer to <a href="#">"5.4 Airflow rate"</a> [▶ 8].</li> <li>▪ Check the temperature setting. Refer to <a href="#">"5.3.1 To start/stop operation mode and to set the temperature"</a> [▶ 8].</li> <li>▪ Check if the airflow direction setting is appropriate. Refer to <a href="#">"5.5 Airflow direction"</a> [▶ 8].</li> <li>▪ Check if the air inlet or outlet of the outdoor or indoor unit is NOT blocked by obstacles. Remove any obstacles and make sure the air can flow freely.</li> <li>▪ Check if the air filters are clogged. Clean the air filters. Refer to <a href="#">"7 Maintenance and service"</a> [▶ 16].</li> <li>▪ Check for open doors or windows. Close doors and windows to prevent wind from coming in.</li> <li>▪ Check if the unit operates in Econo or Outdoor unit quiet operation. Refer to <a href="#">"5.8 Econo and Outdoor unit quiet operation"</a> [▶ 10].</li> <li>▪ Check if there is any furniture directly under or next to the indoor unit. Move the furniture.</li> </ul>
The system operates, but heating is insufficient (air is NOT blown from the unit).	<ul style="list-style-type: none"> <li>▪ The air conditioner may be warming up for heating operation. Wait for 1 to 4 minutes.</li> <li>▪ If a flowing sound is heard, the outdoor unit may be in defrost operation. Wait for 4 to 12 minutes.</li> </ul>
The front panel does NOT open.	Check for the obstacles and try to open the front panel using the user interface. Refer to <a href="#">"7.4 To open the front panel"</a> [▶ 17].
The ON/OFF timer does NOT operate according to the settings.	<ul style="list-style-type: none"> <li>▪ Check if the Weekly timer and ON/OFF timer are set to the same time. Change or deactivate the setting. Refer to <a href="#">"5.10 OFF/ON timer operation"</a> [▶ 11] and <a href="#">"5.11 Weekly timer operation"</a> [▶ 12].</li> <li>▪ Check if the clock and the day of the week are set correctly. Refer to <a href="#">"4.4 About the clock"</a> [▶ 6].</li> </ul>
Heating operation CANNOT be selected.	Check if the user interface's jumper J8 has NOT been cut. <div style="text-align: center; margin-top: 5px;"> </div>
An abnormal function happens during operation.	The air conditioner may malfunction because of lightning or radio waves. Turn the breaker OFF and back ON.
The unit does NOT receive signals from the user interface.	<ul style="list-style-type: none"> <li>▪ Check the batteries of the user interface. Refer to <a href="#">"4.3 To insert the batteries"</a> [▶ 6].</li> <li>▪ Make sure that the transmitter is NOT exposed to direct sunlight.</li> <li>▪ Check if there are any electronic starter type fluorescent lamps in the room. Contact your dealer.</li> </ul>
The user interface display is blank.	Replace the batteries of the user interface.
An error code is displayed on the user interface.	Consult your local dealer. Refer to <a href="#">"8.2 Solving problems based on error codes"</a> [▶ 20] for a detailed list of error codes.

## 8 Troubleshooting

Malfunction	Measure
Other electric appliances start to operate.	If the user interface signals operate other electric appliances, move the other appliances away, and contact your dealer.

If after checking all above items, it is impossible to fix the problem yourself, contact your installer and state the symptoms, the complete model name of the unit (with manufacturing number if possible) and the installation date (possibly listed on the warranty card).

### 8.1 Symptoms that are NOT system malfunctions

The following symptoms are NOT system malfunctions:

#### 8.1.1 Symptom: A sound like water flowing is heard

- This sound is caused by the refrigerant flowing in the unit.
- This sound may be generated when water is flowing away from the unit during cooling or drying operation.

#### 8.1.2 Symptom: A blowing sound is heard

This sound is generated when the direction of the refrigerant flow is changed (e.g. when switching from cooling to heating).

#### 8.1.3 Symptom: A ticking sound is heard

This sound is generated when the unit slightly expands or contracts with changes in temperature.

#### 8.1.4 Symptom: A whistling sound is heard

This sound is generated by the refrigerant flowing during defrost operation.

#### 8.1.5 Symptom: A clicking sound during operation or idle time is heard

This sound is generated when the refrigerant control valves or electrical parts operate.

#### 8.1.6 Symptom: A clapping sound is heard

This sound is generated when an external device sucks air out of the room (e.g. exhaust fan, extractor hood) while the doors and windows in the room are closed. Open the doors or windows, or turn off the device.

#### 8.1.7 Symptom: White mist comes out of a unit (Indoor unit, outdoor unit)

When the system is changed over to heating operation after defrost operation. Moisture generated by defrost becomes steam and is exhausted.

#### 8.1.8 Symptom: The units can give off odours

The unit can absorb the smell of rooms, furniture, cigarettes, etc., and then emit it again.

#### 8.1.9 Symptom: The outdoor fan rotates while the air conditioner is not in operation

- **After operation has stopped.** The outdoor fan continues to rotate for another 30 seconds for system protection.
- **While the air conditioner is not in operation.** When the outdoor temperature is very high, the outdoor fan starts to rotate for system protection.

## 8.2 Solving problems based on error codes

If the unit runs into a problem, the user interface displays an error code. It is important to understand the problem and to take measures before resetting an error code. This should be done by a licensed installer or by your local dealer.

This chapter gives you an overview of all possible error codes and their descriptions as they appear on the user interface.

For detailed troubleshooting of each error, see the service manual.

### Fault diagnosis by user interface

The user interface can receive an error code from the indoor unit referring to the fault. It is important to understand the problem and take measures before resetting the error code. This should be done by a licensed installer or your local dealer.

To see the error code on the user interface:

- 1 Hold **Cancel** for about 5 seconds.

**Result:** **00** blinks in the temperature display section.

- 2 Press **Cancel** repeatedly until a continuous beep is heard.

**Result:** The code is now displayed on the display.



### INFORMATION

- A short beep and 2 consecutive beeps indicate non-corresponding codes.
- To cancel the code display, hold the **Cancel** cancel button for 5 seconds. The code will also disappear from the display if the button is NOT pressed within 1 minute.

### System

Error code	Description
00	Normal
U0	Refrigerant shortage
U2	Overvoltage detection
U4	Signal transmission error (between indoor and outdoor unit)
UR	Indoor/outdoor unit combination fault

### Indoor unit

Error code	Description
R1	Indoor unit PCB abnormality
R5	Freeze-up protection or high-pressure control
R6	Fan motor (DC motor) abnormality
RH	Streamer unit error
E4	Indoor heat exchanger thermistor abnormality
E7	Opening or closing front panel error
E9	Room temperature thermistor abnormality
EE	Humidity sensor error

### Outdoor unit

Error code	Description
E8	4-way valve abnormality
E1	Outdoor unit PCB abnormality
E5	Overload activation (compressor overload)
E6	Compressor lock
E7	DC fan lock
E8	Input power overcurrent
F3	Discharge pipe temperature control
F6	High-pressure control (in cooling mode)

Error code	Description
H3	Compressor system sensor abnormality
H6	Position sensor abnormality
H8	DC voltage / current sensor abnormality
H9	Outdoor temperature thermistor abnormality
J3	Discharge pipe thermistor abnormality
J6	Outdoor heat exchanger thermistor abnormality
L3	Electrical parts heat error
L4	Radiation fin temperature rise
L5	Inverter instantaneous overcurrent (DC)
P4	Radiation fin thermistor abnormality
F8	Compressor internal temperature error

### 8.3 Troubleshooting for wireless connection adapter

The following table provides a brief description of how to deal with some problems. If none of the following solutions fix the problem, go to <http://www.onlinecontroller.daikin-europe.com/> for more information and FAQ.

Problem	Measure
Connection to the WLAN adapter is not possible (none of the LEDs are blinking).	<ul style="list-style-type: none"> <li>Try operating the unit with the user interface.</li> <li>Check if the power is on.</li> <li>Turn the unit off and back on again.</li> </ul>
The WLAN adapter is NOT visible on the unit overview screen (Home screen) after configuration of the WLAN adapter (WPS option).	<ul style="list-style-type: none"> <li>Make sure the wireless LAN adapter is close enough to the communication device.</li> <li>Check if communication is OK.</li> <li>Make sure that the smart device is connected to the same wireless network as the WLAN adapter.</li> <li>Try resetting to the factory default and repeat the setting. See "<a href="#">To reset the connection setting to the factory default</a>" [▶ 15].</li> </ul>
The WLAN adapter is NOT visible in the available Wi-Fi networks list on the smart device (Access point option).	<ul style="list-style-type: none"> <li>Try switching between access point and WPS setting to change the wireless channel. The wireless channel MUST be between 1~11.</li> <li>Check if communication is OK.</li> <li>Try resetting to the factory default and repeat the setting. See "<a href="#">To reset the connection setting to the factory default</a>" [▶ 15].</li> </ul>

Problem	Measure
Displayed indoor/outdoor temperature/humidity value in Online Controller differs from the value measured by other appliances.	<ul style="list-style-type: none"> <li>Online Controller displays indoor/outdoor temperature/humidity only for the indoor/outdoor unit's surrounding.</li> <li>Measured temperature/humidity for other appliances may differ due to different condition around the unit (e.g. direct sunlight, frost accumulation...)</li> <li>Temperature/humidity displayed in Online Controller is only referential.</li> </ul>

## 9 Disposal



### NOTICE

Do NOT try to dismantle the system yourself: dismantling of the system, treatment of the refrigerant, oil and other parts MUST comply with applicable legislation. Units MUST be treated at a specialised treatment facility for reuse, recycling and recovery.

## 10 Glossary

### Dealer

Sales distributor for the product.

### Authorised installer

Technical skilled person who is qualified to install the product.

### User

Person who is owner of the product and/or operates the product.

### Applicable legislation

All international, European, national and local directives, laws, regulations and/or codes that are relevant and applicable for a certain product or domain.

### Service company

Qualified company which can perform or coordinate the required service to the product.

### Installation manual

Instruction manual specified for a certain product or application, explaining how to install, configure and maintain it.

### Operation manual

Instruction manual specified for a certain product or application, explaining how to operate it.

### Accessories

Labels, manuals, information sheets and equipment that are delivered with the product and that need to be installed according to the instructions in the accompanying documentation.

### Optional equipment

Equipment made or approved by Daikin that can be combined with the product according to the instructions in the accompanying documentation.

## 10 Glossary

---

### Field supply

Equipment NOT made by Daikin that can be combined with the product according to the instructions in the accompanying documentation.

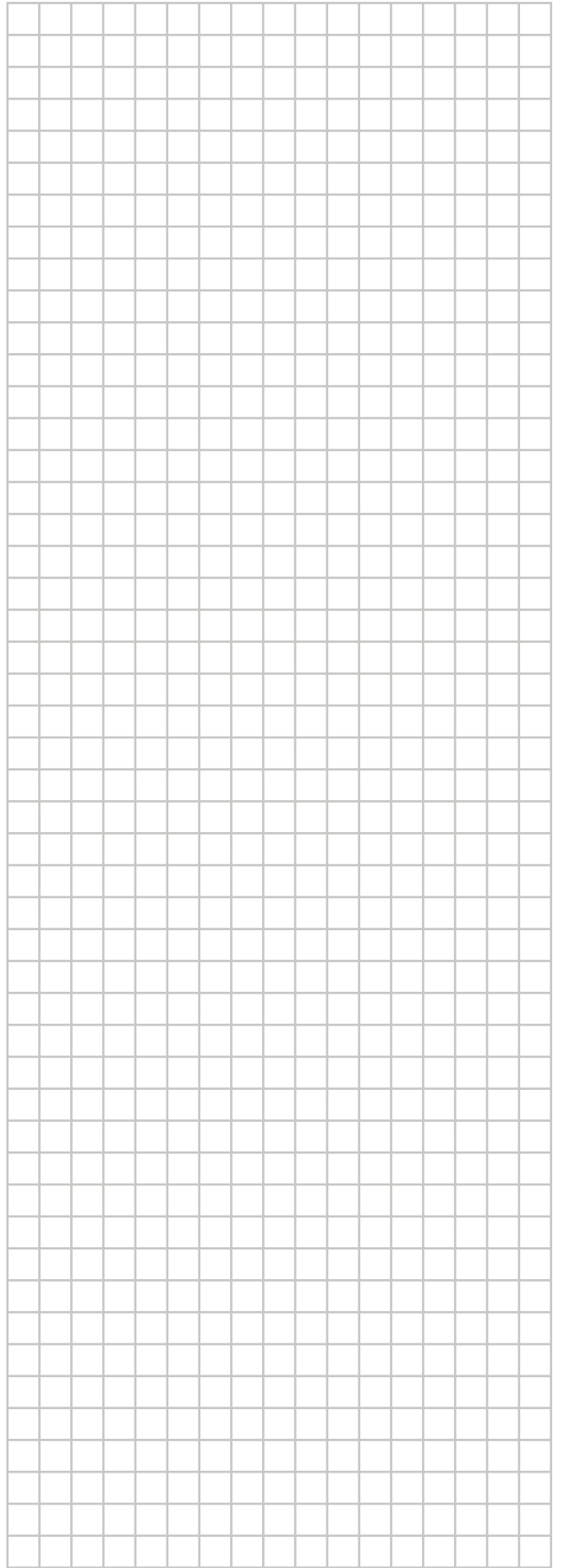

**DAIKIN INDUSTRIES CZECH REPUBLIC s.r.o.**

U Nové Hospody 1/1155, 301 00 Plzeň Skvrňany, Czech Republic

**DAIKIN EUROPE N.V.**

Zandvoordestraat 300, B-8400 Oostende, Belgium

4P518786-1E 2019.10